

# Voyager 4210/4220 Office (Microsoft)

for computer and desk phone

User Guide

# Contents

Overview	3
Headset overview	3
Base overview	4
Accessories	4
Hook up system	5
Desk phone setup details	5
Position Your Base	7
Pair	8
Pair again to base	8
Pair to mobile device	8
Pair mode	8
Fit and charge	9
Wear on the right or left	9
Charge	9
Check headset battery status	9
Load software	10
The Basics	11
Power on your headset	11
Adjust volume	11
Make, answer, end calls	11
Launch Microsoft Teams	12
View Microsoft Teams notifications	12
More Features	13
Play or pause audio	13
Voice assistant (smartphone feature)	13
Enable and use Amazon Alexa (smartphone feature)	13
Enable Tile	13
Change your default line	13
Online indicator	13
Corded mode (audio over USB)	14
Troubleshooting	15
Headset	15
Desk phone	16
Softphone	16
Support	18

# Overview

## Headset overview

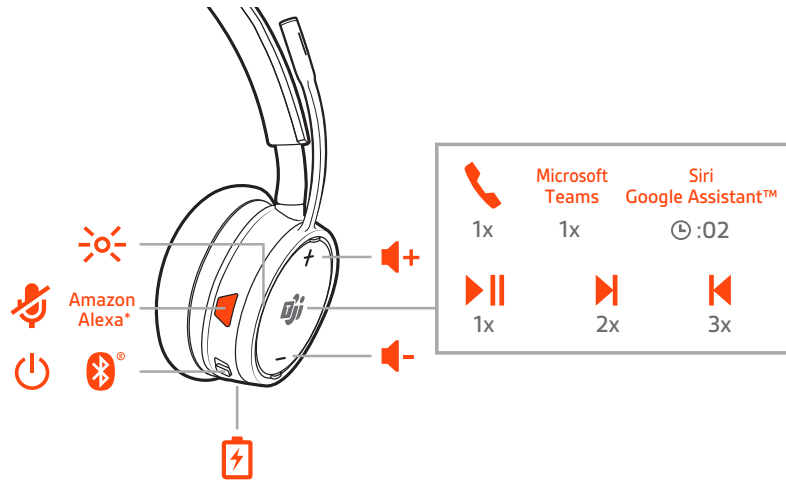

	LEDs
	Mute/unmute
Alexa	Smartphone feature: Voice assistant (requires app)
	Power
	Bluetooth® pairing
	Charge port
	Volume
	Call
	Microsoft Teams (requires app)
Siri®, Google Assistant™	Smartphone feature: Default voice assistant
	Play/pause**
	Next track**
	Previous track**

**NOTE** \*\*Functionality varies by application. May not function with web-based apps.

### Be safe

Please read the safety guide for important safety, charging, battery and regulatory information before using your new headset.

## Base overview

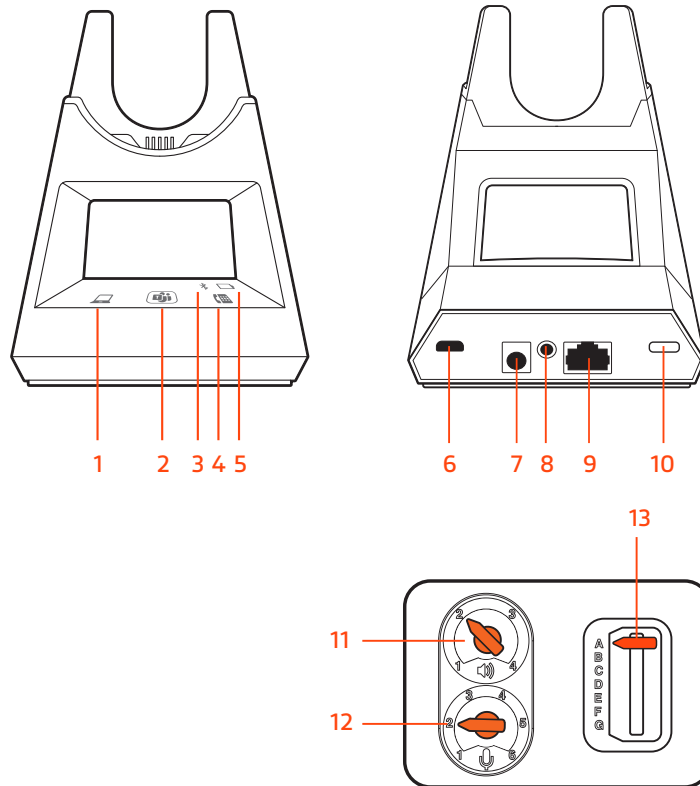

- 1 Computer button
- 2 Microsoft Teams button
- 3 Desk phone button
- 4 Bluetooth LED
- 5 Charging LED
- 6 USB port
- 7 Power jack

- 8 Handset lifter jack
- 9 Telephone interface cable jack
- 10 Bluetooth pairing button
- 11 Desk phone listening volume
- 12 Desk phone speaking volume
- 13 Desk phone configuration switch

## Accessories

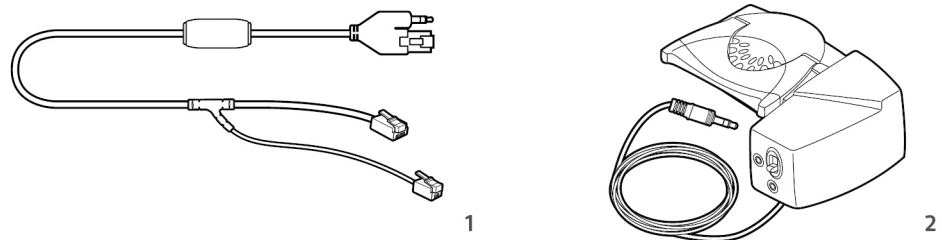

- 1 **Electronic hookswitch cable (EHS cable)** Electronically and automatically answers/ends a desk phone call. Enables remote call control with your headset.
- 2 **HL10 lifter** Automatically lifts handset and returns it to the cradle. Enables remote call control with your headset.

# Hook up system

Using the diagram, connect your headset system.

? [plantronics.com/support](https://plantronics.com/support)

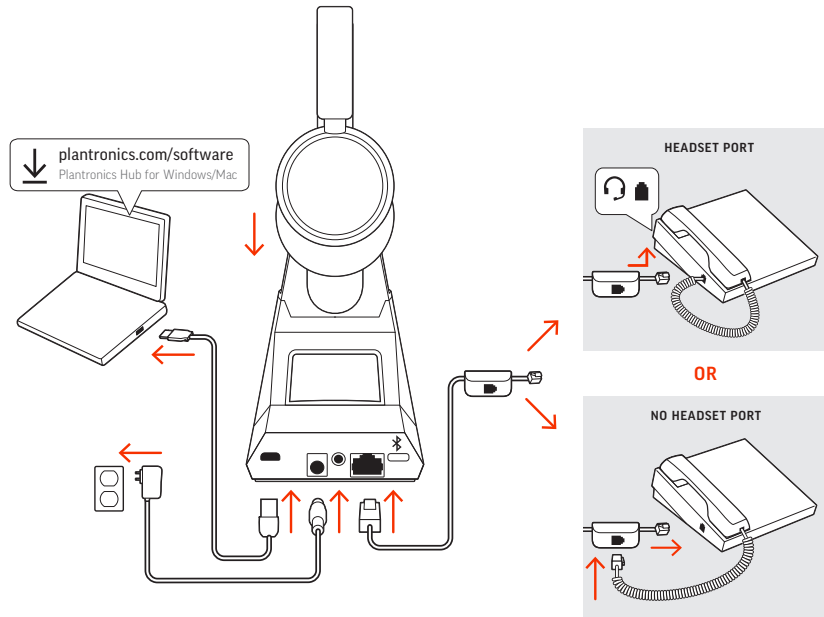

\*Headset design/headset cradle may vary but function is the same.

## NOTE Base configuration settings

Desk phone	Setting (on bottom of base)
Most phones	A
Cisco phones	D
Cisco phones with EHS cable	A

## Desk phone setup details

Choose a desk phone setup A, B, C or D and connect cables.

### A Desk phone with dedicated headset port

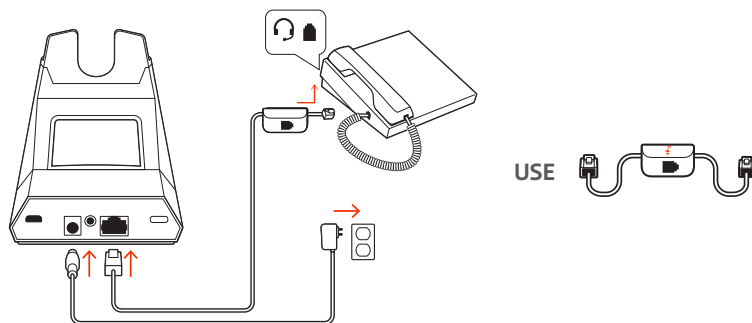

- Connect one end of the telephone interface cable to the back of the base
- Connect the other end of the telephone interface cable into the dedicated headset  port on the desk phone

**IMPORTANT** Cisco phones use configuration **D** on the bottom of the base. Most other phones use default configuration **A**.

**NOTE** Use this setup if you are not using the HL10 lifter or EHS cable. In this configuration, press both the headset  button on your desk phone and the call control button on the headset to answer or end calls.

#### B Desk phone (standard)

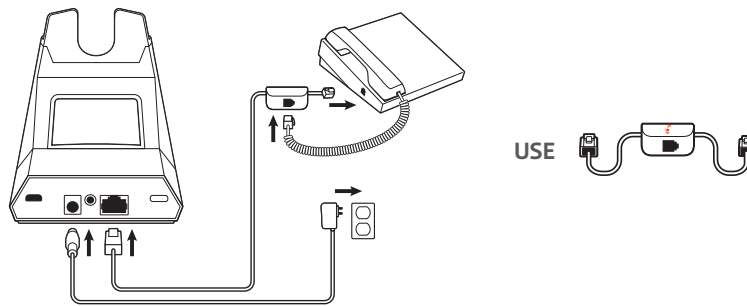

- Connect one end of the telephone interface cable to the back of the base
- Disconnect the handset coil cord from the base of the desk phone and re-connect it to the telephone interface cable junction box
- Finally connect the remaining end of the telephone interface cable into the open handset port on the desk phone

**IMPORTANT** Cisco phones use configuration **D** on the bottom of the base. Most other phones use default configuration **A**.

**NOTE** Use this setup if you are not using the HL10 lifter or EHS cable and your desk phone does not have a dedicated headset port. In this configuration, manually remove the handset on your desk phone and press the call control button on the headset to answer or end calls.

#### C Desk phone + EHS cable (sold separately)

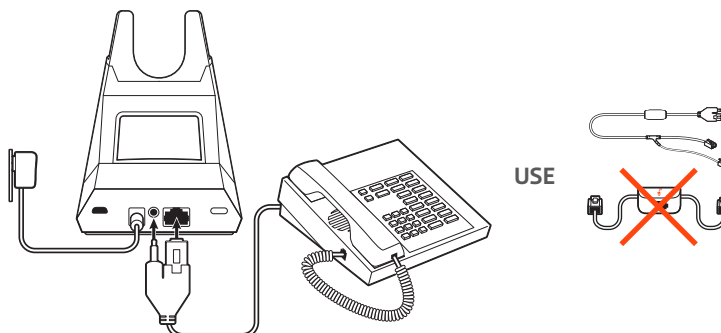

**IMPORTANT** Use configuration **A** on the bottom of the base, which works for most phones including Cisco phones.

**D Desk phone + HL10 lifter (sold separately)**

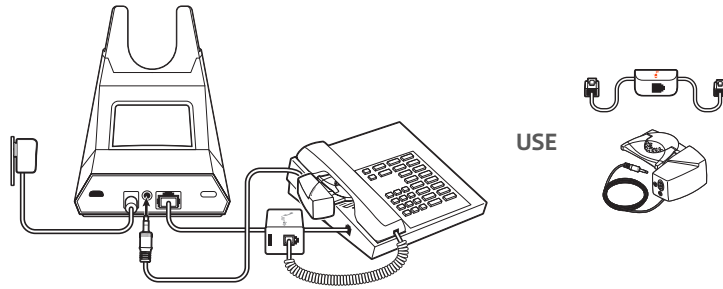

**IMPORTANT** Cisco phones use configuration **D** on the bottom of the base. Most other phones use default configuration **A**.

**Position Your Base**

The minimum recommended separation between your desk phone and the base is 6 inches.

The minimum recommended separation between the base and computer is 12 inches. Incorrect position can cause noise and interference problems.

**NOTE** Headset cradle may vary, but function is the same.

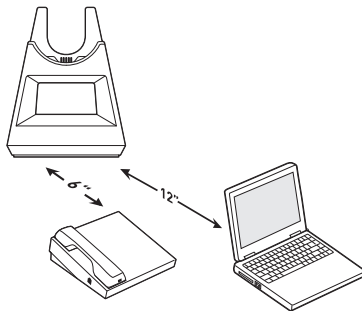



# Pair

## Pair again to base

Your headset comes pre-paired to the base. To pair again:

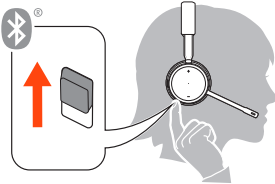
- 1 Slide and hold the headset Power  switch away from the off position until the LEDs flash red and blue.



- 2 Put your base into pair mode by pressing and holding the Bluetooth pairing  button on the back of your base for 2 seconds until the display panel's Bluetooth  icon flashes blue and red.



Pairing is successful when you hear "pairing successful" and "base connected" and the display panel's Bluetooth  icon turns solid blue.

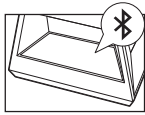

**NOTE** Your headset can pair with up to 8 devices but only maintain 2 connections simultaneously; this includes the base.

## Pair to mobile device

- 1 To put your headset in pair mode, slide and hold the Power  switch away from the off position until you hear "pairing" and the headset LEDs flash red and blue.

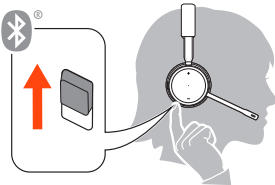

- 2 Activate Bluetooth on your phone and set it to search for new devices.
  - iPhone Settings > Bluetooth > On\*
  - Android Settings > Bluetooth: On > Scan for devices\*

**NOTE** \*Menus may vary by device.

- 3 Select "PLT V4210 Series / PLT V4220 Series."  
If necessary, enter four zeros (0000) for the passcode or accept the connection.

Once successfully paired, you hear "pairing successful" and the headset LEDs stop flashing.

**NOTE** Your headset can pair with up to 8 devices but only maintain 2 connections simultaneously; this includes the base.

## Pair mode

Slide and hold the headset Power  switch away from the off position until the LEDs flash red and blue.



# Fit and charge

## Wear on the right or left

To position the microphone on the right or left side, rotate the microphone boom up and over. Gently bend the boom so it is approximately 2 finger widths from the corner of your mouth.  
**IMPORTANT** For true stereo sound, wear the boom on your right side.

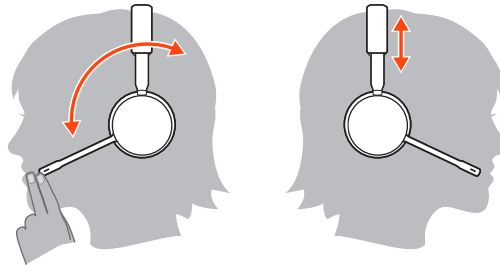

## Charge

Before first use, charge your headset for a minimum of 20 minutes by placing it in the cradle. The base display's battery icon turns solid blue when charging and turns off when charge is complete. A full charge takes approximately 90 minutes.

**NOTE** You may also charge your headset using a micro-USB cable connected to a power source.

## Check headset battery status

There are 3 ways to check the headset battery status. Choose:

- Plantronics Hub for Windows/Mac: click on the Plantronics Hub headset icon in the system tray or menu bar to view battery status
- Plantronics Hub for iOS/Android: check the home screen
- Slide and release the Power switch away from the off position. Listen to the voice alert or observe the headset LEDs.



## Headset LED behavior while charging

---

Off    Charging complete

---

● ● ●    Battery high

---

● ●    Battery medium

---

●    Battery low

---

✖    Battery critical

---

**TIP** To reset the accuracy of the talk time alert, deplete the headset battery then charge fully.

# Load software

Plantronics Hub is an invaluable headset tool.

**NOTE** Some softphones require the installation of Plantronics Hub for Windows and Mac to enable headset control (answer/end and mute) functionality.

- Download Plantronics Hub for Windows/Mac by visiting [plantronics.com/software](https://plantronics.com/software).
- Download Plantronics Hub for iOS/Android by visiting [plantronics.com/software](https://plantronics.com/software), the App Store or Google Play.



Plantronics Hub	iOS and Android	Windows and Mac
Call control for softphones	available for some softphones	X
Change headset language	X	X
Update firmware	X	X
Turn features on/off	X	X
View user guide	X	X
Battery meter	X	X
Find MyHeadset	X	
Use Amazon Alexa (requires app)	X	
Enable Tile (requires app)	X	

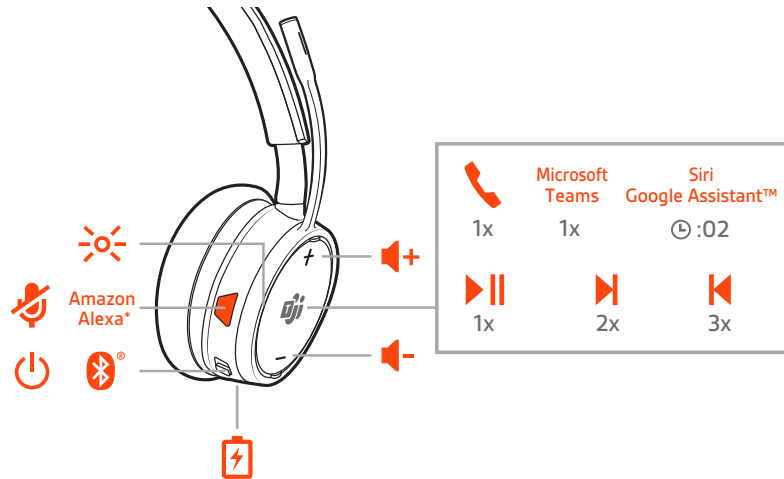

# The Basics



## Power on your headset

To turn on the headset, slide the Power  button.

## Adjust volume

- **Headset volume** Fine-tune your headset volume by adjusting the headset's volume up (+) and down (-) controls.
- **Desk phone volume** When you are on a desk phone call and your voice is too quiet/loud, adjust the speaking  volume on the bottom of the base. If your caller's voice is too loud/quiet on a desk phone call, adjust the listening  volume.
- **Base ringtone volume** Adjust the base ringtone volume setting in Plantronics Hub. This ringtone alerts you if you are not wearing your headset and a call comes in.



## Adjust headset microphone volume (softphone)

Place a test softphone call and adjust softphone volume and PC sound volume accordingly.

## Make, answer, end calls

On the front of the base there are 2 Audio /  buttons: computer and desk phone. These buttons allow you to switch to a different phone line/audio channel.

## Make a call (computer or desk phone)





- 1 Tap an Audio button /  on your base display. You hear a dial tone.  
*Desk phone only: Press the phone's Headset  button or manually remove the handset if you don't have an HL10 lifter or EHS cable.*

**TIP** If you do not hear a dial tone, turn over the base and adjust the switch (A--G). "A" works for the majority of desk phones. "D" works for Cisco phones.

- 2 Dial from your softphone or desk phone.

## Answer or end a call

To answer or end a call, choose:



- Tap the headset Call  button.
- **Computer or desk phone:** Tap the corresponding Audio button /   
*Desk phone only: If you don't have an HL10 lifter or EHS cable, Press the phone's Headset  button or manually remove the handset when answering a call or hang up the handset when ending a call.*

### Mute

During a call, tap the headset mute button. Tap again to unmute. When mute is on, the LED is solid red. Modify your mute settings in Plantronics Hub for Windows/Mac.

### Hold a call

To hold an active call or resume a held call:

- Press the headset Call \ button for 2 seconds.
- **Computer or desk phone:** Press the corresponding base Audio / button for 2 seconds. The button flashes red when a call is on hold.

**NOTE** 2 desk phone calls can be put on hold only from your desk phone.

### Switch between calls (flash)

To switch between calls:

- Press the headset Call \ button for 2 seconds.
- **Computer or desk phone:** Tap the corresponding Audio button on the base. The button flashes red when a call is on hold.

**NOTE** Switching 2 desk phone calls can only be done from your desk phone.

### Launch Microsoft Teams

With Microsoft Teams application installed on your computer, launch by pressing the Teams button on your base or your headset (when not on a call).

**NOTE** Your headset's Microsoft Teams button is also the Call button.

### View Microsoft Teams notifications

Your base's Microsoft Teams button LED pulses when you have a Teams notification.

Tap the button to view notifications on your computer.



# More Features

## Play or pause audio

Tap the Call  button to pause or resume streaming audio.



**NOTE** *Functionality varies by application. May not function with web-based apps.*

### Track selection

Double-tap the Call  button to skip to the next track or triple-tap the Call  button to play the previous track.

**NOTE** *Functionality varies by application. May not function with web-based apps.*

### Fast forward/rewind

Double-tap and hold the Call  button to fast-forward. Triple-tap and hold the Call  button to rewind.

**NOTE** *Functionality varies by application. May not function with web-based apps.*

## Voice assistant (smartphone feature)

**Siri, Google Now™, Cortana** Press and hold the Call button for 2 seconds to activate your smartphone's default voice assistant. Wait for the phone prompt to activate voice dialing, search, and other smartphone voice controls.

**ATTENTION** *Voice assistant is only active when your headset is out of base range and paired to a smartphone.*

## Enable and use Amazon Alexa (smartphone feature)

With Alexa enabled on your headset, you can ask for directions, call friends, access Alexa Skills and more.

**NOTE** *Amazon Alexa isn't available in all languages and countries.*

### 1 Enable Alexa

**A Pair the headset to your mobile device**

**B Update your Plantronics Hub mobile app (software) if necessary**

**C Launch Plantronics Hub app and ensure that your headset (firmware) is up-to-date**

**D From Plantronics Hub main menu, choose Apps > Amazon Alexa > Enable**

**E Launch the Amazon Alexa app and follow the instructions to set up your headset**

### 2 Use Alexa

**A To use Alexa, tap the Mute button (when not on a call) and ask a question. You hear a tone when Alexa is activated.**

## Enable Tile

With the Tile app enabled on your mobile device, you can ring your lost headset or locate it on a map and ask the Tile community for help.

### 1 Pair the headset to your mobile device

### 2 Update your Plantronics Hub mobile app (software) if necessary

### 3 Launch Plantronics Hub app and ensure that your headset (firmware) is up-to-date

### 4 From Plantronics Hub main menu, choose Apps > Tile > Enable

### 5 Launch the Tile app and follow the instructions to connect your headset

## Change your default line

Change the default outbound phone line/audio channel in Plantronics Hub for Windows/Mac.

## Online indicator

Your headset LEDs flash red to inform others that you are on a call. Manage settings in Plantronics Hub.

### Corded mode (audio over USB)

If your audio is cutting out during softphone calls, you may be experiencing Bluetooth density problems. Improve audio performance by using density-friendly corded mode.

- 1 Disconnect your Bluetooth USB adapter from your computer
- 2 Connect your headset directly to your computer with the provided 1.5 m USB cable
- 3 Power off your headset to use density-friendly corded mode

**NOTE** *Your headset battery charges while in corded mode.*

# Troubleshooting

## Headset

---

I can't hear a dial tone in the headset.

- Make sure your headset is charged.
- Make sure your headset is paired to base. See [Pair again to base](#).
- Adjust the configuration switch (A--F) on the bottom of the base until a dial tone is heard. The default **A** works for most phones. **ATTENTION** Use configuration **D** for Cisco phones. Cisco phones connected with EHS cable use configuration **A**.
- Make sure your desk phone is connected correctly to your base. See [Desk phone setup details](#).
- If your base is connected to your desk phone's dedicated headset port, press the desk phone's headset button to hear a dial tone.
- If your base is connected to your desk phone's dedicated headset port, press the desk phone's headset button and base's desk phone button to hear a dial tone.
- If your base is connected to your handset port, manually remove the handset to hear a dial tone (if you do not have an EHS cable or HL10 lifter).
- Make sure your HL10 lifter is lifting the handset high enough to operate the hookswitch; set to a higher setting if necessary.
- Adjust the headset's listening volume. See [Adjust volume](#).
- If the volume is still too low, adjust the desk phone listening volume on the base. See [Adjust volume](#).

---

I hear static.

- Make sure there is at least 12 inches between your base and your computer, and 6 inches between your base and your telephone. If adjusting the distance doesn't help, your headset is going out of range, move closer to the base. See [Position Your Base](#).

---

The sound is distorted.

- Lower the desk phone speaking volume and/or desk phone listening volume on the base. For most telephones the correct setting is position 2. See [Adjust volume](#).
- If your desk phone has a volume control, lower until the distortion disappears.
- If the distortion is still present, adjust the headset volume control to lower the headset speaker volume. See [Adjust volume](#).
- Make sure there is 12 inches between your base and your computer, and 6 inches between your base and your telephone. See [Position Your Base](#).

---

I hear echo in the headset.

- Lower the desk phone speaking volume and/or desk phone listening volume on the base. For most telephones the correct setting is position 2. See [Adjust volume](#).
  - If the audio level is too low in this position, increase the headset volume. See [Adjust volume](#).
  - If your speaking volume is too low for your listener in this position, adjust the position of the headset to make sure the microphone is as close as possible to your mouth.
-

People I talk to can hear a buzz in the background.

- Move the base further away from your phone. See [Position Your Base](#).
- If the base power supply is plugged into a power strip, plug it into the wall directly.

I can't activate Siri or Google Now on my headset.

Your smartphone's default voice assistant is a mobile-only feature and is not active when your headset is in range of your base.

- Ensure that your headset is out of base range
- Ensure that the headset is paired to your smartphone
- See [Voice assistant](#)

I can't activate Alexa on my headset.

- [Alexa requires one-time setup in Plantronics Hub for iOS/Android. See Enable and use Amazon Alexa.](#)

## Desk phone

The handset lifter is installed but does not lift the handset.

- Be sure the handset lifter power cord is firmly pushed into the handset lifter jack on the base.

## Softphone

When I dial from my softphone application, nothing happens.

- Ensure your headset is charged.
- Ensure your headset is paired to the base. See [Pair again to base](#).
- Ensure that Plantronics Hub for Windows and Mac software is installed. To download, visit [plantronics.com/software](http://plantronics.com/software).
- Ensure that you are using a compatible softphone application. For a list of compatible softphones, visit [plantronics.com/software](http://plantronics.com/software).
- If the Plantronics software is not installed and you do not have a compatible softphone, you must first press the base's Audio button and then use the softphone interface to place/answer/end calls.
- Ensure that the headset is the default sound device by going to your Sound Control Panel (Windows) or your Sound System Preferences (Mac).
- Restart your computer.

Speaking and/or listening volume is too low or too high.

- Adjust headset listening volume with volume button.
- Adjust listening/speaking volumes in the computer's sound control panel/system preferences.
- Adjust listening/speaking volumes in the softphone application.

The sound is distorted or I hear an echo in the headset.

- Reduce speaking and/or listening volume on the computer using your softphone application.
- Point microphone towards your chin.
- If the distortion is still present, lower the volume on the headset.

I can no longer hear any audio through my PC Speakers.

**For Windows 10 and Windows 8 systems**



- Go to **Start > Control Panel > Sounds and Audio Devices > Audio > Sound Playback** and change the default setting from your headset to your PC speakers. Click "OK" to confirm your change.

**For Windows Vista and Windows 7 systems**

- Go to **Start > Control Panel > Sounds > Playback** and change the default setting from your headset to your PC speakers. Click "OK" to confirm your change.

**For Mac OS X**

- Choose Apple menu > System Preferences and click Sound.
- Click Output, and then select "Internal Speakers" or your speaker choice.

---

No audio connection to PC.

- Unplug USB and power cables from base. Reconnect power cable first. Wait for power LED to illuminate, then reconnect USB cable. Quit and then re-start your PC audio or softphone application.

---

My audio is cutting out during softphone calls.

- You may be experiencing Bluetooth density problems. Connect your headset directly to your computer. See [Corded mode \(audio over USB\)](#).
-

# Support

## NEED MORE HELP?

[plantronics.com/support](https://plantronics.com/support)

**Plantronics, Inc.**

345 Encinal Street  
Santa Cruz, CA 95060  
United States

**Plantronics B.V.**

Scorpius 171  
2132 LR Hoofddorp  
Netherlands

© 2020 Plantronics, Inc. All rights reserved. Poly, the propeller design, and the Poly logo are trademarks of Plantronics, Inc. Bluetooth is a registered trademark of Bluetooth SIG, Inc. and any use by Plantronics, Inc. is under license. All other trademarks are the property of their respective owners. Manufactured by Plantronics, Inc.

216125-06 02.20