



Russell Hobbs

20 Litre Digital Microwave With Grill



User's Manual

Model number: RHM2031

Please read these instructions carefully and keep them for future reference

Contents

	Page
About this microwave oven	3
Safety instructions.....	4
Microwave oven Installation.....	5
Feature diagram.....	6
Connection to the mains supply.....	6
Control panel.....	7
Operating instructions.....	8
Setting the clock.....	8
Microwave cooking.....	8
Quick start	9
Grill Cooking.....	9
Combination Cooking.....	9
Weight Defrost.....	10
Preset Function.....	10
Auto Cook Menu	10
Child safety lock.....	11
Cleaning and care.....	12
Problem solving.....	13
Important utensil information.....	13
Non-rewireable mains plug.....	15

About this microwave oven

Microwaves are high-frequency electromagnetic waves similar to radio waves. While radio waves may vary in length from one metre to many kilometres, microwaves are very short (less than 12.5 centimetres). Microwaves do not make any heat themselves but only cause water molecules in food to vibrate. This vibration produces the heat that cooks the food. This is why your food will come out of the microwave piping hot, when your utensils inside the oven stay much cooler. The microwaves do not stay in the air or in the food when you open the microwave oven door.

The microwave oven will work using an ordinary household electrical socket. Inside the microwave oven is the magnetron, which turns the electrical energy into microwaves. Microwaves cannot go through metal, so the inside of the oven is lined with metal. The door is lined with a fine metal mesh which stops microwaves getting through. This means that when the microwave oven door is shut, there is no possibility that microwaves can be released. This is why the microwave oven has been made so that it will not work when the door is open.

Before you use your microwave oven

- 1 Remove all the packaging. **Do not remove** the small piece of card from the right hand side of the cavity wall. This is called a wave-guide cover and allows the microwaves to pass through to cook the food.
- 2 Check the oven after unpacking for any visual damage such as:
 - A misaligned door
 - Damage to the door
 - Dents or holes in the door window and screen
 - Dents in the inside

If you can see any damage do not use the oven

Safety instructions

Warning: this oven must be positioned so that the plug is accessible and the plug socket is within easy reach of the power cord.

Warning: only allow children to use the oven without supervision when adequate instructions have been given so that the child is able to use the oven in a safe way and understands the hazards of improper use.

- Children should be supervised to ensure they do not play with the appliance, and the appliance and cable should be kept completely out of reach of young children.
- This appliance is not designed for use by children, or persons with reduced physical, sensory or mental capabilities, and should not be used by such persons unless they can do so safely. Where necessary, such persons (or anyone with lack of experience or knowledge) should first be given supervision or instruction concerning use of the appliance by a person responsible for their safety.

Warning: it is hazardous for anyone other than a competent person to carry out any service or repair operation, which involves the removal of a cover that provides protection against exposure to microwave energy.

Warning: if the door or door seals are damaged, the oven must not be operated until it has been repaired by a competent person. The door seals are located around the window on the inside of the door. These seals are not airtight, although no microwaves can be released; it is normal for small amounts of air or steam to escape when the oven is in use.

Warning: liquids and other foods must not be heated in sealed containers, as they are liable to explode.

- Do not operate the microwave if damaged or after it malfunctions. In the event the supply cord is damaged, it must only be replaced by a qualified service engineer, with a suitably approved part.
- Keep the microwave, cable and plug dry, never immerse in water.
- When heating food in plastic or paper containers, keep an eye on the oven due to the possibility of ignition
- Only use the oven for preparing food. For example do not use for drying clothes, paper or any other non-food items, or for sterilising purposes.
- To avoid damaging the oven, do not use the oven when the cavity is empty.
- Do not store anything in the oven, such as papers, cookbooks and so on.
- Do not cook any food surrounded by a membrane, such as egg yolks, potatoes, chicken livers, ready meals and so on without piercing them several times with a fork.
- Eggs in their shell and whole hard-boiled eggs should not be heated in microwave ovens since they may explode, even after microwave heating has ended.
- Never cover the air vents or put any objects into the openings in the outer case.
- Never remove parts from the oven such as the feet, screws and so on.
- Only use utensils recommended in these instructions.
- Do not try to deep-fry foods in this oven.
- Heat from the contents of a container may be transmitted to the container itself, so please be careful when removing it from the oven. Please remember that the food or liquid inside will be releasing some steam or will be spitting. Never cover any container fully, always leave a gap for steam to escape.
- Cooking utensils may become hot because of heat transferred from the heated food. This is especially true if plastic wrap has been covering the top and handles of the utensil. You may need oven gloves to handle the utensil.
- In order to avoid burns, the contents of feeding bottles and baby food jars should be stirred or shaken and the temperature checked before consumption.

- Always test the temperature of cooked food, never eat or drink food or liquid straight from the oven, allow it to stand for a few minutes and stir to distribute the heat evenly.
- Microwave heating of beverages can result in delayed eruptive boiling, therefore care must be taken when handling the container.
- Food containing a mixture of fat and water (for example, stock) should stand for 30 to 60 seconds in the oven after it has been turned off. This is to allow the mixture to settle and to prevent it from bubbling when a spoon is placed in it, or a stock cube is added.
- When heating or cooking food or liquid, remember that there are certain foods (such as Christmas puddings, jam and mincemeat), which heat up very quickly.
- When heating or cooking foods that contain a lot of fat or sugar, do not use plastic containers.
- Always have the glass tray and turntable support in place when using the oven.
- Do not cook food directly on the glass tray. Put food on a suitable plate or in a bowl before putting it in the oven.

To reduce the risk of fire in the oven cavity:

- Do not overcook food
- Do not leave the microwave oven unattended while you are using it
- Remove wire twist-ties from bags before putting the bag in the oven
- If materials inside the oven catch fire, keep the oven door closed, turn the oven off at the wall switch, or shut the power off at the fuse or circuit-breaker panel

FOOD SAFETY

- Do not cook raw meat or raw shellfish in a microwave, due to the possibility for uneven heating.
- Do not use the microwave oven for home canning or bottling. Improperly canned or bottle foods may spoil and be dangerous to eat.
- Follow cooking instructions on food packaging and always check the temperature of food before serving.

Microwave oven installation

Warning: do not install the oven over a cooker or other heat producing appliance. This will damage the oven. The oven must be placed away from high temperatures and steam.

- This microwave oven weighs approximately 12kg so you must put it on a horizontal surface that is strong enough to support this weight.
- This microwave is designed to be free standing and is not intended to be used 'built in' or in a cabinet.
- Do not put anything on the top of the microwave oven.
- Only use the accessories supplied by the manufacturer.

1. Select a level surface that provides enough space for the outlet vents.
2. A minimum clearance of 3 inches (7.5cm) is required between the oven and any adjacent walls. One side must be open. Leave a minimum clearance of 12 inches (30cm) above the oven.
3. Place the oven as far away from radios and TV's as possible. Using the oven may cause interference with the reception.
4. Plug the oven into a suitable 13amp mains socket, make sure the voltage is the same as on the rating label (do not use extension cables or mains socket adaptors).

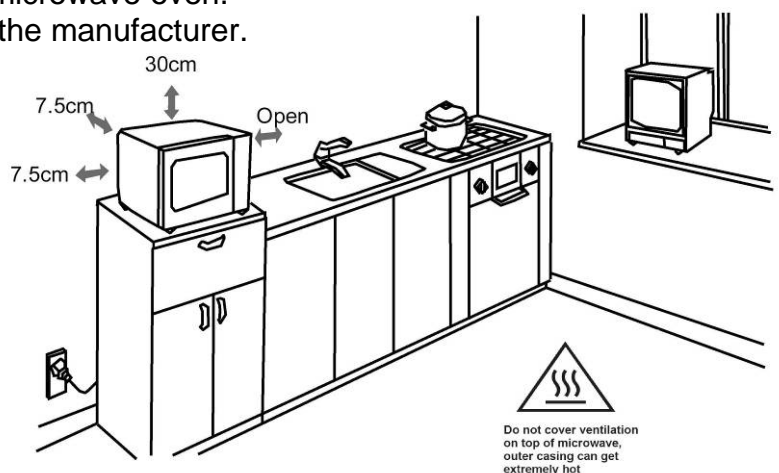

Feature diagram

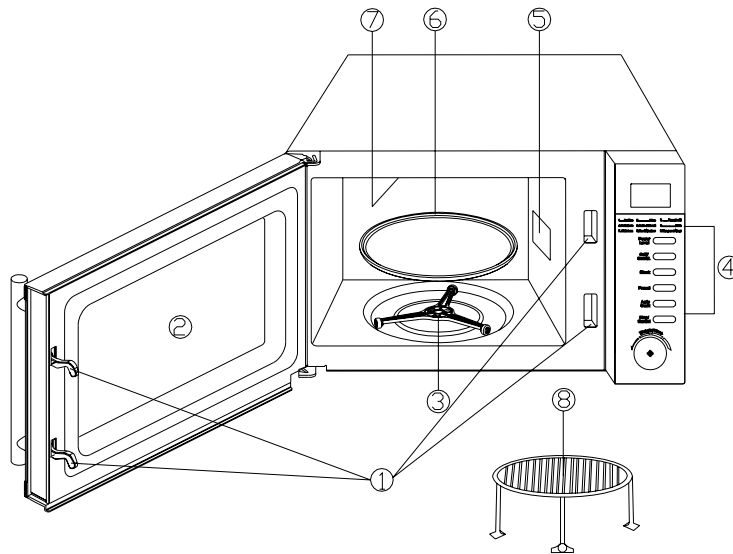

- 1 Door safety lock system
- 2 Oven window
- 3 Turntable roller
- 4 Control panel
- 5 Wave guide cover (do not remove)
- 6 Glass tray
- 7 Grill heater
- 8 Metal rack

Connection to the mains supply

WARNING - THIS APPLIANCE MUST BE EARTHED

This appliance is designed to operate from a mains supply of AC230-240V ~ 50HZ. Check that the voltage marked on the product corresponds with your supply voltage. This product is fitted with a 13A plug complying with BS1363.

If this plug is unsuitable or needs to be replaced, please note the following:

Important: The wires in the mains lead are coloured in accordance with the following code:

GREEN/YELLOW-EARTH

BLUE-NEUTRAL

BROWN-LIVE



DANGER
Electric
Shock Risk

Control panel

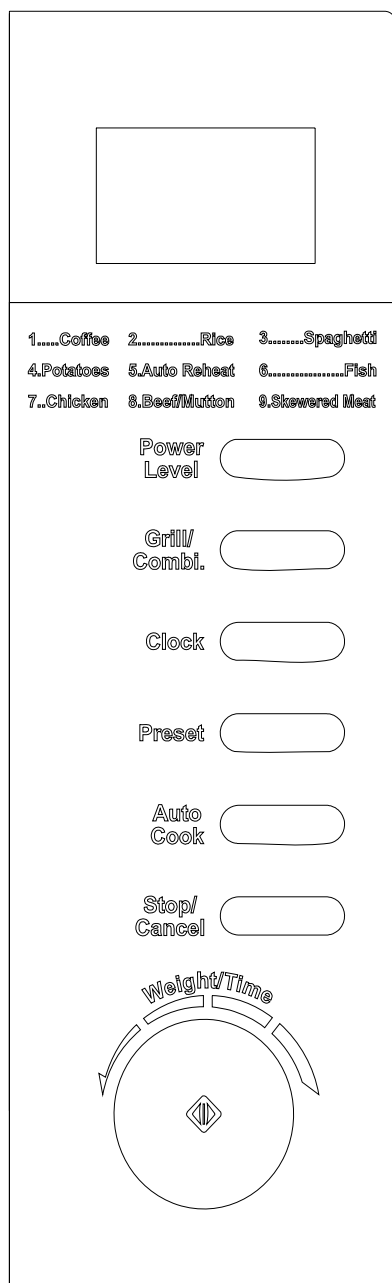

● MENU ACTION SCREEN

Cooking time, power, action indicators, and clock time are displayed

● POWER LEVEL

Touch this button a number of times to set microwave cooking power level.

● GRILL/COMBI.

Press to set a grill or combination cooking programme.

● CLOCK

Touch this button to set the oven clock.

● PRESET

Touch to preset a cooking programme to start at an appointed time automatically.

● AUTO COOK

Touch to set auto cooking.

● STOP/CANCEL

Press to cancel setting or reset the oven before setting a cooking programme.

Press once to temporarily stop cooking, or twice to cancel cooking altogether.

It is also used for setting child lock.

● WEIGHT / TIME (DIAL)

Turn the dial to set the oven clock time or input cooking time.

Turn the dial to set food weight.

● START/QUICK START ()

Press the dial to start cooking programme or set quick start cooking programme

Operating instructions

Connect the main plug into a suitable 13amp mains socket. Make sure the voltage is the same as on the rating label (do not use extension cables or mains adaptors). Each time a button is pressed, a beep will sound to acknowledge the press. After a cooking programme finishes, the system will sound beeps with END on display. And the beeps will continue to sound every two minutes until the door is opened or STOP/CANCEL button is pressed and the system returns to standby mode.

SETTING THE CLOCK

With the oven ready for input, press the CLOCK button once or twice to set the digital clock to 12 or 24 hour cycle.

For example: If you want to set the oven clock time to 8:30.











1. Press CLOCK button once or twice.
2. Turn WEIGHT/TIME dial to indicate the hour digits 8:00. And the LED displays "8: 00" and "0" ("00"flash) .
3. Press CLOCK button once.
4. Turn WEIGHT/TIME dial to indicate the minute digits until the screen shows 8: 30 and "0".
5. Press CLOCK button once to confirm the setting.

NOTE: You can press the CLOCK button once to check clock time during cooking.

MICROWAVE COOKING

To cook with microwave power alone, press the POWER LEVEL button a number of times to select a cooking power level. Then use the WEIGHT/TIME dial to set a desired cooking time. The longest cooking time is 95 minutes.

Select power level by pressing the POWER LEVEL button:

Press POWER LEVEL button	Cooking power	Display
Once	100%	 ,  , "100", "%"
Twice	80%	 ,  , "80", "%"
3 times	60%	 ,  , "60", "%"
4 times	40%	 ,  , "40", "%"
5 times	20%	 ,  , "20", "%"
6 times	00%	 , "00", "%"

For example, suppose you want to cook for 5 minutes at 60% of microwave power.

1. Press POWER LEVEL button repeatedly to select power level.
2. Turn WEIGHT/TIME to show 5:00.
3. Press START/QUICK START button.

Note: During cooking you can check the present cooking power by pressing POWER LEVEL button.

QUICK START

This feature allows you to start the oven quickly at full power.

In standby mode, press the START/QUICK START button a number of times to set the cooking time, the oven starts work at full power level immediately, and the LED displays "0", "0". You can extend the cooking time when cooking is in progress by pressing START/QUICK START (each press for 30 seconds, and up to 10 minutes.)

Grill Cooking

For example: suppose you want to grill food for 12 minutes.

Steps:

1. Press GRILL/COMBI once the LED displays "◇", "W" and "0:10".
2. Turn WEIGHT/TIME until desired time is displayed 12:00.
3. Press START/QUICK START once.

Note: The longest cooking time is 95 minutes.

Combination Cooking

COMBINATION 1

30% time for microwave cooking 70% time for grill cooking. Use for fish or au gratin.

For example: Suppose you want to set the oven to cook with COMBINATION 1 for 25 minutes.

Steps:

1. Press GRILL/COMBI twice, the LED displays "0:10", "◇", "COMB1".
2. Rotate WEIGHT/TIME dial to enter 25:00.
3. Press START/QUICK START.

Note: The longest cooking time is 95 minutes.

COMBINATION 2

55% time for microwave cooking, 45% time for grill cooking. Use for pudding omelettes, baked potatoes, and poultry.

For example: Suppose you want to set the oven to cook with COMBINATION 2 for 12 minutes.

Steps:

1. Press GRILL/COMBI 3 times. The LED displays "0:10", "◇", "COMB2".
2. Rotate WEIGHT/TIME dial to enter 12:00.
3. Press START/QUICK START once.

Note: The longest cooking time is 95 minutes.

WEIGHT DEFROST

Weight Defrost allows the oven to defrost food weights from 100g to 1800g. The time and the defrosting power are adjusted automatically once the weight is programmed.

FOR EXAMPLE: Suppose you want to defrost 600g of shrimp.

1. Place the shrimp to be defrosted into the oven.
2. Turn WEIGHT/TIME dial anti-clockwise once to enter into defrosting mode, and LED displays will show "100", "⊖", "◇" and "**".
3. Rotate the WEIGHT/TIME dial to select food weight.
4. Press START/QUICK START button.

Note: After 2/3 defrosting time the system will pause and signal to remind you to turn over the food, after that, press START/QUICK START to resume.

Preset Function

Preset function allows the oven to start up at a later time. Suppose the clock is running at 11:10 and you want the oven to start cooking at 11:30.

1. Input a cooking programme.
2. Press PRESET button once.
3. Rotate WEIGHT/TIME dial to set hour digit 11.
4. Press PRESET button once.
5. Rotate WEIGHT/TIME dial to set minute digit 30.
6. Press PRESET to confirm. the LED displays 11:30.

Note:

Make sure that the present clock time is correct and the food is placed into the oven in advance before any cooking starts.

When the feature is set, you can check the preset time by pressing PRESET once. The preset time will be displayed for 3 seconds; to cancel the preset function, press STOP/CANCEL pad when the preset time is displayed.

Weight Defrost and Quick Start can not be preset.

AUTO COOK

For food or the following cooking mode, it is not necessary to programme the duration and the cooking power. It is sufficient to indicate the type of food that you wish to cook as well as the weight of this food. For example: to cook 400g of fish.

1. In standby mode, press AUTO COOK to select food code.
2. Rotate the WEIGHT/TIME to indicate the weight of 400g.
3. Press START/QUICK START button.

Auto Cook Menu

Menu code	Menus	Note
01	Coffee(200ml/cup)	<ol style="list-style-type: none"> 1. Turn WEIGHT/TIME dial to indicate weight or amount of food. 2. The result of Auto Cook depends on factors such as fluctuation of voltage, the shape and size of food, your personal preference as to the doneness of certain foods and even how well you happen to place food in the oven. If you find the result at any rate not quite satisfactory, please adjust the cooking time accordingly. 3. For Spaghetti, add boiled water before cooking. 4. For chicken, beef/mutton, skewered meat, the oven will pauses and sound beeps in the middle of cooking time to remind the user to turn over food for uniform cooking.
02	Rice (g)	
03	Spaghetti (g)	
04	Potatoes (each 230g)	
05	Auto Reheat (g)	
06	Fish (g)	
07	Chicken (g)	
08	Beef/Mutton (g)	
09	Skewered Meat (g)	

CHILD SAFETY LOCK

Use to prevent unsupervised operation of the oven by children. The Child Lock indicator will show up on display screen and the oven can not be operated while the Child Lock is set.

To set the Child Lock: In standby mode, press and hold the STOP/CANCEL button for 3 seconds, a beep sounds and lock indicator  "lights, now all buttons (except STOP/CANCEL) are disabled.

To cancel the Child Lock: Press and hold the STOP/CANCEL button for 3 seconds until lock indicator light  on display goes off.

Cleaning and Care

Failure to maintain the oven in a clean condition, could lead to deterioration of the surface that could adversely affect the life of the appliance and possibly result in a hazardous condition. The oven should be cleaned regularly and any food deposits removed.

- Before you clean the microwave oven, turn it off and unplug it.
- Keep the inside of the oven clean. When food or liquids stick to the oven walls, wipe with a damp cloth. We recommend that you do not use harsh detergent or abrasives.
- On the right hand side wall of the cavity is the wave guide cover. Microwaves are passed through this cover to enable your food to cook. It is important that the wave guide cover is kept clean at all times. To do this wipe with mild detergents and water, then dry. Do not remove the waveguide cover.
- You should clean the outside of the oven with a damp cloth and polish dry with a soft dry cloth. Do not allow water to seep into the ventilation openings.
- Wipe the door and window on both sides, the door seals and adjacent parts frequently with a damp cloth to remove any spills or splatters. Do not use an abrasive cleaner.
- Do not allow the control panel to become wet. Clean with a soft, damp cloth. Do not use detergents, abrasives or spray-on cleaners on the control panel.
- If steam builds up inside or around the outside of the oven door, wipe with a soft cloth. This may happen when the microwave oven is used in humid conditions.
- If the inside of the oven smells, put a cup of water with the juice and the skin of one lemon in a deep microwave bowl. Microwave it for three minutes, wipe the cavity walls thoroughly and then dry with a soft cloth.
- Regularly clean the turntable support and oven floor. Simply wipe the bottom surface of the oven with mild detergents and water, and then dry. You can wash the turntable support in soapy water. Check that it is correctly fitted after cleaning.
- Regularly remove the glass tray to clean it, and wash in warm soapy water.
- Do not remove the waveguide cover on the inside wall of the cavity.

Problem solving

The microwave oven may cause interference to your radio, TV or similar equipment. If it does, you can get rid of the interference by moving the radio, TV or equipment as far away from your microwave oven as possible.

If the oven doesn't work, if the display does not appear or if the display has disappeared

- Make sure the oven is plugged in securely. If it is not, remove the plug from the socket, wait 10 seconds and plug it in again securely.
- Check the premises for a blown circuit fuse or a tripped main circuit breaker. If these seem to be working properly, test the socket with another appliance.

If the microwave power will not work

- Make sure the door is securely closed. Otherwise, the microwave energy will not flow into the oven.

Important utensil information

- Use only cookware that is approved to be used in a microwave oven.
- Do not use metal pans or dishes with metal handles.
- Do not use anything with a metal trim.
- Do not use paper covered wire twist-ties on plastic bags.
- Do not use melamine dishes as they contain a material, which will absorb microwave energy. This may cause the dishes to crack or burn and will slow down the cooking speed.
- Do not cook using a container with a restricted opening, such as bottles, as they may explode.
- Do not heat baby bottles with the teat left on and remove the teat if replacing the bottle back into the oven.
- Only use thermometers that are approved for microwave ovens.
- Do not use the microwave oven for heating utensils.

Non-rewireable mains plug

If your appliance is supplied with a non-rewireable plug fitted to the mains lead you will find that it incorporates a fuse, the value of which is indicated either on the base of the plug or on the fuse carrier. Should the fuse need replacing, you must use an ASTA approved fuse (conforming to BS1362) of the same rating. If the fuse cover is lost the plug must not be used until a replacement is obtained from an electrical supplier. If you need to remove the plug, cut it from the mains lead and dispose of it. Never attempt to re-use this plug or insert it into a socket outlet, as there is a very great risk of an electric shock.

SPECIFICATIONS:

Rated voltage:	230-240V~50Hz,
Operating frequency:	2,450MHz
Microwave input:	1200W
Power output:	800W 1000W (Grill)
Outside Dimensions:	262mm x 395mm x 452mm
Oven capacity dimensions	210mm x 329mm x 315mm
Oven Capacity:	20 Litres
Weight:	Approx. 12.5kg

If you have any questions about this product, please call our Careline free on

Important:
For expert product advice,
Please phone the
Russell Hobbs
Helpline on
0844 8793277
Monday – Thursday: 9am until 5pm
Friday: 9am until 4pm
Or send your enquires through email to
microwaves@russellhobbs.co.uk

CE



Revision 1

This symbol is known as the 'Crossed-out Wheelie Bin Symbol'. When this symbol is marked on a product, it means that the product should not be disposed of with your general household waste. Only discard electrical/electronic items in separate collection schemes, which cater for the recovery and recycling of materials contained within. Your co-operation is vital to ensure the success of these schemes and for the protection of the environment.

We reserve the right due to possible changes to design to alter the instruction manual without prior notice.