

Safety Information

Adhere to national and local electrical codes when wiring this unit.

Qualified/licensed electrical personnel should wire this unit.

Disconnect equipment connected to the UPS.

1. Press the OFF button located on the front of the UPS.
2. Disconnect one battery module.
3. Disconnect the UPS from the utility power. Disconnect methods will vary depending on your unit configuration.
 - Unplug the UPS from the wall receptacle.
 - Switch the utility circuit breaker OFF.

Your UPS model may vary from the model depicted in the diagrams. The PDU installation procedure is identical for all models.

Default

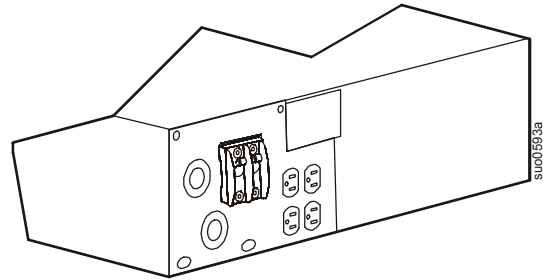

SURT014

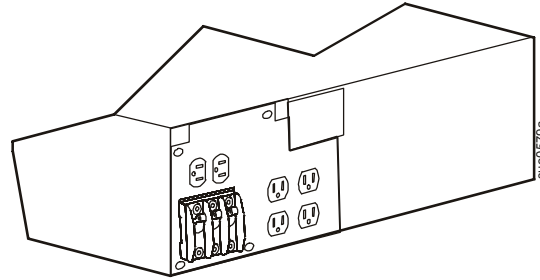

SURT015

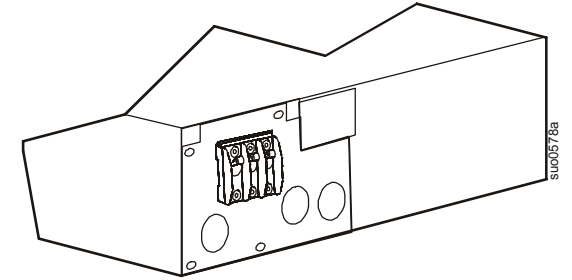

SURT016

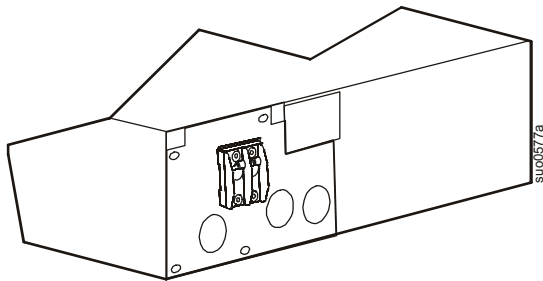

SURT017

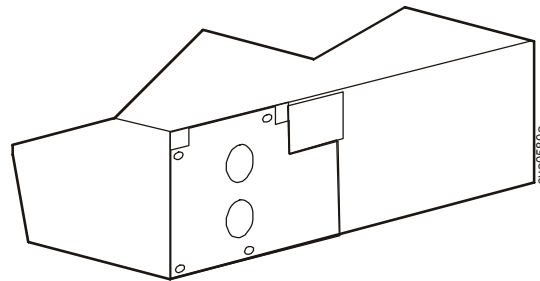

SURT018

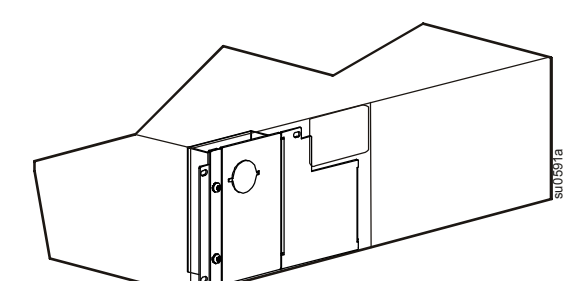

Output Hardwire Instructions

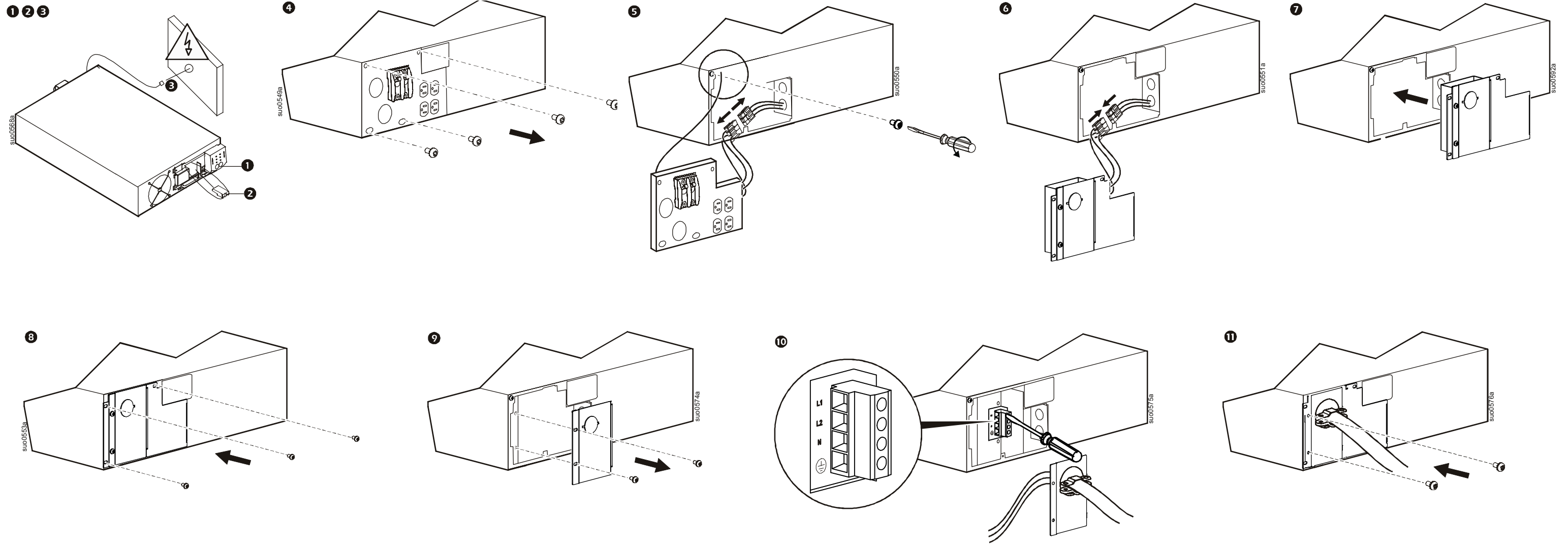

Input Hardwire Instructions

