



ReadyNAS Ultra, Ultra Plus, NVX, and Pro Series

Hardware Manual

Models:

Ultra 2

Ultra 4

Ultra 6

Ultra 2 Plus

Ultra 4 Plus

Ultra 6 Plus

NVX Pioneer

NVX (Business Edition)

Pro 2

Pro 4

Pro 6

Pro Pioneer

Pro (Business Edition)

350 East Plumeria Drive
San Jose, CA 95134
USA

July 2011
202-10846-03

© 2011 NETGEAR, Inc. All rights reserved.

No part of this publication may be reproduced, transmitted, transcribed, stored in a retrieval system, or translated into any language in any form or by any means without the written permission of NETGEAR, Inc.

Technical Support

Thank you for choosing NETGEAR. To register your product, get the latest product updates, or get support online, visit us at <http://support.netgear.com>.

Phone (US & Canada only): 1-888-NETGEAR

Phone (Other Countries): See support information card.

Trademarks

NETGEAR, the NETGEAR logo, and Connect with Innovation are trademarks and/or registered trademarks of NETGEAR, Inc. and/or its subsidiaries in the United States and/or other countries. Information is subject to change without notice. © 2011 NETGEAR, Inc. All rights reserved.

Statement of Conditions

To improve internal design, operational function, and/or reliability, NETGEAR reserves the right to make changes to the products described in this document without notice. NETGEAR does not assume any liability that may occur due to the use, or application of, the product(s) or circuit layout(s) described herein.

Table of Contents

Chapter 1 Getting Started

Additional Documentation	6
Choosing a Setup Location	6
System Requirements	7
Diskless Units	7

Chapter 2 ReadyNAS Ultra 2, Ultra 2 Plus, Pro 2

Front and Side Panels	10
Drive Bay	11
Rear Panel	12
Status Information	13
System Shutdown	13
Boot Menu	14

Chapter 3 ReadyNAS Ultra 4, Ultra 4 Plus, Pro 4, NVX Pioneer, NVX (Business Edition)

Front and Side Panels	17
Drive Bay	18
Rear Panel	19
Status Information	20
System Shutdown	21
Boot Menu	21

Chapter 4 ReadyNAS Ultra 6, Ultra 6 Plus, Pro 6, Pro Pioneer, Pro (Business Edition)

Front and Side Panels	24
Drive Bay	25
Rear Panel	26
Status Information	27
System Shutdown	28
Boot Menu	28

Chapter 5 Disks

Previously Formatted Disks	31
Adding a Disk	32
Failed Disk Notification	33
Replacing a Disk	33

Appendix A Defaults and Technical Specifications

Two-Bay Systems36
Four-Bay Systems38
Six-Bay Systems40
Safety Warnings42
 Electrical Safety Precautions42
 General Safety Precautions43
 Electrostatic Discharge (ESD) Precautions43

Appendix B Compliance Notification

Index

Getting Started

1

Congratulations on your purchase of a NETGEAR ReadyNAS® storage system. This *ReadyNAS Ultra, Ultra Plus, NVX, and Pro Series Hardware Manual* describes the physical features of these storage systems.

This chapter contains the following sections:

- *Additional Documentation*
- *Choosing a Setup Location*
- *System Requirements*
- *Diskless Units*

Additional Documentation

For detailed information about configuring, managing, and using your storage system, see the appropriate software manual for your unit, as listed in the following table.

Model	Software Manual
Ultra Series: Ultra 2, Ultra 4, Ultra 6	<i>ReadyNAS for Home RAIDiator 4.2.17 Software Manual</i>
Ultra Plus Series: Ultra 2 Plus, Ultra 4 Plus, Ultra 6 Plus	
NVX Pioneer	
Pro Pioneer	
NVX (Business Edition)	<i>ReadyNAS for Business RAIDiator 4.2.17 Software Manual</i>
Pro 2	
Pro 4	
Pro 6	
Pro (Business Edition)	

Both documents are available at <http://www.readynas.com/documentation>.

NETGEAR maintains a community website that supports ReadyNAS products. Visit <http://readynas.com> for reviews, tutorials, a comparison chart, software updates, documentation, an active user forum, and much more.

Choosing a Setup Location

Your ReadyNAS desktop unit is suitable for use in a home or small office environment where it can be freestanding. The small, compact size makes it suitable for sitting on a desk or on a closet shelf.

Choose a location for your unit that meets these criteria:

- Cables can be connected easily.
- Water or moisture cannot enter the case.
- Airflow around the unit and through the vents in the side of the case is not restricted.
- The air is as free of dust as possible.
- Temperature operating limits are not likely to be exceeded.
- If you are using an uninterruptable power supply (UPS) for protection, the power cable can be securely and safely connected to the UPS.

System Requirements

Your ReadyNAS desktop unit requires the following:

- Ethernet connection
- Microsoft Windows 7, Vista, XP, 2000, Mac OS, UNIX, or Linux operating system
- Microsoft Internet Explorer 7.0+, Apple Safari, 2.0+, Mozilla Firefox 2.0+, or Opera 9.5+ browser
- Hard disk drive or drives from the NETGEAR Hardware Compatibility List; see http://www.readynas.com/hard_disk_hcl.

Diskless Units

If you purchased a ReadyNAS storage system without a pre-installed hard disk drive or drives, you must follow this procedure before you use your unit. The following procedure is illustrated with a 2-bay ReadyNAS storage system, but the same steps apply to 4-bay and 6-bay models.

➤ **To prepare a diskless unit for first use:**

1. Obtain at least one hard disk drive that appears on the NETGEAR Hardware Compatibility List.

See http://www.readynas.com/hard_disk_hcl.

If you are using a previously formatted disk, see the precautions listed in *Previously Formatted Disks* on page 27.

2. With the unit turned off, insert a disk into a drive bay, as follows:
 - a. Press the disk tray release latch.

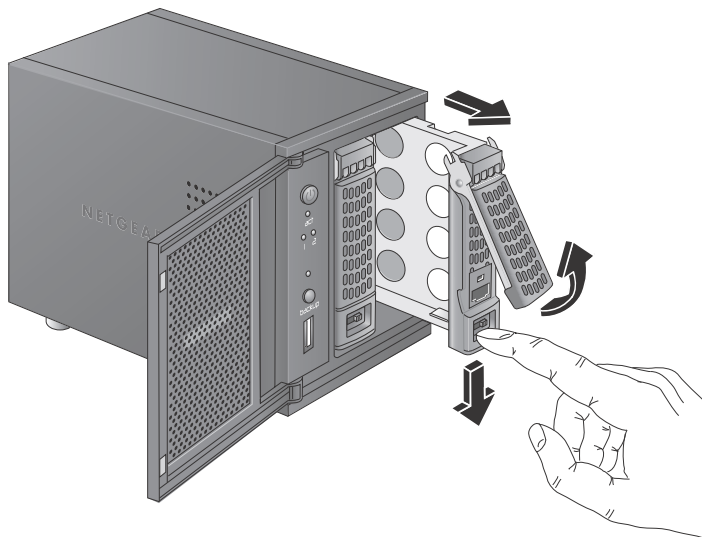

The tray handle pops out.

- b. Pull out the disk tray, place the new disk on the tray, and assemble the disk and tray with the screws that came with your unit.
- c. Make sure that the hard disk connectors face the interior of the disk bay.

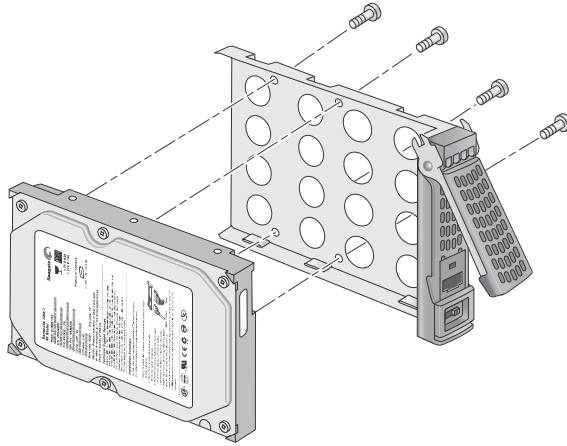

- d. Slide the disk tray back into the unit and press the handle to secure the disk.
3. Turn the unit on and perform a factory reboot.
 - e. See *Boot Menu* on page 15.

Note: Note: This process erases all data and formats the disk as X-RAID2™. If you are using a previously formatted disk that contains data you want to preserve, you must move the data to an external drive before using the previously formatted disk in your ReadyNAS unit.

The factory reboot process can take up to 30 minutes while your unit tests and formats the disk, installs the operating system, and creates a volume. This process can take up to 30 minutes; you can follow the progress in RAIDar. For more information about RAIDar, see the software manual for your unit, which is available at <http://www.readynas.com/documentation>.

If you are installing multiple disks at the same time, they must synchronize. This might take several hours, depending on the disk size. You can continue to use your ReadyNAS, although access is slower until the volume synchronization finishes.

2 ReadyNAS Ultra 2, Ultra 2 Plus, Pro 2

2

This chapter provides an overview of the physical features of the ReadyNAS Ultra 2, Ultra 2 Plus, and Pro 2 and includes the following sections:

- *Front and Side Panels*
- *Drive Bay*
- *Rear Panel*
- *Status Information*
- *System Shutdown*
- *Boot Menu*

Front and Side Panels

This section describes the front and side panels of ReadyNAS Ultra 2, Ultra 2 Plus, and Pro 2 units. Your unit's color might vary from the color shown in this manual.

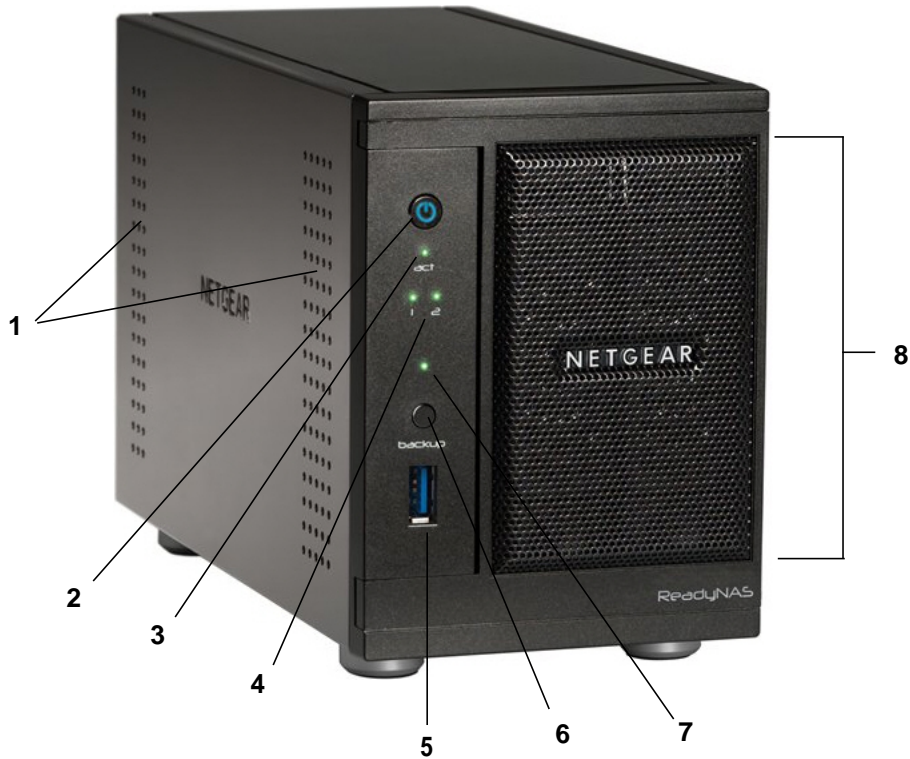

Figure 1. ReadyNAS Ultra 2, Ultra 2 Plus, and Pro 2 front and side panels

1. Exhaust vents
2. Power button and LED
3. Disk activity LED
4. Disk 1 and disk 2 LEDs
5. USB 3.0 port
6. Backup button
7. USB and backup status LED
8. Drive bay door

Drive Bay

This section describes the drive bay of ReadyNAS Ultra 2, Ultra 2 Plus, and Pro 2 units.



Figure 2. ReadyNAS Ultra 2, Ultra 2 Plus, and Pro 2 drive bay

1. Drive bay door
2. Disk bays
3. Recessed disk tray locking mechanism
4. Disk release latch
5. Disk tray latch handle
6. Disk tray

Rear Panel

This section describes the rear panel of ReadyNAS Ultra 2, Ultra 2 Plus, and Pro 2 units.

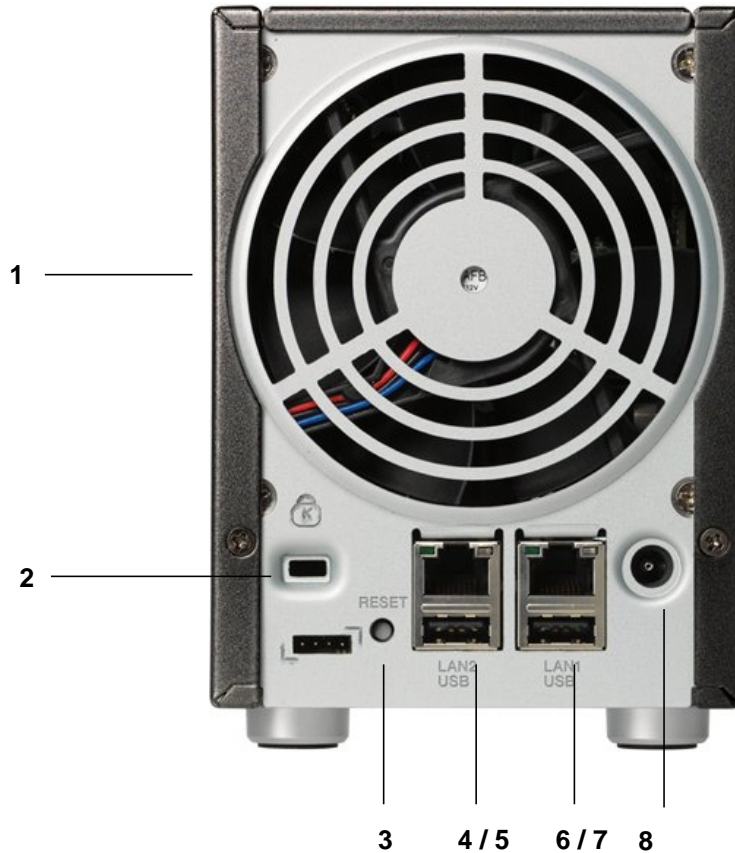

Figure 3. ReadyNAS Ultra 2, Ultra 2 Plus, and Pro 2 rear panel

1. Exhaust fan
2. Kensington lock
3. Reset button
4. LAN2 gigabit Ethernet port with LED status indicators
5. USB 2.0 port
6. LAN1 gigabit Ethernet port with LED status indicators
7. USB 2.0 port
8. Power cable socket

Status Information

You can obtain information about the status of your unit by reviewing the indicators listed in the following table.

Indicator	Description
Power button and LED	Press this button to turn on the ReadyNAS. The LED has these states: <ul style="list-style-type: none"> • Blinking. Booting • Blue. Powered on • Off. Powered off
Disk LEDs (1, 2)	Each disk bay has an LED associated with it on the front panel of the unit. The disk LEDs have these states: <ul style="list-style-type: none"> • On. Power is on and the disk is operating normally. • Blinking. The disk was removed, failed, or is resynchronizing. • Off. The disk bay is empty.
Disk activity LED	The disk activity LED has these states: <ul style="list-style-type: none"> • Blinking green. A disk is active. • Off. No disks are active.
Rear panel Ethernet ports	Two LED status indicators are built into these ports. One LED indicates port activity. The other LED indicates connection speed as follows: <ul style="list-style-type: none"> • Green. The port is operating at 1,000 Mbps. • Amber. The port is operating at 100 Mbps. • Off. The port is operating at 10 Mbps.

System Shutdown

You can shut down your unit in these ways:

- **Using the Power button:**
 - **Preferred shutdown.** Press the **Power** button twice initiate a graceful shutdown.
 - **Forced shutdown.** If the unit is hung, press the **Power** button and hold for 5 seconds to force shutdown.
- **Using FrontView.** For information about using FrontView to shut down your storage system, see the software manual for your unit, which is available at <http://www.readynas.com/documentation>.

Boot Menu

Use the boot menu to restart or troubleshoot your ReadyNAS unit. Your unit has the following boot modes:

- **Normal.** Initiates a normal boot process, just like booting using the Power button.
- **Factory default.** Initiates a short disk test that takes approximately 5 minutes, then begins a 10-minute time-out period waiting for RAIDar. During the 10-minute time-out period, the system can be powered off safely without causing any data loss. After 10 minutes, or if you select the factory default option with RAIDar during the time-out period, the factory default process begins.



WARNING!

The factory default reboot process resets the unit to factory settings, erases all data, resets all defaults, and reformats the disk to X-RAID2.

- **OS reinstall.** Reinstalls the firmware from the internal flash to the disks. Use the OS reinstall boot mode when the system crashes and corrupts some configuration files. OS reinstall boot mode also resets some settings on your unit, such as Internet protocol settings and the administrator password, to defaults.
- **Tech support.** Boots into a low-level diagnostic mode. Use the tech support boot mode only when instructed to do so by a NETGEAR Technical Support representative.
- **Skip volume check.** After a system crash, the system tries to scan and fix the volume using a file system check. If several problems are found on a disk, this process can stall, causing the system not to boot. Use this option to skip the scan and let the system boot.



WARNING!

Use the skip volume check boot mode only when instructed to do so by a NETGEAR Technical Support representative, otherwise data loss might occur.

- **Memory test.** Performs a memory test. The pass or fail result is reported using the unit's LEDs. Contact a NETGEAR technical support representative to interpret memory test results.
- **Disk test.** Performs an offline full disk test. This can take 4 hours or more, depending on the size of your disks. Any problems are reported in the RAIDar discovery tool.

➤ **To access the boot menu:**

1. Power off your unit.
2. Using a straightened paper clip, press and hold the **Reset** button.
3. Press the **Power** button to power on the unit.
4. Continue to press the **Reset** button until the Power button LED, USB and backup status LED, disk 1 LED, and disk 2 LED illuminate.
5. Press the **Backup** button to scroll through boot mode options.

The unit shows the boot mode options using the LEDs, as described in the following table:

Boot Mode	Status Indicator				
	Description	Power LED	Disk 1 LED	Disk 2 LED	USB & Backup LED
Normal	Power LED illuminates.	■	□	□	□
Factory default	Disk 1 LED illuminates.	□	■	□	□
OS reinstall	Disk 2 LED illuminates.	□	□	■	□
Tech support	USB and backup status LED illuminates.	□	□	□	■
Skip volume check	Power LED and disk 1 LED illuminate.	■	■	□	□
Memory test	Power LED and disk 2 LED illuminate.	■	□	■	□
Disk test	Power LED and USB and backup status LED illuminate.	■	□	□	■

Legend:

- On: ■
- Off: □

6. Press and release the **Reset** button to confirm your boot menu selection.

The system boots in the selected boot mode.

ReadyNAS Ultra 4, Ultra 4 Plus, Pro 4, NVX Pioneer, NVX (Business Edition)

3

This chapter provides an overview of the physical features of the ReadyNAS Ultra 4, Ultra 4 Plus, Pro 4, NVX Pioneer, and NVX (Business Edition) and includes the following sections:

- *Front and Side Panels*
- *Drive Bay*
- *Rear Panel*
- *Status Information*
- *System Shutdown*
- *Boot Menu*

Front and Side Panels

This section describes the front and side panels of ReadyNAS Ultra 4, Ultra 4 Plus, Pro 4, NVX Pioneer, and NVX (Business Edition) units. Your unit's color might vary from the color shown in this manual.

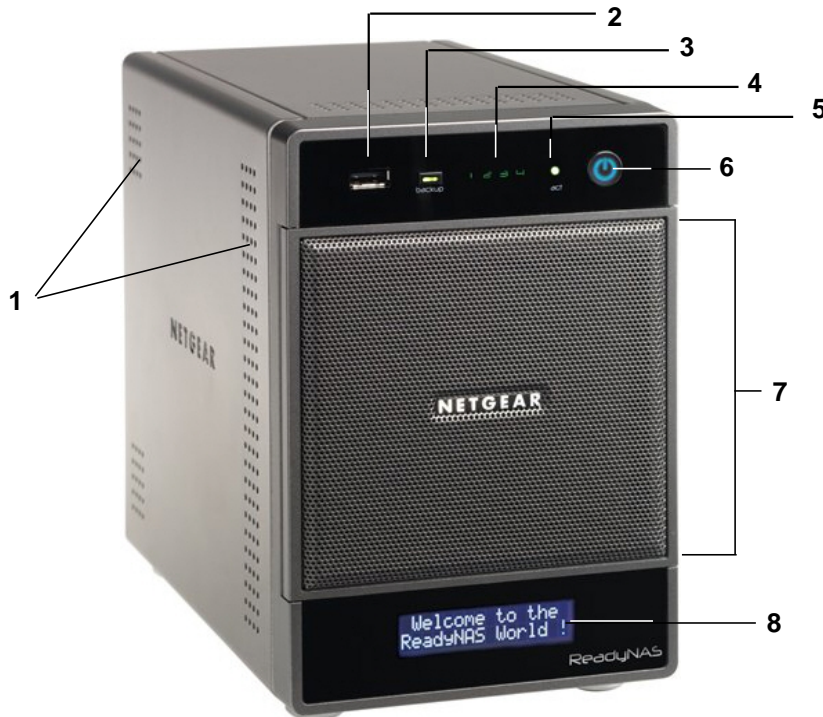

Figure 4. ReadyNAS Ultra 4, Ultra 4 Plus, Pro 4, NVX Pioneer, and NVX (Business Edition) front and side panels

1. Exhaust vents
2. USB 2.0 port
3. Backup button and backup LED
4. Disk LEDs
5. Disk activity LED
6. Power button and LED
7. Drive bay door
8. Status display screen

Drive Bay

This section describes the drive bay of ReadyNAS Ultra 4, Ultra 4 Plus, Pro 4, NVX Pioneer, and NVX (Business Edition) units.

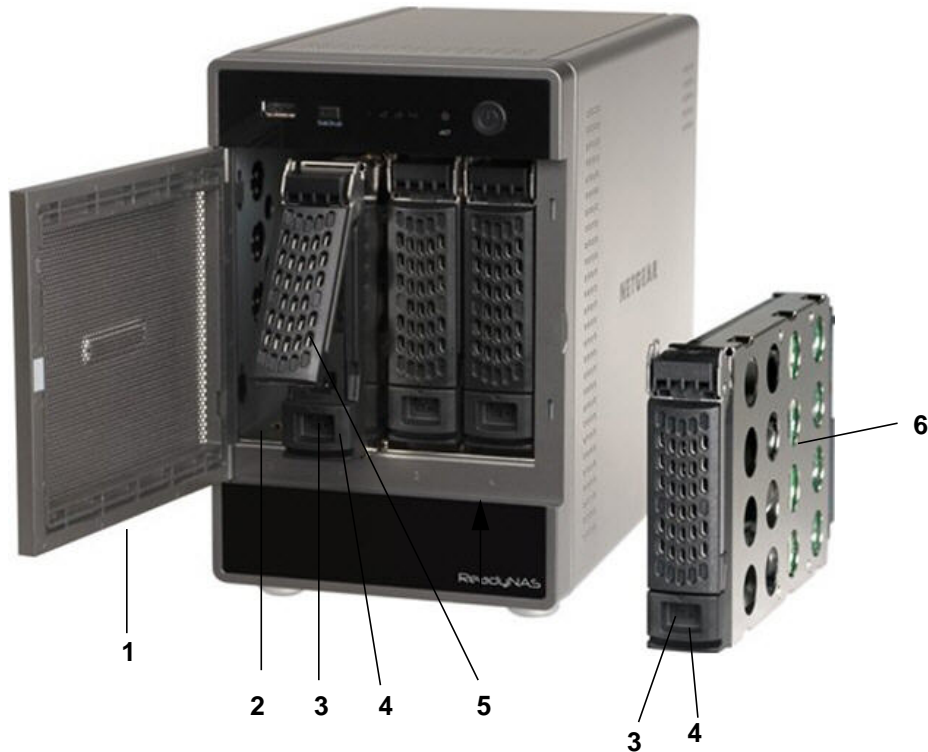

Figure 5. ReadyNAS Ultra 4, Ultra 4 Plus, Pro 4, NVX Pioneer, and NVX (Business Edition) drive bay

1. Drive bay door
2. Disk bays
3. Recessed disk tray locking mechanism
4. Disk release latch
5. Disk tray latch handle
6. Disk tray

Rear Panel

This section describes the rear panel of ReadyNAS Ultra 4, Ultra 4 Plus, Pro 4, NVX Pioneer, and NVX (Business Edition) units.

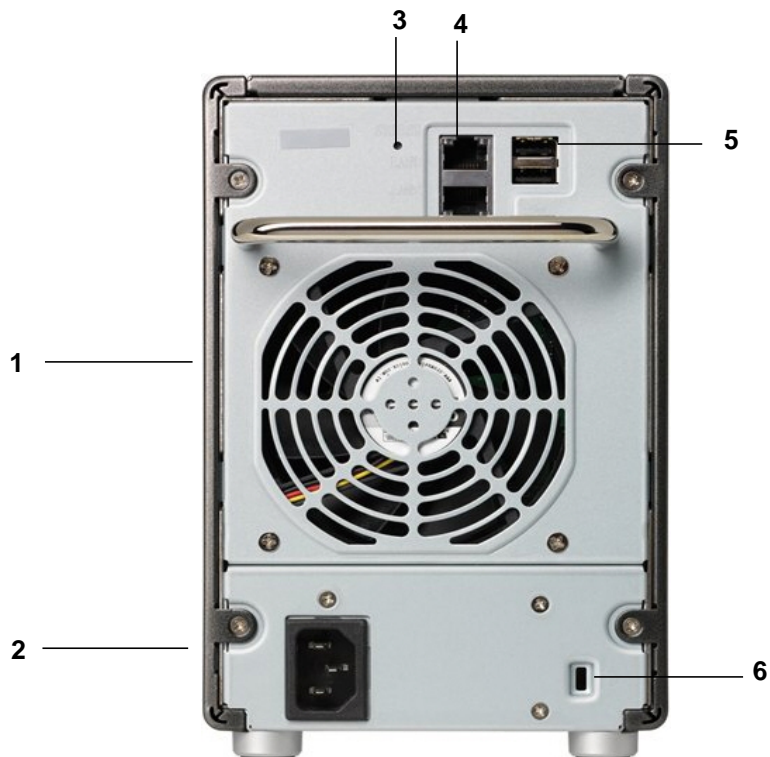

Figure 6. ReadyNAS Ultra 4, Ultra 4 Plus, Pro 4, NVX Pioneer, and NVX (Business Edition) rear panel

1. Exhaust fan
2. Power cable socket
3. Reset button
4. LAN1 and LAN2 gigabit Ethernet ports with LED status indicators
5. USB 2.0 ports
6. Kensington lock

Status Information

You can obtain information about the status of your unit by reviewing the indicators listed in the following table.

Item	Description
Power button and LED	Press this button to turn on the ReadyNAS. The LED has these states: <ul style="list-style-type: none"> • Blinking. Booting • Blue. Powered on • Off. Powered off
Disk LEDs (1, 2, 3, 4)	Each disk bay has an LED associated with it, in numerical order from left to right, along the top of the front panel of the unit. The disk LEDs have these states: <ul style="list-style-type: none"> • On. Power is on and the disk is operating normally. • Blinking. The disk failed or is resynchronizing. See the status display screen for details. • Off. The disk bay is empty.
Disk activity LED	The disk activity LED has these states: <ul style="list-style-type: none"> • Blinking green. A disk is active. • Off. No disks are active.
Rear panel Ethernet port LEDs	Two LED status indicators are built into these ports. One LED indicates port activity. The other LED indicates connection speed as follows: <ul style="list-style-type: none"> • Green. The port is operating at 1,000 Mbps. • Amber. The port is operating at 100 Mbps. • Off. The port is operating at 10 Mbps.
Status display screen	Displays messages about the status of your unit. Note that the status display screen goes to sleep to prevent burn-in; to wake it, press the Power button. If the unit reports an abnormal operation or error, the status display screen stays on.

System Shutdown

You can shut down your unit in two ways:

- **Using the Power button:**
 - **Preferred shutdown:**
 - If the status display screen is not lit, press the **Power** button three times to initiate a graceful shutdown.
 - If the status display screen is lit, press the **Power** button two times to initiate a graceful shutdown.
 - **Forced shutdown.** If the unit is hung, press the **Power** button and hold for 5 seconds to force shutdown.
- **Using FrontView.** For information about using FrontView to shut down your storage system, see the software manual for your unit, which is available at <http://www.readynas.com/documentation>.

Boot Menu

Use the boot menu to restart or troubleshoot your ReadyNAS unit. Your unit has the following boot modes:

- **Normal.** Initiates a normal boot process, just like booting using the Power button.
- **Factory default.** Initiates a short disk test that takes approximately 5 minutes, then begins a 10-minute time-out period waiting for RAIDar. During the 10-minute time-out period, the system can be powered off safely without causing any data loss. After 10 minutes, or if you select the factory default option with RAIDar during the time-out period, the factory default process begins.



WARNING!

The factory default reboot process resets the unit to factory settings, erases all data, resets all defaults, and reformats the disk to X-RAID2.

- **OS reinstall.** Reinstalls the firmware from the internal flash to the disks. Use the OS reinstall boot mode when the system crashes and corrupts some configuration files. OS reinstall boot mode also resets some settings on your unit, such as Internet protocol settings and the administrator password, to defaults.
- **Tech support.** Boots into a low-level diagnostic mode. Use the tech support boot mode only when instructed to do so by a NETGEAR Technical Support representative.
- **Skip volume check.** After a system crash, the system tries to scan and fix the volume using a file system check. If several problems are found on a disk, this process can stall, causing the system not to boot. Use this option to skip the scan and let the system boot.



WARNING!

Use the skip volume check boot mode only when instructed to do so by a NETGEAR Technical Support representative, otherwise data loss might occur.

- **Memory test.** Performs a memory test. The pass or fail result is reported on the status display screen.
- **Disk test.** Performs an offline full disk test. This can take 4 hours or more depending on the size of your disks. Any problems are reported on the status display screen or in the RAIDar discovery tool.

➤ **To access the boot menu:**

1. Power off your unit.
2. Using a straightened paper clip, press and hold the **Reset** button.
3. Press the **Power** button to power on the unit.
4. Continue to press the **Reset** button until the status display screen shows a boot menu message.
5. Press the **Backup** button to scroll through the boot mode options.
The status display screen shows the current boot mode option.
6. When the status display screen shows the boot mode you need, press and release **Reset** button to confirm your boot menu selection.

The system boots in the selected boot mode.

ReadyNAS Ultra 6, Ultra 6 Plus, Pro 6, Pro Pioneer, Pro (Business Edition)

4

This chapter provides an overview of the physical features of the ReadyNAS Ultra 6, Ultra 6 Plus, Pro 6, Pro Pioneer, and Pro (Business Edition) and includes the following sections:

- *Front and Side Panels*
- *Drive Bay*
- *Rear Panel*
- *Status Information*
- *System Shutdown*
- *Boot Menu*

Front and Side Panels

This section describes the front and side panels of ReadyNAS Ultra 6, Ultra 6 Plus, Pro 6, Pro Pioneer, and Pro (Business Edition) units. Your unit's color might vary from the color shown in this manual.

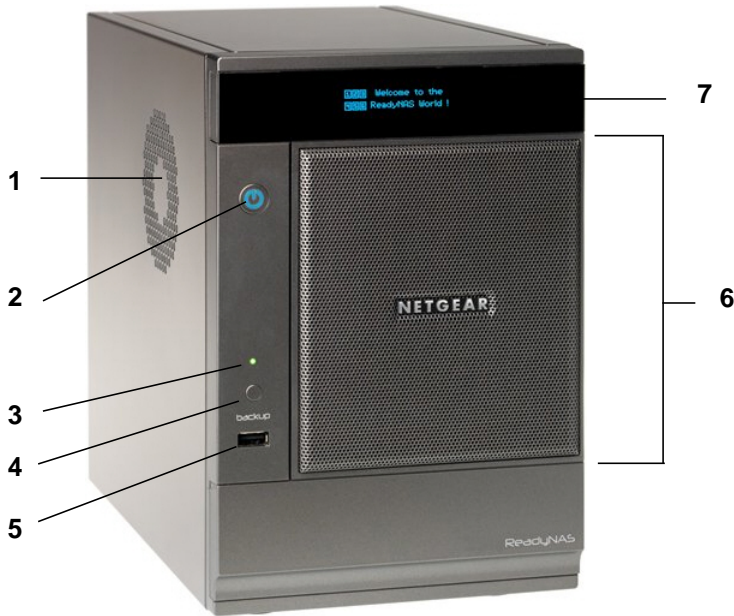

Figure 7. ReadyNAS Ultra 6, Ultra 6 Plus, Pro 6, Pro Pioneer, and Pro (Business Edition) front and side panels

1. Exhaust vent
2. Power button and LED
3. USB and backup status LED
4. Backup button
5. USB 2.0 port
6. Drive bay door
7. Status display screen

Drive Bay

This section describes the drive bay of ReadyNAS Ultra 6, Ultra 6 Plus, Pro 6, Pro Pioneer, and Pro (Business Edition) units.

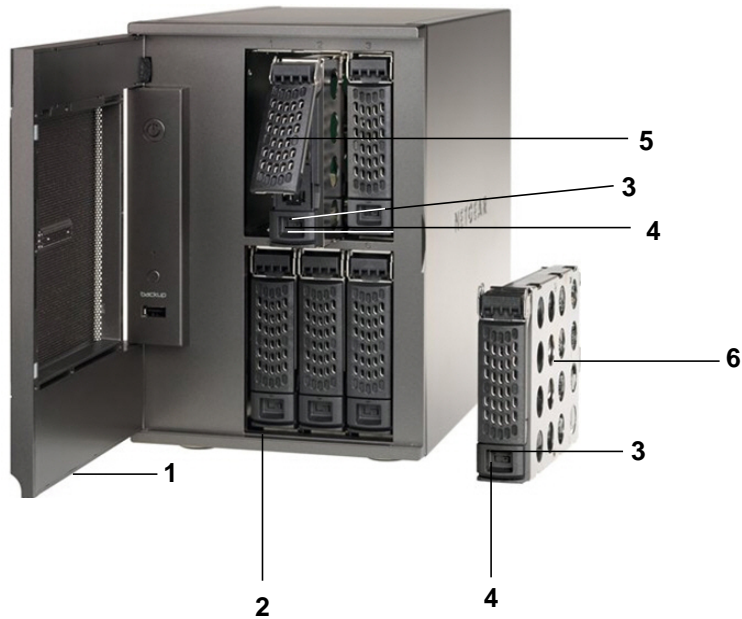

Figure 8. ReadyNAS Ultra 6, Ultra 6 Plus, Pro 6, Pro Pioneer, and Pro (Business Edition) drive bay

1. Drive bay door
2. Disk bays
3. Recessed disk tray locking mechanism
4. Disk release latch
5. Disk tray latch handle
6. Disk tray

Rear Panel

This section describes the rear panel of ReadyNAS Ultra 6, Ultra 6 Plus, Pro 6, Pro Pioneer, and Pro (Business Edition) units.

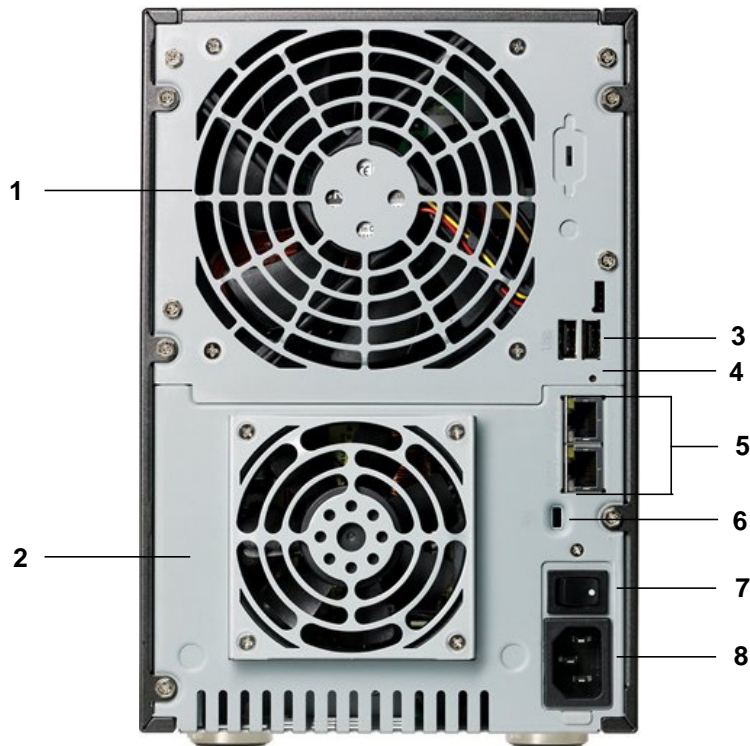

Figure 9. ReadyNAS Ultra 6, Ultra 6 Plus, Pro 6, Pro Pioneer, and Pro (Business Edition) rear panel

1. Exhaust fan
2. PSU exhaust fan
3. USB 2.0 ports
4. Reset button
5. LAN1 and LAN2 gigabit Ethernet ports with LED status indicators
6. Kensington lock
7. Power switch
8. Power cable socket

Status Information

You can obtain information about the status of your unit by reviewing the indicators listed in the following table.

Item	Description
Power button and LED	Press this button to boot the ReadyNAS. The LED has these states: <ul style="list-style-type: none"> • Blinking. Booting • Blue. Powered on • Off. Powered off
Disk icons (1, 2, 3, 4, 5, 6)	Disk icons are located on the status display screen. The disk icons have these states: <ul style="list-style-type: none"> • Empty box. No disk is installed in that bay. • Numbered box. A disk is installed in the bay that corresponds to that icon and it is operating properly. • X in box. The disk in the bay that corresponds to that icon was removed or failed. See the status display screen for details.
Rear panel Ethernet port LEDs	Two LED status indicators are built into these ports. One LED indicates port activity. The other LED indicates connection speed as follows: <ul style="list-style-type: none"> • Green. The port is operating at 1,000 Mbps. • Amber. The port is operating at 100 Mbps. • Off. The port is operating at 10 Mbps.
Status display screen	Displays messages about the status of your unit. Note that the status display screen goes to sleep to prevent burn-in; to wake it, press the Power button. If the unit reports an abnormal operation or error, the status display screen stays on.

System Shutdown

You can shut down your unit in these ways:

- **Using the Power button:**
 - **Preferred shutdown:**
 - If the status display screen is not lit, press the **Power** button three times initiate a graceful shutdown.
 - If the status display screen is lit, press the **Power** button two times to initiate a graceful shutdown.
 - **Forced shutdown.** If the unit is hung, press the Power button and hold for 5 seconds to force shutdown.
- **Using FrontView.** For information about using FrontView to shut down your storage system, see the software manual for your unit, which is available at <http://www.readynas.com/documentation>.

Boot Menu

Use the boot menu to restart or troubleshoot your ReadyNAS unit. Your unit has the following boot modes:

- **Normal.** Initiates a normal boot process, just like booting using the Power button.
- **Factory default.** Initiates a short disk test that takes approximately 5 minutes, then begins a 10-minute time-out period waiting for RAIDar. During the 10-minute time-out period, the system can be powered off safely without causing any data loss. After 10 minutes, or if you select the factory default option with RAIDar during the time-out period, the factory default process begins.



WARNING!

The factory default reboot process resets the unit to factory settings, erases all data, resets all defaults, and reformats the disk to X-RAID2.

- **OS reinstall.** Reinstalls the firmware from the internal flash to the disks. Use the OS reinstall boot mode when the system crashes and corrupts some configuration files. OS reinstall boot mode also resets some settings on your unit, such as Internet protocol settings and the administrator password, to defaults.
- **Tech support.** Boots into a low-level diagnostic mode. Use the tech support boot mode only when instructed to do so by a NETGEAR Technical Support representative.
- **Skip volume check.** After a system crash, the system tries to scan and fix the volume using a file system check. If several problems are found on a disk, this process can stall, causing the system not to boot. Use this option to skip the scan and let the system boot.



WARNING!

Use the skip volume check boot mode only when instructed to do so by a NETGEAR Technical Support representative, otherwise data loss might occur.

- **Memory test.** Performs a memory test. The pass or fail result is reported on the status display screen.
- **Disk test.** Performs an offline full disk test. This can take 4 hours or more depending on the size of your disks. Any problems are reported on the status display screen or in the RAIDar discovery tool.

➤ **To access the boot menu:**

1. Power off your unit.
2. Using a straightened paper clip, press and hold the **Reset** button.
3. Press the **Power** button to power on the unit.
4. Continue to press the **Reset** button until the status display screen shows a boot menu message.
5. Press the **Backup** button to scroll through the boot mode options.
The status display screen shows the current boot mode option.
6. When the status display screen shows the boot mode you need, press and release **Reset** button to confirm your boot menu selection.
The system boots in the selected boot mode.

5 Disks

5

Use only supported disks in your ReadyNAS storage system. If you use unsupported disks, NETGEAR Technical Support will not provide assistance. For a list of supported disks, see the NETGEAR Hardware Compatibility List at http://www.readynas.com/hard_disk_hcl.

For information about configuring disks, see the appropriate software manual for your unit. Manuals are available at <http://www.readynas.com/documentation>.

This chapter includes the following topics:

- *Previously Formatted Disks*
- *Adding a Disk*
- *Failed Disk Notification*
- *Replacing a Disk*

Previously Formatted Disks

You must take care when using previously formatted disks in your ReadyNAS unit, as described in the following table.

Unit Status	Precaution
ReadyNAS unit has no disks (diskless)	<p>Turn the unit off and insert the disk as described in Diskless Units on page 7. Then, perform a factory default reboot as described in the boot menu section for your ReadyNAS unit:</p> <ul style="list-style-type: none"> • Ultra 2, Ultra 2 Plus, and Pro 2 Boot Menu on page 14 • Ultra 4, Ultra 4 Plus, Pro 4, NVX Pioneer, and NVX (Business Edition) Boot Menu on page 21 • Ultra 6, Ultra 6 Plus, Pro 6, Pro Pioneer, and Pro (Business Edition) Boot Menu on page 28 <p>Note: This process erases all data and reformats the previously formatted disk to X-RAID2. If you want to preserve the data on the disk, you must move the data to an external drive before using the previously formatted disk in your ReadyNAS unit.</p> <p>If you try to use a previously formatted disk in your unit without following this process, the unit will indicate that the disk is corrupt.</p>
ReadyNAS unit is operating with one or more disks	<p>With the unit running, insert the disk in an empty disk bay as described in Adding a Disk on page 32. The unit automatically formats the disk in the same format as your existing disks.</p> <p>Note: This process erases all data on the previously formatted disk. If you want to preserve the data on the disk, you must move the data to an external drive before using the previously formatted disk in your ReadyNAS unit.</p>

Previously formatted disks must appear on the NETGEAR Hardware Compatibility List, which is available at http://www.readynas.com/hard_disk_hcl.

Adding a Disk

You can add a hard disk to an empty disk bay. You do not need to shut down your unit before adding a disk.

If you are adding previously formatted disks to your unit, see the precautions in *Previously Formatted Disks* on page 31.

➤ **To add a disk:**

1. Press the disk tray release latch.

The tray handle pops out.

2. Pull out the disk tray and place the new disk on the tray.

Make sure that the hard disk connectors face the interior of the disk bay.

3. Slide the disk tray back into the unit and press the handle to secure the disk.

The volume automatically synchronizes with the new disk in the background. This could take several hours depending on the disk size. You can continue to use your ReadyNAS, although access is slower until the volume synchronization finishes. You are notified by email when the process is complete.

If you are adding disks to a diskless unit, see the software manual for your unit for information about using RAIDar to discover your unit on your local area network for the first time.

Failed Disk Notification

If a disk fails in your ReadyNAS, you are notified by email. Email alerts must be set up for notifications to be sent. In addition, FrontView provides information about the failed disk.

NETGEAR recommends replacing a failed disk with the same disk model. Use FrontView to determine the disk vendor and model used in your unit.

For information about setting up email alerts and using FrontView for the ReadyNAS Ultra series, see the appropriate software manual for your unit. Manuals are available at <http://www.readynas.com/documentation>.



WARNING!

No matter how many hard drives are installed in your unit, ensure that all drive trays remain in the drive bays to maintain adequate airflow.

Replacing a Disk

In the case of a failed disk, the unit provides email alerts and status messages about the need to replace a disk. ReadyNAS supports hot-swap bays, so you do not need to power down your unit when replacing a disk.

If you are replacing a disk with a previously formatted disk, see the precautions in *Previously Formatted Disks* on page 31.

➤ To replace a disk:

1. Press the disk tray pull release latch.
The disk tray handle pops out.
2. Pull out the disk tray and replace the disk.



1. Disk
2. Empty disk tray
3. Assembled disk and tray

3. Make sure that the hard disk connectors face the interior of the disk bay.
4. Slide the disk tray back into the unit and press the handle to secure the disk.

The volume automatically synchronizes with the new disk in the background. This could take several hours depending on the disk size. You can continue to use your ReadyNAS, although access is slower until the volume synchronization finishes. You are notified by email when the process is complete.

A Defaults and Technical Specifications



This appendix includes the following sections:

- *Two-Bay Systems*
- *Four-Bay Systems*
- *Six-Bay Systems*
- *Safety Warnings*

Two-Bay Systems

The following table lists factory default settings for ReadyNAS Ultra 2, Ultra 2 Plus, and Pro 2 storage systems.

Feature		Default
Login		
	User login URL when the ReadyNAS is not connected to a DHCP server	https://192.168.168.168/admin
	Admin user name (case-sensitive)	admin
	Admin login password (case-sensitive)	netgear1
Management		
	System configuration	FrontView web-based configuration and status monitoring
	Discovery, multi-unit status monitoring, and RAID formatting utility	RAIDar for Windows, Mac, and Linux
LAN Connections		
	MAC address	Default address
	MTU size	1500
	Ports	2 Auto Sense 10/100/1000BASE-T, RJ-45
	LAN IP address	DHCP acquired

ReadyNAS Ultra 2, Ultra 2 Plus, and Pro 2 storage systems meet the following technical specifications:

General:

- 2-bay storage
- Intel single-core processor in Ultra 2; Intel dual-core processor in Ultra 2 Plus and Pro2
- 1 GB DDR3 SODIMM RAM
- Two gigabit Ethernet ports
- One USB 3.0 port (front)
- Two USB 2.0 ports (back)
- XRAID2, Flex-RAID
- RAID 0, 1 data protection

Physical dimensions (h x w x d):

- 142 x 101 x 220 mm
- 5.60 x 3.98 x 8.70 in

Physical weight:

- 2.07 kg / 4.56 lb without disks

Power consumption:

- 38 W (with 2 x 2 TB disks)

Electrical:

- Input: DC 12.0V, 5A

Thermal:

- Software controlled 92 mm chassis cooling fan
- High temperature email alert with auto shutdown

Environmental compliance:

- 32° to 104° F
- 20% to 80% Humidity (non-condensing)
- FCC, UL, CE, RoHS, C-tick, VCCI, CCC, KCC compliance

Four-Bay Systems

The following table lists factory default settings for ReadyNAS Ultra 4, Ultra 4 Plus, Pro 4 NVX Pioneer, and NVX (Business Edition) storage systems.

Feature		Default
Login		
	User login URL when the ReadyNAS is not connected to a DHCP server	https://192.168.168.168/admin
	Admin user name (case-sensitive)	admin
	Admin login password (case-sensitive)	netgear1
Management		
	System configuration	FrontView Web-based configuration and status monitoring
	Discovery, multi-unit status monitoring, and RAID formatting utility	RAIDar for Windows, Mac, and Linux
LAN Connections		
	MAC address	Default address
	MTU size	1500
	Ports	2 Auto Sense 10/100/1000BASE-T, RJ-45
	LAN IP address	DHCP acquired

ReadyNAS Ultra 4, Ultra 4 Plus, Pro 4, NVX Pioneer, and NVX (Business Edition) storage systems meet the following technical specifications:

General:

- 4-bay storage
- Intel single-core processor in Ultra 4, NVX Pioneer, NVX (Business Edition), and Pro 4; Intel dual-core processor in Ultra Plus 4 and Pro 4
- 1 GB DDR2 SODIMM RAM
- Two gigabit Ethernet ports
- Three USB 2.0 ports
- XRAID2, Flex-RAID
- RAID 0, 1, 5, 10 data protection

Physical dimensions (h x w x d):

- 200 x 132 x 222 mm
- 7.9 x 5.2 x 8.7 in

Physical weight:

- 4.70 kg / 10.35 lb without disks

Power consumption:

- Ultra 4, Ultra 4 Plus, and Pro 4: 48W (with 4 x 2 TB disks)*
* Using Seagate 2 TB LP drives, with system in idle state
- NVX Pioneer and NVX (Business Edition): 76W (with 4 x 1 TB disks)

Electrical:

- 120W server-rated AC power supply
- Input: 100 to 240V AC, 50/60Hz

Thermal:

- Software controlled 92 mm chassis cooling fan
- High temperature email alert with auto shutdown

Environmental compliance:

- 32° to 104° F
- 20% to 80% Humidity (non-condensing)
- Ultra 4, Ultra 4 Plus, Pro 4: FCC, UL, CE, RoHS, C-tick, VCCI, CCC, KCC compliance
- NVX Pioneer and NVX (Business Edition): FCC, UL, CE, RoHS, C-tick, VCCI, KCC compliance

Six-Bay Systems

The following table lists factory default settings for ReadyNAS Ultra 6, Ultra 6 Plus, Pro 6, Pro Pioneer, and Pro (Business Edition) storage systems.

Feature		Default
Login		
	User login URL when the ReadyNAS is not connected to a DHCP server	https://192.168.168.168/admin
	Admin user name (case-sensitive)	admin
	Admin login password (case-sensitive)	netgear1
Management		
	System configuration	FrontView web-based configuration and status monitoring
	Discovery, multi-unit status monitoring, and RAID formatting utility	RAIDar for Windows, Mac, and Linux
LAN Connections		
	MAC address	Default address
	MTU size	1500
	Ports	2 Auto Sense 10/100/1000BASE-T, RJ-45
	LAN IP address	DHCP acquired

ReadyNAS Ultra 6, Ultra 6 Plus, Pro 6, Pro Pioneer, and Pro (Business Edition) storage systems meet the following technical specifications:

General:

- 6-bay storage
- Intel dual-core processor
- 1 GB DDR2 SODIMM RAM
- Two gigabit Ethernet ports
- Three USB 2.0 ports
- XRAID2 with dual redundancy, Flex-RAID
- RAID 0, 1, 5, 6, 10 data protection

Physical dimensions (h x w x d):

- 250 x 170 x 285 mm
- 10.0 x 6.7 x 11.2 in

Physical weight:

- 7.30 kg / 16.09 lb without disks

Power consumption:

- Ultra 6, Ultra 6 Pro, and Pro 6: 68W (with 6 x 2 TB disks)*
* Using Seagate 2 TB LP drives, with system in idle state
- Pro Pioneer and Pro (Business Edition): 83W (with 6 x 500 GB disks)

Electrical:

- 300W server-rated AC power supply
- Input: 100 to 240V AC, 50/60 Hz

Thermal:

- Software controlled 120 mm chassis cooling fan
- 90 mm CPU cooling fan
- High temperature email alert with auto shutdown

Environmental compliance:

- 32° to 104° F
- 20% to 80% Humidity (non-condensing)
- Ultra 6, Ultra 6 Plus, and Pro 6: FCC, UL, CE, RoHS, C-tick, VCCI, CCC, KCC compliance
- Pro Pioneer and Pro (Business Edition): FCC, UL, CE, C-tick, MIC, VCCI, RoHS compliance

Safety Warnings

1. The equipment contains no operator access areas and is certified for installation only by trained personnel, according to the installation instructions provided with each unit.
2. Install the socket outlet near the equipment in an easily accessible location.
3. Observe the on-board battery precautions.



DANGER:

RISK OF EXPLOSION IF BATTERY IS REPLACED BY AN INCORRECT TYPE. DISPOSE OF USED BATTERIES ACCORDING TO THEIR INSTRUCTIONS.

4. Connect the units and their associated LAN connections only to equipment within the same building.
5. Do not use slide or rail-mounted equipment as a shelf or a work space. 

Electrical Safety Precautions

Follow basic electrical safety precautions to protect yourself from harm and the ReadyNAS from damage:

- Be aware of the locations of the power on/off switch on the chassis as well as the room's emergency power-off switch, disconnection switch, or electrical outlet. If an electrical accident occurs, you can then quickly remove power from the system.
- Do not work alone when working with high-voltage components.
- Always disconnect power from the system when removing or installing main system components, such as the main board or memory modules. When disconnecting power, first power down the system with the operating system and then unplug the power cords of all the power supply units in the system.
- When working around exposed electrical circuits, ensure that another person who is familiar with the power-off controls is nearby to switch off the power if necessary.
- Use only one hand when working with powered-on electrical equipment. This is to avoid making a complete circuit, which will cause electrical shock. Use extreme caution when using metal tools, which can easily damage any electrical components or circuit boards they come into contact with.
- Do not use mats designed to decrease static electrical discharge as protection from electrical shock. Instead, use rubber mats that have been specifically designed as electrical insulators.
- Use only power supply cords that include a grounding plug and plug them into grounded electrical outlets.

General Safety Precautions

Follow these rules to ensure general safety:

- Keep the area around the ReadyNAS clean and free of clutter.
- See the technical specifications in this manual for details about your specific ReadyNAS Ultra unit.
- Replace the on-board battery only with the same battery or an equivalent type of battery recommended by the manufacturer. Dispose of used batteries according to the manufacturer's instructions.



DANGER:

Installing the battery upside down reverses its polarities and creates a danger of explosion.

- Main board replaceable soldered-in fuses: Only trained service technicians can replace the self-resetting PTC (positive temperature coefficient) fuses on the main board, using only new fuses that are the same as or equivalent to the ones being replaced. Contact Technical Support for details and support.

Electrostatic Discharge (ESD) Precautions

Electrostatic discharge (ESD) is generated by two objects with different electrical charges coming into contact with each other. An electrical discharge is created to neutralize this difference, which can damage electronic components and printed circuit boards. The following measures are generally sufficient to neutralize this difference before contact is made to protect your equipment from ESD:



- Use a grounded wrist strap designed to prevent static discharge.
- Keep all components and printed circuit boards (PCBs) in their antistatic bags until ready for use.
- Touch a grounded metal object before removing the board from the antistatic bag.
- Do not let components or PCBs come into contact with your clothing, which might retain a charge even if you are wearing a wrist strap.
- Handle a board by its edges only; do not touch its components, peripheral chips, memory modules, or contacts.
- When handling chips or modules, avoid touching their pins.
- Put the main board and peripherals back into their antistatic bags when not in use.
- For grounding purposes, make sure your computer chassis provides excellent conductivity between the power supply, the case, the mounting fasteners and the main board.

Compliance Notification



Regulatory Compliance Information

This section includes user requirements for operating this product in accordance with National laws for usage of radio spectrum and operation of radio devices. Failure of the end-user to comply with the applicable requirements may result in unlawful operation and adverse action against the end-user by the applicable National regulatory authority.

This product's firmware limits operation to only the channels allowed in a particular Region or Country. Therefore, all options described in this user's guide may not be available in your version of the product.

FCC Requirements for Operation in the United States

FCC Information to User

This product does not contain any user serviceable components and is to be used with approved antennas only. Any product changes or modifications will invalidate all applicable regulatory certifications and approvals

This device complies with Part 15 of the FCC Rules. Operation is subject to the following two conditions: (1) This device may not cause harmful interference, and (2) this device must accept any interference received, including interference that may cause undesired operation.

FCC Guidelines for Human Exposure

This equipment complies with FCC radiation exposure limits set forth for an uncontrolled environment. This equipment should be installed and operated with minimum distance of 20 cm between the radiator and your body.

This transmitter must not be co-located or operating in conjunction with any other antenna or transmitter.

FCC Declaration Of Conformity

We, NETGEAR, Inc., 350 East Plumeria Drive, San Jose, CA 95134, declare under our sole responsibility that the NETGEAR ReadyNAS Ultra, Ultra Plus, NVX, and Pro comply with Part 15 of FCC Rules.

Operation is subject to the following two conditions:

- This device may not cause harmful interference, and
- This device must accept any interference received, including interference that may cause undesired operation.

FCC Radio Frequency Interference Warnings & Instructions

This equipment has been tested and found to comply with the limits for a Class B digital device, pursuant to Part 15 of the FCC Rules. These limits are designed to provide reasonable protection against harmful interference in a residential installation. This equipment uses and can radiate radio frequency energy and, if not installed and used in accordance with the instructions, may cause harmful interference to radio communications. However, there is no guarantee that interference will not occur in a particular installation.

If this equipment does cause harmful interference to radio or television reception, which can be determined by turning the equipment off and on, the user is encouraged to try to correct the interference by one or more of the following methods:

- Reorient or relocate the receiving antenna.
- Increase the separation between the equipment and the receiver.
- Connect the equipment into an electrical outlet on a circuit different from that which the radio receiver is connected.
- Consult the dealer or an experienced radio/TV technician for help.

Modifications made to the product, unless expressly approved by NETGEAR, Inc., could void the user's right to operate the equipment.

Canadian Department of Communications Radio Interference Regulations

This digital apparatus, NETGEAR ReadyNAS Ultra, Ultra Plus, NVX, and Pro do not exceed the Class B limits for radio-noise emissions from digital apparatus as set out in the Radio Interference Regulations of the Canadian Department of Communications.

European Union

The NETGEAR ReadyNAS Ultra, Ultra Plus, NVX, and Pro comply with essential requirements of EU EMC Directive 2004/108/EC and Low Voltage Directive 2006/95/EC as supported by applying the following test methods and standards:

- EN55022: 2006 / A1: 2007
- EN55024: 1998 / A1: 2001 / A2: 2003
- EN60950-1: 2005 2nd Edition
- EN 61000-3-2:2006
- EN 61000-3-3:1995 w/A1: 2001+A2: 2005

Index

B

- battery [42](#)
- boot menu
 - NVX (Business Edition) [21](#)
 - NVX Pioneer [21](#)
 - Pro [14](#)
 - Pro (Business Edition) [28](#)
 - Pro 4 [21](#)
 - Pro 6 [28](#)
 - Pro Pioneer [28](#)
 - Ultra 2 [14](#)
 - Ultra 2 Plus [14](#)
 - Ultra 4 [21](#)
 - Ultra 4 Plus [21](#)
 - Ultra 6 [28](#)
 - Ultra 6 Plus [28](#)

C

- compliance [44](#)

D

- Declaration Of Conformity [44](#)
- disk failure [33](#)
- disk, adding [32](#)
- disk, failure [33](#)
- disk, replacing [33](#)
- diskless units [7](#)
- disks, previously formatted [31](#)
- disks, supported [30](#)
- drive bay
 - NVX (Business Edition) [18](#)
 - NVX Pioneer [18](#)
 - Pro (Business Edition) [25](#)
 - Pro 2 [11](#)
 - Pro 4 [18](#)
 - Pro 6 [25](#)
 - Pro Pioneer [25](#)
 - Ultra 2 [11](#)
 - Ultra 2 Plus [11](#)
 - Ultra 4 [18](#)
 - Ultra 4 Plus [18](#)
 - Ultra 6 [25](#)
 - Ultra 6 Plus [25](#)

E

- electrical safety [42](#)
- electrostatic discharge [43](#)
- email alerts [33](#)
- ESD [43](#)

F

- factory default settings [36](#), [38](#), [40](#)
- failed disk [33](#)
- FCC [44](#)
- front panel
 - NVX (Business Edition) [17](#)
 - NVX Pioneer [17](#)
 - Pro (Business Edition) [24](#)
 - Pro 2 [10](#)
 - Pro 4 [17](#)
 - Pro 6 [24](#)
 - Pro Pioneer [24](#)
 - Ultra 2 [10](#)
 - Ultra 2 Plus [10](#)
 - Ultra 4 [17](#)
 - Ultra 4 Plus [17](#)
 - Ultra 6 [24](#)
 - Ultra 6 Plus [24](#)

G

- general safety [43](#)

H

- Hardware Compatibility List [7](#), [30](#), [31](#)

L

- LEDs
 - NVX (Business Edition) [20](#)
 - NVX Pioneer [20](#)
 - Pro (Business Edition) [27](#)
 - Pro 2 [13](#)
 - Pro 4 [20](#)
 - Pro 6 [27](#)
 - Pro Pioneer [27](#)
 - Ultra 2 [13](#)

Ultra 2 Plus **13**

Ultra 4 **20**

Ultra 4 Plus **20**

Ultra 6 **27**

Ultra 6 Plus **27**

location, unit **6**

P

previously formatted disks **31**

R

rear panel

NVX (Business Edition) **19**

NVX Pioneer **19**

Pro (Business Edition) **26**

Pro 2 **12**

Pro 4 **19**

Pro 6 **26**

Pro Pioneer **26**

Ultra 2 **12**

Ultra 2 Plus **12**

Ultra 4 **19**

Ultra 4 Plus **19**

Ultra 6 **26**

Ultra 6 Plus **26**

S

safety **42, 43**

safety warning **42**

setup location **6**

shutdown, forced

NVX (Business Edition) **21**

NVX Pioneer **21**

Pro (Business Edition) **28**

Pro 2 **13**

Pro 4 **21**

Pro 6 **28**

Pro Pioneer **28**

Ultra 2 **13**

Ultra 2 Plus **13**

Ultra 4 **21**

Ultra 4 Plus **21**

Ultra 6 **28**

Ultra 6 Plus **28**

shutdown, graceful

NVX (Business Edition) **21**

NVX Pioneer **21**

Pro (Business Edition) **28**

Pro 2 **13**

Pro 4 **21**

Pro 6 **28**

Pro Pioneer **28**

Ultra 2 **13**

Ultra 2 Plus **13**

Ultra 4 **21**

Ultra 4 Plus **21**

Ultra 6 **28**

Ultra 6 Plus **28**

side panel

NVX (Business Edition) **17**

NVX Pioneer **17**

Pro (Business Edition) **24**

Pro 2 **10**

Pro 4 **17**

Pro 6 **24**

Pro Pioneer **24**

Ultra 2 **10**

Ultra 2 Plus **10**

Ultra 4 **17**

Ultra 4 Plus **17**

Ultra 6 **24**

Ultra 6 Plus **24**

socket outlet **42**

status information **13**

NVX (Business Edition) **20**

NVX Pioneer **20**

Pro (Business Edition) **27**

Pro 4 **20**

Pro 6 **27**

Pro Pioneer **27**

Ultra 4 **20**

Ultra 4 Plus **20**

Ultra 6 **27**

Ultra 6 Plus **27**

supported disks **30**

system requirements **7**

system shutdown **13**

NVX (Business Edition) **21**

NVX Pioneer **21**

Pro (Business Edition) **28**

Pro 2 **13**

Pro 4 **21**

Pro 6 **28**

Pro Pioneer **28**

Ultra 2 **13**

Ultra 2 Plus **13**

Ultra 4 **21**

Ultra 4 Plus **21**

Ultra 6 **28**

Ultra 6 Plus **28**

system status

NVX (Business Edition) **20**

NVX Pioneer **20**

Pro (Business Edition) **27**

Pro 2 **13**

Pro 4 **20**

Pro 6 **27**

Pro Pioneer **27**

- Ultra 2 **13**
- Ultra 2 Plus **13**
- Ultra 4 **20**
- Ultra 4 Plus **20**
- Ultra 6 **27**
- Ultra 6 Plus **27**

T

- technical specifications **36, 38, 40**
- technical support **2**
- trademarks **2**
- troubleshooting with boot menu
 - NVX (Business Edition) **21**
 - NVX Pioneer **21**
 - Pro (Business Edition) **28**
 - Pro 2 **14**
 - Pro 4 **21**
 - Pro 6 **28**
 - Pro Pioneer **28**
 - Ultra 2 **14**
 - Ultra 2 Plus **14**
 - Ultra 4 **21**
 - Ultra 4 Plus **21**
 - Ultra 6 **28**
 - Ultra 6 Plus **28**

U

- unit location **6**

V

- volume synchronization **8, 32**