



LX770 / LH770
Digital Projector
User Manual

Copyright & Disclaimer

Copyright

Copyright 2017 by BenQ Corporation (Shanghai). All rights reserved. No part of this publication may be reproduced, transmitted, transcribed, stored in a retrieval system or translated into any language or computer language, in any form or by any means, electronic, mechanical, magnetic, optical, chemical, manual or otherwise, without the prior written permission of BenQ Corporation (Shanghai).

All other logos, products or company names mentioned in this manual may be the registered trademarks or copyrights of their respective companies, and are used for reference only.

Disclaimer

BenQ Corporation (Shanghai) makes no representations or warranties, either expressed or implied, with respect to the contents hereof and specifically disclaims any warranties, merchantability or fitness for any particular purpose. Further, BenQ Corporation (Shanghai) reserves the right to revise this publication and to make changes from time to time in the contents hereof without obligation to notify any person of such revision or changes.

This user manual strives its best to provide the latest and accurate information to consumers. Therefore, all contents are subject to change without notice. Please visit <http://www.benq.com> for the latest version of this manual.

Statement for hyper links and third-party websites

BenQ Corporation is not responsible for the content of the websites or of similar resources, which are maintained and controlled by third parties, that may be linked from this product. Providing links to those websites or to similar resources does not mean that BenQ Corporation makes any warranty or representation to their content by expression or by implication.

Any third party content or service preinstalled in this product is provided "as is". BenQ Corporation does not explicitly or implicitly guarantees contents or services provided by the third party. BenQ Corporation does not warrant or guarantee that the content or services provided by third parties are accurate, effective, most up-to-date, legal, or complete. Under no circumstances shall BenQ Corporation be liable for the content or services provided by third parties including their negligence. Services provided by third parties may be terminated temporarily or permanently. BenQ Corporation does not warrant or guarantee that the content or services provided by third parties are in good condition at any time, and is not liable for the termination of the said content and services. In addition, BenQ Corporation is not involved in any transactions you conduct in the websites or similar resources maintained by third parties. You should contact the content or service providers for any questions, concerns, or disputes.

Table of Contents

- Copyright & Disclaimer.....2**
 - Copyright..... 2
 - Disclaimer..... 2
 - Statement for hyper links and third-party websites..... 2

- Important safety instructions6**
 - Safety Instructions..... 6**
 - Laser statement..... 7**
 - Laser type.....7
 - Label indication..... 8
 - Laser indication 9
 - Heat radiation notice 9**

- Shipping contents.....11**
 - Standard accessories 11**
 - Optional accessories..... 11**

- Introduction.....12**
 - Projector exterior view..... 12**
 - Front/upper side.....12
 - Rear/upper side.....12
 - Controls and functions 13**
 - Control panel.....13
 - Control terminal.....14
 - Remote controller.....15

- Installation18**
 - Positioning your projector 18**
 - Choosing a location.....18
 - Evaluate the distance based on the image size..... 19**
 - Obtaining a preferred projected image size.....19
 - Projection dimensions.....19
 - Press the lens shift button for adjustment..... 21**
 - Adjust the location of vertical image.....21
 - Adjust the location of horizontal image21
 - Adjust the zoom/focus function22
 - Connection 23**
 - Before connection23
 - Connection with the AV device.....25
 - Connection with the computer.....25
 - Connection with LAN26

Operation.....	27
Starting up the projector	27
Adjusting the projected image	28
Adjusting the projection angle	28
Auto-adjusting the image.....	28
Fine-tuning the image size and clarity.....	28
Correcting 2D keystone.....	29
Adjusting corner fit	30
Using the menus.....	31
Securing the projector	32
Using a security cable lock.....	32
Utilizing the password function	32
Setting a password	32
If you forget the password	33
Entering the password recall procedure.....	33
Changing the password.....	33
Switching input signal.....	34
Changing Color Space.....	34
Selecting the aspect ratio	35
About the aspect ratio	36
Optimizing the image.....	37
Using Wall Color	37
Selecting a picture mode.....	37
Fine-tuning the image quality in user modes	38
Remote paging operations	41
Freezing the image	41
Hiding the image.....	41
Locking control keys	42
Operating in a high altitude environment.....	42
Adjusting the sound.....	42
Using Test Pattern	43
Using Quick Install.....	44
Control the projector via the wired LAN environment	44
Install the wired LAN setting	44
Remote control the projector via web browser	46
Shutting down the projector	48
Menu operations	49
Description of each menu	54
Maintenance	62
Prior to projector maintenance	62
Care of the projector	62

Clean the lens	62
Cleaning the projector case	62
Dust filter maintenance	63
Dust filter replacement	63
LED Indicator	65
System message.....	65
Light source error messages	65
Thermal error messages	66
Troubleshooting	67
Troubleshooting	67
The projector does not turn on.....	67
No picture	67
Blurred image.....	67
Remote control does not work	67
The password is incorrect	67
Specifications	68
Specifications	68
Dimensions	69
Ceiling mount installation	69
Appendix	70
Timing chart	70
Supported timing for PC/PC2 input	70
Supported timing for Component-YPbPr input.....	71
Supported timing for VIDEO/S-VIDEO input	72
Supported timing for HDMI/DVI-D (HDCP) input.....	72
Supporting timing for HDMI Video input.....	74
PJLink	75

Important safety instructions

Your projector is designed and tested to meet the latest standards for safety of information technology equipment. However, to ensure safe use of this product, it is important that you follow the instructions mentioned in this manual and marked on the product.

Safety Instructions

1. Do not look straight at the projector lens during operation. The intense light beam may damage your eyes.
2. Always open the lens shutter or remove the lens cap when the projector lamp is on.
3. In some countries, the line voltage is NOT stable. This projector is designed to operate safely within a mains voltage between 100 to 240 volts AC, but could fail if power cuts or surges of ± 10 volts occur. In areas where the mains voltage may fluctuate or cut out, it is recommended that you connect your projector through a power stabilizer, surge protector or uninterruptible power supply (UPS).
4. Do not block the projection lens with any objects when the projector is under operation as this could cause the objects to become heated and deformed or even cause a fire. Press **ECO BLANK** on the remote control to turn off the lamp temporarily.
5. Do not place this product on an unstable cart, stand, or table. The product may fall, sustaining serious damage.
6. Do not attempt to disassemble this projector. There are dangerous high voltages inside which may cause death if you should come into contact with live parts.
Under no circumstances should you ever undo or remove any other covers. Refer servicing only to suitably qualified professional service personnel.
7. Do not place this projector in any of the following environments.
 - Space that is poorly ventilated or confined. Allow at least 50 cm clearance from walls and free flow of air around the projector.
 - Locations where temperatures may become excessively high, such as the inside of a car with all windows rolled up.
 - Locations where excessive humidity, dust, or cigarette smoke may contaminate optical components, shortening the projector's life span and darkening the image.
 - Locations near fire alarms
 - Locations with an ambient temperature above 40°C / 104°F
 - Locations where the altitudes are higher than 5000 m (16400 feet).
8. Do not block the ventilation holes.
 - Do not place this projector on a blanket, bedding or any other soft surface.
 - Do not cover this projector with a cloth or any other item.
 - Do not place inflammables near the projector.

If the ventilation holes are seriously obstructed, overheating inside the projector may result in a fire.

9. Do not step on the projector or place any objects upon it. Besides probable physical damage to the projector, doing so may result in accidents and possible injury.
10. Do not place liquids near or on the projector. Liquids spilled into the projector may cause it to fail. If the projector does become wet, disconnect it from the power supply's wall socket and call BenQ to have the projector serviced.

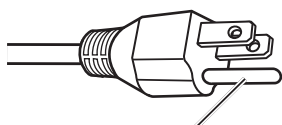

Do not remove it.

This device comes with the three-pin power plug with earth contact. Do not remove the earth contact pin. As a safety function, this power plug may only be inserted into the power socket with earth wire. Contact the electrician if the plug cannot be inserted into the power socket.

Laser statement



This symbol indicates that laser radiation might hurt your eyes if not strictly following the instructions.

Laser type



This laser product is identified as Class 1 for all operating procedures.

Caution: Carrying out the control, adjustment or procedure not specified in this document may cause dangerous radiation.

Label indication

The following diagram shows label locations.

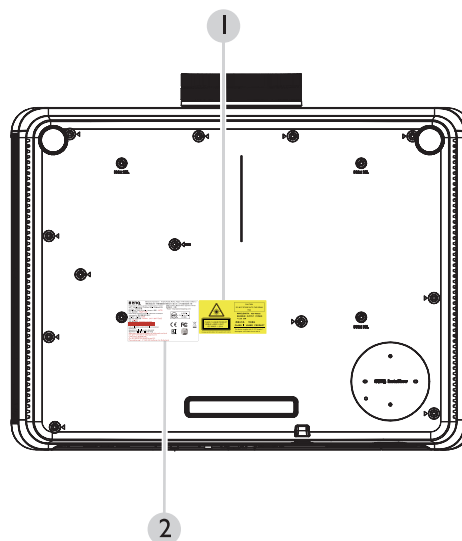
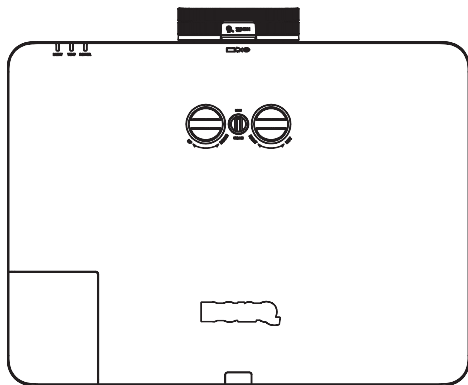

1. Laser warning label

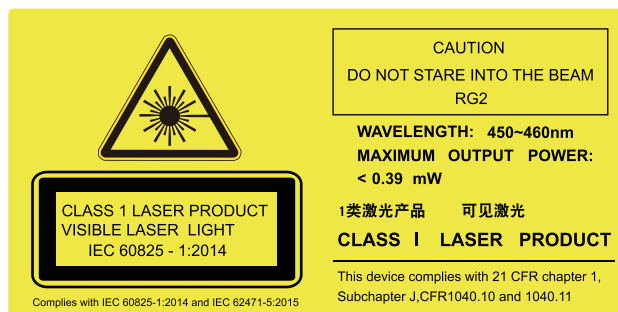

2. Specification label



Note:

Specification labels may vary due to different delivery regions. Consult the dealer for details.



Laser indication

The following diagram shows the location of laser aperture. Be aware that you must not look straight at the laser.

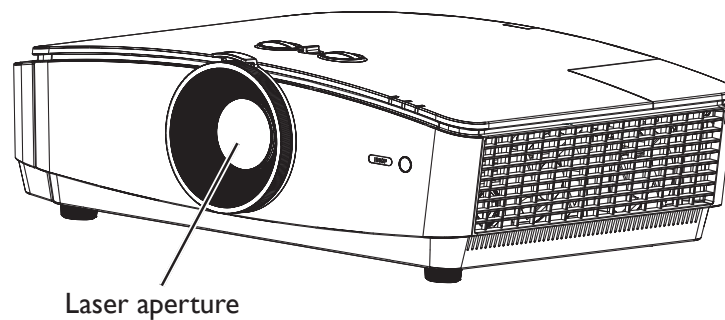

Heat radiation notice

Leave a space at least 500 mm (19.7 in.) around the air outlet. Make sure that no object blocks the ventilation within 300 mm (11.8 in.).

Keep the air vent at least 1 m away from the air inlet of other projectors.

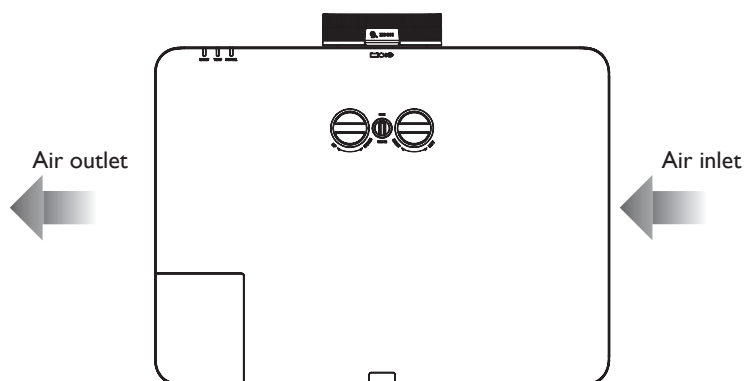

- Leave a space at least 50 cm around the air outlet.

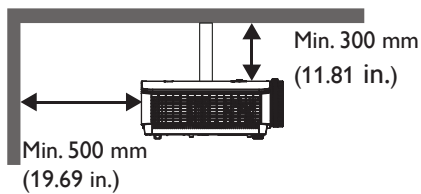
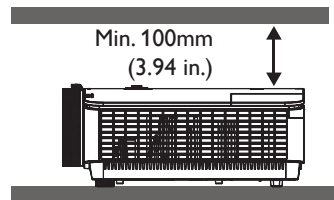
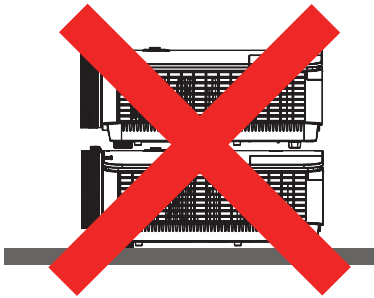
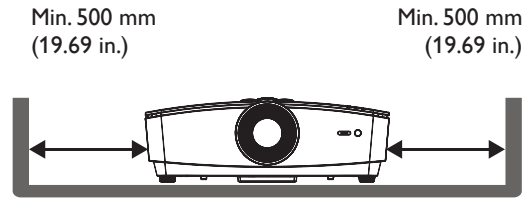
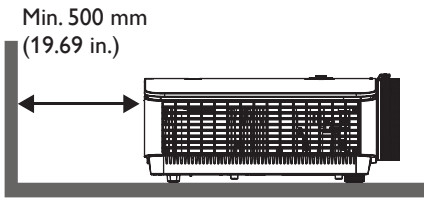

- Make sure that the air inlet would not suck in the hot air from the air outlet.
- When using this product in a confined space, make sure that the temperature of the air near this space does not exceed the operating temperature of the projector in operation. Also, make sure that the air inlet and air outlet are not blocked.
- All chassis have passed a certified thermal evaluation. It is assured that the projector does not reuse the waste gas, otherwise the projector would shutdown, even if the ambient temperature is within the acceptable operating range.

Shipping contents

Standard accessories

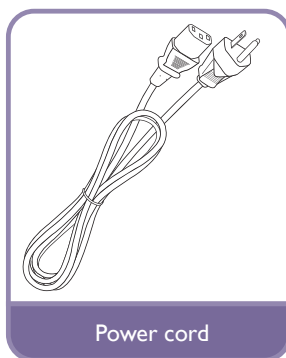
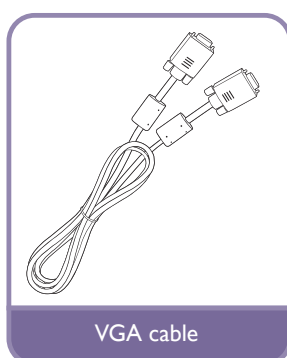
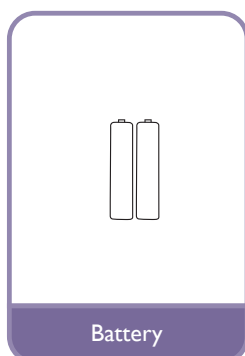

Optional accessories

1. Ceiling mount kit
2. 3D glasses
3. Wireless dongle: QCast (QP01), InstaShow™ (WDC10)

*The warranty card is only supplied in some specific regions. Please consult your dealer for detailed information.

Introduction

Projector exterior view

Front/upper side

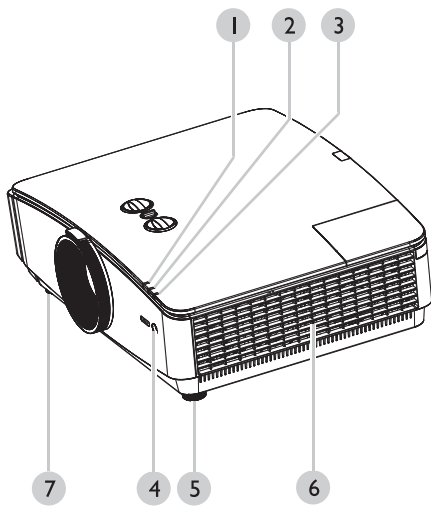

1. POWER indicator light
2. TEMP (temperature) warning light
3. LAMP indicator light
4. Front IR remote sensor
5. Front adjuster foot
6. Side ventilation hole
7. Front adjuster foot

Rear/upper side

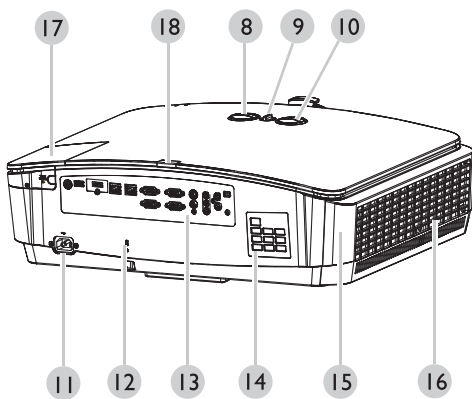

8. Vertical lens knob
9. Lens lock knob
10. Horizontal lens knob
11. AC power cord inlet
12. Kensington anti-theft lock slot
13. Control terminal
14. Control panel
15. Dust cap (air inlet area)
16. Ventilation hole (sucking cool air)
17. HDMI2/MHL
18. Rear IR remote sensor

Controls and functions

Control panel

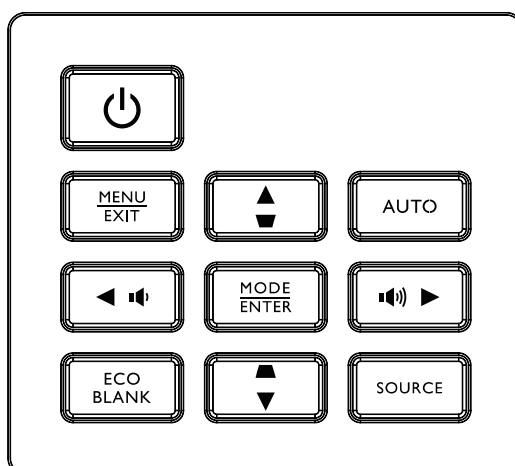

- **MENU/EXIT**
Turns on the On-Screen Display (OSD) menu. Goes back to previous OSD menu, exits and saves menu settings. See [“Using the menus” on page 31](#) for details.
- **Volume/Arrow keys (/ Left)**
Turns down the volume.
- **SOURCE**
Displays the source selection bar.
- **MODE/ENTER**
Selects an available picture setup mode.
Activates the selected On-Screen Display (OSD) menu item. See [“Using the menus” on page 31](#) for details.
- **Keystone/Arrow keys (/ Down)**
Manually corrects distorted images resulting from an angled projection. See [“Correcting 2D keystone” on page 29](#) for details.
- **AUTO**
Automatically determines the best picture timings for the displayed image. See [“Auto-adjusting the image” on page 28](#) for details.
- **Volume/Arrow keys (/ Right)**
Turns up the volume.
- **POWER**
Toggles the projector between standby mode and on. See [“Starting up the projector” on page 27](#) and [“Shutting down the projector” on page 48](#) for details.
- **Keystone/Arrow keys (/ Up)**
When the On-Screen Display (OSD) menu is activated, the , , and keys are used as directional arrows to select the desired menu items and to make adjustments. See [“Using the menus” on page 31](#) for details.
- **ECO BLANK**
Used to hide the screen picture. See [“Hiding the image” on page 41](#) for details.

Control terminal

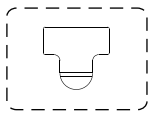

HDMI 2
MHL

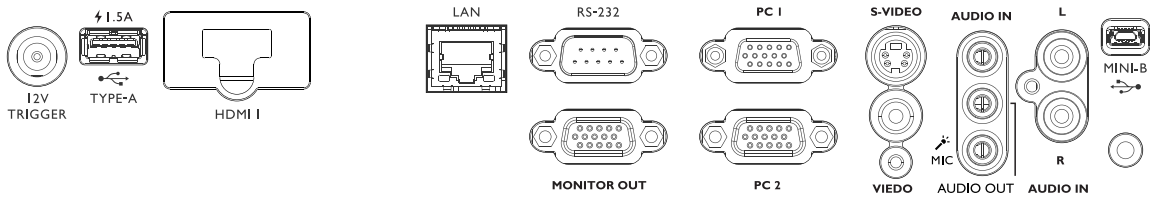

- **MONITOR OUT**
Connects to other display devices used for simultaneous playback and display.
- **PC 1/PC 2**
This indicates the RGB or YPbPr/YCbCr output signal.
- **S-VIDEO**
Connecting S-Video source.
- **HDMI 1**
Connecting HDMI source.
- **HDMI 2/MHL**
Connecting HDMI or MHL source.
- **LAN**
Connecting to RJ45 Cat5/Cat6 Ethernet cable to control the projector via Internet.
- **USB 1.5A**
Supporting 5V/1.5A output.
- **VIDEO**
Connecting Video source.
- **Mini-B**
This is the port for maintenance only. Only authorized maintenance personnel are allowed to use this port.
- **RS-232**
This is a standard 9-pin D-sub connector. It is used for connecting to the PC to control the system and maintain the projector.
- **AUDIO IN (L/R)**
Connecting to the audio input source via the audio cable or audio L/R cable.
- **AUDIO OUT**
Connecting to the loudspeaker or earphone.
- **AUDIO IN**
Connecting to the audio input source via the audio cable.
- **12V TRIGGER**
This is the 12V trigger outlet. It is used to trigger external devices such as the electric screen. Consult your dealer for the way to connect to these devices.

Remote controller

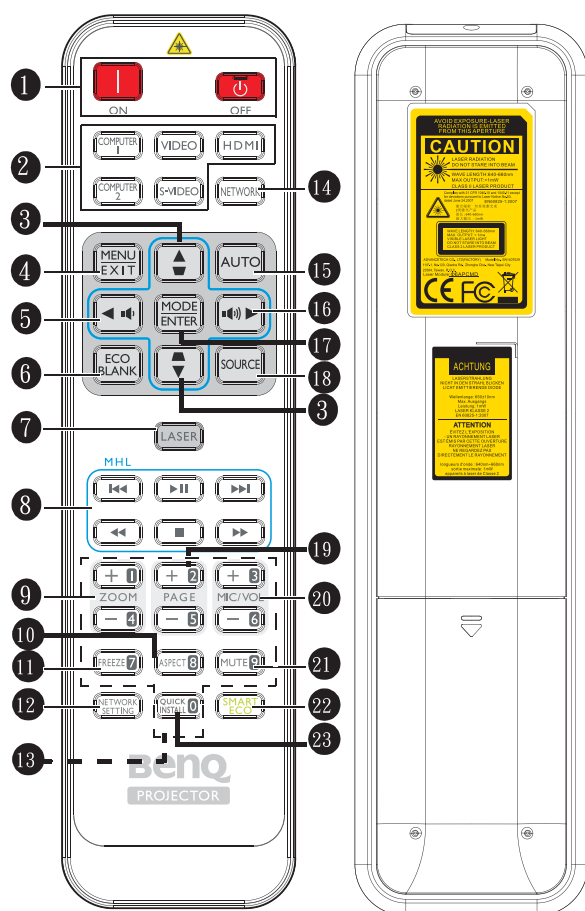

1. **ON/OFF**
Toggles the projector between standby mode and on.
2. **Source selection button**
Select the input source displayed.
3. **Keystone/Arrow keys (▼ / ▲ Up, ▲ / ▼ Down)**
Manually corrects distorted images resulting from an angled projection.
4. **MENU/EXIT**
Turns on the On-Screen Display (OSD) menu. Goes back to previous OSD menu, exits and saves menu settings.
5. **◀ Left/ 🔊**
Turn down the projector volume.
6. **ECO BLANK**
Used to hide the screen picture.

7. LASER

Emits visible laser pointer light for presentation purposes.

8. MHL control buttons

These buttons are used when playing the media. Their functions are listed by order: Go to the previous document/Play/Pause/Go to the next document/Fast rewind/Stop/Fast forward.

These buttons can only be used when controlling the intelligent device in MHL mode.

9. ZOOM+/ZOOM-

Magnifies or reduces the projected picture size.

10. ASPECT

Selects the display aspect ratio.

11. FREEZE

Freezes the projected image.

12. NETWORK SETTING

Displays **Network Settings** menu.

13. Number keys

Enter numbers in Network Settings.

☞ **Don't press the numeric buttons 1, 2, 3 and 4 when being asked to enter the password.**

14. NETWORK

It is not available in this projector.

15. AUTO

Automatically determines the best picture timings for the displayed image.

If no OSD menu is available and you're in the MHL signal source mode, long-press this button for 3 seconds to switch between the MHL and DLP modes on the MHL key of remote control.

16. ► Right/ 

Turn up the projector volume.

When the On-Screen Display (OSD) menu is activated, the #3, #5 and #16 keys are used as directional arrows to select the desired menu items and to make adjustments.

In the MHL mode, use #3, #5 and #16 as arrow keys. Use #4 for MENU/EXIT and #17 for MODE/ENTER.

17. MODE/ENTER

Selects an available picture setup mode.

Activates the selected On-Screen Display (OSD) menu item.

18. SOURCE

Displays the source selection bar.

19. PAGE +/PAGE-

You can operate your display software program (on a connected PC) which responds to page up/down commands (like Microsoft PowerPoint) by pressing PAGE +/- on the remote control.

20. MIC/VOL +/MIC/VOL -

Adjusts the microphone's sound level.

21. MUTE

Toggles projector audio between on and off.

22. SMART ECO

Switches the light source mode.

23. QUICK INSTALL

Displays the **Quick Install** menu.

 **When the projector is in the MHL mode, the function of the keypad on the projector shall be the same as the key on the remote control.**

Use the remote control to manipulate the intelligent device

When the projector projects an image from the MHL-compatible intelligent device, you can use the remote control to control the intelligent device.

To enter the MHL mode, press **AUTO** for 3 seconds. Use the following buttons to control the intelligent device: Arrow keys (**▼ / ▲ Up**, **▲ / ▼ Down**, **◀ Left**, **▶ Right**), **MENU/EXIT** and the **MHL** control button.

To exit the MHL mode, press **AUTO** for 3 seconds.

Operating the laser pointer

The Laser Pointer is a presentation aid for professionals. It emits red colored light when you press it and the indicator lights up red.

The laser beam is visible. It is necessary to press and hold LASER for continuous output.

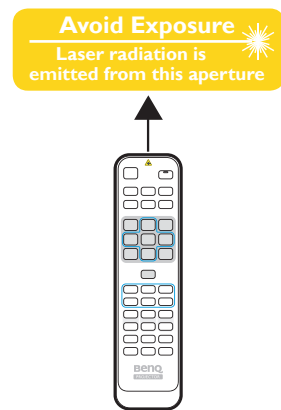

Do not look into the laser light window or shine the laser light beam on yourself or others. See the warning messages on the back of the remote control prior to using it.

The laser pointer is not a toy. Parents should be mindful of the dangers of laser energy and keep this remote control out of the reach of children.

Effective range of remote control

Infra-Red (IR) remote control sensors are located on the front and rear of the projector. The remote control must be held at an angle within 30 degrees perpendicular to the projector's IR remote control sensor to function correctly. The distance between the remote control and the sensor should not exceed 8 meters (~ 26 feet).

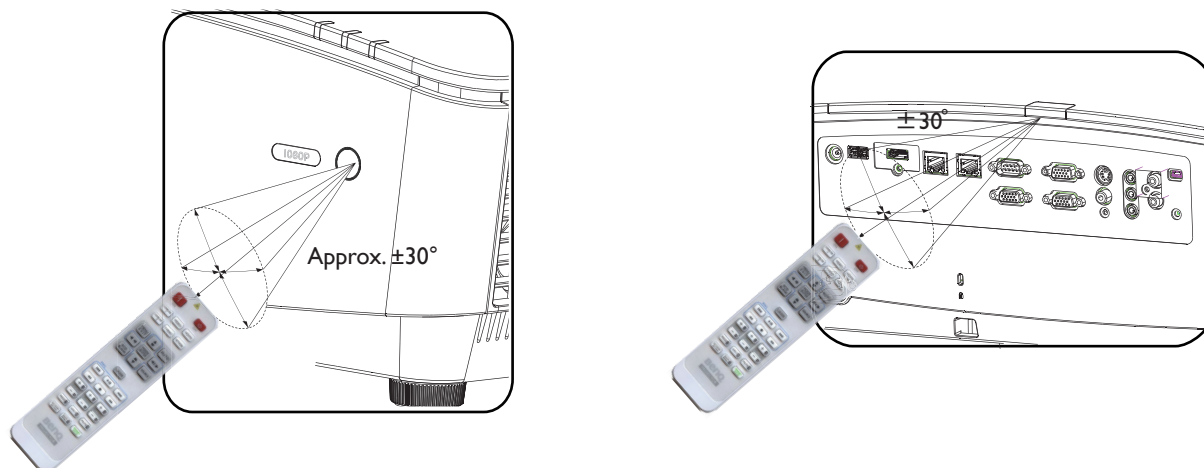

Replacing the remote control battery

1. To open the battery cover, turn the remote control over to view its back, push on the finger grip on the cover and slide it up in the direction of the arrow as illustrated. The cover will slide off.
2. Remove any existing batteries (if necessary) and install two AAA batteries observing the battery polarities as indicated in the base of the battery compartment. Positive (+) goes to positive and negative (-) goes to negative.
3. Refit the cover by aligning it with the base and sliding it back down into position. Stop when it clicks into place.

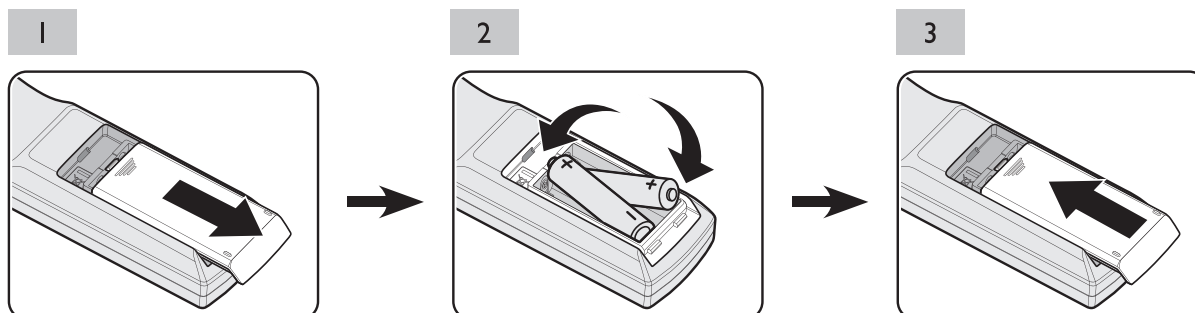

Caution:

- Avoid excessive heat and humidity.
- There may be battery damage if the battery is incorrectly replaced.
- Replace only with the same or equivalent type recommended by the battery manufacturer.
- Dispose of the used battery according to the battery manufacturer's instructions.
- Never throw a battery into a fire. There may be danger of an explosion.
- If the battery is dead or if you will not be using the remote control for a long time, remove the battery to prevent damage to the remote control from possible battery leakage.

Installation

Positioning your projector

Choosing a location

Your projector is designed to be installed in one of four possible installation locations:

1. Front Table

Select this location with the projector placed near the floor in front of the screen. This is the most common way to position the projector for quick setup and portability.

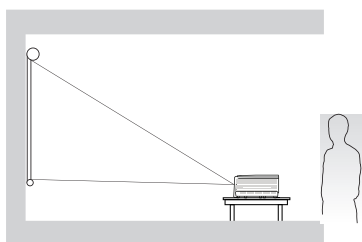

2. Rear Table

Select this location with the projector placed near the floor behind the screen.

Note that a special rear projection screen is required.

* Set **Rear Table** in the **SYSTEM SETUP: Basic > Projector Installation** menu after you turn the projector on.

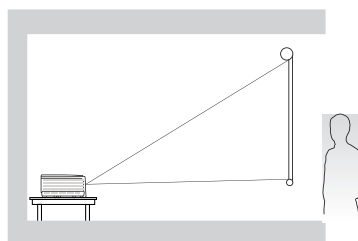

3. Front Ceiling

Select this location with the projector suspended upside-down from the ceiling in front of the screen.

Purchase the BenQ Projector Ceiling Mounting Kit from your dealer to mount your projector on the ceiling.

* Set **Front Ceiling** in the **SYSTEM SETUP: Basic > Projector Installation** menu after you turn the projector on.

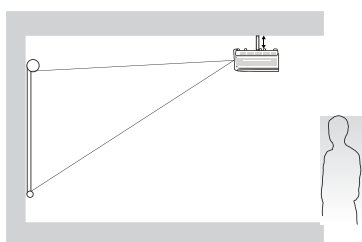

4. Rear Ceiling

Select this location with the projector suspended upside-down from the ceiling behind the screen.

Note that a special rear projection screen and the BenQ Projector Ceiling Mounting Kit are required for this installation location.

* Set **Rear Ceiling** in the **SYSTEM SETUP: Basic > Projector Installation** menu after you turn the projector on.

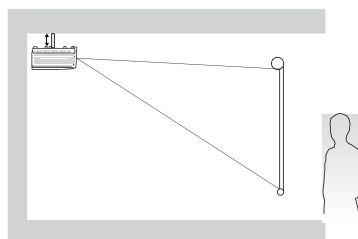

Your room layout or personal preference will dictate which installation location you select. Take into consideration the size and position of your screen, the location of a suitable power outlet, as well as the location and distance between the projector and the rest of your equipment.

Evaluate the distance based on the image size

Obtaining a preferred projected image size

The distance from the projector lens to the screen, the zoom setting (if available), and the video format each factors in the projected image size.

Projection dimensions

Refer to “Dimensions” on page 69 for the center of lens dimensions of this projector before calculating the appropriate position.

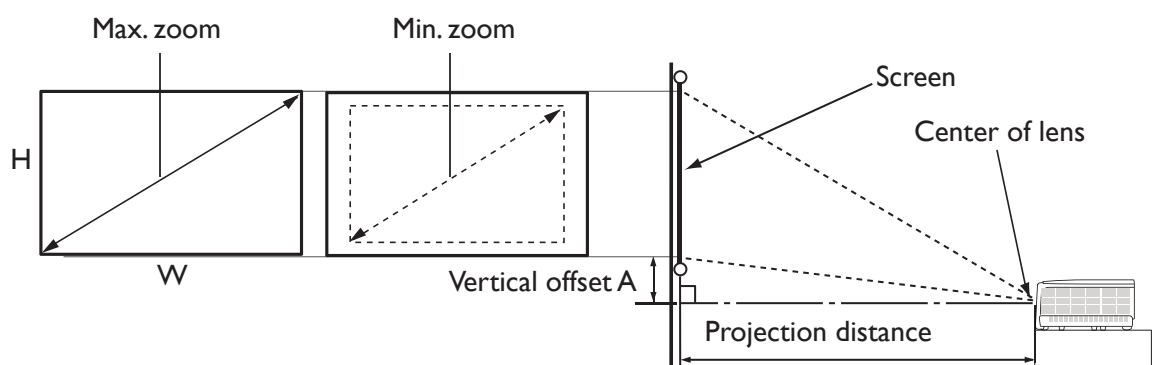

LX770

The screen aspect ratio is 4:3 and the projected picture is 4:3

Screen size				Distance from screen (mm)			Offset (mm)
Diagonal		H (mm)	W (mm)	Min distance	Average	Max distance	
Inch	mm			(max. zoom)		(min. zoom)	
30	762	475	610	1084	1384	1683	112
40	1016	610	813	1463	1862	2261	149
50	1270	762	1016	1841	2340	2838	187
60	1524	914	1219	2220	2818	3416	224
80	2032	1219	1626	2977	3774	4571	299
100	2540	1524	2032	3734	4730	5725	373
120	3048	1829	2438	4491	5686	6880	448
140	3556	2134	2845	5248	6641	8035	523
160	4064	2438	3251	6005	7597	9190	597
180	4572	2743	3658	6762	8553	10345	672
200	5080	3048	4064	7519	9509	11500	747
220	5588	3353	4470	8276	10465	12655	821
250	6350	3810	5080	9411	11899	14387	933
300	7620	4572	6096	11304	14289	17274	1120

LH770

The screen aspect ratio is 16:9 and the projected picture is 16:9

Screen size			Distance from screen (mm)			Offset (mm)	
Diagonal		H (mm)	W (mm)	Min distance	Average		Max distance
Inch	mm			(max. zoom)			(min. zoom)
30	762	374	664	891	1140	1389	96
40	1016	498	886	1205	1537	1869	128
50	1270	623	1107	1520	1934	2348	160
60	1524	747	1328	1834	2331	2828	192
80	2032	996	1771	2463	3125	3787	256
100	2540	1245	2241	3092	3919	4746	320
120	3048	1494	2657	3721	4713	5704	384
140	3556	1743	3099	4350	5507	6663	448
160	4064	1992	3542	4979	6301	7622	512
180	4572	2241	3985	5608	7095	8581	576
200	5080	2491	4428	6237	7889	9540	640
220	5588	2740	4870	6866	8682	10499	704
250	6350	3113	5535	7809	9873	11937	800
300	7620	3736	6641	9382	11858	14335	960

 **Note:**

A 5-percent tolerance exists between these numbers due to the difference among optical components. BenQ recommends that if you intend to permanently install the projector, you should physically test the projection size and distance using the actual projector in situ before you permanently install it, so as to make allowance for this projector's optical characteristics. This will help you determine the exact mounting position so that it best suits your installation location. To optimize the projection quality, we suggest to project images in an area without grayscale.

Press the lens shift button for adjustment

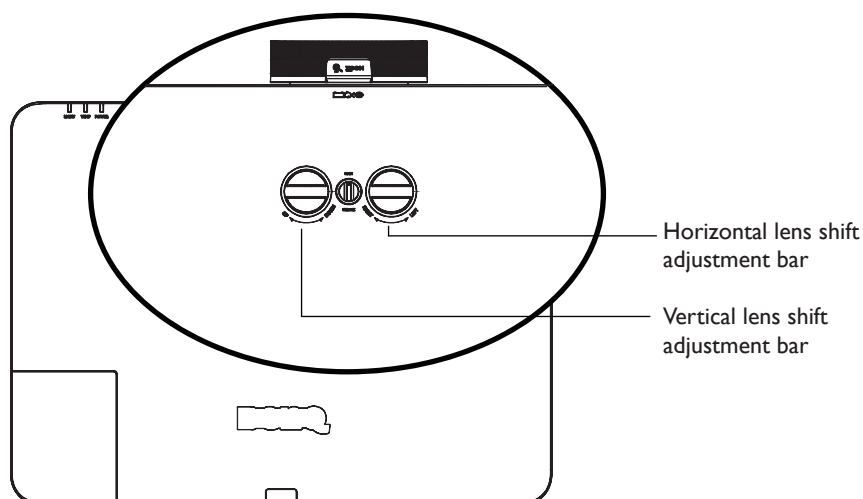

You can use the lens shift function to adjust the location of projected image horizontally or vertically in the range described below.

Adjust the location of vertical image

You can adjust the height of vertical image between the shift locations 124.5% \pm 7.8% (XGA), 125.7% \pm 7.9% (1080P).

Adjust the location of horizontal image

You can adjust the height of horizontal image between the shift locations 0% \pm 6.3% (XGA), 0% \pm 4.8% (1080P).

 **Note:** A 3-percent tolerance exists for the lens shift.

Adjust the zoom/focus function

You can turn the zoom gear for zoom-in and zoom-out. You can turn the focus gear to focus on an image until the image becomes clear. The projector will focus on an image in a certain distance. Refer to “[Fine-tuning the image size and clarity](#)” on page 28.

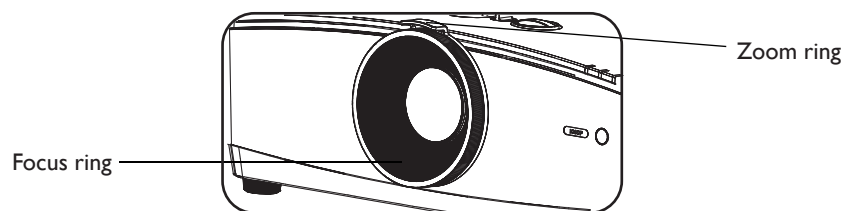

Connection

Before connection

- Please read the manual for connection to external devices carefully before connection.
- Shut down the power supply of all devices before connecting the cable.
- Bear the following in mind before connecting the cable. A breakdown might occur if not following these rules.
 - Please touch metal objects nearby to release static electricity before connecting the cable to the projector or device linking to the projector.
 - Do not use any over-length cable to connect to the projector or use it to connect the device to the projector. A long cable would operate like an antenna. It is more likely to be interfered by noise.
 - When connecting a cable, connect the GND (earth) part first and then insert the connector linking to the device.
- Get a connecting cable not provided by the supplier to connect the external device to the system.
- If there is too much jitter in the video signal, the image on the screen shakes. Therefore, you must connect the time base corrector (TBC).
- If the synchronous signal output in the computer or video device is cut off due to the change of the video output setting or other reasons, the color of projected image would be distorted for a short time.
- The projector receives the video signal, Y/C signal, YCBCR/YPBPR signal, simulated RGB signal (TTL level for synchronous signal) and numeric signal.
- Some computer models are not compatible with the projector.
- Use the cable compensator when using the long cable to connect the device to the projector. The image might not be displayed properly if not using the cable compensator.

PC

No.	Serial
1	P/PR
2	G/Y
3	B/PB
4	-
5	GND
6	GND
7	GND
8	GND

No.	Serial
9	-
10	GND
11	GND
12	DDC data
13	SYNC/HD
14	VD
15	DDC clock

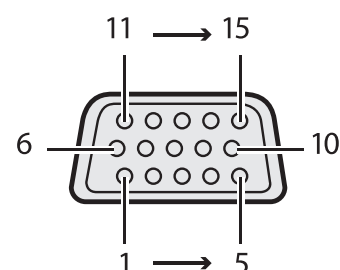

HDMI 1

No.	Serial
1	TMDS Data2+
2	TMDS Data2 Shield
3	TMDS Data2-
4	TMDS Data1+
5	TMDS Data1 Shield
6	TMDS Data1-
7	TMDS Data0+
8	TMDS Data0 Shield
9	TMDS Data0-
10	TMDS Clock+

No.	Serial
11	TMDS Clock Shield
12	TMDS Clock-
13	CEC
14	Reserved (no pin)
15	SCL
16	SDA
17	DDC/CEC Ground
18	+5V power supply (50 mA max.)
19	Hot-swap test

2 to 18 (even number of pins)

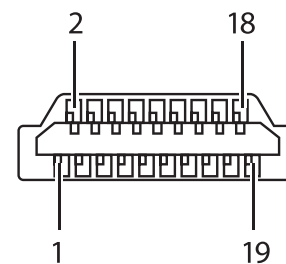

1 to 19 (odd number of pins)

Connection with the AV device

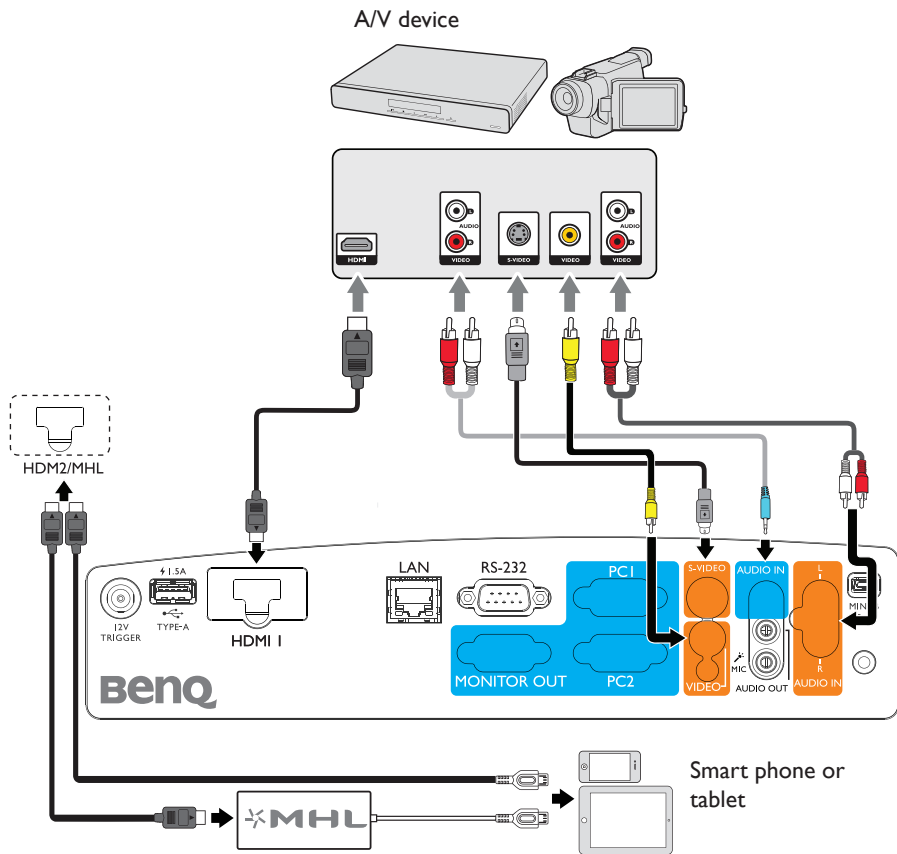

Connection with the computer

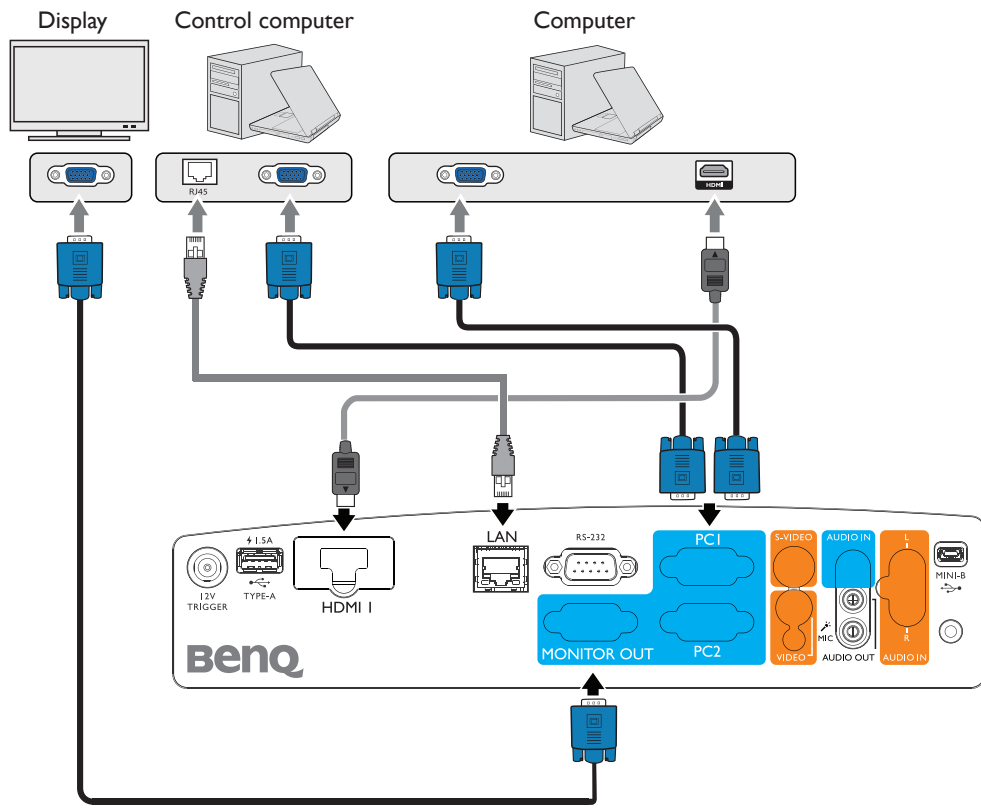

Connection with LAN

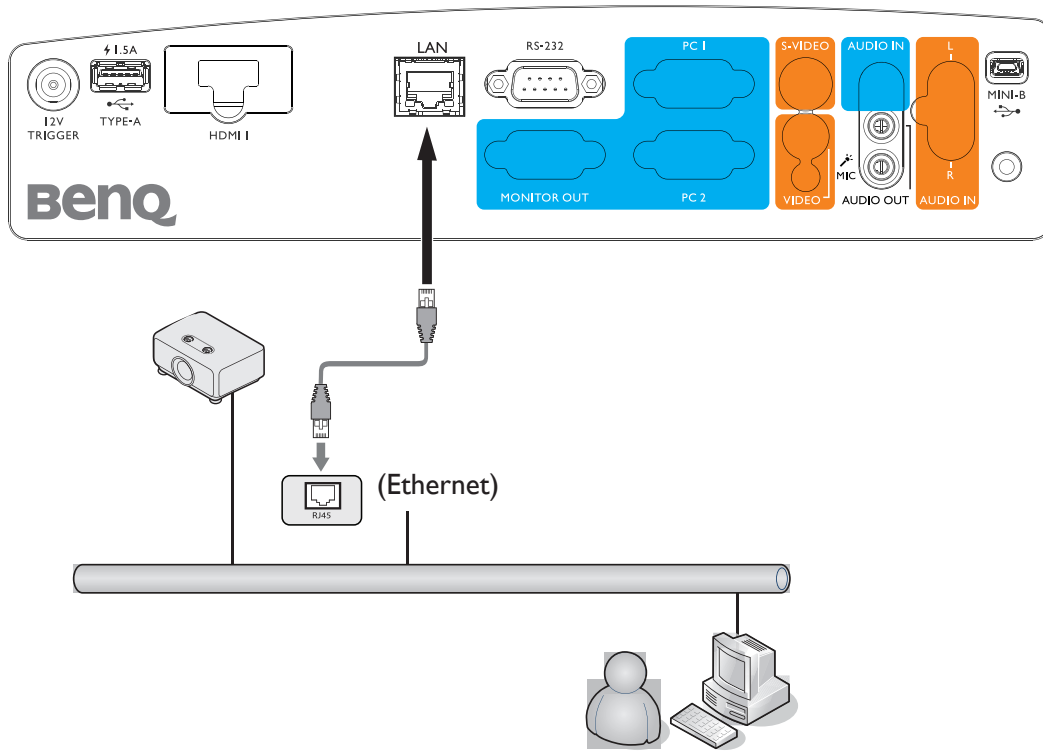



Operation

Starting up the projector

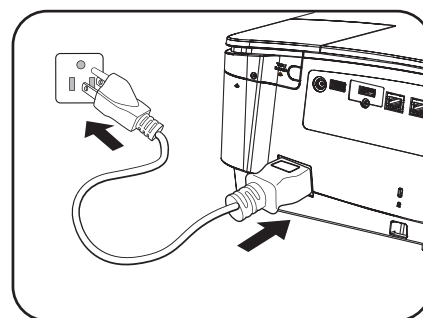
1. Plug the power cord into the projector and into a power outlet. Turn on the power outlet switch (where fitted). Check that the **POWER indicator light** on the projector lights orange after power has been applied.



 **Please use the original accessories (e.g. power cable) only with the device to avoid possible dangers such as electric shock and fire.**

2. Press **POWER**  on the projector or  on the remote control to turn on the projector. Now you will hear the start sound. The **POWER indicator light** flashes and stays green when the projector is on. The start up procedure takes about 30 seconds. In the later stage of start up, a startup logo is projected.

(If necessary) Rotate the focus ring to adjust the image clearness.

To turn off the ring tone, refer to “[Power On/Off Ring Tone](#)” on page 43 for details.

3. To use the OSD menus, please set them to your familiar language first.



4. If you are prompted for a password, press the arrow keys to enter a six digit password. See “[Utilizing the password function](#)” on page 32 for details.
5. Switch all of the connected equipment on.
6. The projector will start to search for input signals. The current input signal being scanned displays in the upper left corner of the screen. If the projector doesn't detect a valid signal, the message “**No Signal**” will continue displaying until an input signal is found. You can also press **SOURCE** on the projector or remote control to select your desired input signal. See “[Switching input signal](#)” on page 34 for details.

 **If the frequency/resolution of the input signal exceeds the projector's operating range, you will see the message “Out of Range” displayed on a blank screen. Please change to an input signal which is compatible with the projector's resolution or set the input signal to a lower setting. See “[Timing chart](#)” on page 70 for details.**

Adjusting the projected image

Adjusting the projection angle

The projector is equipped with 2 front adjuster feet. These adjusters change the image height and projection angle.

To adjust the projector:

1. Adjust the foot before turning the projector to ensure that the image is at the position you prefer.
2. To retract the foot, screw the front and rear adjuster feet in a reverse direction.

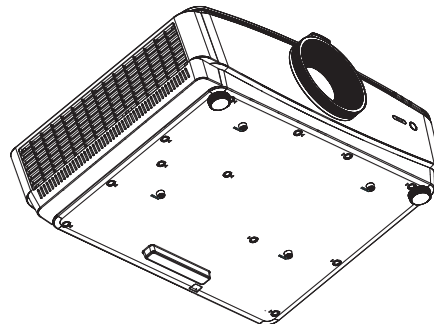

If the projector is not placed on a flat surface or the screen and the projector are not perpendicular to each other, the projected image becomes trapezoidal. To correct this situation, see [“Correcting 2D keystone” on page 29](#) for details.



- **Do not look into the lens while the lamp is on. The strong light from the lamp may cause damage to your eyes.**
- **Be careful when you press the adjuster button as it is close to the exhaust vent where hot air comes from.**

Auto-adjusting the image

In some cases, you may need to optimize the picture quality. To do this, press **AUTO** on the projector or remote control.

Within 3 seconds, the built-in Intelligent Auto Adjustment function will re-adjust the values of Frequency and Clock to provide the best picture quality.

The current source information will be displayed in the upper left corner of the screen for 3 seconds.



- **The screen will be blank while Auto is functioning.**
- **This function is only available when PC signal (analog RGB) is selected.**

Fine-tuning the image size and clarity

1. Adjust the projected image to the size that you need using the zoom ring.

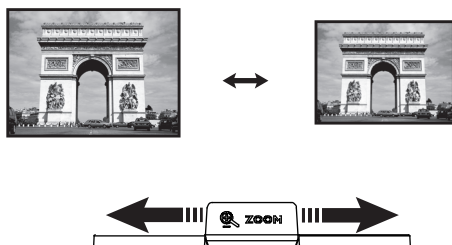

2. Then sharpen the image by rotating the focus ring.

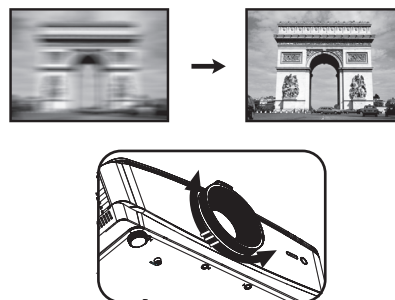

Correcting 2D keystone

2D Keystone function enables a wider projector installation area compared to conventional projectors with limited positioning in front of the screen.

To correct this, you will need to manually correct it following one of these steps.

- Using the projector or remote control

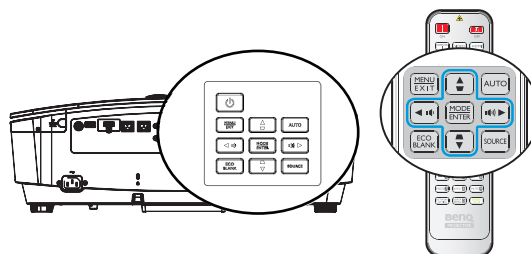

Press ▲ / ▼ to display the 2D Keystone page.

Press ▲/▼ to adjust vertical values from -30 to 30. Press ◀/▶ to adjust horizontal values from -30 to 30.

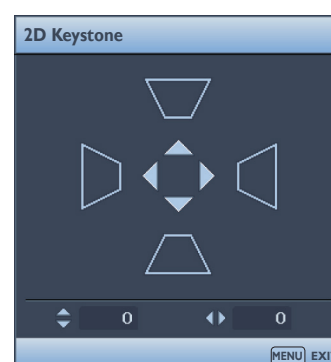

- Using the menus

1. Press **MENU/EXIT** and then press ◀/▶ until the **DISPLAY** menu is highlighted.
2. Press ▼ to highlight **2D Keystone** and press **MODE/ENTER**. The **2D Keystone** page displays.
3. Press ▲, ▼, ◀, ▶ to adjust the keystone values.



- Using **QUICK INSTALL** key

1. Press **QUICK INSTALL** on the remote control.

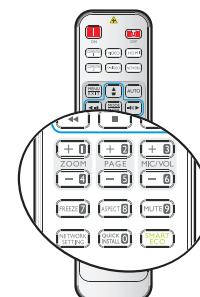

2. Press ▼ to highlight **2D Keystone** and press **MODE/ENTER**. The **2D Keystone** page displays.
3. Press ▲, ▼, ◀, ▶ to adjust the keystone values.

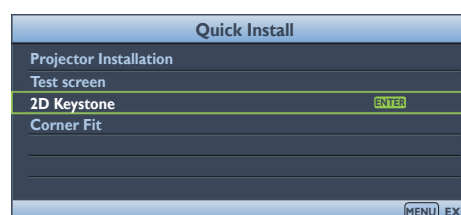

Adjusting corner fit

Manually adjust four corners of the image by setting the horizontal and vertical values.

- Using the OSD menu

1. Press **MENU/EXIT** and then press **◀/▶** until the **DISPLAY** menu is highlighted.
2. Press **▼** to highlight **Corner Fit** and press **MODE/ENTER**. The **Corner Fit** page displays.
3. Press **▲, ▼, ◀, ▶** to select one of the four corners and press **MODE/ENTER**.
4. Press **▲/▼** to adjust vertical values from 0 to 60.
5. Press **◀/▶** to adjust horizontal values from 0 to 60.

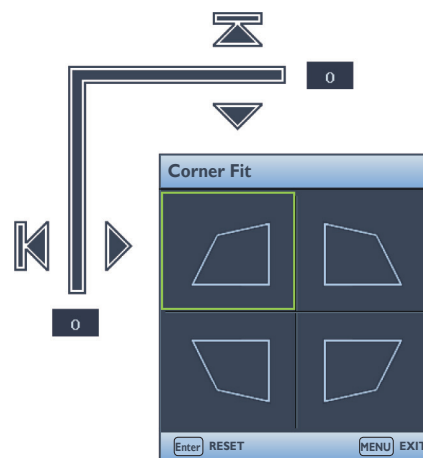
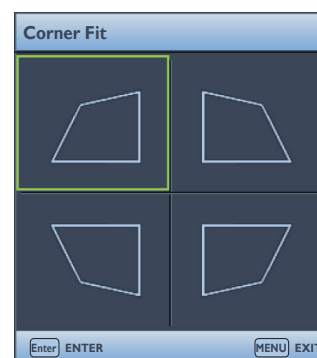

Using the menus

The projector is equipped with On-Screen Display (OSD) menus for making various adjustments and settings.

Below is the overview of the OSD menu.

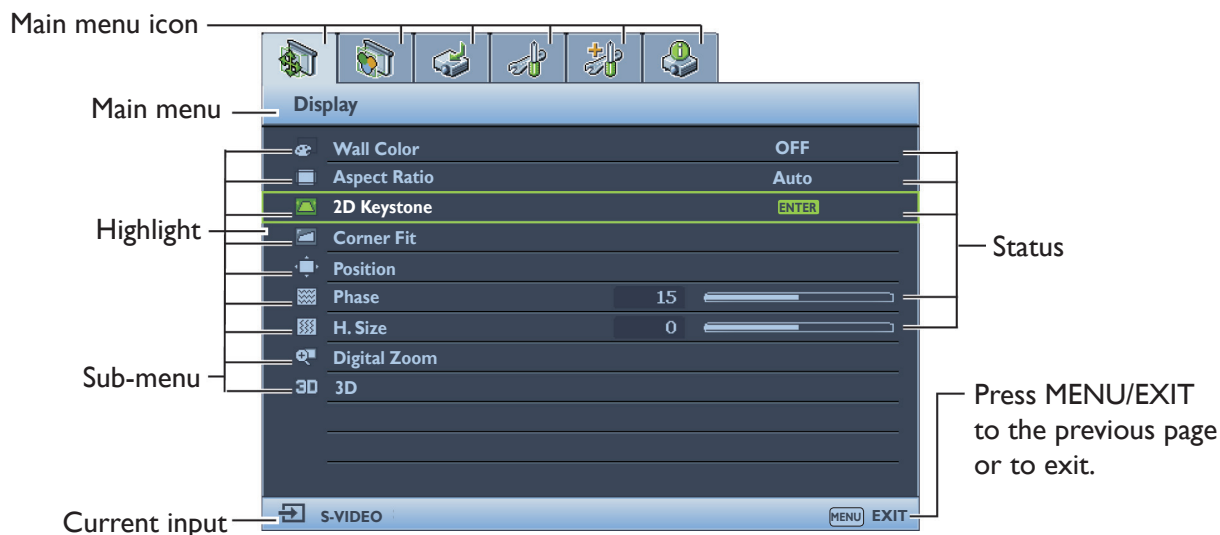

To use the OSD menus, please set them to your familiar language first.

1. Press **MODE/ENTER** on the projector or remote control to turn the OSD menu on.



3. Press **▼** to highlight **Language** and press **◀/▶** to select a preferred language.

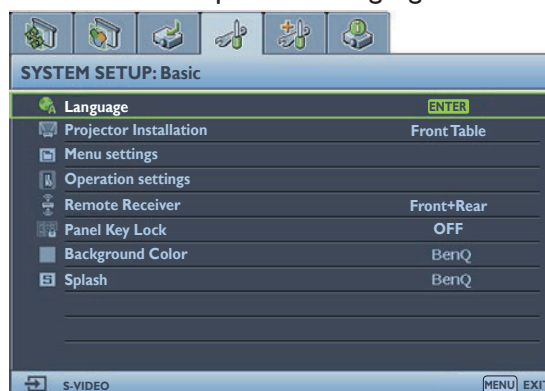

2. Use **◀/▶** to highlight the **SYSTEM SETUP: Basic** menu.



Securing the projector

Using a security cable lock

The projector has to be installed in a safe place to prevent theft. Otherwise, purchase a lock, such as the Kensington lock, to secure the projector. You can locate a Kensington lock slot on the left side of the projector.

A Kensington security cable lock is usually a combination of key(s) and the lock. Refer to the lock's documentation for finding out how to use it.

Utilizing the password function

For security purposes and to help prevent unauthorized use, the projector includes an option for setting up password security. The password can be set through the On-Screen Display (OSD) menu.

WARNING: You will be inconvenienced if you activate the power-on lock functionality and subsequently forget the password. Print out this manual (if necessary) and write the password you used in this manual, and keep the manual in a safe place for later recall.

Setting a password

Once a password has been set, the projector cannot be used unless the correct password is entered every time the projector is started.

1. Open the OSD menu and go to the **SYSTEM SETUP:Advanced > Security Settings** menu. Press **MODE/ENTER**. The **Security Settings** page displays.
2. Highlight **Change Security Settings** and press **MODE/ENTER**.
3. As pictured to the right, the four arrow keys (**▲**, **▼**, **◀**, **▶**) respectively represent 4 digits (1, 2, 3, 4). According to the password you desire to set, press the arrow keys to enter six digits for the password.
4. Please enter the new password again to validate it. Once the password is set, the OSD menu returns to the **Security Settings** page.
5. To activate **Power on lock**, press **▲/▼** to highlight **Power on lock** and press **◀/▶** to select **On**.

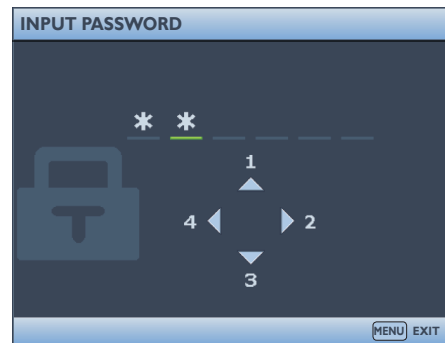

The digits being input will display as asterisks on-screen. Write your selected password down here in this manual in advance or right after the password is entered so that it is available to you should you ever forget it.

Password: _ _ _ _ _

Keep this manual in a safe place.

6. To leave the OSD menu, press **MENU/EXIT**.

If you forget the password

If the password function is activated, you will be asked to enter the six-digit password every time you turn on the projector. If you enter the wrong password, the password error message as pictured to the right displays lasting for three seconds, and the message **'INPUT PASSWORD'** follows. You can retry by entering another six-digit password, or if you did not record the password in this manual, and you absolutely do not remember it, you can use the password recall procedure. See [“Entering the password recall procedure” on page 33](#) for details.

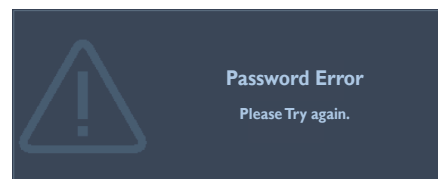

If you enter an incorrect password 5 times in succession, the projector will automatically shut down in a short time.

Entering the password recall procedure

1. Press and hold **AUTO** on the projector or remote control for 3 seconds. The projector will display a coded number on the screen.
2. Write down the number and turn off your projector.
3. Seek help from the local BenQ service center to decode the number. You may be required to provide proof of purchase documentation to verify that you are an authorized user of the projector.

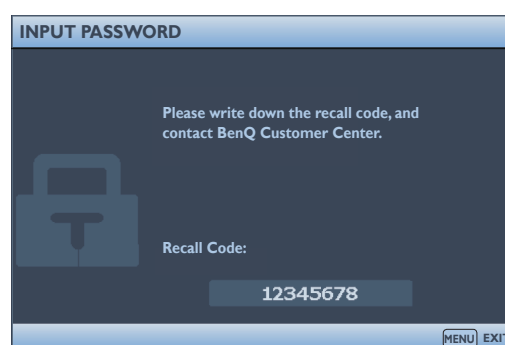

Changing the password

1. Open the OSD menu and go to the **SYSTEM SETUP:Advanced > Security Settings > Change Password** menu.
2. Press **MODE/ENTER**. The message **'INPUT CURRENT PASSWORD'** displays.
3. Enter the old password.
 - If the password is correct, another message **'INPUT NEW PASSWORD'** displays.
 - If the password is incorrect, the password error message displays lasting for three seconds, and the message **'INPUT CURRENT PASSWORD'** displays for your retry. You can press **MENU/EXIT** to cancel the change or try another password.
4. Enter a new password.

 **The digits being input will display as asterisks on-screen. Write your selected password down here in this manual in advance or right after the password is entered so that it is available to you should you ever forget it.**

Password: _ _ _ _ _

Keep this manual in a safe place.

5. Re-enter the new password to confirm it.
6. You have successfully assigned a new password to the projector. Remember to enter the new password next time the projector is started.
7. To leave the OSD menu, press **MENU/EXIT**.

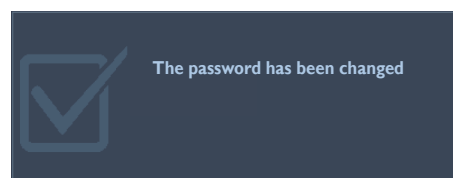

Switching input signal

The projector can be connected to multiple devices at the same time. However, it can only display one full screen at a time.

Be sure the **Quick Auto Search** function in the **SOURCE** menu is **On** (which is the default of this projector) if you want the projector to automatically search for the signals.

You can also manually cycle through the available input signals.

1. Press **SOURCE** on the projector or remote control. Displays the source selection bar.
2. Press **▲/▼** until your desired signal is selected and press **MODE/ENTER**.

Once detected, the selected source information will display on the screen for seconds. If there is multiple equipment connected to the projector, repeat steps 1-2 to search for another signal.

- ☞ **The brightness level of the projected image will change accordingly when you switch between different input signals. Data (graphic) “PC” presentations using mostly static images are generally brighter than “Video” using mostly moving images (movies).**
- For best display picture results, you should select and use an input signal which outputs at this resolution. Any other resolutions will be scaled by the projector depending upon the 'aspect ratio' setting, which may cause some image distortion or loss of picture clarity. See “Selecting the aspect ratio” on page 35 for details.**

Changing Color Space

In the unlikely event that you connect the projector to a DVD player via the projector's HDMI input and the projected picture displays wrong colors, please change the color space.

The operation is as follows:

1. Press **MENU/EXIT** and then press **◀/▶** until the **SOURCE** menu is highlighted.
2. Press **▼** to highlight **Color Space Conversion** and press **◀/▶** to select the setting.

☞ **This function is only available when the HDMI input port is in use.**

Selecting the aspect ratio

The "aspect ratio" is the ratio of the image width to the image height. Most analog TV and computers are in 4:3 ratio, and digital TV and DVDs are usually in 16:9 ratio.

With the advent of digital signal processing, digital display devices like this projector can dynamically stretch and scale the image output to a different aspect than that of the image input signal.

To change the projected image ratio (no matter what aspect the source is):

- Using the remote control
 1. Press **ASPECT RATIO** to show the current setting.
 2. Press **ASPECT RATIO** repeatedly to select an aspect ratio to suit the format of the video signal and your display requirements.
- Using the menus
 1. Press **MENU/EXIT** and then press ◀/▶ until the **DISPLAY** menu is highlighted.
 2. Press ▼ to highlight **Aspect Ratio**.
 3. Press ◀/▶ to select an aspect ratio to suit the format of the video signal and your display requirements.

About the aspect ratio

 In the pictures below, the black portions are inactive areas and the white portions are active areas. OSD menus can be displayed on those unused black areas.

1. **Auto:** Scales an image proportionally to fit the projector's native resolution in its horizontal width. This is suitable for the incoming image which is not in 4:3 and you want to make most use of the screen without altering the image's aspect ratio.

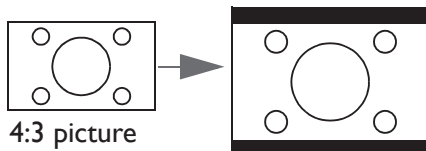

2. **Real:** The image is projected as its original resolution, and resized to fit within the display area. For input signals with lower resolutions, the projected image will display smaller than if resized to full screen. You could adjust the zoom setting or move the projector backwards the screen to increase the image size if necessary. You may also need to refocus the projector after making these adjustments.

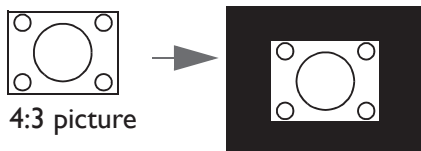

3. **4:3:** Scales an image so that it is displayed in the center of the screen with a 4:3 aspect ratio. This is most suitable for 4:3 images like computer monitors, standard definition TV and 4:3 aspect DVD movies, as it displays them without aspect alteration.

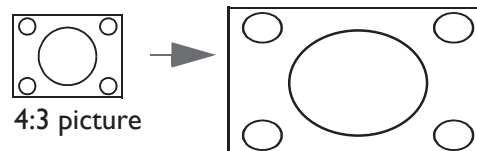

4. **16:10:** Scales an image so that it is displayed in the center of the screen with a 16:10 aspect ratio. This is most suitable for images which are already in a 16:10 aspect as it displays them without aspect alteration.

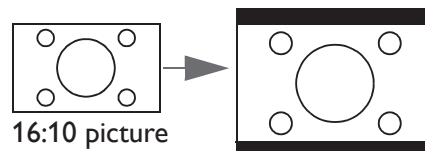

5. **16:9:** Scales an image so that it is displayed in the center of the screen with a 16:9 aspect ratio. This is most suitable for images which are already in a 16:9 aspect as it displays them without aspect alteration.

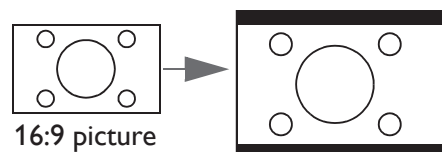

Optimizing the image

Using Wall Color

In the situation where you are projecting onto a colored surface such as a painted wall which may not be white, the **Wall Color** feature can help correct the projected picture's color to prevent possible color difference between the source and projected pictures.

To use this function, go to the **DISPLAY > Wall Color** menu and press ◀/▶ to select a color which is the closest to the color of the projection surface. There are several precalibrated colors to choose from: **Light Yellow, Pink, Light Green, Blue, and Blackboard**.

Selecting a picture mode

The projector is preset with several predefined picture modes so that you can choose one to suit your operating environment and input signal picture type.

To select an operation mode that suits your need, you can follow one of the following steps.

- Press **MODE/ENTER** on the projector repeatedly until your desired mode is selected.
 - Go to the **PICTURE > Picture Mode** menu and press ◀/▶ to select a desired mode.
1. **Dynamic mode:** Maximizes the brightness of the projected image. This mode is suitable for environments where extra-high brightness is required, such as using the projector in well lit rooms.
 2. **Presentation mode:** Is designed for presentations. The brightness is emphasized in this mode to match PC and notebook coloring.
 3. **sRGB mode:** Maximizes the purity of RGB colors to provide true-to-life images regardless of brightness setting. It is most suitable for viewing photos taken with an sRGB compatible and properly calibrated camera, and for viewing PC graphic and drawing applications such as AutoCAD.
 4. **Vivid mode:** It is suitable for image playback. It enables vivid color display.
 5. **Infographic mode:** Is designed for presentations. This mode highlights the color to display presentations with abundant charts.
 6. **User 1 mode:** Recalls the settings customized based on the current available picture modes.

Setting the User 1 mode

You can use one of the picture modes (except the User 1) as a starting point and customize the settings if the current available picture modes are not suitable for your need.

1. Press **MENU/EXIT** to open the On-Screen Display (OSD) menu.
2. Go to the **PICTURE > Picture Mode** menu.
3. Press ◀/▶ to select User 1.
4. Press ▼ to highlight **Reference Mode**.

 **This function is only available when User 1 mode is selected up in the Picture Mode sub-menu item.**

5. Press ▼ to select a sub-menu item to be changed and adjust the value with ◀/▶. See “[Fine-tuning the image quality in user modes](#)” for details.

Fine-tuning the image quality in user modes

According to the detected signal type and selected picture mode, some of the below functions may not be available. Based on your needs, you can make adjustments to these functions by highlighting them and pressing ◀/▶ on the projector or remote control.

Adjusting Brightness

The higher the value, the brighter the image. And the lower the setting, the darker the image. Adjust this control so the black areas of the image appear just as black and that detail in the dark areas is visible.



Adjusting Contrast

The higher the value, the greater the contrast. Use this to set the peak white level after you have previously adjusted the **Brightness** setting to suit your selected input and viewing environment.



Adjusting Color

Lower setting produces less saturated colors. If the setting is too high, colors on the image will be overpowering, which makes the image unrealistic.

Adjusting Tint

The higher the value, the more reddish the picture becomes. The lower the value, the more greenish the picture becomes.

Adjusting Sharpness

The higher the value, the sharper the picture becomes. The lower the value, the softer the picture becomes.

Adjusting Brilliant Color

This feature utilizes a new color-processing algorithm and system level enhancements to enable higher brightness while providing truer, more vibrant colors in picture. It enables a greater than 50 % brightness increase in mid-tone images, which are common in video and natural scenes, so the projector reproduces images in realistic and true colors. If you prefer images with that quality, select **On**. If you don't need it, select **Off**.

When **Off** is selected, the **Color Temperature** function is not available.

Selecting a Color Temperature

The options available for color temperature* settings vary according to the signal type selected.

1. **Cool:** Makes images appear bluish white.
2. **Normal:** Maintains normal colorings for white.
3. **Warm:** Makes images appear reddish white.

*About color temperatures:

There are many different shades that are considered to be "white" for various purposes. One of the common methods of representing white color is known as the "color temperature". A white color with a low color temperature appears to be reddish white. A white color with a high color temperature appears to have more blue in it.

Setting a preferred color temperature

To set a preferred color temperature:

1. Highlight **Color Temperature** and select **Warm, Normal** or **Cool** by pressing ◀/▶ on the projector or remote control.
2. Press ▼ to highlight **Color Temperature Fine Tuning** and press **MODE/ENTER**. The Color Temperature Fine Tuning page displays.
3. Press ▲/▼ to select the item you want to change and adjust the values by pressing ◀/▶.
 - **R Gain/G Gain/B Gain:** Adjusts the contrast levels of Red, Green, and Blue.
 - **R Offset/G Offset/B Offset:** Adjusts the brightness levels of Red, Green, and Blue.
4. Press **MENU/EXIT** to exit and save the settings.

3D Color Management

In most installation situations, color management will not be necessary, such as in classroom, meeting room, or lounge room situations where lights remain on, or where building external windows allow daylight into the room.

Only in permanent installations with controlled lighting levels such as boardrooms, lecture theaters, or home theaters, should color management be considered. Color management provides fine color control adjustment to allow for more accurate color reproduction, should you require it.

Proper color management can only be achieved under controlled and reproducible viewing conditions. You will need to use a colorimeter (color light meter), and provide a set of suitable source images to measure color reproduction. These tools are not provided with the projector, however, your projector supplier should be able to provide you with suitable guidance, or even an experienced professional installer.

The Color Management provides six sets (RGBCMY) of colors to be adjusted. When you select each color, you can independently adjust its range and saturation according to your preference.

If you have purchased a test disc which contains various color test patterns and can be used to test the color presentation on monitors, TVs, projectors, etc. You can project any image from the disc on the screen and enter the **3D Color Management** menu to make adjustments.

To adjust the settings:

1. Go to the **PICTURE** menu and highlight **3D Color Management**.

2. Press **MODE/ENTER** and the **3D Color Management** page displays.
3. Select **Primary Color** and press ◀/▶ to select a color from among Red, Green, Blue, Cyan, Magenta, or Yellow.
4. Press ▼ to highlight **Hue** and press ◀/▶ to select its range. Increase in the range will include colors consisted of more proportions of its two adjacent colors. Please refer to the illustration to the right for how the colors relate to each other.

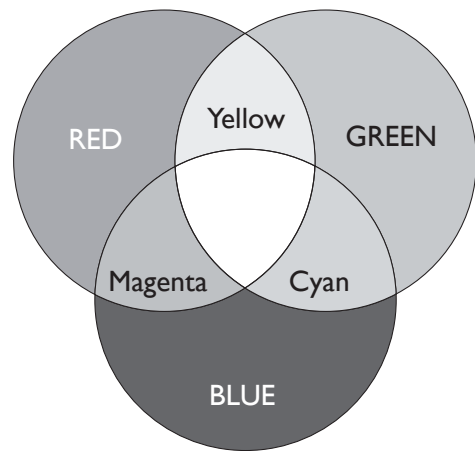

For example, if you select Red and set its range at 0, only pure red in the projected picture will be selected. Increasing its range will include red close to yellow and red close to magenta.

5. Press ▼ to highlight **Saturation** and adjust its values to your preference by pressing ◀/▶. Every adjustment made will reflect to the image immediately.

For example, if you select Red and set its value at 0, only the saturation of pure red will be affected.

 **Saturation is the amount of that color in a video picture. Lower settings produce less saturated colors; a setting of “0” removes that color from the image entirely. If the saturation is too high, that color will be overpowering and unrealistic.**

6. Press ▼ to highlight **Gain** and adjust its values to your preference by pressing ◀/▶. The contrast level of the primary color you select will be affected. Every adjustment made will reflect to the image immediately.
7. Repeat steps 3 to 6 for other color adjustments.
8. Make sure you have made all of the desired adjustments.
9. Press **MENU/EXIT** to exit the menu and save the setting.

Resetting current or all picture modes

1. Go to the **PICTURE** menu and highlight **Reset Picture Settings**.
2. Press **MODE/ENTER** and press ▲/▼ to select **Current** or **All**.
 - **Current:** returns current picture mode to the factory preset settings.
 - **All:** returns all settings, except User 1 in the PICTURE menu to the factory preset settings.

Remote paging operations

Connect the projector to your PC or notebook with a USB cable prior to using the paging function. See “[Connection](#)” on page 23 for details.

You can operate your display software program (on a connected PC) which responds to page up/down commands (like Microsoft PowerPoint) by pressing **PAGE +/PAGE -** on the remote control.

If remote paging function doesn't work, check if the USB connection is correctly made and the mouse driver on your computer is updated to the latest version.

 **The remote paging operation cannot be performed in Microsoft® Windows® 98. We suggest to use Windows® XP or above.**

Freezing the image

Press **FREEZE** on the remote control to freeze the image. The word '**FREEZE**' will display in the screen. To release the function, press any key on the projector or remote control.

 **If the buttons below are available on your remote control, make sure that you cannot press them to release functions: LASER, # 2, # 5, PAGE +/PAGE -.**

Even if an image is frozen on the screen, the pictures are running on the video or other device. If the connected devices have active audio output, you will still hear the audio even though the image is frozen on screen.

Hiding the image

In order to draw the audience's full attention to the presenter, you can use **ECO BLANK** on the projector or remote control to hide the screen image. When this function is activated with an audio input connected, the audio can still be heard.

You can set the blank time in the **SYSTEM SETUP: Basic > Operation Settings > Blank Timer** menu to let the projector return the image automatically after a period of time when there is no action taken on the blank screen. The length of time can be set from 5 to 30 minutes in 5-minute increments.

If the default time span is suitable for your presentation, please select **Disable**.

No matter **Blank Timer** is activated or not, you can press any key on the projector or remote control to restore the picture.







- **Do not block the projection lens from projecting as this could cause the blocking object to become heated.**

Locking control keys

With the control keys locked, you can prevent your projector settings from being changed accidentally (by children, for example). When the **Panel Key Lock** is on, no control keys on the projector will operate except  **POWER**.

1. Go to the **SYSTEM SETUP: Basic > Panel Key Lock** menu and select **On** by pressing /  on the projector or remote control. A confirmation message appears.
2. Highlight **Yes** and press **MODE/ENTER**.

To release Panel Key Lock, use the remote control to enter **SYSTEM SETUP: Basic > Panel Key Lock** menu and press /  to select **Off**.





-  • **When activating Panel Key Lock, keys on the remote control are still effective.**
- **If pressing  to turn off the projector but not disabling Panel Key Lock, panel keys are still locked next time turning on the projector.**

Operating in a high altitude environment

We recommend you use the **High Altitude Mode** when your environment is between 1500 m –5000 m above sea level, and ambient temperature is between 0°C–30°C.

-  **Do not use the High Altitude Mode if your altitude is between 0 m and 1500 m and ambient temperature is between 0°C and 35°C. The projector will be over cooled, if you turn the mode on under such a condition.**

To activate the **High Altitude Mode**:

1. Press **MENU/EXIT** and then press /  until the **SYSTEM SETUP:Advanced** menu is highlighted.
2. Press  to select **High Altitude Mode** and press /  to select **On**. A confirmation message displays.
3. Highlight **Yes** and press **MODE/ENTER**.

Operation under “**High Altitude Mode**” may cause a higher decibel operating noise level because of increased fan speed necessary to improve overall system cooling and performance.

If you use this projector under other extreme conditions excluding the above, it may display auto shut-down symptoms, which is designed to protect your projector from over-heating. In cases like this, you should switch to High Altitude mode to solve these symptoms. However, this is not to state that this projector can operate under any and all harsh or extreme conditions.

Adjusting the sound

The sound adjustments made as below will have an effect on the projector speaker(s). Be sure you have made a correct connection to the projector audio input. See “[Connection](#)” on page 23 for how the audio input is connected.

Input signal	Audio Input	AUDIO OUT
PC	Mini jack	Mini jack
HDMI-1, HDMI-2/MHL	HDMI	Mini jack
VIDEO	RCA	Mini jack
S-VIDEO	RCA	Mini jack

Muting the sound

To temporarily turn off the sound,

- Using the remote control

Press **MUTE** to temporarily turn off the sound. When turning off the sound,  appears on the top-right corner of screen. To turn the sound on again, press **MUTE** again.

- Using the menus

1. Press **MENU/EXIT** and then press **◀/▶** until the **SYSTEM SETUP:Advanced** menu is highlighted.
2. Press **▼** to highlight **Audio Settings** and press **MODE/ENTER**. The **Audio Settings** page displays.
3. Highlight **Mute** and press **◀/▶** to select **On**.
4. To turn the sound on again, repeat Steps 1-3 and press **◀/▶** to select **Off**.

Adjusting the sound level

To adjust the sound level,

- Using the remote control

Press  or  to select a desired sound level.

- Using the menus

1. Repeat steps 1-2 above.
2. Press **▼** to highlight **Volume** and press **◀/▶** to select a desired sound level.

Adjusts the microphone's sound level.

To adjust the microphone volume, press **MIC/VOL (+/-)** on the remote control or:

1. Repeat steps 1-2 above.
2. Press **▼** to highlight **Microphone Volume** and press **◀/▶** to select a desired sound level.

Power On/Off Ring Tone

1. Repeat steps 1-2 above.
2. Highlight **Power On/Off Ring Tone** and press **◀/▶** to select **Off**.

The only way to change Power on/off ring tone is setting On or Off here.

Setting the sound mute or changing the sound level will not affect the Power on/off ring tone.

Using Test Pattern

This projector allows grid test pattern. This function lets you adjust image size and focal length to ensure projected image without distortion.

To display the test pattern, open the OSD menu and enter **SYSTEM SETUP:Advanced > Test Pattern** and press **◀/▶** to select **On**.

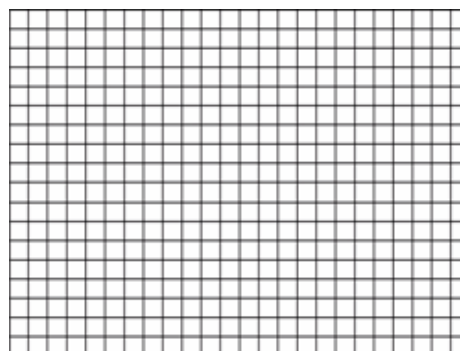

Using Quick Install

This projector provides hot keys to set up **Projector Installation**, **Test Pattern** and **Keystone**.

Press **QUICK INSTALL** on the remote control and press ▲/▼ to select options:

- Projector Installation: See “Installation” on page 18.
- Test Pattern: See “Using Test Pattern” on page 43.
- 2D Keystone: See “Correcting 2D keystone” on page 29.

Control the projector via the wired LAN environment

When the computer and projector are connected to the same LAN correctly, you can manage the projector by using the web browser on the computer via the "wired LAN".

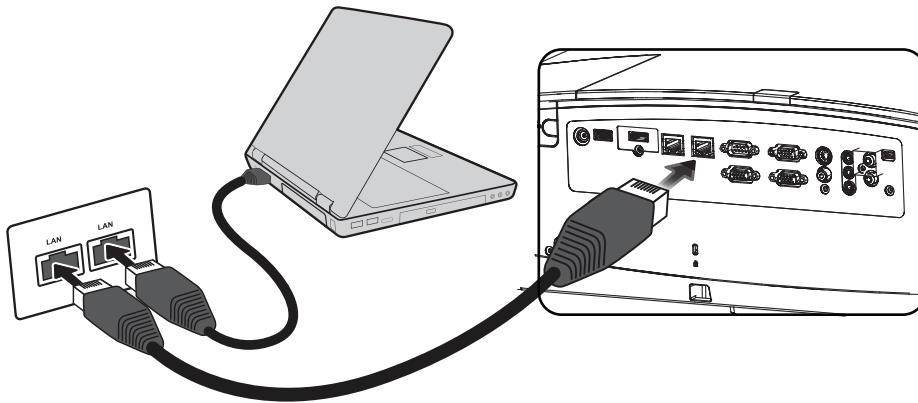

Install the wired LAN setting

In the DHCP environment:

1. Take an RJ45 cable and connect one end to the RJ45 LAN jack on the projector and the other end to the RJ45 port.

 **Avoid wrapping when connecting the RJ45 cable, otherwise signal noise or interference might occur.**

2. Press **MENU/EXIT** and then press ◀/▶ until the **SYSTEM SETUP:Advanced** menu is highlighted.
3. Press ▼ to highlight **Network Settings** and press **MODE/ENTER**. The **Network Settings** page displays.
4. Press ▼ to highlight **Wired LAN** and press **MODE/ENTER**. The **Wired LAN** page displays.
5. Highlight **DHCP** and press ◀/▶ to select **On**.
6. Please wait about 15-20 seconds and re-enter the **Wired LAN** page.

7. **IP Address, Subnet Mask, Default Gateway** and **DNS Server** settings will appear. Record the IP address displayed in **IP Address** line.

Wired LAN	
Status	Connection
DHCP	On
IP Address	10.82.30.156
Subnet Mask	255.255.255.0
Default Gateway	10.82.159.254
DNS Server	10.82.131.12
Apply	

 **Contact your ITS administrator if the IP address still has not appeared.**

3. Go to the **SYSTEM SETUP:Advanced > Network Settings** menu.
9. Press **▼** to highlight **AMX Device Discovery** and press **◀/▶** to select **On** or **Off**. When **AMX Device Discovery** is **On**, the projector can be detected by AMX controller.

In the non-DHCP environment:

- Repeat steps 1-4 above.
- Highlight **DHCP** and press **◀/▶** to select **Off**.
- Contact the ITS administrator to find out information on **IP Address, Subnet Mask, Default Gateway** and **DNS Server** settings.
- Press **▼** to select the item you want to modify and press **MODE/ENTER**.

Wired LAN	
Status	Connection
DHCP	On
IP Address	10.10.10.10
Subnet Mask	255.255.255.0
Default Gateway	0.0.0.0
DNS Server	0.0.0.0
Apply	

5. Press **◀/▶** to move the cursor and press **▲/▼** to enter values.

IP Address	255	.	255	.	10	.	10
------------	-----	---	-----	---	----	---	----

- Press **MODE/ENTER** to save the setting. Press **MENU/EXIT** if you don't want to save the setting.
- Press **▼** to highlight **Apply** and press **MODE/ENTER**.
- Press **MENU/EXIT** to return to the **Network Settings** page. Press **▼** to highlight **AMX Device Discovery** and press **◀/▶** to select **On** or **Off**.
- Press **MENU/EXIT** leave the menu.

Remote control the projector via web browser

If a correct IP address of projector exists and the projector is turned on or in standby mode, you can use any computer in the same LAN to control the projector.

1. Enter the address of projector in the address field of browser and click Go.

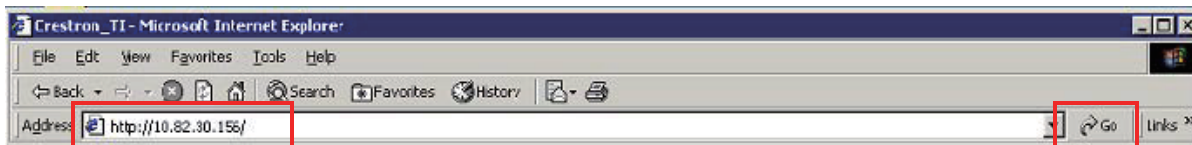

2. Open the operation page of remote control network. This page (Crestron eControl) allows you to operate the projector like using the remote control or the control panel of projector.



1	<p>If switching the input source, please click the signal you need.</p> <p> Source lists may differ, depending on the connectors available on the projector. "Video" indicates the video signal.</p>														
2	<table border="0"> <tr> <td>Menu</td> <td rowspan="5">See "Remote controller" on page 15 for details.</td> </tr> <tr> <td>Auto PC</td> </tr> <tr> <td>Blank</td> </tr> <tr> <td>Input</td> </tr> <tr> <td>▲(▼)</td> </tr> <tr> <td>▼(▲)</td> <td></td> </tr> <tr> <td>◀(▶)</td> <td></td> </tr> <tr> <td>▶(▶)</td> <td></td> </tr> <tr> <td>OK</td> <td>Activates the selected On-Screen Display (OSD) menu item.</td> </tr> </table>	Menu	See "Remote controller" on page 15 for details.	Auto PC	Blank	Input	▲(▼)	▼(▲)		◀(▶)		▶(▶)		OK	Activates the selected On-Screen Display (OSD) menu item.
Menu	See "Remote controller" on page 15 for details.														
Auto PC															
Blank															
Input															
▲(▼)															
▼(▲)															
◀(▶)															
▶(▶)															
OK	Activates the selected On-Screen Display (OSD) menu item.														

The tools page allows you to manage the projector, configure the LAN control settings and secure access of remote network operation on this projector.

The screenshot shows the BenQ Tools page with the following configuration sections:

- Crestron Control:** IP Address, IP ID, Port, and a Send button. (Numbered 1)
- Projector:** Projector Name, Location, Assigned To, and a Send button. (Numbered 2)
- User Password:** Enabled checkbox, New Password, Confirm, and a Send button. (Numbered 3)
- Admin Password:** Enabled checkbox, New Password, Confirm, and a Send button. (Numbered 4)
- Network configuration:** DHCP (Enabled), IP Address, Subnet Mask, Default Gateway, and DNS Server, each with a Send button. (Numbered 5)
- Exit:** A large black button at the bottom center. (Numbered 5)

1. You can name the projector, keep track of its location and the person in charge of it.
2. You can adjust the **Wired LAN Control settings**.
3. Once set, access to the remote network operation on this projector has been password-protected.
4. Once set, access to the tools page has been password-protected.
5. Press **Exit** to return to the operation page of remote control network.

 **After making the adjustments, press the Send button and the data will be saved in the projector.**

Please note that there is a length limit for the items in the following list (including the space and other punctuation keys):

Category Item	Input length	Maximum number of characters
Crestron Control	IP Address	15
	IP ID	4
	Port	5
Projector	Projector Name	22
	Position	22
	Assigned To	(Not applicable)
Network configuration	DHCP (Enabled)	15
	IP Address	15
	Subnet Mask	15
	Default Gateway	15
	DNS Server	(Not applicable)
User Password	Enabled	(Not applicable)
	New Password	15
	Confirm	15

Category Item	Input length	Maximum number of characters
Admin Password	Enabled	(Not applicable)
	New Password	15
	Confirm	15

The Information page displays the information and status of this projector.



Press **Exit** to return to the operation page of remote control network.

Visit <http://www.crestron.com> and www.crestron.com/getroomview for details.

Shutting down the projector

1. Press **POWER** or **OFF**. A confirmation message displays prompting you. If you don't respond in a few seconds, the message will disappear.
2. Press **POWER** or **OFF** a second time. **POWER indicator light** flashes orange and the projector lamp shuts down.
3. After cool down, you will hear the "power-off ring tone". **POWER indicator light** shows stable orange and the fan stops. Pull off the power cable from the socket.

- To turn off the power-off ring tone, refer to "Power On/Off Ring Tone" on page 43 for details.

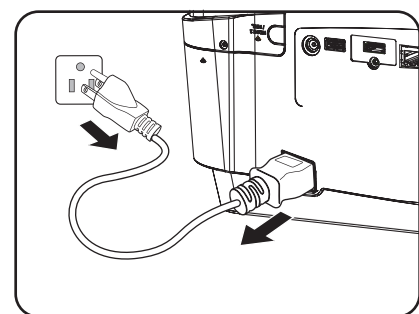

Menu operations

Menu system

Please note that the on-screen display (OSD) menus vary according to the signal type selected.

Main menu	Sub-menu	Option	
1. DISPLAY	Wall Color	Off/Light Yellow/Pink/Light Green/Blue/Blackboard	
	Aspect Ratio	Auto/Real/4:3/16:9/16:10	
	2D Keystone		
	Corner Fit	Top-Left/Top-Right/Bottom-Left/Bottom-Right	
	Position		
	Phase		
	H. Size		
	Digital Zoom	PC: 1.0x~2.0x Video: 1.0x~1.8x	
		3D Mode	Auto/Off/Frame Sequential/Frame Packing/Top Bottom/Side by Side
		3D Sync Invert	Disable/Invert
	3D	Save 3D Settings	3D Settings 1/3D Settings 2/3D Settings 3
	Apply 3D Settings	3D Settings 1/3D Settings 2/3D Settings 3/Off	

Main menu	Sub-menu	Option	
2. PICTURE	Picture Mode	Dynamic/Presentation/sRGB/Infographic/ (3D)/Vivid/User 1	
	Reference Mode	Dynamic/Presentation/sRGB/Infographic/ (3D)/Vivid	
	Brightness		
	Contrast		
	Color		
	Tint		
	Sharpness		
	Brilliant Color	On/Off	
	Color Temperature	Cool/Normal/Warm	
	Color Temperature Fine Tuning	R Gain/G Gain/B Gain/R Offset/G Offset/B Offset	
	3D Color Management	Primary Color	R/G/B/C/M/Y
		Tint	
		Saturation	
		Gain	
Reset Picture Setting	Current/All/Cancel		
3. SOURCE	Quick Auto Search	On/Off	
	HDMI Range	Auto/Full/Limited	
	Color Space Conversion	Auto/RGB/YUV	

Main menu	Sub-menu	Option
	Language	English / Français / Deutsch / Italiano / Español / Русский / 繁體中文 / 简体中文 / 日本語 / 한국어 / Svenska / Nederlands / Türkçe / Čeština / Português / ไทย / Polski / Magyar / Hrvatski / Română / Norsk / Dansk
	Projector Installation	Front Table/Rear Table/Rear Ceiling/ Front Ceiling
	Menu Display Time	5 secs/10 secs/20 secs/30 secs/Always
	Menu Settings	Menu Position Center/Top-Left/Top-Right/Bottom-Right/Bottom-Left
	Reminder Message	On/Off
	Operation Settings	Direct Power On On/Off
	Signal Power On	Computer On/Off HDMI On/Off
	Auto Power Off	Disable/3 min/10 min/15 min/20 min/25 min/30 min
	Auto Hide Screen Picture	On/Off
	Blank Timer	Disable/5 min/10 min/15 min/20 min/25 min/30 min
	Sleep Timer	Disable/30 min/1 hr/2 hrs/3 hrs/4 hrs/8 hrs/12 hrs
	Reset Filter Timer	Reset/Cancel
	Remote Receiver	Front+Rear/Front/Rear
	Panel Key Lock	On/Off Yes/No
	Background Color	BenQ/Black/Blue/Purple
	Splash Screen	BenQ/Black/Blue

4. SYSTEM SETUP: Basic

Main menu	Sub-menu	Option
	High Altitude Mode	On/Off
	Mute	On/Off
Audio Settings	Volume	
	Microphone Volume	
	Light Source Mode	Normal/Economic/Dimming
	Dynamic Black	On/Off
Light Source Settings	Reset Light Source Timer	Reset/Cancel
	Light Source Information	Normal/Economic/Dimming Light Hour Equivalent Light Hour
	Change Password	
Security Settings	Change Security	
	Power On Lock	On/Off
Baud Rate		2400/4800/9600/14400/19200/38400/57600/115200
Test screen		On/Off
Closed Caption	Closed Caption Enable	On/Off
	Caption Version	CCI/CC2/CC3/CC4
12V Trigger		On/Off
	Network	Enable network standby mode/Switch to normal standby mode
Standby Settings	Microphone	On/Off
	Monitor Out	On/Off
	Audio Pass Through	Off/Audio In/Audio L/R/HDMI
	Wired LAN	Status/DHCP/IP Address/Subnet Mask/ Default Gateway/DNS Server/Apply
Network Settings	AMX Device Discovery	On/Off
	MAC Address	
Reset All Settings		Reset/Cancel

**5.
SYSTEM
SETUP:
Advanced**



Main menu	Sub-menu	Option
6. INFORMATION	Current System Status	<ul style="list-style-type: none">• Source• Picture Mode• Light Source Mode• Resolution• 3D Format• Color System• Light Source Usage Time• Firmware Version

Note that the menu items are available when the projector detects at least one valid signal. If there is no equipment connected to the projector or no signal detected, limited menu items are accessible.

Description of each menu

FUNCTION		DESCRIPTION
1.DISPLAY menu	Wall Color	Corrects the projected picture's color when the projection surface is not white. See “Using Wall Color” on page 37 for details.
	Aspect Ratio	There are several options to set the image's aspect ratio depending on your input signal source. See “Selecting the aspect ratio” on page 35 for details.
	2D Keystone	Adjust the shape of projected image to ensure that all the lines forming the four angles are straight ones. See “Correcting 2D keystone” on page 29 for details.
	Corner Fit	Adjust the shape of projected image to ensure that one angle stays perpendicular. See “Adjusting corner fit” on page 30 for details.
	Position	Displays the position adjustment page. Press arrow key to move project image. Press this key to scroll through values shown in bottom of page from the least to the maximum or vice versa. This function is only available when a PC signal (analog RGB) is selected.
	Phase	Adjusts the clock phase to reduce image distortion. This function is only available when a PC signal (analog RGB) is selected.
	H. Size	Adjusts the horizontal width of the image. This function is only available when a PC signal (analog RGB) is selected.
	Digital Zoom	Shows the digital zoom function with Zoom bar. <ul style="list-style-type: none"> • PC: 1.0x~2.0x, • Video: 1.0x~1.8x





FUNCTION	DESCRIPTION
<p style="writing-mode: vertical-rl; transform: rotate(180deg);">1.DISPLAY menu</p> <p style="text-align: center;">3D</p>	<p>This projector features a 3D function which enables you to enjoy the 3D movies, videos, and sporting events in a more realistic way by presenting the depth of the images. You need to wear a pair of 3D glasses to view the 3D images.</p> <p>3D Mode The default setting is Auto and the projector automatically chooses an appropriate 3D format when detecting 3D contents. If the projector cannot recognize the 3D format, press ◀/▶ to choose a 3D mode.</p> <p> When the 3D function is turned on:</p> <ul style="list-style-type: none"> • The brightness level of the projected image will decrease. • The settings below cannot be adjusted: Picture mode and Reference Mode. • The correcting keystone function can only be adjusted within a limited angle range. <p>3D Sync Invert When you discover the inversion of the image depth, enable this function to correct the problem.</p> <p>Save 3D Settings After carrying out proper adjustments to display the 3D content, you can enable this function and select a 3D setting to memorize the current 3D setting.</p> <p>Apply 3D Settings After saving the 3D setting, you can decide whether to apply this 3D setting by selecting a saved 3D setting. Once the 3D setting is applied, the projector automatically plays the 3D content being input if matching the saved 3D setting.</p> <p> Only the 3D setting with memory data is available.</p>

FUNCTION	DESCRIPTION
Picture Mode	Pre-defined picture modes are provided so you can optimize your projector image set-up to suit your program type. See “Selecting a picture mode” on page 37 for details.
Reference Mode	Selects a picture mode that best suits your need for the image quality and further fine-tune the image based on the selections listed on the same page below. See “Setting the User 1 mode” on page 38 for details.
Brightness	Adjusts the brightness of the image. See “Adjusting Brightness” on page 38 for details.
Contrast	Adjusts the degree of difference between dark and light in the image. See “Adjusting Contrast” on page 38 for details.
Color	Adjusts the color saturation level -- the amount of each color in a video image. See “Adjusting Color” on page 38 for details.  This function is only available when selecting the video or S-video of the NTSC system.
Tint	Adjust red and green tint of image. See “Adjusting Tint” on page 38 for details.  This function is only available when selecting the video or S-video of the NTSC system.
Sharpness	Adjusts the image to make it look sharper or softer. See “Adjusting Sharpness” on page 38 for details.  This function is only available when selecting the video or S-video of the NTSC system.
Brilliant Color	Adjust the white peak value while ensuring that the color is displayed correctly. See “Adjusting Brilliant Color” on page 38 for details.
Color Temperature	See “Selecting a Color Temperature” on page 39 for details.
Color Temperature Fine Tuning	See “Setting a preferred color temperature” on page 39 for details.
3D Color Management	See “3D Color Management” on page 39 for details.
Reset Picture Setting	See “Resetting current or all picture modes” on page 40 for details.

	FUNCTION	DESCRIPTION
3. SOURCE menu	Quick Auto Search	See “Switching input signal” on page 34 for details.
	HDMI Range	Select the type of input source for the HDMI signal. "Auto" means to confirm and recommend the setting. You can also select the source type. Different brightness standards are carried out for different source types.  This function is only available when a HDMI signal is selected.
	Color Space Conversion	See “Changing Color Space” on page 34 for details.
4. SYSTEM SETUP: Basic menu	Language	Sets the language for the On-Screen Display (OSD) menus. See “Using the menus” on page 31 for details.
	Projector Installation	The projector can be installed on a ceiling or behind a screen, or with one or more mirrors. See “Installation” on page 18 for details.
	Menu Settings	<p>Menu Display Time Sets the length of time the OSD will remain active after your last key press. The range is from 5 to 30 seconds in 5-second increments.</p> <p>Menu Position Sets the On-Screen Display (OSD) menu position.</p> <p>Reminder Message If you select On, the projector will remind you to clean the filter when necessary.</p>

FUNCTION	DESCRIPTION
Operation Settings 4.SYSTEM SETUP: Basic menu	<p>Direct Power On When connecting the power cable, the projector is turned on automatically.</p> <p>Signal Power On The default setting is that the projector is turned On automatically without pressing POWER or when it is in standby mode and a signal exists in the VGA or HDMI 1 cable.</p> <p>Auto Power Off Allows the projector to turn off automatically if no input signal is detected after a set period of time.</p> <p>Auto Hide Screen Picture If you select On, the image is turned off automatically 3 minutes after the projector has not received any signal. Press any key to cancel this function.</p> <p>Blank Timer Sets the image blank time when the Blank feature is activated, once elapsed the image will return to the screen. See “Hiding the image” on page 41 for details.</p> <p>Sleep Timer Sets the auto-shutdown timer. The timer can be set to a value between 30 minutes and 12 hours.</p>
Remote Receiver	Sets which IR remote sensor (front sensor or rear sensor) of the projector will receive the signal from the remote control.
Panel Key Lock	Disables or enables all panel key functions except  Power on the projector and keys on the remote control. See “Locking control keys” on page 42 for details.
Background Color	Select the background effect when no signal is available.
Splash Screen	Allows you to select which logo screen will display during projector start-up.

FUNCTION	DESCRIPTION
High Altitude Mode	It is the operation mode suitable for high altitude areas. See “Operating in a high altitude environment” on page 42 for details.
Audio Settings	<p>See “Adjusting the sound” on page 42 for details.</p> <p>Mute Sets the mute function.</p> <p>Volume Adjusts the audio volume level.</p> <p>Microphone Volume Adjusts the microphone’s audio volume level.</p> <p>Power On/Off Ring Tone Sets the power on/off ring tone.</p>
Light Source Settings	<p>Light Source Mode You can adjust the light source mode to Normal/Economic/Dimming/Customize.</p> <p>Dynamic Black If the output image is black, the image brightness is turned off automatically.</p> <p>Reset Light Source Timer Reset the light hour in the light source information.</p> <p>Light Source Information Display the light hour in the light source mode.</p>
Security Settings	<p>Change Password You will be asked to enter the current password before changing to a new one. See “Utilizing the password function” on page 32 for details.</p> <p>Change Security Settings</p> <p>Power On Lock When Power On Lock is activated, you must enter the current password to turn on the projector. If you enter the wrong password for 5 times, the projector immediately turns off automatically.</p> <p>Web Control Lock If Web Control Lock is opened, you must enter the password to turn on the projector.</p>
Baud Rate	Select the Baud Rate the same as the one for your computer to use the appropriate RS-232 cable to connect the projector or update or download the projector firmware. This function is intended for qualified service personnel.
Test Pattern	<p>Selecting On enables the function and the projector displays the grid test pattern.</p> <p>It helps you adjust the image size and focus and check that the projected image is free from distortion.</p>

FUNCTION	DESCRIPTION
Closed Caption	<p>Closed Caption Enable Activates the function by selecting "On" when the selected input signal carries closed captions.</p> <ul style="list-style-type: none"> • Captions:An on-screen display of the dialogue, narration, and sound effects of TV programs and videos that are closed captioned (usually marked as "CC" in TV listings). <p>Caption Version Selects a preferred closed captioning mode. To view captions, select CC1, CC2, CC3, or CC4 (CC1 displays captions in the primary language in your area).</p>
12V Trigger	<p>Turn on or off the output of 12V Trigger. Used to trigger external devices such as an electric screen or light control, etc. Consult your dealer for how to connect these devices.</p>
<p style="writing-mode: vertical-rl; transform: rotate(180deg);">5.SYSTEM SETUP:Advanced menu</p> Standby Settings	<p>Network</p> <ul style="list-style-type: none"> • Enable network standby mode Selecting On enables the function. This projector provides the network function in the standby mode. Selecting Off disables the function. This projector does not provide the network function in the standby mode. • Switch to normal standby mode This allows the projector to disable the network function after entering the standby mode for a while. For instance, the projector enables the network function for 20 minutes after entering the standby mode if you select the 20-minute option. The projector enters the normal standby mode after 20 minutes. <p> This function is only available when "Enable network standby mode" is "On".</p> <p>Microphone Selecting On enables the function, and the microphone can be used even in standby mode.</p> <p>Monitor Out Selecting "On" enables the function. The projector can output a VGA signal when it is in standby mode and the PC jack is correctly connected to devices. See "Connection" on page 23 for how to make the connection.</p> <p>Audio Pass Through Press ◀/▶ to choose the source that you wish to use. See "Connection" on page 23 for how to make the connection.</p> <p>If the projector is in the standby mode and corresponding ports are all connected to the device correctly, the projector can output the audio signal to the external speaker. The built-in speaker will be muted in the standby mode.</p> <p> Enabling this function slightly increases the standby power consumption.</p>

FUNCTION	DESCRIPTION
5.SYSTEM SETUP:Advanced menu	<p>Wired LAN See “Control the projector via the wired LAN environment” on page 44 for details.</p> <p>AMX Device Discovery When AMX Device Discovery is On, the projector can be detected by AMX controller.</p> <p>MAC Address Displays the mac address for this projector.</p>
	<p>Returns all settings to the factory preset values.</p> <p> The following settings will still remain: Position, Phase, H. Size, Projector Installation, Language, High Altitude Mode, Security Settings and Baud Rate.</p>
6.INFORMATION menu	<p>Source Shows the current signal source.</p> <p>Picture Mode Shows the selected mode in the PICTURE menu.</p> <p>Light Source Mode Display current light source mode.</p> <p>Resolution Shows the supported resolution of the input signal.</p> <p>3D Format Shows the current 3D mode.</p> <p>Color System Display the format for entering data into the system: NTSC, PAL, SECAM or RGB.</p> <p>Light Source Usage Time Display time of the light source used.</p> <p>Firmware Version Display the separation version of projector.</p>

 **INFORMATION** menu shows the current operation of projector.

Maintenance

Prior to projector maintenance

- Be sure to turn off the projector before maintenance.
- Be sure to follow the steps in “[Shutting down the projector](#)” on page 48 when shutting down the projector.

Care of the projector

Your projector needs little maintenance. The only thing you need to do on a regular basis is to keep the lens clean.

Never remove any parts of the projector. Contact your dealer if other parts need replacing.

Clean the lens

Clean the lens whenever you notice dirt or dust on the surface.

- Use a canister of compressed air to remove dust.
- If there is dirt or smears, use lens-cleaning paper or moisten a soft cloth with lens cleaner and gently wipe the lens surface.

Caution:

Never use any type of abrasive pad, alkaline/acid cleaner, scouring powder, or volatile solvent, such as alcohol, benzene, thinner or insecticide. Using such materials or maintaining prolonged contact with rubber or vinyl materials may result in damage to the projector surface and cabinet material.

Cleaning the projector case

Before you clean the case, turn the projector off using the proper shutdown procedure as described in “[Shutting down the projector](#)” on page 48 and unplug the power cord.

- To remove dirt or dust, wipe the case with a soft, lint-free cloth.
- To remove stubborn dirt or stains, moisten a soft cloth with water and a neutral pH detergent. Then wipe the case.

Caution:

Never use wax, alcohol, benzene, thinner or other chemical detergents. These can damage the case.

Dust filter maintenance

Dust filter replacement

The dust filter can be used to prevent the dust from piling up on the surface of the optical element in the projector. If the dust filter is dirty or blocked, the projector would heat excessively or the quality of projected image would be reduced.

1. A replacement notice pops up after the dust filter is used for 500 hours. Select Reset to reset the timer and replace the dust filter.
2. A reminder pops up when you reboot the projector next time if you select Cancel until you select Reset.

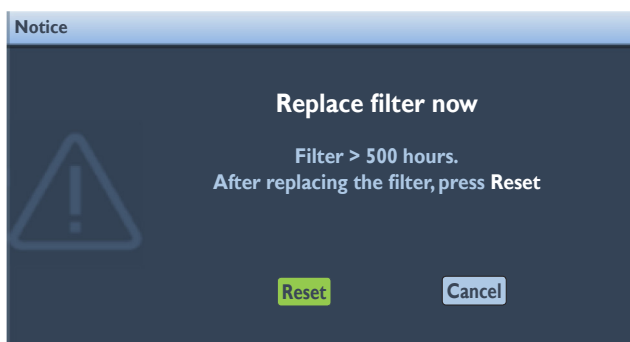

Caution:

It is suggested that you should avoid using the projector in a dusty or smoky environment, otherwise the picture quality might be reduced. If the dust filter is seriously blocked and cannot be cleaned, replace it with a new one.

Note:

It is suggested that you should use a ladder when replacing the dust filter. Do not remove the projector from the wall mount bracket.

Side dust filter replacement

1. Shut down the projector and pull off the power plug from the socket. Clean the dust on the projector and near the ventilation hole. Loosen the 5 fasten screws used for fastening the cap of dust filter.
4. Align the hole on the module of the new dust filter to the fasten screw on the cap of dust filter.

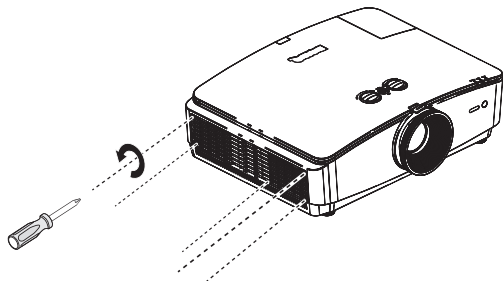

2. Pull the cap of dust filter.

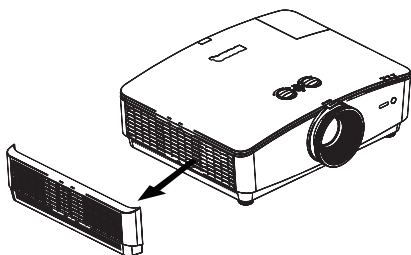

3. Remove the module of dust filter from the projector.

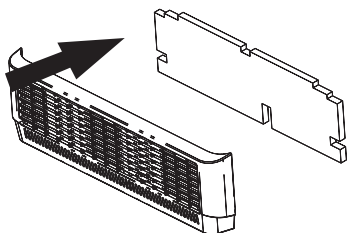

5. Push in the cap gently and fasten screws according to the indicated direction to install the cap of dust filter back to the projector.

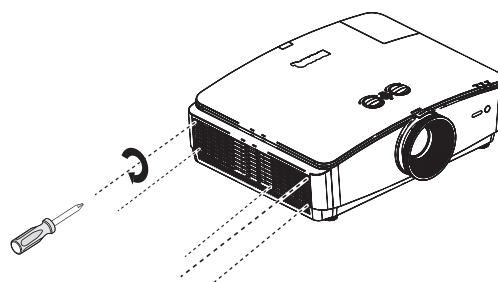
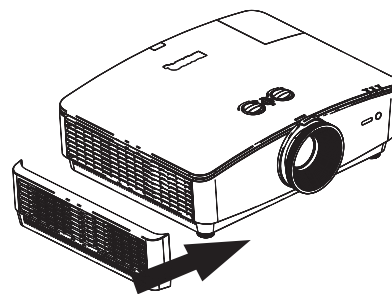

LED Indicator

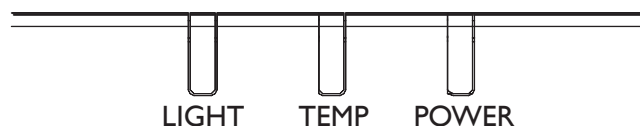

System message

Power	Temp	Light	Status & Description
Orange	-	-	Stand-by mode
Green Flashing	-	-	Powering up
Green	-	-	Normal operation
Orange Flashing	-	-	Normal power-down cooling
Red Flashing	Red Flashing	Red Flashing	Download
Green	-	Red	CW start fail
Green	-	Orange	The lamp dies out.

Light source error messages

Power	Temp	Light	Status & Description
-	-	RED	Light source error in normal operation
-	-	Orange Flashing	Light source is not lit up

Thermal error messages

Power	Temp	Light	Status & Description
Red	Red	-	Fan 1 error
Red	Red Flashing	-	Fan 2 error
Red	Green	-	Fan 3 error
Red	Green Flashing	-	Fan 4 error
Red Flashing	Red	-	Fan 5 error
Red Flashing	Red Flashing	-	Fan 6 error
Red Flashing	Green	-	Fan 7 error
Green	Red	-	Temperature 1 error

Troubleshooting

Troubleshooting

The projector does not turn on.

Cause	Remedy
There is no power from the power cable.	Plug the power cord into the AC inlet on the projector, and plug the power cord into the power outlet. If the power outlet has a switch, make sure that it is switched on.

No picture

Cause	Remedy
The video source is not turned on or connected correctly.	Turn the video source on and check that the signal cable is connected correctly.
The projector is not correctly connected to the input signal device.	Check the connection.
The input signal has not been correctly selected.	Select the correct input signal with the SOURCE key on the projector or remote control.

Blurred image

Cause	Remedy
The projection lens is not correctly focused.	Adjust the focus of the lens using the focus ring.
The projector and the screen are not aligned properly.	Adjust the projection angle and direction as well as the height of the unit if necessary.

Remote control does not work

Cause	Remedy
The battery is out of power.	Replace the battery with new one.
There is an obstacle between the remote control and the projector.	Remove the obstacle.
You are too far away from the projector.	Stand within 7 meters (23 feet) of the projector.

The password is incorrect

Cause	Remedy
You do not remember the password.	<ol style="list-style-type: none"> 1. Press and hold AUTO on the projector or remote control for 3 seconds. The projector will display a coded number on the screen. 2. Write down the number and turn off your projector. 3. Seek help from the local BenQ service center to decode the number. You may be required to provide proof of purchase documentation to verify that you are an authorized user of the projector.

Specifications

Specifications

Optical

Resolution

LX770

1024 x 768

LH770

1920 x 1080

Display system

Single-chip DLP™ system

Light source

Laser Diode

Electrical

Power supply

AC 100-240V

50-60 Hz (Automatic)

6.00 A

Power consumption

540 W (Max); < 0.5 W (Standby)

Mechanical

Weight

30.4 lbs (13.8 Kg)

Output terminals

Speaker

10w x 1 (peak-to-peak value)

Audio signal output

PC audio jack x 1

Monitor Out

D-Sub 15-pin (female) x1

USB

Type-A (5 V/1.5 A)

Control

USB

MINI-B x1

RS-232 serial control

9 pin x 1

IR receiver x 2

12V Trigger

12VDC (Max 0.2 A) x 1

LAN control

RJ45 x 1

Input terminals

Computer input

RGB input

D-Sub 15-pin (female) x 2

Video signal input

COMPONENT

D-Sub 15-pin (female) x 2

S-VIDEO

Mini DIN 4-pin port x 1

VIDEO

RCA jack x 1

SD/HDTV signal input

Digital-HDMI x 1

HDMI 2/MHL x 1

Audio signal input

Audio in

PC audio jack x 1

RCA audio jack (L/R) x 1

Environmental Requirements

Operating temperature

0°C-40°C at sea level

Operating relative humidity

10%-90% (without condensation)

Operating altitude

0-1499 m at 0°C-35°C

1500-5000 m at 0°C-30°C (with High

Altitude Mode on)

Storage temperature

-20°C-60°C

Storage humidity

10%-90% RH (without condensation)

Note:

Notes: All specifications are subject to change without notice.

Dimensions

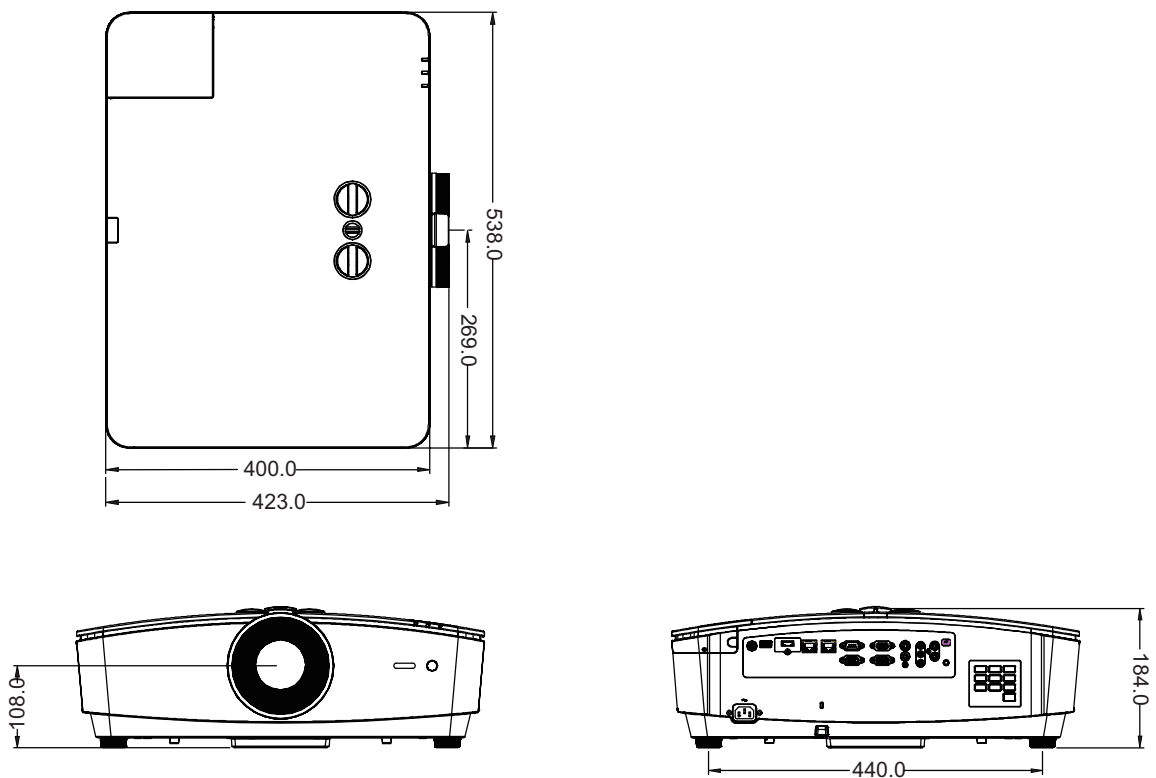

Ceiling mount installation

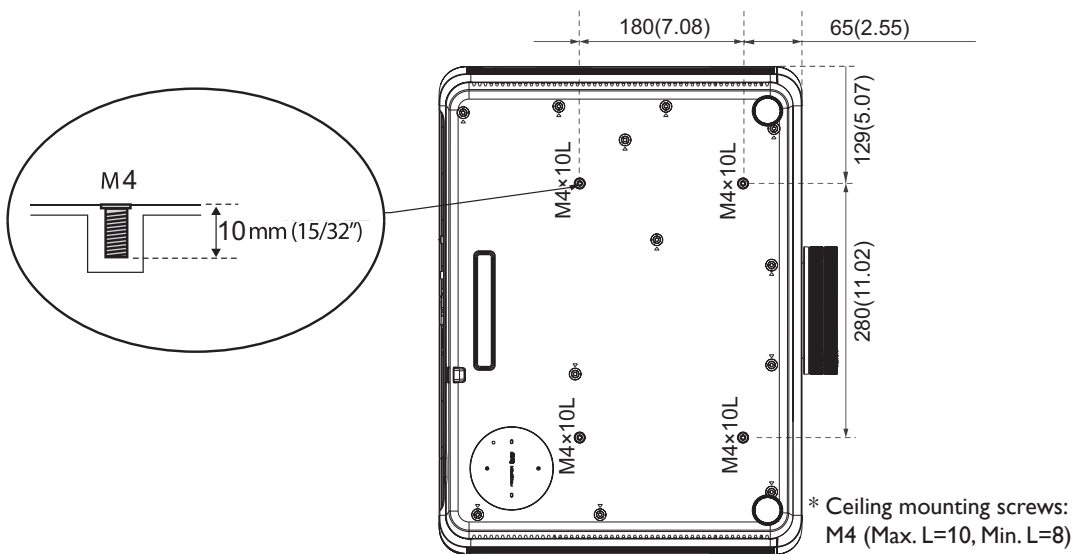

Appendix

Timing chart

Supported timing for PC/PC2 input

Resolution	Mode	Refresh Rate (Hz)	Horizontal Frequency (kHz)	Clock (MHz)	3D Field Sequential	3D Top-Bottom	3D Side by Side
720 x 400	720 x 400_70	70.087	31.469	28.3221			
640 x 480	VGA_60	59.940	31.469	25.175	⊙	⊙	⊙
	VGA_72	72.809	37.861	31.500			
	VGA_75	75.000	37.500	31.500			
	VGA_85	85.008	43.269	36.000			
800 x 600	SVGA_60	60.317	37.879	40.000	⊙	⊙	⊙
	SVGA_72	72.188	48.077	50.000			
	SVGA_75	75.000	46.875	49.500			
	SVGA_85	85.061	53.674	56.250			
	SVGA_120 (Reduce Blanking)	119.854	77.425	83.000	⊙		
1024 x 768	XGA_60	60.004	48.363	65.000	⊙	⊙	⊙
	XGA_70	70.069	56.476	75.000			
	XGA_75	75.029	60.023	78.750			
	XGA_85	84.997	68.667	94.500			
	XGA_120 (Reduce Blanking)	119.989	97.551	115.500	⊙		
1152 x 864	1152 x 864_75	75.000	67.500	108.000			
1024 x 576	BenQ NB Timing	60.000	35.820	46.966			
1024 x 600	BenQ NB Timing	64.995	41.467	51.419			
1280 x 720	1280 x 720_60	60.000	45.000	74.250	⊙	⊙	⊙
1280 x 768	1280 x 768_60	59.870	47.776	79.500	⊙	⊙	⊙
1280 x 800	WXGA_60	59.810	49.702	83.500	⊙	⊙	⊙
	WXGA_75	74.934	62.795	106.500			
	WXGA_85	84.880	71.554	122.500			
	WXGA_120 (Reduce Blanking)	119.909	101.563	146.250	⊙		
1280 x 1024	SXGA_60	60.020	63.981	108.000		⊙	⊙
	SXGA_75	75.025	79.976	135.000			
	SXGA_85	85.024	91.146	157.500			
1280 x 960	1280 x 960_60	60.000	60.000	108.000		⊙	⊙
	1280 x 960_85	85.002	85.938	148.500			

Resolution	Mode	Refresh Rate (Hz)	Horizontal Frequency (kHz)	Clock (MHz)	3D Field Sequential	3D Top-Bottom	3D Side by Side
1360 x 768	1360 x 768_60	60.015	47.712	85.500		⊙	⊙
1440 x 900	WXGA+_60	59.887	55.935	106.500		⊙	⊙
1400 x 1050	SXGA+_60	59.978	65.317	121.750		⊙	⊙
1600 x 1200	UXGA	60.000	75.000	162.000		⊙	⊙
1680 x 1050	1680 x 1050_60	59.954	65.290	146.250		⊙	⊙
640 x 480@67Hz	MAC13	66.667	35.000	30.240			
832 x 624@75Hz	MAC16	74.546	49.722	57.280			
1024 x 768@75Hz	MAC19	74.930	60.241	80.000			
1152 x 870@75Hz	MAC21	75.060	68.680	100.000			

 **Note:**

The timings showing above may not be supported due to EDID file and VGA graphic card limitations. It is possible that user cannot choose the above 3D timings on VGA display card.

Supported timing for Component-YPbPr input

Timing	Resolution	Horizontal Frequency (KHz)	Vertical Frequency (Hz)	Dot Clock Frequency (MHz)	3D Field Sequential
480i	720 x 480	15.73	59.94	13.50	⊙
480p	720 x 480	31.47	59.94	27.00	⊙
576i	720 x 576	15.63	50.00	13.50	
576p	720 x 576	31.25	50.00	27.00	
720/50p	1280 x 720	37.50	50.00	74.25	
720/60p	1280 x 720	45.00	60.00	74.25	⊙
1080/50i	1920 x 1080	28.13	50.00	74.25	
1080/60i	1920 x 1080	33.75	60.00	74.25	
1080/24p	1920 x 1080	27.00	24.00	74.25	
1080/25p	1920 x 1080	28.13	25.00	74.25	
1080/30p	1920 x 1080	33.75	30.00	74.25	
1080/50p	1920 x 1080	56.25	50.00	148.50	
1080/60p	1920 x 1080	67.50	60.00	148.50	

Supported timing for VIDEO/S-VIDEO input

Video mode	Horizontal Frequency (KHz)	Vertical Frequency (Hz)	Sub-carrier Frequency (MHz)	3D Field Sequential
NTSC	15.73	60	3.58	⊙
PAL	15.63	50	4.43	
SECAM	15.63	50	4.25 or 4.41	
PAL-M	15.73	60	3.58	
PAL-N	15.63	50	3.58	
PAL-60	15.73	60	4.43	
NTSC4.43	15.73	60	4.43	

Supported timing for HDMI/DVI-D (HDCP) input

Resolution	Mode	Refresh Rate (Hz)	Horizontal Frequency (KHz)	Clock (MHz)	3D Field Sequential	3D Top-Bottom	3D Side by Side
640 x 480	VGA_60	59.940	31.469	25.175	⊙	⊙	⊙
	VGA_72	72.809	37.861	31.500			
	VGA_75	75.000	37.500	31.500			
	VGA_85	85.008	43.269	36.000			
720 x 400	720 x 400_70	70.087	31.469	28.3221			
800 x 600	SVGA_60	60.317	37.879	40.000	⊙	⊙	⊙
	SVGA_72	72.188	48.077	50.000			
	SVGA_75	75.000	46.875	49.500			
	SVGA_85	85.061	53.674	56.250			
	SVGA_120 (Reduce Blanking)	119.854	77.425	83.000	⊙		
1024 x 768	XGA_60	60.004	48.363	65.000	⊙	⊙	⊙
	XGA_70	70.069	56.476	75.000			
	XGA_75	75.029	60.023	78.750			
	XGA_85	84.997	68.667	94.500			
	XGA_120 (Reduce Blanking)	119.989	97.551	115.500	⊙		
1152 x 864	1152 x 864_75	75.000	67.500	108.000			
1024 x 576	BenQ NBTiming	60.000	35.820	46.996			
1024 x 600	BenQ NBTiming	64.995	41.467	51.419			
1280 x 720	1280 x 720_60	60.000	45.000	74.250	⊙	⊙	⊙
1280 x 768	1280 x 768_60	59.870	47.776	79.500	⊙	⊙	⊙

Resolution	Mode	Refresh Rate (Hz)	Horizontal Frequency (KHz)	Clock (MHz)	3D Field Sequential	3D Top-Bottom	3D Side by Side
1280 x 800	WXGA_60	59.810	49.702	83.500	⊙	⊙	⊙
	WXGA_75	74.934	62.795	106.500			
	WXGA_85	84.880	71.554	122.500			
	WXGA_120 (Reduce Blanking)	119.909	101.563	146.250	⊙		
1280 x 1024	SXGA_60	60.020	63.981	108.000		⊙	⊙
	SXGA_75	75.025	79.976	135.000			
	SXGA_85	85.024	91.146	157.500			
1280 x 960	1280 x 960_60	60.000	60.000	108.000		⊙	⊙
	1280 x 960_85	85.002	85.938	148.500			
1360 x 768	1360 x 768_60	60.015	47.712	85.500		⊙	⊙
1440 x 900	WXGA+_60	59.887	55.935	106.500		⊙	⊙
1400 x 1050	SXGA+_60	59.978	65.317	121.750		⊙	⊙
1600 x 1200	UXGA	60.000	75.000	162.000		⊙	
1680 x 1050	1680 x 1050_60	59.954	65.290	146.250		⊙	⊙
640 x 480@67Hz	MAC13	66.667	35.000	30.240			
832 x 624@75Hz	MAC16	74.546	49.722	57.280			
1024 x 768@75Hz	MAC19	75.020	60.241	80.000			
1152 x 870@75Hz	MAC21	75.060	68.680	100.000			
1920 x 1080@60Hz	1920 x 1080_60	60.000	67.500	148.500		⊙	⊙
1920 x 1200@60Hz	1920 x 1200_60 (Reduce Blanking)	59.950	74.038	154.000		⊙	⊙

 **Note:**

The timings showing above may not be supported due to EDID file and VGA graphic card limitations. It is possible that user cannot choose the above timings on VGA display card.

Supporting timing for HDMI Video input

Timing	Resolution	Horizontal Frequency (KHz)	Vertical Frequency (Hz)	Dot Clock Frequency (MHz)	3D Field Sequential	3D Frame Packing	3D Top-Bottom	3D Side by Side
480i	720 (1440) x 480	15.73	59.94	27.00	⊙			
480p	720 x 480	31.47	59.94	27.00	⊙			
576i	720 (1440) x 576	15.63	50.00	27.00				
576p	720 x 576	31.25	50.00	27.00				
720/50p	1280 x 720	37.50	50.00	74.25		⊙	⊙	⊙
720/60p	1280x720	45.00	60.00	74.25	⊙	⊙	⊙	⊙
1080/24p	1920 x 1080	27.00	24.00	74.25		⊙	⊙	⊙
1080/25p	1920 x 1080	28.13	25.00	74.25				
1080/30p	1920 x 1080	33.75	30.00	74.25				
1080/50i	1920 x 1080	28.13	50.00	74.25				⊙
1080/60i	1920 x 1080	33.75	60.00	74.25				⊙
1080/50p	1920 x 1080	56.25	50.00	148.50			⊙	⊙
1080/60p	1920 x 1080	67.50	60.00	148.50			⊙	⊙

PJLink

PJLink protocol

The network function of this projector supports PJLink class 1. The PJLink protocol can be used to carry out projector settings from the computer and lookup and operate the projector status.

Control command

The following list shows PJLink protocol commands for projector control.

Command	Control details	Parameter/ Return string	Note		
POWR	Power supply control	0 1	Standby Power on		
POWR?	Power supply status query	0 1	Standby Power on		
INPT	Input selection	11 21	PC1/YPbPr VIDEO S-VIDEO HDMI1 HDMI2/MHL		
INPT?	Input status query	22 31 32			
AVMT	Mute	11	Video mute On Video mute Off Audio mute On Audio mute Off Video & Audio mute On Video & Audio mute Off		
AVMT?	Mute query	10 21 20 31 30			
ERST?	Error status query	xxxxxxx	1st byte	<ul style="list-style-type: none"> 0=No error is detected 1=Warning 2=Error 	
			2nd byte		Indicates light source errors, and returns 0-2
			3rd byte		Indicates temperature errors, and returns 0-2
			4th byte		Return 0
			5th byte		Return 0
			6th byte		Indicates other errors, and returns 0-2
LAMP?	Light source status query	xxxxxxxxxxxxx	1st number (1-5 digitals): Light source 1 runtime		
INST?	Input selection list query	11 21 22 31 32	SX751/SW752/SH753/SU754		
NAME?	Projector name query	xxxxxx	Returns the name set in [PROJECTOR NAME] of [NETWORK SETUP]		
INF1?	Manufacturer name query	BenQ	Returns manufacturer name		

Command	Control details	Parameter/ Return string	Note
INF2?	Model name query	SX751/SW752/ SH753/SU754	Returns model name
INF0?	Other information queries	xxxxx	Returns information such as version number
CLASS?	Class information query	1	Returns class for PLink