

# Quick Reference

## Copying

### Making copies

- 1 Load an original document into the ADF tray or on the scanner glass.  
**Note:** To avoid a cropped image, make sure that the original document and output have the same paper size.
- 2 From the home screen, touch **Copy**, and then specify the number of copies.  
If necessary, adjust the copy settings.
- 3 Copy the document.

**Note:** To make a quick copy, from the control panel, press .

### Copying on both sides of the paper (two-sided)

- 1 Load an original document into the ADF tray or on the scanner glass.
- 2 From the home screen, touch **Copy > Settings > Paper Setup**.
- 3 Adjust the settings.
- 4 Copy the document.

### Copying multiple pages onto a single sheet

- 1 Load an original document into the ADF tray or on the scanner glass.
- 2 From the home screen, touch **Copy > Pages per Side**.
- 3 Adjust the settings.
- 4 Copy the document.

## Faxing

### Sending a fax

#### Using the control panel

- 1 Load the original document into the ADF tray or on the scanner glass.
- 2 From the home screen, touch **Fax**, and then enter the needed information.
- 3 If necessary, configure other fax settings.
- 4 Send the fax job.

#### Using the computer

##### For Windows users

- 1 With a document open, click **File > Print**.
- 2 Select the printer, and then click **Properties, Preferences, Options, or Setup**.
- 3 Click **Fax > Enable fax**, and then enter the recipient number.
- 4 If necessary, configure other fax settings.
- 5 Send the fax job.

##### For Macintosh users

- 1 With a document open, choose **File > Print**.
- 2 Select the printer and enter the recipient number.
- 3 If necessary, configure other fax settings.
- 4 Send the fax job.

## E-mailing

### Sending an e-mail

#### Using the control panel

- 1 Load an original document into the ADF tray or on the scanner glass.

- 2 From the home screen, touch **E-mail**, and then enter the needed information.  
**Note:** You can also enter the recipient using the address book or shortcut number.

- 3 If necessary, configure the output file type settings.
- 4 Send the e-mail.

#### Using the shortcut number

- 1 From the control panel, press **#**, and then enter the shortcut number using the keypad.
- 2 Send the e-mail.

## Loading paper

### Loading trays

 **CAUTION—TIPPING HAZARD:** To reduce the risk of equipment instability, load each tray separately. Keep all other trays closed until needed.

- 1 Remove the tray.

**Note:** To avoid paper jams, do not remove trays while the printer is busy.



**2** Adjust the paper guides to match the size of the paper that you are loading.

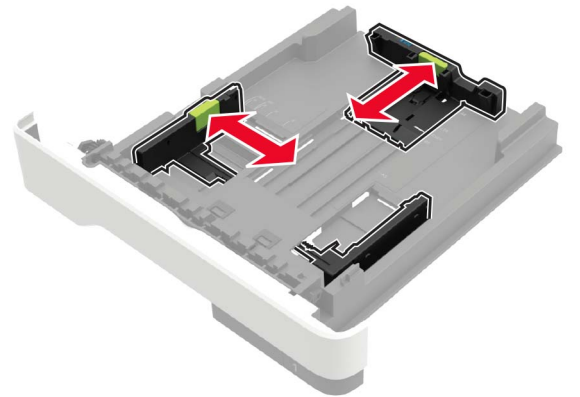

**3** Flex, fan, and align the paper edges before loading.

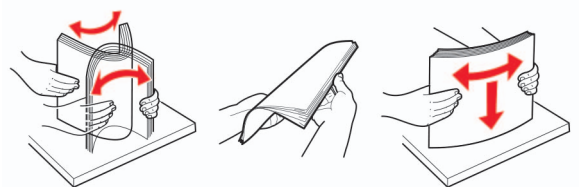

**4** Load the paper stack with the printable side facedown, and then make sure that the side guides fit snugly against the paper.

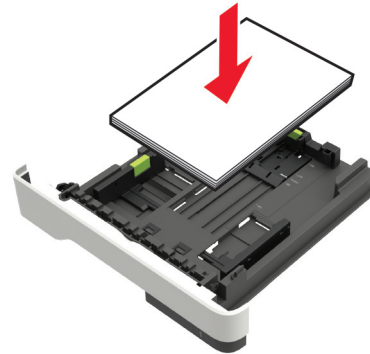

**Notes:**

- Load letterhead facedown with the top edge of the sheet toward the front of the tray for one-sided printing.
- Load letterhead faceup with the bottom edge of the sheet toward the front of the tray for two-sided printing.
- Do not slide paper into the tray.
- To avoid paper jams, make sure that the stack height is below the maximum paper fill indicator.

**5** Insert the tray.

If necessary, set the paper size and paper type from the control panel to match the paper loaded.

## Loading the multipurpose feeder

**1** Open the multipurpose feeder.

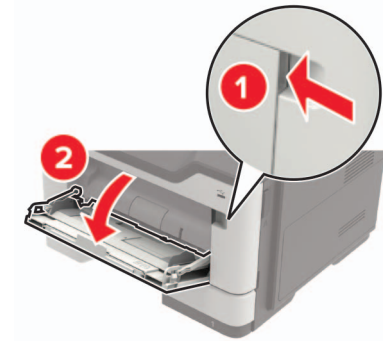

**2** Adjust the guide to match the size of the paper that you are loading.

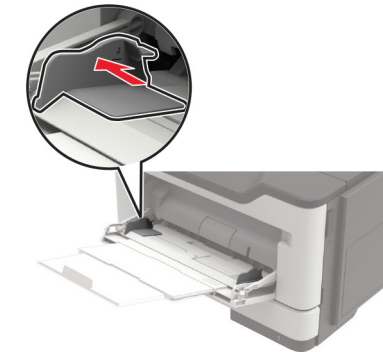

- 3 Flex, fan, and align the paper edges before loading.

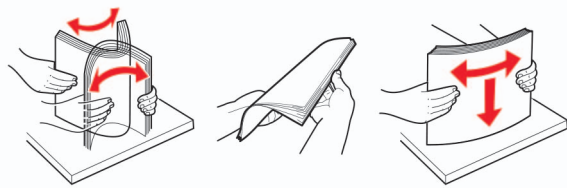

- 4 Load paper with the printable side faceup.

**Notes:**

- Load letterhead faceup with the top edge of the sheet toward the front of the tray for one-sided printing.
- Load letterhead facedown with the bottom edge of the sheet toward the front of the tray for two-sided printing.
- Load envelopes with the flap facedown on the left side.
- Load European envelopes with the flap facedown and entering the printer first.

**Warning—Potential Damage:** Do not use envelopes with stamps, clasps, snaps, windows, coated linings, or self-stick adhesives.

- 5 From the control panel, set the paper size and paper type to match the paper loaded.

## Setting the size and type of the specialty media

The trays automatically detect the size of plain paper. For specialty media like labels, card stock, or envelopes, do the following:

- 1 From the home screen, navigate to:  
**Settings > Paper > Tray Configuration > Paper Size/Type >** select a paper source
- 2 Set the size and type of the specialty media.

## Printing

### Printing from a computer

**Note:** For labels, card stock, and envelopes, set the paper size and paper type in the printer before printing the document.

- 1 From the document that you are trying to print, open the Print dialog.
- 2 If necessary, adjust the settings.
- 3 Print the document.

**Note:** For details of the function of the printer driver, refer to the Help of the printer driver.

## Maintaining the printer

### Replacing the toner cartridge

- 1 Open door A.

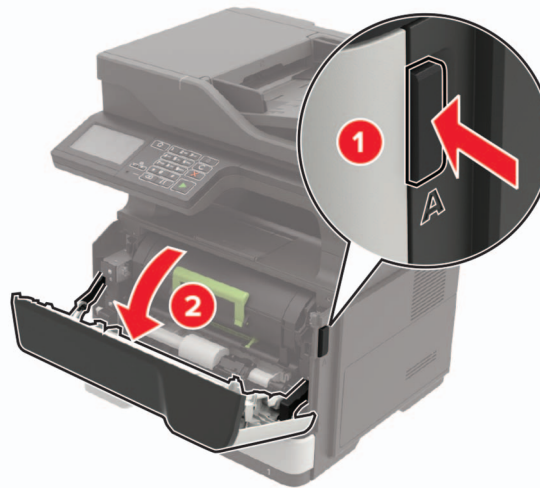

- 2 Remove the used toner cartridge.

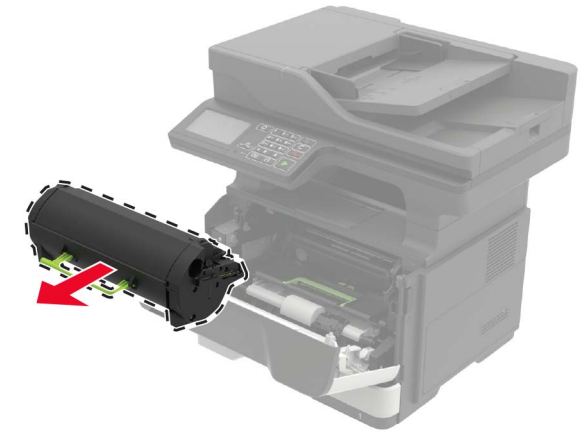

- 3 Unpack the new toner cartridge, and then shake it three times to redistribute the toner.

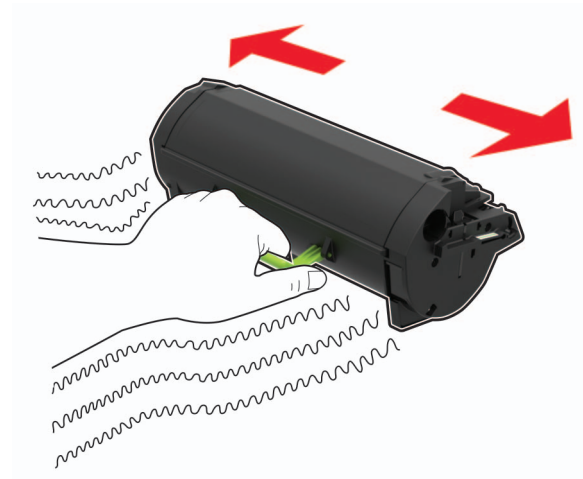

- 4 Insert the new toner cartridge.

**Note:** Use the arrows inside the printer as guides.



5 Close door A.

## Replacing the imaging unit

1 Open door A.

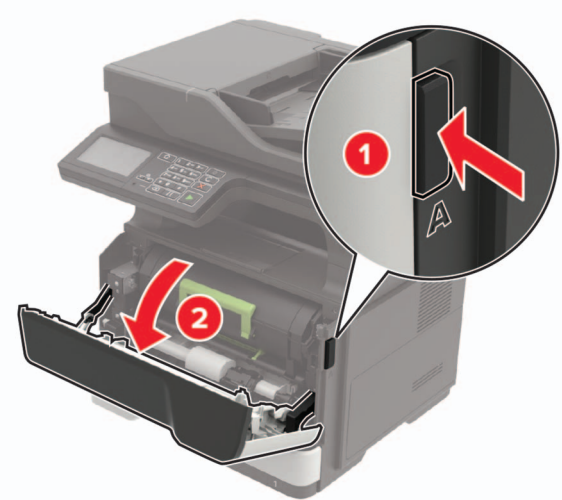

2 Remove the toner cartridge.

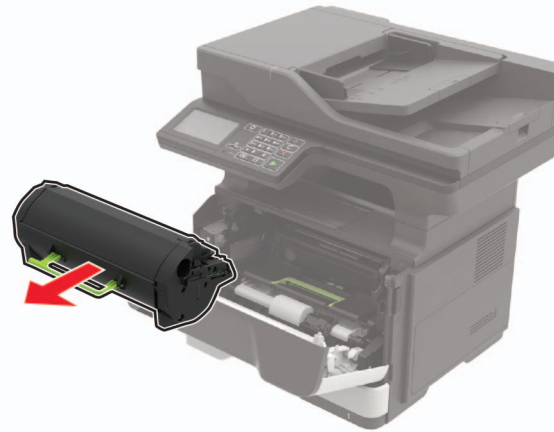

3 Remove the used imaging unit.

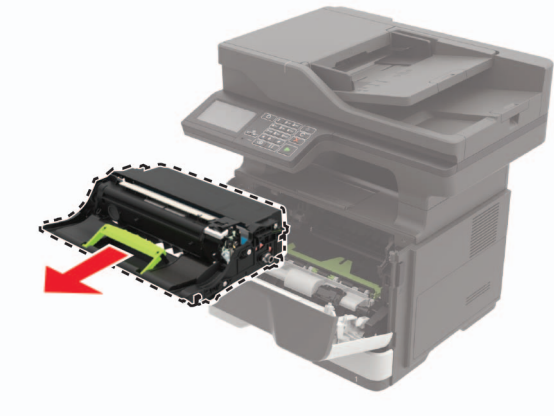

4 Unpack the new imaging unit, and then shake it three times to redistribute the toner.

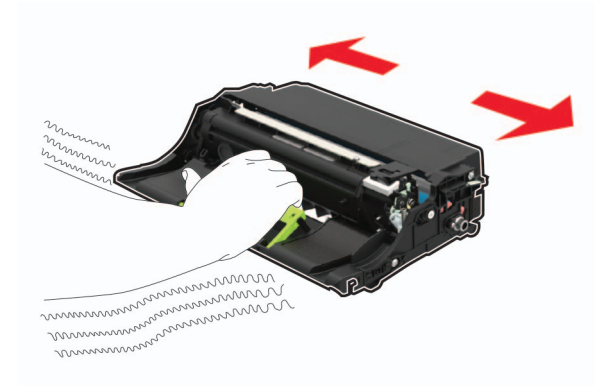

**Warning—Potential Damage:** Do not expose the imaging unit to direct light for more than 10 minutes. Extended exposure to light may cause print quality problems.

**Warning—Potential Damage:** Do not touch the photoconductor drum. Doing so may affect the quality of future print jobs.



5 Insert the new imaging unit.

**Note:** Use the arrows inside the printer as guides.

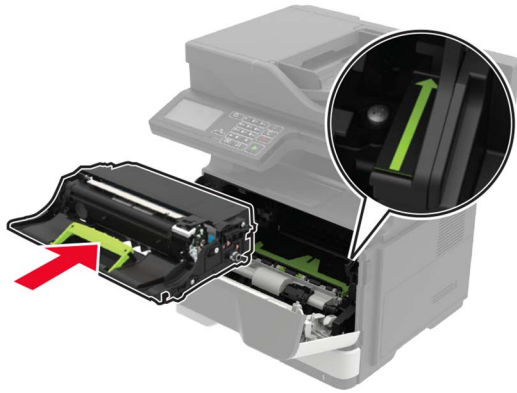

6 Insert the toner cartridge.

**Note:** Use the arrows inside the printer as guides.



7 Close door A.

## Clearing jams

### Avoiding jams

#### Load paper properly

- Make sure that the paper lies flat in the tray.

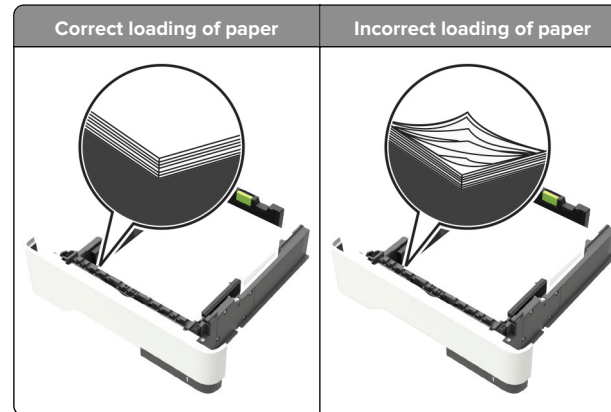

- Do not load or remove a tray while the printer is printing.
- Do not load too much paper. Make sure that the stack height is below the maximum paper fill indicator.

- Do not slide paper into the tray. Load paper as shown in the illustration.

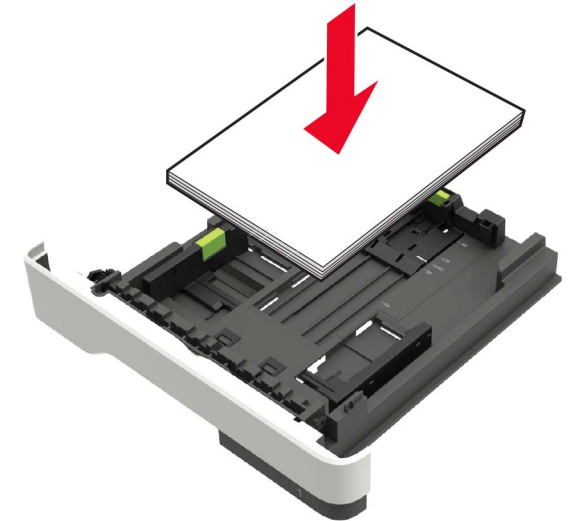

- Make sure that the paper guides are positioned correctly and are not pressing tightly against the paper or envelopes.
- Push the tray firmly into the printer after loading paper.

#### Use recommended paper

- Use only recommended paper or specialty media.
- Do not load paper that is wrinkled, creased, damp, bent, or curled.
- Flex, fan, and align the paper edges before loading.

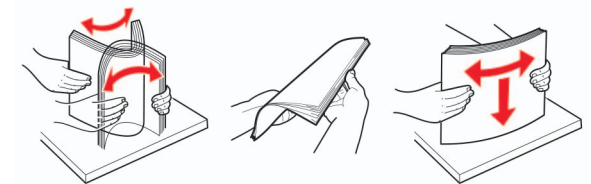

- Do not use paper that has been cut or trimmed by hand.
- Do not mix paper sizes, weights, or types in the same tray.
- Make sure that the paper size and type are set correctly on the computer or printer control panel.
- Store paper according to manufacturer recommendations.

## Identifying jam locations

### Notes:

- When Jam Assist is set to On, the printer automatically flushes blank pages or partially printed pages with after a jammed page is cleared. Check your printed output for blank pages.
- When Jam Recovery is set to On or Auto, the printer reprints jammed pages.

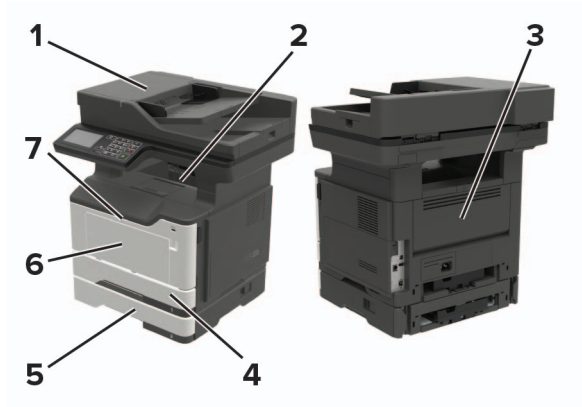

	Jam location
1	Automatic document feeder
2	Standard bin
3	Rear door
4	Standard 250-sheet tray
5	Optional 250- or 550-sheet tray
6	Multipurpose feeder
7	Door A

## Paper jam in door A

1 Remove the tray.



2 Open door A.

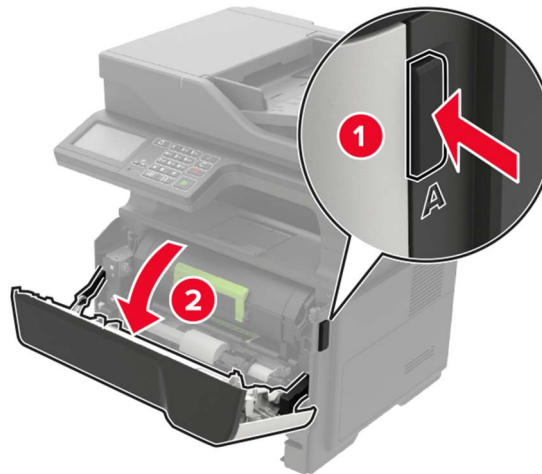

3 Remove the toner cartridge.

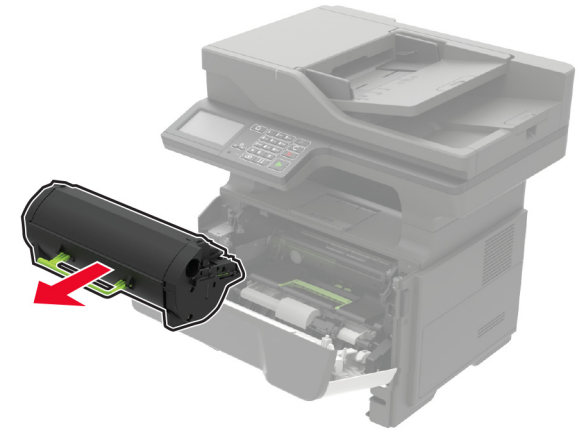

4 Remove the imaging unit.

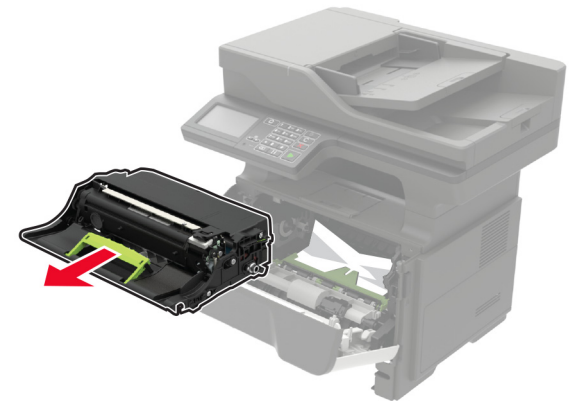

**Warning—Potential Damage:** Do not expose the imaging unit to direct light for more than 10 minutes. Extended exposure to light may cause print quality problems.

**Warning—Potential Damage:** Do not touch the photoconductor drum. Doing so may affect the quality of future print jobs.



5 Remove the jammed paper.

**CAUTION—HOT SURFACE:** The inside of the printer might be hot. To reduce the risk of injury from a hot component, allow the surface to cool before touching it.

**Note:** Make sure that all paper fragments are removed.

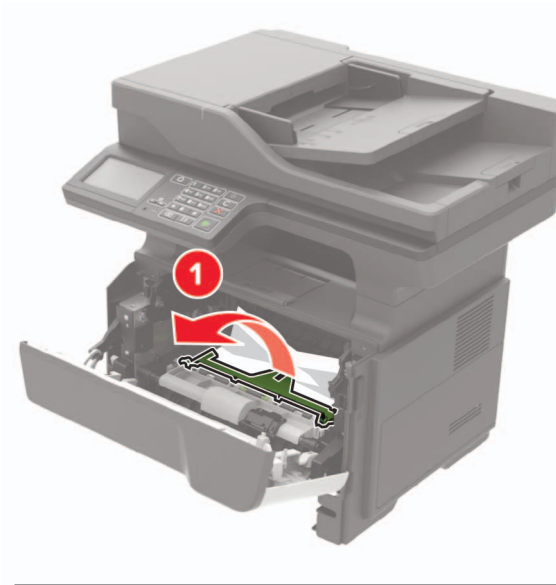

6 Insert the imaging unit.

**Note:** Use the arrows inside the printer as guides.

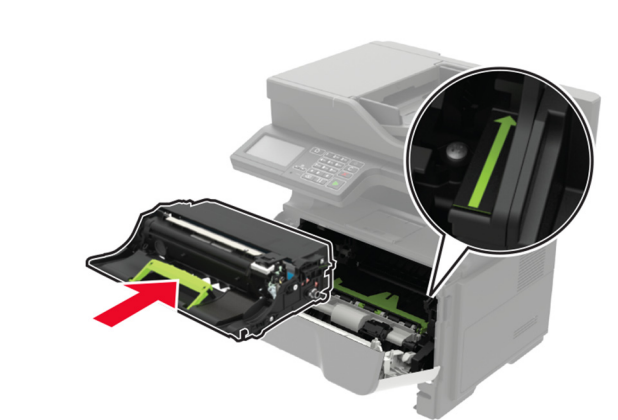
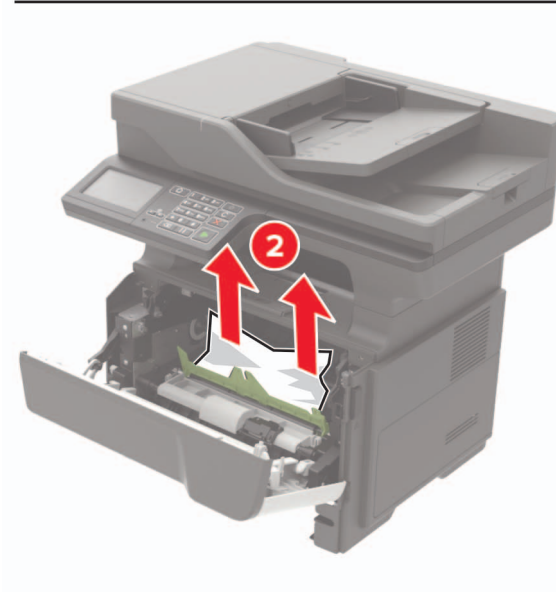

7 Insert the toner cartridge.

**Note:** Use the arrows inside the printer as guides.

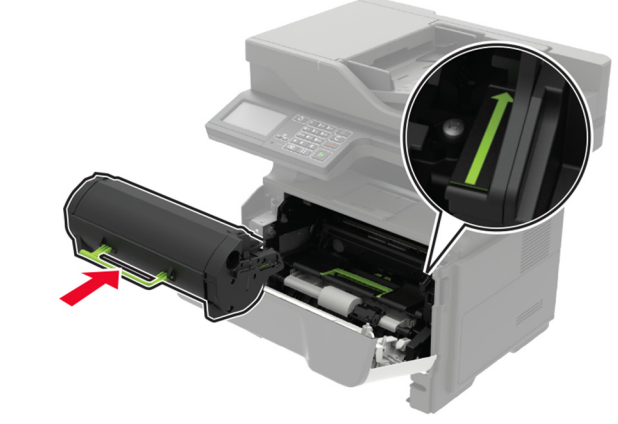

8 Close door A.

9 Insert the tray.

### Paper jam in the rear door

1 Open the rear door.

 **CAUTION—HOT SURFACE:** The inside of the printer might be hot. To reduce the risk of injury from a hot component, allow the surface to cool before touching it.

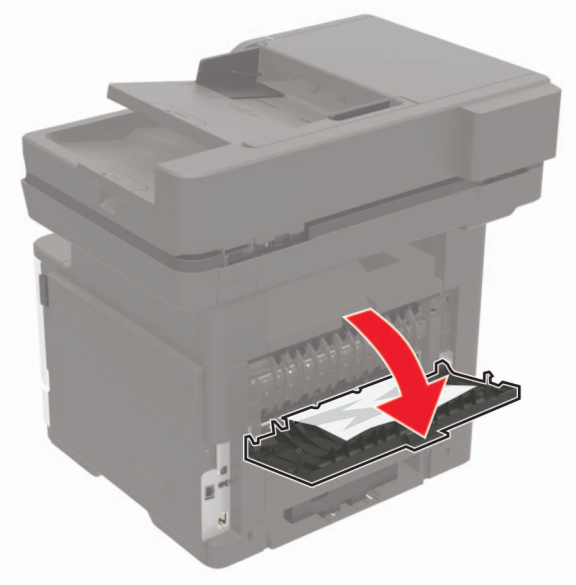

**2** Remove the jammed paper.

**Note:** Make sure that all paper fragments are removed.

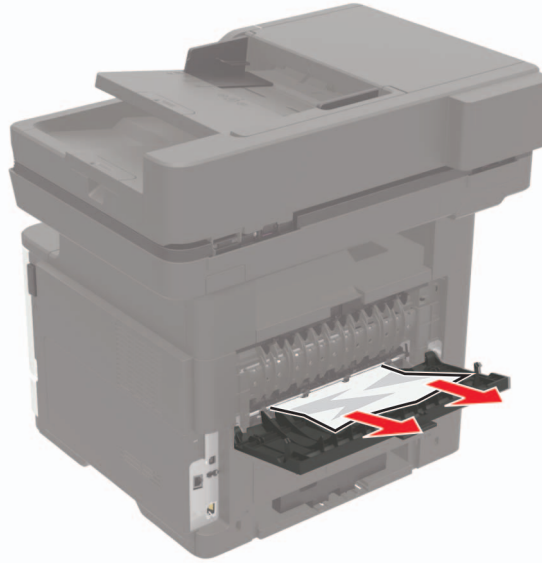

**3** Close the rear door.

### Paper jam in the standard bin

Remove the jammed paper.

**Note:** Make sure that all paper fragments are removed.



### Paper jam in the duplex unit

**1** Remove the tray.



**2** Remove the jammed paper.

**Note:** Make sure that all paper fragments are removed.

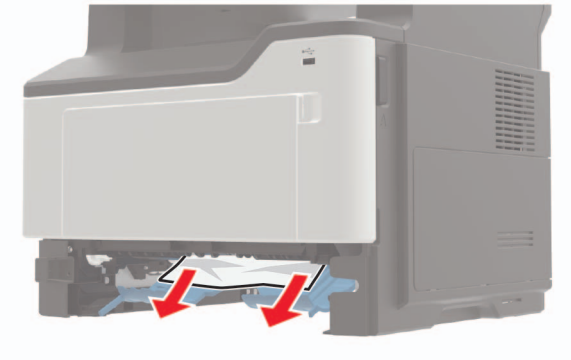

**3** Insert the tray.



## Paper jam in trays

- 1 Remove the tray.



- 2 Remove the jammed paper.

**Note:** Make sure that all paper fragments are removed.

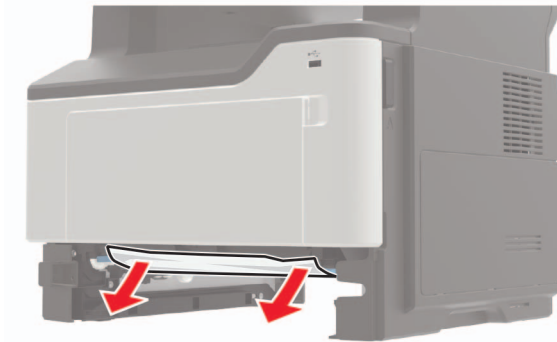

- 3 Insert the tray.

## Paper jam in the multipurpose feeder

- 1 Remove paper from the multipurpose feeder.

- 2 Remove the jammed paper.

**Note:** Make sure that all paper fragments are removed.

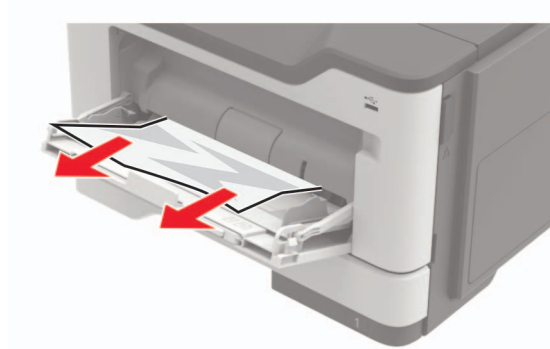

- 3 Flex, fan, and align the paper edges before loading.

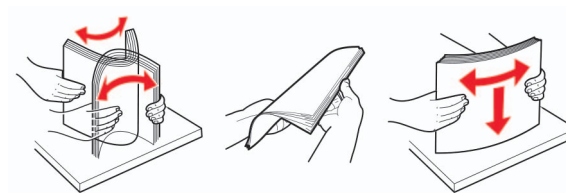

- 4 Reload paper, and then adjust the paper guide.



## Paper jam in the automatic document feeder

- 1 Remove all original documents from the ADF tray.

- 2 Open the ADF cover.

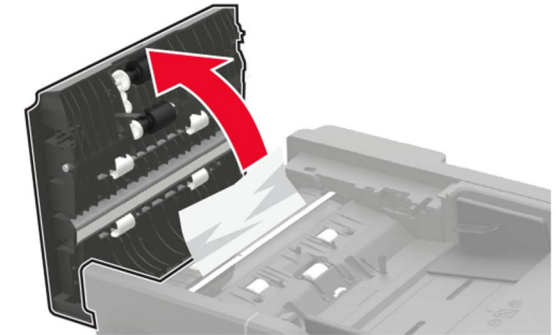

- 3 Remove the jammed paper.

**Note:** Make sure that all paper fragments are removed.

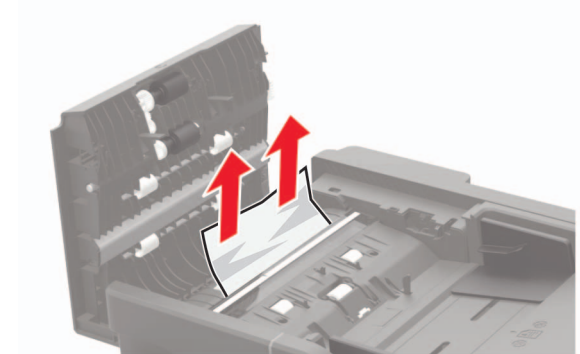

- 4 Close the ADF cover.