

**PowerLite**<sup>®</sup>  
**1970W/1975W/1980WU/1985WU**  
**User's Guide**



---

# Contents

<b>PowerLite 1970W/1975W/1980WU/1985WU User's Guide</b> .....	<b>9</b>
<b>Introduction to Your Projector</b> .....	<b>10</b>
Projector Features.....	10
Product Box Contents.....	11
Additional Components .....	13
Optional Equipment and Replacement Parts.....	13
Warranty and Registration Information .....	14
Notations Used in the Documentation .....	15
Where to Go for Additional Information .....	15
Projector Part Locations .....	15
Projector Parts - Front/Top .....	16
Projector Parts - Rear .....	17
Projector Parts - Base.....	18
Projector Parts - Control Panel .....	19
Projector Parts - Remote Control.....	20
<b>Setting Up the Projector</b> .....	<b>22</b>
Projector Placement.....	22
Projector Setup and Installation Options .....	22
Projection Distance.....	24
Projector Connections .....	25
Connecting to Computer Sources.....	26
Connecting to a Computer for USB Video and Audio.....	26
Connecting to a Computer for VGA Video.....	27
Connecting to a Computer for HDMI Video and Audio .....	28
Connecting to a Computer for USB Mouse Control.....	28
Connecting to a Computer for Sound.....	29
Connecting to Video Sources .....	29
Connecting to an HDMI Video Source .....	29
Connecting to an MHL-Compatible Device .....	30
Connecting to a Component-to-VGA Video Source .....	31

Connecting to a Composite Video Source .....	31
Connecting to a Video Source for Sound .....	32
Connecting to an External Computer Monitor .....	32
Connecting to External Speakers .....	33
Connecting to External USB Devices .....	34
USB Device Projection .....	34
Connecting a USB Device or Camera to the Projector .....	35
Selecting the Connected USB Source .....	35
Disconnecting a USB Device or Camera From the Projector .....	35
Connecting to a Document Camera .....	36
Installing Batteries in the Remote Control .....	36
Opening the Lens Cover .....	38
<b>Using the Projector on a Network .....</b>	<b>40</b>
Wired Network Projection .....	40
Connecting to a Wired Network .....	41
Selecting Wired Network Settings .....	41
Wireless Network Projection .....	43
Installing the Wireless LAN Module .....	45
Using Quick Wireless Connection (Windows Only) .....	47
Selecting Wireless Network Settings Manually .....	47
Wireless LAN Menu Settings .....	50
Searching for a Wireless Network .....	51
Selecting Wireless Network Settings in Windows .....	53
Selecting Wireless Network Settings in OS X .....	53
Setting Up Wireless Network Security .....	54
Wireless Security Menu Settings .....	55
Wireless Network Projection from a Mobile Device (Screen Mirroring) .....	55
Screen Mirroring Restrictions .....	56
Selecting Screen Mirroring Settings .....	56
Connecting for Screen Mirroring Using Windows 8.1 .....	57
Connecting for Screen Mirroring Using Windows 7/Windows 8 .....	58
Connecting for Screen Mirroring with Miracast .....	59
Setting Up Projector Network E-Mail Alerts .....	59

Network Projector E-mail Alert Messages .....	61
Setting Up Monitoring Using SNMP .....	61
Controlling a Networked Projector Using a Web Browser .....	62
Crestron RoomView Support.....	64
Setting Up Crestron RoomView Support .....	64
Controlling a Networked Projector Using Crestron RoomView .....	65
<b>Using Basic Projector Features .....</b>	<b>67</b>
Turning On the Projector .....	67
Turning Off the Projector .....	69
Selecting the Language for the Projector Menus.....	71
Adjusting the Image Height .....	72
Image Shape.....	74
Automatically Correcting Image Shape With Screen Fit .....	74
Correcting Image Shape with the Keystone Buttons.....	75
Correcting Image Shape with Quick Corner .....	76
Resizing the Image With the Zoom Ring .....	78
Focusing the Image Using the Focus Ring.....	79
Focusing the Image with Focus Help.....	79
Remote Control Operation .....	81
Using the Remote Control as a Wireless Mouse .....	83
Using the Remote Control as a Pointer.....	84
Selecting an Image Source .....	84
Projection Modes .....	86
Changing the Projection Mode Using the Remote Control .....	86
Changing the Projection Mode Using the Menus.....	87
Image Aspect Ratio .....	87
Changing the Image Aspect Ratio .....	88
Available Image Aspect Ratios .....	88
Color Mode.....	89
Changing the Color Mode.....	89
Available Color Modes.....	90
Turning On Auto Iris.....	91
Controlling the Volume with the Volume Buttons.....	92

Projecting a PC Free Presentation .....	92
Supported PC Free File Types .....	92
Starting a PC Free Slide Show .....	94
Starting a PC Free PDF File Presentation .....	95
Starting a PC Free Movie Presentation .....	97
PC Free Display Options .....	98
<b>Adjusting Projector Features .....</b>	<b>100</b>
Shutting Off the Picture and Sound Temporarily .....	100
Stopping Video Action Temporarily .....	101
Zooming Into and Out of Images .....	101
Projector Security Features.....	102
Password Security Types .....	102
Setting a Password .....	103
Selecting Password Security Types.....	104
Entering a Password to Use the Projector.....	105
Saving a User's Logo Image to Display.....	106
Locking the Projector's Buttons .....	108
Unlocking the Projector's Buttons .....	109
Installing a Security Cable .....	109
Projector Identification System for Multiple Projector Control.....	109
Setting the Projector ID.....	110
Setting the Remote Control ID.....	111
Matching Multiple-Projector Display Quality .....	111
Projecting Two Images Simultaneously.....	113
Scheduling Projector Events .....	114
Saving a Scheduled Event.....	114
Viewing Scheduled Events .....	115
Editing a Scheduled Event.....	116
<b>Adjusting the Menu Settings .....</b>	<b>118</b>
Using the Projector's Menus.....	118
Image Quality Settings - Image Menu .....	119
Input Signal Settings - Signal Menu.....	121
Projector Feature Settings - Settings Menu.....	124

Projector Setup Settings - Extended Menu.....	126
Projector Network Settings - Network Menu.....	130
Projector Setup Settings - ECO Menu.....	132
Projector Information Display - Info Menu .....	134
Event ID Code List.....	135
Projector Reset Options - Reset Menu.....	136
<b>Maintaining and Transporting the Projector .....</b>	<b>138</b>
Projector Maintenance .....	138
Cleaning the Lens.....	138
Cleaning the Projector Case.....	139
Air Filter and Vent Maintenance .....	139
Cleaning the Air Filter and Vents.....	140
Replacing the Air Filter.....	140
Projector Lamp Maintenance.....	142
Replacing the Lamp .....	143
Resetting the Lamp Timer.....	148
Replacing the Remote Control Batteries .....	149
Transporting the Projector.....	150
<b>Solving Problems .....</b>	<b>151</b>
Projection Problem Tips .....	151
Projector Light Status .....	152
Using the Projector Help Displays .....	155
Solving Image or Sound Problems .....	156
Solutions When No Image Appears.....	156
Solutions When Image is Incorrect Using the USB Display Function .....	157
Solutions When "No Signal" Message Appears.....	157
Displaying From a PC Laptop .....	158
Displaying From a Mac Laptop .....	158
Solutions When "Not Supported" Message Appears .....	159
Solutions When Only a Partial Image Appears.....	159
Solutions When the Image is Not Rectangular .....	160
Solutions When the Image Contains Noise or Static .....	160
Solutions When the Image is Fuzzy or Blurry .....	161

Solutions When the Image Brightness or Colors are Incorrect .....	162
Solutions to Sound Problems .....	163
Solving Projector or Remote Control Operation Problems .....	163
Solutions to Projector Power or Shut-Off Problems .....	164
Solutions to Problems with the Remote Control.....	164
Solutions to Password Problems .....	165
Solutions When You Cannot Access the Projector Through the Web .....	165
Solutions When Network Alert E-Mails are Not Received .....	166
Where to Get Help.....	166
<b>Technical Specifications .....</b>	<b>168</b>
General Projector Specifications .....	168
Projector Lamp Specifications.....	170
Remote Control Specifications .....	171
Projector Dimension Specifications.....	171
Projector Electrical Specifications .....	171
Projector Environmental Specifications.....	172
Projector Safety and Approvals Specifications.....	173
Supported Video Display Formats.....	173
USB Display System Requirements .....	176
<b>Notices .....</b>	<b>177</b>
Recycling.....	177
Important Safety Information .....	177
Important Safety Instructions.....	178
Restriction of Use .....	180
FCC Compliance Statement.....	181
Wireless Telegraphy Act Regulations.....	182
Trademarks .....	182
Open Source Software License.....	182
Copyright Notice.....	232
A Note Concerning Responsible Use of Copyrighted Materials.....	232
Copyright Attribution .....	232



---

# **PowerLite 1970W/1975W/1980WU/1985WU User's Guide**

Welcome to the PowerLite 1970W/1975W/1980WU/1985WU *User's Guide*.

---

# Introduction to Your Projector

Refer to these sections to learn more about your projector and this manual.

[Projector Features](#)

[Notations Used in the Documentation](#)

[Where to Go for Additional Information](#)

[Projector Part Locations](#)

## Projector Features

The PowerLite 1970W, 1975W, 1980WU, and 1985WU projectors include these special features:

### **Bright, high-resolution projection system**

- PowerLite 1980WU: Up to 4400 lumens of color brightness (color light output) and 4400 lumens of white brightness (white light output)

PowerLite 1985WU: Up to 4800 lumens of color brightness (color light output) and 4800 lumens of white brightness (white light output)

PowerLite 1970W/1975W: Up to 5000 lumens of color brightness (color light output) and 5000 lumens of white brightness (white light output)

**Note:** Color brightness (color light output) and white brightness (white light output) will vary depending on usage conditions. Color light output measured in accordance with IDMS 15.4; white light output measured in accordance with ISO 21118.

- PowerLite 1970W/1975W: Native resolution of 1280 × 800 pixels (WXGA)  
PowerLite 1980WU/1985WU: Native resolution of 1920 × 1080 pixels (WUXGA)

### **Flexible connectivity**

- Plug-and-play 3-in-1 USB projection, audio, and mouse control for instant setup
- Wired and wireless (PowerLite 1970W/1975W/1985WU) network support for projection, monitoring, and control via remote network computer
- HDMI 1/MHL and HDMI 2 ports for computer or video device connection
- WiDi and Miracast screen mirroring for laptops and mobile devices (PowerLite 1975W/1985WU)
- PC Free slide shows and presentations via connected USB memory devices or Epson document camera

- Dual VGA ports for connections by multiple presenters
- Ports for connecting an external monitor and external speakers

#### **Easy-to-use setup and operation features**

- Real-time, automatic vertical and horizontal keystone correction always displays a rectangular screen
- Epson's Instant Off and Direct Power On features for quick setup and shut down
- Screen Fit feature automatically resizes images for your projection screen
- Support for Crestron RoomView network monitoring systems
- Network message broadcast system to project timely messages to all networked projectors (Windows only)
- Powerful 10W speaker system

**Note:** Availability of models varies by country.

[Product Box Contents](#)

[Additional Components](#)

[Optional Equipment and Replacement Parts](#)

[Warranty and Registration Information](#)

**Parent topic:** [Introduction to Your Projector](#)

**Related concepts**

[Projector Part Locations](#)

## **Product Box Contents**

Save all the packaging in case you need to ship the projector. Always use the original packaging (or equivalent) when shipping.

Make sure your projector box included all of these parts:



- 1 Projector
- 2 Remote control
- 3 Remote control batteries (two AA alkaline)
- 4 Power cord
- 5 VGA computer cable
- 6 Projector documentation CD
- 7 Projector software CD

Parent topic: [Projector Features](#)

## Additional Components

Depending on how you plan to use the projector, you may need to obtain the following additional components:

- To receive a composite video signal, you need an RCA-style video or A/V cable. See your local computer or electronics dealer for purchase information.
- To receive a component video signal, you need a D-sub, 15-pin, component-to-VGA video cable. You can purchase one from Epson or an authorized Epson reseller.
- To receive an HDMI signal, you need a compatible HDMI cable. You can purchase one from Epson or an authorized Epson reseller.

**Note:** To connect a Mac that includes only a Mini DisplayPort, Thunderbolt port, or Mini-DVI port for video output, you need to obtain an adapter that allows you to connect to the projector's **HDMI** port. Contact Apple for compatible adapter options. Older Mac computers (2009 and earlier) may not support audio through the HDMI port.

- To receive an HDMI signal via MHL, you need an MHL-compatible device, an MHL cable or an HDMI cable and an MHL adapter compatible with your device. Devices with an integrated MHL connector may not require a cable.
- To project with audio from certain ports, you may need a commercially available audio cable compatible with your device. See your local computer or electronics dealer for purchase information.

**Parent topic:** [Projector Features](#)

## Optional Equipment and Replacement Parts

You can purchase screens, other optional accessories, and replacement parts from an Epson authorized reseller. To find the nearest reseller, call 800-GO-EPSON (800-463-7766). Or you can purchase online at [epsonstore.com](http://epsonstore.com) (U.S. sales) or [epson.ca](http://epson.ca) (Canadian sales).

Epson offers the following optional accessories and replacement parts for your projector:

Option or part	Part number
Genuine Epson Replacement lamp (ELPLP77)	V13H010L77
Air filter replacement (ELPAF41)	V13H134A41
Quick Wireless Connection USB Key (ELPAP09; PowerLite 1975W/1985WU)	V12H005M08
Wireless LAN module (ELPAP07; PowerLite 1975W/1985WU)	V12H418P12

Option or part	Part number
Epson DC-06 document camera (ELPDC06)	V12H321005
Epson DC-11 document camera	V12H377020
Epson DC-12 document camera (ELPDC12)	V12H594020
Epson DC-20 document camera (ELPDC20)	V12H500020
Accolade Duet portable projector screen	ELPSC80
Universal projector ceiling mount	ELPMBPJF
Adjustable suspended ceiling channel kit	ELPMBP01
False ceiling plate kit	ELPMBP02
Component-to-VGA video cable (ELPKC19)	V12H005C19
VGA video cable 1.8 m length	ELPKC02
VGA video cable 3.0 m length	ELPKC09
VGA video cable 20 m length	ELPKC10
Kensington security lock	ELPSL01
Soft carrying case	V12H001K65
1-Year Extended Service Program - Exchange Service	EPPEXPA1
1-Year Extended Service Program - Depot Repair Service	EPPFPA1
2-Year Extended Service Program - Depot Repair Service	EPPFPA2

Parent topic: [Projector Features](#)

## Warranty and Registration Information

Your projector comes with a basic warranty that lets you project with confidence. For details, see the warranty that came with your projector.

In addition, Epson offers free Extra Care Road Service. In the unlikely event of an equipment failure, you won't have to wait for your unit to be repaired. Instead, Epson will ship you a replacement unit anywhere in the United States, Canada, or Puerto Rico. See the Extra Care Road Service brochure for details.

Register your product online using the projector CD or at this site: [epson.com/webreg](http://epson.com/webreg).

Registering also lets you receive special updates on new accessories, products, and services.

Parent topic: [Projector Features](#)

## Notations Used in the Documentation

Follow the guidelines in these notations as you read your documentation:

- **Warnings** must be followed carefully to avoid bodily injury.
- **Cautions** must be observed to avoid damage to your equipment.
- **Notes** contain important information about your projector.
- **Tips** contain additional projection information.

Parent topic: [Introduction to Your Projector](#)

## Where to Go for Additional Information

Need quick help on using your projector? Here's where to look for help:

- [epson.com/support](http://epson.com/support) (U.S) or [epson.ca/support](http://epson.ca/support) (Canada)

View FAQs (frequently asked questions) and e-mail your questions to Epson technical support 24 hours a day.

- For detailed instructions on using your projector in a network environment, see the *EasyMP Network Projection Operation Guide*.
- For detailed instructions on monitoring your projector in a network environment (Windows only), see the *EasyMP Monitor Operation Guide*.
- For detailed instructions on using your projector to hold interactive meetings in a network environment, see the *EasyMP Multi PC Projection Operation Guide*.
- If you still need help after checking this manual and the sources listed above, you can use the Epson PrivateLine Support service to get help fast. For details, see "Where to Get Help".

Parent topic: [Introduction to Your Projector](#)

### Related references

[Where to Get Help](#)

## Projector Part Locations

Check the projector part illustrations to learn about the parts on your projector.

[Projector Parts - Front/Top](#)

[Projector Parts - Rear](#)

Projector Parts - Base

Projector Parts - Control Panel

Projector Parts - Remote Control

Parent topic: Introduction to Your Projector

## Projector Parts - Front/Top

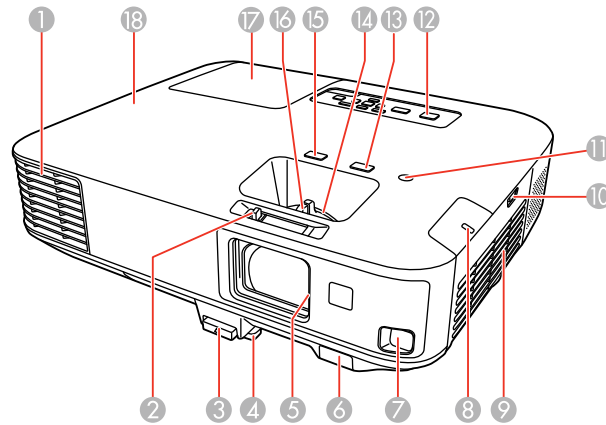

- 1 Exhaust vent
- 2 A/V Mute slide lever
- 3 Foot release lever
- 4 Front adjustable foot
- 5 A/V Mute slide
- 6 Remote receiver
- 7 Screen Fit sensor
- 8 Wireless LAN indicator light (PowerLite 1975W/1985WU)
- 9 Air filter cover
- 10 Air filter cover latch
- 11 Illumination sensor



- 12 Control panel
- 13 Focus help button
- 14 Zoom ring
- 15 Screen Fit button
- 16 Focus ring
- 17 Lamp cover
- 18 Status lights (on the side of the projector)

Parent topic: [Projector Part Locations](#)

## Projector Parts - Rear

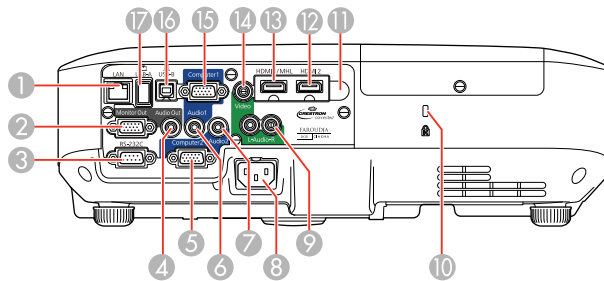

- 1 Network (**LAN**) port
- 2 **Monitor Out** port
- 3 **RS-232C** port
- 4 **Audio Out** port
- 5 **Computer2** port
- 6 **Audio1** port
- 7 **Audio2** port
- 8 Power inlet
- 9 **L-Audio-R** ports

- 10 Security slot
- 11 Remote receiver
- 12 **HDMI 2** port
- 13 **HDMI 1/MHL** port
- 14 **Video** port
- 15 **Computer1** port
- 16 **USB-B** port
- 17 **USB-A** port

Parent topic: [Projector Part Locations](#)

## Projector Parts - Base

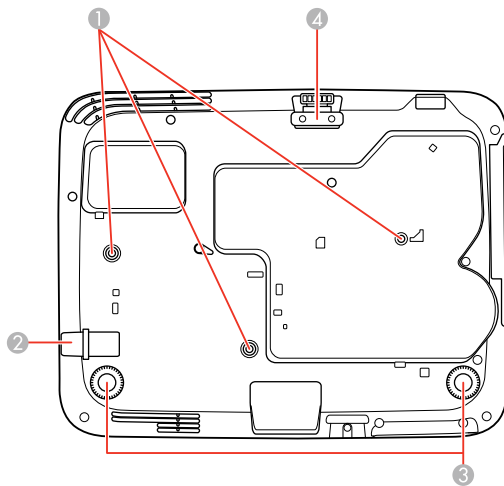

- 1 Mounting bracket holes
- 2 Security cable attachment point
- 3 Rear feet
- 4 Front adjustable foot

Parent topic: [Projector Part Locations](#)

## Projector Parts - Control Panel

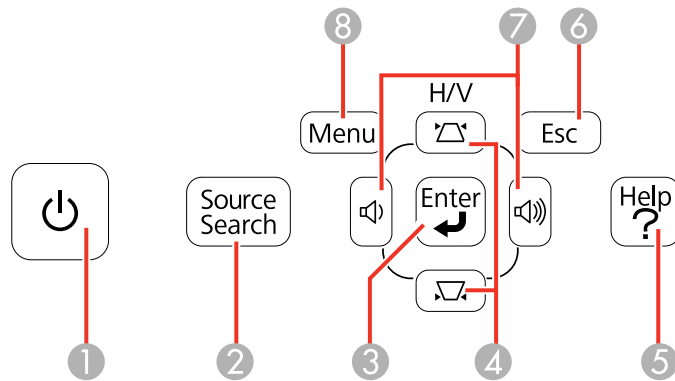

- 1 Power button
- 2 **Source Search** button (searches for connected sources)
- 3 **Enter** button (selects options)
- 4 Vertical keystone adjustment buttons (adjust screen shape) and arrow buttons
- 5 **Help** button (accesses projector help information)
- 6 **Esc** button (cancels/exits functions)
- 7 Volume adjustment buttons (adjust speaker volume), horizontal keystone adjustment buttons (adjust screen shape), and arrow buttons
- 8 **Menu** button (accesses projector menu system)

Parent topic: [Projector Part Locations](#)

Related references

[Projector Light Status](#)

## Projector Parts - Remote Control

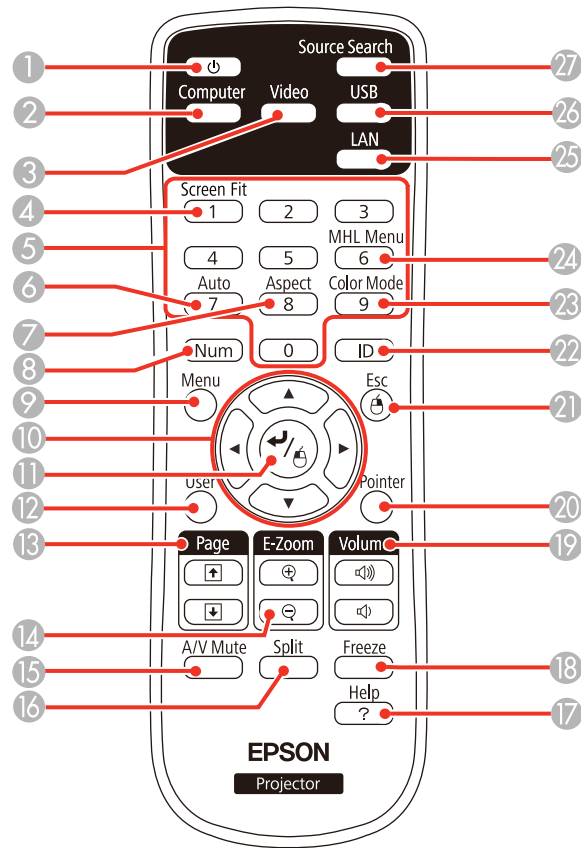

- 1 Power button
- 2 **Computer** button (cycles through connected computer sources)
- 3 **Video** button (cycles through connected video sources)
- 4 **Screen Fit** button (adjusts image shape)
- 5 Numeric buttons (enter numbers)
- 6 **Auto** button (automatically adjusts position, tracking, and sync settings)

- 7 **Aspect** button (selects the image aspect ratio)
- 8 **Num** button (when held down, switches numeric buttons to number function)
- 9 **Menu** button (accesses projector menu system)
- 10 Arrow buttons (move through on-screen options and control wireless mouse functions)
- 11 Enter button (selects options and controls wireless mouse functions)
- 12 **User** button (customizable for different functions)
- 13 **Page** up/down buttons (control presentation slides)
- 14 **E-Zoom +/-** buttons (zoom into and out of the image)
- 15 **A/V Mute** button (turns off picture and sound)
- 16 **Split** button (splits the screen)
- 17 **Help** button (accesses projector help information)
- 18 **Freeze** button (stops video action)
- 19 **Volume** up/down buttons (adjust speaker volume)
- 20 **Pointer** button (activates on-screen pointer)
- 21 **Esc** button (cancels/exits functions and controls wireless mouse functions)
- 22 **ID** button (selects projector and remote control ID numbers )
- 23 **Color Mode** button (selects display modes)
- 24 **MHL Menu** button (displays settings or performs functions for the MHL device)
- 25 **LAN** button (cycles between network and optional Quick Wireless Connection USB Key sources)
- 26 **USB** button (cycles through connected USB sources)
- 27 **Source Search** button (searches for connected sources)

Parent topic: [Projector Part Locations](#)

---

# Setting Up the Projector

Follow the instructions in these sections to set up your projector for use.

[Projector Placement](#)

[Projector Connections](#)

[Installing Batteries in the Remote Control](#)

[Opening the Lens Cover](#)

## Projector Placement

You can place the projector on almost any flat surface to project an image.

You can also install the projector in a ceiling mount if you want to use it in a fixed location.

Keep these considerations in mind as you select a projector location:

- Place the projector on a sturdy, level surface or install it using a compatible mount.
- Leave plenty of space around and under the projector for ventilation, and do not place it on top of or next to anything that could block the vents.
- Position the projector within reach of a grounded electrical outlet or extension cord.

[Projector Setup and Installation Options](#)

[Projection Distance](#)

**Parent topic:** [Setting Up the Projector](#)

## Projector Setup and Installation Options

You can set up or install your projector in the following ways:

Front

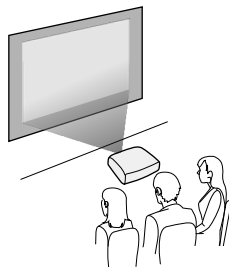

## Rear

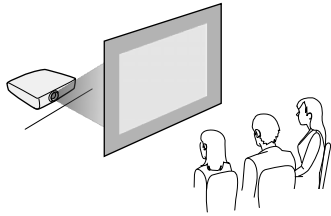

## Front Ceiling

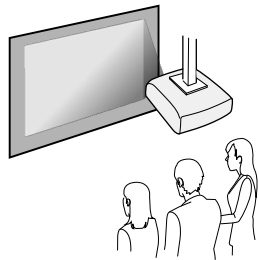

## Rear Ceiling

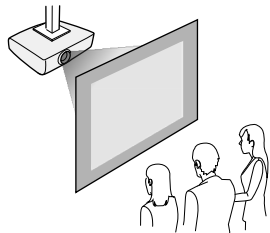

Wherever you set up the projector, make sure to position it squarely in front of the center of the screen, not at an angle, if possible.

If you project from the ceiling or from the rear, be sure to select the correct **Projection** option in the projector's menu system.

**Parent topic:** [Projector Placement](#)

## Related references

[Projector Setup Settings - Extended Menu](#)

## Projection Distance

The distance at which you place the projector from the screen determines the approximate size of the image. The image size increases the farther the projector is from the screen, but can vary depending on the zoom factor, aspect ratio, and other settings.

Use the tables here to determine approximately how far to place the projector from the screen based on the size of the projected image. (Conversion figures may have been rounded up or down.)

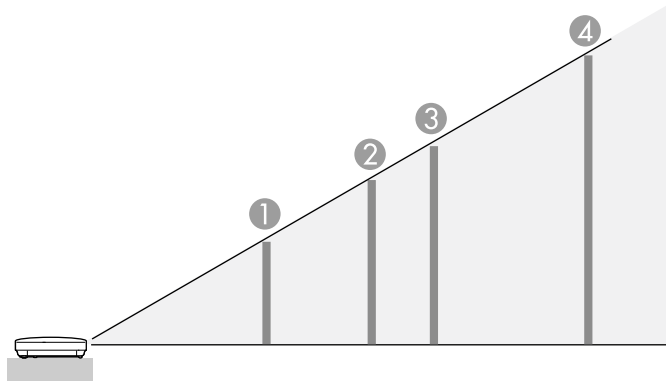

### PowerLite 1970W/1975W

#### 16:10 Aspect Ratio Image or Screen

	Screen or image size	Projection distance Wide to Tele
1	50 inches	57.5 to 95.9 inches (146.7 to 243.5 cm)
2	80 inches	92.9 to 154.2 inches (235.9 to 391.7 cm)
3	100 inches	116.5 to 193.1 inches (295.8 to 490.6 cm)
4	150 inches	175.4 to 290.4 inches (445.6 to 737.6 cm)

### PowerLite 1980WU/1980WU

#### 16:10 Aspect Ratio Image or Screen



	Screen or image size	Projection distance Wide to Tele
1	50 inches	57.5 to 95.9 inches (146.1 to 243.5 cm)
2	80 inches	92.9 to 154.2 inches (235.9 to 391.7 cm)
3	100 inches	116.5 to 193.1 inches (295.8 to 490.6 cm)
4	150 inches	175.4 to 290.4 inches (445.6 to 737.6 cm)

Parent topic: [Projector Placement](#)

## Projector Connections

You can connect the projector to a variety of computer, video, and audio sources to display presentations, movies, or other images, with or without sound.

- Connect any type of computer that has a USB port, standard video output (monitor) port, or HDMI port.
- For video projection, connect devices such as DVD players, gaming consoles, digital cameras, and smartphones with compatible video output ports.
- If your presentation or video includes sound, you can connect audio input cables, if necessary.
- For slide shows or presentations without a computer, you can connect USB devices (such as a flash drive or camera) or an optional Epson document camera.

**Caution:** If you will use the projector at altitudes above 4921 feet (1500 m), turn on **High Altitude Mode** to ensure the projector's internal temperature is regulated properly.

[Connecting to Computer Sources](#)

[Connecting to Video Sources](#)

[Connecting to an External Computer Monitor](#)

[Connecting to External Speakers](#)

[Connecting to External USB Devices](#)

[Connecting to a Document Camera](#)

Parent topic: [Setting Up the Projector](#)

### Related references

[Product Box Contents](#)

[Projector Setup Settings - Extended Menu](#)

## Connecting to Computer Sources

Follow the instructions in these sections to connect a computer to the projector.

[Connecting to a Computer for USB Video and Audio](#)

[Connecting to a Computer for VGA Video](#)

[Connecting to a Computer for HDMI Video and Audio](#)

[Connecting to a Computer for USB Mouse Control](#)

[Connecting to a Computer for Sound](#)

**Parent topic:** [Projector Connections](#)

### Connecting to a Computer for USB Video and Audio

If your computer meets the system requirements, you can send video and audio output to the projector through the computer's USB port (preferably USB 2.0). Connect the projector to your computer using a USB cable.

**Note:** An HDMI connection is recommended for projecting content requiring high bandwidth.

1. Turn on your computer.
2. Connect the cable to your projector's **USB-B** port.

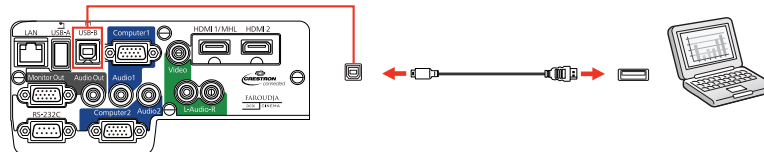

3. Connect the other end to any available USB port on your computer.
4. Do one of the following:
  - **Windows 8.x:** Click **EPSON\_PJ\_UD** in the upper right-corner, then select **Run EMP\_UDSE.EXE** in the dialog box that appears to install the Epson USB Display software.
  - **Windows 7/Windows Vista:** Select **Run EMP\_UDSE.EXE** in the dialog box that appears to install the Epson USB Display software.
  - **Windows XP:** Wait as messages appear on your computer screen and the projector installs the Epson USB Display software on your computer.

- **Windows 2000:** Select **Computer**, **EPSON\_PJ\_UD**, and **EMP\_UDSE.EXE** to install the Epson USB Display software.
- **OS X:** The USB Display setup folder appears on your screen. Select **USB Display Installer** and follow the on-screen instructions to install the Epson USB Display software.

Follow any on-screen instructions. You need to install this software only the first time you connect the projector to the computer.

**Note:** If you are using Windows XP or Windows 2000 and you see a message asking if you want to restart your computer, select **No**.

The projector displays the image from your computer's desktop and outputs sound, if your presentation contains audio.

**Parent topic:** [Connecting to Computer Sources](#)

#### Related references

[Projector Setup Settings - Extended Menu](#)

[USB Display System Requirements](#)

### Connecting to a Computer for VGA Video

You can connect the projector to your computer using a VGA computer cable.

**Note:** To connect a Mac that includes only a Mini DisplayPort, Thunderbolt port, or Mini-DVI port for video output, you need to obtain an adapter that allows you to connect to the projector's VGA video port. Contact Apple for compatible adapter options.

1. If necessary, disconnect your computer's monitor cable.
2. Connect the VGA computer cable to your computer's monitor port.
3. Connect the other end to a **Computer** port on the projector.

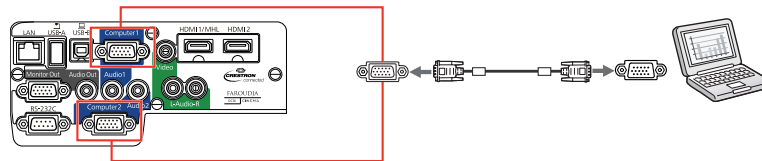

4. Tighten the screws on the VGA connector.

Parent topic: [Connecting to Computer Sources](#)

### Connecting to a Computer for HDMI Video and Audio

If your computer has an HDMI port, you can connect it to the projector using an optional HDMI cable.

**Note:** To connect a Mac that includes only a Mini DisplayPort, Thunderbolt port, or Mini-DVI port for video output, you need to obtain an adapter that allows you to connect to the projector's **HDMI** port. Contact Apple for compatible adapter options. Older Mac computers (2009 and earlier) may not support audio through the **HDMI** port.

1. Connect the HDMI cable to your computer's HDMI output port.
2. Connect the other end to one of the projector's HDMI ports.

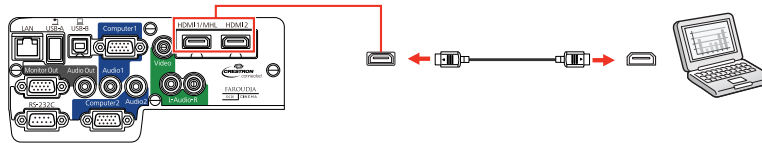

**Note:** The projector converts the digital audio signal sent from your computer into a mono analog signal for the internal speaker or a stereo analog signal if you are connecting to external speakers.

Parent topic: [Connecting to Computer Sources](#)

### Connecting to a Computer for USB Mouse Control

If you connected your computer to a **Computer**, **USB-B**, or **HDMI** port on the projector, you can set up the remote control to act as a wireless mouse. This lets you control projection at a distance from your computer. To do this, connect the projector to your computer using a USB cable, if it is not connected already.

1. Connect the USB cable to your projector's **USB-B** port.

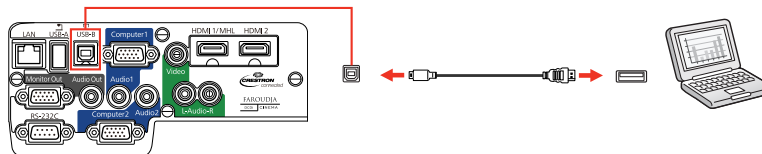

2. Connect the other end to any available USB port on your computer.

3. If necessary, configure your computer to work with an external USB mouse. See your computer documentation for details.

**Parent topic:** [Connecting to Computer Sources](#)

#### Related tasks

[Using the Remote Control as a Wireless Mouse](#)

### Connecting to a Computer for Sound

If your computer presentation includes sound and you did not connect it to the projector's **USB-B** or **HDMI** port, you can still play sound through the projector's speaker system. Just connect an optional 3.5 mm stereo mini-jack audio cable as described here.

1. Connect the audio cable to your laptop's headphone or audio-out jack, or your desktop's speaker or audio-out port.
2. Connect the other end to the **Audio** port that corresponds to the **Computer** port you are using.

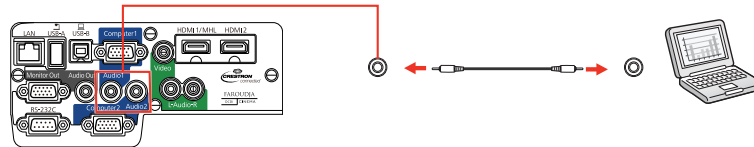

**Parent topic:** [Connecting to Computer Sources](#)

### Connecting to Video Sources

Follow the instructions in these sections to connect video devices to the projector.

[Connecting to an HDMI Video Source](#)

[Connecting to an MHL-Compatible Device](#)

[Connecting to a Component-to-VGA Video Source](#)

[Connecting to a Composite Video Source](#)

[Connecting to a Video Source for Sound](#)

**Parent topic:** [Projector Connections](#)

### Connecting to an HDMI Video Source

If your video source has an HDMI port, you can connect it to the projector using an optional HDMI cable. The HDMI connection provides the best image quality.

1. Connect the HDMI cable to your video source's HDMI output port.

2. Connect the other end to one of the projector's HDMI ports.

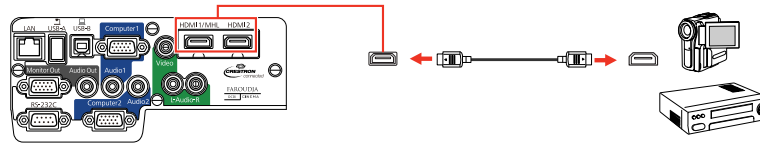

**Note:** The projector converts the digital audio signal sent from your video source into a mono analog signal for the internal speaker or a stereo analog signal if you are connecting to external speakers.

**Parent topic:** [Connecting to Video Sources](#)

### Connecting to an MHL-Compatible Device

If you have an MHL-compatible smartphone or tablet, you can connect it to the projector using either an MHL cable or an HDMI cable with a device-compatible MHL adapter. If you have a device with a built-in MHL connector, plug it directly into the **HDMI 1/MHL** port.

**Note:** Some connected devices may not charge when using an MHL adapter.

1. Connect the MHL cable or adapter to your device's Micro-USB port.
2. If you are using an MHL adapter, connect it to an MHL-compatible HDMI cable.
3. Connect the other end of the cable to the projector's **HDMI 1/MHL** port.

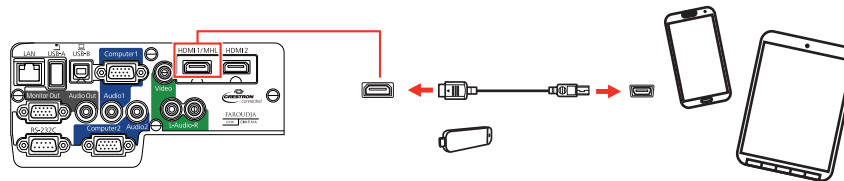

**Note:** The projector converts the digital audio signal sent from your video source into a mono analog signal for the internal speaker or a stereo analog signal if you are connecting to external speakers.

**Parent topic:** [Connecting to Video Sources](#)

## Connecting to a Component-to-VGA Video Source

If your video source has component video ports, you can connect it to the projector using an optional component-to-VGA video cable. Depending on your component ports, you may need to use an adapter cable along with a component video cable.

1. Connect the component connectors to your video source's color-coded component video output ports, usually labeled **Y**, **Pb**, **Pr** or **Y**, **Cb**, **Cr**. If you are using an adapter, connect these connectors to your component video cable.
2. Connect the VGA connector to a **Computer** port on the projector.

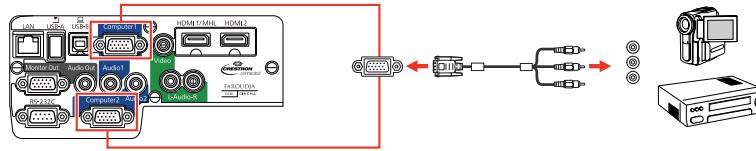

3. Tighten the screws on the VGA connector.

If your image colors appear incorrect, you may need to change the **Input Signal** setting in the projector's Signal menu.

**Parent topic:** [Connecting to Video Sources](#)

### Related references

[Input Signal Settings - Signal Menu](#)

[Optional Equipment and Replacement Parts](#)

## Connecting to a Composite Video Source

If your video source has a composite video port, you can connect it to the projector using an optional RCA-style video or A/V cable.

1. Connect the cable with the yellow connector to your video source's yellow video output port.
2. Connect the other end to the projector's **Video** port.

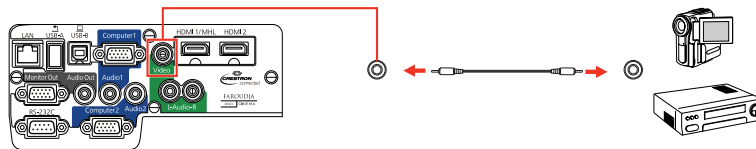

Parent topic: [Connecting to Video Sources](#)

## Connecting to a Video Source for Sound

You can play sound through the projector's speaker system if your video source has audio output ports.

If you are projecting video using a **Computer** port, connect the projector to the video source using an optional stereo mini-jack audio cable or an RCA audio cable.

If you are projecting video using the **Video** port, connect the projector to the video source using an RCA audio cable.

**Note:** If you connected your video source to the projector using an HDMI cable, the audio signal is transferred with the video signal; you do not need an additional cable for sound.

1. Connect the audio cable to your video source's audio-out ports.
2. Do one of the following:
  - Connect the other end of the cable to the projector's **Audio** port that corresponds to the **Computer** port you are using for video.
  - Connect the red and white plugs on the other end of the cable to the projector's **L-Audio-R** ports.

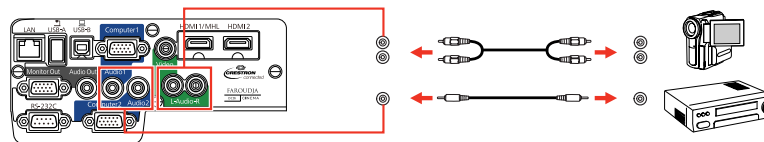

Parent topic: [Connecting to Video Sources](#)

### Related references

[Projector Setup Settings - Extended Menu](#)

## Connecting to an External Computer Monitor

If you connected the projector to a computer using a **Computer** port, you can also connect an external monitor to the projector. This lets you see your presentation on the external monitor even when the projected image is not visible.

If you want to output images to an external monitor when the projector is turned off, you need to select **Communication On** as the **Standby Mode** setting and **Always On** as the **A/V Output** setting in the projector's menu system.



**Note:** Monitors that use a refresh rate less than 60 Hz may not be able to display images correctly.

1. Make sure your computer is connected to the projector's **Computer** port.
2. Connect the external monitor's cable to your projector's **Monitor Out** port.

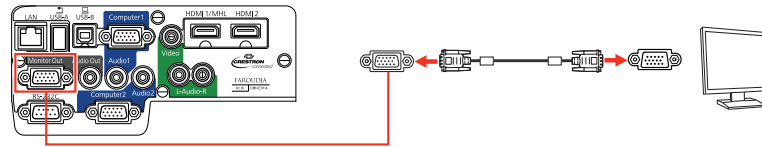

Parent topic: [Projector Connections](#)

## Connecting to External Speakers

To enhance the sound from your presentation, you can connect the projector to external self-powered speakers. You can control the volume using the projector's remote control.

**Note:** You can also connect the projector to an amplifier with speakers.

If you want to output audio from the external speakers when the projector is turned off, you need to select **Communication On** for the **Standby Mode** setting and **Always On** for the **A/V Output** setting in the projector's Extended menu.

**Note:** The projector's built-in speaker system is disabled when you connect external speakers.

1. Make sure your computer or video source is connected to the projector with both audio and video cables as necessary.
2. Locate the appropriate cable to connect your external speakers, such as a stereo mini-jack-to-pin-jack cable, or another type of cable or adapter.
3. Connect one end of the cable to your external speakers as necessary.
4. Connect the stereo mini-jack end of the cable to your projector's **Audio Out** port.

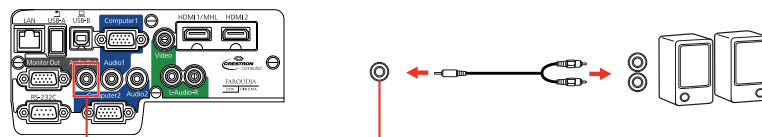

**Parent topic:** [Projector Connections](#)

## Connecting to External USB Devices

Follow the instructions in these sections to connect external USB devices to the projector.

[USB Device Projection](#)

[Connecting a USB Device or Camera to the Projector](#)

[Selecting the Connected USB Source](#)

[Disconnecting a USB Device or Camera From the Projector](#)

**Parent topic:** [Projector Connections](#)

### USB Device Projection

You can project images and other content without using a computer or video device by connecting any of these devices to your projector:

- USB flash drive
- Digital camera or smartphone
- USB hard drive
- Multimedia storage viewer
- USB memory card reader

**Note:** Digital cameras or smartphones must be USB-mounted devices, not TWAIN-compliant devices, and must be USB Mass Storage Class-compliant.

**Note:** USB hard drives must meet these requirements:

- USB Mass Storage Class-compliant (not all USB Mass Storage Class devices are supported)
- Formatted in FAT or FAT32
- Self-powered by their own AC power supplies (bus-powered hard drives are not recommended)
- Avoid using hard drives with multiple partitions

You can also use the EasyMP PC Free feature to create your own slide shows containing converted PowerPoint files and image files, and project them from a connected USB device or memory card reader.

**Parent topic:** [Connecting to External USB Devices](#)

## Related topics

[Projecting a PC Free Presentation](#)

### Connecting a USB Device or Camera to the Projector

You can connect your USB device or camera to the projector's **USB-A** port and use it to project images and other content.

1. If your USB device came with a power adapter, plug the device into an electrical outlet.
2. Connect the USB cable (or USB flash drive or USB memory card reader) to the projector's **USB-A** port shown here.

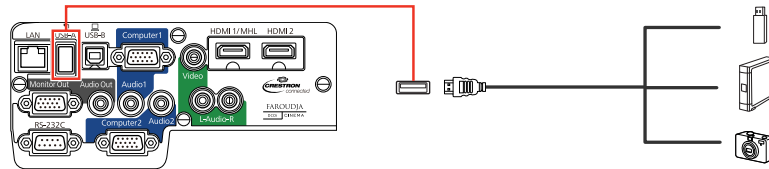

**Note:** Do not connect a USB hub or a USB cable longer than 10 feet (3 m), or the device may not operate correctly.

3. Connect the other end of the cable (if applicable) to your device.

**Parent topic:** [Connecting to External USB Devices](#)

## Related topics

[Projecting a PC Free Presentation](#)

### Selecting the Connected USB Source

You can switch the projector's display to the source you connected to the **USB-A** port.

1. Make sure the connected USB source is turned on, if necessary.
2. Press the **USB** button on the remote control.
3. Press the button again to cycle through other USB sources, if available.

**Parent topic:** [Connecting to External USB Devices](#)

### Disconnecting a USB Device or Camera From the Projector

When you finish presenting with a connected USB device or camera, you must prepare to disconnect the device from the projector.

1. If the device has a power button, turn off and unplug the device.

2. Disconnect the USB device or camera from the projector.

**Parent topic:** [Connecting to External USB Devices](#)

## Connecting to a Document Camera

You can connect a document camera to your projector to project images viewed by the camera.

Depending on your Epson document camera model, do one of the following to connect the document camera to your projector:

- For the Epson DC-06 document camera, locate the USB cable that came with the camera and connect it to the projector's **USB-A** port and to the document camera's USB Type B port.
- For the Epson DC-11 document camera, connect it to the projector's **Computer** or **Video** port and to the corresponding port on the document camera. See the document camera manual for details.
- For the Epson DC-12 document camera, connect it to the projector's **HDMI**, **Computer**, or **Video** port and to the corresponding port on the document camera. See the document camera manual for details.
- For the Epson DC-20 document camera, connect it to the projector's **HDMI**, **Computer**, or **Video** port and to the corresponding port on the document camera. See the document camera manual for details.

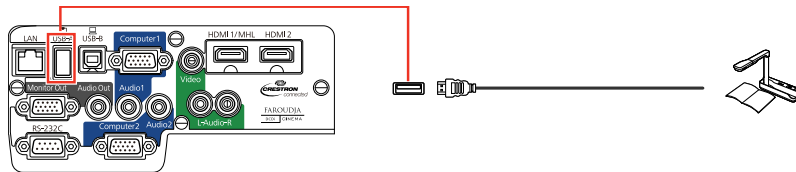

**Note:** For additional features supported by software, connect your document camera to your computer instead of the projector. See the document camera manual for details.

**Parent topic:** [Projector Connections](#)

**Related references**

[Optional Equipment and Replacement Parts](#)

## Installing Batteries in the Remote Control

The remote control uses the two AA batteries that came with the projector.

**Caution:** Use only the type of batteries specified in this manual. Do not install batteries of different types, or mix new and old batteries.

1. Open the battery cover.

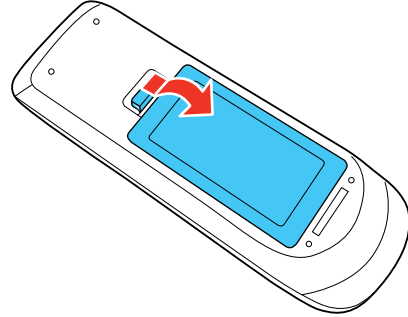

2. Insert the batteries with the + and – ends facing as shown.

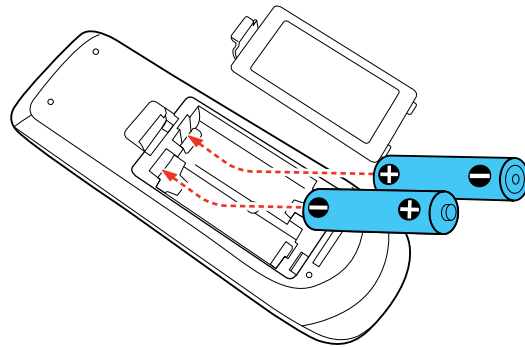

3. Close the battery cover and press it down until it clicks into place.

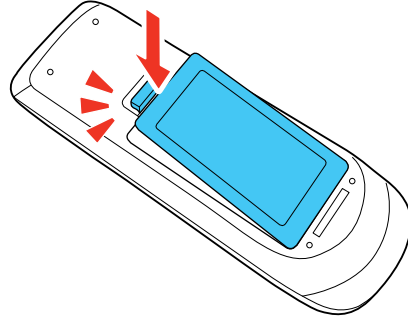

**Warning:** Dispose of used batteries according to local regulations. Do not expose batteries to heat or flame. Keep batteries out of the reach of children; they are choking hazards and are very dangerous if swallowed.

Parent topic: [Setting Up the Projector](#)

## Opening the Lens Cover

1. To open the projector's lens cover, slide the **AV Mute** slide lever until it clicks into the open position.

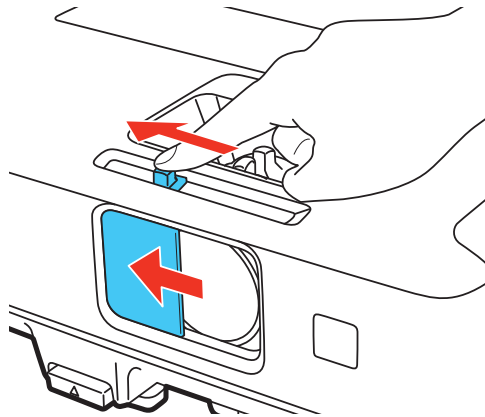

2. To cover the lens or temporarily turn off the projected picture and sound, slide the **AV Mute** slide cover closed.

**Parent topic:** [Setting Up the Projector](#)

---

# Using the Projector on a Network

Follow the instructions in these sections to set up your projector for use on a network.

[Wired Network Projection](#)

[Wireless Network Projection](#)

[Wireless Network Projection from a Mobile Device \(Screen Mirroring\)](#)

[Setting Up Projector Network E-Mail Alerts](#)

[Setting Up Monitoring Using SNMP](#)

[Controlling a Networked Projector Using a Web Browser](#)

[Crestron RoomView Support](#)

## Wired Network Projection

You can send images to your projector through a wired network. To do this, you connect the projector to your network, and then set up your projector and computer for network projection.

After connecting and setting up the projector as described here, install the network software from the *Epson Projector Software* CD or download the software as necessary. Use the following software and documentation to set up, control, and monitor network projection:

- EasyMP Network Projection software sets up your computer for network projection. See the *EasyMP Network Projection Operation Guide* for instructions.
- EasyMP Monitor software (Windows only) lets you monitor and control your projector through the network. You can download the latest software and documentation from the Epson web site. Go to [epson.com/support](http://epson.com/support) (U.S.) or [epson.ca/support](http://epson.ca/support) (Canada) and select your projector.
- EasyMP Multi PC Projection software allows you to hold interactive meetings by projecting the computer screens of users over a network. See the *EasyMP Multi PC Projection Operation Guide* for instructions.
- EasyMP Network Updater software (Windows only) allows you to update firmware for a projector over a wired LAN. See the *EasyMP Network Updater Operation Guide* for instructions. You can download the latest software and documentation from the Epson web site. Go to [epson.com/support](http://epson.com/support) (U.S.) or [epson.ca/support](http://epson.ca/support) (Canada) and select your projector.

**Note:** If your projector is connected via a LAN cable to a network that includes a wireless access point, you can connect to the projector wirelessly through the access point using the EasyMP Network Projection software.



[Connecting to a Wired Network](#)  
[Selecting Wired Network Settings](#)

**Parent topic:** [Using the Projector on a Network](#)

## Connecting to a Wired Network

To connect the projector to a wired local area network (LAN), use a 100Base-TX or 10Base-T network cable. To ensure proper data transmission, use a Category 5 shielded cable or better.

1. Connect one end of the network cable to your network hub, switch, or router.
2. Connect the other end of the cable to the projector's **LAN** port.

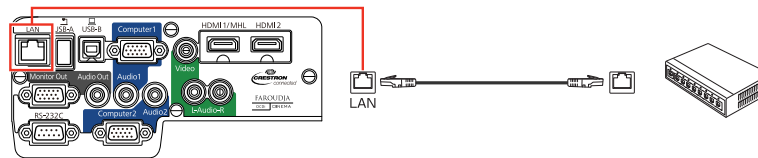

**Parent topic:** [Wired Network Projection](#)

## Selecting Wired Network Settings

Before you can project from computers on your network, you must select the network settings for the projector using its menu system.

**Note:** Make sure you already connected the projector to your wired network using the **LAN** port.

1. Turn on the projector.
2. Press the **Menu** button.

3. Select the **Network** menu and press **Enter**.

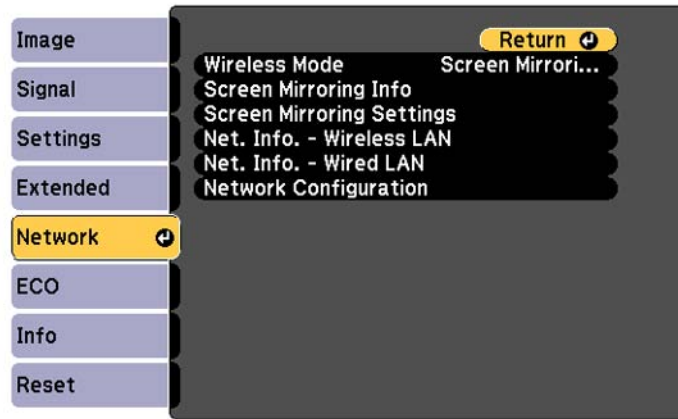

4. Select **Network Configuration** and press **Enter**.
5. Select the **Basic** menu and press **Enter**.
6. Select the following basic options as necessary:
  - **Projector Name** lets you enter a name up to 16 alphanumeric characters long to identify the projector over the network.
  - **PJLink Password** lets you enter a password up to 32 alphanumeric characters long for using the PJLink protocol for projector control.
  - **Web Control Password** lets you enter a password up to 8 alphanumeric characters long for accessing the projector over the web. (Default user name is **EPSONWEB**; default password is **admin**.)
  - **Projector Keyword** lets you turn on a security password to prevent access to the projector by anyone not in the room with it. You must enter a displayed, randomized keyword from a computer using the EasyMP Network Projection software to access the projector.

**Note:** Use the displayed keyboard to enter the name, passwords and keyword. Press the arrow buttons on the remote control to highlight characters and press **Enter** to select them.

7. Select the **Wired LAN** menu and press **Enter**.

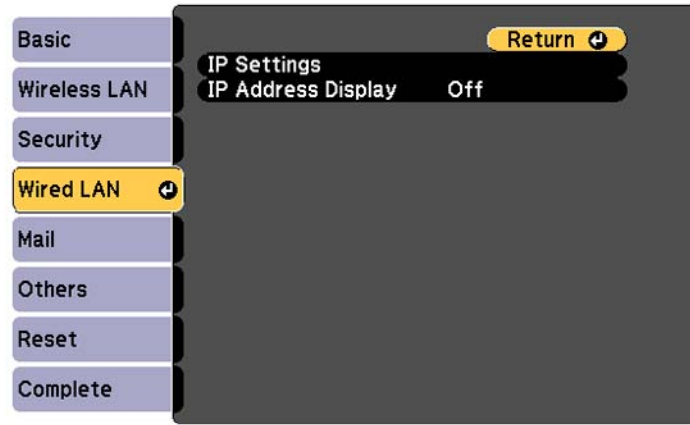

8. If necessary, select **IP Settings** and press **Enter**.
9. Select your IP Settings as necessary:
  - If your network assigns addresses automatically, turn on the **DHCP** setting.
  - If you must set addresses manually, turn off **DHCP** and enter the projector's **IP Address**, **Subnet Mask**, and **Gateway Address** as needed.

**Note:** To highlight the numbers you want from the displayed keyboard, press the arrow buttons on the remote control. To select a highlighted number, press **Enter**.

10. To prevent display of the IP address on the standby screen, turn off **IP Address Display**.
11. When you finish selecting settings, select **Complete** and follow the on-screen instructions to save your settings and exit the menus.

**Parent topic:** [Wired Network Projection](#)

## Wireless Network Projection

You can send images to your projector through a wireless network (PowerLite 1970W/1975W/1980WU). To do this, you must install the Epson 802.11b/g/n wireless LAN module, and then set up your projector and computer for wireless projection.

**Note:** The wireless LAN module is not included with your projector.

**Note:** If your projector is connected via a LAN cable to a network that includes a wireless access point, you can connect to the projector wirelessly using the EasyMP Network Projection software.

There are two ways to connect the projector to your wireless network:

- Using the optional Quick Wireless Connection USB Key (Windows only)
- Configuring the connection manually using the projector's Network menus

After installing the module and setting up the projector, install the network software from the *Epson Projector Software* CD or download the software, as necessary. Use the following software and documentation to set up, control, and monitor wireless projection:

- EasyMP Network Projection software sets up your computer for wireless network projection. See the *EasyMP Network Projection Operation Guide* for instructions.
- EasyMP Monitor software (Windows only) lets you monitor and control your projector through the network. You can download the latest software and documentation from the Epson web site. Go to [epson.com/support](http://epson.com/support) (U.S.) or [epson.ca/support](http://epson.ca/support) (Canada) and select your projector.
- EasyMP Multi PC Projection software allows you to hold interactive meetings by projecting the computer screens of users over a network. See the *EasyMP Multi PC Projection Operation Guide* for instructions.
- Projection from iOS or Android devices with the wireless LAN module and free Epson iProjection app; visit [epson.com/projectorapp](http://epson.com/projectorapp) (U.S.) or [epson.ca/projectorapp](http://epson.ca/projectorapp) (Canada) for more information.

[Installing the Wireless LAN Module](#)

[Using Quick Wireless Connection \(Windows Only\)](#)

[Selecting Wireless Network Settings Manually](#)

[Searching for a Wireless Network](#)

[Selecting Wireless Network Settings in Windows](#)

[Selecting Wireless Network Settings in OS X](#)

[Setting Up Wireless Network Security](#)

**Parent topic:** [Using the Projector on a Network](#)

**Related references**

[Optional Equipment and Replacement Parts](#)

## Installing the Wireless LAN Module

To use the projector over a wireless network, install the optional Epson 802.11b/g/n wireless LAN module (PowerLite 1970W/1975W/1980WU). Do not install any other type of wireless LAN module.

**Caution:** Never remove the module while its indicator light is green or flashing, or while you are projecting wirelessly. You may damage the module or lose data.

1. Turn off the projector and unplug the power cord.
2. Slide the air filter cover latch and open the air filter cover.

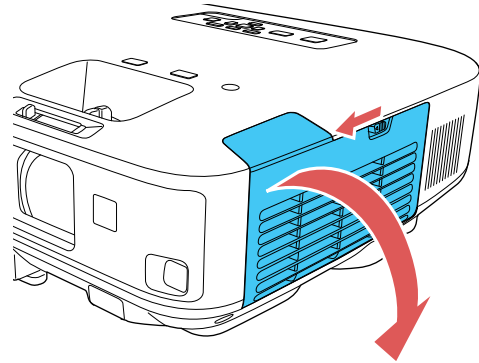

3. Remove the screw securing the wireless LAN module stopper, then remove the stopper.

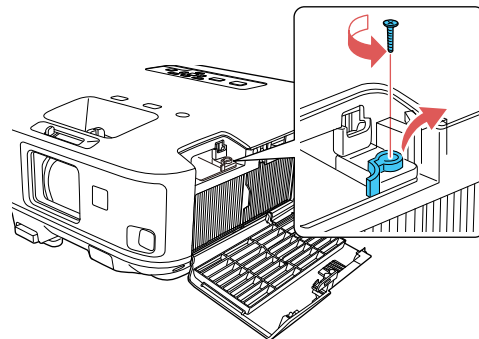

4. Insert the wireless LAN module into the port.

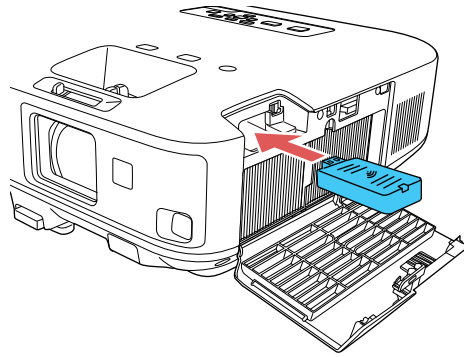

5. Replace the wireless LAN module stopper and secure it using the screw you removed.

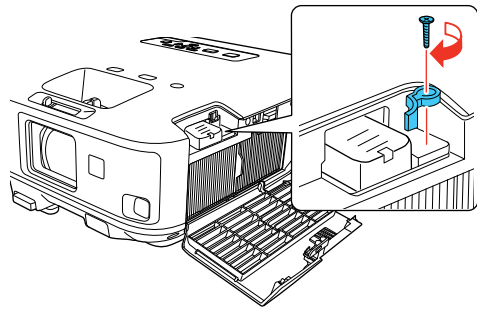

6. Close the air filter cover.
7. Plug in and turn on the projector.

**Parent topic:** [Wireless Network Projection](#)

**Related references**

[Optional Equipment and Replacement Parts](#)

## Using Quick Wireless Connection (Windows Only)

You can use the Quick Wireless Connection USB Key to quickly connect the projector to a Windows computer wirelessly. Then you can project your presentation and remove the key when you are done.

**Note:** The Quick Wireless Connection USB Key is not included with your projector.

1. Turn on the projector.
2. Connect the USB key to the projector's **USB-A** port.  
You see a projected message that the network information update is complete.
3. Remove the USB key.
4. Connect the USB key to a USB port on your computer or laptop.

**Note:** In Windows Vista, if you see the AutoPlay window, select **Run LaunchU3.exe**, then select **Allow** on the next screen.

5. Follow the on-screen instructions to install the Quick Wireless Connection driver.

**Note:** If you see a Windows Firewall message, click **Yes** to disable the firewall.

After a few minutes, your computer image is displayed by the projector. If it does not appear, press the **LAN** button on your projector remote control or restart your computer.

6. Run your presentation as necessary.
7. When you finish projecting wirelessly, select the **Safely Remove Hardware** option in the Windows taskbar, then remove the USB key from your computer.

**Note:** You may need to restart your computer to reactivate your wireless LAN connection.

**Parent topic:** [Wireless Network Projection](#)

**Related references**

[Optional Equipment and Replacement Parts](#)

## Selecting Wireless Network Settings Manually

Before you can project from your wireless network, you must select the network settings for the projector using its menu system.

1. Turn on the projector.
2. Press the **Menu** button.
3. Select the **Network** menu and press **Enter**.

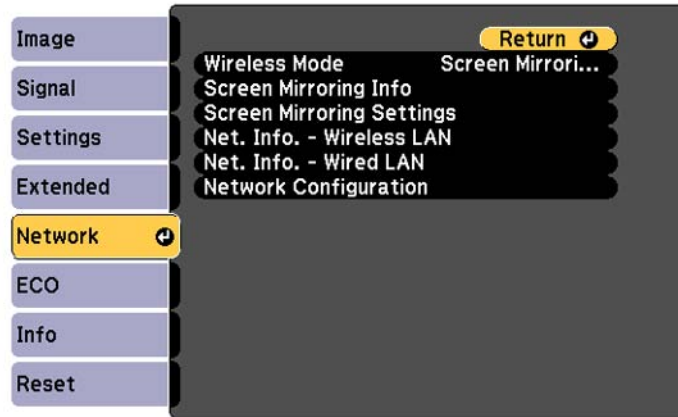

4. Set the **Wireless Mode** setting to **Wireless LAN On** and press **Enter**.
5. Select **Network Configuration** and press **Enter**.
6. Select the **Basic** menu and press **Enter**.

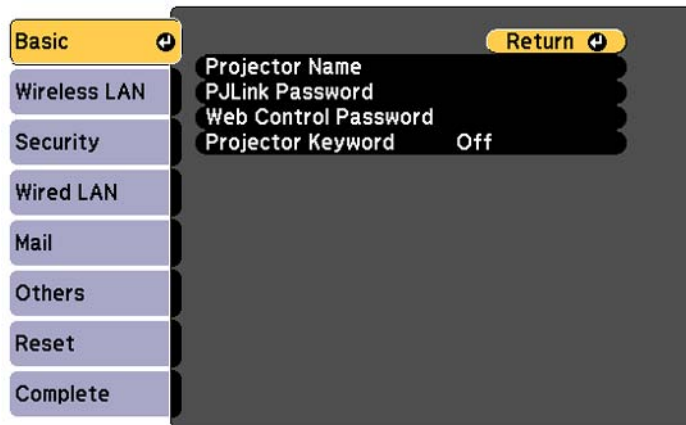



7. Select the following basic options as necessary:

- **Projector Name** lets you enter a name up to 16 alphanumeric characters long to identify the projector over the network.
- **PJLink Password** lets you enter a password up to 32 alphanumeric characters long for using the PJLink protocol for projector control.
- **Web Control Password** lets you enter a password up to 8 alphanumeric characters long for accessing the projector over the web. (Default user name is **EPSONWEB**; default password is **admin**.)
- **Projector Keyword** lets you turn on a security password to prevent access to the projector by anyone not in the room with it. You must enter a displayed, randomized keyword from a computer using the EasyMP Network Projection software to access the projector.

**Note:** Use the displayed keyboard to enter the name, passwords and keyword. Press the arrow buttons on the remote control to highlight characters and press **Enter** to select them.

8. Select the **Wireless LAN** menu and press **Enter**.

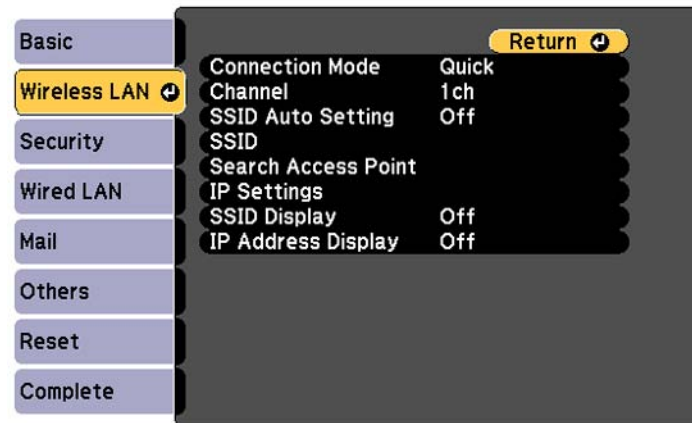

9. Select the settings on the **Wireless LAN** menu as necessary for your network.

10. When you finish selecting settings, select **Complete** and follow the on-screen instructions to save your settings and exit the menus.

After you complete the wireless settings for your projector, you need to select the wireless network on your computer.

## Wireless LAN Menu Settings

Parent topic: [Wireless Network Projection](#)

### Wireless LAN Menu Settings

Setting	Options	Description
<b>Connection Mode</b>	<b>Quick</b> <b>Advanced</b>	Selects the type of wireless connection: <b>Quick:</b> lets you quickly connect to one computer or use the optional Quick Wireless Connection USB key to connect <b>Advanced:</b> lets you connect to multiple computers via a wireless network access point
<b>Channel</b>	<b>1ch</b> <b>6ch</b> <b>11ch</b>	In <b>Quick</b> connection mode, selects the frequency band (channel) used by the wireless LAN
<b>SSID Auto Setting</b>	<b>On</b> <b>Off</b>	Turns on automatic SSID searching in <b>Quick</b> connection mode; set to <b>Off</b> when connecting to multiple projectors at the same time
<b>SSID</b>	Up 32 alphanumeric characters	Sets the SSID (network name) of the wireless LAN system the projector is connecting to
<b>Wi-Fi Protected Setup</b>	<b>Setup</b>	Select <b>Setup</b> to start the WPS Connection Setup utility
<b>Wireless LAN System</b>	<b>802.11b/g</b> <b>802.11b/g/n</b>	Sets the type of wireless LAN system the projector is connecting to
<b>Search Access Point</b>	<b>To Search View</b>	Search for available wireless network access points in <b>Advanced</b> connection mode

Setting	Options	Description
<b>IP Settings</b>	<b>DHCP</b> <b>IP Address</b> <b>Subnet Mask</b> <b>Gateway Address</b>	Select DHCP if your network assigns addresses automatically, or manually enter the network's <b>IP Address</b> , <b>Subnet Mask</b> , and <b>Gateway Address</b>
<b>SSID Display</b>	<b>On</b> <b>Off</b>	Selects whether to display the SSID on the network standby screen
<b>IP Address Display</b>	<b>On</b> <b>Off</b>	Selects whether to display the IP address on the network standby screen

Parent topic: [Selecting Wireless Network Settings Manually](#)

## Searching for a Wireless Network

You can use your projector's site survey function to quickly locate and connect to available wireless networks.

1. Turn on the projector.
2. Press the **Menu** button on the remote control.
3. Select the **Network** menu and press **Enter**.

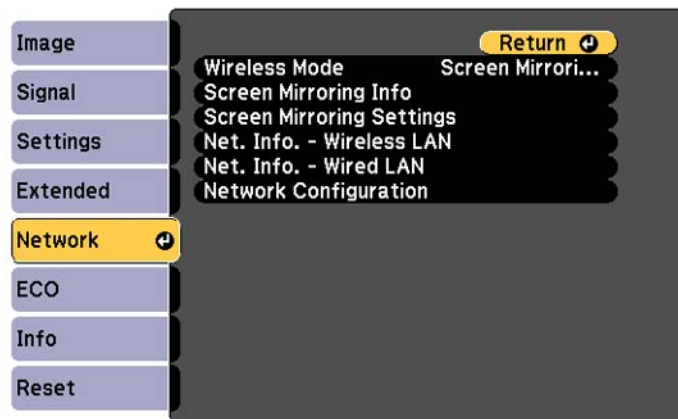

4. Select **Network Configuration** and press **Enter**.
5. Select the **Wireless LAN** menu and press **Enter**.

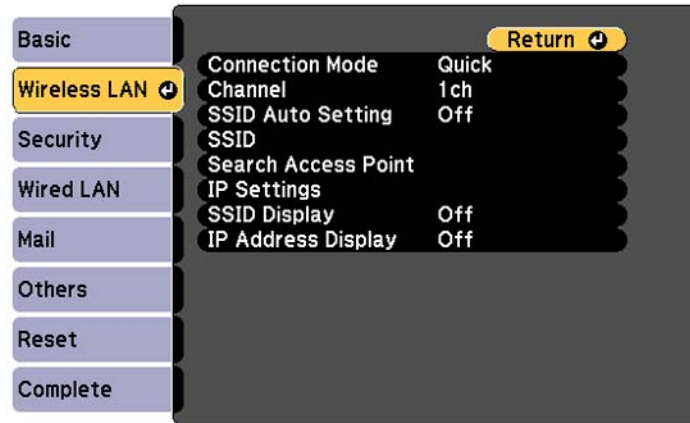

6. Select **Advanced** as the Connection Mode setting and press **Enter**.
7. Select **Search Access Point** and press **Enter**.

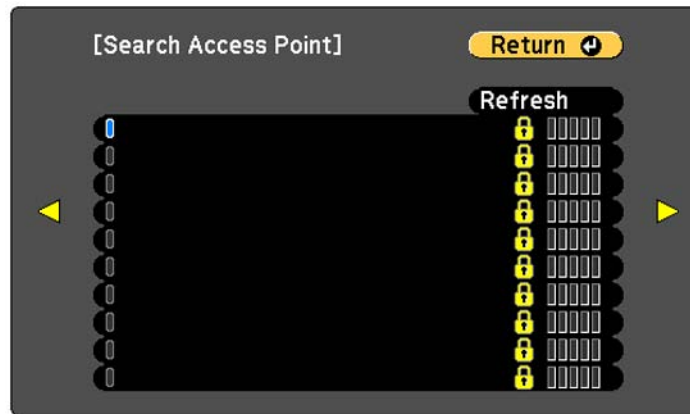

8. Select the name of the wireless network you want to connect to and press **Enter**.
9. If the network has security enabled, enter the wireless password.

You see a screen like this:

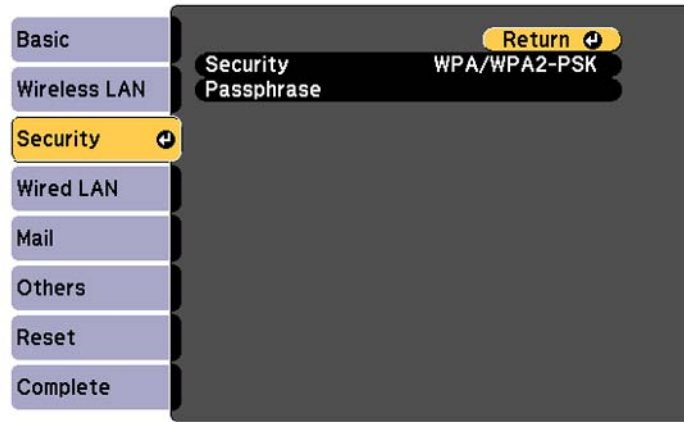

10. Select the settings on the security menu as necessary for your network.
11. When you finish selecting settings, select **Complete** and follow the on-screen instructions to save your settings and exit the menus.

Parent topic: [Wireless Network Projection](#)

## Selecting Wireless Network Settings in Windows

Before connecting to the projector, select the correct wireless network on your computer.

1. To access your wireless utility software, double-click the network icon on the Windows taskbar.
2. Do one of the following:
  - If your projector is set up on an existing network (Advanced mode), select the network name (SSID).
  - If your projector is configured for Quick mode, select the projector's SSID.
3. Click **Connect**.

Parent topic: [Wireless Network Projection](#)

## Selecting Wireless Network Settings in OS X

Before connecting to the projector, select the correct wireless network in OS X.

1. Click the AirPort icon on the menu bar at the top of the screen.

2. Make sure AirPort is turned on, then do one of the following:
  - If your projector is set up on an existing network (Advanced mode), select the network name (SSID).
  - If your projector is configured for Quick mode, select the projector's SSID.

**Parent topic:** [Wireless Network Projection](#)

## Setting Up Wireless Network Security

You can set up security for your projector to use on the wireless network. Set up one of the following security options to match the settings used on your network:

- WPA/WPA2-PSK security (Advanced connection mode)
- WPA2-PSK security (Advanced and Quick connection mode)

**Note:** TKIP and AES encryption are supported.

**Note:** Check with your network administrator for guidance on entering the correct information.

1. Press the **Menu** button.
2. Select the **Network** menu and press **Enter**.
3. Select **Network Configuration** and press **Enter**.
4. Select the **Security** menu and press **Enter**.

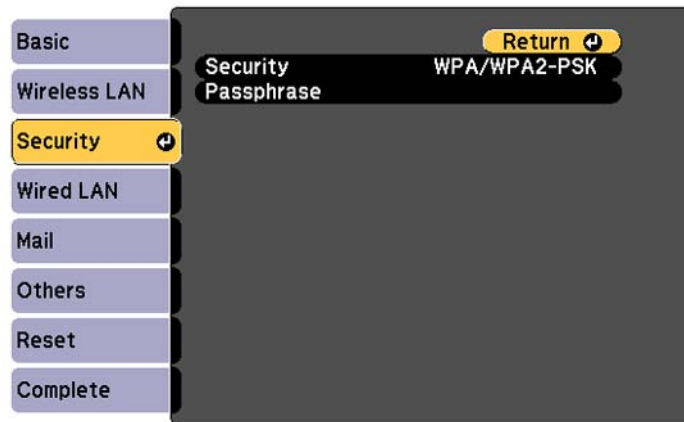

5. Select the security settings for your network.

**Note:** WPA authentication via an authentication server is not supported.

6. When you finish selecting settings, select **Complete** and follow the on-screen instructions to save your settings and exit the menus.

[Wireless Security Menu Settings](#)

**Parent topic:** [Wireless Network Projection](#)

### Wireless Security Menu Settings

Settings on the Security menu let you select the type of security and security settings that match the network you are connecting the projector to.

Setting	Options	Description
<b>Security</b>	<b>WPA2-PSK</b> and <b>WPA</b> types available	Selects the type of security used on the wireless network
<b>Passphrase</b>	Various keys from 8 to 32 characters	Selects the pre-shared key used on the network

**Parent topic:** [Setting Up Wireless Network Security](#)

## Wireless Network Projection from a Mobile Device (Screen Mirroring)

You can send images to your projector from mobile devices such as laptops, smartphones, and tablets using Intel WiDi (version 3.5 or later) and Miracast technology (PowerLite 1975W/1985WU).

If your device supports Intel WiDi or Miracast, you do not need to install any additional software.

[Screen Mirroring Restrictions](#)

[Selecting Screen Mirroring Settings](#)

[Connecting for Screen Mirroring Using Windows 8.1](#)

[Connecting for Screen Mirroring Using Windows 7/Windows 8](#)

[Connecting for Screen Mirroring with Miracast](#)

**Parent topic:** [Using the Projector on a Network](#)

## Screen Mirroring Restrictions

Note the following when using Screen Mirroring features:

- You cannot play audio with more than 3 channels.
- You cannot project images with a resolution above 1920 × 1080 and a frame rate above 50 fps.
- You cannot play 3D video.
- Extended Miracast features on Windows 8.1 are not supported.
- The extended Intel WiDi version 4 features are not supported.
- You may not be able to view contents with copyright protection with a Miracast connection.

**Parent topic:** [Wireless Network Projection from a Mobile Device \(Screen Mirroring\)](#)

## Selecting Screen Mirroring Settings

You can select Screen Mirroring settings for your projector and then project images from your mobile device.

1. Press the **Menu** button.
2. Select the **Network** menu and press **Enter**.
3. Select **Screen Mirroring On** as the **Wireless Mode** setting.
4. Select **Screen Mirroring Settings** and press **Enter**.

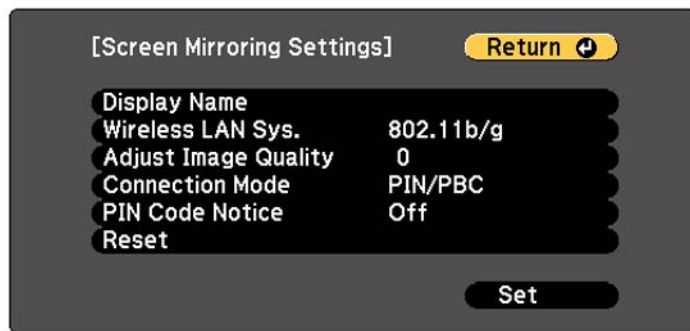

5. Select these Screen Mirroring settings as necessary:
  - **Display Name** lets you enter a name up to 32 alphanumeric characters long to identify the projector from a list of available devices.



- **Wireless LAN Sys.** lets you select the type of wireless LAN system the projector is connected to.
  - **Adjust Image Quality** lets you adjust the screen mirroring speed/quality. Select a small number to improve the quality and select a large number to increase the speed.
  - **Connection Mode** lets you select the type of WPS (Wi-Fi Protected Setup) you are using.
  - **PIN Code Notice** lets you select whether the PIN code is displayed on the projected image while projecting from sources other than the Screen Mirroring source.
6. When you finish selecting settings, select **Set** and press **Enter**.

**Parent topic:** [Wireless Network Projection from a Mobile Device \(Screen Mirroring\)](#)

## Connecting for Screen Mirroring Using Windows 8.1

You can set up your computer for wireless projection from Devices menu in Windows 8.1.

1. Select the **Screen Mirroring Settings** on your projector as necessary.
2. Press the **LAN** button on the remote control to switch to the Screen Mirroring source.  
You see the Screen Mirroring standby screen.
3. On your computer, navigate to the Apps screen.
4. Select **PC settings**.
5. Select **PC and devices**.
6. Select **Devices**.
7. Click **Add a device**.

You see a list of available devices.



8. Select your projector from the list.
9. If you see the PIN entry screen on your computer or mobile device, enter the PIN code displayed on the Screen Mirroring standby screen or at the bottom right of the projected image and click **Next**.  
The projector displays the image from your computer or mobile device.

**Note:** It may take some time to establish the connection. Do not disconnect the projector's power cord while it is connecting to your device. This may cause your device to freeze or malfunction.

**Parent topic:** [Wireless Network Projection from a Mobile Device \(Screen Mirroring\)](#)

## Connecting for Screen Mirroring Using Windows 7/Windows 8

If you are using Windows 7 or Windows 8, you can use the Intel WiDi software to connect to the projector wirelessly and project images and audio.

1. Select the **Screen Mirroring Settings** on your projector as necessary.
2. Press the **LAN** button on the remote control to switch to the Screen Mirroring source.  
You see the Screen Mirroring standby screen.
3. On your computer or mobile device, open the Intel WiDi software.  
You see a list of available devices.

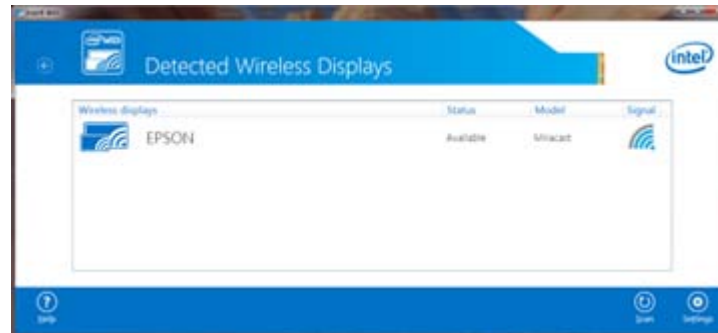

4. Select your projector's **Display Name** from the list.
5. If you see the PIN entry screen on your computer or mobile device, enter the PIN code displayed on the projector's Screen Mirroring standby screen or at the bottom right of the projected image.  
The projector displays the image from your mobile device.

**Note:** It may take some time to establish the WiDi connection. Do not disconnect the projector's power cord while it is connecting to your device. This may cause your device to freeze or malfunction.

**Parent topic:** [Wireless Network Projection from a Mobile Device \(Screen Mirroring\)](#)

## Connecting for Screen Mirroring with Miracast

If your mobile device supports Miracast, you can connect it to the projector wirelessly and project images and sound.

1. Select the **Screen Mirroring Settings** on your projector as necessary.
2. Press the **LAN** button on the remote control to switch to the Screen Mirroring source.  
You see the Screen Mirroring standby screen.
3. On your mobile device, use the Miracast function to search for the projector.

**Note:** See your mobile device's documentation for information on accessing the Miracast function.

You see a list of available devices.

4. Select your projector from the list.
5. If you see the PIN entry screen on your mobile device, enter the PIN code displayed on the Screen Mirroring standby screen or at the bottom right of the projected image.

The projector displays the image from your mobile device.

**Note:** It may take some time to establish the connection. Do not disconnect the projector's power cord while it is connecting to your device. Doing so may cause your device to freeze or malfunction.

Depending on the mobile device, you may need to delete a device when connecting. Follow the on-screen instructions on your device.

**Parent topic:** [Wireless Network Projection from a Mobile Device \(Screen Mirroring\)](#)

## Setting Up Projector Network E-Mail Alerts

You can set up the projector to send you an e-mail alert over the network if there is a problem with the projector.

1. Press the **Menu** button.
2. Select the **Network** menu and press **Enter**.

3. Select **Network Configuration** and press **Enter**.
4. Select the **Mail** menu and press **Enter**.

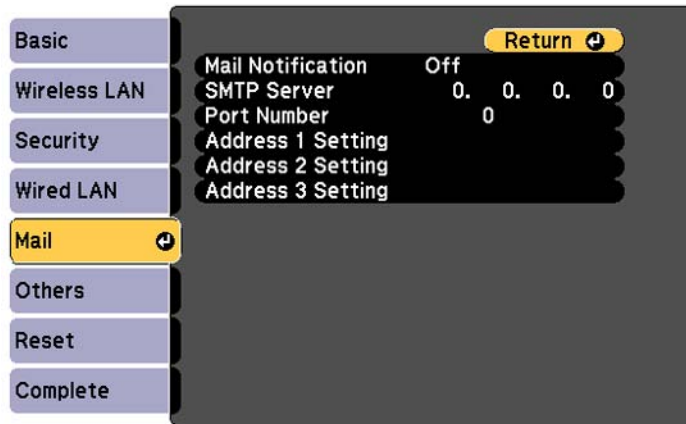

5. Turn on **Mail Notification**.
6. Enter the IP address for the **SMTP Server** option.  
**Note:** Do not use these addresses: 127.x.x.x or 224.0.0.0 through 255.255.255.255 (where x is a number from 0 to 255).
7. Select a number for the SMTP server **Port Number**, from 1 to 65535 (default is 25).
8. Choose an **Address** field, enter the e-mail address, and select the alerts you want to receive there. Repeat for up to three addresses.

**Note:** Your e-mail address can be up to 32 alphanumeric characters long.

9. When you finish selecting settings, select **Complete** and follow the on-screen instructions to save your settings and exit the menu.

**Note:** If a critical problem causes a projector to shut down, you may not receive an e-mail alert.

[Network Projector E-mail Alert Messages](#)

**Parent topic:** [Using the Projector on a Network](#)

## Network Projector E-mail Alert Messages

When a problem occurs with a networked projector, and you selected to receive e-mail alerts, you receive an e-mail containing the following information:

- **Epson Projector** on the subject line
- The name of the projector experiencing a problem
- The IP address of the affected projector
- Detailed information about the problem

**Note:** If a critical problem causes a projector to shut down, you may not receive an e-mail alert.

**Parent topic:** [Setting Up Projector Network E-Mail Alerts](#)

## Setting Up Monitoring Using SNMP

Network administrators can install SNMP (Simple Network Management Protocol) software on network computers so they can monitor projectors. If your network uses this software, you can set up the projector for SNMP monitoring.

1. Press the **Menu** button.
2. Select the **Network** menu and press **Enter**.
3. Select **Network Configuration** and press **Enter**.
4. Select the **Others** menu and press **Enter**.

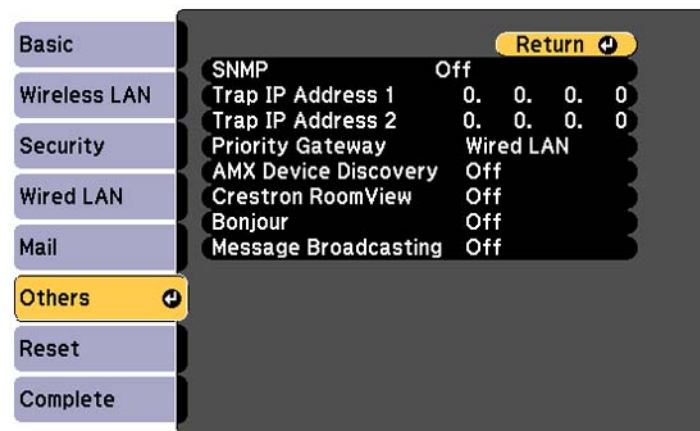

5. Enter up to two IP addresses to receive SNMP notifications, using 0 to 255 for each address field.

**Note:** Do not use these addresses: 127.x.x.x or 224.0.0.0 through 255.255.255.255 (where x is a number from 0 to 255).

6. If available, select the **Priority Gateway** setting for your network.
7. If your network environment uses an AMX controller, turn on the **AMX Device Discovery** setting to allow the projector to be detected.
8. If your network environment uses a Crestron RoomView controller, turn on the **Crestron RoomView** setting to allow the projector to be detected.
9. If you are connecting to a network using Bonjour, turn on the **Bonjour** setting.
10. If you want this projector to receive broadcasted messages over the network, turn on the **Message Broadcasting** setting. Administrators can broadcast messages over the network using the Message Broadcasting plug-in for EasyMP Monitor (Windows only).
11. When you finish selecting settings, select **Complete** and follow the on-screen instructions to save your settings and exit the menus.

**Parent topic:** [Using the Projector on a Network](#)

## Controlling a Networked Projector Using a Web Browser

Once you have connected your projector to your network, you can select projector settings and control projection using a compatible web browser. This lets you access the projector remotely.

**Note:** The web setup and control features support Microsoft Internet Explorer 8.0 or later, and Safari on networks that do not use a proxy server for connection. You cannot select all of the projector menu settings or control all projector functions using a web browser.

**Note:** If you set Standby Mode to **Communication On**, you can use a web browser to select settings and control projection even if the projector is in standby mode.

1. Make sure the projector is turned on.
2. Start your web browser on a computer connected to the network.
3. Type the projector's IP address into the browser's address box and press the computer's **Enter** key. You see the Web Control screen.

**Note:** You may need to log in before you see the Web Control screen. If you see a log in window, enter your user name and password. (The default user name is **EPSONWEB** and the default password is **admin**.)

4. To select projector menu settings, select the name of the menu and follow the on-screen instructions to select settings.
5. To control projection remotely, select the **Web Remote** option.

You see a screen like this:

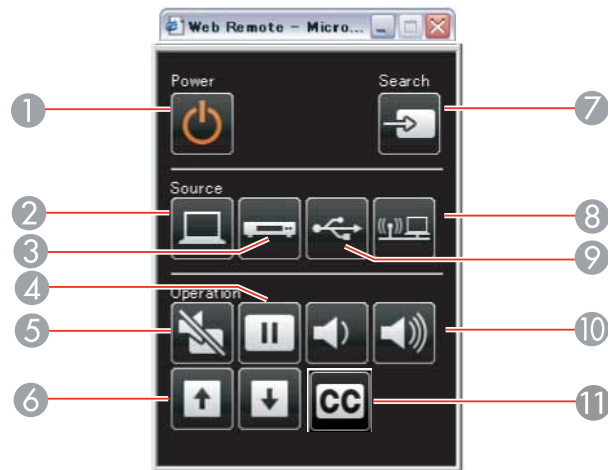

- 1 Power button control
- 2 Selects **Computer** port source
- 3 Selects **Video** and **HDMI** port sources
- 4 **Freeze** button control
- 5 **A/V Mute** button control
- 6 **Page Up** and **Page Down** button controls
- 7 Searches for sources
- 8 Selects the network source
- 9 Selects the USB Display or USB device source

10 **Volume** button controls

11 Closed Caption control

6. Select the icon corresponding to the projector function you want to control.

**Parent topic:** [Using the Projector on a Network](#)

## Crestron RoomView Support

If you are using the Crestron RoomView network monitoring and control system, you can set up your projector for use on the system. Crestron RoomView lets you control and monitor your projector using a web browser.

**Note:** You cannot use the Epson Web Control feature or the Message Broadcasting plug-in for EasyMP Monitor when you use Crestron RoomView.

For additional information on Crestron RoomView, contact Crestron.

[Setting Up Crestron RoomView Support](#)

[Controlling a Networked Projector Using Crestron RoomView](#)

**Parent topic:** [Using the Projector on a Network](#)

## Setting Up Crestron RoomView Support

To set up your projector for monitoring and control using a Crestron RoomView system, make sure your computer and projector are connected to the network.

**Note:** If you want to use the Crestron RoomView system when the projector is turned off, you need to adjust the **Standby Mode** settings in the ECO menu.

1. Press the **Menu** button.
2. Select the **Network** menu and press **Enter**.
3. Select **Network Configuration** and press **Enter**.



4. Select the **Others** menu and press **Enter**.

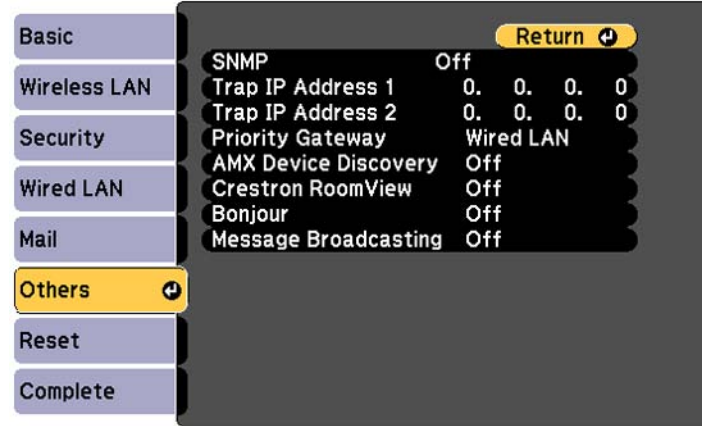

5. Set the **Crestron RoomView** setting to **On** to allow the projector to be detected.
6. When you finish selecting settings, select **Complete** and follow the on-screen instructions to save your settings and exit the menus.
7. Turn off the projector, then turn it on again to enable the setting.

**Parent topic:** [Crestron RoomView Support](#)

## Controlling a Networked Projector Using Crestron RoomView

Once you have set up your projector to use Crestron RoomView, you can control and monitor projection using a compatible web browser.

1. Start your web browser on a computer connected to the network.
2. Type the projector's IP address into the browser's address box and press the computer's **Enter** key.

You see this screen:



3. Select the input source that you want to control in the Sources List box. You can scroll through available sources using the up and down arrows in the box.
4. To control projection remotely, click the on-screen buttons that correspond to the projector's remote control buttons. You can scroll through button options at the bottom of the screen.

**Note:** These on-screen buttons do not directly correspond to the projector's remote control buttons:

- **OK** acts as the **Enter** button
- **Menu** displays the projector's menu

5. To view information about the projector, click the **Info** tab.
6. To change projector, Crestron, and password settings, click the **Tools** tab, select settings on the displayed screen, and click **Send**.
7. When you finish selecting settings, click **Exit** to exit the program.

**Parent topic:** [Crestron RoomView Support](#)

---

# Using Basic Projector Features

Follow the instructions in these sections to use your projector's basic features.

[Turning On the Projector](#)

[Turning Off the Projector](#)

[Selecting the Language for the Projector Menus](#)

[Adjusting the Image Height](#)

[Image Shape](#)

[Resizing the Image With the Zoom Ring](#)

[Focusing the Image Using the Focus Ring](#)

[Focusing the Image with Focus Help](#)

[Remote Control Operation](#)

[Selecting an Image Source](#)

[Projection Modes](#)

[Image Aspect Ratio](#)

[Color Mode](#)

[Controlling the Volume with the Volume Buttons](#)

[Projecting a PC Free Presentation](#)

## **Related references**

[Projector Setup Settings - Extended Menu](#)

## Turning On the Projector

Turn on the computer or video equipment you want to use before you turn on the projector so it can display the image source.

1. Open the projector's lens cover.

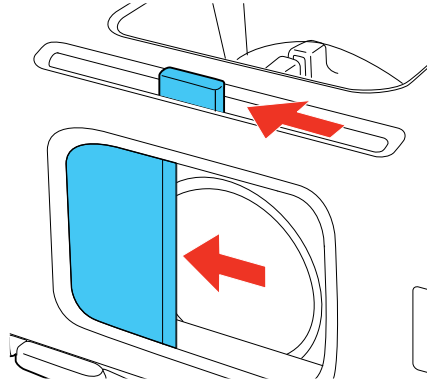

2. Connect the power cord to the projector's power inlet.

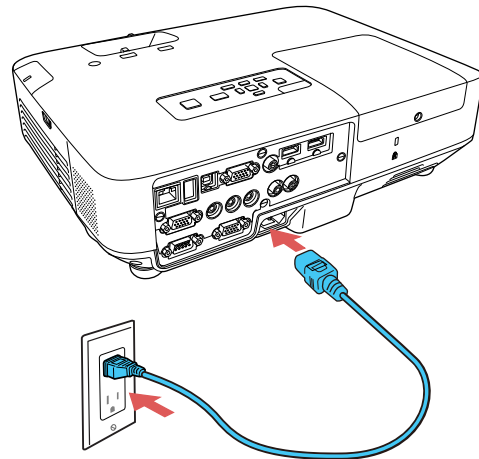

3. Plug the power cord into an electrical outlet.

**Note:** With **Direct Power On** turned on, the projector turns on as soon as you plug it in.

The projector's power light turns blue. This indicates that the projector is receiving power.

4. Press the power button on the projector or the remote control to turn on the projector.

The projector beeps and the Status light flashes blue as the projector warms up. Once the projector is warmed up, the Status light stops flashing and turns blue.

**Warning:** Never look into the projector lens when the lamp is on. This can damage your eyes and is especially dangerous for children.

If you do not see a projected image right away, try the following:

- Verify the lens cover is open all the way.
- Turn on the connected computer or video device.
- Insert a DVD or other video media and press the play button, if necessary.
- Press the **Source Search** button on the projector or remote control to detect the video source.
- Press the button for the video source on the remote control.

**Parent topic:** [Using Basic Projector Features](#)

## Turning Off the Projector

Before turning off the projector, shut down any computer connected to it so you can see the computer display during shutdown.

**Note:** Turn off this product when not in use to prolong the life of the projector. Lamp life will vary depending upon mode selected, environmental conditions, and usage. Brightness decreases over time.

**Note:** When using the A/V Mute feature, the projector lamp is still on. To turn off the lamp, turn off the projector.

1. Press the power button on the projector or the remote control.

The projector displays a shutdown confirmation screen.



2. Press the power button again. (To leave it on, press any other button.)  
The projector beeps twice, the lamp turns off, and the Status light turns off.

**Note:** With Epson's Instant Off technology, there is no cool-down period so you can pack up the projector for transport right away (if necessary).

3. To transport or store the projector, make sure the Status light is off, then unplug the power cord.

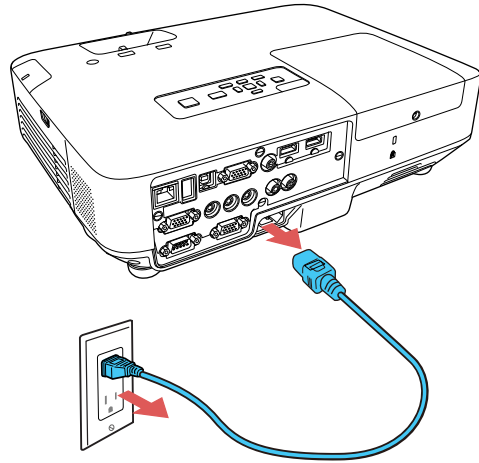

**Caution:** To avoid damaging the projector or lamp, never unplug the power cord when the Status light is on or flashing.

4. Close the projector's lens cover.

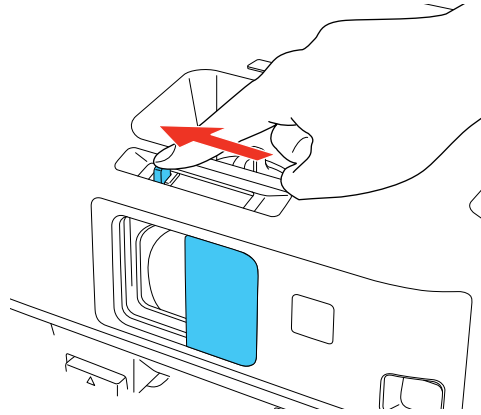

Parent topic: [Using Basic Projector Features](#)

## Selecting the Language for the Projector Menus

If you want to view the projector's menus and messages in another language, you can change the Language setting.

1. Turn on the projector.
2. Press the **Menu** button.

3. Select the **Extended** menu and press **Enter**.

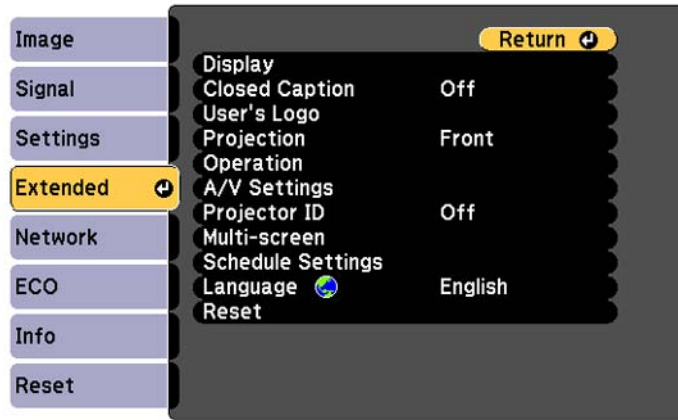

4. Select the **Language** setting and press **Enter**.
5. Select the language you want to use and press **Enter**.
6. Press **Menu** or **Esc** to exit the menus.

Parent topic: [Using Basic Projector Features](#)

## Adjusting the Image Height

If you are projecting from a table or other flat surface, and the image is too high or low, you can adjust the image height using the projector's adjustable feet.

1. Turn on the projector and display an image.



2. To adjust the front foot, pull up on the foot release lever and lift the front of the projector.

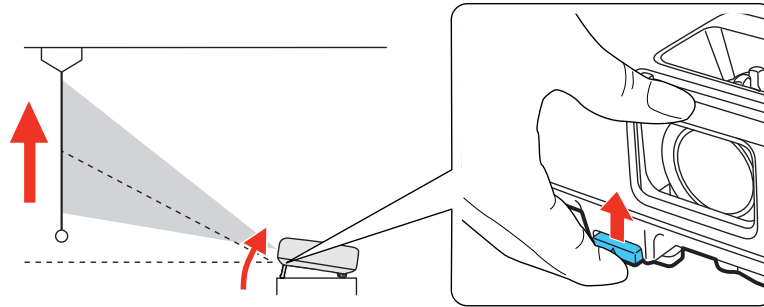

The foot extends from the projector.

3. Release the lever to lock the foot.
4. If the image is tilted, rotate the rear feet to adjust their height.

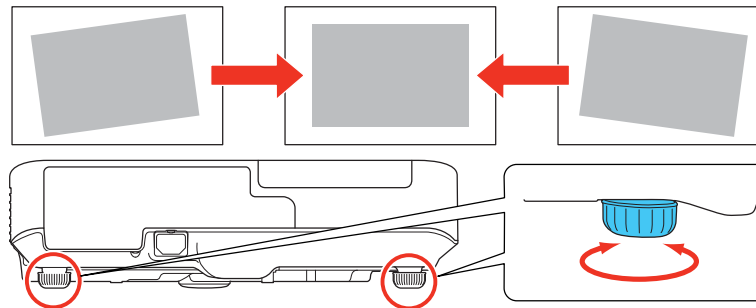

If the projected image is unevenly rectangular, you need to adjust the image shape.

**Parent topic:** [Using Basic Projector Features](#)

**Related concepts**

[Image Shape](#)

**Related references**

[Projector Feature Settings - Settings Menu](#)

## Image Shape

You can project an evenly rectangular image by placing the projector directly in front of the center of the screen and keeping it level. If you place the projector at an angle to the screen, or tilted up or down, or off to the side, you may need to correct the image shape for the best display quality.

When you turn on automatic keystone correction in your projector's Settings menu, your projector automatically corrects keystone effects when you reposition the projector.

[Automatically Correcting Image Shape With Screen Fit](#)

[Correcting Image Shape with the Keystone Buttons](#)

[Correcting Image Shape with Quick Corner](#)

**Parent topic:** [Using Basic Projector Features](#)

### Automatically Correcting Image Shape With Screen Fit

You can use the projector's Screen Fit feature to automatically correct the shape and position of images to fit on your screen.

The projector's sensor can detect the screen size and shape in these conditions:

- Projector is not mounted on the ceiling
- Screen size is 100 inches (254 cm) or less
- Projection distance is about 4 feet (1.2 m) to 10 feet (3 m) (PowerLite 1970W/1975W)
- Projection distance is about 5 feet (1.5 m) to 10 feet (3 m) (PowerLite 1980WU/1985WU)
- Projection angle is about 20° right or left, or 30° up or down
- The room is not too dark
- The projection surface is not patterned and does not deflect the sensor in some way

1. Press the **Screen Fit** button on the projector or remote control.

You see a message on the screen.

2. Move the projector as necessary to display the message in the middle of the screen.
3. Zoom into the image until its yellow frame extends beyond the edges of the screen.
4. Press the **Screen Fit** button again.

Two displays flash briefly, then this message appears:

The revision result can be adjusted by  on the main control panel.

5. Fine-tune the image shape as necessary using the arrow buttons on the control panel.
6. When you are finished, press **Esc**.

Now, if necessary, you can correct the image corners individually using Quick Corner by pressing the arrow buttons on the control panel.

**Parent topic:** [Image Shape](#)

**Related tasks**

[Correcting Image Shape with Quick Corner](#)

## Correcting Image Shape with the Keystone Buttons

You can use the projector's keystone correction buttons to correct the shape of an image that is unevenly rectangular on the sides.

1. Turn on the projector and display an image.

**Note:** You can display a pattern to aid in adjusting the projected image using the Settings menu.

**Note:** You can also display the pattern by pressing the **User** button on the remote control (if the test pattern is assigned to this button).

2. Press one of these keystone buttons on the control panel to display the Keystone adjustment screen.
3. Press a keystone button on the projector's control panel to adjust the image shape.

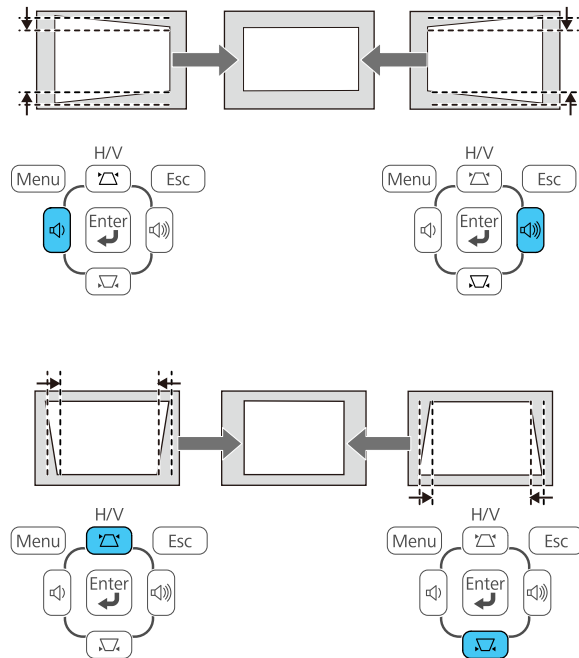

After correction, your image is slightly smaller.

**Note:** If the projector is installed out of reach, you can also correct the image shape with the remote control using the **Keystone** settings in the projector menus.

**Parent topic:** [Image Shape](#)

**Related references**

[Projector Feature Settings - Settings Menu](#)

## Correcting Image Shape with Quick Corner

You can use the projector's Quick Corner setting to correct the shape and size of an image that is unevenly rectangular on all sides.

1. Turn on the projector and display an image.

**Note:** You can display a pattern to aid in adjusting the projected image using the Settings menu.

**Note:** You can also display the pattern by pressing the **User** button on the remote control (if the test pattern is assigned to this button).

2. Press the **Menu** button.
3. Select the **Settings** menu and press **Enter**.

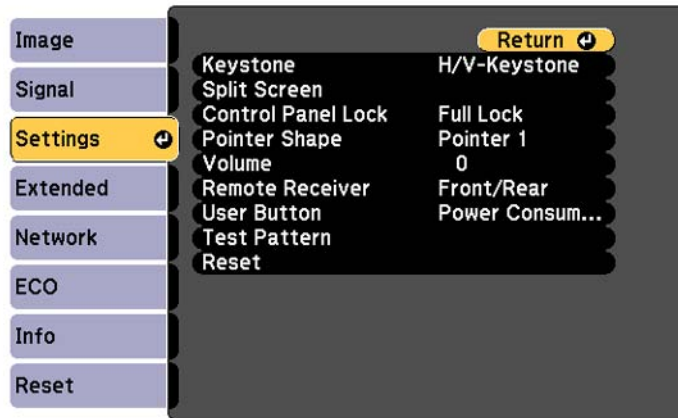

4. Select the **Keystone** setting and press **Enter**.
5. Select the **Quick Corner** setting and press **Enter**. Then press **Enter** again.

You see the Quick Corner adjustment screen:

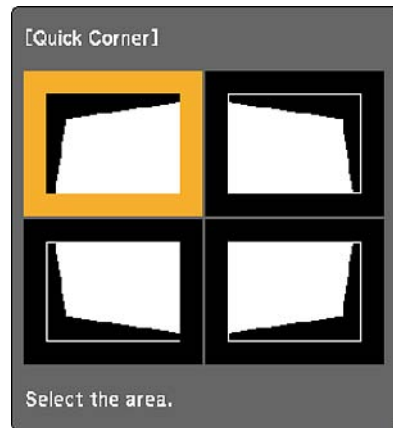

6. Use the arrow buttons on the projector or the remote control to select the corner of the image you want to adjust. Then press **Enter**.
7. Press the arrow buttons to adjust the image shape as necessary.
8. When you are finished, press **Esc**.

**Parent topic:** [Image Shape](#)

**Related references**

[Projector Feature Settings - Settings Menu](#)

## Resizing the Image With the Zoom Ring

1. Turn on the projector and display an image.

**Note:** You can display a pattern to aid in adjusting the projected image using the Settings menu.

**Note:** You can also display the pattern by pressing the **User** button on the remote control (if the test pattern is assigned to this button).

2. To enlarge or reduce the image size, rotate the projector's zoom ring.

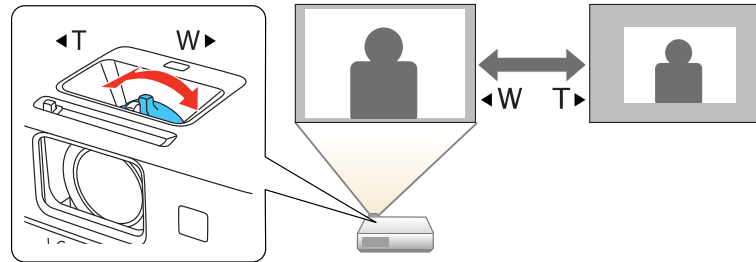

Parent topic: [Using Basic Projector Features](#)

## Focusing the Image Using the Focus Ring

1. Turn on the projector and display an image.

**Note:** You can display a pattern to aid in adjusting the projected image using the Settings menu.

2. To sharpen the image focus, rotate the projector's focus ring.

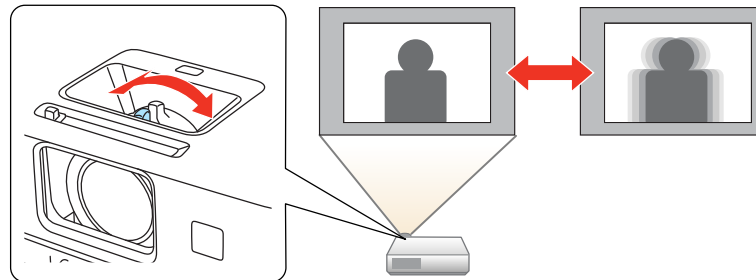

Parent topic: [Using Basic Projector Features](#)

## Focusing the Image with Focus Help

You can use the projector's Focus Help feature to focus the image.

Focus Help works in these conditions:

- Screen size is 100 inches (254 cm) or less
- The room is not too bright

- Projector is positioned within the distances and angles listed here:

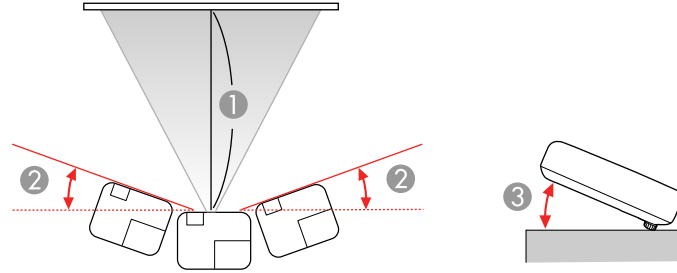

### PowerLite 1980WU/1985WU

- 1 5 to 10 feet (1.5 to 3 m)
- 2 20°
- 3 30°

### PowerLite 1970W/1975W

- 1 3 to 10 feet (0.9 to 3 m)
- 2 20°
- 3 30°

1. Press the **Focus Help** button on the projector.

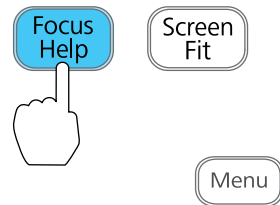



You see a screen like this:



2. Turn the focus ring until the green number matches the orange number as closely as possible.

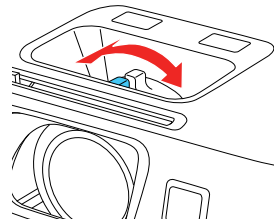

3. When you are finished, press **Esc**.

Parent topic: [Using Basic Projector Features](#)

## Remote Control Operation

The remote control lets you control the projector from almost anywhere in the room, up to 26 feet (8 m) away. You can point it at the screen, or the front or back of the projector.

Make sure that you aim the remote control at the projector's receivers within the angles listed here.

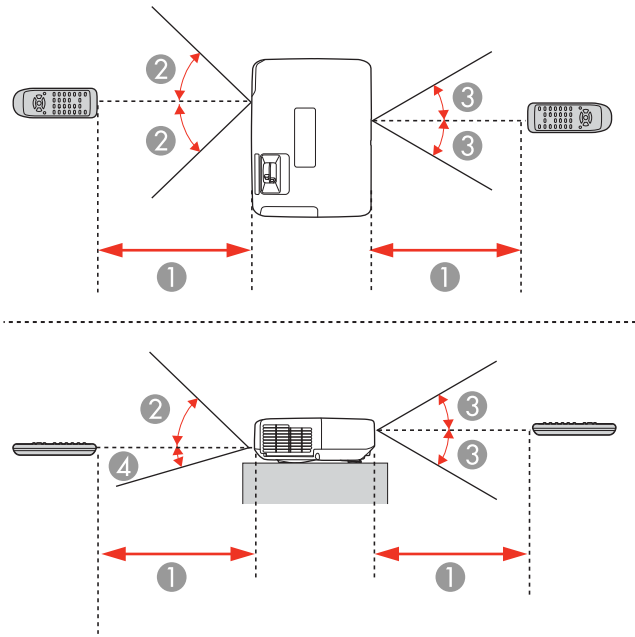

- 1 26 feet (8 m)
- 2 45°
- 3 30°
- 4 15°

**Note:** Avoid using the remote control in conditions with bright fluorescent lights or in direct sunlight, or the projector may not respond to commands. If you will not use the remote control for a long time, remove the batteries.

[Using the Remote Control as a Wireless Mouse](#)

[Using the Remote Control as a Pointer](#)

**Parent topic:** [Using Basic Projector Features](#)

**Related tasks**



[Replacing the Remote Control Batteries](#)

## Using the Remote Control as a Wireless Mouse

You can use the projector's remote control as a wireless mouse so you can control projection at a distance from the computer.

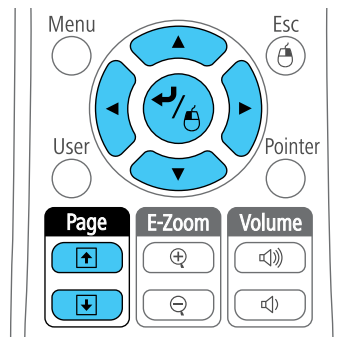
1. Connect the projector to a computer using the projector's **USB-B**, **Computer**, or **HDMI** port to display video.
2. If you connected your computer to the **Computer** or **HDMI** port, also connect a USB cable to the projector's **USB-B** port and to a USB port on your computer (for wireless mouse support).
3. Start your presentation.
4. Use the following buttons on the remote control to control your presentation:
  - To move through slides or pages, press the up or down **Page** buttons.



- To move the cursor on the screen, use the arrow buttons.
- To left-click, press the  button once (press it twice to double-click).
- To right-click, press the **Esc** button.
- To drag-and-drop, hold the  button as you move the cursor with the arrow buttons, then release  at the destination.

**Parent topic:** [Remote Control Operation](#)

### Related references

[Projector Setup Settings - Extended Menu](#)

## Using the Remote Control as a Pointer

You can use the projector's remote control as a pointer to help you call out important information on the screen. The default pointer shape is an arrow, but you can select an alternative shape using the Settings menu.

1. Press the **Pointer** button on the remote control.

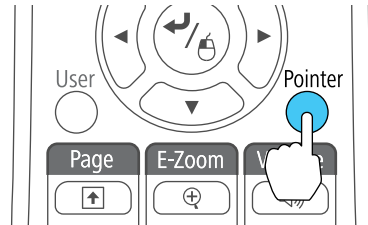

2. Use the arrow buttons on the remote control to move the pointer on the screen.

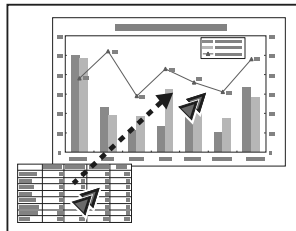

3. Press **Esc** to clear the pointer from the screen.

**Parent topic:** [Remote Control Operation](#)

### Related references

[Projector Feature Settings - Settings Menu](#)

## Selecting an Image Source

If you connected multiple image sources to the projector, such as a computer and DVD player, you may want to switch from one image source to the other.

1. Make sure the connected image source you want to use is turned on.
2. For video image sources, insert a DVD or other video media and press its play button, if necessary.

3. Do one of the following:

- Press the **Source Search** button on the projector or remote control until you see the image from the source you want.

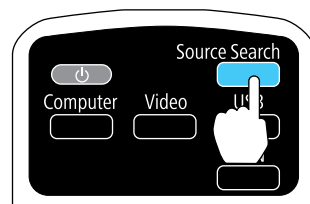
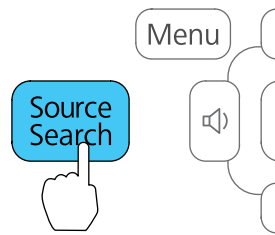

- Press the button for the source you want on the remote control. If there is more than one port for that source, press the button again to cycle through the sources.

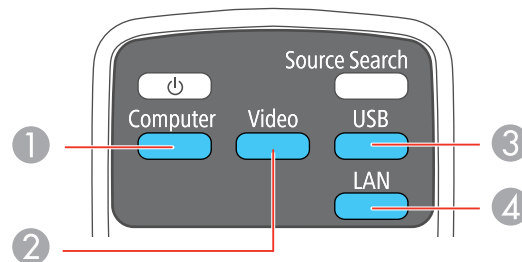

- 1 Computer port sources
- 2 Video, HDMI, and MHL sources
- 3 USB port sources (computer display and external devices)

Parent topic: [Using Basic Projector Features](#)

## Projection Modes

Depending on how you positioned the projector, you may need to change the projection mode so your images project correctly.

- **Front** (default setting) lets you project from a table in front of the screen.
- **Front/Ceiling** flips the image over top-to-bottom to project upside-down from a ceiling or wall mount.
- **Rear** flips the image horizontally to project from behind a translucent screen.
- **Rear/Ceiling** flips the image over top-to-bottom and horizontally to project from the ceiling and behind a translucent screen.

[Changing the Projection Mode Using the Remote Control](#)

[Changing the Projection Mode Using the Menus](#)

Parent topic: [Using Basic Projector Features](#)

## Changing the Projection Mode Using the Remote Control

You can change the projection mode to flip the image over top-to-bottom.

1. Turn on the projector and display an image.
2. Hold down the **A/V Mute** button on the remote control for five seconds.

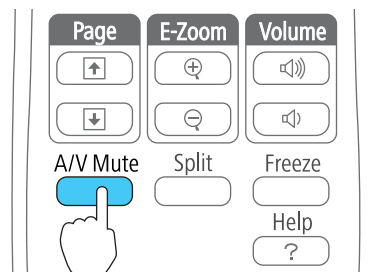

The image disappears briefly and reappears flipped top-to-bottom.

3. To change projection back to the original mode, hold down the **A/V Mute** button for five seconds again.

Parent topic: [Projection Modes](#)

## Changing the Projection Mode Using the Menus

You can change the projection mode to flip the image over top-to-bottom and/or left-to-right using the projector menus.

1. Turn on the projector and display an image.
2. Press the **Menu** button.
3. Select the **Extended** menu and press **Enter**.

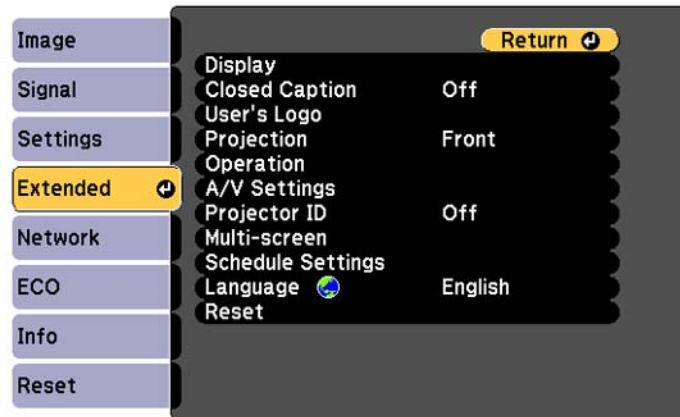

4. Select the **Projection** setting and press **Enter**.
5. Select a projection mode and press **Enter**.
6. Press **Menu** or **Esc** to exit the menus.

Parent topic: [Projection Modes](#)

## Image Aspect Ratio

The projector can display images in different width-to-height ratios called aspect ratios. Normally the input signal from your video source determines the image's aspect ratio. However, for certain images you can change the aspect ratio to fit your screen by pressing a button on the remote control.

If you always want to use a particular aspect ratio for a certain video input source, you can select it using the projector's menus.

### [Changing the Image Aspect Ratio](#)

#### [Available Image Aspect Ratios](#)

**Parent topic:** [Using Basic Projector Features](#)

#### **Related references**

[Input Signal Settings - Signal Menu](#)

## Changing the Image Aspect Ratio

You can change the aspect ratio of the displayed image to resize it.

1. Turn on the projector and switch to the image source you want to use.
2. Press the **Aspect** button on the remote control.

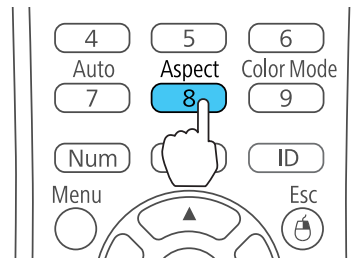

The shape and size of the displayed image changes, and the name of the aspect ratio appears briefly on the screen.

3. To cycle through the available aspect ratios for your input signal, press the **Aspect** button repeatedly.

**Parent topic:** [Image Aspect Ratio](#)

## Available Image Aspect Ratios

You can select the following image aspect ratios, depending on the input signal from your image source.

**Note:** Black bands and cropped images may project in certain aspect ratios, depending on the aspect ratio and resolution of your input signal.



Aspect ratio setting	Description
<b>Normal</b>	Displays images using the full projection area and maintains the aspect ratio of the image.
<b>16:9</b>	Converts the aspect ratio of the image to 16:9.
<b>Full</b>	Displays images using the full width of the projection area, but does not maintain the aspect ratio.
<b>Zoom</b>	Displays images using the full width of the projection area and maintains the aspect ratio of the image.
<b>Native</b>	Displays images as is (aspect ratio and resolution are maintained).

**Note:** The **Auto** aspect ratio setting is available only for HDMI and MHL image sources.

**Parent topic:** [Image Aspect Ratio](#)

## Color Mode

The projector offers different Color Modes to provide optimum brightness, contrast, and color for a variety of viewing environments and image types. You can select a mode designed to match your image and environment, or experiment with the available modes.

If you always want to use a particular color mode for a certain video input source, you can select it using the projector menus.

[Changing the Color Mode](#)

[Available Color Modes](#)

[Turning On Auto Iris](#)

**Parent topic:** [Using Basic Projector Features](#)

**Related references**

[Image Quality Settings - Image Menu](#)

## Changing the Color Mode

You can change the projector's Color Mode using the remote control to optimize the image for your viewing environment.

1. Turn on the projector and switch to the image source you want to use.
2. If you are projecting from a DVD player or other video source, insert a disc or other video media and press the play button, if necessary.

3. Press the **Color Mode** button on the remote control to change the Color Mode.

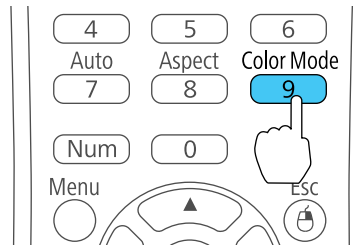

The image appearance changes and the name of the Color Mode appears briefly on the screen.

4. To cycle through all the available Color Modes for your input signal, press the **Color Mode** button repeatedly.

Parent topic: [Color Mode](#)

## Available Color Modes

You can set the projector to use these Color Modes, depending on the input source you are using:

Color Mode	Description
<b>Presentation</b>	Best for color presentations in a bright room
<b>Dynamic</b>	Best for projecting in a bright room
<b>Theatre</b>	Best for movies projected in a dark room
<b>Sports</b>	Best for television images in a bright room
<b>sRGB</b>	Best for standard sRGB computer displays
<b>Blackboard</b>	Best for presentations onto a green chalkboard (adjusts the colors accordingly)
<b>Whiteboard</b>	Best for presentations onto a whiteboard (adjusts the colors accordingly)
<b>Photo</b>	Best for still images projected in a bright room
<b>DICOM SIM</b>	Best for projecting X-ray photographs and other medical images

**Note:** The **DICOM SIM** Color Mode is for reference purposes only and should not be used to make medical diagnoses.

Parent topic: [Color Mode](#)

## Turning On Auto Iris

In certain color modes, you can turn on the Auto Iris setting to automatically optimize the image based on the brightness of the content you project.

1. Turn on the projector and switch to the image source you want to use.
2. Press the **Menu** button.
3. Select the **Image** menu and press **Enter**.

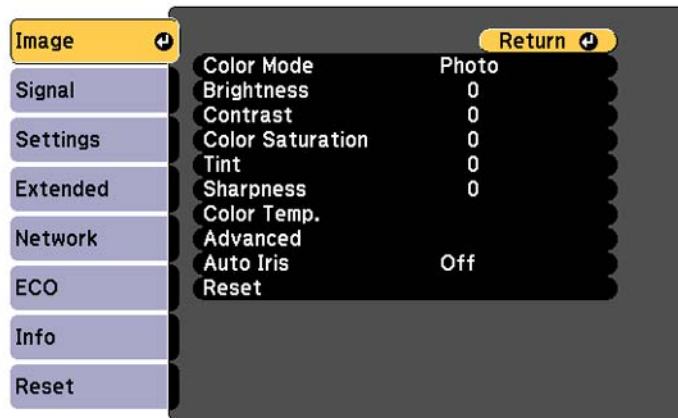

4. Select the **Auto Iris** setting and select **On**.

**Note:** You can turn **Auto Iris** on or off for each Color Mode that supports the feature. You cannot change the **Auto Iris** setting when you are using a **Closed Caption** setting.

5. Press **Menu** or **Esc** to exit the menus.

Parent topic: [Color Mode](#)

## Controlling the Volume with the Volume Buttons

You can use the **Volume** buttons on the projector or the remote control to adjust the volume as you project a presentation with audio. The volume buttons control the projector's internal speaker system or any external speakers you connected to the projector.

You must adjust the volume separately for each connected input source.

1. Turn on the projector and start a presentation that includes audio.
2. To lower or raise the volume, press the **Volume** buttons on the remote control or these buttons on the control panel.

translate="no" [ADD GHANA IMAGE]

A volume gauge appears on the screen.

3. To set the volume to a specific level for an input source, use the projector menus.

**Parent topic:** [Using Basic Projector Features](#)

## Projecting a PC Free Presentation

You can use your projector's PC Free feature whenever you connect a USB device that contains compatible presentation files. This lets you quickly and easily display a presentation and control it using the projector's remote control.

[Supported PC Free File Types](#)

[Starting a PC Free Slide Show](#)

[Starting a PC Free PDF File Presentation](#)

[Starting a PC Free Movie Presentation](#)

[PC Free Display Options](#)

**Parent topic:** [Using Basic Projector Features](#)

**Related concepts**

[USB Device Projection](#)

**Related tasks**

[Connecting a USB Device or Camera to the Projector](#)

## Supported PC Free File Types

You can project these types of files using the projector's PC Free feature.

**Note:** For best results, place your files on media that is formatted in FAT16/32. If you have trouble projecting from media formatted for non-Windows file systems, try formatting the media for Windows instead. You may not be able to use the security features on certain USB storage devices with PC Free features.

File contents	File type (extension)	Details
Image	.jpg	Make sure the file is not: <ul style="list-style-type: none"> <li>• CMYK format</li> <li>• Progressive format</li> <li>• Highly compressed</li> <li>• Above 8192 × 8192 resolution</li> </ul>
	.bmp	Make sure the file resolution is not above 1920 × 1080
	.gif	Make sure the file is not: <ul style="list-style-type: none"> <li>• Above 1920 × 1080 resolution</li> <li>• Animated</li> </ul>
	.png	Make sure the file resolution is not above 1920 × 1080
Scenario	.fse	Main format for files converted from PowerPoint using EasyMP Slide Converter
PDF	.pdf	Make sure the file is not: <ul style="list-style-type: none"> <li>• Saved in PDF version 1.8 or later format</li> <li>• Encrypted</li> </ul>
Movie	.avi	Make sure the file is not: <ul style="list-style-type: none"> <li>• Saved with an audio codec other than linear PCM or ADPCM</li> <li>• Above 1280 × 720 resolution</li> <li>• Larger than 2GB</li> </ul>

Parent topic: [Projecting a PC Free Presentation](#)

## Starting a PC Free Slide Show

After connecting a USB device or digital camera to the projector, you can switch to the USB input source and start your slide show.

**Note:** You can change the PC Free operation options or add special effects by highlighting **Option** at the bottom of the screen and pressing **Enter**.

1. Press the **USB** button on the projector remote control.

The PC Free screen appears.



2. Do the following as necessary to locate your files:
  - If you need to display files inside a subfolder on your device, press the arrow buttons to highlight the folder and press the **Enter** button.
  - To move back up a folder level on your device, highlight **Back to Top** and press **Enter**.
  - To view additional files in a folder, highlight **Next page** or **Previous page** and press **Enter**.

3. Do one of the following:
  - To display an individual image, press the arrow buttons to highlight the image and press **Enter**. (Press the **Esc** button to return to the file list screen.)
  - To display a slide show of all the images in a folder, press the arrow buttons to highlight the **Slideshow** option at the bottom of the screen and press **Enter**.

**Note:** If any file names are longer than 8 characters or include unsupported symbols, the file names may be shortened or changed only in the screen display.

4. While projecting, use the following commands to control the display as necessary:
  - To rotate a displayed image, press the up or down arrow button.
  - To move to the next or previous image, press the left or right arrow button.
5. To stop the display, follow the on-screen instructions or press the **Esc** button.

**Parent topic:** [Projecting a PC Free Presentation](#)

**Related tasks**

[Disconnecting a USB Device or Camera From the Projector](#)

## Starting a PC Free PDF File Presentation

After connecting a USB device to the projector, you can switch to the USB input source and start your PDF file presentation.

**Note:** You cannot do the following while presenting a PDF file from a USB device:

- Release a password
- Display e-signatures, JPEG2000 images, transparent effects, 3D artwork, or comments
- Play multimedia content

1. Press the **USB** button on the projector remote control.

The PC Free screen appears.



2. Do the following as necessary to locate your files:
  - If you need to display files inside a subfolder on your device, press the arrow buttons to highlight the folder and press the **Enter** button.
  - To move back up a folder level on your device, highlight **Back to Top** and press **Enter**.
  - To view additional files in a folder, highlight **Next page** or **Previous page** and press **Enter**.
3. To display the first page of a PDF file at full size, press the arrow buttons to highlight the file and press **Enter**. (Press the **Esc** button to return to the file list screen.)

**Note:** If any file names are longer than 8 characters or include unsupported symbols, the file names may be shortened or changed only in the screen display. If a PDF file extension is not .pdf, the file does not appear in the file list.

4. While projecting a PDF file, use the following commands to control the display as necessary:
  - To move to the next or previous page, press the up or down arrow button.



- To display a menu of pages to select from, press the **Esc** button. Then press the left or right arrow button to select a page and press **Enter**.
  - To enlarge the view of a page to fit the screen, press **Enter**. Press **Enter** again to return to standard size display.
  - To rotate a displayed page, press the left or right arrow button.
5. To stop the display, press the **Esc** button, press the up or down arrow button to highlight **EXIT**, and press **Enter**.

Parent topic: [Projecting a PC Free Presentation](#)

## Starting a PC Free Movie Presentation

After connecting a USB device or digital camera to the projector, you can switch to the USB input source and start your movie.

**Note:** You can change the PC Free operation options by highlighting **Option** at the bottom of the screen and pressing **Enter**.

1. Press the **USB** button on the projector remote control.

The PC Free screen appears.



2. Do the following as necessary to locate your files:
  - If you need to display files inside a subfolder on your device, press the arrow buttons to highlight the folder and press the **Enter** button.
  - To move back up a folder level on your device, highlight **Back to Top** and press **Enter**.
  - To view additional files in a folder, highlight **Next page** or **Previous page** and press **Enter**, or press the **Page** up or down buttons on the remote control.
3. To play back a movie, press the arrow buttons to highlight the file and press **Enter**.

**Note:** If any file names are longer than 8 characters or include unsupported symbols, the file names may be shortened or changed only in the screen display. If you want to play back all the movies in a folder in sequence, select the **Slideshow** option at the bottom of the screen.

4. To stop movie playback, press the **Esc** button, highlight **Exit**, and press **Enter**.

**Parent topic:** [Projecting a PC Free Presentation](#)

#### **Related tasks**

[Disconnecting a USB Device or Camera From the Projector](#)

## **PC Free Display Options**

You can select these display options when using the projector's PC Free feature.



<b>Setting</b>	<b>Options</b>	<b>Description</b>
<b>Display Order</b>	<b>Name Order</b>	Displays files in name order
	<b>Date Order</b>	Displays files in date order
<b>Sort Order</b>	<b>In Ascending</b>	Sorts files in first-to-last order
	<b>In Descending</b>	Sorts files in last-to-first order
<b>Continuous Play</b>	<b>On</b>	Displays a slide show continuously
	<b>Off</b>	Displays a slide show one time through
<b>Screen Switching Time</b>	<b>No</b>	Does not display the next file automatically
	1 Second to 60 Seconds	Displays files for the selected time and switches to the next file automatically; high resolution images may switch at a slightly slower rate
<b>Effect</b>	<b>Wipe</b>	Transitions between images with a wipe effect
	<b>Dissolve</b>	Transitions between images with a dissolve effect
	<b>Random</b>	Transitions between images using a random variety of effects

**Parent topic:** [Projecting a PC Free Presentation](#)

---

# Adjusting Projector Features

Follow the instructions in these sections to use your projector's feature adjustments.

[Shutting Off the Picture and Sound Temporarily](#)

[Stopping Video Action Temporarily](#)

[Zooming Into and Out of Images](#)

[Projector Security Features](#)

[Projector Identification System for Multiple Projector Control](#)

[Projecting Two Images Simultaneously](#)

[Scheduling Projector Events](#)

## Shutting Off the Picture and Sound Temporarily

You can temporarily turn off the projected picture and sound if you want to redirect your audience's attention during a presentation. Any sound or video action continues to run, however, so you cannot resume projection at the point that you stopped it.

If you want to display an image such as a company logo or picture when the presentation is stopped, you can set up this feature using the projector's menus.

**Note:** If the picture and sound are off for more than 30 minutes, the power automatically turns off. You can turn this setting on and off using the projector's Eco menu.

1. Press the **A/V Mute** button on the remote control to temporarily stop projection and mute any sound.

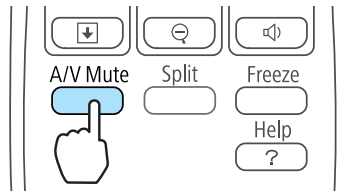

2. To turn the picture and sound back on, press **A/V Mute** again.

**Note:** You can also stop projection using the **A/V Mute** slide lever on the projector.

**Parent topic:** [Adjusting Projector Features](#)

## Related references

[Projector Setup Settings - Extended Menu](#)

## Stopping Video Action Temporarily

You can temporarily stop the action in a video or computer presentation and keep the current image on the screen. Any sound or video action continues to run, however, so you cannot resume projection at the point that you stopped it.

1. Press the **Freeze** button on the remote control to stop the video action.

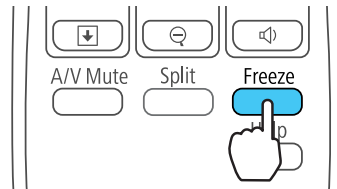

2. To restart the video action in progress, press **Freeze** again.

Parent topic: [Adjusting Projector Features](#)

## Zooming Into and Out of Images

You can draw attention to parts of a presentation by zooming into a portion of the image and enlarging it on the screen.

1. Press the **E-Zoom +** button on the remote control.

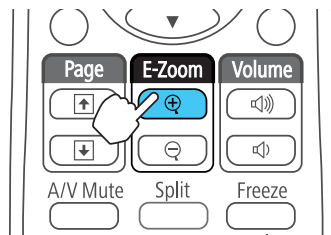

You see a crosshair on the screen indicating the center of the zoom area.

2. Use the following buttons on the remote control to adjust the zoomed image:
  - Use the arrow buttons to position the crosshair in the image area you want to zoom into.
  - Press the **E-Zoom +** button repeatedly to zoom into the image area, enlarging it as necessary. Press and hold the **E-Zoom +** button to zoom in more quickly.
  - To pan around the zoomed image area, use the arrow buttons.
  - To zoom out of the image, press the **E-Zoom –** button as necessary.
  - To return to the original image size, press **Esc**.

Parent topic: [Adjusting Projector Features](#)

## Projector Security Features

You can secure your projector to deter theft or prevent unintended use by setting up the following security features:

- Password security to prevent the projector from being turned on, and prevent changes to the startup screen and other settings.
- Button lock security to block operation of the projector using the buttons on the control panel.
- Security cabling to physically cable the projector in place.

[Password Security Types](#)

[Locking the Projector's Buttons](#)

[Installing a Security Cable](#)

Parent topic: [Adjusting Projector Features](#)

## Password Security Types

You can set up these types of password security using one shared password:

- **Power On Protection** password prevents anyone from using the projector without first entering a password.
- **User's Logo Protection** password prevents anyone from changing the custom screen the projector can display when it turns on or when you use the A/V Mute feature. The presence of the custom screen discourages theft by identifying the projector's owner.
- **Network Protection** password prevents anyone from changing the network settings in the projector menus.
- **Time/Schedule Protection** password prevents anyone from changing the projector's time or schedule settings.

- Setting a Password
- Selecting Password Security Types
- Entering a Password to Use the Projector
- Saving a User's Logo Image to Display

**Parent topic:** Projector Security Features

## Setting a Password

To use password security, you must set a password.

1. Hold down the **Freeze** button on the remote control for about ten seconds or until you see this menu.

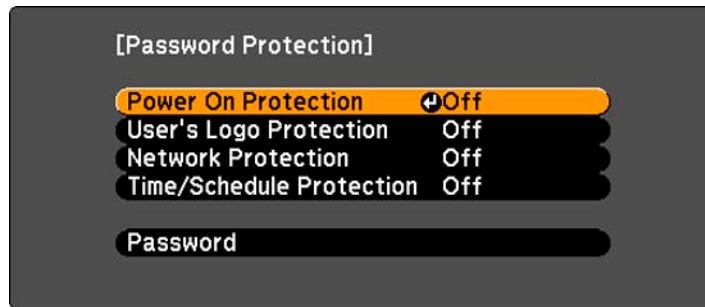

2. Press the down arrow to select **Password** and press **Enter**.  
You see the prompt "Change the password?".
3. Select **Yes** and press **Enter**.
4. Press and hold down the **Num** button on the remote control and use the numeric buttons to set a four-digit password.

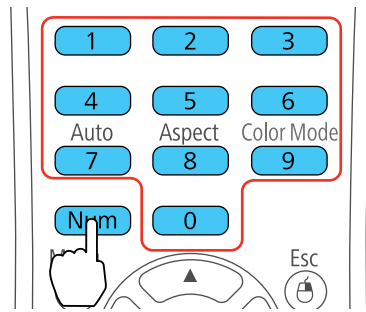

The password displays as \*\*\*\* as you enter it. Then you see the confirmation prompt.

5. Enter the password again.

You see the message "Password accepted."

6. Press **Esc** to return to the menu.
7. Make a note of the password and keep it in a safe place in case you forget it.

**Parent topic:** [Password Security Types](#)

### Selecting Password Security Types

After setting a password, you see this menu, allowing you to select the password security types you want to use.

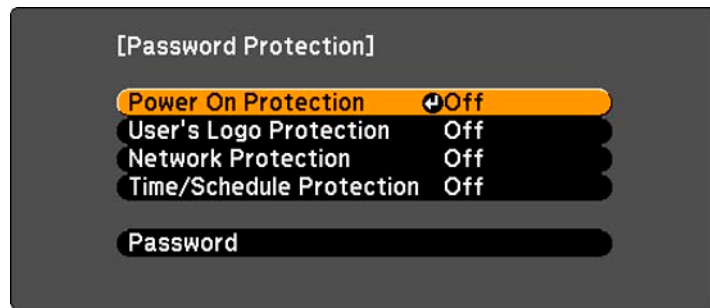

If you do not see this menu, hold down the **Freeze** button on the remote control for five seconds until the menu appears.

1. To prevent unauthorized use of the projector, select **Power On Protection**, press **Enter**, select **On**, press **Enter** again, and press **Esc**.
2. To prevent changes to the User's Logo screen or related display settings, select **User's Logo Protection**, press **Enter**, select **On**, press **Enter** again, and press **Esc**.
3. To prevent changes to network settings, select **Network Protection**, press **Enter**, select **On**, press **Enter** again, and press **Esc**.
4. To prevent changes to the projector's time or schedule settings, select **Time/Schedule Protection**, press **Enter**, select **On**, press **Enter** again, and press **Esc**.

**Note:** Be sure to keep the remote control in a safe place; if you lose it, you will not be able to enter the password required to use the projector.



Parent topic: [Password Security Types](#)

## Entering a Password to Use the Projector

If a password is set up and a **Power On Protection** password is enabled, you see a prompt to enter a password whenever you turn on the projector.

**Note:** This prompt will only appear when the projector is turned on after being unplugged.

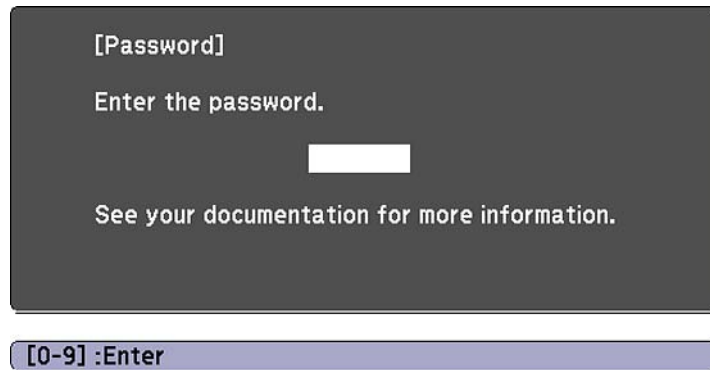

You must enter the correct password to use the projector.

1. Press and hold down the **Num** button on the remote control while you enter the password using the numeric buttons.

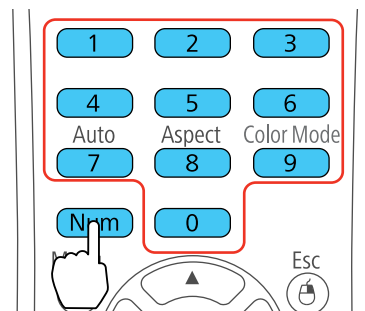

The password screen closes.

2. If the password is incorrect, the following may happen:
  - You see a "wrong password" message and a prompt to try again. Enter the correct password to proceed.
  - If you enter an incorrect password several times in succession, the projector displays a request code and a message to contact Epson Support. When you contact Epson Support, provide the displayed request code and proof of ownership for assistance in unlocking the projector.

**Parent topic:** [Password Security Types](#)

### Saving a User's Logo Image to Display

You can transfer an image to the projector and then display it whenever the projector turns on. You can also display the image when the projector is not receiving an input signal or when you temporarily stop projection (using the A/V Mute feature). This transferred image is called the User's Logo screen.

The image you select as the User's Logo can be a photo, graphic, or company logo, which is useful in identifying the projector's owner to help deter theft. You can prevent changes to the User's Logo by setting up password protection for it.

1. Display the image you want to project as the User's Logo.
2. Press the **Menu** button, select the **Extended** menu, and press **Enter**.

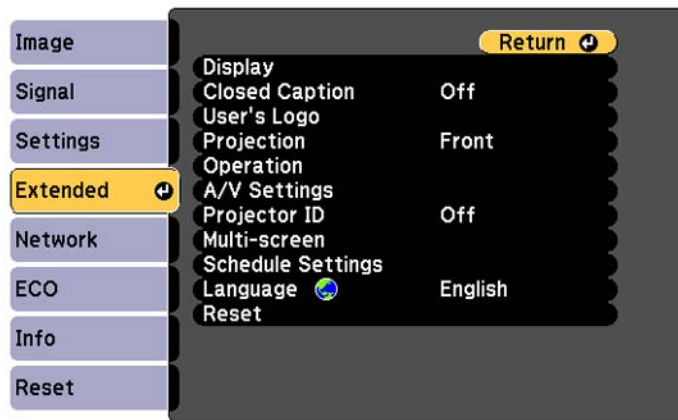

3. Select the **User's Logo** setting and press **Enter**.  
You see a prompt asking if you want to use the displayed image as a user's logo.
4. Select **Yes** and press **Enter**.

You see a selection box overlaying your image.

5. Use the arrow buttons on the remote control to surround the image area you want to use as the User's Logo and press **Enter**.

You see a prompt asking if you want to select this image area.

6. Select **Yes** and press **Enter**. (If you want to change the selected area, select **No**, press **Enter**, and repeat the last step.)

You see the User's Logo zoom factor menu.

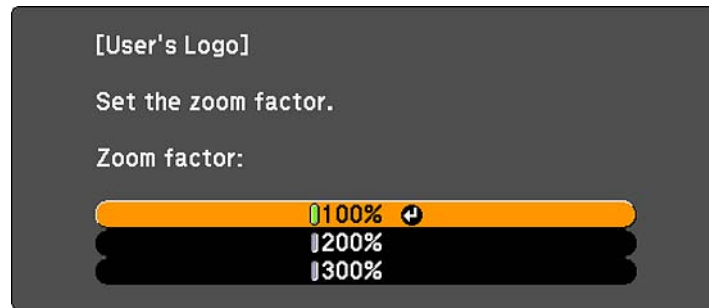

7. Select a zoom percentage and press **Enter**.

You see a prompt asking if you want to save the image as the User's Logo.

8. Select **Yes** and press **Enter**.

**Note:** It takes a few moments for the projector to save the image; do not use the projector, its remote control, or any connected equipment until it is finished.

You see a completion message.

9. Press **Esc** to exit the message screen.
10. Select the **Extended** menu and press **Enter**.
11. Select **Display** and press **Enter**.
12. Select when you want to display the User's Logo screen:
  - To display it whenever there is no input signal, select **Display Background** and set it to **Logo**.
  - To display it whenever you turn the projector on, select **Startup Screen** and set it to **On**.
  - To display it whenever you press the **A/V Mute** button, select **A/V Mute** and set it to **Logo**.

To prevent anyone from changing the User's Logo settings without first entering a password, set a password and enable User's Logo security.

**Parent topic:** [Password Security Types](#)

## Locking the Projector's Buttons

You can lock the buttons on the projector's control panel to prevent anyone from using the projector. You can lock all the buttons or all the buttons except the power button.

1. Press the **Menu** button.
2. Select the **Settings** menu and press **Enter**.

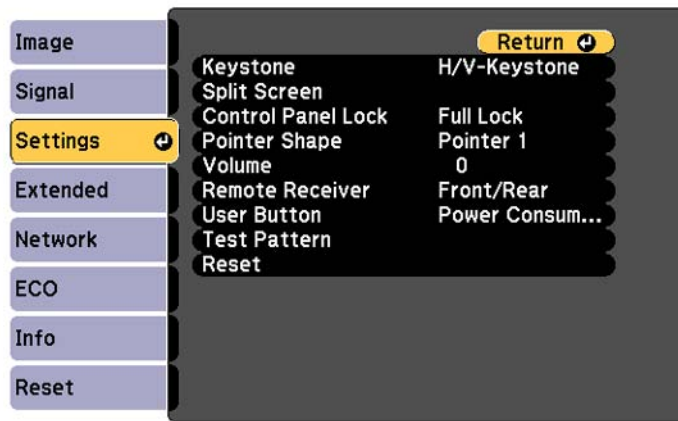

3. Select the **Control Panel Lock** setting and press **Enter**.
4. Select one of these lock types and press **Enter**:
  - To lock all of the projector's buttons, select **Full Lock**.
  - To lock all buttons except the power button, select **Partial Lock**.

You see a confirmation prompt.

5. Select **Yes** and press **Enter**.

[Unlocking the Projector's Buttons](#)

**Parent topic:** [Projector Security Features](#)

## Unlocking the Projector's Buttons

If the projector's buttons have been locked, hold the **Enter** button on the projector's control panel for seven seconds to unlock them.

**Parent topic:** [Locking the Projector's Buttons](#)

## Installing a Security Cable

You can install two types of security cables on the projector to deter theft.

- Use the security slot on the projector to attach a Kensington Microsaver Security system, available from Epson.
- Use the security cable attachment point on the projector to attach a wire cable and secure it to a room fixture or heavy furniture.

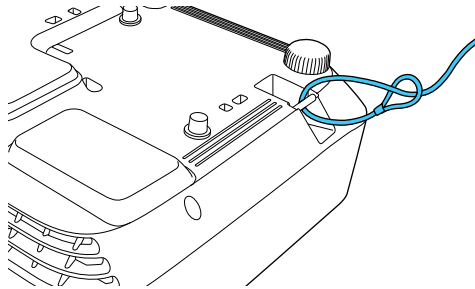

**Note:** Do not pass drop-prevention cables through the security cable attachment point when mounting the projector on a wall or ceiling.

**Parent topic:** [Projector Security Features](#)

**Related references**

[Projector Parts - Rear](#)

## Projector Identification System for Multiple Projector Control

You can operate multiple projectors using one remote control for more elaborate presentations. To do this, you assign an identification number to each projector and to the remote control. Then you can operate all the projectors at once or individually.

You can also match the colors displayed by any projectors you plan to use near each other.

**Caution:** Leave at least 20 inches (50 cm) of space between the projectors to prevent them from overheating.

[Setting the Projector ID](#)

[Setting the Remote Control ID](#)

[Matching Multiple-Projector Display Quality](#)

**Parent topic:** [Adjusting Projector Features](#)

## Setting the Projector ID

If you want to control multiple projectors from a remote control, give each projector a unique ID.

1. Press the **Menu** button.
2. Select the **Extended** menu and press **Enter**.
3. Select **Projector ID** and press **Enter**.

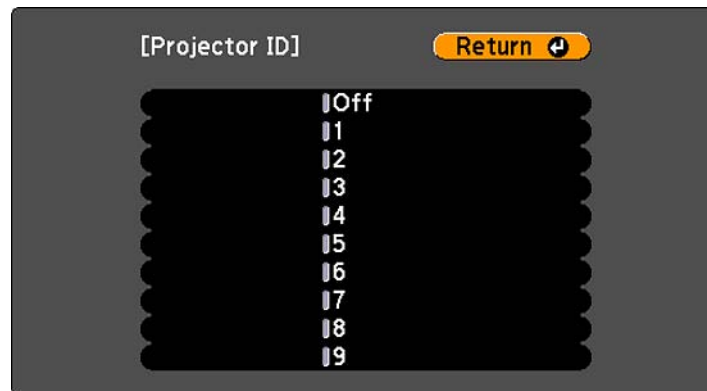

4. Use the arrow buttons on the remote control to select the identification number you want to use for the projector. Then press **Enter**.

Repeat these steps for all the other projectors you want to operate from one remote control.

**Parent topic:** [Projector Identification System for Multiple Projector Control](#)

## Setting the Remote Control ID

The remote control's ID is set to zero by default so it can operate any compatible projector. If you want to set the remote control to operate only a particular projector, you need to set the remote control's ID to match the projector's ID.

1. Turn on the projector you want the remote control to operate with exclusively.
2. Make sure you know the projector's ID number as set in the Extended menu **Projector ID** setting.
3. Aim the remote control at that projector.
4. Hold down the **ID** button on the remote control while you press the numeric button that matches the projector's ID. Then release the buttons.

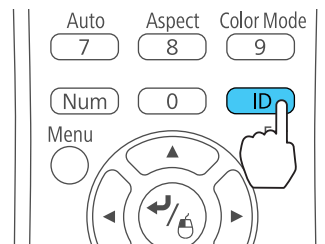

5. Press the **ID** button on the remote control to check if the ID-setting process worked. You see a message displayed by the projector.
  - If the remote control is listed as **On**, the remote control ID is set to operate only the listed projector.
  - If the remote control is listed as **Off**, the remote control ID is not set properly. Repeat the steps above to set the ID to match the projector you want to control.

**Note:** You must set the remote control ID to match the projector ID each time you turn on the projector you have set it to control.

**Parent topic:** [Projector Identification System for Multiple Projector Control](#)

## Matching Multiple-Projector Display Quality

You can match the display quality of multiple projectors that will project next to each other.

1. Turn on all the projectors on which you want to match the display quality.
2. Set ID numbers on each projector.

3. Make sure all the projectors are using the same Color Mode setting.
4. It is best to match two projectors at a time, so set the remote control ID to match the first projector.
5. Press the **Menu** button, select the **Extended** menu, and press **Enter**.

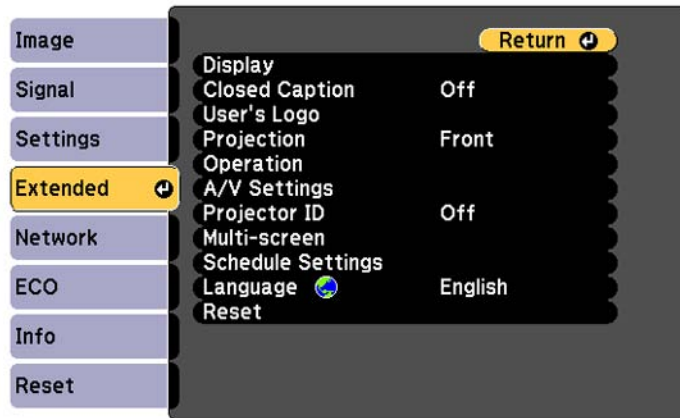

6. Select the **Multi-screen** setting and press **Enter**.
7. Set the **Adjustment Level** setting to **1** and press **Enter**.
8. Set the remote control ID to match the second projector.
9. Access the Extended menu **Multi-screen** setting on the second projector and set the **Adjustment Level** setting to **1**.
10. Adjust the **Brightness Correct.** setting on the projector with the darkest display so it matches the lighter display, and press **Enter**. (You may need to switch the remote control ID back and forth to make adjustments to each projector in all of these steps.)
11. Change the **Adjustment Level** setting to **5** on each projector, but this time match the lighter display to the darker one.
12. Adjust the **Brightness Correct.** setting on **Adjustment Level 2, 3 , and 4** in the same way.
13. Adjust the **Color Correct.** settings for green-to-red (**G/R**) and blue-to-yellow (**B/Y**) balance for all the levels on both projectors in the same way.
14. If you need to match more projectors, repeat these steps matching projector 3 to projector 2, 4 to 3, and so on.

**Parent topic:** [Projector Identification System for Multiple Projector Control](#)



### Related references

[Projector Setup Settings - Extended Menu](#)

### Related tasks

[Changing the Color Mode](#)

## Projecting Two Images Simultaneously

You can use the split screen feature to simultaneously project two images from different image sources next to each other. You can control the split screen feature using the remote control or the projector menus.

**Note:** While you use the split screen feature, other projector features may not be available and some settings may be automatically applied to both images.

1. Press the **Split** button on the remote control.

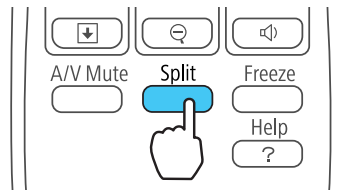

The currently selected input source moves to the left side of the screen.

2. Press the **Menu** button.

You see this screen:

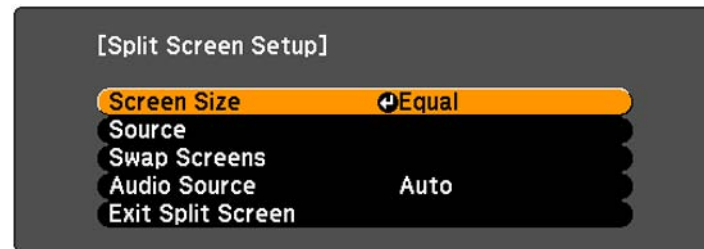

3. To select an input source for the other image, select the **Source** setting, press **Enter**, select the input source, select **Execute**, and press **Enter**. (You can also change image sources, if necessary.)
4. To switch the images, select the **Swap Screens** setting and press **Enter**.
5. To change the image sizes, select the **Screen Size** setting, press **Enter**, select a sizing option, press **Enter**, and press **Menu** to exit.

**Note:** Depending on the video input signals, the images may not appear at the same size even if you choose the **Equal** setting.

6. To choose the audio you want to hear, select the **Audio Source** setting, press **Enter**, select an audio option, press **Enter**, and press **Menu** to exit.

**Note:** Select **Auto** to hear audio from the largest screen or the left screen.

7. To exit the split screen feature, press the **Split** or **Esc** button.

**Parent topic:** [Adjusting Projector Features](#)

## Scheduling Projector Events

You can save a projector command, such as turning the projector on or off or switching input sources, as an "event". You can schedule when you want the projector to automatically execute the command.

**Note:** The Time/Schedule Protection setting in the Password Protection menu must be turned off to schedule an event.

[Saving a Scheduled Event](#)

[Viewing Scheduled Events](#)

[Editing a Scheduled Event](#)

**Parent topic:** [Adjusting Projector Features](#)

## Saving a Scheduled Event

You can select projector commands you want to perform and schedule them as an event.

1. Press the **Menu** button.
2. Select the **Extended** menu and press **Enter**.
3. Select the **Schedule Settings** setting and press **Enter**.

The Schedule Settings screen appears.

4. Select the **Schedule** menu and press **Enter**.
5. Select **Add New** and press **Enter**.
6. In the Event Settings section, select the events you want to have occur. (Select **No Change** for events that you do not want to occur.)
7. In the Date/Time Settings section, set the date and time for the scheduled events to occur.
8. When you are finished, select **Save** and press **Enter**.
9. To schedule more events, repeat the previous 4 steps.
10. Select **Setup complete** and select **Yes** to save your changes.

Parent topic: [Scheduling Projector Events](#)

## Viewing Scheduled Events

You can view any currently scheduled events.

1. Press the **Menu** button.
2. Select the **Extended** menu and press **Enter**.
3. Select the **Schedule Settings** setting and press **Enter**.

You see a screen like this:

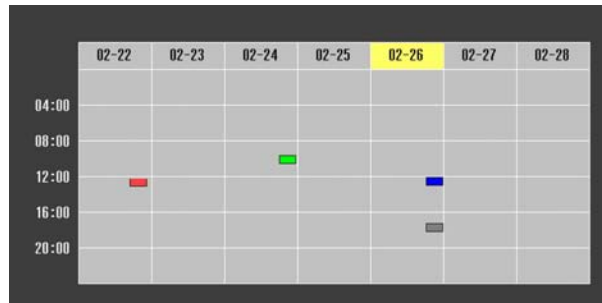

The colored boxes in the calendar indicate the following about the scheduled events:

- One-time event
- Reoccurring event

- Communication is on/off
- Event is invalid

Parent topic: [Scheduling Projector Events](#)

## Editing a Scheduled Event

You can edit any currently scheduled event.

1. Press the **Menu** button.
2. Select the **Extended** menu and press **Enter**.
3. Select the **Schedule Settings** setting and press **Enter**.

You see a screen like this:



4. Press the left or right arrow buttons to highlight the date on the calendar containing the scheduled event you want to edit.
5. Press the up or down arrow buttons to highlight the event you want to edit, and press **Esc**.
6. Select one of the following:
  - **On/Off**: Enable or disable the selected event.
  - **Edit**: Edit the settings for the selected event.
  - **Clear**: Delete the selected event.
  - **Add New**: Add a new scheduled event.
7. When you are finished, select **Return** and press **Enter**.

8. Select **Setup complete** and select **Yes** to save your changes.

**Note:** To delete all scheduled events, select **Schedule Reset** and select **Yes**.

**Parent topic:** [Scheduling Projector Events](#)

---

# Adjusting the Menu Settings

Follow the instructions in these sections to access the projector menu system and change projector settings.

[Using the Projector's Menus](#)

[Image Quality Settings - Image Menu](#)

[Input Signal Settings - Signal Menu](#)

[Projector Feature Settings - Settings Menu](#)

[Projector Setup Settings - Extended Menu](#)

[Projector Network Settings - Network Menu](#)

[Projector Setup Settings - ECO Menu](#)

[Projector Information Display - Info Menu](#)

[Projector Reset Options - Reset Menu](#)

## Using the Projector's Menus

You can use the projector's menus to adjust the settings that control how your projector works. The projector displays the menus on the screen.

1. Press the **Menu** button on the control panel or remote control.

You see the menu screen displaying the Image menu settings.

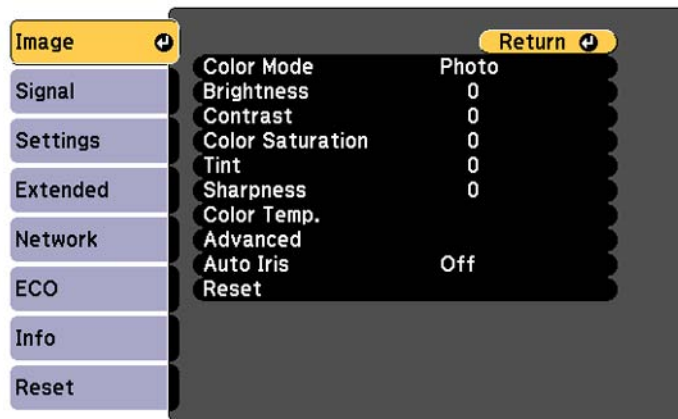

2. Press the up or down arrow buttons to move through the menus listed on the left. The settings for each menu are displayed on the right.

**Note:** The available settings depend on the current input source.

3. To change settings in the displayed menu, press **Enter**.
4. Press the up or down arrow button to move through the settings.
5. Change the settings using the buttons listed on the bottom of the menu screens.
6. To return all the menu settings to their default values, select **Reset**.
7. When you finish changing settings on a menu, press **Esc**.
8. Press **Menu** or **Esc** to exit the menus.

**Parent topic:** [Adjusting the Menu Settings](#)

## Image Quality Settings - Image Menu

Settings on the Image menu let you adjust the quality of your image for the input source you are currently using. The available settings depend on the currently selected input source.

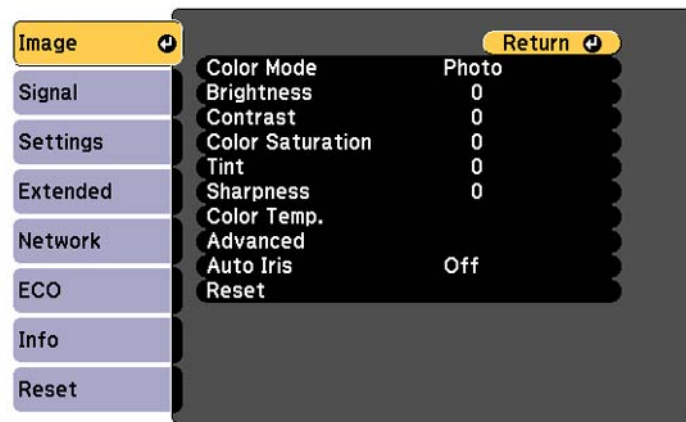

To change settings for an input source, make sure the source is connected and select that source.

Setting	Options	Description
<b>Color Mode</b>	See the list of available Color Modes	Adjusts the vividness of image colors for various image types and environments
<b>Brightness</b>	Varying levels available	Lightens or darkens the overall image
<b>Contrast</b>	Varying levels available	Adjusts the difference between light and dark areas of the image
<b>Color Saturation</b>	Varying levels available	Adjusts the intensity of the image colors
<b>Tint</b>	Varying levels available	Adjusts the balance of green to magenta tones in the image
<b>Sharpness</b>	Varying levels available	Adjusts the sharpness or softness of image details
<b>Color Temp.</b>	Varying levels available	Sets the color tone based on color temperature
<b>Advanced</b>	Various options available	Adjusts the gamma levels and intensity of individual hues in the image
<b>Auto Iris</b>	<b>Off</b> <b>Normal</b> <b>High Speed</b>	Adjusts the projected luminance based on the image brightness when the <b>Dynamic</b> and <b>Theatre</b> Color Modes are selected; <b>High Speed</b> sets faster luminance correction for fast-moving images

**Note:** The **Brightness** setting does not affect lamp brightness. To change the lamp brightness mode, use the **Power Consumption** setting.

**Parent topic:** [Adjusting the Menu Settings](#)

**Related references**

[Available Color Modes](#)



## Input Signal Settings - Signal Menu

Normally the projector detects and optimizes the input signal settings automatically. If you need to customize the settings, you can use the Signal menu. The available settings depend on the currently selected input source.

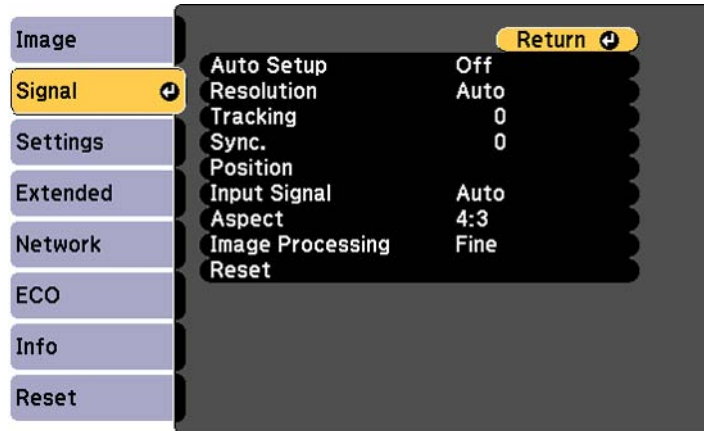

**Note:** You can restore the default settings of the **Position**, **Tracking**, and **Sync** settings by pressing the **Auto** button on the remote control.

To change settings for an input source, make sure the source is connected and select that source.

Setting	Options	Description
<b>Auto Setup</b>	<b>On</b> <b>Off</b>	Automatically optimizes computer image quality (when On)
<b>Resolution</b>	<b>Auto</b> <b>Wide</b> <b>Normal</b>	Sets the input signal resolution if not detected automatically using the <b>Auto</b> option
<b>Tracking</b>	Varying levels available	Adjusts signal to eliminate vertical stripes in computer images

Setting	Options	Description
<b>Sync.</b>	Varying levels available	Adjusts signal to eliminate fuzziness or flickering in computer images
<b>Position</b>	Up, down, left, right	Adjusts the image location on the screen
<b>Progressive</b>	<b>Off</b> <b>Video</b> <b>Film/Auto</b>	Sets whether to convert interlaced-to-progressive signals for certain video image types <b>Off:</b> for fast-moving video images <b>Video:</b> for most video images <b>Film/Auto:</b> for movies, computer graphics, and animation
<b>Noise Reduction</b>	<b>Off</b> <b>NR1</b> <b>NR2</b>	Reduces flickering in analog images in two levels
<b>HDMI Video Range</b>	<b>Auto</b> <b>Normal</b> <b>Expanded</b>	Sets the video range to match the setting of the device connected to the HDMI input port <b>Auto:</b> detects the video range automatically <b>Normal:</b> normally for images from a device other than a computer; can also be selected if the black areas of the image are too bright <b>Expanded:</b> normally for images from a computer; can also be selected if the image is too dark

Setting	Options	Description
<b>Input Signal</b>	<b>Auto</b> <b>RGB</b> <b>Component</b>	Specifies the signal type from input sources connected to computer ports  <b>Auto:</b> detects signals automatically <b>RGB:</b> corrects color for computer/RGB video inputs <b>Component:</b> corrects color for component video inputs
<b>Video Signal</b>	<b>Auto</b> Various video standards	Specifies the signal type from the input sources connected to the video ports  <b>Auto:</b> detects signals automatically
<b>Aspect</b>	See the list of available aspect ratios	Sets the aspect ratio (width-to-height ratio) for the selected input source
<b>Overscan</b>	<b>Auto</b> <b>Off</b> 4% 8%	Changes the projected image ratio to make the edges visible by a selectable percentage or automatically
<b>Image Processing</b>	<b>Fine</b> <b>Fast</b>	Adjusts image processing speed/quality

**Note:** The **Noise Reduction** setting is not available if you have done the following:

- Set the **Image Processing** option to **Fast**
- Set the **Progressive** setting to **Off**
- Selected a digital RGB or an interlaced (480i/567i/1080i) input signal

**Parent topic:** [Adjusting the Menu Settings](#)

## Related references

[Available Image Aspect Ratios](#)

# Projector Feature Settings - Settings Menu

Options on the Settings menu let you customize various projector features. The available settings depend on the currently selected input source.

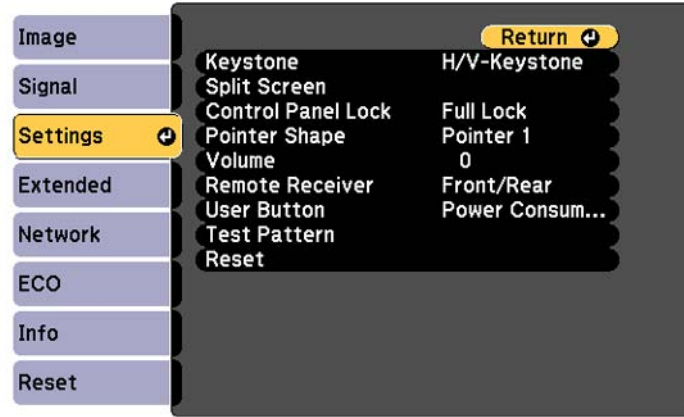

Setting	Options	Description
Keystone	H/V Keystone Quick Corner	Adjusts image shape to rectangular (horizontally and vertically)  <b>H/V Keystone:</b> lets you manually correct horizontal and vertical sides, or turn automatic correction on or off  <b>Quick Corner:</b> select to correct image shape and alignment using an on-screen display

Setting	Options	Description
<b>Split Screen</b>	<b>Screen Size</b> <b>Source</b> <b>Swap Screens</b> <b>Audio Source</b>	Divides the viewing area horizontally and displays two images side-by-side (press <b>Esc</b> to cancel split screen display)
<b>Control Panel Lock</b>	<b>Full Lock</b> <b>Partial Lock</b> <b>Off</b>	Controls projector button locking to secure the projector  <b>Full Lock:</b> locks all buttons <b>Partial Lock:</b> locks all buttons except the power button <b>Off:</b> no buttons locked
<b>Pointer Shape</b>	Three shapes available	Changes the shape of the remote control pointer feature
<b>Volume</b>	Varying levels available	
<b>Remote Receiver</b>	<b>Front</b> <b>Rear</b> <b>Front/Rear</b> <b>Off</b>	Limits reception of remote control signals by the selected receiver; <b>Off</b> turns off all receivers
<b>User Button</b>	<b>Power Consumption</b> <b>Info</b> <b>Progressive</b> <b>Closed Caption</b> <b>Test Pattern</b> <b>Resolution</b> <b>Multi-screen</b>	Assigns a menu option to the <b>User</b> button on the remote control for one-touch access
<b>Test Pattern</b>	—	Displays a test pattern to assist in focusing and zooming the image and correcting image shape (press <b>Esc</b> to cancel pattern display)

**Parent topic:** [Adjusting the Menu Settings](#)

**Related tasks**

[Correcting Image Shape with Quick Corner](#)

[Projecting Two Images Simultaneously](#)

[Locking the Projector's Buttons](#)

## Projector Setup Settings - Extended Menu

Settings on the Extended menu let you customize various projector setup features that control its operation.

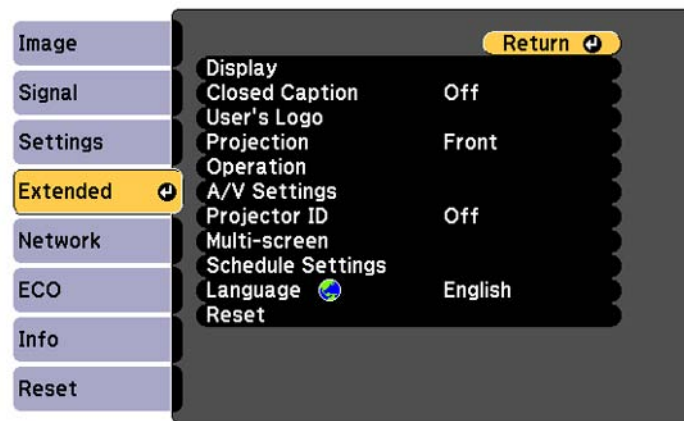

Setting	Options	Description
<b>Display</b>	<b>Messages</b> <b>Display Background</b> <b>Startup Screen</b> <b>A/V Mute</b>	Selects various display options <b>Messages:</b> controls whether messages are displayed on the screen <b>Display Background:</b> selects the screen color or logo to display when no signal is received <b>Startup Screen:</b> controls whether a special screen appears when the projector starts up <b>A/V Mute:</b> selects the screen color or logo to display when A/V Mute is turned on
<b>Closed Caption</b>	<b>Off</b> <b>CC1</b> <b>CC2</b>	Controls use of closed captions and selects the closed caption type (closed captions are only visible for NTSC signals connected through the <b>S-Video</b> or <b>Video</b> ports)
<b>User's Logo</b>	–	Creates a screen that the projector displays to identify itself and enhance security
<b>Projection</b>	<b>Front</b> <b>Front/Ceiling</b> <b>Rear</b> <b>Rear Ceiling</b>	Selects the way the projector faces the screen so the image is oriented correctly

Setting	Options	Description
<b>Operation</b>	<b>Direct Power On</b> <b>High Altitude Mode</b> <b>Startup Source Search</b> <b>Auto Power On</b> <b>Date &amp; Time</b>	Selects various operation options  <b>Direct Power On:</b> lets you turn on the projector without pressing the power button  <b>High Altitude Mode:</b> regulates the projector's operating temperature at altitudes above 4921 feet (1500 m)  <b>Startup Source Search:</b> automatically detects the image signal that is input when the projector is turned on  <b>Auto Power On:</b> lets you turn on the projector by turning on a computer connected to the <b>Computer</b> port  <b>Date &amp; Time:</b> adjusts the projector's system time and date settings



Setting	Options	Description
<b>A/V Settings</b>	<b>A/V Output</b> <b>Audio Output</b> <b>HDMI1 Audio Output</b> <b>HDMI2 Audio Output</b>	<p>Selects the following when the projector is in standby mode (turned off):</p> <p><b>A/V Output:</b> The <b>Always On</b> setting lets the projector output audio and video signals even while it is standby mode. Available only when <b>Standby Mode</b> is set to <b>Communication On</b></p> <p><b>Audio Output:</b> Selects the audio input port when projecting images from the <b>Computer</b>, <b>Video</b>, and <b>USB-A</b> ports.</p> <p><b>HDMI1 Audio Output</b> and <b>HDMI2 Audio Output:</b> Selects which Audio port provides audio output when viewing images from the <b>HDMI 1/MHL</b> and <b>HDMI 2</b> ports on the projector.</p>
<b>Projector ID</b>	<b>Off</b> <b>1 through 9</b>	Assigns an ID for the projector when you use multiple projectors
<b>Multi-screen</b>	<b>Adjustment Level (1 to 9)</b> <b>Brightness Correct.</b> <b>Color Correct.</b>	Matches display qualities and colors of multiple projectors
<b>Schedule Settings</b>	Various scheduling options available	Sets the projector's date and time settings and schedules various tasks
<b>Language</b>	Various languages available	Selects the language for projector menu and message displays (not changed by <b>Reset</b> option)

**Note:** When the **User's Logo Protection** option in the Password Protection menu is set to **On**, you cannot change any settings related to the user's logo.

**Parent topic:** [Adjusting the Menu Settings](#)

**Related concepts**

[Projector Identification System for Multiple Projector Control](#)

**Related topics**

[Scheduling Projector Events](#)

## Projector Network Settings - Network Menu

Settings on the Network menu let you view network information and set up the projector for monitoring and control over a network.

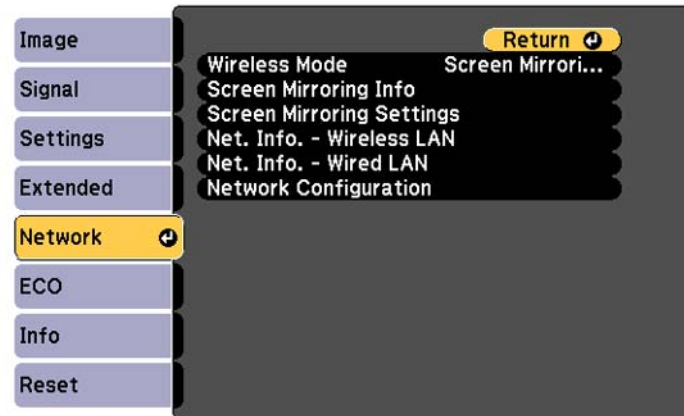

Setting	Options	Description
<b>Wireless Mode</b> (PowerLite 1975W/1985WU)	<b>Screen Mirroring On</b> <b>Wireless LAN On</b> <b>Both Settings Off</b>	Switches between wireless LAN and screen mirroring connection modes
<b>Wireless Mode</b> (PowerLite 1970W)	<b>Wireless LAN On</b> <b>Off</b>	Turns on wireless LAN mode

<b>Setting</b>	<b>Options</b>	<b>Description</b>
<b>Screen Mirroring Info</b> (PowerLite 1975W/1985WU)	<b>Display Name</b> <b>MAC Address</b> <b>Region Code</b> <b>Version</b>	Displays screen mirroring status and details
<b>Screen Mirroring Settings</b> (PowerLite 1975W/1985WU)	Accesses screen mirroring settings	Configures your screen mirroring settings
<b>Net. Info - Wireless LAN</b> (PowerLite 1970W/1975W/1985WU)	<b>Connection mode</b> <b>Wireless LAN Sys.</b> <b>Antenna level</b> <b>Projector Name</b> <b>SSID</b> <b>DHCP</b> <b>IP Address</b> <b>Subnet Mask</b> <b>Gateway Address</b> <b>MAC Address</b> <b>Region Code</b>	Displays wireless network status and details
<b>Net. Info - Wired LAN</b>	<b>Projector Name</b> <b>DHCP</b> <b>IP Address</b> <b>Subnet Mask</b> <b>Gateway Address</b> <b>MAC Address</b>	Displays wired network status and details
<b>Network Configuration</b>	Accesses additional network menus	Configures your network settings

Parent topic: [Adjusting the Menu Settings](#)

### Related concepts

[Wireless Network Projection from a Mobile Device \(Screen Mirroring\)](#)

[Wired Network Projection](#)

[Wireless Network Projection](#)

## Projector Setup Settings - ECO Menu

Settings on the ECO menu let you customize projector functions to save power. When you select a power-saving setting, a leaf icon appears next to the menu item.

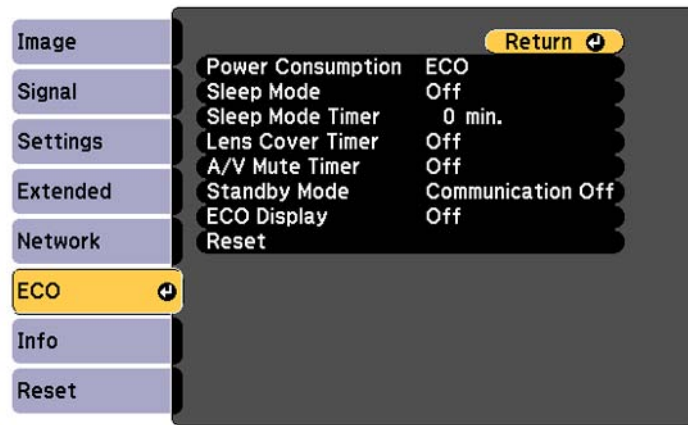

Setting	Options	Description
Power Consumption	Auto Normal ECO	Selects the brightness mode of the projector lamp  <b>Auto:</b> sets the projector to sense the optimum lamp brightness and adjust the lamp brightness accordingly  <b>Normal:</b> sets maximum lamp brightness  <b>ECO:</b> reduces lamp brightness and fan noise, and saves power and lamp life

Setting	Options	Description
<b>Sleep Mode</b>	<b>On</b> <b>Off</b>	Automatically places the projector in standby mode after an interval of inactivity
<b>Sleep Mode Timer</b>	1 to 30 minutes	Sets the interval for Sleep Mode
<b>Lens Cover Timer</b>	<b>On</b> <b>Off</b>	Automatically turns off the projector after 30 minutes if the lens cover is closed
<b>A/V Mute Timer</b>	<b>On</b> <b>Off</b>	Automatically turns off the projector after 30 minutes if <b>A/V Mute</b> is enabled
<b>Standby Mode</b>	<b>Communication On</b> <b>Communication Off</b>	<p><b>Communication On</b> indicates that the projector can be monitored over a network when the projector is in standby mode. Enable this setting to allow the following operations to occur when the projector is in standby mode:</p> <ul style="list-style-type: none"> <li>• Monitor and control the projector over a network</li> <li>• Output audio and video to an external device (A/V Output must be set to <b>Always On</b>)</li> </ul>
<b>ECO Display</b>	<b>On</b> <b>Off</b>	Displays a leaf icon in the bottom left corner of the projected screen to indicate the power-saving status when the lamp brightness changes

Parent topic: [Adjusting the Menu Settings](#)

## Projector Information Display - Info Menu

You can display information about the projector and input sources by viewing the Info menu. However, you cannot change any settings in the menu.

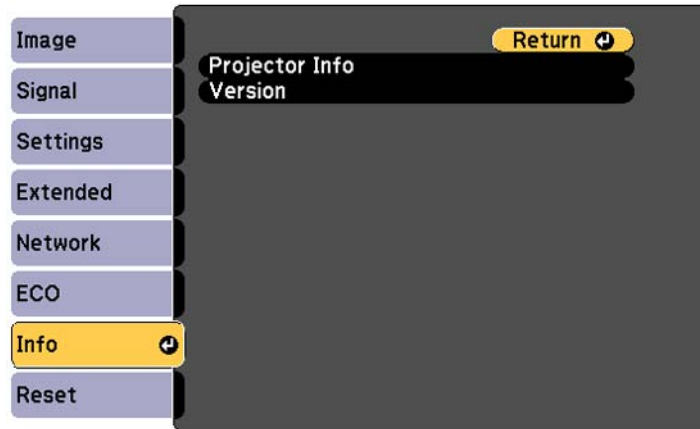

Select **Version** to display the projector's firmware version. Select **Projector Info** to display the settings described below.

**Note:** Available settings depend on the current input source. The lamp usage timer does not register any hours until you have used the lamp for at least 10 hours.

Information item	Description
<b>Lamp Hours</b>	Displays the number of hours ( <b>H</b> ) the lamp has been used in <b>Normal</b> and <b>ECO</b> Power Consumption modes; if the information is displayed in yellow, obtain a genuine Epson replacement lamp soon
<b>Source</b>	Displays the name of the port to which the current input source is connected
<b>Input Signal</b>	Displays the input signal setting of the current input source
<b>Resolution</b>	Displays the resolution of the current input source
<b>Video Signal</b>	Displays the video signal format of the current input source

Information item	Description
<b>Refresh Rate</b>	Displays the refresh rate of the current input source
<b>Sync Info</b>	Displays information that may be needed by a service technician
<b>Status</b>	Displays information about projector problems that may be needed by a service technician
<b>Serial Number</b>	Displays the projector's serial number
<b>Event ID</b>	Displays the Event ID number corresponding to a specific projector problem; see the list of Event ID codes

[Event ID Code List](#)

**Parent topic:** [Adjusting the Menu Settings](#)

**Related references**

[Optional Equipment and Replacement Parts](#)

[Projector Lamp Specifications](#)

## Event ID Code List

If the **Event ID** option on the Info menu displays a code number, check this list of Event ID codes for the solution to the projector problem associated with the code.

Event ID code	Cause and solution
0432	The EasyMP Network Projection program did not start. Turn the projector off and then on again.
0435	
0434	Unstable network communication. Check the network communication status, wait a few moments, and try connecting to the network again.
0481	
0482	
0485	
0433	Cannot display the transferred images. Restart the EasyMP Network Projection program.
0484	Communication with computer was disconnected. Restart the EasyMP Network Projection program.

Event ID code	Cause and solution
0483	The EasyMP Network Projection program quit unexpectedly. Check the network communication status, then turn the projector off and then on again.
04FE	
0479	A projector system error has occurred. Turn the projector off and then on again.
04FF	
0891	Cannot find an access point with the same SSID. Set your computer, access point, and projector to the same SSID.
0892	The WPA/WPA2 authentication type does not match. Make sure the wireless network security settings are correct.
0893	The WEP/TKIP/AES encryption type does not match. Make sure the wireless network security settings are correct.
0894	Communication with unauthorized access point was disconnected. Contact your network administrator.
0898	Failed to acquire DHCP address. Make sure the DHCP server is operating correctly. If you are not using DHCP, turn off the <b>DHCP</b> setting in the Network menus.
0899	A communication error has occurred. Try restarting the EasyMP Network Projection program and restarting your projector. If that does not solve the problem, contact Epson for help.

Parent topic: [Projector Information Display - Info Menu](#)

## Projector Reset Options - Reset Menu

You can reset most of the projector settings to their default values using the **Reset All** option on the Reset menu.



You can also reset the projector's lamp usage timer to zero when you replace the lamp using the **Reset Lamp Hours** option.

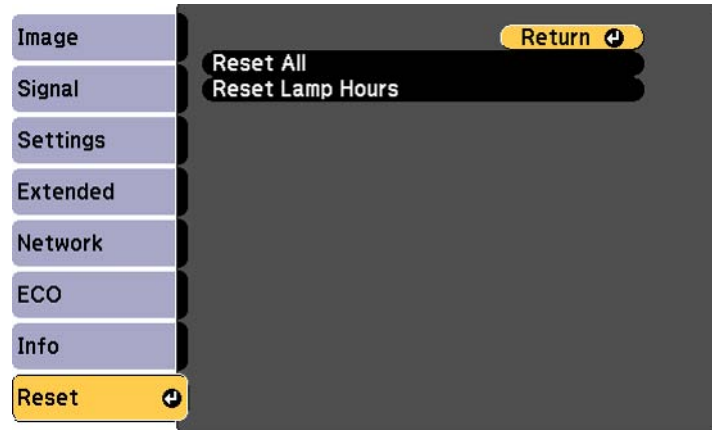

You cannot reset the following settings using the **Reset All** option:

- Input Signal
- User's Logo
- Schedule Settings
- Language
- Network menu items (if available)
- Lamp Hours
- Password
- Multi-screen
- Date & Time

**Parent topic:** [Adjusting the Menu Settings](#)

---

# Maintaining and Transporting the Projector

Follow the instructions in these sections to maintain your projector and transport it from place to place.

[Projector Maintenance](#)

[Transporting the Projector](#)

## Projector Maintenance

Your projector needs little maintenance to keep working at its best.

You may need to clean the lens periodically, and clean the air filter and air vents to prevent the projector from overheating due to blocked ventilation.

The only parts you should replace are the lamp, air filter, and remote control batteries. If any other part needs replacing, contact Epson or an authorized Epson servicer.

**Warning:** Before cleaning any part of the projector, turn it off and unplug the power cord. Never open any cover on the projector, except as specifically explained in this manual. Dangerous electrical voltages in the projector can injure you severely.

**Warning:** Do not try to service this product yourself, except as specifically explained in this manual. Refer all other servicing to qualified servicers.

[Cleaning the Lens](#)

[Cleaning the Projector Case](#)

[Air Filter and Vent Maintenance](#)

[Projector Lamp Maintenance](#)

[Replacing the Remote Control Batteries](#)

**Parent topic:** [Maintaining and Transporting the Projector](#)

## Cleaning the Lens

Clean the projector's lens periodically, or whenever you notice dust or smudges on the surface.

- To remove dust or smudges, gently wipe the lens with lens-cleaning paper.

- To remove stubborn smudges, moisten a soft, lint-free cloth with lens cleaner and gently wipe the lens. Do not spray any liquid directly on the lens.

**Warning:** Do not use a lens cleaner that contains flammable gas. The high heat generated by the projector lamp may cause a fire.

**Caution:** Do not use glass cleaner or any harsh materials to clean the lens and do not subject the lens to any impacts; you may damage it. Do not use canned air, or the gases may leave a residue. Avoid touching the lens with your bare hands to prevent fingerprints on or damage to the lens surface.

**Parent topic:** [Projector Maintenance](#)

## Cleaning the Projector Case

Before cleaning the projector case, turn off the projector and unplug the power cord.

- To remove dust or dirt, use a soft, dry, lint-free cloth.
- To remove stubborn dirt, use a soft cloth moistened with water and mild soap. Do not spray liquid directly on the projector.

**Caution:** Do not use wax, alcohol, benzene, paint thinner, or other chemicals to clean the projector case. These can damage the case. Do not use canned air, or the gases may leave a flammable residue.

**Parent topic:** [Projector Maintenance](#)

## Air Filter and Vent Maintenance

Regular filter maintenance is important to maintaining your projector. Your Epson projector is designed with an easily accessible, user-replaceable filter to protect your projector and make regular maintenance simple. Filter maintenance intervals will depend on the environment.

If regular maintenance is not performed, your Epson projector will notify you when the temperature inside the projector has reached a high level. Do not wait until this warning appears to maintain your projector filter as prolonged exposure to high temperatures may reduce the life of your projector or lamp.

Damage due to the failure to properly maintain the projector or its filter may not be covered by the projector or lamp Limited Warranties.

[Cleaning the Air Filter and Vents](#)

[Replacing the Air Filter](#)

**Parent topic:** [Projector Maintenance](#)

## Cleaning the Air Filter and Vents

Clean the projector's air filter or vents if they get dusty, or if you see a message telling you to clean them.

1. Turn off the projector and unplug the power cord.
2. Gently remove the dust using a small vacuum designed for computers or a very soft brush (such as a paintbrush).

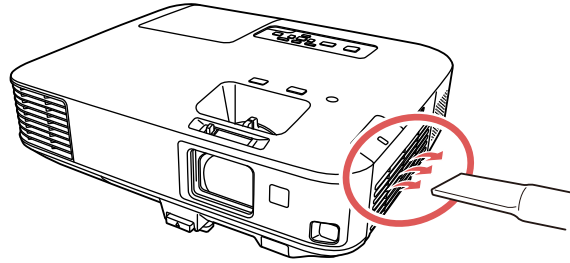

**Note:** You can remove the air filter so you can clean both sides of it. Do not rinse the air filter in water, or use any detergent or solvent to clean it.

**Caution:** Do not use canned air. The gases may leave a flammable residue or push dust and debris into the projector's optics or other sensitive areas.

3. If dust is difficult to remove or the air filter is damaged, replace the air filter.

**Parent topic:** [Air Filter and Vent Maintenance](#)

## Replacing the Air Filter

You need to replace the air filter in the following situations:

- After cleaning the air filter, you see a message telling you to clean or replace it
- The air filter is torn or damaged

You can replace the air filter while the projector is mounted to the ceiling or placed on a table.

1. Turn off the projector and unplug the power cord.

2. Slide the air filter cover latch and open the air filter cover.

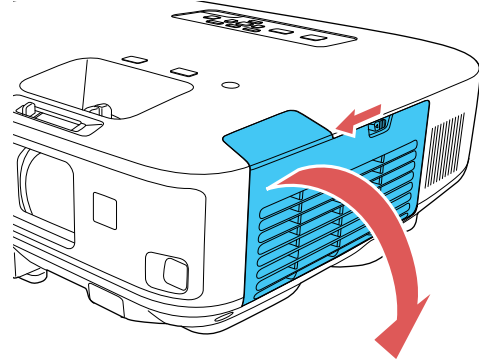

3. Pull the air filter out of the projector.

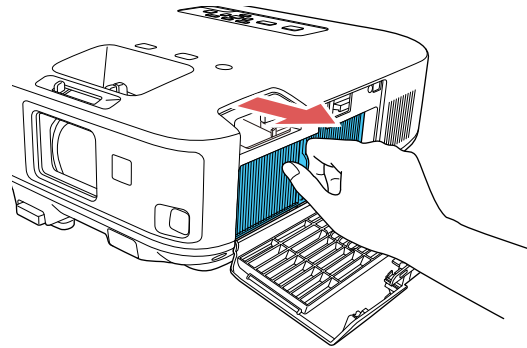

**Note:** Air filters contain polypropylene. Dispose of used air filters according to local regulations.

4. Place the new air filter in the projector as shown and push gently until it clicks into place.

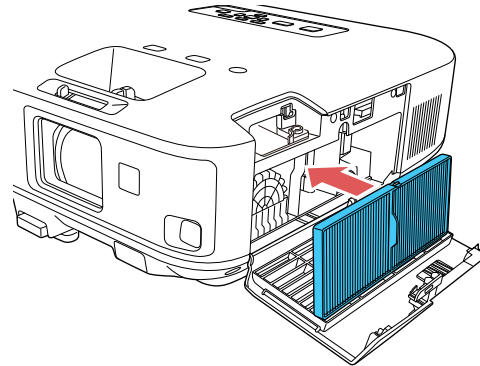

5. Close the air filter cover.

**Parent topic:** [Air Filter and Vent Maintenance](#)

**Related references**

[Optional Equipment and Replacement Parts](#)

## Projector Lamp Maintenance

The projector keeps track of the number of hours the lamp is used and displays this information in the projector's menu system.

Replace the lamp as soon as possible when the following occurs:

- The projected image gets darker or starts to deteriorate
- A message appears when you turn on the projector telling you to replace the lamp
- The projector's lamp light is flashing orange

[Replacing the Lamp](#)

[Resetting the Lamp Timer](#)

**Parent topic:** [Projector Maintenance](#)

**Related references**

[Optional Equipment and Replacement Parts](#)

[Projector Lamp Specifications](#)

## Replacing the Lamp

Before you replace the lamp, let the projector cool down for at least one hour so the lamp will not be hot.

**Warning:** Let the lamp fully cool before replacing it to avoid injury.

You can replace the lamp while the projector is mounted to the ceiling, if necessary.

1. Turn off the projector and unplug the power cord.
2. Allow the projector lamp to cool down for at least one hour.
3. Use the screwdriver included with the replacement lamp to loosen the screw securing the lamp cover.

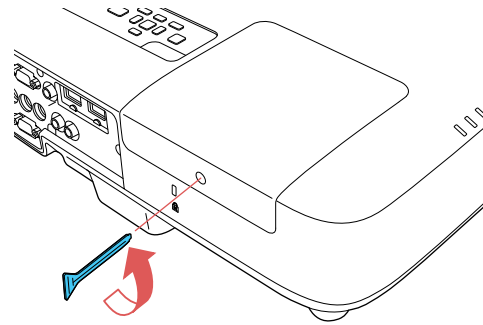

**Warning:** If the lamp is broken, glass fragments may be loose inside the lamp chamber. Be careful removing any broken glass to avoid injury.

4. Slide the lamp cover out and lift it off.

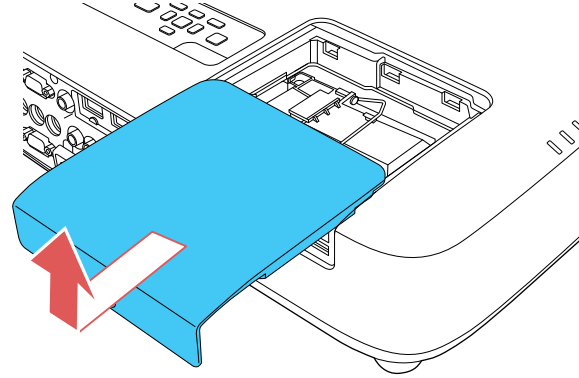



5. Loosen the screws securing the lamp to the projector. The screws do not come all the way out.

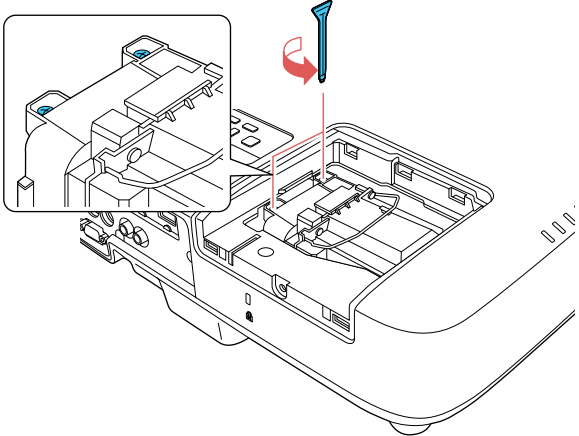
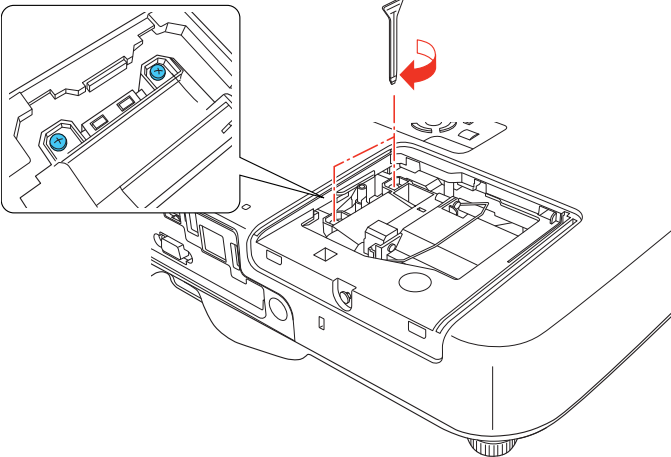

6. Lift up the lamp handle and gently pull the lamp out of the projector.

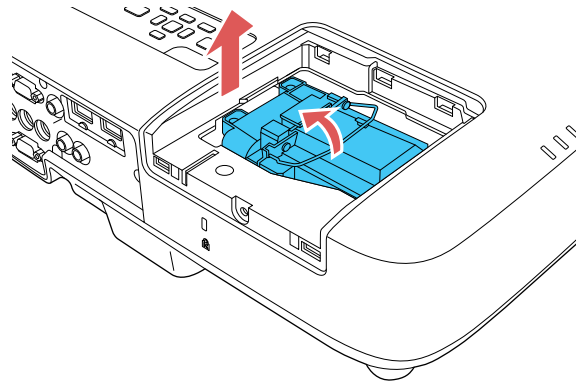

**Note:** (Hg) The lamp(s) in this product contain mercury. Please consult your state and local regulations regarding disposal or recycling. Do not put in the trash.

7. Gently insert the new lamp into the projector. If it does not fit easily, make sure it is facing the right way. Press the handle down.

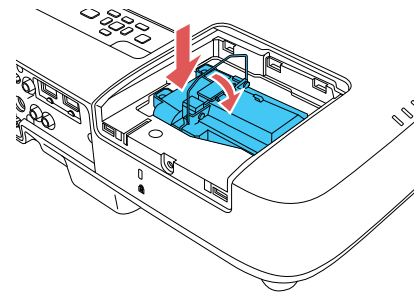

**Caution:** Do not touch any glass on the lamp assembly to avoid premature lamp failure.

8. Push in the lamp firmly and tighten the screws to secure it.

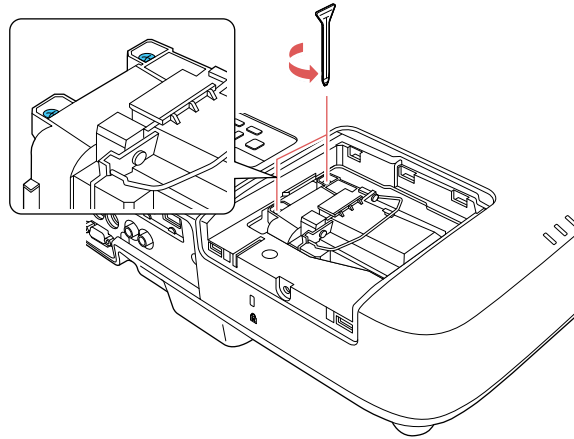

9. Replace the lamp cover and tighten the screw to secure it.

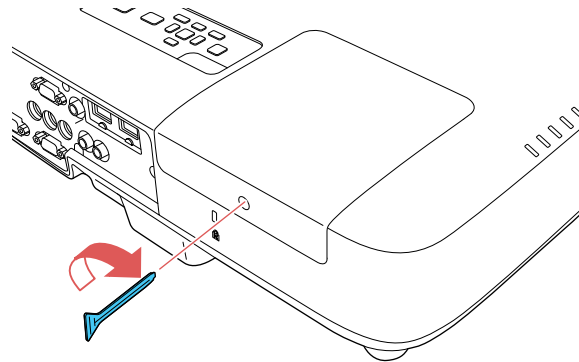

**Note:** Be sure the lamp cover is securely installed or the lamp will not come on.

Reset the lamp timer to zero to keep track of the new lamp's usage.

**Parent topic:** [Projector Lamp Maintenance](#)

**Related tasks**

[Resetting the Lamp Timer](#)

## Resetting the Lamp Timer

You must reset the lamp timer after replacing the projector's lamp to clear the lamp replacement message and to keep track of lamp usage correctly.

**Note:** Do not reset the lamp timer if you have not replaced the lamp to avoid inaccurate lamp usage information.

1. Turn on the projector.
2. Press the **Menu** button.
3. Select the **Reset** menu and press **Enter**.

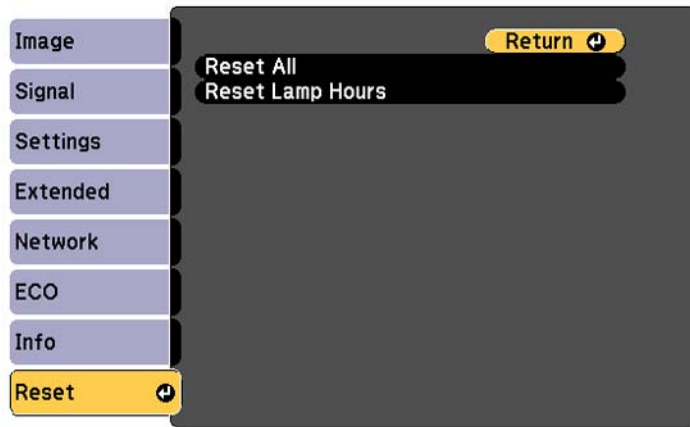

4. Select **Reset Lamp Hours** and press **Enter**.  
You see a prompt asking if you want to reset the lamp hours.
5. Select **Yes** and press **Enter**.
6. Press **Menu** or **Esc** to exit the menus.

**Parent topic:** [Projector Lamp Maintenance](#)

### Related tasks

[Replacing the Lamp](#)

## Replacing the Remote Control Batteries

The remote control uses two AA manganese or alkaline batteries. Replace the batteries as soon as they run out.

**Caution:** Use only the type of batteries specified in this manual. Do not install batteries of different types, or mix new and old batteries.

1. Open the battery cover as shown.

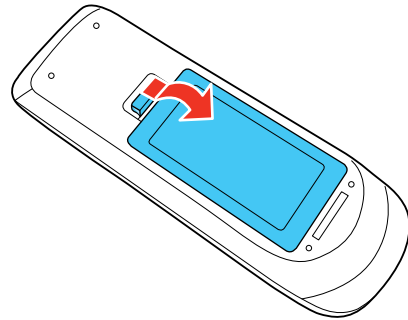

2. Remove the old batteries.

**Warning:** If the battery fluid has leaked, wipe it away with a soft cloth and avoid getting the fluid on your hands. If it gets on your hands, wash them immediately to avoid injury.

3. Insert the batteries with the + and – ends facing as shown.

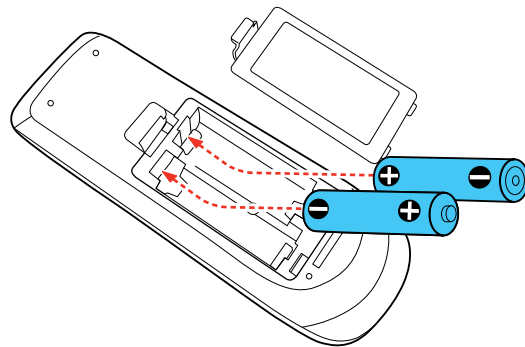

4. Close the battery cover and press it down until it clicks into place.

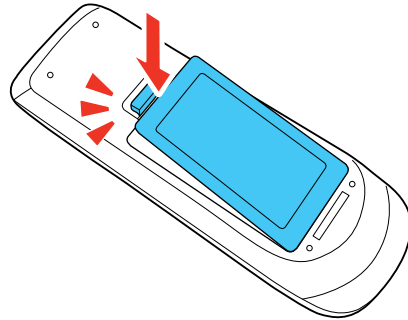

**Warning:** Dispose of used batteries according to local regulations. Do not expose batteries to heat or flame. Keep batteries out of the reach of children; they are choking hazards and are very dangerous if swallowed.

**Parent topic:** [Projector Maintenance](#)

**Related references**

[Remote Control Operation](#)

## Transporting the Projector

The projector contains precision parts, some of which are glass. Follow these guidelines to transport or ship the projector safely:

- Close the lens cover to protect the lens.
- Remove any equipment connected to the projector.
- When transporting the projector a long distance or as checked luggage, pack it in a firm box with cushioning around it and mark the box "Fragile."
- When shipping the projector for repairs, place it in its original packing materials, if possible, or use equivalent materials with cushioning around the projector. Mark the box "Fragile."

**Note:** Epson shall not be liable for any damages incurred during transportation.

**Parent topic:** [Maintaining and Transporting the Projector](#)

---

# Solving Problems

Check the solutions in these sections if you have any problems using the projector.

[Projection Problem Tips](#)

[Projector Light Status](#)

[Using the Projector Help Displays](#)

[Solving Image or Sound Problems](#)

[Solving Projector or Remote Control Operation Problems](#)

[Solutions When You Cannot Access the Projector Through the Web](#)

[Solutions When Network Alert E-Mails are Not Received](#)

[Where to Get Help](#)

## Projection Problem Tips

If the projector is not working properly, try turning it off and unplugging it. Then plug it back in and turn it on.

If this does not solve the problem, check the following:

- The lights on the projector may indicate what the problem is.
- The projector's Help system can display information about common problems, if the projector is operating.
- The solutions in this manual can help you solve many problems.

If none of these solutions help, you can contact Epson for technical support.

**Parent topic:** [Solving Problems](#)

## Projector Light Status

The lights on the projector indicate the projector status and let you know when a problem occurs. Check the status and color of the lights and look for a solution in the table here.

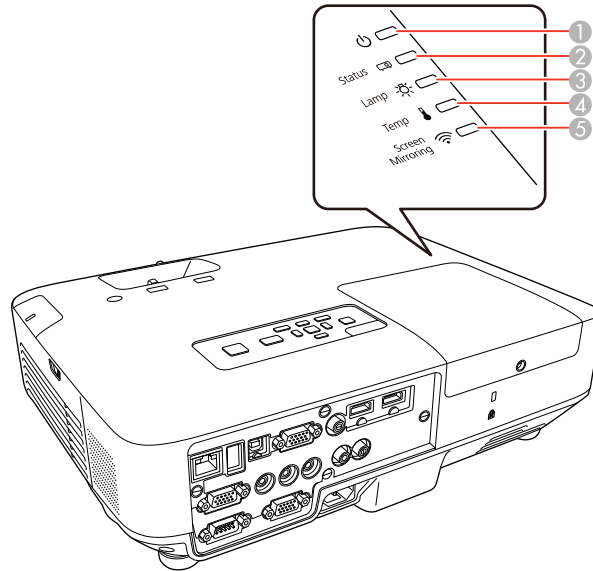

- 1 Power light
- 2 Status light
- 3 Lamp light
- 4 Temp light
- 5 Screen Mirroring light

Power light	Status light	Lamp light	Temp light	Status and solution
Blue	Blue	Off	Off	Normal operation
Blue	Flashing blue	Off	Off	Warming up; wait for an image to appear
Off	Off	Off	Off	Standby or sleep mode



Power light	Status light	Lamp light	Temp light	Status and solution
Blue	Flashing blue	Off	Off	Shutting down; when the Status light stops flashing, you can unplug the projector
Flashing blue	Varies	Off	Flashing orange	Projector is too hot <ul style="list-style-type: none"> <li>• Make sure that the vents and air filter are not clogged with dust or obstructed by nearby objects</li> <li>• Clean or replace the air filter</li> <li>• Make sure the environmental temperature is not too hot</li> </ul>
Off	Flashing blue	Off	Orange	Projector has overheated and turned off; leave it turned off to cool down for about five minutes, then do the following: <ul style="list-style-type: none"> <li>• Make sure that the vents and air filter are not clogged with dust or obstructed by nearby objects</li> <li>• Clean or replace the air filter</li> <li>• If operating the projector at high altitude, turn on <b>High Altitude Mode</b></li> <li>• If the problem persists, unplug the projector and contact Epson for help</li> </ul>

Power light	Status light	Lamp light	Temp light	Status and solution
Off	Flashing blue	Orange	Off	Lamp has a problem <ul style="list-style-type: none"> <li>• Check to see if the lamp is burned out, broken, or installed incorrectly; reseal or replace the lamp as necessary</li> <li>• Clean or replace the air filter</li> <li>• If operating the projector at high altitude, turn on <b>High Altitude Mode</b></li> <li>• If the problem persists, unplug the projector and contact Epson for help</li> </ul>
Flashing blue	Varies	Flashing orange	Off	Replace the lamp soon to avoid damage; do not continue using the projector
Off	Flashing blue	Off	Flashing orange	A fan or sensor has a problem; turn the projector off, unplug it, and contact Epson for help
Off	Flashing blue	Flashing orange	Flashing orange	Auto Iris error; turn the projector off, unplug it, and contact Epson for help
Off	Flashing blue	Orange	Orange	Power error (ballast); turn the projector off, unplug it, and contact Epson for help
Off	Flashing blue	Flashing orange	Off	Internal projector error; turn the projector off, unplug it, and contact Epson for help
Any	Any	Any	Any	Screen Mirroring light is solid blue; Screen Mirroring connection is available
Any	Any	Any	Any	Screen Mirroring light flashes blue quickly; connecting to a device

Power light	Status light	Lamp light	Temp light	Status and solution
Any	Any	Any	Any	Screen Mirroring light flashes blue slowly; Screen Mirroring error, select <b>Both Settings Off</b> as the <b>Wireless Mode</b> setting, then switch the setting back to <b>Screen Mirroring On</b>
Any	Any	Any	Any	Screen Mirroring light is off; Screen Mirroring is not available, check that the <b>Wireless Mode</b> setting is set to <b>Screen Mirroring On</b>

**Note:** If the lights display a pattern not listed in the table above, turn the projector off, unplug it, and contact Epson for help.

**Parent topic:** [Solving Problems](#)

**Related references**

[Projector Setup Settings - Extended Menu](#)

[Where to Get Help](#)

**Related tasks**

[Cleaning the Air Filter and Vents](#)

[Replacing the Air Filter](#)

[Replacing the Lamp](#)

## Using the Projector Help Displays

You can display information to help you solve common problems using the projector's Help system.

1. Turn on the projector.
2. Press the **Help** button on the projector or the remote control.  
You see the Help menu.
3. Use the up and down arrow buttons to highlight the problem you want to solve.
4. Press **Enter** to view the solutions.
5. When you are finished, do one of the following:
  - To select another problem to solve, press **Esc**.

- To exit the help system, press **Help**.

**Parent topic:** [Solving Problems](#)

## Solving Image or Sound Problems

Check the solutions in these sections if you have any problems with projected images or sound.

[Solutions When No Image Appears](#)

[Solutions When Image is Incorrect Using the USB Display Function](#)

[Solutions When "No Signal" Message Appears](#)

[Solutions When "Not Supported" Message Appears](#)

[Solutions When Only a Partial Image Appears](#)

[Solutions When the Image is Not Rectangular](#)

[Solutions When the Image Contains Noise or Static](#)

[Solutions When the Image is Fuzzy or Blurry](#)

[Solutions When the Image Brightness or Colors are Incorrect](#)

[Solutions to Sound Problems](#)

**Parent topic:** [Solving Problems](#)

### Solutions When No Image Appears

If no image appears, try the following solutions:

- Make sure the lens cover is open all the way or off.
- Press the **A/V Mute** button on the remote control to see if the image was temporarily turned off.
- Make sure all necessary cables are securely connected and the power is on for the projector and connected video sources.
- Press the projector's power button to wake it from standby or sleep mode. Also see if your connected computer is in sleep mode or displaying a blank screen saver.
- Check the settings on the Signal menu to make sure they are correct for the current video source.
- Adjust the **Brightness** setting or select the **Normal** Power Consumption setting.
- Check the **Display** setting to make sure **Messages** is set to **On**.
- If the projector does not respond when you press the control panel buttons, the buttons may be locked. Unlock the buttons.
- If the projector does not respond when you press buttons on the remote control, make sure the remote receivers are turned on.

- For images projected with Windows Media Center, reduce the screen size from full screen mode.
- For images projected from applications using Windows DirectX, turn off DirectX functions.

**Parent topic:** [Solving Image or Sound Problems](#)

**Related references**

[Image Quality Settings - Image Menu](#)

[Input Signal Settings - Signal Menu](#)

[Projector Feature Settings - Settings Menu](#)

[Projector Setup Settings - Extended Menu](#)

**Related tasks**

[Unlocking the Projector's Buttons](#)

## Solutions When Image is Incorrect Using the USB Display Function

If no image appears or if the image appears incorrectly using the USB Display function, try the following solutions:

- Press the **USB** button on the remote control.
- Make sure the USB Display software has installed correctly. Install it manually if necessary.
- With OS X, select the **USB Display** icon in the Dock or from the **Applications** folder.
- For images projected with Windows Media Center, reduce the screen size from full screen mode.
- For images projected from applications using Windows DirectX, turn off DirectX functions.
- If the mouse cursor flickers, select **Make the movement of the mouse pointer smooth** in the Epson USB Display Settings program on your computer (feature not available with Windows 2000).
- Turn off the **Transfer layered window** setting in the Epson USB Display Settings program on your computer.

**Parent topic:** [Solving Image or Sound Problems](#)

**Related references**

[Projector Setup Settings - Extended Menu](#)

## Solutions When "No Signal" Message Appears

If the "No Signal" message appears, try the following solutions:

- Press the **Source Search** button and wait a few seconds for an image to appear.

- Turn on the connected computer or video source, and press its play button to begin your presentation, if necessary.
- Check the connection from the projector to your video sources.
- If you are projecting from a laptop computer, make sure it is set up to display on an external monitor.
- If necessary, turn the projector and the connected computer or video source off and then on again.

[Displaying From a PC Laptop](#)

[Displaying From a Mac Laptop](#)

**Parent topic:** [Solving Image or Sound Problems](#)

#### **Related topics**

[Connecting to Video Sources](#)

[Connecting to Computer Sources](#)

### **Displaying From a PC Laptop**

If you see the "No Signal" message when you display from a PC laptop, you need to set up the laptop to display on an external monitor.

1. Hold down the laptop's **Fn** key and press the key labelled with a monitor icon or **CRT/LCD**. (See your laptop manual for details.) Wait a few seconds for an image to appear.
2. To display on both the laptop's monitor and the projector, try pressing the same keys again.
3. If the same image is not displayed by the laptop and projector, check the Windows **Display** utility to make sure the external monitor port is enabled and extended desktop mode is disabled. (See your computer or Windows manual for instructions.)
4. If necessary, check your video card settings and set the multiple display option to **Mirror** or **Duplicate**.

**Parent topic:** [Solutions When "No Signal" Message Appears](#)

#### **Related topics**

[Connecting to Computer Sources](#)

### **Displaying From a Mac Laptop**

If you see the "No Signal" message when you display from a Mac laptop, you need to set up the laptop for mirrored display. (See your laptop manual for details.)

1. Open the **System Preferences** utility and select **Displays**.
2. Click the **Arrangement** tab.
3. Select the **Mirror Displays** checkbox.

**Parent topic:** [Solutions When "No Signal" Message Appears](#)

**Related topics**

[Connecting to Computer Sources](#)

## Solutions When "Not Supported" Message Appears

If the "Not Supported" message appears, try the following solutions:

- Make sure the correct input signal is selected on the Signal menu.
- Make sure the computer's display resolution does not exceed the projector's resolution and frequency limit. If necessary, select a different display resolution for your computer. (See your computer manual for details.)

**Parent topic:** [Solving Image or Sound Problems](#)

**Related references**

[Input Signal Settings - Signal Menu](#)

[Supported Video Display Formats](#)

## Solutions When Only a Partial Image Appears

If only a partial computer image appears, try the following solutions:

- Press the **Auto** button on the remote control to optimize the image signal.
- Try adjusting the image position using the **Position** menu setting.
- Press the **Aspect** button on the remote control to select a different image aspect ratio.
- If you zoomed into or out of the image using the **E-Zoom** buttons, press the **Esc** button until the projector returns to a full display.
- Check your computer display settings to disable dual display and set the resolution within the projector's limits. (See your computer manual for details.)
- Check the resolution assigned to your presentation files to see if they are created for a different resolution than you are projecting in. (See your software help for details.)

**Parent topic:** [Solving Image or Sound Problems](#)

**Related references**

[Input Signal Settings - Signal Menu](#)

[Supported Video Display Formats](#)

## Solutions When the Image is Not Rectangular

If the projected image is not evenly rectangular, try the following solutions:

- Place the projector directly in front of the center of the screen, facing it squarely, if possible.
- If you adjusted the projector height using the projector feet, press the keystone buttons on the projector to adjust the image shape.
- Turn on automatic keystone adjustments using the projector's menus.
- Press the **Screen Fit** button and adjust the image shape using the on-screen display.
- Adjust the **Quick Corner** setting to correct the image shape.

**Parent topic:** [Solving Image or Sound Problems](#)

### Related references

[Projector Feature Settings - Settings Menu](#)

### Related tasks

[Automatically Correcting Image Shape With Screen Fit](#)

[Correcting Image Shape with the Keystone Buttons](#)

[Correcting Image Shape with Quick Corner](#)

## Solutions When the Image Contains Noise or Static

If the projected image seems to contain electronic interference (noise) or static, try the following solutions:

- Check the cables connecting your computer or video source to the projector. They should be:
  - Separated from the power cord to prevent interference
  - Securely connected at both ends
  - Not connected to an extension cable
  - No longer than 10 feet (3 m) for VGA/computer cables or 24 feet (7.3 m) for HDMI cables
- Check the settings on the projector's Signal menu to make sure they match the video source. If available for your video source, adjust the **Progressive** and **Noise Reduction** settings.
- Select a computer video resolution and refresh rate that are compatible with the projector.
- If you are projecting from a computer, press the **Auto** button on the remote control to automatically adjust the **Tracking** and **Sync** settings.
- If you adjusted the image shape using the projector controls, try decreasing the **Sharpness** setting to improve image quality.



- If you connected an extension power cable, try projecting without it to see if it caused interference in the signal.
- If you are using the USB Display function, turn off the **Transfer layered window** setting in the Epson USB Display Settings program on your computer.

**Parent topic:** [Solving Image or Sound Problems](#)

**Related references**

[Input Signal Settings - Signal Menu](#)

[Supported Video Display Formats](#)

**Related tasks**

[Displaying From a PC Laptop](#)

[Displaying From a Mac Laptop](#)

**Related topics**

[Connecting to Video Sources](#)

[Connecting to Computer Sources](#)

## Solutions When the Image is Fuzzy or Blurry

If the projected image is fuzzy or blurry, try the following solutions:

- Adjust the image focus.
- Clean the projector lens.

**Note:** To avoid condensation on the lens after bringing the projector in from a cold environment, let the projector warm up to room temperature before using it.

- Position the projector close enough to the screen.
- Position the projector so the keystone adjustment angle is not so wide that it distorts the image.
- When using the **Screen Fit** feature, position the projector at a compatible distance from the screen or adjust the image shape manually.
- Turn on automatic keystone adjustment in the projector's menus.
- Adjust the **Sharpness** setting to improve image quality.
- If you are projecting from a computer, press the **Auto** button on the remote control to automatically adjust the tracking and sync. If any bands or overall blurriness remain, display a uniformly patterned image on the screen and manually adjust the **Tracking** and **Sync** settings.

- If you are projecting from a computer, use a lower resolution.

**Parent topic:** [Solving Image or Sound Problems](#)

**Related references**

[Input Signal Settings - Signal Menu](#)

[Image Quality Settings - Image Menu](#)

[Projection Distance](#)

**Related tasks**

[Focusing the Image Using the Focus Ring](#)

[Cleaning the Lens](#)

## Solutions When the Image Brightness or Colors are Incorrect

If the projected image is too dark or light, or the colors are incorrect, try the following solutions:

- Press the **Color Mode** button on the remote control to try different color modes for the image and environment.
- Check your video source settings.
- Adjust the available settings on the Image menu for the current input source, such as **Brightness**, **Contrast**, **Tint**, **Color Adjustment**, and/or **Color Saturation**.
- Make sure you selected the correct **Input Signal** or **Video Signal** setting on the Signal menu, if available for your image source.
- Make sure all the cables are securely connected to the projector and your video device. If you connected long cables, try connecting shorter cables.
- If you are using the **ECO** Power Consumption setting, try selecting **Normal** in the projector's menus.

**Note:** At high altitudes or locations subject to high temperatures, the image may become darker and you may not be able to adjust the Power Consumption setting.

- Position the projector close enough to the screen.
- If the image has been progressively darkening, you may need to replace the projector lamp soon.

**Parent topic:** [Solving Image or Sound Problems](#)

**Related concepts**

[Projector Lamp Maintenance](#)

### Related references

[Input Signal Settings - Signal Menu](#)

[Image Quality Settings - Image Menu](#)

[Projector Feature Settings - Settings Menu](#)

## Solutions to Sound Problems

If there is no sound when you expect it or the volume is too low or high, try the following solutions:

- Adjust the projector's volume settings.
- Press the **A/V Mute** button on the remote control to resume video and audio if they were temporarily stopped.
- Press the **Source Search** button to switch to the correct input source, if necessary.
- Check your computer or video source to make sure the volume is turned up and the audio output is set for the correct source.
- Check the audio cable connections between the projector and your video source.
- If you do not hear sound from an HDMI source, set the connected device to PCM output.
- Make sure any connected audio cables are labeled "No Resistance".
- If you are using the USB Display function, turn on the **Output audio from the projector** setting in the Epson USB Display Settings program on your computer.
- If you are using a Mac and you do not hear sound from an HDMI source, make sure your Mac supports audio through the HDMI port. If not, you need to connect an audio cable.
- If you want to use a connected audio source when the projector is off, set the **Standby Mode** option to **Communication On** and the **A/V Output** option to **Always On**.
- If you turn the projector on immediately after turning it off, the cooling fans may run at high speed momentarily and cause an unexpected noise. This is normal.

**Parent topic:** [Solving Image or Sound Problems](#)

## Solving Projector or Remote Control Operation Problems

Check the solutions in these sections if you have problems operating the projector or remote control.

[Solutions to Projector Power or Shut-Off Problems](#)

[Solutions to Problems with the Remote Control](#)

[Solutions to Password Problems](#)

**Parent topic:** [Solving Problems](#)

## Solutions to Projector Power or Shut-Off Problems

If the projector does not come on when you press the power button or it shuts off unexpectedly, try the following solutions:

- Make sure the power cord is securely connected to the projector and to a working electrical outlet.
- The projector's buttons may be locked for security. Unlock the buttons or use the remote control to turn on the projector.
- The power cord may be defective. Disconnect the cord and contact Epson.
- If the projector's lamp shuts off unexpectedly, it may have entered standby mode after a period of inactivity. Press the power button to wake the projector.
- If the projector's lamp shuts off and the power and Temp lights are red, the projector has overheated and shut off. Check the solutions for this light status.
- If the power button on the remote control does not turn on the projector, check its batteries and make sure the **Remote Receiver** setting is turned on in the projector's menu, if available.

**Parent topic:** [Solving Projector or Remote Control Operation Problems](#)

### Related references

[Projector Feature Settings - Settings Menu](#)

[Projector Light Status](#)

### Related tasks

[Unlocking the Projector's Buttons](#)

## Solutions to Problems with the Remote Control

If the projector does not respond to remote control commands, try the following solutions:

- Check that the remote control batteries are installed correctly and have power. If necessary, replace the batteries.
- Make sure you are operating the remote control within the reception angle and range of the projector.
- Make sure the projector is not warming up or shutting down.
- Check to see if a button on the remote control is stuck down, causing it to enter sleep mode. Release the button to wake the remote control up.
- Strong fluorescent lighting, direct sunlight, or infrared device signals may be interfering with the projector's remote receivers. Dim the lights or move the projector away from the sun or interfering equipment.

- If available, turn off one of the remote receivers in the projector's menu system, or check if all the remote receivers were turned off.
- If you assigned an ID number to the remote control to operate multiple projectors, you may need to check or change the ID setting (feature not available with all projectors).
- If you lose the remote control, you can order another one from Epson.

**Parent topic:** [Solving Projector or Remote Control Operation Problems](#)

#### **Related references**

[Projector Feature Settings - Settings Menu](#)

[Projector Setup and Installation Options](#)

[Remote Control Operation](#)

#### **Related tasks**

[Setting the Remote Control ID](#)

## **Solutions to Password Problems**

If you cannot enter or remember a password, try the following solutions:

- You may have turned on password protection without first setting a password. Try entering **0000** using the remote control.
- If you have entered an incorrect password too many times and see a message displaying a request code, write down the code and contact Epson. Do not attempt to enter the password again. Provide the request code and proof of ownership for assistance in unlocking the projector.
- If you lose the remote control you cannot enter a password. Order a new one from Epson.

**Parent topic:** [Solving Projector or Remote Control Operation Problems](#)

## **Solutions When You Cannot Access the Projector Through the Web**

If you are unable to access the projector through a web browser, make sure you are using the correct ID and password, which are case sensitive.

- For the user ID, enter **EPSONWEB**. (You cannot change the user ID.)
- For the password, enter the password set in the projector's Network menu. The default password is **admin**.
- Make sure you have access to the network the projector is on.

**Note:** The user ID and password are case sensitive.

Parent topic: [Solving Problems](#)

## Solutions When Network Alert E-Mails are Not Received

If you do not receive an e-mail alerting you to problems with a projector over the network, try the following solutions:

- Make sure the projector is turned on and connected to the network correctly. (If an error shut down the projector, it cannot send an e-mail.)
- Make sure you set up the projector e-mail alert settings correctly on the projector's network Mail menu or in the network software.
- Set the **Standby Mode** setting to **Communication On** so the network software can monitor the projector in standby mode.

Parent topic: [Solving Problems](#)

## Where to Get Help

If you need to contact Epson for technical support services, use the following support options.

### Internet Support

Visit Epson's support website at [epson.com/support](http://epson.com/support) (U.S.) or [epson.ca/support](http://epson.ca/support) (Canada) for solutions to common problems with your projector. You can download utilities and documentation, get FAQs and troubleshooting advice, or e-mail Epson with your questions.

### Speak to a Support Representative

To use the Epson PrivateLine Support service, call (800) 637-7661. This service is available for the duration of your warranty period. You may also speak with a projector support specialist by dialing (562) 276-4394 (U.S.) or (905) 709-3839 (Canada).

Support hours are 6 AM to 8 PM, Pacific Time, Monday through Friday and 7 AM to 4 PM, Pacific Time, Saturday.

Days and hours of support are subject to change without notice. Toll or long distance charges may apply.

Before you call, have the following information ready:

- Product name
- Product serial number (located on the bottom or rear of the projector, or in the menu system)
- Proof of purchase (such as a store receipt) and date of purchase

- Computer or video configuration
- Description of the problem

### **Purchase Supplies and Accessories**

You can purchase screens, other optional accessories, and replacement parts from an Epson authorized reseller. To find the nearest reseller, call 800-GO-EPSON (800-463-7766). Or you can purchase online at [epsonstore.com](http://epsonstore.com) (U.S. sales) or [epson.ca](http://epson.ca) (Canadian sales).

To purchase a replacement remote control, call (562) 276-4394 (U.S.) or (905) 709-3839 (for dealer referral in Canada).

**Parent topic:** [Solving Problems](#)

---

# Technical Specifications

These sections list the technical specifications of your projector.

[General Projector Specifications](#)

[Projector Lamp Specifications](#)

[Remote Control Specifications](#)

[Projector Dimension Specifications](#)

[Projector Electrical Specifications](#)

[Projector Environmental Specifications](#)

[Projector Safety and Approvals Specifications](#)

[Supported Video Display Formats](#)

[USB Display System Requirements](#)

## General Projector Specifications

<b>Type of display</b>	Poly-silicon TFT active matrix
<b>Resolution</b>	<b>PowerLite 1970W/1975W:</b> 1280 × 800 pixels (WXGA) <b>PowerLite 1980WU/1985WU:</b> 1920 × 1200 pixels (WUXGA)
<b>Lens</b>	F=1.5 to 2.0 Focal length: 23 to 38.4 mm
<b>Color reproduction</b>	Full color, up to 1 billion colors



## Brightness

### **PowerLite 1970W/1975W:**

Normal Power Consumption mode:

White light output 5000 lumens (ISO 21118 standard)

Color light output 5000 lumens

ECO Power Consumption mode:

White light output 3500 lumens (ISO 21118 standard)

**Note:** Color brightness (color light output) and white brightness (white light output) will vary depending on usage conditions. Color light output measured in accordance with IDMS 15.4; white light output measured in accordance with ISO 21118.

### **PowerLite 1980WU/1985WU:**

Normal Power Consumption mode:

White light output 4800 lumens (ISO 21118 standard)

Color light output 4800 lumens

ECO Power Consumption mode:

White light output 3400 lumens (ISO 21118 standard)

**Note:** Color brightness (color light output) and white brightness (white light output) will vary depending on usage conditions. Color light output measured in accordance with IDMS 15.4; white light output measured in accordance with ISO 21118.

## Contrast ratio

10000:1 with Auto Iris on and Normal Power Consumption mode

## Image size

(in native aspect ratio)

### **PowerLite 1970W/1975W:**

30 inches (0.76 m) to 300 inches (7.62 m)

### **PowerLite 1980WU/1985WU:**

50 inches (1.27 m) to 300 inches (7.62 m)

## Projection distance

(in native aspect ratio)

### **PowerLite 1970W/1975W:**

33.9 inches (0.86 m) to 352.4 inches (8.95 m)

### **PowerLite 1980WU/1985WU:**

57.5 inches (1.46 m) to 352.4 inches (8.95 m)

<b>Projection methods</b>	Front, rear, ceiling-mounted
<b>Optical aspect ratio</b> (width-to-height)	16:10
<b>Focus adjustment</b>	Manual
<b>Zoom adjustment</b>	Manual
<b>Zoom ratio</b> (Tele-to-Wide)	1 to 1.6
<b>Internal sound system</b>	16 W monaural
<b>Noise level</b>	39 dB (Normal Power Consumption mode) 31 dB (ECO Power Consumption mode)
<b>Keystone correction angle</b>	Vertical: $\pm 30^\circ$ (manual); $\pm 30^\circ$ (using Auto Keystone or Screen Fit) Horizontal: $\pm 30^\circ$ (manual); $\pm 20^\circ$ (using Auto Keystone or Screen Fit)
<b>USB Type B port compatibility</b>	USB 1.1 and 2.0 compliant for USB display or external mouse
<b>USB Type A port compatibility</b>	One USB 1.1 and 2.0 compliant port for USB device input or Epson document camera display

Parent topic: [Technical Specifications](#)

## Projector Lamp Specifications

<b>Type</b>	UHE (Ultra High Efficiency)
<b>Power consumption</b>	<b>PowerLite 1970W/1975W/1985WU:</b> 280 W <b>PowerLite 1980WU:</b> 260 W
<b>Lamp life</b>	Normal Power Consumption mode: Up to about 3000 hours ECO Power Consumption mode: Up to about 4000 hours

**Note:** Turn off this product when not in use to prolong the life of the projector. Lamp life will vary depending upon mode selected, environmental conditions, and usage. Brightness decreases over time.

Parent topic: [Technical Specifications](#)

## Remote Control Specifications

<b>Reception range</b>	Up to 26.2 feet (8 m)
<b>Batteries</b>	Two alkaline or manganese AA

Parent topic: [Technical Specifications](#)

## Projector Dimension Specifications

<b>Height</b> (excluding feet)	4.3 inches (110 mm)
<b>Width</b>	14.8 inches (377 mm)
<b>Depth</b>	11.5 inches (291 mm)
<b>Weight</b>	<b>PowerLite 1970W/1980WU:</b> 9.9 lb (4.5 kg) <b>PowerLite 1975W/1985WU:</b> 10.1 lb (4.6 kg)

Parent topic: [Technical Specifications](#)

## Projector Electrical Specifications

<b>Rated frequency</b>	50/60 Hz
<b>Power supply</b>	100 to 240 VAC $\pm$ 10% <b>PowerLite 1970W/1975W/1985WU:</b> 4.3 to 1.9 A <b>PowerLite 1980WU:</b> 4.1 to 1.8 A

**Power consumption**

(100 to 120 V)

Operating:

**PowerLite 1970W/1975W/1985WU:**

Normal Power Consumption mode: 435 W

ECO Power Consumption mode: 330 W

**PowerLite 1980WU:**

Normal Power Consumption mode: 409 W

ECO Power Consumption mode: 330 W

Standby:

0.21 W (Communication Off), 3.5 W (Communication On)

**Power consumption**

(220 to 240 V)

Operating:

**PowerLite 1970W/1975W/1985WU:**

Normal Power Consumption mode: 411 W

ECO Power Consumption mode: 316 W

**PowerLite 1980WU:**

Normal Power Consumption mode: 388 W

ECO Power Consumption mode: 316 W

Standby:

0.34 W (Communication Off), 3.5 W (Communication On)

Parent topic: [Technical Specifications](#)

## Projector Environmental Specifications

**Temperature**

Operating: 41 to 95 °F (5 to 35 °C)

Up to 7500 ft (2286 m): 41 to 95 °F (5 to 35 °C)

7500 ft (2286 m) to 9843 feet (3000 m) : 41 to 86 °F (5 to 30 °C)

Storage: 14 to 140 °F (-10 to 60 °C)

**Humidity** (relative, non-condensing)

Operating: 20 to 80%

Storage: 10 to 90%

**Operating altitude** Up to 4921 feet (1500 m)  
Up to 9843 feet (3000 m) with High Altitude Mode enabled

Parent topic: [Technical Specifications](#)

## Projector Safety and Approvals Specifications

**United States** FCC Part 15 Class B (DoC)  
UL60950-1 2nd edition (cTUVus Mark)

**Canada** ICES-003 Class B  
CSA C22.2 No. 60950-1

Parent topic: [Technical Specifications](#)

## Supported Video Display Formats

For best results, your computer's monitor port or video card resolution should be set to display in the projector's native resolution. However, your projector includes Epson's SizeWise chip that supports other computer display resolutions, so your image will be resized to fit automatically.

Your computer's monitor port or video card refresh rate (vertical frequency) must be compatible with the projector. (See your computer or video card manual for details.)

The table here lists the compatible refresh rate and resolution for each compatible video display format.

Display format	Refresh rate (in Hz)	Resolution (in pixels)
<b>Computer signals (analog RGB)</b>		
VGA	60/72/75/85	640 × 480
SVGA	56/60/72/75/85	800 × 600
XGA	60/72/75/85	1024 × 768
WXGA	60	1280 × 768
	60	1366 × 768
	60/75/85	1280 × 800
WXGA+	60/75/85	1440 × 900

<b>Display format</b>	<b>Refresh rate (in Hz)</b>	<b>Resolution (in pixels)</b>
WXGA++	60	1600 × 900
SXGA	70/75/85	1152 × 864
	60/75/85	1280 × 1024
	60/75/85	1280 × 960
SXGA+	60/75	1400 × 1050
WSXGA+*	60	1680 × 1050
UXGA	60	1600 × 1200
WUXGA**	60	1900 × 1200
MAC13"	67	640 × 480
MAC16"	75	832 × 624
MAC19"	75	1024 × 768
	59	1024 × 768
MAC21"	75	1152 × 870
<b>Composite video</b>		
TV (NTSC)	60	720 × 480
TV (SECAM)	50	720 × 576
TV (PAL)	50/60	720 × 576
<b>Component video</b>		
SDTV (480i)	60	720 × 480
SDTV (576i)	50	720 × 576
SDTV (480p)	60	720 × 480
SDTV (576p)	50	720 × 576
HDTV (720p)	50/60	1280 × 720
HDTV (1080i)	50/60	1920 × 1080
HDTV (1080p)**	50/60	1920 × 1080
<b>HDMI input signals</b>		

Display format	Refresh rate (in Hz)	Resolution (in pixels)
VGA	60	640 × 480
SVGA	60	800 × 600
XGA	60	1024 × 768
WXGA	60	1280 × 800
	60	1366 × 768
WXGA+	60	1440 × 900
WXGA++	60	1600 × 900
WSXGA+	60	1680 × 1050
SXGA	60	1280 × 960
	60	1280 × 1024
SXGA+	60	1400 × 1050
UXGA	60	1600 × 1200
WUXGA+**	60	1920 × 1200
SDTV (480i/480p)	60	720 × 480
SDTV (576i/576p)	50	720 × 576
HDTV (720p)	50/60	1280 × 720
HDTV (1080i)	50/60	1920 × 1080
HDTV (1080p)	24/30/50/60	1920 × 1080
<b>MHL input signals</b>		
VGA	60	640 × 480
SDTV (480i/480p)	60	720 × 480
SDTV (576i/576p)	50	720 × 576
HDTV (720p)	50/60	1280 × 720
HDTV (1080i)	50/60	1920 × 1080
HDTV (1080p)	24/30	1920 × 1080

\* **Wide** resolution only

\*\* PowerLite 1980WU/1985WU only

Parent topic: [Technical Specifications](#)

## USB Display System Requirements

Your computer system must meet the system requirements here to use the projector's USB Display software.

Requirement	Windows	Mac
Operating system	Windows XP Professional, Home Edition, and Tablet PC Edition (32-bit); except for Service Pack 1	OS X 10.5.8 (32-bit); OS X 10.6.x, 10.7.x, 10.8.x, or 10.9.x (32- and 64-bit)
	Windows Vista Ultimate, Enterprise, Business, Home Premium, and Home Basic (32-bit)	
	Windows 7 Ultimate, Enterprise, Professional, and Home Premium (32- and 64-bit); Home Basic and Starter (32-bit)	
	Windows 8.x, Windows 8 Enterprise and Pro (32- and 64-bit)	
USB version	USB 1.1 and above (USB 2.0 recommended)	
CPU	Mobile Pentium III 1.2 GHz or faster (1.6 GHz or faster recommended)	Power PC G4 1 GHz or faster (Core Duo 1.83 GHz or faster recommended)
Memory	256MB or more (512MB or more recommended)	512MB or more
Hard disk space	20MB or more	
Display	Resolution between 640 × 480 and 1600 × 1200, 16-bit color or greater	Resolution between 640 × 480 and 1680 × 1200, 16-bit color or greater

Parent topic: [Technical Specifications](#)



---

## Notices

Check these sections for important notices about your projector.

[Recycling](#)

[Important Safety Information](#)

[Important Safety Instructions](#)

[FCC Compliance Statement](#)

[Wireless Telegraphy Act Regulations](#)

[Trademarks](#)

[Open Source Software License](#)

[Copyright Notice](#)

## Recycling

Epson offers a recycling program for end of life products. Please go to [epson.com/recycle](https://epson.com/recycle) for information on how to return your products for proper disposal.

**Parent topic:** [Notices](#)

## Important Safety Information

**Caution:** Never look into the projector lens when the lamp is turned on; the bright light can damage your eyes. Never let children look into the lens when it is on. Never open any cover on the projector, except the lamp and filter covers. Dangerous electrical voltages inside the projector can severely injure you. Except as specifically explained in this *User's Guide*, do not attempt to service this product yourself. Refer all servicing to qualified service personnel.

**Warning:** The projector and its accessories come packaged in plastic bags. Keep plastic bags away from small children to avoid any risk of suffocation.

**Caution:** When you replace the lamp, never touch the new lamp with your bare hands; the invisible residue left by the oil on your hands may shorten the lamp life. Use a cloth or glove to handle the new lamp.

**Parent topic:** [Notices](#)

## Important Safety Instructions

Follow these safety instructions when setting up and using the projector:

- Do not look into the lens when the projector is on. The bright light can damage your eyes. Avoid standing in front of the projector so the bright light does not shine into your eyes.
- Do not place the projector on an unstable cart, stand, or table.
- Do not operate the projector on its side, or while tilted to one side. Do not tilt the projector more than 30° forward or back.
- If the projector is mounted on a ceiling or wall, it should be installed by qualified technicians using mounting hardware designed for use with this projector.
- When installing or adjusting a ceiling or wall mount, do not use adhesives to prevent the screws from loosening and do not use oils or lubricants. This may cause the projector case to crack and the projector to fall from its ceiling mount. This could cause serious injury to anyone under the mount and could damage the projector.
- Do not use the projector near water, sources of heat, high-voltage electrical wires, or sources of magnetic fields.
- Use the type of power source indicated on the projector. Use of a different power source may result in fire or electric shock. If you are not sure of the power available, consult your dealer or power company.
- Place the projector near a wall outlet where the plug can be easily unplugged.
- Take the following precautions when handling the plug: Do not hold the plug with wet hands. Do not insert the plug into a dusty outlet. Insert the plug firmly into the outlet. Do not pull the power cord when disconnecting the plug; always be sure to hold the plug when disconnecting it. Do not overload wall outlets, extension cords, or power strips. Failure to comply with these precautions could result in fire or electric shock.
- Do not place the projector where the cord can be walked on. This may result in fraying or damage to the plug.
- Unplug the projector from the wall outlet before cleaning. Use a dry cloth (or, for stubborn dirt or stains, a moist cloth that has been wrung dry) for cleaning. Do not use liquid or aerosol cleaners, any sprays containing flammable gas, or solvents such as alcohol, paint thinner, or benzine.
- Do not block the slots and openings in the projector case. They provide ventilation and prevent the projector from overheating. Do not operate the projector on a sofa, rug, or other soft surface, or set it on top of loose papers. Do not cover the projector with a blanket, curtain, or tablecloth. If you are setting up the projector near a wall, leave at least 7.9 inches (20 cm) of space between the wall and the air exhaust vent.
- Do not operate the projector in a closed-in cabinet unless proper ventilation is provided.

- Never allow objects of any kind to enter any openings in the projector. Do not leave objects, especially flammable objects, near the projector. Never spill liquid of any kind into the projector.
- If you are using two or more projectors side-by-side, leave at least of space between the projectors to allow for proper ventilation.
- You may need to clean the air filter and vent. A clogged air filter or vent can block ventilation needed to cool the projector. Do not use canned air, or the gases may leave a residue.
- Do not store the projector outdoors for an extended length of time.
- Except as specifically explained in this manual, do not attempt to service this product yourself. Refer all servicing to qualified personnel. Opening or removing covers may expose you to dangerous voltages and other hazards.
- Never open any covers on the projector except as specifically explained in this manual. Never attempt to disassemble or modify the projector. Refer all repairs to qualified service personnel.
- Unplug the projector from the wall outlet and refer servicing to qualified service personnel under the following conditions: if it does not operate normally when you follow the operating instructions, or exhibits a distinct change in performance; if smoke, strange odors, or strange noises come from the projector; if the power cord or plug is damaged or frayed; if liquid or foreign objects get inside the projector, or if it has been exposed to rain or water; if it has been dropped or the housing has been damaged.
- Do not touch the plug during an electrical storm. Otherwise, you may receive an electric shock.
- Unplug the projector when it will not be used for extended periods.
- Do not use the projector where it may be exposed to rain, water, or excessive humidity.
- Do not use or store the projector where it may be exposed to smoke, steam, corrosive gases, excessive dust, vibration, or shock.
- Do not use the projector where flammable or explosive gases may be present.
- Do not use or store the projector or remote control in a hot location, such as near a heater, in direct sunlight, or in a closed vehicle.
- If you use the projector in a country other than where you purchased it, use the correct power cord for that country.
- Do not stand on the projector or place heavy objects on it.
- Do not use the projector outside of the required temperature range of 41 to 95 °F (5 to 35 °C). Doing so may cause an unstable display and could lead to projector damage. Do not use or store the projector where it may be exposed to sudden changes in temperature.

- Do not store the projector outside of the required temperature range of 14 to 140 °F (–10 to 60 °C) or in direct sunlight for long periods of time. Doing so may cause damage to the case.
- Do not place anything that can become warped or damaged by heat near the exhaust vents. Do not bring your hands or face close to the vents while projection is in progress. Do not bring your face close to the projector while it is in use.
- Before you move the projector, make sure its power is turned off, the plug is disconnected from the outlet, and all cables are disconnected.
- Never try to remove the lamp immediately after use because it will be extremely hot. Before removing the lamp, turn off the power and wait at least an hour to allow the lamp to cool completely.
- Do not disassemble the lamp or subject it to impacts.
- Do not place the source of an open flame, such as a lit candle, on or near the projector.
- Do not modify the power cord. Do not place heavy objects on top of the power cord or bend, twist, or pull it excessively. Keep the power cord away from hot electrical appliances.
- If the lamp breaks, ventilate the room to prevent gases contained in the lamp from being inhaled or coming in contact with your eyes or mouth. If you do inhale gases or gases come in contact with your eyes or mouth, seek medical advice immediately.
- If the projector is mounted overhead and the lamp breaks, be careful to prevent pieces of glass from falling into your eyes or mouth when you open the lamp cover. If pieces of glass do get into your eyes or mouth, seek medical advise immediately.

**Note:**  The lamp(s) in this product contain mercury. Please consult your state and local regulations regarding disposal or recycling. Do not put in the trash.

**WARNING:** The cords included with this product contain chemicals, including lead, known to the State of California to cause birth defects or other reproductive harm. ***Wash hands after handling.*** (This notice is provided in accordance with Proposition 65 in Cal. Health & Safety Code § 25249.5 and following.)

[Restriction of Use](#)

**Parent topic:** [Notices](#)

## Restriction of Use

When this product is used for applications requiring high reliability/safety such as transportation devices related to aviation, rail, marine, automotive; disaster prevention devices; various safety devices; or functional/precision devices, you should use this product only after giving consideration to including fail-safes and redundancies into your design to maintain safety and total system reliability.

Because this product was not intended for use in applications requiring extremely high reliability/safety such as aerospace equipment, main communication equipment, nuclear power control equipment, or medical equipment related to direct medical care, please make your own judgment on this product's suitability after a full evaluation.

**Parent topic:** [Important Safety Instructions](#)

## FCC Compliance Statement

### For United States Users

This equipment has been tested and found to comply with the limits for a Class B digital device, pursuant to Part 15 of the FCC Rules. These limits are designed to provide reasonable protection against harmful interference in a residential installation. This equipment generates, uses, and can radiate radio frequency energy and, if not installed and used in accordance with the instructions, may cause harmful interference to radio communications. However, there is no guarantee that interference will not occur in a particular installation. If this equipment does cause interference to radio and television reception, which can be determined by turning the equipment off and on, the user is encouraged to try to correct the interference by one or more of the following measures:

- Reorient or relocate the receiving antenna.
- Increase the separation between the equipment and receiver.
- Connect the equipment into an outlet on a circuit different from that to which the receiver is connected.
- Consult the dealer or an experienced radio/TV technician for help.

### WARNING

The connection of a non-shielded equipment interface cable to this equipment will invalidate the FCC Certification or Declaration of this device and may cause interference levels which exceed the limits established by the FCC for this equipment. It is the responsibility of the user to obtain and use a shielded equipment interface cable with this device. If this equipment has more than one interface connector, do not leave cables connected to unused interfaces. Changes or modifications not expressly approved by the manufacturer could void the user's authority to operate the equipment.

### For Canadian Users

CAN ICES-3(B)/NMB-3(B)

**Parent topic:** [Notices](#)

## Wireless Telegraphy Act Regulations

The following acts are prohibited by the Wireless Telegraphy Act:

- Modifying and disassembling (including the antenna)
- Removing the label of conformance

Parent topic: [Notices](#)

## Trademarks

EPSON®, EasyMP®, Instant Off®, PowerLite®, and Quick Corner® are registered trademarks, and EPSON Exceed Your Vision is a registered logomark of Seiko Epson Corporation.

Accolade® and PrivateLine® are registered trademarks; Duet™ is a trademark; and Epson Store<sup>SM</sup> and Extra Care<sup>SM</sup> are service marks of Epson America, Inc.

Mac and OS X are trademarks of Apple Inc., registered in the U.S. and other countries.

HDMI and High-Definition Multimedia Interface are the trademarks or registered trademarks of HDMI Licensing LLC.  HIGH DEFINITION MULTIMEDIA INTERFACE

General Notice: Other product names used herein are for identification purposes only and may be trademarks of their respective owners. Epson disclaims any and all rights in those marks.



Parent topic: [Notices](#)

## Open Source Software License

### GNU GPL

This projector product includes the open source software programs which apply the GNU General Public License Version 2 or later version ("GPL Programs").

We provide the source code of the GPL Programs until five (5) years after the discontinuation of same model of this projector product.

If you desire to receive the source code of the GPL Programs, contact Epson.

These GPL Programs are WITHOUT ANY WARRANTY; without even the implied warranty of MERCHANTABILITY AND FITNESS FOR A PARTICULAR PURPOSE. See the GNU General Public License for more details.

The list of GPL Programs is as follows and the names of author are described in the source code of the GPL Programs

The list of GPL Programs

- busybox-1.13.4
- iptables-1.4.4
- libgcc1(gcc-4.3.3)
- libstdc++-6.0.10
- linux-2.6.27
- patches
- udhcp 0.9.8
- uvc rev.219
- wireless\_tools 29
- EPSON original drivers
- linux-2.6.34
- PTP-1.00
- busybox-1.18.4
- bridge-utils-1.1
- gdb-6.4
- gawk-3.1.5
- oprofile-0.9.2
- binutils-2.16.1
- diehotplug0.4
- MTD-utils
- Yaffs2-alpha1
- pppoe-3.8
- udftools-1.0.0b3

- lrzsz-0.12.20
- wireless\_tools.29
- yaffs2-utils
- squashfs 4.2
- coreutils 6.9

The GNU General Public License Version 2 is as follows. You also can see the GNU General Public License Version 2 at <http://www.gnu.org/licenses/>.

## **GNU GENERAL PUBLIC LICENSE**

Version 2, June 1991

Copyright (C) 1989, 1991 Free Software Foundation, Inc., 51 Franklin Street, Fifth Floor, Boston, MA 02110-1301 USA Everyone is permitted to copy and distribute verbatim copies of this license document, but changing it is not allowed.

### **Preamble**

The licenses for most software are designed to take away your freedom to share and change it. By contrast, the GNU General Public License is intended to guarantee your freedom to share and change free software--to make sure the software is free for all its users. This General Public License applies to most of the Free Software Foundation's software and to any other program whose authors commit to using it. (Some other Free Software Foundation software is covered by the GNU Lesser General Public License instead.) You can apply it to your programs, too.

When we speak of free software, we are referring to freedom, not price. Our General Public Licenses are designed to make sure that you have the freedom to distribute copies of free software (and charge for this service if you wish), that you receive source code or can get it if you want it, that you can change the software or use pieces of it in new free programs; and that you know you can do these things.

To protect your rights, we need to make restrictions that forbid anyone to deny you these rights or to ask you to surrender the rights. These restrictions translate to certain responsibilities for you if you distribute copies of the software, or if you modify it.

For example, if you distribute copies of such a program, whether gratis or for a fee, you must give the recipients all the rights that you have. You must make sure that they, too, receive or can get the source code. And you must show them these terms so they know their rights.

We protect your rights with two steps: (1) copyright the software, and (2) offer you this license which gives you legal permission to copy, distribute and/or modify the software.

Also, for each author's protection and ours, we want to make certain that everyone understands that there is no warranty for this free software. If the software is modified by someone else and passed on,



we want its recipients to know that what they have is not the original, so that any problems introduced by others will not reflect on the original authors' reputations.

Finally, any free program is threatened constantly by software patents. We wish to avoid the danger that redistributors of a free program will individually obtain patent licenses, in effect making the program proprietary. To prevent this, we have made it clear that any patent must be licensed for everyone's free use or not licensed at all.

The precise terms and conditions for copying, distribution and modification follow.

## **GNU GENERAL PUBLIC LICENSE TERMS AND CONDITIONS FOR COPYING, DISTRIBUTION AND MODIFICATION**

0. This License applies to any program or other work which contains a notice placed by the copyright holder saying it may be distributed under the terms of this General Public License. The "Program", below, refers to any such program or work, and a "work based on the Program" means either the Program or any derivative work under copyright law: that is to say, a work containing the Program or a portion of it, either verbatim or with modifications and/or translated into another language. (Hereinafter, translation is included without limitation in the term "modification".) Each licensee is addressed as "you".

Activities other than copying, distribution and modification are not covered by this License; they are outside its scope. The act of running the Program is not restricted, and the output from the Program is covered only if its contents constitute a work based on the Program (independent of having been made by running the Program). Whether that is true depends on what the Program does.

1. You may copy and distribute verbatim copies of the Program's source code as you receive it, in any medium, provided that you conspicuously and appropriately publish on each copy an appropriate copyright notice and disclaimer of warranty; keep intact all the notices that refer to this License and to the absence of any warranty; and give any other recipients of the Program a copy of this License along with the Program.

You may charge a fee for the physical act of transferring a copy, and you may at your option offer warranty protection in exchange for a fee.

2. You may modify your copy or copies of the Program or any portion of it, thus forming a work based on the Program, and copy and distribute such modifications or work under the terms of Section 1 above, provided that you also meet all of these conditions:

a) You must cause the modified files to carry prominent notices stating that you changed the files and the date of any change.

b) You must cause any work that you distribute or publish, that in whole or in part contains or is derived from the Program or any part thereof, to be licensed as a whole at no charge to all third parties under the terms of this License.

c) If the modified program normally reads commands interactively when run, you must cause it, when started running for such interactive use in the most ordinary way, to print or display an announcement including an appropriate copyright notice and a notice that there is no warranty (or else, saying that you provide a warranty) and that users may redistribute the program under these conditions, and telling the user how to view a copy of this License. (Exception: if the Program itself is interactive but does not normally print such an announcement, your work based on the Program is not required to print an announcement.)

These requirements apply to the modified work as a whole. If identifiable sections of that work are not derived from the Program, and can be reasonably considered independent and separate works in themselves, then this License, and its terms, do not apply to those sections when you distribute them as separate works. But when you distribute the same sections as part of a whole which is a work based on the Program, the distribution of the whole must be on the terms of this License, whose permissions for other licensees extend to the entire whole, and thus to each and every part regardless of who wrote it.

Thus, it is not the intent of this section to claim rights or contest your rights to work written entirely by you; rather, the intent is to exercise the right to control the distribution of derivative or collective works based on the Program.

In addition, mere aggregation of another work not based on the Program with the Program (or with a work based on the Program) on a volume of a storage or distribution medium does not bring the other work under the scope of this License.

3. You may copy and distribute the Program (or a work based on it, under Section 2) in object code or executable form under the terms of Sections 1 and 2 above provided that you also do one of the following:

a) Accompany it with the complete corresponding machine-readable source code, which must be distributed under the terms of Sections 1 and 2 above on a medium customarily used for software interchange; or,

b) Accompany it with a written offer, valid for at least three years, to give any third party, for a charge no more than your cost of physically performing source distribution, a complete machine-readable copy of the corresponding source code, to be distributed under the terms of Sections 1 and 2 above on a medium customarily used for software interchange; or,

c) Accompany it with the information you received as to the offer to distribute corresponding source code. (This alternative is allowed only for noncommercial distribution and only if you received the program in object code or executable form with such an offer, in accord with Subsection b above.)

The source code for a work means the preferred form of the work for making modifications to it. For an executable work, complete source code means all the source code for all modules it contains, plus any associated interface definition files, plus the scripts used to control compilation and installation of the executable. However, as a special exception, the source code distributed need not include anything that is normally distributed (in either source or binary form) with the major components (compiler, kernel, and

so on) of the operating system on which the executable runs, unless that component itself accompanies the executable.

If distribution of executable or object code is made by offering access to copy from a designated place, then offering equivalent access to copy the source code from the same place counts as distribution of the source code, even though third parties are not compelled to copy the source along with the object code.

4. You may not copy, modify, sublicense, or distribute the Program except as expressly provided under this License. Any attempt otherwise to copy, modify, sublicense or distribute the Program is void, and will automatically terminate your rights under this License. However, parties who have received copies, or rights, from you under this License will not have their licenses terminated so long as such parties remain in full compliance.

5. You are not required to accept this License, since you have not signed it. However, nothing else grants you permission to modify or distribute the Program or its derivative works. These actions are prohibited by law if you do not accept this License. Therefore, by modifying or distributing the Program (or any work based on the Program), you indicate your acceptance of this License to do so, and all its terms and conditions for copying, distributing or modifying the Program or works based on it.

6. Each time you redistribute the Program (or any work based on the Program), the recipient automatically receives a license from the original licensor to copy, distribute or modify the Program subject to these terms and conditions. You may not impose any further restrictions on the recipients' exercise of the rights granted herein. You are not responsible for enforcing compliance by third parties to this License.

7. If, as a consequence of a court judgment or allegation of patent infringement or for any other reason (not limited to patent issues), conditions are imposed on you (whether by court order, agreement or otherwise) that contradict the conditions of this License, they do not excuse you from the conditions of this License. If you cannot distribute so as to satisfy simultaneously your obligations under this License and any other pertinent obligations, then as a consequence you may not distribute the Program at all. For example, if a patent license would not permit royalty-free redistribution of the Program by all those who receive copies directly or indirectly through you, then the only way you could satisfy both it and this License would be to refrain entirely from distribution of the Program.

If any portion of this section is held invalid or unenforceable under any particular circumstance, the balance of the section is intended to apply and the section as a whole is intended to apply in other circumstances.

It is not the purpose of this section to induce you to infringe any patents or other property right claims or to contest validity of any such claims; this section has the sole purpose of protecting the integrity of the free software distribution system, which is implemented by public license practices. Many people have made generous contributions to the wide range of software distributed through that system in reliance on consistent application of that system; it is up to the author/donor to decide if he or she is willing to distribute software through any other system and a licensee cannot impose that choice.

This section is intended to make thoroughly clear what is believed to be a consequence of the rest of this License.

8. If the distribution and/or use of the Program is restricted in certain countries either by patents or by copyrighted interfaces, the original copyright holder who places the Program under this License may add an explicit geographical distribution limitation excluding those countries, so that distribution is permitted only in or among countries not thus excluded. In such case, this License incorporates the limitation as if written in the body of this License.

9. The Free Software Foundation may publish revised and/or new versions of the General Public License from time to time. Such new versions will be similar in spirit to the present version, but may differ in detail to address new problems or concerns.

Each version is given a distinguishing version number. If the Program specifies a version number of this License which applies to it and "any later version", you have the option of following the terms and conditions either of that version or of any later version published by the Free Software Foundation. If the Program does not specify a version number of this License, you may choose any version ever published by the Free Software Foundation.

10. If you wish to incorporate parts of the Program into other free programs whose distribution conditions are different, write to the author to ask for permission. For software which is copyrighted by the Free Software Foundation, write to the Free Software Foundation; we sometimes make exceptions for this. Our decision will be guided by the two goals of preserving the free status of all derivatives of our free software and of promoting the sharing and reuse of software generally.

#### **NO WARRANTY**

11. BECAUSE THE PROGRAM IS LICENSED FREE OF CHARGE, THERE IS NO WARRANTY FOR THE PROGRAM, TO THE EXTENT PERMITTED BY APPLICABLE LAW. EXCEPT WHEN OTHERWISE STATED IN WRITING THE COPYRIGHT HOLDERS AND/OR OTHER PARTIES PROVIDE THE PROGRAM "AS IS" WITHOUT WARRANTY OF ANY KIND, EITHER EXPRESSED OR IMPLIED, INCLUDING, BUT NOT LIMITED TO, THE IMPLIED WARRANTIES OF MERCHANTABILITY AND FITNESS FOR A PARTICULAR PURPOSE. THE ENTIRE RISK AS TO THE QUALITY AND PERFORMANCE OF THE PROGRAM IS WITH YOU. SHOULD THE PROGRAM PROVE DEFECTIVE, YOU ASSUME THE COST OF ALL NECESSARY SERVICING, REPAIR OR CORRECTION.

12. IN NO EVENT UNLESS REQUIRED BY APPLICABLE LAW OR AGREED TO IN WRITING WILL ANY COPYRIGHT HOLDER, OR ANY OTHER PARTY WHO MAY MODIFY AND/OR REDISTRIBUTE THE PROGRAM AS PERMITTED ABOVE, BE LIABLE TO YOU FOR DAMAGES, INCLUDING ANY GENERAL, SPECIAL, INCIDENTAL OR CONSEQUENTIAL DAMAGES ARISING OUT OF THE USE OR INABILITY TO USE THE PROGRAM (INCLUDING BUT NOT LIMITED TO LOSS OF DATA OR DATA BEING RENDERED INACCURATE OR LOSSES SUSTAINED BY YOU OR THIRD PARTIES OR A FAILURE OF THE PROGRAM TO OPERATE WITH ANY OTHER PROGRAMS), EVEN IF SUCH HOLDER OR OTHER PARTY HAS BEEN ADVISED OF THE POSSIBILITY OF SUCH DAMAGES.

## END OF TERMS AND CONDITIONS

### How to Apply These Terms to Your New Programs

If you develop a new program, and you want it to be of the greatest possible use to the public, the best way to achieve this is to make it free software which everyone can redistribute and change under these terms.

To do so, attach the following notices to the program. It is safest to attach them to the start of each source file to most effectively convey the exclusion of warranty; and each file should have at least the "copyright" line and a pointer to where the full notice is found.

<one line to give the program's name and a brief idea of what it does.>

Copyright (C) <year> <name of author>

This program is free software; you can redistribute it and/or modify it under the terms of the GNU General Public License as published by the Free Software Foundation; either version 2 of the License, or (at your option) any later version.

This program is distributed in the hope that it will be useful, but WITHOUT ANY WARRANTY; without even the implied warranty of MERCHANTABILITY or FITNESS FOR A PARTICULAR PURPOSE. See the GNU General Public License for more details.

You should have received a copy of the GNU General Public License along with this program; if not, write to the Free Software Foundation, Inc., 51 Franklin Street, Fifth Floor, Boston, MA 02110-1301 USA.

Also add information on how to contact you by electronic and paper mail.

If the program is interactive, make it output a short notice like this when it starts in an interactive mode:

Gnomovision version 69, Copyright (C) year name of author Gnomovision comes with ABSOLUTELY NO WARRANTY; for details type `show w'. This is free software, and you are welcome to redistribute it under certain conditions; type `show c' for details.

The hypothetical commands `show w' and `show c' should show the appropriate parts of the General Public License. Of course, the commands you use may be called something other than `show w' and `show c'; they could even be mouse-clicks or menu items--whatever suits your program.

You should also get your employer (if you work as a programmer) or your school, if any, to sign a "copyright disclaimer" for the program, if necessary. Here is a sample; alter the names:

Yoyodyne, Inc., hereby disclaims all copyright interest in the program `Gnomovision' (which makes passes at compilers) written by James Hacker.

<signature of Ty Coon>, 1 April 1989

Ty Coon, President of Vice

This General Public License does not permit incorporating your program into proprietary programs. If your program is a subroutine library, you may consider it more useful to permit linking proprietary applications with the library. If this is what you want to do, use the GNU Lesser General Public License instead of this License.

## **GNU LGPL**

This projector product includes the open source software programs which apply the GNU Lesser General Public License Version 2 or later version ("LGPL Programs").

We provide the source code of the LGPL Programs until five (5) years after the discontinuation of same model of this projector product.

If you desire to receive the source code of the LGPL Programs, please contact Epson.

These LGPL Programs are WITHOUT ANY WARRANTY; without even the implied warranty of MERCHANTABILITY AND FITNESS FOR A PARTICULAR PURPOSE. See the GNU General Public License for more details.

The list of LGPL Programs is as follows and the names of author are described in the source code of the LGPL Programs.

### LGPL Programs

- glibc-2.8
- SDL-1.2.13
- SDL-Image
- uclibc 0.9.30.3
- ebase 1.2.2
- qdecoder 8.0
- neon-0.28.6
- neon-0.27.2
- libotf-0.9.9
- fribidi-0.10.9
- DirectFB-1.4.2
- libcharguess 1.0b

The GNU Lesser General Public License Version 2 is as follows. You also can see the GNU Lesser General Public License Version 2 at <http://www.gnu.org/licenses/>.

## **GNU LESSER GENERAL PUBLIC LICENSE**

Version 2.1, February 1999

Copyright (C) 1991, 1999 Free Software Foundation, Inc. 51 Franklin Street, Fifth Floor, Boston, MA 02110-1301 USA Everyone is permitted to copy and distribute verbatim copies of this license document, but changing it is not allowed.

[This is the first released version of the Lesser GPL. It also counts as the successor of the GNU Library Public License, version 2, hence the version number 2.1.]

### **Preamble**

The licenses for most software are designed to take away your freedom to share and change it. By contrast, the GNU General Public Licenses are intended to guarantee your freedom to share and change free software--to make sure the software is free for all its users.

This license, the Lesser General Public License, applies to some specially designated software packages--typically libraries--of the Free Software Foundation and other authors who decide to use it. You can use it too, but we suggest you first think carefully about whether this license or the ordinary General Public License is the better strategy to use in any particular case, based on the explanations below.

When we speak of free software, we are referring to freedom of use, not price. Our General Public Licenses are designed to make sure that you have the freedom to distribute copies of free software (and charge for this service if you wish); that you receive source code or can get it if you want it; that you can change the software and use pieces of it in new free programs; and that you are informed that you can do these things.

To protect your rights, we need to make restrictions that forbid distributors to deny you these rights or to ask you to surrender these rights. These restrictions translate to certain responsibilities for you if you distribute copies of the library or if you modify it.

For example, if you distribute copies of the library, whether gratis or for a fee, you must give the recipients all the rights that we gave you. You must make sure that they, too, receive or can get the source code. If you link other code with the library, you must provide complete object files to the recipients, so that they can relink them with the library after making changes to the library and recompiling it. And you must show them these terms so they know their rights.

We protect your rights with a two-step method: (1) we copyright the library, and (2) we offer you this license, which gives you legal permission to copy, distribute and/or modify the library.

To protect each distributor, we want to make it very clear that there is no warranty for the free library. Also, if the library is modified by someone else and passed on, the recipients should know that what they have is not the original version, so that the original author's reputation will not be affected by problems that might be introduced by others.

Finally, software patents pose a constant threat to the existence of any free program. We wish to make sure that a company cannot effectively restrict the users of a free program by obtaining a restrictive license from a patent holder. Therefore, we insist that any patent license obtained for a version of the library must be consistent with the full freedom of use specified in this license.

Most GNU software, including some libraries, is covered by the ordinary GNU General Public License. This license, the GNU Lesser General Public License, applies to certain designated libraries, and is quite different from the ordinary General Public License. We use this license for certain libraries in order to permit linking those libraries into non-free programs.

When a program is linked with a library, whether statically or using a shared library, the combination of the two is legally speaking a combined work, a derivative of the original library. The ordinary General Public License therefore permits such linking only if the entire combination fits its criteria of freedom. The Lesser General Public License permits more lax criteria for linking other code with the library.

We call this license the "Lesser" General Public License because it does Less to protect the user's freedom than the ordinary General Public License. It also provides other free software developers Less of an advantage over competing non-free programs. These disadvantages are the reason we use the ordinary General Public License for many libraries. However, the Lesser license provides advantages in certain special circumstances.

For example, on rare occasions, there may be a special need to encourage the widest possible use of a certain library, so that it becomes a de-facto standard. To achieve this, non-free programs must be allowed to use the library. A more frequent case is that a free library does the same job as widely used non-free libraries. In this case, there is little to gain by limiting the free library to free software only, so we use the Lesser General Public License.

In other cases, permission to use a particular library in non-free programs enables a greater number of people to use a large body of free software. For example, permission to use the GNU C Library in non-free programs enables many more people to use the whole GNU operating system, as well as its variant, the GNU/Linux operating system.

Although the Lesser General Public License is Less protective of the users' freedom, it does ensure that the user of a program that is linked with the Library has the freedom and the wherewithal to run that program using a modified version of the Library.

The precise terms and conditions for copying, distribution and modification follow. Pay close attention to the difference between a "work based on the library" and a "work that uses the library". The former contains code derived from the library, whereas the latter must be combined with the library in order to run.



## **GNU LESSER GENERAL PUBLIC LICENSE TERMS AND CONDITIONS FOR COPYING, DISTRIBUTION AND MODIFICATION**

0. This License Agreement applies to any software library or other program which contains a notice placed by the copyright holder or other authorized party saying it may be distributed under the terms of this Lesser General Public License (also called "this License"). Each licensee is addressed as "you".

A "library" means a collection of software functions and/or data prepared so as to be conveniently linked with application programs (which use some of those functions and data) to form executables.

The "Library", below, refers to any such software library or work which has been distributed under these terms. A "work based on the Library" means either the Library or any derivative work under copyright law: that is to say, a work containing the Library or a portion of it, either verbatim or with modifications and/or translated straightforwardly into another language. (Hereinafter, translation is included without limitation in the term "modification".)

"Source code" for a work means the preferred form of the work for making modifications to it. For a library, complete source code means all the source code for all modules it contains, plus any associated interface definition files, plus the scripts used to control compilation and installation of the library.

Activities other than copying, distribution and modification are not covered by this License; they are outside its scope. The act of running a program using the Library is not restricted, and output from such a program is covered only if its contents constitute a work based on the Library (independent of the use of the Library in a tool for writing it). Whether that is true depends on what the Library does and what the program that uses the Library does.

1. You may copy and distribute verbatim copies of the Library's complete source code as you receive it, in any medium, provided that you conspicuously and appropriately publish on each copy an appropriate copyright notice and disclaimer of warranty; keep intact all the notices that refer to this License and to the absence of any warranty; and distribute a copy of this License along with the Library.

You may charge a fee for the physical act of transferring a copy, and you may at your option offer warranty protection in exchange for a fee.

2. You may modify your copy or copies of the Library or any portion of it, thus forming a work based on the Library, and copy and distribute such modifications or work under the terms of Section 1 above, provided that you also meet all of these conditions:

- a) The modified work must itself be a software library.
- b) You must cause the files modified to carry prominent notices stating that you changed the files and the date of any change.
- c) You must cause the whole of the work to be licensed at no charge to all third parties under the terms of this License.

d) If a facility in the modified Library refers to a function or a table of data to be supplied by an application program that uses the facility, other than as an argument passed when the facility is invoked, then you must make a good faith effort to ensure that, in the event an application does not supply such function or table, the facility still operates, and performs whatever part of its purpose remains meaningful.

(For example, a function in a library to compute square roots has a purpose that is entirely well-defined independent of the application. Therefore, Subsection 2d requires that any application-supplied function or table used by this function must be optional: if the application does not supply it, the square root function must still compute square roots.)

These requirements apply to the modified work as a whole. If identifiable sections of that work are not derived from the Library, and can be reasonably considered independent and separate works in themselves, then this License, and its terms, do not apply to those sections when you distribute them as separate works. But when you distribute the same sections as part of a whole which is a work based on the Library, the distribution of the whole must be on the terms of this License, whose permissions for other licensees extend to the entire whole, and thus to each and every part regardless of who wrote it.

Thus, it is not the intent of this section to claim rights or contest your rights to work written entirely by you; rather, the intent is to exercise the right to control the distribution of derivative or collective works based on the Library.

In addition, mere aggregation of another work not based on the Library with the Library (or with a work based on the Library) on a volume of a storage or distribution medium does not bring the other work under the scope of this License.

3. You may opt to apply the terms of the ordinary GNU General Public License instead of this License to a given copy of the Library. To do this, you must alter all the notices that refer to this License, so that they refer to the ordinary GNU General Public License, version 2, instead of to this License. (If a newer version than version 2 of the ordinary GNU General Public License has appeared, then you can specify that version instead if you wish.) Do not make any other change in these notices.

Once this change is made in a given copy, it is irreversible for that copy, so the ordinary GNU General Public License applies to all subsequent copies and derivative works made from that copy.

This option is useful when you wish to copy part of the code of the Library into a program that is not a library.

4. You may copy and distribute the Library (or a portion or derivative of it, under Section 2) in object code or executable form under the terms of Sections 1 and 2 above provided that you accompany it with the complete corresponding machine-readable source code, which must be distributed under the terms of Sections 1 and 2 above on a medium customarily used for software interchange.

If distribution of object code is made by offering access to copy from a designated place, then offering equivalent access to copy the source code from the same place satisfies the requirement to distribute the source code, even though third parties are not compelled to copy the source along with the object code.

5. A program that contains no derivative of any portion of the Library, but is designed to work with the Library by being compiled or linked with it, is called a "work that uses the Library". Such a work, in isolation, is not a derivative work of the Library, and therefore falls outside the scope of this License.

However, linking a "work that uses the Library" with the Library creates an executable that is a derivative of the Library (because it contains portions of the Library), rather than a "work that uses the library". The executable is therefore covered by this License. Section 6 states terms for distribution of such executables.

When a "work that uses the Library" uses material from a header file that is part of the Library, the object code for the work may be a derivative work of the Library even though the source code is not. Whether this is true is especially significant if the work can be linked without the Library, or if the work is itself a library. The threshold for this to be true is not precisely defined by law.

If such an object file uses only numerical parameters, data structure layouts and accessors, and small macros and small inline functions (ten lines or less in length), then the use of the object file is unrestricted, regardless of whether it is legally a derivative work. (Executables containing this object code plus portions of the Library will still fall under Section 6.)

Otherwise, if the work is a derivative of the Library, you may distribute the object code for the work under the terms of Section 6. Any executables containing that work also fall under Section 6, whether or not they are linked directly with the Library itself.

6. As an exception to the Sections above, you may also combine or link a "work that uses the Library" with the Library to produce a work containing portions of the Library, and distribute that work under terms of your choice, provided that the terms permit modification of the work for the customer's own use and reverse engineering for debugging such modifications.

You must give prominent notice with each copy of the work that the Library is used in it and that the Library and its use are covered by this License. You must supply a copy of this License. If the work during execution displays copyright notices, you must include the copyright notice for the Library among them, as well as a reference directing the user to the copy of this License. Also, you must do one of these things:

a) Accompany the work with the complete corresponding machine-readable source code for the Library including whatever changes were used in the work (which must be distributed under Sections 1 and 2 above); and, if the work is an executable linked with the Library, with the complete machine-readable "work that uses the Library", as object code and/or source code, so that the user can modify the Library and then relink to produce a modified executable containing the modified Library. (It is understood that the user who changes the contents of definitions files in the Library will not necessarily be able to recompile the application to use the modified definitions.)

b) Use a suitable shared library mechanism for linking with the Library. A suitable mechanism is one that (1) uses at run time a copy of the library already present on the user's computer system, rather than copying library functions into the executable, and (2) will operate properly with a modified version of the

library, if the user installs one, as long as the modified version is interface-compatible with the version that the work was made with.

c) Accompany the work with a written offer, valid for at least three years, to give the same user the materials specified in Subsection 6a, above, for a charge no more than the cost of performing this distribution.

d) If distribution of the work is made by offering access to copy from a designated place, offer equivalent access to copy the above specified materials from the same place.

e) Verify that the user has already received a copy of these materials or that you have already sent this user a copy.

For an executable, the required form of the "work that uses the Library" must include any data and utility programs needed for reproducing the executable from it. However, as a special exception, the materials to be distributed need not include anything that is normally distributed (in either source or binary form) with the major components (compiler, kernel, and so on) of the operating system on which the executable runs, unless that component itself accompanies the executable.

It may happen that this requirement contradicts the license restrictions of other proprietary libraries that do not normally accompany the operating system. Such a contradiction means you cannot use both them and the Library together in an executable that you distribute.

7. You may place library facilities that are a work based on the Library side-by-side in a single library together with other library facilities not covered by this License, and distribute such a combined library, provided that the separate distribution of the work based on the Library and of the other library facilities is otherwise permitted, and provided that you do these two things:

a) Accompany the combined library with a copy of the same work based on the Library, uncombined with any other library facilities. This must be distributed under the terms of the Sections above.

b) Give prominent notice with the combined library of the fact that part of it is a work based on the Library, and explaining where to find the accompanying uncombined form of the same work.

8. You may not copy, modify, sublicense, link with, or distribute the Library except as expressly provided under this License. Any attempt otherwise to copy, modify, sublicense, link with, or distribute the Library is void, and will automatically terminate your rights under this License. However, parties who have received copies, or rights, from you under this License will not have their licenses terminated so long as such parties remain in full compliance.

9. You are not required to accept this License, since you have not signed it. However, nothing else grants you permission to modify or distribute the Library or its derivative works. These actions are prohibited by law if you do not accept this License. Therefore, by modifying or distributing the Library (or any work based on the Library), you indicate your acceptance of this License to do so, and all its terms and conditions for copying, distributing or modifying the Library or works based on it.

10. Each time you redistribute the Library (or any work based on the Library), the recipient automatically receives a license from the original licensor to copy, distribute, link with or modify the Library subject to these terms and conditions. You may not impose any further restrictions on the recipients' exercise of the rights granted herein. You are not responsible for enforcing compliance by third parties with this License.

11. If, as a consequence of a court judgment or allegation of patent infringement or for any other reason (not limited to patent issues), conditions are imposed on you (whether by court order, agreement or otherwise) that contradict the conditions of this License, they do not excuse you from the conditions of this License. If you cannot distribute so as to satisfy simultaneously your obligations under this License and any other pertinent obligations, then as a consequence you may not distribute the Library at all. For example, if a patent license would not permit royalty-free redistribution of the Library by all those who receive copies directly or indirectly through you, then the only way you could satisfy both it and this License would be to refrain entirely from distribution of the Library.

If any portion of this section is held invalid or unenforceable under any particular circumstance, the balance of the section is intended to apply, and the section as a whole is intended to apply in other circumstances.

It is not the purpose of this section to induce you to infringe any patents or other property right claims or to contest validity of any such claims; this section has the sole purpose of protecting the integrity of the free software distribution system which is implemented by public license practices. Many people have made generous contributions to the wide range of software distributed through that system in reliance on consistent application of that system; it is up to the author/donor to decide if he or she is willing to distribute software through any other system and a licensee cannot impose that choice.

This section is intended to make thoroughly clear what is believed to be a consequence of the rest of this License.

12. If the distribution and/or use of the Library is restricted in certain countries either by patents or by copyrighted interfaces, the original copyright holder who places the Library under this License may add an explicit geographical distribution limitation excluding those countries, so that distribution is permitted only in or among countries not thus excluded. In such case, this License incorporates the limitation as if written in the body of this License.

13. The Free Software Foundation may publish revised and/or new versions of the Lesser General Public License from time to time. Such new versions will be similar in spirit to the present version, but may differ in detail to address new problems or concerns.

Each version is given a distinguishing version number. If the Library specifies a version number of this License which applies to it and "any later version", you have the option of following the terms and conditions either of that version or of any later version published by the Free Software Foundation. If the Library does not specify a license version number, you may choose any version ever published by the Free Software Foundation.

14. If you wish to incorporate parts of the Library into other free programs whose distribution conditions are incompatible with these, write to the author to ask for permission. For software which is copyrighted by the Free Software Foundation, write to the Free Software Foundation; we sometimes make exceptions for this. Our decision will be guided by the two goals of preserving the free status of all derivatives of our free software and of promoting the sharing and reuse of software generally.

#### **NO WARRANTY**

15. BECAUSE THE LIBRARY IS LICENSED FREE OF CHARGE, THERE IS NO WARRANTY FOR THE LIBRARY, TO THE EXTENT PERMITTED BY APPLICABLE LAW. EXCEPT WHEN OTHERWISE STATED IN WRITING THE COPYRIGHT HOLDERS AND/OR OTHER PARTIES PROVIDE THE LIBRARY "AS IS" WITHOUT WARRANTY OF ANY KIND, EITHER EXPRESSED OR IMPLIED, INCLUDING, BUT NOT LIMITED TO, THE IMPLIED WARRANTIES OF MERCHANTABILITY AND FITNESS FOR A PARTICULAR PURPOSE. THE ENTIRE RISK AS TO THE QUALITY AND PERFORMANCE OF THE LIBRARY IS WITH YOU. SHOULD THE LIBRARY PROVE DEFECTIVE, YOU ASSUME THE COST OF ALL NECESSARY SERVICING, REPAIR OR CORRECTION.

16. IN NO EVENT UNLESS REQUIRED BY APPLICABLE LAW OR AGREED TO IN WRITING WILL ANY COPYRIGHT HOLDER, OR ANY OTHER PARTY WHO MAY MODIFY AND/OR REDISTRIBUTE THE LIBRARY AS PERMITTED ABOVE, BE LIABLE TO YOU FOR DAMAGES, INCLUDING ANY GENERAL, SPECIAL, INCIDENTAL OR CONSEQUENTIAL DAMAGES ARISING OUT OF THE USE OR INABILITY TO USE THE LIBRARY (INCLUDING BUT NOT LIMITED TO LOSS OF DATA OR DATA BEING RENDERED INACCURATE OR LOSSES SUSTAINED BY YOU OR THIRD PARTIES OR A FAILURE OF THE LIBRARY TO OPERATE WITH ANY OTHER SOFTWARE), EVEN IF SUCH HOLDER OR OTHER PARTY HAS BEEN ADVISED OF THE POSSIBILITY OF SUCH DAMAGES.

END OF TERMS AND CONDITIONS

#### **How to Apply These Terms to Your New Libraries**

If you develop a new library, and you want it to be of the greatest possible use to the public, we recommend making it free software that everyone can redistribute and change. You can do so by permitting redistribution under these terms (or, alternatively, under the terms of the ordinary General Public License).

To apply these terms, attach the following notices to the library. It is safest to attach them to the start of each source file to most effectively convey the exclusion of warranty; and each file should have at least the "copyright" line and a pointer to where the full notice is found.

<one line to give the library's name and a brief idea of what it does.>

Copyright (C) <year> <name of author>

This library is free software; you can redistribute it and/or modify it under the terms of the GNU Lesser General Public License as published by the Free Software Foundation; either version 2.1 of the License, or (at your option) any later version.

This library is distributed in the hope that it will be useful, but WITHOUT ANY WARRANTY; without even the implied warranty of MERCHANTABILITY or FITNESS FOR A PARTICULAR PURPOSE. See the GNU Lesser General Public License for more details.

You should have received a copy of the GNU Lesser General Public License along with this library; if not, write to the Free Software Foundation, Inc., 51 Franklin Street, Fifth Floor, Boston, MA 02110-1301 USA

Also add information on how to contact you by electronic and paper mail.

You should also get your employer (if you work as a programmer) or your school, if any, to sign a "copyright disclaimer" for the library, if necessary. Here is a sample; alter the names:

Yoyodyne, Inc., hereby disclaims all copyright interest in the library `Frob' (a library for tweaking knobs) written by James Random Hacker.

<signature of Ty Coon>, 1 April 1990

Ty Coon, President of Vice

That's all there is to it!

### **BSD License (Berkeley Software Distribution License)**

This projector product includes the open source software program "University of California, Berkeley License (Berkeley Software Distribution License)" which applies the terms and conditions provided by owner of the copyright to the "BSD License".

The "BSD License" are WITHOUT ANY WARRANTY; without even the implied warranty of MERCHANTABILITY AND FITNESS FOR A PARTICULAR PURPOSE.

List of BSD License programs

- busybox-1.13.4
- busybox-1.18.4
- tcpdump-3.9.7
- pppd-2.4.4
- WPA Supplicant 0.8

License terms of conditions of each program which are provided by owner of the copyright to the "BSD License" are as follows.

Copyright (c) The Regents of the University of California. All rights reserved.

This code is derived from software contributed to Berkeley by Kenneth Almquist.

Redistribution and use in source and binary forms, with or without modification, are permitted provided that the following conditions are met:

1. Redistributions of source code must retain the above copyright notice, this list of conditions and the following disclaimer.
2. Redistributions in binary form must reproduce the above copyright notice, this list of conditions and the following disclaimer in the documentation and/or other materials provided with the distribution.
3. Neither the name of the University nor the names of its contributors may be used to endorse or promote products derived from this software without specific prior written permission.

THIS SOFTWARE IS PROVIDED BY THE REGENTS AND CONTRIBUTORS "AS IS" AND ANY EXPRESS OR IMPLIED WARRANTIES, INCLUDING, BUT NOT LIMITED TO, THE IMPLIED WARRANTIES OF MERCHANTABILITY AND FITNESS FOR A PARTICULAR PURPOSE ARE DISCLAIMED. IN NO EVENT SHALL THE REGENTS OR CONTRIBUTORS BE LIABLE FOR ANY DIRECT, INDIRECT, INCIDENTAL, SPECIAL, EXEMPLARY, OR CONSEQUENTIAL DAMAGES (INCLUDING, BUT NOT LIMITED TO, PROCUREMENT OF SUBSTITUTE GOODS OR SERVICES; LOSS OF USE, DATA, OR PROFITS; OR BUSINESS INTERRUPTION) HOWEVER CAUSED AND ON ANY THEORY OF LIABILITY, WHETHER IN CONTRACT, STRICT LIABILITY, OR TORT (INCLUDING NEGLIGENCE OR OTHERWISE) ARISING IN ANY WAY OUT OF THE USE OF THIS SOFTWARE, EVEN IF ADVISED OF THE POSSIBILITY OF SUCH DAMAGE.

### **libjpeg**

This projector product includes the open source software program "libjpeg" which applies the terms and conditions provided by owner of the copyright to the "libjpeg".

The "libjpeg" are WITHOUT ANY WARRANTY; without even the implied warranty of MERCHANTABILITY AND FITNESS FOR A PARTICULAR PURPOSE.

List of libjpeg programs

- libjpeg-6b

License terms of conditions of each program which are provided by owner of the copyright to the "libjpeg" are as follows.

Copyright (C) 1994-1997, Thomas G. Lane. This file is part of the Independent JPEG Group's software. For conditions of distribution and use, see the accompanying README file.

This distribution contains the sixth public release of the Independent JPEG Group's free JPEG software. You are welcome to redistribute this software and to use it for any purpose, subject to the conditions under LEGAL ISSUES, below.

LEGAL ISSUES



=====

In plain English:

1. We don't promise that this software works. (But if you find any bugs, please let us know!)
2. You can use this software for whatever you want. You don't have to pay us.
3. You may not pretend that you wrote this software. If you use it in a program, you must acknowledge somewhere in your documentation that you've used the IJG code.

In legalese:

The authors make NO WARRANTY or representation, either express or implied, with respect to this software, its quality, accuracy, merchantability, or fitness for a particular purpose. This software is provided "AS IS", and you, its user, assume the entire risk as to its quality and accuracy.

This software is copyright (C) 1991-1998, Thomas G. Lane. All Rights Reserved except as specified below.

Permission is hereby granted to use, copy, modify, and distribute this software (or portions thereof) for any purpose, without fee, subject to these conditions:

- (1) If any part of the source code for this software is distributed, then this README file must be included, with this copyright and no-warranty notice unaltered; and any additions, deletions, or changes to the original files must be clearly indicated in accompanying documentation.
- (2) If only executable code is distributed, then the accompanying documentation must state that "this software is based in part on the work of the Independent JPEG Group".
- (3) Permission for use of this software is granted only if the user accepts full responsibility for any undesirable consequences; the authors accept NO LIABILITY for damages of any kind.

These conditions apply to any software derived from or based on the IJG code, not just to the unmodified library. If you use our work, you ought to acknowledge us.

Permission is NOT granted for the use of any IJG author's name or company name in advertising or publicity relating to this software or products derived from it. This software may be referred to only as "the Independent JPEG Group's software".

We specifically permit and encourage the use of this software as the basis of commercial products, provided that all warranty or liability claims are assumed by the product vendor.

ansi2knr.c is included in this distribution by permission of L. Peter Deutsch, sole proprietor of its copyright holder, Aladdin Enterprises of Menlo Park, CA. ansi2knr.c is NOT covered by the above copyright and conditions, but instead by the usual distribution terms of the Free Software Foundation; principally, that you must include source code if you redistribute it. (See the file ansi2knr.c for full details.) However, since ansi2knr.c is not needed as part of any program generated from the IJG code, this does not limit you more than the foregoing paragraphs do.

The Unix configuration script "configure" was produced with GNU Autoconf. It is copyright by the Free Software Foundation but is freely distributable. The same holds for its supporting scripts (config.guess, config.sub, ltconfig, ltmain.sh). Another support script, install-sh, is copyright by M.I.T. but is also freely distributable.

It appears that the arithmetic coding option of the JPEG spec is covered by patents owned by IBM, AT&T, and Mitsubishi. Hence arithmetic coding cannot legally be used without obtaining one or more licenses. For this reason, support for arithmetic coding has been removed from the free JPEG software. (Since arithmetic coding provides only a marginal gain over the unpatented Huffman mode, it is unlikely that very many implementations will support it.) So far as we are aware, there are no patent restrictions on the remaining code.

The IJG distribution formerly included code to read and write GIF files. To avoid entanglement with the Unisys LZW patent, GIF reading support has been removed altogether, and the GIF writer has been simplified to produce "uncompressed GIFs". This technique does not use the LZW algorithm; the resulting GIF files are larger than usual, but are readable by all standard GIF decoders.

We are required to state that "The Graphics Interchange Format(c) is the Copyright property of CompuServe Incorporated. GIF(sm) is a Service Mark property of CompuServe Incorporated."

### **libpng**

This projector product includes the open source software program "libpng" which applies the terms and conditions provided by owner of the copyright to the "libpng".

The "libpng" are WITHOUT ANY WARRANTY; without even the implied warranty of MERCHANTABILITY AND FITNESS FOR A PARTICULAR PURPOSE.

List of libpng programs

- libpng-1.2.49
- libpng-1.2.18

License terms of conditions of each program which are provided by owner of the copyright to the "libpng" are as follows.

This copy of the libpng notices is provided for your convenience. In case of any discrepancy between this copy and the notices in the file png.h that is included in the libpng distribution, the latter shall prevail.

**COPYRIGHT NOTICE, DISCLAIMER, and LICENSE:**

If you modify libpng you may insert additional notices immediately following this sentence.

This code is released under the libpng license.

libpng versions 1.2.6, August 15, 2004, through 1.2.49, March 29, 2012, are Copyright (c) 2004, 2006-2009 Glenn Randers-Pehrson, and are distributed according to the same disclaimer and license as libpng-1.2.5 with the following individual added to the list of Contributing Authors

Cosmin Truta

libpng versions 1.0.7, July 1, 2000, through 1.2.5 - October 3, 2002, are Copyright (c) 2000-2002 Glenn Randers-Pehrson, and are distributed according to the same disclaimer and license as libpng-1.0.6 with the following individuals added to the list of Contributing Authors

Simon-Pierre Cadieux

Eric S. Raymond

Gilles Vollant

and with the following additions to the disclaimer:

There is no warranty against interference with your enjoyment of the library or against infringement. There is no warranty that our efforts or the library will fulfill any of your particular purposes or needs. This library is provided with all faults, and the entire risk of satisfactory quality, performance, accuracy, and effort is with the user.

libpng versions 0.97, January 1998, through 1.0.6, March 20, 2000, are Copyright (c) 1998, 1999 Glenn Randers-Pehrson, and are distributed according to the same disclaimer and license as libpng-0.96, with the following individuals added to the list of Contributing Authors:

Tom Lane

Glenn Randers-Pehrson

Willem van Schaik

libpng versions 0.89, June 1996, through 0.96, May 1997, are Copyright (c) 1996, 1997 Andreas Dilger Distributed according to the same disclaimer and license as libpng-0.88, with the following individuals added to the list of Contributing Authors:

John Bowler

Kevin Bracey

Sam Bushell

Magnus Holmgren

Greg Roelofs

Tom Tanner

libpng versions 0.5, May 1995, through 0.88, January 1996, are Copyright (c) 1995, 1996 Guy Eric Schalnat, Group 42, Inc.

For the purposes of this copyright and license, "Contributing Authors" is defined as the following set of individuals:

Andreas Dilger

Dave Martindale

Guy Eric Schalnat

Paul Schmidt

Tim Wegner

The PNG Reference Library is supplied "AS IS". The Contributing Authors and Group 42, Inc. disclaim all warranties, expressed or implied, including, without limitation, the warranties of merchantability and of fitness for any purpose. The Contributing Authors and Group 42, Inc. assume no liability for direct, indirect, incidental, special, exemplary, or consequential damages, which may result from the use of the PNG Reference Library, even if advised of the possibility of such damage.

Permission is hereby granted to use, copy, modify, and distribute this source code, or portions hereof, for any purpose, without fee, subject to the following restrictions:

1. The origin of this source code must not be misrepresented.
2. Altered versions must be plainly marked as such and must not be misrepresented as being the original source.
3. This Copyright notice may not be removed or altered from any source or altered source distribution.

The Contributing Authors and Group 42, Inc. specifically permit, without fee, and encourage the use of this source code as a component to supporting the PNG file format in commercial products. If you use this source code in a product, acknowledgment is not required but would be appreciated.

A "png\_get\_copyright" function is available, for convenient use in "about" boxes and the like:

```
printf("%s",png_get_copyright(NULL));
```

Also, the PNG logo (in PNG format, of course) is supplied in the files "pngbar.png" and "pngbar.jpg" (88x31) and "pngnow.png" (98x31).

Libpng is OSI Certified Open Source Software. OSI Certified Open Source is a certification mark of the Open Source Initiative.

Glenn Randers-Pehrson

glennrp at users.sourceforge.net

March 29, 2012

## **zlib**

This projector product includes the open source software program "zlib" which applies the terms and conditions provided by owner of the copyright to the "zlib".

The "zlib" are WITHOUT ANY WARRANTY; without even the implied warranty of MERCHANTABILITY AND FITNESS FOR A PARTICULAR PURPOSE.

List of zlib programs

- zlib-1.1.4
- zlib-1.2.3

License terms of conditions of each program which are provided by owner of the copyright to the "zlib" are as follows.

Copyright notice:

(C) 1995-1998 Jean-loup Gailly and Mark Adler

This software is provided 'as-is', without any express or implied warranty. In no event will the authors be held liable for any damages arising from the use of this software.

Permission is granted to anyone to use this software for any purpose, including commercial applications, and to alter it and redistribute it freely, subject to the following restrictions:

1. The origin of this software must not be misrepresented; you must not claim that you wrote the original software. If you use this software in a product, an acknowledgment in the product documentation would be appreciated but is not required.
2. Altered source versions must be plainly marked as such, and must not be misrepresented as being the original software.
3. This notice may not be removed or altered from any source distribution.

Jean-loup Gailly

jloup@gzip.org

Mark Adler

madler@alumni.caltech.edu

If you use the zlib library in a product, we would appreciate \*not\* receiving lengthy legal documents to sign. The sources are provided for free but without warranty of any kind. The library has been entirely written by Jean-loup Gailly and Mark Adler; it does not include third-party code.

If you redistribute modified sources, we would appreciate that you include in the file ChangeLog history information documenting your changes.

## **Apache-2.0**

This projector product includes the open source software program which applies the terms and conditions provided by owner of the copyright to the "Apache-2.0".

The "Apache-2.0" are WITHOUT ANY WARRANTY; without even the implied warranty of MERCHANTABILITY AND FITNESS FOR A PARTICULAR PURPOSE.

List of Apache-2.0 programs

- mDNSResponder-107.6 (only mDNSResponderPosix is used)
- DroidSansFallback.ttf

License terms of conditions of each program which are provided by owner of the copyright to the "Apache-2.0" are as follows.

### **Apache License**

Version 2.0, January 2004

<http://www.apache.org/licenses/>

### **TERMS AND CONDITIONS FOR USE, REPRODUCTION, AND DISTRIBUTION**

#### 1. Definitions.

"License" shall mean the terms and conditions for use, reproduction, and distribution as defined by Sections 1 through 9 of this document.

"Licensor" shall mean the copyright owner or entity authorized by the copyright owner that is granting the License.

"Legal Entity" shall mean the union of the acting entity and all other entities that control, are controlled by, or are under common control with that entity. For the purposes of this definition, "control" means (i) the power, direct or indirect, to cause the direction or management of such entity, whether by contract or otherwise, or (ii) ownership of fifty percent (50%) or more of the outstanding shares, or (iii) beneficial ownership of such entity.

"You" (or "Your") shall mean an individual or Legal Entity exercising permissions granted by this License.

"Source" form shall mean the preferred form for making modifications, including but not limited to software source code, documentation source, and configuration files.

"Object" form shall mean any form resulting from mechanical transformation or translation of a Source form, including but not limited to compiled object code, generated documentation, and conversions to other media types.

"Work" shall mean the work of authorship, whether in Source or Object form, made available under the License, as indicated by a copyright notice that is included in or attached to the work (an example is provided in the Appendix below).

"Derivative Works" shall mean any work, whether in Source or Object form, that is based on (or derived from) the Work and for which the editorial revisions, annotations, elaborations, or other modifications represent, as a whole, an original work of authorship. For the purposes of this License, Derivative Works shall not include works that remain separable from, or merely link (or bind by name) to the interfaces of, the Work and Derivative Works thereof.

"Contribution" shall mean any work of authorship, including the original version of the Work and any modifications or additions to that Work or Derivative Works thereof, that is intentionally submitted to Licensor for inclusion in the Work by the copyright owner or by an individual or Legal Entity authorized to submit on behalf of the copyright owner. For the purposes of this definition, "submitted" means any form of electronic, verbal, or written communication sent to the Licensor or its representatives, including but not limited to communication on electronic mailing lists, source code control systems, and issue tracking systems that are managed by, or on behalf of, the Licensor for the purpose of discussing and improving the Work, but excluding communication that is conspicuously marked or otherwise designated in writing by the copyright owner as "Not a Contribution."

"Contributor" shall mean Licensor and any individual or Legal Entity on behalf of whom a Contribution has been received by Licensor and subsequently incorporated within the Work.

2. Grant of Copyright License. Subject to the terms and conditions of this License, each Contributor hereby grants to You a perpetual, worldwide, non-exclusive, no-charge, royalty-free, irrevocable copyright license to reproduce, prepare Derivative Works of, publicly display, publicly perform, sublicense, and distribute the Work and such Derivative Works in Source or Object form.

3. Grant of Patent License. Subject to the terms and conditions of this License, each Contributor hereby grants to You a perpetual, worldwide, non-exclusive, no-charge, royalty-free, irrevocable (except as stated in this section) patent license to make, have made, use, offer to sell, sell, import, and otherwise transfer the Work, where such license applies only to those patent claims licensable by such Contributor that are necessarily infringed by their Contribution(s) alone or by combination of their Contribution(s) with the Work to which such Contribution(s) was submitted. If You institute patent litigation against any entity (including a cross-claim or counterclaim in a lawsuit) alleging that the Work or a Contribution incorporated within the Work constitutes direct or contributory patent infringement, then any patent licenses granted to You under this License for that Work shall terminate as of the date such litigation is filed.

4. Redistribution. You may reproduce and distribute copies of the Work or Derivative Works thereof in any medium, with or without modifications, and in Source or Object form, provided that You meet the following conditions:

(a) You must give any other recipients of the Work or Derivative Works a copy of this License; and

- (b) You must cause any modified files to carry prominent notices stating that You changed the files; and
- (c) You must retain, in the Source form of any Derivative Works that You distribute, all copyright, patent, trademark, and attribution notices from the Source form of the Work, excluding those notices that do not pertain to any part of the Derivative Works; and
- (d) If the Work includes a "NOTICE" text file as part of its distribution, then any Derivative Works that You distribute must include a readable copy of the attribution notices contained within such NOTICE file, excluding those notices that do not pertain to any part of the Derivative Works, in at least one of the following places: within a NOTICE text file distributed as part of the Derivative Works; within the Source form or documentation, if provided along with the Derivative Works; or, within a display generated by the Derivative Works, if and wherever such third-party notices normally appear. The contents of the NOTICE file are for informational purposes only and do not modify the License. You may add Your own attribution notices within Derivative Works that You distribute, alongside or as an addendum to the NOTICE text from the Work, provided that such additional attribution notices cannot be construed as modifying the License.

You may add Your own copyright statement to Your modifications and may provide additional or different license terms and conditions for use, reproduction, or distribution of Your modifications, or for any such Derivative Works as a whole, provided Your use, reproduction, and distribution of the Work otherwise complies with the conditions stated in this License.

5. Submission of Contributions. Unless You explicitly state otherwise, any Contribution intentionally submitted for inclusion in the Work by You to the Licensor shall be under the terms and conditions of this License, without any additional terms or conditions.

Notwithstanding the above, nothing herein shall supersede or modify the terms of any separate license agreement you may have executed with Licensor regarding such Contributions.

6. Trademarks. This License does not grant permission to use the trade names, trademarks, service marks, or product names of the Licensor, except as required for reasonable and customary use in describing the origin of the Work and reproducing the content of the NOTICE file.

7. Disclaimer of Warranty. Unless required by applicable law or agreed to in writing, Licensor provides the Work (and each Contributor provides its Contributions) on an "AS IS" BASIS, WITHOUT WARRANTIES OR CONDITIONS OF ANY KIND, either express or implied, including, without limitation, any warranties or conditions of TITLE, NON-INFRINGEMENT, MERCHANTABILITY, or FITNESS FOR A PARTICULAR PURPOSE. You are solely responsible for determining the appropriateness of using or redistributing the Work and assume any risks associated with Your exercise of permissions under this License.

8. Limitation of Liability. In no event and under no legal theory, whether in tort (including negligence), contract, or otherwise, unless required by applicable law (such as deliberate and grossly negligent acts) or agreed to in writing, shall any Contributor be liable to You for damages, including any direct, indirect, special, incidental, or consequential damages of any character arising as a result of this License or out of



the use or inability to use the Work (including but not limited to damages for loss of goodwill, work stoppage, computer failure or malfunction, or any and all other commercial damages or losses), even if such Contributor has been advised of the possibility of such damages.

9. Accepting Warranty or Additional Liability. While redistributing the Work or Derivative Works thereof, You may choose to offer, and charge a fee for, acceptance of support, warranty, indemnity, or other liability obligations and/or rights consistent with this License. However, in accepting such obligations, You may act only on Your own behalf and on Your sole responsibility, not on behalf of any other Contributor, and only if You agree to indemnify, defend, and hold each Contributor harmless for any liability incurred by, or claims asserted against, such Contributor by reason of your accepting any such warranty or additional liability.

END OF TERMS AND CONDITIONS

#### **APPENDIX: How to apply the Apache License to your work.**

To apply the Apache License to your work, attach the following boilerplate notice, with the fields enclosed by brackets "[]" replaced with your own identifying information. (Don't include the brackets!) The text should be enclosed in the appropriate comment syntax for the file format. We also recommend that a file or class name and description of purpose be included on the same "printed page" as the copyright notice for easier identification within third-party archives.

Copyright [yyyy] [name of copyright owner]

Licensed under the Apache License, Version 2.0 (the "License");

you may not use this file except in compliance with the License.

You may obtain a copy of the License at

<http://www.apache.org/licenses/LICENSE-2.0>

Unless required by applicable law or agreed to in writing, software distributed under the License is distributed on an "AS IS" BASIS, WITHOUT WARRANTIES OR CONDITIONS OF ANY KIND, either express or implied.

See the License for the specific language governing permissions and limitations under the License.

#### **aes-src-29-04-09**

This projector product includes the open source software program "aes-src-29-04-09" which applies the terms and conditions provided by owner of the copyright to the "aes-src-29-04-09".

The "aes-src-29-04-09" are WITHOUT ANY WARRANTY; without even the implied warranty of MERCHANTABILITY AND FITNESS FOR A PARTICULAR PURPOSE.

List of aes-src-29-04-09 programs

- aes-src-29-04-09

License terms of conditions of each program which are provided by owner of the copyright to the "aes-src-29-04-09" are as follows.

Copyright (c) 1998-2008, Brian Gladman, Worcester, UK. All rights reserved.

#### LICENSE TERMS

The redistribution and use of this software (with or without changes) is allowed without the payment of fees or royalties provided that:

1. source code distributions include the above copyright notice, this list of conditions and the following disclaimer;
2. binary distributions include the above copyright notice, this list of conditions and the following disclaimer in their documentation;.
3. the name of the copyright holder is not used to endorse products built using this software without specific written permission.

#### DISCLAIMER

This software is provided 'as is' with no explicit or implied warranties in respect of its properties, including, but not limited to, correctness and/or fitness for purpose.

#### **newlib**

This projector product includes the open source software program "newlib" which applies the terms and conditions provided by owner of the copyright to the "newlib".

The "newlib" are WITHOUT ANY WARRANTY; without even the implied warranty of MERCHANTABILITY AND FITNESS FOR A PARTICULAR PURPOSE.

List of newlib programs

- newlib 1.17.0

License terms of conditions of each program which are provided by owner of the copyright to the "newlib" are as follows.

The newlib subdirectory is a collection of software from several sources.

Each file may have its own copyright/license that is embedded in the source file. Unless otherwise noted in the body of the source file(s), the following copyright notices will apply to the contents of the newlib subdirectory:

- (1) Red Hat Incorporated

Copyright (c) 1994-2007 Red Hat, Inc. All rights reserved.

This copyrighted material is made available to anyone wishing to use, modify, copy, or redistribute it subject to the terms and conditions of the BSD License. This program is distributed in the hope that it will be useful, but WITHOUT ANY WARRANTY expressed or implied, including the implied warranties of MERCHANTABILITY or FITNESS FOR A PARTICULAR PURPOSE. A copy of this license is available at <http://www.opensource.org/licenses>. Any Red Hat trademarks that are incorporated in the source code or documentation are not subject to the BSD License and may only be used or replicated with the express permission of Red Hat, Inc.

(2) University of California, Berkeley

Copyright (c) 1981-2000 The Regents of the University of California.

All rights reserved.

Redistribution and use in source and binary forms, with or without modification, are permitted provided that the following conditions are met:

\* Redistributions of source code must retain the above copyright notice, this list of conditions and the following disclaimer.

\* Redistributions in binary form must reproduce the above copyright notice, this list of conditions and the following disclaimer in the documentation and/or other materials provided with the distribution.

\* Neither the name of the University nor the names of its contributors may be used to endorse or promote products derived from this software without specific prior written permission.

THIS SOFTWARE IS PROVIDED BY THE COPYRIGHT HOLDERS AND CONTRIBUTORS "AS IS" AND ANY EXPRESS OR IMPLIED WARRANTIES, INCLUDING, BUT NOT LIMITED TO, THE IMPLIED WARRANTIES OF MERCHANTABILITY AND FITNESS FOR A PARTICULAR PURPOSE ARE DISCLAIMED. IN NO EVENT SHALL THE COPYRIGHT OWNER OR CONTRIBUTORS BE LIABLE FOR ANY DIRECT, INDIRECT, INCIDENTAL, SPECIAL, EXEMPLARY, OR CONSEQUENTIAL DAMAGES (INCLUDING, BUT NOT LIMITED TO, PROCUREMENT OF SUBSTITUTE GOODS OR SERVICES; LOSS OF USE, DATA, OR PROFITS; OR BUSINESS INTERRUPTION) HOWEVER CAUSED AND ON ANY THEORY OF LIABILITY, WHETHER IN CONTRACT, STRICT LIABILITY, OR TORT (INCLUDING NEGLIGENCE OR OTHERWISE) ARISING IN ANY WAY OUT OF THE USE OF THIS SOFTWARE, EVEN IF ADVISED OF THE POSSIBILITY OF SUCH DAMAGE.

(3) David M. Gay (AT&T 1991, Lucent 1998)

The author of this software is David M. Gay.

Copyright (c) 1991 by AT&T.

Permission to use, copy, modify, and distribute this software for any purpose without fee is hereby granted, provided that this entire notice is included in all copies of any software which is or includes a copy or modification of this software and in all copies of the supporting documentation for such software.

THIS SOFTWARE IS BEING PROVIDED "AS IS", WITHOUT ANY EXPRESS OR IMPLIED WARRANTY. IN PARTICULAR, NEITHER THE AUTHOR NOR AT&T MAKES ANY REPRESENTATION OR WARRANTY OF ANY KIND CONCERNING THE MERCHANTABILITY OF THIS SOFTWARE OR ITS FITNESS FOR ANY PARTICULAR PURPOSE.

-----

The author of this software is David M. Gay.

Copyright (C) 1998-2001 by Lucent Technologies

All Rights Reserved

Permission to use, copy, modify, and distribute this software and its documentation for any purpose and without fee is hereby granted, provided that the above copyright notice appear in all copies and that both that the copyright notice and this permission notice and warranty disclaimer appear in supporting documentation, and that the name of Lucent or any of its entities not be used in advertising or publicity pertaining to distribution of the software without specific, written prior permission.

LUCENT DISCLAIMS ALL WARRANTIES WITH REGARD TO THIS SOFTWARE, INCLUDING ALL IMPLIED WARRANTIES OF MERCHANTABILITY AND FITNESS. IN NO EVENT SHALL LUCENT OR ANY OF ITS ENTITIES BE LIABLE FOR ANY SPECIAL, INDIRECT OR CONSEQUENTIAL DAMAGES OR ANY DAMAGES WHATSOEVER RESULTING FROM LOSS OF USE, DATA OR PROFITS, WHETHER IN AN ACTION OF CONTRACT, NEGLIGENCE OR OTHER TORTIOUS ACTION, ARISING OUT OF OR IN CONNECTION WITH THE USE OR PERFORMANCE OF THIS SOFTWARE.

(4) Advanced Micro Devices

Copyright 1989, 1990 Advanced Micro Devices, Inc.

This software is the property of Advanced Micro Devices, Inc (AMD) which specifically grants the user the right to modify, use and distribute this software provided this notice is not removed or altered. All other rights are reserved by AMD.

AMD MAKES NO WARRANTY OF ANY KIND, EXPRESS OR IMPLIED, WITH REGARD TO THIS SOFTWARE. IN NO EVENT SHALL AMD BE LIABLE FOR INCIDENTAL OR CONSEQUENTIAL DAMAGES IN CONNECTION WITH OR ARISING FROM THE FURNISHING, PERFORMANCE, OR USE OF THIS SOFTWARE.

So that all may benefit from your experience, please report any problems or suggestions about this software to the 29K Technical Support Center at 800-29-29-AMD (800-292-9263) in the USA, or 0800-89-1131 in the UK, or 0031-11-1129 in Japan, toll free. The direct dial number is 512-462-4118.

Advanced Micro Devices, Inc.

29K Support Products

Mail Stop 573

5900 E. Ben White Blvd.

Austin, TX 78741

800-292-9263

(5) C.W. Sandmann

Copyright (C) 1993 C.W. Sandmann

This file may be freely distributed as long as the author's name remains.

(6) Eric Backus

(C) Copyright 1992 Eric Backus

This software may be used freely so long as this copyright notice is left intact. There is no warrantee on this software.

(7) Sun Microsystems

Copyright (C) 1993 by Sun Microsystems, Inc. All rights reserved.

Developed at SunPro, a Sun Microsystems, Inc. business. Permission to use, copy, modify, and distribute this software is freely granted, provided that this notice is preserved.

(8) Hewlett Packard

(c) Copyright 1986 HEWLETT-PACKARD COMPANY

To anyone who acknowledges that this file is provided "AS IS" without any express or implied warranty: permission to use, copy, modify, and distribute this file for any purpose is hereby granted without fee, provided that the above copyright notice and this notice appears in all copies, and that the name of Hewlett-Packard Company not be used in advertising or publicity pertaining to distribution of the software without specific, written prior permission. Hewlett-Packard Company makes no representations about the suitability of this software for any purpose.

(9) Hans-Peter Nilsson

Copyright (C) 2001 Hans-Peter Nilsson

Permission to use, copy, modify, and distribute this software is freely granted, provided that the above copyright notice, this notice and the following disclaimer are preserved with no changes.

THIS SOFTWARE IS PROVIDED "AS IS" AND WITHOUT ANY EXPRESS OR IMPLIED WARRANTIES, INCLUDING, WITHOUT LIMITATION, THE IMPLIED WARRANTIES OF MERCHANTABILITY AND FITNESS FOR A PARTICULAR PURPOSE.

(11) Christopher G. Demetriou

Copyright (c) 2001 Christopher G. Demetriou

All rights reserved.

Redistribution and use in source and binary forms, with or without modification, are permitted provided that the following conditions are met:

1. Redistributions of source code must retain the above copyright notice, this list of conditions and the following disclaimer.
2. Redistributions in binary form must reproduce the above copyright notice, this list of conditions and the following disclaimer in the documentation and/or other materials provided with the distribution.
3. The name of the author may not be used to endorse or promote products derived from this software without specific prior written permission.

THIS SOFTWARE IS PROVIDED BY THE AUTHOR "AS IS" AND ANY EXPRESS OR IMPLIED WARRANTIES, INCLUDING, BUT NOT LIMITED TO, THE IMPLIED WARRANTIES OF MERCHANTABILITY AND FITNESS FOR A PARTICULAR PURPOSE ARE DISCLAIMED. IN NO EVENT SHALL THE AUTHOR BE LIABLE FOR ANY DIRECT, INDIRECT, INCIDENTAL, SPECIAL, EXEMPLARY, OR CONSEQUENTIAL DAMAGES (INCLUDING, BUT NOT LIMITED TO, PROCUREMENT OF SUBSTITUTE GOODS OR SERVICES; LOSS OF USE, DATA, OR PROFITS; OR BUSINESS INTERRUPTION) HOWEVER CAUSED AND ON ANY THEORY OF LIABILITY, WHETHER IN CONTRACT, STRICT LIABILITY, OR TORT (INCLUDING NEGLIGENCE OR OTHERWISE) ARISING IN ANY WAY OUT OF THE USE OF THIS SOFTWARE, EVEN IF ADVISED OF THE POSSIBILITY OF SUCH DAMAGE.

(12) SuperH, Inc.

Copyright 2002 SuperH, Inc. All rights reserved

This software is the property of SuperH, Inc (SuperH) which specifically grants the user the right to modify, use and distribute this software provided this notice is not removed or altered. All other rights are reserved by SuperH.

SUPERH MAKES NO WARRANTY OF ANY KIND, EXPRESS OR IMPLIED, WITH REGARD TO THIS SOFTWARE. IN NO EVENT SHALL SUPERH BE LIABLE FOR INDIRECT, SPECIAL, INCIDENTAL OR CONSEQUENTIAL DAMAGES IN CONNECTION WITH OR ARISING FROM THE FURNISHING, PERFORMANCE, OR USE OF THIS SOFTWARE.

So that all may benefit from your experience, please report any problems or suggestions about this software to the SuperH Support Center via e-mail at [softwaresupport@superh.com](mailto:softwaresupport@superh.com) .

SuperH, Inc.

405 River Oaks Parkway

San Jose

CA 95134

USA

(13) Royal Institute of Technology

Copyright (c) 1999 Kungliga Tekniska Högskolan (Royal Institute of Technology, Stockholm, Sweden).

All rights reserved.

Redistribution and use in source and binary forms, with or without modification, are permitted provided that the following conditions are met:

1. Redistributions of source code must retain the above copyright notice, this list of conditions and the following disclaimer.
2. Redistributions in binary form must reproduce the above copyright notice, this list of conditions and the following disclaimer in the documentation and/or other materials provided with the distribution.
3. Neither the name of KTH nor the names of its contributors may be used to endorse or promote products derived from this software without specific prior written permission.

THIS SOFTWARE IS PROVIDED BY KTH AND ITS CONTRIBUTORS "AS IS" AND ANY EXPRESS OR IMPLIED WARRANTIES, INCLUDING, BUT NOT LIMITED TO, THE IMPLIED WARRANTIES OF MERCHANTABILITY AND FITNESS FOR A PARTICULAR PURPOSE ARE DISCLAIMED. IN NO EVENT SHALL KTH OR ITS CONTRIBUTORS BE LIABLE FOR ANY DIRECT, INDIRECT, INCIDENTAL, SPECIAL, EXEMPLARY, OR CONSEQUENTIAL DAMAGES (INCLUDING, BUT NOT LIMITED TO, PROCUREMENT OF SUBSTITUTE GOODS OR SERVICES; LOSS OF USE, DATA, OR PROFITS; OR BUSINESS INTERRUPTION) HOWEVER CAUSED AND ON ANY THEORY OF LIABILITY, WHETHER IN CONTRACT, STRICT LIABILITY, OR TORT (INCLUDING NEGLIGENCE OR OTHERWISE) ARISING IN ANY WAY OUT OF THE USE OF THIS SOFTWARE, EVEN IF ADVISED OF THE POSSIBILITY OF SUCH DAMAGE.

(14) Alexey Zelkin

Copyright (c) 2000, 2001 Alexey Zelkin <phantom@FreeBSD.org>

All rights reserved.

Redistribution and use in source and binary forms, with or without modification, are permitted provided that the following conditions are met:

1. Redistributions of source code must retain the above copyright notice, this list of conditions and the following disclaimer.
2. Redistributions in binary form must reproduce the above copyright notice, this list of conditions and the following disclaimer in the documentation and/or other materials provided with the distribution.

THIS SOFTWARE IS PROVIDED BY THE AUTHOR AND CONTRIBUTORS "AS IS" AND ANY EXPRESS OR IMPLIED WARRANTIES, INCLUDING, BUT NOT LIMITED TO, THE IMPLIED WARRANTIES OF MERCHANTABILITY AND FITNESS FOR A PARTICULAR PURPOSE ARE

DISCLAIMED. IN NO EVENT SHALL THE AUTHOR OR CONTRIBUTORS BE LIABLE FOR ANY DIRECT, INDIRECT, INCIDENTAL, SPECIAL, EXEMPLARY, OR CONSEQUENTIAL DAMAGES (INCLUDING, BUT NOT LIMITED TO, PROCUREMENT OF SUBSTITUTE GOODS OR SERVICES; LOSS OF USE, DATA, OR PROFITS; OR BUSINESS INTERRUPTION) HOWEVER CAUSED AND ON ANY THEORY OF LIABILITY, WHETHER IN CONTRACT, STRICT LIABILITY, OR TORT (INCLUDING NEGLIGENCE OR OTHERWISE) ARISING IN ANY WAY OUT OF THE USE OF THIS SOFTWARE, EVEN IF ADVISED OF THE POSSIBILITY OF SUCH DAMAGE.

(15) Andrey A. Chernov

Copyright (C) 1997 by Andrey A. Chernov, Moscow, Russia.

All rights reserved.

Redistribution and use in source and binary forms, with or without modification, are permitted provided that the following conditions are met:

1. Redistributions of source code must retain the above copyright notice, this list of conditions and the following disclaimer.
2. Redistributions in binary form must reproduce the above copyright notice, this list of conditions and the following disclaimer in the documentation and/or other materials provided with the distribution.

THIS SOFTWARE IS PROVIDED BY THE AUTHOR "AS IS" AND ANY EXPRESS OR IMPLIED WARRANTIES, INCLUDING, BUT NOT LIMITED TO, THE IMPLIED WARRANTIES OF MERCHANTABILITY AND FITNESS FOR A PARTICULAR PURPOSE ARE DISCLAIMED. IN NO EVENT SHALL THE REGENTS OR CONTRIBUTORS BE LIABLE FOR ANY DIRECT, INDIRECT, INCIDENTAL, SPECIAL, EXEMPLARY, OR CONSEQUENTIAL DAMAGES (INCLUDING, BUT NOT LIMITED TO, PROCUREMENT OF SUBSTITUTE GOODS OR SERVICES; LOSS OF USE, DATA, OR PROFITS; OR BUSINESS INTERRUPTION) HOWEVER CAUSED AND ON ANY THEORY OF LIABILITY, WHETHER IN CONTRACT, STRICT LIABILITY, OR TORT (INCLUDING NEGLIGENCE OR OTHERWISE) ARISING IN ANY WAY OUT OF THE USE OF THIS SOFTWARE, EVEN IF ADVISED OF THE POSSIBILITY OF SUCH DAMAGE.

(16) FreeBSD

Copyright (c) 1997-2002 FreeBSD Project.

All rights reserved.

Redistribution and use in source and binary forms, with or without modification, are permitted provided that the following conditions are met:

1. Redistributions of source code must retain the above copyright notice, this list of conditions and the following disclaimer.
2. Redistributions in binary form must reproduce the above copyright notice, this list of conditions and the following disclaimer in the documentation and/or other materials provided with the distribution.



THIS SOFTWARE IS PROVIDED BY THE AUTHOR AND CONTRIBUTORS "AS IS" AND ANY EXPRESS OR IMPLIED WARRANTIES, INCLUDING, BUT NOT LIMITED TO, THE IMPLIED WARRANTIES OF MERCHANTABILITY AND FITNESS FOR A PARTICULAR PURPOSE ARE DISCLAIMED. IN NO EVENT SHALL THE AUTHOR OR CONTRIBUTORS BE LIABLE FOR ANY DIRECT, INDIRECT, INCIDENTAL, SPECIAL, EXEMPLARY, OR CONSEQUENTIAL DAMAGES (INCLUDING, BUT NOT LIMITED TO, PROCUREMENT OF SUBSTITUTE GOODS OR SERVICES; LOSS OF USE, DATA, OR PROFITS; OR BUSINESS INTERRUPTION) HOWEVER CAUSED AND ON ANY THEORY OF LIABILITY, WHETHER IN CONTRACT, STRICT LIABILITY, OR TORT (INCLUDING NEGLIGENCE OR OTHERWISE) ARISING IN ANY WAY OUT OF THE USE OF THIS SOFTWARE, EVEN IF ADVISED OF THE POSSIBILITY OF SUCH DAMAGE.

(17) S. L. Moshier

Author: S. L. Moshier.

Copyright (c) 1984,2000 S.L. Moshier

Permission to use, copy, modify, and distribute this software for any purpose without fee is hereby granted, provided that this entire notice is included in all copies of any software which is or includes a copy or modification of this software and in all copies of the supporting documentation for such software.

THIS SOFTWARE IS BEING PROVIDED "AS IS", WITHOUT ANY EXPRESS OR IMPLIED WARRANTY. IN PARTICULAR, THE AUTHOR MAKES NO REPRESENTATION OR WARRANTY OF ANY KIND CONCERNING THE MERCHANTABILITY OF THIS SOFTWARE OR ITS FITNESS FOR ANY PARTICULAR PURPOSE.

(18) Citrus Project

Copyright (c)1999 Citrus Project,

All rights reserved.

Redistribution and use in source and binary forms, with or without modification, are permitted provided that the following conditions are met:

1. Redistributions of source code must retain the above copyright notice, this list of conditions and the following disclaimer.
2. Redistributions in binary form must reproduce the above copyright notice, this list of conditions and the following disclaimer in the documentation and/or other materials provided with the distribution.

THIS SOFTWARE IS PROVIDED BY THE AUTHOR AND CONTRIBUTORS "AS IS" AND ANY EXPRESS OR IMPLIED WARRANTIES, INCLUDING, BUT NOT LIMITED TO, THE IMPLIED WARRANTIES OF MERCHANTABILITY AND FITNESS FOR A PARTICULAR PURPOSE ARE DISCLAIMED. IN NO EVENT SHALL THE AUTHOR OR CONTRIBUTORS BE LIABLE FOR ANY DIRECT, INDIRECT, INCIDENTAL, SPECIAL, EXEMPLARY, OR CONSEQUENTIAL DAMAGES (INCLUDING, BUT NOT LIMITED TO, PROCUREMENT OF SUBSTITUTE GOODS OR SERVICES;

LOSS OF USE, DATA, OR PROFITS; OR BUSINESS INTERRUPTION) HOWEVER CAUSED AND ON ANY THEORY OF LIABILITY, WHETHER IN CONTRACT, STRICT LIABILITY, OR TORT (INCLUDING NEGLIGENCE OR OTHERWISE) ARISING IN ANY WAY OUT OF THE USE OF THIS SOFTWARE, EVEN IF ADVISED OF THE POSSIBILITY OF SUCH DAMAGE.

(19) Todd C. Miller

Copyright (c) 1998 Todd C. Miller <Todd.Miller@courtesan.com>

All rights reserved.

Redistribution and use in source and binary forms, with or without modification, are permitted provided that the following conditions are met:

1. Redistributions of source code must retain the above copyright notice, this list of conditions and the following disclaimer.
2. Redistributions in binary form must reproduce the above copyright notice, this list of conditions and the following disclaimer in the documentation and/or other materials provided with the distribution.
3. The name of the author may not be used to endorse or promote products derived from this software without specific prior written permission.

THIS SOFTWARE IS PROVIDED "AS IS" AND ANY EXPRESS OR IMPLIED WARRANTIES, INCLUDING, BUT NOT LIMITED TO, THE IMPLIED WARRANTIES OF MERCHANTABILITY AND FITNESS FOR A PARTICULAR PURPOSE ARE DISCLAIMED. IN NO EVENT SHALL THE AUTHOR BE LIABLE FOR ANY DIRECT, INDIRECT, INCIDENTAL, SPECIAL, EXEMPLARY, OR CONSEQUENTIAL DAMAGES (INCLUDING, BUT NOT LIMITED TO, PROCUREMENT OF SUBSTITUTE GOODS OR SERVICES; LOSS OF USE, DATA, OR PROFITS; OR BUSINESS INTERRUPTION) HOWEVER CAUSED AND ON ANY THEORY OF LIABILITY, WHETHER IN CONTRACT, STRICT LIABILITY, OR TORT (INCLUDING NEGLIGENCE OR OTHERWISE) ARISING IN ANY WAY OUT OF THE USE OF THIS SOFTWARE, EVEN IF ADVISED OF THE POSSIBILITY OF SUCH DAMAGE.

(20) DJ Delorie (i386)

Copyright (C) 1991 DJ Delorie

All rights reserved.

Redistribution and use in source and binary forms is permitted provided that the above copyright notice and following paragraph are duplicated in all such forms.

This file is distributed WITHOUT ANY WARRANTY; without even the implied warranty of MERCHANTABILITY or FITNESS FOR A PARTICULAR PURPOSE.

(23) Intel (i960)

Copyright (c) 1993 Intel Corporation

Intel hereby grants you permission to copy, modify, and distribute this software and its documentation. Intel grants this permission provided that the above copyright notice appears in all copies and that both the copyright notice and this permission notice appear in supporting documentation. In addition, Intel grants this permission provided that you prominently mark as "not part of the original" any modifications made to this software or documentation, and that the name of Intel Corporation not be used in advertising or publicity pertaining to distribution of the software or the documentation without specific, written prior permission.

Intel Corporation provides this AS IS, WITHOUT ANY WARRANTY, EXPRESS OR IMPLIED, INCLUDING, WITHOUT LIMITATION, ANY WARRANTY OF MERCHANTABILITY OR FITNESS FOR A PARTICULAR PURPOSE. Intel makes no guarantee or representations regarding the use of, or the results of the use of, the software and documentation in terms of correctness, accuracy, reliability, currentness, or otherwise; and you rely on the software, documentation and results solely at your own risk.

IN NO EVENT SHALL INTEL BE LIABLE FOR ANY LOSS OF USE, LOSS OF BUSINESS, LOSS OF PROFITS, INDIRECT, INCIDENTAL, SPECIAL OR CONSEQUENTIAL DAMAGES OF ANY KIND. IN NO EVENT SHALL INTEL'S TOTAL LIABILITY EXCEED THE SUM PAID TO INTEL FOR THE PRODUCT LICENSED HEREUNDER.

(26) Mike Barcroft

Copyright (c) 2001 Mike Barcroft <mike@FreeBSD.org>

All rights reserved.

Redistribution and use in source and binary forms, with or without modification, are permitted provided that the following conditions are met:

1. Redistributions of source code must retain the above copyright notice, this list of conditions and the following disclaimer.
2. Redistributions in binary form must reproduce the above copyright notice, this list of conditions and the following disclaimer in the documentation and/or other materials provided with the distribution.

THIS SOFTWARE IS PROVIDED BY THE AUTHOR AND CONTRIBUTORS "AS IS" AND ANY EXPRESS OR IMPLIED WARRANTIES, INCLUDING, BUT NOT LIMITED TO, THE IMPLIED WARRANTIES OF MERCHANTABILITY AND FITNESS FOR A PARTICULAR PURPOSE ARE DISCLAIMED. IN NO EVENT SHALL THE AUTHOR OR CONTRIBUTORS BE LIABLE FOR ANY DIRECT, INDIRECT, INCIDENTAL, SPECIAL, EXEMPLARY, OR CONSEQUENTIAL DAMAGES (INCLUDING, BUT NOT LIMITED TO, PROCUREMENT OF SUBSTITUTE GOODS OR SERVICES; LOSS OF USE, DATA, OR PROFITS; OR BUSINESS INTERRUPTION) HOWEVER CAUSED AND ON ANY THEORY OF LIABILITY, WHETHER IN CONTRACT, STRICT LIABILITY, OR TORT (INCLUDING NEGLIGENCE OR OTHERWISE) ARISING IN ANY WAY OUT OF THE USE OF THIS SOFTWARE, EVEN IF ADVISED OF THE POSSIBILITY OF SUCH DAMAGE.

(27) Konstantin Chuguev (--enable-newlib-iconv)

Copyright (c) 1999, 2000

Konstantin Chuguev. All rights reserved.

Redistribution and use in source and binary forms, with or without modification, are permitted provided that the following conditions are met:

1. Redistributions of source code must retain the above copyright notice, this list of conditions and the following disclaimer.
2. Redistributions in binary form must reproduce the above copyright notice, this list of conditions and the following disclaimer in the documentation and/or other materials provided with the distribution.

THIS SOFTWARE IS PROVIDED BY THE AUTHOR AND CONTRIBUTORS "AS IS" AND ANY EXPRESS OR IMPLIED WARRANTIES, INCLUDING, BUT NOT LIMITED TO, THE IMPLIED WARRANTIES OF MERCHANTABILITY AND FITNESS FOR A PARTICULAR PURPOSE ARE DISCLAIMED. IN NO EVENT SHALL THE AUTHOR OR CONTRIBUTORS BE LIABLE FOR ANY DIRECT, INDIRECT, INCIDENTAL, SPECIAL, EXEMPLARY, OR CONSEQUENTIAL DAMAGES (INCLUDING, BUT NOT LIMITED TO, PROCUREMENT OF SUBSTITUTE GOODS OR SERVICES; LOSS OF USE, DATA, OR PROFITS; OR BUSINESS INTERRUPTION) HOWEVER CAUSED AND ON ANY THEORY OF LIABILITY, WHETHER IN CONTRACT, STRICT LIABILITY, OR TORT (INCLUDING NEGLIGENCE OR OTHERWISE) ARISING IN ANY WAY OUT OF THE USE OF THIS SOFTWARE, EVEN IF ADVISED OF THE POSSIBILITY OF SUCH DAMAGE.

iconv (Charset Conversion Library) v2.0

(28) Artem Bityuckiy (--enable-newlib-iconv)

Copyright (c) 2003, Artem B. Bityuckiy, SoftMine Corporation. Rights transferred to Franklin Electronic Publishers.

Redistribution and use in source and binary forms, with or without modification, are permitted provided that the following conditions are met:

1. Redistributions of source code must retain the above copyright notice, this list of conditions and the following disclaimer.
2. Redistributions in binary form must reproduce the above copyright notice, this list of conditions and the following disclaimer in the documentation and/or other materials provided with the distribution.

THIS SOFTWARE IS PROVIDED BY THE AUTHOR AND CONTRIBUTORS "AS IS" AND ANY EXPRESS OR IMPLIED WARRANTIES, INCLUDING, BUT NOT LIMITED TO, THE IMPLIED WARRANTIES OF MERCHANTABILITY AND FITNESS FOR A PARTICULAR PURPOSE ARE DISCLAIMED. IN NO EVENT SHALL THE AUTHOR OR CONTRIBUTORS BE LIABLE FOR ANY DIRECT, INDIRECT, INCIDENTAL, SPECIAL, EXEMPLARY, OR CONSEQUENTIAL DAMAGES (INCLUDING, BUT NOT LIMITED TO, PROCUREMENT OF SUBSTITUTE GOODS OR SERVICES;

LOSS OF USE, DATA, OR PROFITS; OR BUSINESS INTERRUPTION) HOWEVER CAUSED AND ON ANY THEORY OF LIABILITY, WHETHER IN CONTRACT, STRICT LIABILITY, OR TORT (INCLUDING NEGLIGENCE OR OTHERWISE) ARISING IN ANY WAY OUT OF THE USE OF THIS SOFTWARE, EVEN IF ADVISED OF THE POSSIBILITY OF SUCH DAMAGE.

(30) - Alex Tatmanjants (targets using libc/posix)

Copyright (c) 1995 Alex Tatmanjants <alex@elvisti.kiev.ua>

at Electronni Visti IA, Kiev, Ukraine.

All rights reserved.

Redistribution and use in source and binary forms, with or without modification, are permitted provided that the following conditions are met:

1. Redistributions of source code must retain the above copyright notice, this list of conditions and the following disclaimer.
2. Redistributions in binary form must reproduce the above copyright notice, this list of conditions and the following disclaimer in the documentation and/or other materials provided with the distribution.

THIS SOFTWARE IS PROVIDED BY THE AUTHOR "AS IS" AND ANY EXPRESS OR IMPLIED WARRANTIES, INCLUDING, BUT NOT LIMITED TO, THE IMPLIED WARRANTIES OF MERCHANTABILITY AND FITNESS FOR A PARTICULAR PURPOSE ARE DISCLAIMED. IN NO EVENT SHALL THE AUTHOR BE LIABLE FOR ANY DIRECT, INDIRECT, INCIDENTAL, SPECIAL, EXEMPLARY, OR CONSEQUENTIAL DAMAGES (INCLUDING, BUT NOT LIMITED TO, PROCUREMENT OF SUBSTITUTE GOODS OR SERVICES; LOSS OF USE, DATA, OR PROFITS; OR BUSINESS INTERRUPTION) HOWEVER CAUSED AND ON ANY THEORY OF LIABILITY, WHETHER IN CONTRACT, STRICT LIABILITY, OR TORT (INCLUDING NEGLIGENCE OR OTHERWISE) ARISING IN ANY WAY OUT OF THE USE OF THIS SOFTWARE, EVEN IF ADVISED OF THE POSSIBILITY OF SUCH DAMAGE.

(31) - M. Warner Losh (targets using libc/posix)

Copyright (c) 1998, M. Warner Losh <imp@freebsd.org>

All rights reserved.

Redistribution and use in source and binary forms, with or without modification, are permitted provided that the following conditions are met:

1. Redistributions of source code must retain the above copyright notice, this list of conditions and the following disclaimer.
2. Redistributions in binary form must reproduce the above copyright notice, this list of conditions and the following disclaimer in the documentation and/or other materials provided with the distribution.

THIS SOFTWARE IS PROVIDED BY THE AUTHOR AND CONTRIBUTORS "AS IS" AND ANY EXPRESS OR IMPLIED WARRANTIES, INCLUDING, BUT NOT LIMITED TO, THE IMPLIED WARRANTIES OF MERCHANTABILITY AND FITNESS FOR A PARTICULAR PURPOSE ARE DISCLAIMED. IN NO EVENT SHALL THE AUTHOR OR CONTRIBUTORS BE LIABLE FOR ANY DIRECT, INDIRECT, INCIDENTAL, SPECIAL, EXEMPLARY, OR CONSEQUENTIAL DAMAGES (INCLUDING, BUT NOT LIMITED TO, PROCUREMENT OF SUBSTITUTE GOODS OR SERVICES; LOSS OF USE, DATA, OR PROFITS; OR BUSINESS INTERRUPTION) HOWEVER CAUSED AND ON ANY THEORY OF LIABILITY, WHETHER IN CONTRACT, STRICT LIABILITY, OR TORT (INCLUDING NEGLIGENCE OR OTHERWISE) ARISING IN ANY WAY OUT OF THE USE OF THIS SOFTWARE, EVEN IF ADVISED OF THE POSSIBILITY OF SUCH DAMAGE.

(32) - Andrey A. Chernov (targets using libc/posix)

Copyright (C) 1996 by Andrey A. Chernov, Moscow, Russia.

All rights reserved.

Redistribution and use in source and binary forms, with or without modification, are permitted provided that the following conditions are met:

1. Redistributions of source code must retain the above copyright notice, this list of conditions and the following disclaimer.
2. Redistributions in binary form must reproduce the above copyright notice, this list of conditions and the following disclaimer in the documentation and/or other materials provided with the distribution.

THIS SOFTWARE IS PROVIDED BY THE AUTHOR "AS IS" AND ANY EXPRESS OR IMPLIED WARRANTIES, INCLUDING, BUT NOT LIMITED TO, THE IMPLIED WARRANTIES OF MERCHANTABILITY AND FITNESS FOR A PARTICULAR PURPOSE ARE DISCLAIMED. IN NO EVENT SHALL THE REGENTS OR CONTRIBUTORS BE LIABLE FOR ANY DIRECT, INDIRECT, INCIDENTAL, SPECIAL, EXEMPLARY, OR CONSEQUENTIAL DAMAGES (INCLUDING, BUT NOT LIMITED TO, PROCUREMENT OF SUBSTITUTE GOODS OR SERVICES; LOSS OF USE, DATA, OR PROFITS; OR BUSINESS INTERRUPTION) HOWEVER CAUSED AND ON ANY THEORY OF LIABILITY, WHETHER IN CONTRACT, STRICT LIABILITY, OR TORT (INCLUDING NEGLIGENCE OR OTHERWISE) ARISING IN ANY WAY OUT OF THE USE OF THIS SOFTWARE, EVEN IF ADVISED OF THE POSSIBILITY OF SUCH DAMAGE.

(33) - Daniel Eischen (targets using libc/posix)

Copyright (c) 2001 Daniel Eischen <deischen@FreeBSD.org>.

All rights reserved.

Redistribution and use in source and binary forms, with or without modification, are permitted provided that the following conditions are met:

1. Redistributions of source code must retain the above copyright notice, this list of conditions and the following disclaimer.

2. Redistributions in binary form must reproduce the above copyright notice, this list of conditions and the following disclaimer in the documentation and/or other materials provided with the distribution.

THIS SOFTWARE IS PROVIDED BY THE AUTHOR AND CONTRIBUTORS "AS IS" AND ANY EXPRESS OR IMPLIED WARRANTIES, INCLUDING, BUT NOT LIMITED TO, THE IMPLIED WARRANTIES OF MERCHANTABILITY AND FITNESS FOR A PARTICULAR PURPOSE ARE DISCLAIMED. IN NO EVENT SHALL THE REGENTS OR CONTRIBUTORS BE LIABLE FOR ANY DIRECT, INDIRECT, INCIDENTAL, SPECIAL, EXEMPLARY, OR CONSEQUENTIAL DAMAGES (INCLUDING, BUT NOT LIMITED TO, PROCUREMENT OF SUBSTITUTE GOODS OR SERVICES; LOSS OF USE, DATA, OR PROFITS; OR BUSINESS INTERRUPTION) HOWEVER CAUSED AND ON ANY THEORY OF LIABILITY, WHETHER IN CONTRACT, STRICT LIABILITY, OR TORT (INCLUDING NEGLIGENCE OR OTHERWISE) ARISING IN ANY WAY OUT OF THE USE OF THIS SOFTWARE, EVEN IF ADVISED OF THE POSSIBILITY OF SUCH DAMAGE.

(35) - ARM Ltd (arm and thumb variant targets only)

Copyright (c) 2009 ARM Ltd

All rights reserved.

Redistribution and use in source and binary forms, with or without modification, are permitted provided that the following conditions are met:

1. Redistributions of source code must retain the above copyright notice, this list of conditions and the following disclaimer.

2. Redistributions in binary form must reproduce the above copyright notice, this list of conditions and the following disclaimer in the documentation and/or other materials provided with the distribution.

3. The name of the company may not be used to endorse or promote products derived from this software without specific prior written permission.

THIS SOFTWARE IS PROVIDED BY ARM LTD "AS IS" AND ANY EXPRESS OR IMPLIED WARRANTIES, INCLUDING, BUT NOT LIMITED TO, THE IMPLIED WARRANTIES OF MERCHANTABILITY AND FITNESS FOR A PARTICULAR PURPOSE ARE DISCLAIMED. IN NO EVENT SHALL ARM LTD BE LIABLE FOR ANY DIRECT, INDIRECT, INCIDENTAL, SPECIAL, EXEMPLARY, OR CONSEQUENTIAL DAMAGES (INCLUDING, BUT NOT LIMITED TO, PROCUREMENT OF SUBSTITUTE GOODS OR SERVICES; LOSS OF USE, DATA, OR PROFITS; OR BUSINESS INTERRUPTION) HOWEVER CAUSED AND ON ANY THEORY OF LIABILITY, WHETHER IN CONTRACT, STRICT LIABILITY, OR TORT (INCLUDING NEGLIGENCE OR OTHERWISE) ARISING IN ANY WAY OUT OF THE USE OF THIS SOFTWARE, EVEN IF ADVISED OF THE POSSIBILITY OF SUCH DAMAGE.

(36) - CodeSourcery, Inc.

Copyright (c) 2009 CodeSourcery, Inc.

All rights reserved.

Redistribution and use in source and binary forms, with or without modification, are permitted provided that the following conditions are met:

- \* Redistributions of source code must retain the above copyright notice, this list of conditions and the following disclaimer.
- \* Redistributions in binary form must reproduce the above copyright notice, this list of conditions and the following disclaimer in the documentation and/or other materials provided with the distribution.
- \* Neither the name of CodeSourcery nor the names of its contributors may be used to endorse or promote products derived from this software without specific prior written permission.

THIS SOFTWARE IS PROVIDED BY CODESOURCERY, INC. "AS IS" AND ANY EXPRESS OR IMPLIED WARRANTIES, INCLUDING, BUT NOT LIMITED TO, THE IMPLIED WARRANTIES OF MERCHANTABILITY AND FITNESS FOR A PARTICULAR PURPOSE ARE DISCLAIMED. IN NO EVENT SHALL CODESOURCERY BE LIABLE FOR ANY DIRECT, INDIRECT, INCIDENTAL, SPECIAL, EXEMPLARY, OR CONSEQUENTIAL DAMAGES (INCLUDING, BUT NOT LIMITED TO, PROCUREMENT OF SUBSTITUTE GOODS OR SERVICES; LOSS OF USE, DATA, OR PROFITS; OR BUSINESS INTERRUPTION) HOWEVER CAUSED AND ON ANY THEORY OF LIABILITY, WHETHER IN CONTRACT, STRICT LIABILITY, OR TORT (INCLUDING NEGLIGENCE OR OTHERWISE) ARISING IN ANY WAY OUT OF THE USE OF THIS SOFTWARE, EVEN IF ADVISED OF THE POSSIBILITY OF SUCH DAMAGE.

(37) MIPS Technologies, Inc

/\*

\* Copyright (c) 2009 MIPS Technologies, Inc.

\* All rights reserved.

\* Redistribution and use in source and binary forms, with or without modification, are permitted provided that the following conditions are met:

\* \* Redistributions of source code must retain the above copyright notice, this list of conditions and the following disclaimer.

\* \* Redistributions in binary form must reproduce the above copyright notice, this list of conditions and the following disclaimer in the documentation and/or other materials provided with the distribution.

\* \* Neither the name of MIPS Technologies Inc. nor the names of its contributors may be used to endorse or promote products derived from this software without specific prior written permission.

\* THIS SOFTWARE IS PROVIDED BY THE COPYRIGHT HOLDERS AND CONTRIBUTORS "AS IS" AND ANY EXPRESS OR IMPLIED WARRANTIES, INCLUDING, BUT NOT LIMITED TO, THE IMPLIED



WARRANTIES OF MERCHANTABILITY AND FITNESS FOR A PARTICULAR PURPOSE ARE DISCLAIMED. IN NO EVENT SHALL THE COPYRIGHT OWNER OR CONTRIBUTORS BE LIABLE FOR ANY DIRECT, INDIRECT, INCIDENTAL, SPECIAL, EXEMPLARY, OR CONSEQUENTIAL DAMAGES (INCLUDING, BUT NOT LIMITED TO, PROCUREMENT OF SUBSTITUTE GOODS OR SERVICES; LOSS OF USE, DATA, OR PROFITS; OR BUSINESS INTERRUPTION) HOWEVER CAUSED AND ON ANY THEORY OF LIABILITY, WHETHER IN CONTRACT, STRICT LIABILITY, OR TORT (INCLUDING NEGLIGENCE OR OTHERWISE) ARISING IN ANY WAY OUT OF THE USE OF THIS SOFTWARE, EVEN IF ADVISED OF THE POSSIBILITY OF SUCH DAMAGE.

\*/

### **MIT License**

This projector product includes the open source software program which applies the terms and conditions provided by owner of the copyright to the "MIT License".

The "MIT License" are WITHOUT ANY WARRANTY; without even the implied warranty of MERCHANTABILITY AND FITNESS FOR A PARTICULAR PURPOSE.

List of MIT License programs

- jquery-1.7.2.min.js
- jquery-ui-1.8.20.custom.zip
- jquery.ui.touch-punch.js
- jquery.upload-1.0.2.min.js

License terms of conditions of each program which are provided by owner of the copyright to the "MIT License" are as follows.

Copyright (c) 2012 jQuery Foundation and other contributors,

<http://jquery.com/>

Permission is hereby granted, free of charge, to any person obtaining a copy of this software and associated documentation files (the "Software"), to deal in the Software without restriction, including without limitation the rights to use, copy, modify, merge, publish, distribute, sublicense, and/or sell copies of the Software, and to permit persons to whom the Software is furnished to do so, subject to the following conditions:

The above copyright notice and this permission notice shall be included in all copies or substantial portions of the Software.

THE SOFTWARE IS PROVIDED "AS IS", WITHOUT WARRANTY OF ANY KIND, EXPRESS OR IMPLIED, INCLUDING BUT NOT LIMITED TO THE WARRANTIES OF MERCHANTABILITY, FITNESS FOR A PARTICULAR PURPOSE AND NONINFRINGEMENT. IN NO EVENT SHALL THE AUTHORS

OR COPYRIGHT HOLDERS BE LIABLE FOR ANY CLAIM, DAMAGES OR OTHER LIABILITY, WHETHER IN AN ACTION OF CONTRACT, TORT OR OTHERWISE, ARISING FROM, OUT OF OR IN CONNECTION WITH THE SOFTWARE OR THE USE OR OTHER DEALINGS IN THE SOFTWARE.

## **TOPPERS/JSP**

This projector product includes the open source software program "TOPPERS/JSP" which applies the terms and conditions provided by owner of the copyright to the "TOPPERS/JSP".

The "TOPPERS/JSP" are WITHOUT ANY WARRANTY; without even the implied warranty of MERCHANTABILITY AND FITNESS FOR A PARTICULAR PURPOSE.

List of TOPPERS/JSP programs

- jsp-1.4.3
- toppers-pro

License terms of conditions of each program which are provided by owner of the copyright to the "TOPPERS/JSP" are as follows.

TOPPERS/JSP Kernel

Toyohashi Open Platform for Embedded Real-Time Systems/Just Standard Profile Kernel

Copyright (C) 2000-2003 by Embedded and Real-Time Systems Laboratory Toyohashi Univ. of Technology, JAPAN

Copyright (C) 2004 by Embedded and Real-Time Systems Laboratory Graduate School of Information Science, Nagoya Univ., JAPAN.

The above copyright holder, limited to cases in which one satisfies conditions (1) ~ (4) below, or the conditions described in Version 2 of the GNU Public License officially announced by the Free Software Foundation, consents to the use, reproduction, alteration, and redistribution (hereafter called utilization) of this software (this software includes alterations, likewise below) without compensation.

(1) When this software is utilized in the form of source code, the above copyright declaration, these conditions of utilization, and the following stipulation of no guarantee shall be included in unchanged form inside the source code.

(2) When this software is redistributed in a form in which it can be used in the development of other software, library form, etc., the above copyright display, these terms of utilization, and the following stipulation of no guarantee shall be inserted in documentation accompanying redistribution (user's manual, etc.).

(3) When this software is redistributed in a form in which it cannot be used in the development of other software, embedded in devices, etc., one of the following conditions shall be satisfied.

- (a) The above copyright display, these terms of utilization, and the following stipulation of no guarantee shall be inserted in documentation accompanying redistribution (user's manual, etc.).
- (b) The TOPPERS Project shall be notified owing to a method in which the form of distribution is decided otherwise.
- (4) The above copyright holder and the TOPPERS Project shall be exempt from responsibility for whatever damages occur either directly or indirectly through the utilization of this software.

This software is something that is provided with no guarantee. The above copyright holder and the TOPPERS Project make no guarantee whatsoever in regard to this software, including the possibility of its application. In addition, the above copyright holder and the TOPPERS Project shall also not bear responsibility for whatever damages occur either directly or indirectly through the utilization of this software.

Note: The TOPPERS License has been revised several times; what is shown above is the latest version that is to be applied to software made public hereafter.

## **TINET**

This projector product includes the open source software program "TINET" which applies the terms and conditions provided by owner of the copyright to the "TINET".

The "TINET" are WITHOUT ANY WARRANTY; without even the implied warranty of MERCHANTABILITY AND FITNESS FOR A PARTICULAR PURPOSE.

List of TINET programs

- tinet-1.4.4

License terms of conditions of each program which are provided by owner of the copyright to the "TINET" are as follows.

(1) FreeBSD

Copyright (c) 1980, 1986, 1993

The Regents of the University of California. All rights reserved.

Redistribution and use in source and binary forms, with or without modification, are permitted provided that the following conditions are met:

1. Redistributions of source code must retain the above copyright notice, this list of conditions and the following disclaimer.
2. Redistributions in binary form must reproduce the above copyright notice, this list of conditions and the following disclaimer in the documentation and/or other materials provided with the distribution.

3. All advertising materials mentioning features or use of this software must display the following acknowledgement:

This product includes software developed by the University of California, Berkeley and its contributors.

4. Neither the name of the University nor the names of its contributors may be used to endorse or promote products derived from this software without specific prior written permission.

THIS SOFTWARE IS PROVIDED BY THE REGENTS AND CONTRIBUTORS "AS IS" AND ANY EXPRESS OR IMPLIED WARRANTIES, INCLUDING, BUT NOT LIMITED TO, THE IMPLIED WARRANTIES OF MERCHANTABILITY AND FITNESS FOR A PARTICULAR PURPOSE ARE DISCLAIMED. IN NO EVENT SHALL THE REGENTS OR CONTRIBUTORS BE LIABLE FOR ANY DIRECT, INDIRECT, INCIDENTAL, SPECIAL, EXEMPLARY, OR CONSEQUENTIAL DAMAGES (INCLUDING, BUT NOT LIMITED TO, PROCUREMENT OF SUBSTITUTE GOODS OR SERVICES; LOSS OF USE, DATA, OR PROFITS; OR BUSINESS INTERRUPTION) HOWEVER CAUSED AND ON ANY THEORY OF LIABILITY, WHETHER IN CONTRACT, STRICT LIABILITY, OR TORT (INCLUDING NEGLIGENCE OR OTHERWISE) ARISING IN ANY WAY OUT OF THE USE OF THIS SOFTWARE, EVEN IF ADVISED OF THE POSSIBILITY OF SUCH DAMAGE.

(6) TINET and TOPPERS

TINET (TCP/IP Protocol Stack)

Copyright (C) 2001-2006 by Dep. of Computer Science and Engineering Tomakomai National College of Technology, JAPAN

The above copyright holder, limited to cases in which one satisfies conditions (1) ~ (4) below, or the conditions described in Version 2 of the GNU Public License officially announced by the Free Software Foundation, consents to the use, reproduction, alteration, and redistribution (hereafter called utilization) of this software (this software includes alterations, likewise below) without compensation.

(1) When this software is utilized in the form of source code, the above copyright declaration, these conditions of utilization, and the following stipulation of no guarantee shall be included in unchanged form inside the source code.

(2) When this software is redistributed in a form in which it can be used in the development of other software, library form, etc., the above copyright display, these terms of utilization, and the following stipulation of no guarantee shall be inserted in documentation accompanying redistribution (user's manual, etc.).

(3) When this software is redistributed in a form in which it cannot be used in the development of other software, embedded in devices, etc., following conditions shall be satisfied.

(a) The above copyright display, these terms of utilization, and the following stipulation of no guarantee shall be inserted in documentation accompanying redistribution (user's manual, etc.).

(4) The above copyright holder and the TOPPERS Project shall be exempt from responsibility for whatever damages occur either directly or indirectly through the utilization of this software.

This software is something that is provided with no guarantee. The above copyright holder and the TOPPERS Project make no guarantee whatsoever in regard to this software, including the possibility of its application. In addition, the above copyright holder and the TOPPERS Project shall also not bear responsibility for whatever damages occur either directly or indirectly through the utilization of this software.

### **openssl**

This projector product includes the open source software program "openssl" which applies the terms and conditions provided by owner of the copyright to the "openssl".

The "openssl" are WITHOUT ANY WARRANTY; without even the implied warranty of MERCHANTABILITY AND FITNESS FOR A PARTICULAR PURPOSE.

List of openssl programs

- openssl-1.0.0d

License terms of conditions of each program which are provided by owner of the copyright to the "openssl" are as follows.

### LICENSE ISSUES

=====

The OpenSSL toolkit stays under a dual license, i.e. both the conditions of the OpenSSL License and the original SSLeay license apply to the toolkit. See below for the actual license texts. Actually both licenses are BSD-style Open Source licenses. In case of any license issues related to OpenSSL please contact [openssl-core@openssl.org](mailto:openssl-core@openssl.org).

### OpenSSL License

-----

/\* =====

- \* Copyright (c) 1998-2011 The OpenSSL Project. All rights reserved.
- \* Redistribution and use in source and binary forms, with or without modification, are permitted provided that the following conditions are met:
  - \* 1. Redistributions of source code must retain the above copyright notice, this list of conditions and the following disclaimer.
  - \* 2. Redistributions in binary form must reproduce the above copyright notice, this list of conditions and the following disclaimer in the documentation and/or other materials provided with the distribution.

\* 3. All advertising materials mentioning features or use of this software must display the following acknowledgment:

\* "This product includes software developed by the OpenSSL Project for use in the OpenSSL Toolkit. (<http://www.openssl.org/>)"

\* 4. The names "OpenSSL Toolkit" and "OpenSSL Project" must not be used to endorse or promote products derived from this software without prior written permission. For written permission, please contact [openssl-core@openssl.org](mailto:openssl-core@openssl.org).

\* 5. Products derived from this software may not be called "OpenSSL" nor may "OpenSSL" appear in their names without prior written permission of the OpenSSL Project.

\* 6. Redistributions of any form whatsoever must retain the following acknowledgment:

\* "This product includes software developed by the OpenSSL Project for use in the OpenSSL Toolkit (<http://www.openssl.org/>)"

\* THIS SOFTWARE IS PROVIDED BY THE OpenSSL PROJECT "AS IS" AND ANY EXPRESSED OR IMPLIED WARRANTIES, INCLUDING, BUT NOT LIMITED TO, THE IMPLIED WARRANTIES OF MERCHANTABILITY AND FITNESS FOR A PARTICULAR PURPOSE ARE DISCLAIMED. IN NO EVENT SHALL THE OpenSSL PROJECT OR ITS CONTRIBUTORS BE LIABLE FOR ANY DIRECT, INDIRECT, INCIDENTAL, SPECIAL, EXEMPLARY, OR CONSEQUENTIAL DAMAGES (INCLUDING, BUT NOT LIMITED TO, PROCUREMENT OF SUBSTITUTE GOODS OR SERVICES; LOSS OF USE, DATA, OR PROFITS; OR BUSINESS INTERRUPTION) HOWEVER CAUSED AND ON ANY THEORY OF LIABILITY, WHETHER IN CONTRACT, STRICT LIABILITY, OR TORT (INCLUDING NEGLIGENCE OR OTHERWISE) ARISING IN ANY WAY OUT OF THE USE OF THIS SOFTWARE, EVEN IF ADVISED OF THE POSSIBILITY OF SUCH DAMAGE.

\* =====

\* This product includes cryptographic software written by Eric Young ([ey@cryptsoft.com](mailto:ey@cryptsoft.com)). This product includes software written by Tim Hudson ([tjh@cryptsoft.com](mailto:tjh@cryptsoft.com)).

\*/

Original SSLeay License

-----

/\* Copyright (C) 1995-1998 Eric Young ([ey@cryptsoft.com](mailto:ey@cryptsoft.com))

\* All rights reserved.

\* This package is an SSL implementation written by Eric Young ([ey@cryptsoft.com](mailto:ey@cryptsoft.com)).

\* The implementation was written so as to conform with Netscapes SSL.

- \* This library is free for commercial and non-commercial use as long as the following conditions are adhered to. The following conditions apply to all code found in this distribution, be it the RC4, RSA, lhash, DES, etc., code; not just the SSL code. The SSL documentation included with this distribution is covered by the same copyright terms except that the holder is Tim Hudson (tjh@cryptsoft.com).
- \* Copyright remains Eric Young's, and as such any Copyright notices in the code are not to be removed.
- \* If this package is used in a product, Eric Young should be given attribution as the author of the parts of the library used.
- \* This can be in the form of a textual message at program startup or in documentation (online or textual) provided with the package.
- \* Redistribution and use in source and binary forms, with or without modification, are permitted provided that the following conditions are met:
  - \* 1. Redistributions of source code must retain the copyright notice, this list of conditions and the following disclaimer.
  - \* 2. Redistributions in binary form must reproduce the above copyright notice, this list of conditions and the following disclaimer in the documentation and/or other materials provided with the distribution.
  - \* 3. All advertising materials mentioning features or use of this software must display the following acknowledgement:
    - \* "This product includes cryptographic software written by Eric Young (eay@cryptsoft.com)"
    - \* The word 'cryptographic' can be left out if the routines from the library being used are not cryptographic related :-).
  - \* 4. If you include any Windows specific code (or a derivative thereof) from the apps directory (application code) you must include an acknowledgement:
    - \* "This product includes software written by Tim Hudson (tjh@cryptsoft.com)"
- \* THIS SOFTWARE IS PROVIDED BY ERIC YOUNG "AS IS" AND ANY EXPRESS OR IMPLIED WARRANTIES, INCLUDING, BUT NOT LIMITED TO, THE IMPLIED WARRANTIES OF MERCHANTABILITY AND FITNESS FOR A PARTICULAR PURPOSE ARE DISCLAIMED. IN NO EVENT SHALL THE AUTHOR OR CONTRIBUTORS BE LIABLE FOR ANY DIRECT, INDIRECT, INCIDENTAL, SPECIAL, EXEMPLARY, OR CONSEQUENTIAL DAMAGES (INCLUDING, BUT NOT LIMITED TO, PROCUREMENT OF SUBSTITUTE GOODS OR SERVICES; LOSS OF USE, DATA, OR PROFITS; OR BUSINESS INTERRUPTION) HOWEVER CAUSED AND ON ANY THEORY OF LIABILITY, WHETHER IN CONTRACT, STRICT LIABILITY, OR TORT (INCLUDING NEGLIGENCE OR OTHERWISE) ARISING IN ANY WAY OUT OF THE USE OF THIS SOFTWARE, EVEN IF ADVISED OF THE POSSIBILITY OF SUCH DAMAGE.

\* The licence and distribution terms for any publically available version or derivative of this code cannot be changed. i.e. this code cannot simply be copied and put under another distribution licence [including the GNU Public Licence.]

\*/

**Parent topic:** [Notices](#)

## Copyright Notice

All rights reserved. No part of this publication may be reproduced, stored in a retrieval system, or transmitted in any form or by any means, electronic, mechanical, photocopying, recording, or otherwise, without the prior written permission of Seiko Epson Corporation. The information contained herein is designed only for use with this Epson product. Epson is not responsible for any use of this information as applied to other products.

Neither Seiko Epson Corporation nor its affiliates shall be liable to the purchaser of this product or third parties for damages, losses, costs, or expenses incurred by purchaser or third parties as a result of: accident, misuse, or abuse of this product or unauthorized modifications, repairs, or alterations to this product, or (excluding the U.S.) failure to strictly comply with Seiko Epson Corporation's operating and maintenance instructions.

Seiko Epson Corporation shall not be liable for any damages or problems arising from the use of any options or any consumable products other than those designated as Original Epson Products or Epson Approved Products by Seiko Epson Corporation.

This information is subject to change without notice.

[A Note Concerning Responsible Use of Copyrighted Materials](#)

[Copyright Attribution](#)

**Parent topic:** [Notices](#)

## A Note Concerning Responsible Use of Copyrighted Materials

Epson encourages each user to be responsible and respectful of the copyright laws when using any Epson product. While some countries' laws permit limited copying or reuse of copyrighted material in certain circumstances, those circumstances may not be as broad as some people assume. Contact your legal advisor for any questions regarding copyright law.

**Parent topic:** [Copyright Notice](#)

## Copyright Attribution

© 2014 Epson America, Inc.



7/14

CPD-41046

**Parent topic:** [Copyright Notice](#)