

# PRESENTATION OF THE PARROT DISCO

## GENERAL

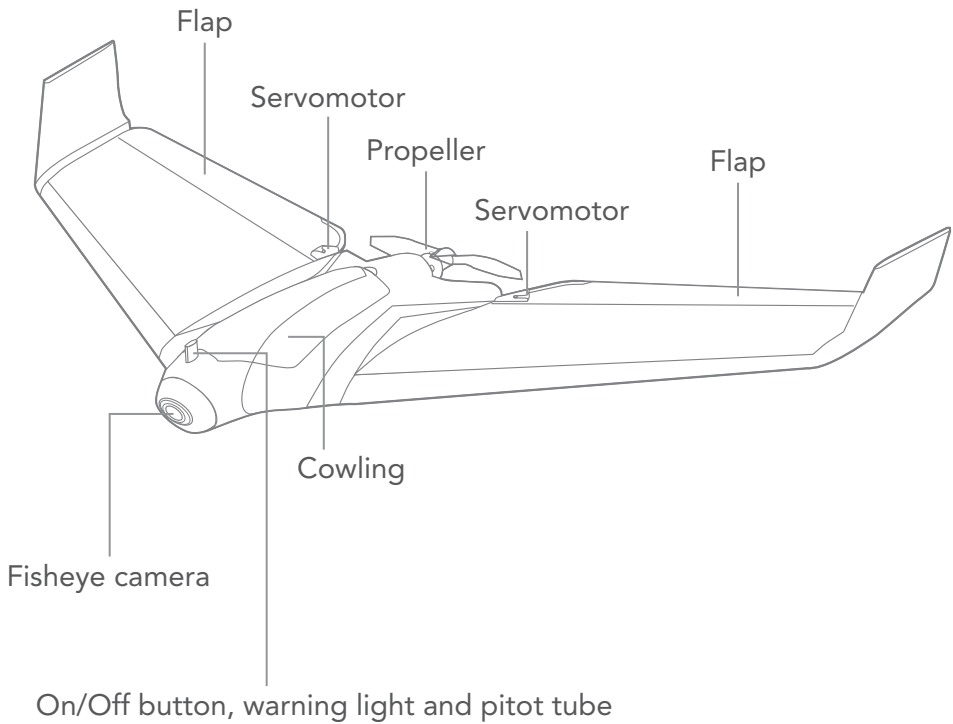

# CHUCK AUTOPILOT UNIT

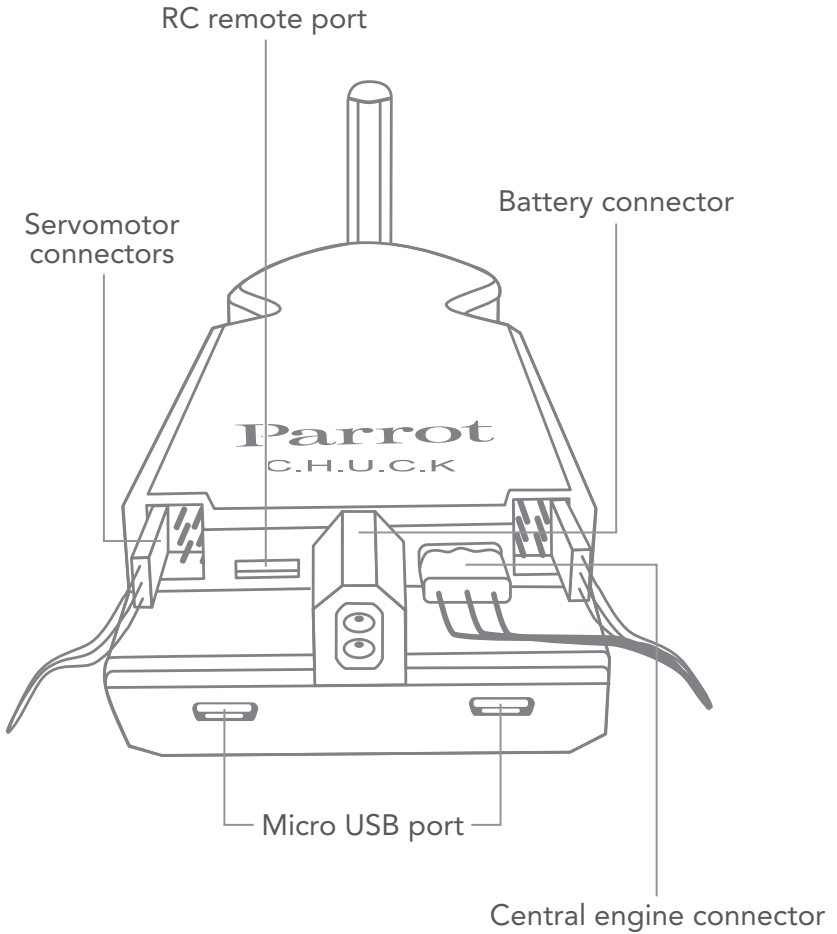

# PRESENTATION OF THE PARROT SKYCONTROLLER 2

Location of the smartphone and tablet holder

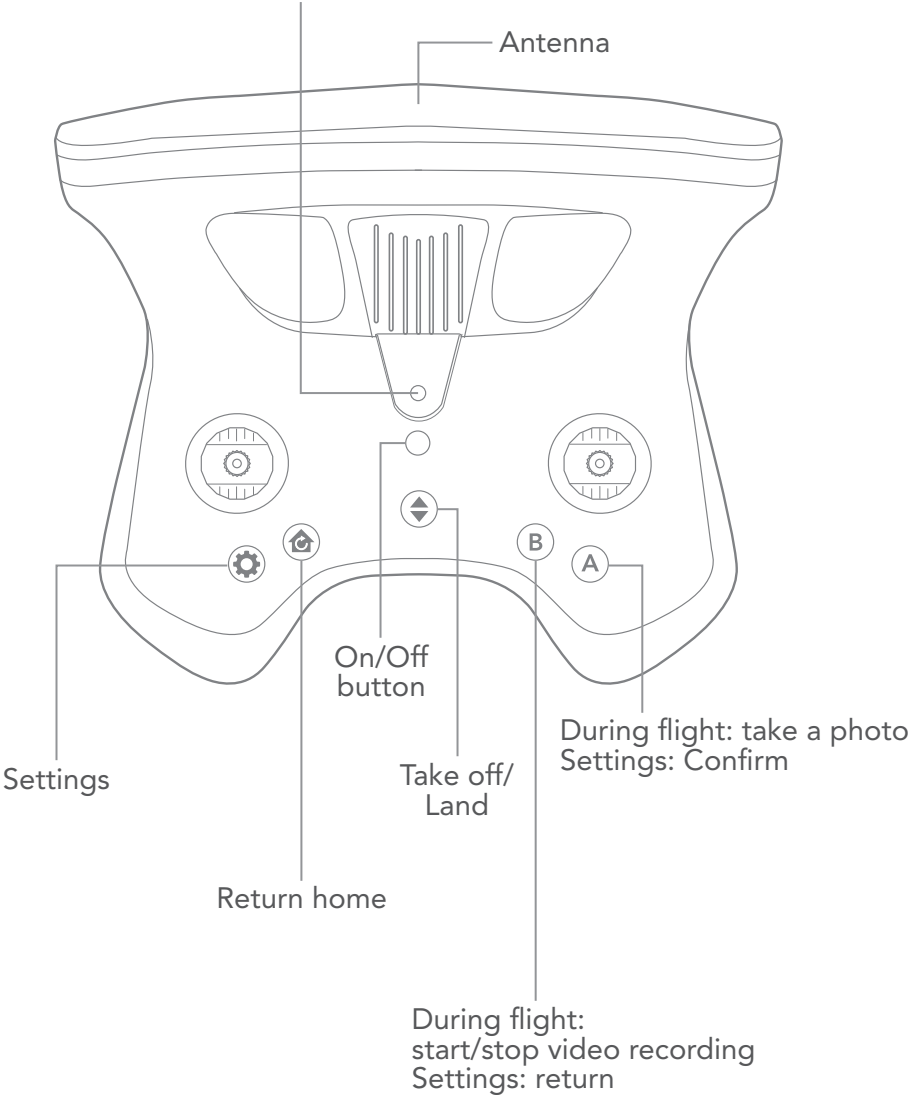

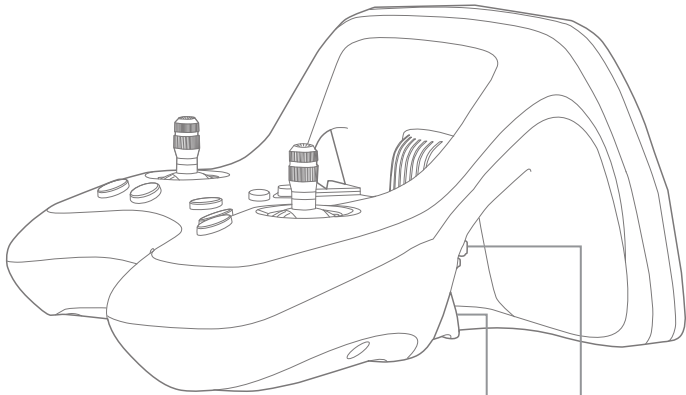

Switch to direct view or  
immersive view

Set the camera exposure

USB port

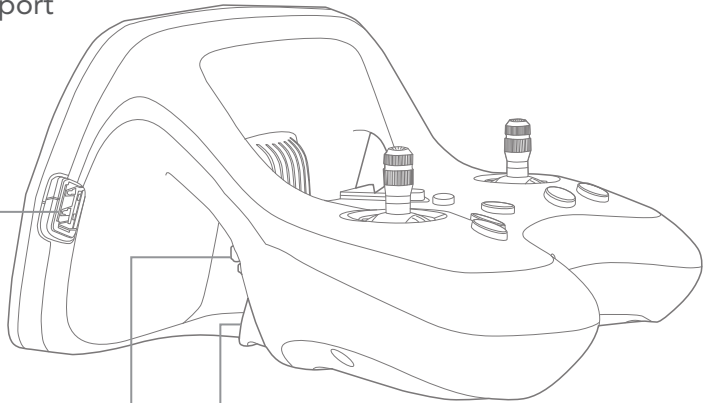

Change the display mode  
on the application

Vertical orientation of the camera

# PRESENTATION OF PARROT COCKPITGLASSES

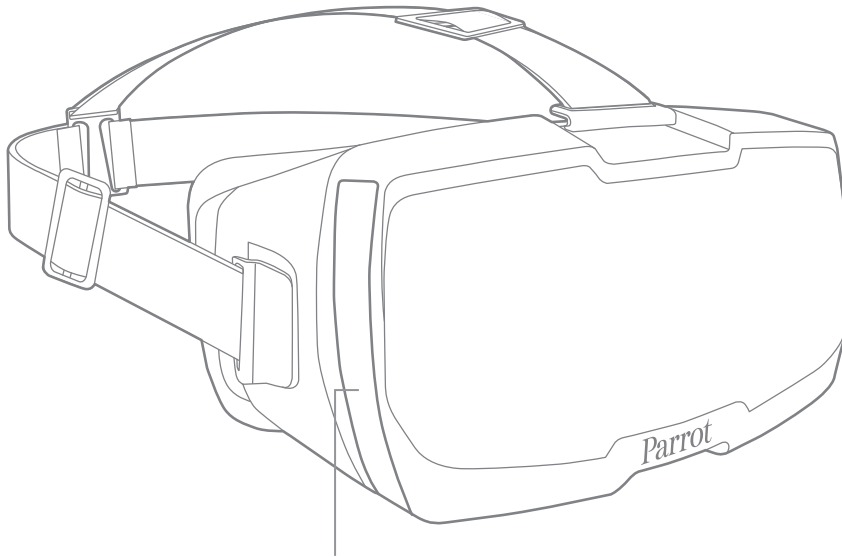

Drawer for smartphone

Parrot Cockpitglasses are compatible with the following phones:

- iPhone 6s Plus
- iPhone 6s
- iPhone 6 Plus
- iPhone 6
- Samsung Galaxy S® 7
- Samsung Galaxy S® 6
- Samsung Galaxy S® 5
- Samsung Galaxy Note® 5
- Samsung Galaxy Note® 4
- Samsung Galaxy Note® 3
- LG G4
- LG G3
- HTC One M8
- Nexus 5

**⚠** Never leave Parrot Cockpitglasses in the sun when not in use.  
This could damage your phone.

# BEFORE GETTING STARTED

## DOWNLOAD THE FREEFLIGHT PRO APPLICATION

Login to the App Store® or Google Play™ and download the free FreeFlight Pro application to your smartphone or tablet.

## CHARGING THE PARROT DISCO'S BATTERY

**⚠** The battery must be disconnected from the Parrot Disco.

- 1.** Select the plug for your country and put it on the charger.
- 2.** Connect the cable to the charger.
- 3.** Connect the battery to the charger's cable, and then plug the charger into the mains.

The warning light is red while charging and then turns green when the battery is charged.

The battery charge time is approximately 55 minutes.

The flight time is approximately 45 minutes.

## FITTING THE BATTERY

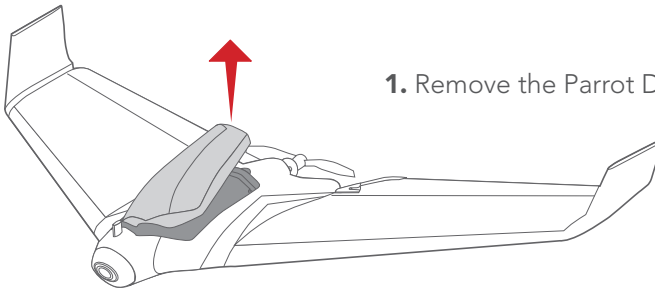

**1.** Remove the Parrot Disco's cowling.

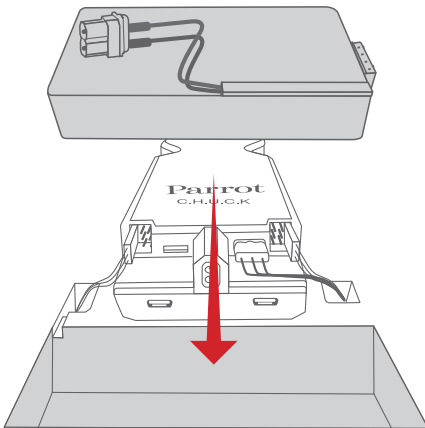

**2.** Place the battery in the slot provided for this purpose.

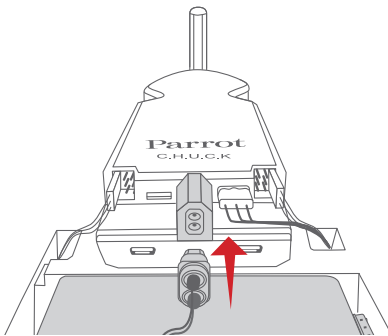

**3.** Plug the battery into the Parrot Disco.

**4.** Close the Parrot Disco's cowling.

## ATTACHING THE WINGS

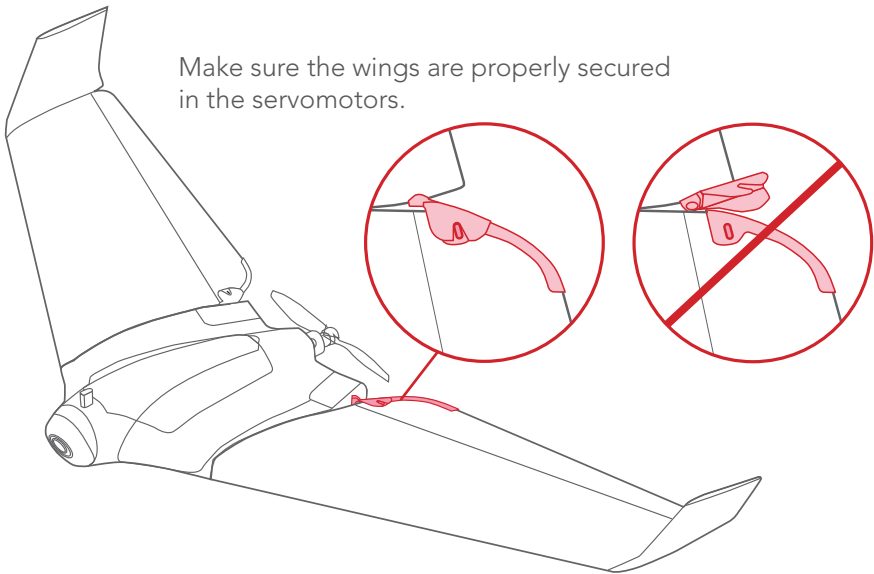
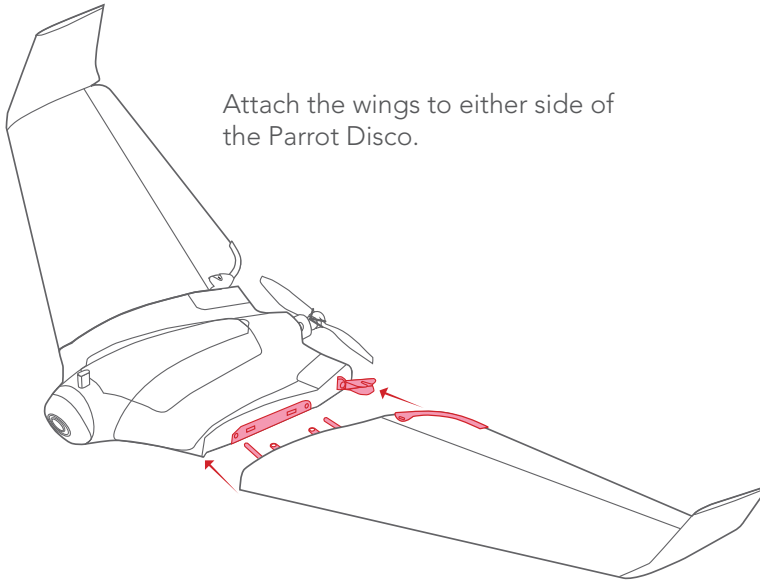

To remove the wings, pull on them.

**⚠** Do not move the servomotors with your hand to avoid damaging them.



# PRE-FLIGHT CHECKS

Before each flight with Parrot Disco, make the following checks:

## REGULATIONS

- Make sure that the use of Parrot Disco is allowed where you are going to fly.
- Check the restrictions regarding the use of Wi-Fi® frequencies in the place where you are going to fly.
- Check the regulations on the use of FPV goggles when flying a drone where you are going to fly.

## FLIGHT CONDITIONS

- Make sure you have at least 80 meters in diameter of clear space for your Parrot Disco to take off and land. Make sure the airfield has no obstacles that may hinder piloting or prevent visual flight.
- Do not fly the Parrot Disco at night.
- Do not fly the Parrot Disco over an urban area or in certain places in the public domain (for example: train stations, airports, etc.).
- Check weather conditions. Do not fly the Parrot Disco in rain, fog, snow or wind over 12 meters per second or 43 km/h.

## PARROT DISCO

- Make sure the Parrot Disco's wings are properly secured (see the Attaching the wings section).
- Make sure the Parrot Disco's battery and your remote control's battery are charged (see the Fitting the battery section).
- Make sure the Parrot Disco's cowling is properly closed.
- Make sure the Parrot Disco's warning light is green. This means the Parrot Disco has acquired the GPS signal.

# PILOTING CONFIGURATIONS

There are three piloting configurations.  
Familiarise yourself with no. 1 and no. 2 before using no. 3.

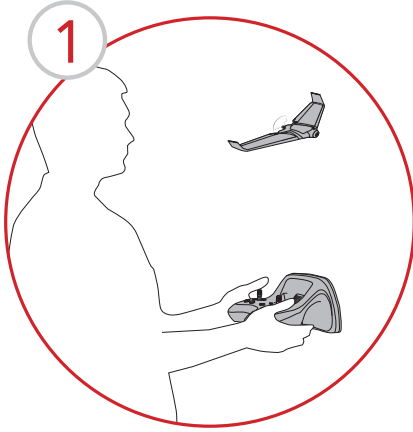

Parrot Skycontroller 2  
alone

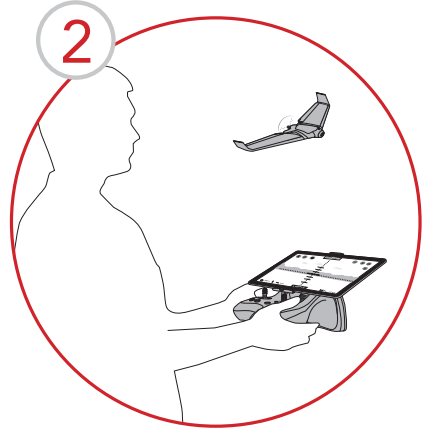

Parrot Skycontroller 2  
and smartphone

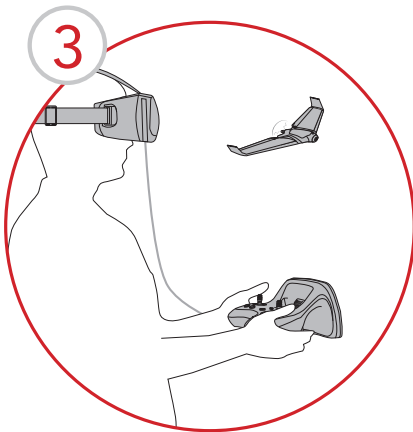

Parrot Skycontroller 2 and  
Parrot Cockpitglasses

# CONNECTING TO THE PARROT DISCO

## CONNECTING THE PARROT SKYCONTROLLER 2 TO THE PARROT DISCO

1. Place the Parrot Disco on a flat surface.
2. Press the Parrot Disco's On/Off button.  
> The button flashes red and green once the GPS is connected.
3. Press the Parrot Skycontroller 2's On/Off button to turn it on.
4. Wait until the warning light is a steady green.  
**You are connected to the Parrot Disco.**

If the warning light continues to flash red, you need to calibrate the Parrot Disco. To do this:

1. In the FreeFlight Pro application, go to **Fly and film** >  > **Position** and press **Calibrate**.

2. Rotate the Parrot Disco on the Z-axis (yaw).

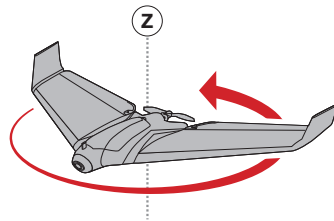

3. Rotate the Parrot Disco on the Y-axis (pitch).

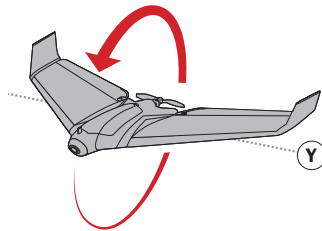

4. Rotate the Parrot Disco on the X-axis (roll).

> The warning light flashes green. The Parrot Disco is calibrated.

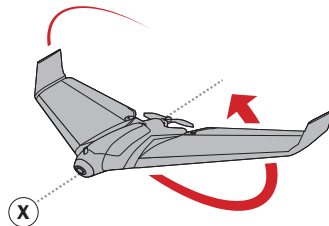

## CONNECTING YOUR PARROT SKYCONTROLLER 2 TO YOUR SMARTPHONE

1. Screw the smartphone holder onto the Parrot Skycontroller 2.

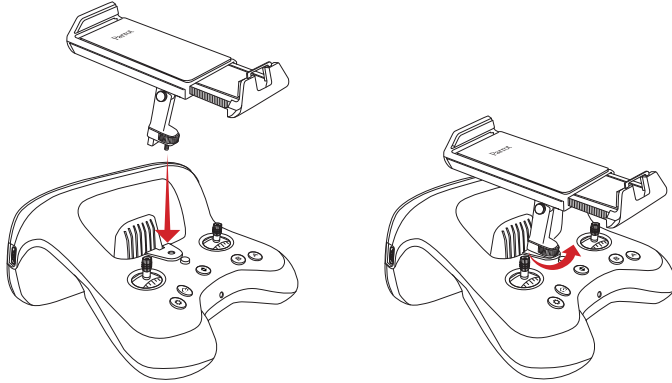

-  You can rotate the holder to fit your smartphone's dimensions. To do this, press on it and rotate it to the right.

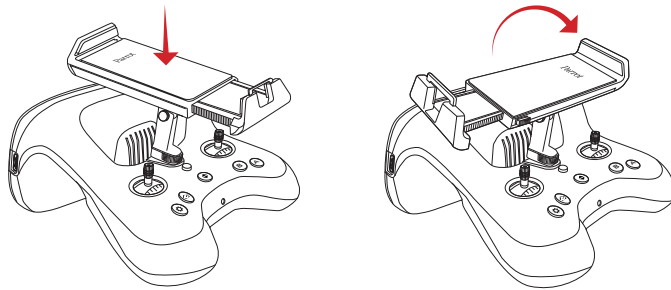

2. Press the right button on the holder to fully open it.
3. Position your smartphone on the holder.

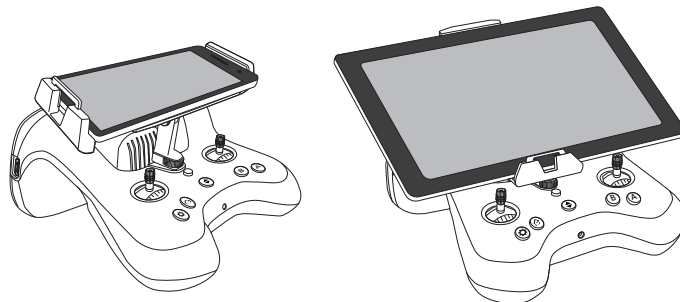

4. Tighten the holder on your smartphone.
5. Using your smartphone's USB cable, connect your smartphone to the Parrot Skycontroller 2's USB port.
  - > The FreeFlight Pro application starts automatically.
  - You are connected.

## USE THE PARROT COCKPITGLASSES

1. Connect your Parrot Skycontroller 2 to your drone.
2. Pull out the drawer on your Parrot Cockpitglasses.

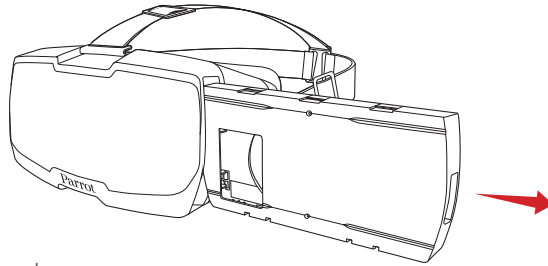

3. Open the drawer.
4. Pass your smartphone's USB cable through the opening in the drawer.

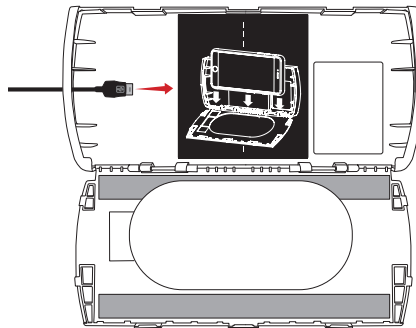

5. Plug one end of your smartphone's USB cable into the Parrot Skycontroller 2 and the other end into your smartphone.
  - > The FreeFlight Pro application will launch automatically on your smartphone.
6. In the FreeFlight Pro application, go to **Fly & Film** and press .
  - > FPV mode launches on your smartphone.

- Centre your smartphone in relation to the dots on the drawer and block it on the central part of the drawer.

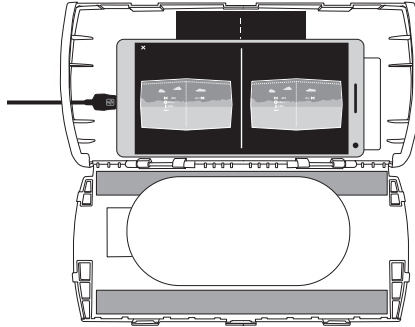

- Close the drawer and slide it into the Parrot Cockpitglasses.

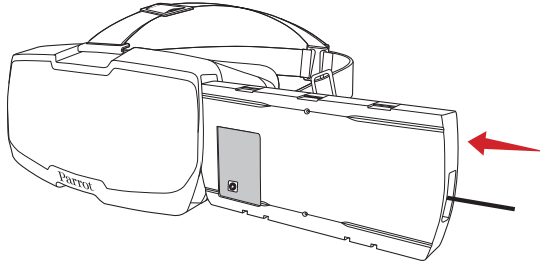

- Adjust the strap of the Parrot Cockpitglasses on your head.

**Note:** Use the Parrot Skycontroller 2 to edit the FreeFlight Pro application's settings when you are wearing Parrot Cockpitglasses.

## FIRST FLIGHT: USE THE FLAT TRIM FUNCTION

- Place the Parrot Disco on a flat surface.
- Press the On/Off switch to turn on the Parrot Disco.
- On your smartphone, connect to the Parrot Disco's Wi-Fi® : Disco\_XXXX.
- In the FreeFlight Pro application, go to **Fly and film** >  > **Position** and press **Flat trim**.

# TAKING OFF

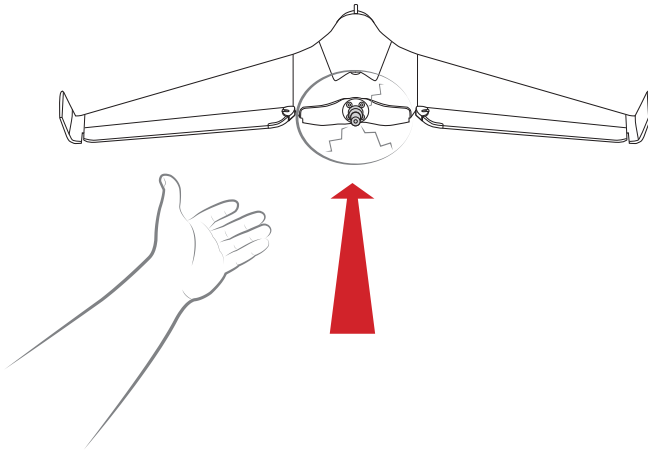

**⚠️ You must take off into the wind.**

1. Stand facing upwind holding the body of the Parrot Disco with one hand.
2. Make sure the Parrot Disco's engine is completely clear.
3. Press the  button on your Parrot Skycontroller 2.
  - > The Parrot Disco's engine will slowly run for 3 seconds and then accelerate.
  - > A «Ready to take off» pop-up window is displayed on your smartphone. You can take off.
4. Gently toss the Parrot Disco upward.



> The Parrot Disco takes off. It goes up to 50 metres in altitude and then makes 60-metre diameter circles. Now you can fly it.

**Note:** To stop the Parrot Disco's engine, press the  button again on your Parrot Skycontroller 2.

If you do not toss the Parrot Disco within 10 seconds of pressing , the engine shuts off. Press , again to start a new take off procedure.

# PILOTING MODES

## AUTOPILOT

This mode allows you to securely fly the Parrot Disco. During flight, the Parrot Disco maintains its speed and maintains its altitude.

### LEFT CONTROL

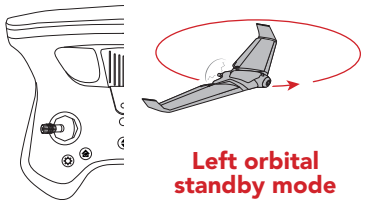
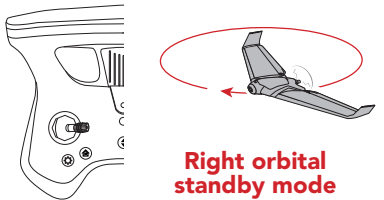
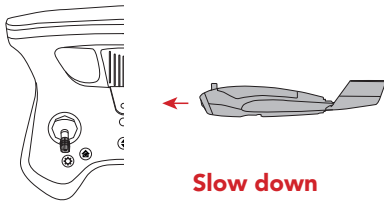
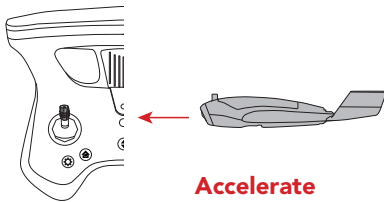

### RIGHT CONTROL

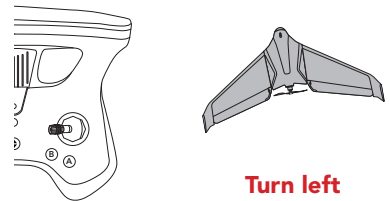
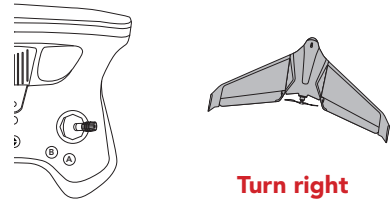
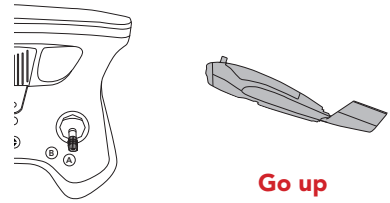

You can configure and customise the commands in the FreeFlight Pro application.



## MANUAL MODE

You can use an RC remote (not included) to fly the Parrot Disco.

Manual mode offers no piloting assistance for the Parrot Disco. Configure the channels of your RC remote for the Parrot Disco. To do this, refer to the manual for your RC remote.

**⚠** The Parrot Disco is difficult to control without the assistance of the autopilot. This mode is for expert pilots.

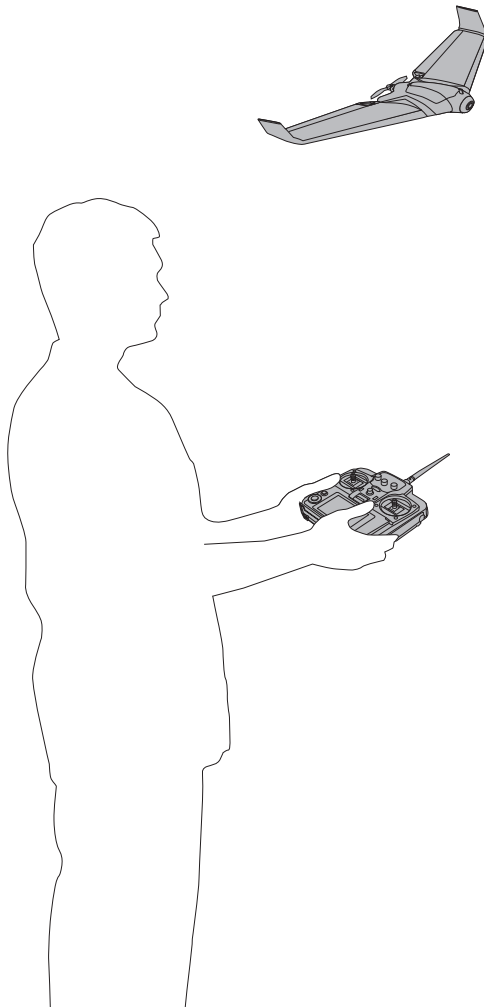

# CONTROL SCREEN

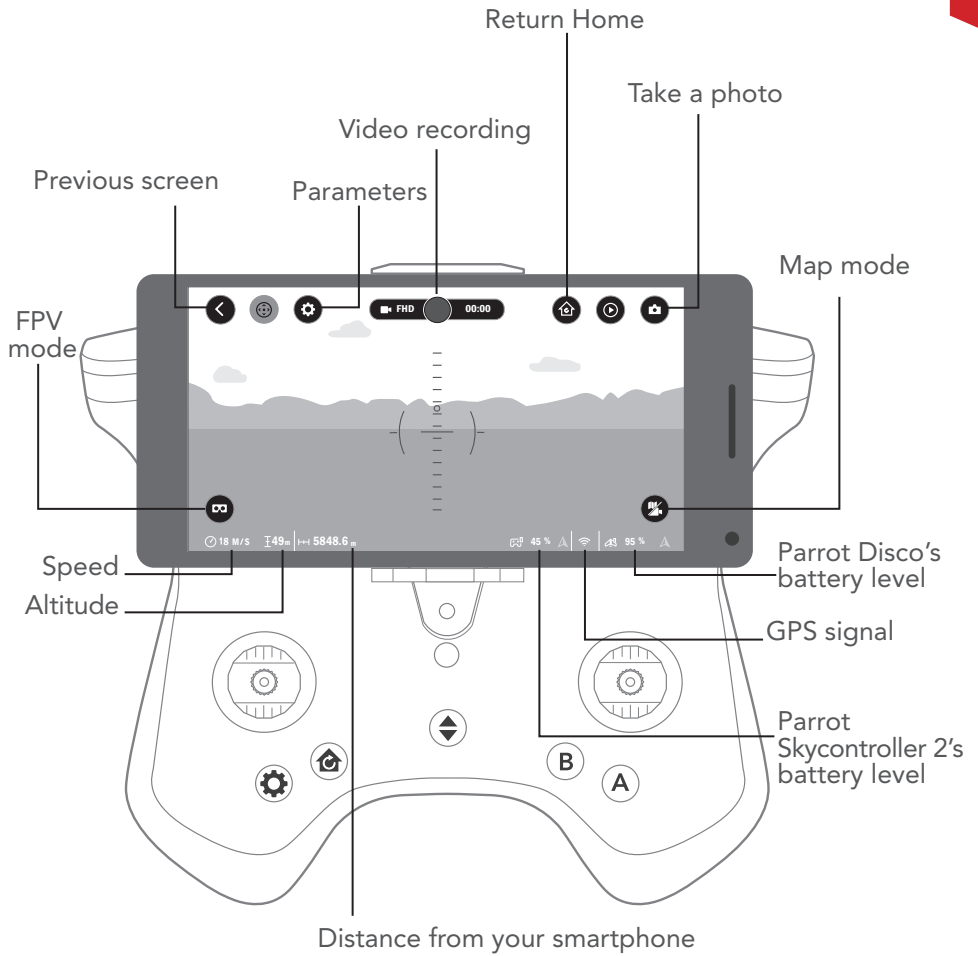

## FPV MODE

Use See Through mode to see through the camera of your smartphone when you are wearing Parrot Cockpitglasses.

Press the right trigger on the Parrot Skycontroller 2 to switch from immersive view to See Through.

There are several display mode in Freeflight Pro application:

- **Radar** : Information about your Parrot Disco position.
- **Telemetry** : Distance between the pilot and the Parrot Disco, altitude of the drone...
- **Full Screen** : Live video streaming from the front camera of the Parrot Disco without any other information.

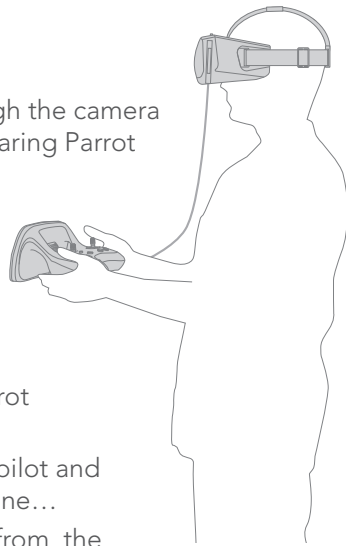

## RETURN HOME

To make the Parrot Disco return to its starting point, press the  button on the Parrot Skycontroller 2 or on the FreeFlight Pro application.

- > The Parrot Disco sets its altitude to 50 meters, comes back towards its starting position and makes 60-meter diameter circles above this position.

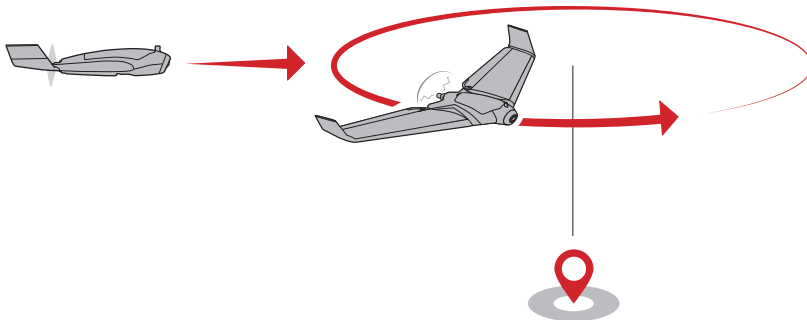

 Make sure you are in an open environment.

# LANDING

⚠ To avoid damaging the Parrot Disco, land on a suitable surface, such as grass, for example.

## LINEAR LANDING

1. Position the Parrot Disco facing upwind.
2. Press the  button on the Parrot Skycontroller 2.
  - > The Parrot Disco descends in a straight line and then straightens and lands softly.

**Note:** During the descent of the Parrot Disco, you can over-correct: go up, go down, turn left and turn right.

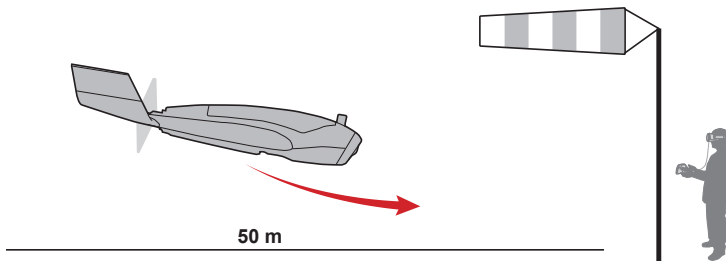

To cancel the landing, press the  button on the Parrot Skycontroller 2.

The Parrot Disco goes up to 50 meters and makes 60-meter diameter circles.

## CIRCULAR LANDING

During circular landing, the Parrot Disco makes sure, by itself, that it lands facing upwind so as to limit its landing speed.

1. Make sure you have an area of at least 80 meters in diameter to land the Parrot Disco.
2. In the FreeFlight Pro application, press Circular landing .  
> The Parrot Disco lands in a spiral.

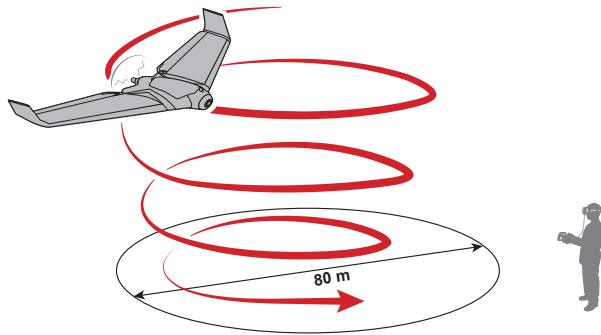

 Circular landing requires a lot of space.

# PHOTOS AND VIDEOS

The Parrot Disco can be used in photo mode or video mode.

## TAKING PHOTOS

On your Parrot Skycontroller 2, press the **(A)** button to take a photo. The internal memory of the Parrot Disco has a capacity of 32 GB. The maximum number of stored photos depends on the format selected.

For good quality photos, make sure the Parrot Disco is in photo mode.

## RECORDING VIDEOS

Recording starts automatically when you press the Take off button. The **●** icon flashes while recording video.

To stop recording, press the **(B)** button.

To record a new video, press **(B)** again.

**Note:** You cannot take videos when the Parrot Disco is in burst mode.

## FLIGHT PLAN

You can plan your flights thanks to the In-app Flight Plan, available for purchase in FreeFlight Pro.

**⚠** You must create and load your flight plan before taking off.

## PRELOADING A MAP

1. Make sure your smartphone is connected to the Internet.
2. Enable your smartphone's GPS.
3. In the FreeFlight Pro application, go to Menu > Settings.
4. Press Preload map.
  - > A map opens. The blue dot indicates the position of your smartphone.
5. Zoom in on your flight area.
6. Press Preload.
7. After preloading is complete, press **(◀)** to return to the previous screen.

## CREATING A FLIGHT PLAN

1. Press  to enable waypoint editing.
2. On the map, tap where you want to place your first waypoint.
  - > A numbered bubble appears. The number represents the altitude of the Parrot Disco when passing this point.
3. Continue placing your waypoints.
4. Once you have drawn your path, press and hold the last point of your journey.
  - > A pop-up window appears. Choose the desired landing mode (linear or circular). Warning! Circular landing requires an area of 60 metres in diameter free of obstacles.

**Your flight plan is created.**

## FLYING WITH FLIGHT PLAN

1. Make sure your flight plan is created and loaded.
2. Turn on your Parrot Disco.
3. Wait until the Parrot Disco's warning light turns green. This means that the GPS is connected.
4. Connect your smartphone to the Parrot Disco and start the FreeFlight Pro application.
5. On the Home screen, press Flight Plan.
6. Press Start.
7. Stand facing upwind
8. Make the Parrot Disco take off.
  - > The Parrot Disco begins the course you set.

## LOSS OF CONNECTION

If the connection is lost during flight between your Parrot Skycontroller 2 and your Parrot Disco, the Parrot Disco will fly in 60-meter diameter circles for a specified time period (10 seconds by default).

If the connection is not restored, the Parrot Disco returns to its starting position and then flies in 60-meter diameter circles.

If the connection is not restored after 5 minutes, the Parrot Disco performs a circular landing.

## TURNING OFF THE PARROT DISCO

To turn off the Parrot Disco, press and hold down the On/Off button.

> The red light flashes, and then the Parrot Disco turns off.

## RETRIEVING YOUR PHOTOS AND VIDEOS

### ON YOUR COMPUTER

**⚠** Always use the micro USB port to the left of the Parrot C.H.U.C.K.

1. Connect the Parrot Disco to your computer with the USB/micro USB (provided).

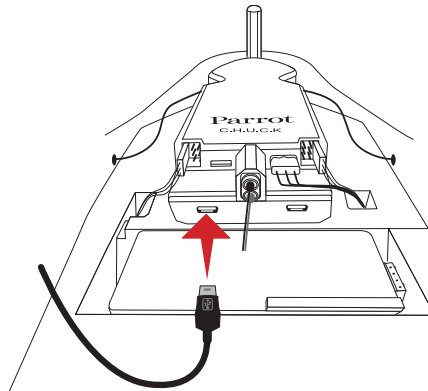



2. Turn on the Parrot Disco.
  - > Your computer will automatically detect the Parrot Disco.
3. Open the folder as if it were a USB flash drive.
4. Copy the photo and video recordings onto your computer.

## ON YOUR SMARTPHONE

To retrieve photos and/or videos from the FreeFlight Pro application:

1. Turn on your Parrot Disco and connect it via Wi-Fi to your smartphone.
2. On your smartphone, launch the FreeFlight Pro application and go to Menu ≡ > **Internal Memory**.
  - > The list of photos and videos stored in the internal memory of the Parrot Disco appears.
3. Select one or multiple photos and/or videos.
4. Press **Transfer** to retrieve the photos and/or videos.

## UPDATING THE PARROT DISCO

### VIA A SMARTPHONE

1. Connect your smartphone to the Internet.
2. Launch the FreeFlight Pro application.
3. Go to Menu ≡ > **Updates**.
4. Select the new version and press **Start**.
  - > The application downloads the update file.
5. Connect your smartphone to the Parrot Disco's Wi-Fi network.
6. Restart the FreeFlight Pro application.
7. Go to Menu ≡ > **Updates**.
  - > A pop-up window prompts you to install the update.
8. Press **OK** and wait until the installation is complete.
  - > The Parrot Disco automatically restarts.
9. Make sure the new version has actually been installed: in the FreeFlight Pro application, go to Menu ≡ > **Settings**. The version number is shown in the general information.

## VIA A MICRO USB FLASH DRIVE

1. Connect your micro USB flash drive (not provided) to a computer. Make sure that your flash drive does not contain any files in .plf format.
2. Go to the Parrot Disco's support page on [www.parrot.com](http://www.parrot.com) and download the update file available in .plf format.
3. Copy this file to the root of your micro USB flash drive.
4. Turn on the Parrot Disco.
5. Connect the micro USB flash drive to one of the Parrot Disco's ports.
  - > The Parrot Disco automatically restarts and the warning light flashes yellow. Then, the Parrot Disco restarts again.
6. Wait until the Parrot Disco has completely restarted.
7. Disconnect the micro USB flash drive.
  - > The update is complete. Make sure the new version has actually been installed: in the FreeFlight Pro application, go to Menu > Settings. The version number is shown in the general information.

## WARNING LIGHT INDICATIONS

Flashing red light	<p>The Parrot Disco is starting up.</p> <p><b>Or</b></p> <p>The Parrot Disco has detected an error.</p> <p><b>&gt; Restart the Parrot Disco on a flat, immobile surface, out of the wind. If the problem persists, visit the Parrot Disco's support page on <a href="http://www.parrot.com">www.parrot.com</a>.</b></p>
Flashing green light	The Parrot Disco has detected the GPS signal and is ready to take off.
Flashing yellow light	The Parrot Disco update is underway. Do not turn off the Parrot Disco.

# SPARE PARTS

You can buy spare parts for the Parrot Disco from our online store : [www.parrot.com](http://www.parrot.com).

For more information on the assembly of spare parts, see the video tutorials on our support page.

# TECHNICAL SPECIFICATIONS

## SENSORS

- Ultrasound
- Altimeter
- Hi-speed vertical camera
- Pitot Tube: speed sensor

## INERTIAL NAVIGATION SYSTEM

- Three-axis gyroscope
- Three-axis accelerometer.
- Three-axis magnetometer

## HARDWARE

- Dual core ARM 9 CPU
- Internal flash memory: 32GB

## WI-FI AND TRANSMISSIONS

- Network access point
- AC Wi-Fi, 2 dual band antenna (2.4 and 5 GHz), multiple inputs and outputs
- Up to 2km of range with the Parrot Skycontroller and the Parrot Skycontroller 2.

## REMOVABLE BATTERY

- 3 cell 2700mAh / 25A LipoBattery
- Battery life: 45 minutes
- Rated voltage: 11.1V
- 21.6A continuous discharge
- 3.5A max charge
- Operating range: -20°C-60°C

## DIMENSIONS

- Weight: 750 gr.
- Size: 1150 mm x 580 mm x 120 mm
- Wingspan: 1150 mm

## GPS

- Integrated GPS
- GPS + GLONASS

## PERFORMANCE

- Engine: 1280kv
- Servomotor: 5V
- Option of installing an SBUS, SUMD, CPPM radio receiver

## VIDEO & PHOTOS

- Full HD 1080p Camera
- Video feed: 360p / 720p

## FIRMWARE

- Linux & Open Source SDK for development

## BATTERY CHARGER

- Input: 100-240V, 50h-60Hz, 1.2A
- Output: Max 12.6Vdc, 3.5A
- Maximum altitude: 2000m above sea level
- Operating range: 0°C-40°C

## PARROT DISCO

- Operating range: 0°C-40°C
- Max current: 15A
- Rated voltage: 11.1V

# GENERAL INFORMATION

The Parrot Disco must be used in accordance with the civil aviation rules for each country, and in places suited to its chosen progression in order to always ensure the safety of people, animals and property. Before flying your Parrot Disco, check the local civil aviation rules.

## ACCESSORIES AND SPARE PARTS

Accessories and spare parts are available from your Parrot retailer or on [www.parrot.com](http://www.parrot.com).

## PRECAUTIONS FOR USE AND MAINTENANCE

### PARROT DISCO

The Parrot Disco is a model aircraft designed for recreation and leisure. The pilot must, at all times, maintain eye contact with the Parrot Disco and control its trajectory.

The Parrot Disco must be used according to the rules of civil aviation in your country. The places where it is used must be suitable to its progression in order to continuously ensure the safety of people, animals and property.

Using the Parrot Disco in some public places (for example: train stations, airports, etc.) or on public roads may not be allowed.

As soon as the Parrot Disco's propeller is moving, it can cause damage to people, animals or objects. Always stay a safe distance away from the Parrot Disco. Always pay attention to the Parrot Disco's propeller during take-off. Only use accessories specified by Parrot Drone SAS.

If sand or dust gets into the Parrot Disco, it may be irreparably damaged and no longer function properly. Do not use the Parrot Disco in adverse weather conditions (rain, strong wind or snow) or when visibility is poor (at night).

Keep the Parrot Disco away from high voltage power lines, buildings or any other potentially hazardous areas.

Do not use this device near liquids. Do not place the Parrot Disco on water or on a wet surface as this could cause irreparable damage.

Avoid making the Parrot Disco undergo significant changes in altitude.

Do not leave the Parrot Disco in the sun.

Risk of ingestion of small objects. The packaging is not part of the product and must be discarded as a safety measure.

### PARROT SKYCONTROLLER 2

The Parrot Skycontroller 2 is intended to fly the Bebop Drone, the Bebop 2 and the Parrot Disco and is not suitable for children under 14 years of age.

Check the list of drones that are compatible with the Parrot Skycontroller 2 in the Support section on [www.parrot.com](http://www.parrot.com).

Only use accessories specified by Parrot Drone SAS.

If sand or dust gets into the Parrot Skycontroller 2, it may be irreparably damaged and no longer function correctly.

Do not expose the Parrot Skycontroller 2 to rain or sun for an extended period.

Do not use this device near liquids.

Risk of ingestion of small objects. The packaging is not part of the product and must be discarded as a safety measure.

### PARROT COCKPITGLASSES

This device is not a toy. Only use the Parrot Cockpitglasses when you are flying a Parrot drone.

Do not disassemble, change or repair your Parrot Cockpitglasses yourself.

Make sure you are not close to people, objects, stairs, balconies, windows, furniture or any other item that you might hit when using the Parrot Cockpitglasses or immediately after their use. Do not hold sharp or dangerous objects when using Parrot Cockpitglasses.

Never wear Parrot Cockpitglasses in situations that require your attention, such as when walking, riding a bicycle or driving.

Ensure that the Parrot Cockpitglasses fit comfortably and securely on your head, and that the image is sharp and not doubled.

Do not use Parrot Cockpitglasses when you are tired, sleep-deprived, under the influence of alcohol or drugs, if you suffer from headaches or digestive problems, if you are suffering from emotional stress or anxiety, or if you have a cold, migraines or an earache, as this may increase the side effects.

Do not use Parrot Cockpitglasses when you are in a vehicle in motion, such as a car, bus or train, as this may increase the side effects.

Do not wear Parrot Cockpitglasses if the smartphone is not attached to it.

Only use accessories specified by Parrot.

If sand or dust gets into the Parrot Cockpitglasses, they may be irreparably damaged and no longer function correctly.

Do not leave the Parrot Cockpitglasses in the rain and do not expose them to sun for extended periods.

Do not use this device near liquids.

Risk of ingestion of small objects. The packaging is not part of the product and must be discarded as a safety measure.

### **WI-FI® (PARROT DISCO)**

Before you fly your Parrot Disco, check the restrictions regarding the use of Wi-Fi® frequencies in the place where you are going to fly it. Certain frequencies may be restricted or prohibited. In some countries, for example, the use of the 5 GHz Wi-Fi® band may be prohibited outdoors.

### **RISK OF SEIZURES (PARROT COCKPITGLASSES)**

For some people (about 1 in 4,000), strong light stimulation or a rapid succession of images can cause severe dizziness, convulsions, epileptic seizures or a feeling of faintness, which can occur when watching television, playing video games or during a virtual reality experience, even if they have never felt such discomfort before or have no history of convulsions or epileptic seizures. These types of ailments are more common in children and young adults under the age of 20. Anyone who has suffered seizures, a loss of consciousness or other symptoms related to epilepsy should consult a doctor before using Parrot Cockpitglasses.

### **CHILDREN (PARROT COCKPITGLASSES)**

Parrot Cockpitglasses should not be used by children under the age of 14. Adults should supervise children (14 years of age or over) who use or have used Parrot Cockpitglasses to ensure the absence of symptoms such as those described above, and should limit the duration of use of Parrot Cockpitglasses by children and impose breaks.

### **WARNING REGARDING PRIVACY AND RESPECT FOR IMAGES OF PROPERTY**

Recording and broadcasting an individual's image without their permission may constitute an invasion of privacy and you may be held liable. Ask permission before filming people, especially if you intend to keep your recordings and/or broadcast them. Do not broadcast degrading images which may affect an individual's reputation or dignity.

Recording and broadcasting the image of property without permission from its owner and or any third party holding intellectual property rights on the property may constitute a violation of the property's image rights and you may be held liable. Ask permission from its owner and/or any third party with ownership rights.

### **BATTERY (PARROT DISCO/PARROT SKYCONTROLLER 2)**

**WARNING:** Failure to follow all the instructions may result in serious injury, irreparable damage to the battery and may cause a fire, smoke or explosion.

Always check the battery's condition before charging or using it. Replace the battery if it has been dropped, or in case of odour, overheating, discolouration, deformation or leakage. Never use anything other than the approved LiPo charger to charge the battery. Always use a balancing charger for LiPo cells or a LiPo cell balancer. It is recommended that you do not use any other charger than the one provided with the product. Never trickle charge or charge under 2.5V per cell. The battery temperature must never exceed 60 °C (140 °F) otherwise the battery could be damaged or ignite. Never charge on a flammable surface, near flammable products or inside a vehicle (preferably place the battery in a non-flammable

and non-conductive container). Never leave the battery unattended during the charging process. Never disassemble or modify the housing's wiring, or puncture the cells. Always ensure that the charger output voltage corresponds to the voltage of the battery. Do not short circuit the batteries. Never expose the LiPo battery to moisture or direct sunlight, or store it in a place where temperatures could exceed 60 °C (car in the sun, for example). Always keep it out of reach of children.

**CAUTION**  
**RISK OF EXPLOSION IF BATTERY IS REPLACED BY AN**  
**INCORRECT TYPE.**  
**DISPOSE OF USED BATTERIES ACCORDING**  
**TO THE INSTRUCTIONS.**

#### **WARRANTY**

For the warranty conditions, please read the Terms and Conditions of sale of the retailer where you purchased the Parrot Disco/Parrot Skycontroller 2/Parrot Cockpitglasses.

#### **HOW TO RECYCLE THIS PRODUCT (PARROT DISCO/PARROT SKYCONTROLLER 2)**



This symbol on the product or its documentation indicates that it must not be disposed of with household waste. Uncontrolled waste disposal may harm the environment or human health. Please separate your device from other types of waste to recycle it responsibly. This will help to foster the sustainable re-use of material resources. We invite you to contact your retailer or inquire at your local town hall to find out where and how the Parrot Skycontroller 2/Parrot Disco/Parrot Cockpitglasses can be recycled.

#### **DECLARATION OF CONFORMITY (PARROT DISCO)**



This device can be used in: DE, AT, BE, BG, CY, HR, DK, ES, EE, FI, FR, GR, HU, IE, IT, LV, LT, LU, MT, NL, PL, PT, CZ, RO, GB, SK, SI, SE.

The outdoor use restriction in member states of the European Union relates only to the first in the 5GHz band (5150-5250MHz).

Parrot DRONES, 174 quai de Jemmapes, 75010 Paris, France, hereby declares that it is solely responsible for the compliance of the product described in this user guide with technical standards, EN 301489-1 (v1.9.2), EN 301489-3 (v1.6.1), EN301489-17 (v2.2.1), EN300440-1 (v1.6.1), EN 62311, EN300328 (v1.9.1), EN301893 (v1.7.1), EN300440-2 (v1.4.1), EN 60950-1: 2006/A11: 2009/A1: 2010/A12: 2011/A2: 2013, EN50581 under the provisions of the (R&TTE) Directive 1999/5/EC, the General Product Safety Directive 2001/95/EU and the ROHS Directive 2011/65/EU. <http://www.parrot.com/ce/?parrot-disco>

#### **DECLARATION OF CONFORMITY (PARROT SKYCONTROLLER 2)**

This device can be used in: DE, AT, BE, BG, CY, HR, DK, ES, EE, FI, FR, GR, HU, IR, IT, LV, LT, LU, MT, NL, PL, PT, CZ, RO, GB, SK, SI, SE.

Parrot DRONES, 174 quai de Jemmapes, 75010 Paris, France, hereby declares that it is solely responsible for the compliance of the product described in this user guide with technical standards, EN 301489-17, EN300328, EN71-1, EN71-2, EN71-3, EN62115, EN 50566: 2013 (SAR) under the provisions of the Radio Equipment Directive (RED) 2014/53/EU and the General Product Safety Directive 2014/35/EU. <http://www.parrot.com/ce/?skycontroller-2>

#### **DECLARATION OF CONFORMITY IN CANADA (PARROT DISCO)**

This device complies with the Industry Canada RSS applicable to license-exempt radio apparatus. Operation is permitted subject to the following two conditions: (1) the device must not produce interference, and (2) the user of the device must accept any radio interference encountered, even if the interference is likely to compromise operations. This category B digital device is compliant with the NMB-003 standard of Canada.

#### **DECLARATION OF CONFORMITY IN USA/CANADA (PARROT SKYCONTROLLER 2)**

This device complies with the Industry Canada RSS applicable to license-exempt radio apparatus. Operation is permitted subject to the following two conditions: (1) the device must not produce inter-

ference, and (2) the user of the device must accept any radio interference encountered, even if the interference is likely to compromise operations.

### **FCC/IC (PARROT DISCO/PARROT SKYCONTROLLER 2)**

To comply with FCC/IC RF exposure guidelines for transmission equipment, a distance of at least 20 cm must be maintained between the product antenna and individuals. To remain compliant it is not recommended to use the product at any distance less than this.

Changes or modifications not expressly approved by the party responsible for compliance could void the user's authority to operate the equipment.

This equipment has been tested and found to comply with the limits for a Class B digital device, pursuant to part 15 of the FCC Rules. These limits are designed to provide reasonable protection against harmful interference in a residential installation. This equipment generates, uses and can radiate radio frequency energy and, if not installed and used in accordance with the instructions, may cause harmful interference to radio communications. However, there is no guarantee that interference will not occur in a particular installation. If this equipment does cause harmful interference to radio or television reception, which can be determined by turning the equipment off and on, the user is encouraged to try to correct the interference by one or more of the following measures:

- Reorient or relocate the receiving antenna.
- Increase the separation between the equipment and receiver.
- Connect the equipment into an outlet on a circuit different from that to which the receiver is connected.
- Consult the dealer or an experienced radio/TV technician for help.

This portable equipment with its antenna complies with FCC's radiation exposure limits set forth for an uncontrolled environment. This equipment has shown compliance with FCC's Specific Absorption Rate (SAR) limits. To maintain compliance, follow the instructions below :

This transmitter must not be co-located or operating in conjunction with any other antenna or transmitter.

### **TRADEMARKS**

Parrot Disco, Parrot Skycontroller, Parrot Cockpitglasses, Parrot C.H.U.C.K as well as their respective logos are trademarks of Parrot Drones SAS.

Parrot and the Parrot logos are trademarks of Parrot S.A.

iPhone is a trademark of Apple Inc., registered in the USA and other countries.

App Store is a trademark of Apple Inc.

Google Play is a trademark of Google Inc.

Samsung, Galaxy S and Galaxy Note are registered trademarks of Samsung Electronics.

LG and G4 are trademarks or registered trademarks of LG Electronics, Inc.

HTC One is a commercial brand of HTC Corporation.

Wi-Fi® is a registered trademark of Wi-Fi Alliance®.

Linux is a trademark of Linus Torvalds registered in the USA and other countries.

All other trademarks mentioned in this guide are the property of their respective owners.

### **MANUFACTURER INFORMATION**

The Parrot Disco/Parrot Skycontroller 2/Parrot Cockpitglasses is manufactured by: PARROT DRONES SAS - 174 Quai de Jemmapes - 75010 Paris (France) - Corporate and Trade Register Paris 808 408 074

[www.parrot.com](http://www.parrot.com)

