



User Guide

© Copyright 2017 HP Development Company, L.P.

HDMI, the HDMI Logo and High-Definition Multimedia Interface are trademarks or registered trademarks of HDMI Licensing LLC.

The information contained herein is subject to change without notice. The only warranties for HP products and services are set forth in the express warranty statements accompanying such products and services. Nothing herein should be construed as constituting an additional warranty. HP shall not be liable for technical or editorial errors or omissions contained herein.

Product notice





This guide describes features that are common to most models. To access the latest user guide, go to <http://www.hp.com/support>, and select your country. Select **Find your product**, and then follow the on-screen instructions.

First Edition: August 2017

Document Part Number: 929163-002

About This Guide

This guide provides information on monitor features, setting up the monitor, and technical specifications.

-
-  **WARNING!** Indicates a hazardous situation that, if not avoided, **could** result in death or serious injury.
 -  **CAUTION:** Indicates a hazardous situation that, if not avoided, **could** result in minor or moderate injury.
 -  **NOTE:** Contains additional information to emphasize or supplement important points of the main text.
 -  **TIP:** Provides helpful hints for completing a task.
-



This product incorporates HDMI technology. (Select Models)

Contents

1	Getting Started	1
	Important safety information	1
	Product features and components	2
	Features	2
	Rear components	3
	54.61 cm/21.5-inch model	3
	60.47 cm/23.8-inch model	3
	Front bezel controls	4
	Setting up the monitor	5
	Installing the monitor stand	5
	Connecting the cables	5
	Adjusting the monitor	7
	Turning on the monitor	8
	HP Watermark and Image Retention Policy	9
	Installing a security cable	9
2	Using the Monitor	10
	Downloading the monitor drivers	10
	Using the On-Screen Display (OSD) menu	10
	Assigning the Function buttons	11
	Adjusting to Low Blue Light Mode	11
	Using Auto-Sleep Mode	11

3	Support and troubleshooting	12
	Solving common problems	12
	Using the auto-adjustment function (analog input)	13
	Optimizing image performance (analog input)	14
	Button lockouts	15
	Product support	15
	Preparing to call technical support	15
	Locating the serial number and product number	16
4	Maintaining the monitor	17
	Maintenance guidelines	17
	Cleaning the monitor	17
	Shipping the monitor	17
A	Technical specifications	18
	54.61 cm/21.5-inch model	18
	60.47 cm/23.8-inch model	18
	Preset display resolutions	19
	54.61 cm/21.5-inch model	19
	60.47 cm/23.8-inch model	19
	Entering user modes	20
	Energy saver feature	20
B	Accessibility	21
	Supported assistive technologies	21
	Contacting support	21

1 Getting Started

Important safety information

An AC power cord is included with the monitor. If another cord is used, use only a power source and connection appropriate for this monitor. For information on the correct power cord set to use with the monitor, refer to the *Product Notices* provided in your documentation kit.

⚠ WARNING! To reduce the risk of electric shock or damage to the equipment:

- Plug the power cord into an AC outlet that is easily accessible at all times.
- Disconnect power from the computer by unplugging the power cord from the AC outlet.
- If provided with a 3-pin attachment plug on the power cord, plug the cord into a grounded (earthed) 3-pin outlet. Do not disable the power cord grounding pin, for example, by attaching a 2-pin adapter. The grounding pin is an important safety feature.

For your safety, do not place anything on power cords or cables. Arrange them so that no one may accidentally step on or trip over them.

To reduce the risk of serious injury, read the *Safety & Comfort Guide*. It describes proper workstation, setup, posture, and health and work habits for computer users, and provides important electrical and mechanical safety information. This guide is located on the Web at <http://www.hp.com/ergo>.

⚠ CAUTION: For the protection of the monitor, as well as the computer, connect all power cords for the computer and its peripheral devices (such as a monitor, printer, scanner) to some form of surge protection device such as a power strip or Uninterruptible Power Supply (UPS). Not all power strips provide surge protection; the power strips must be specifically labeled as having this ability. Use a power strip whose manufacturer offers a Damage Replacement Policy so you can replace the equipment, if surge protection fails.

Use the appropriate and correctly sized furniture designed to properly support your HP LCD monitor.

⚠ WARNING! LCD monitors that are inappropriately situated on dressers, bookcases, shelves, desks, speakers, chests, or carts may fall over and cause personal injury.

Care should be taken to route all cords and cables connected to the LCD monitor so that they cannot be pulled, grabbed, or tripped over.

Be sure that the total ampere rating of the products connected to the AC outlet does not exceed the current rating of the outlet, and that the total ampere rating of the products connected to the cord does not exceed the rating of the cord. Look on the power label to determine the ampere rating (AMPS or A) for each device.

Install the monitor near an AC outlet that you can easily reach. Disconnect the monitor by grasping the plug firmly and pulling it from the AC outlet. Never disconnect the monitor by pulling the cord.

Do not drop the monitor or place it on an unstable surface.

📝 NOTE: This product is suitable for entertainment purposes. Consider placing the monitor in a controlled luminous environment to avoid interference from surrounding light and bright surfaces that may cause disturbing reflections from the screen.

Product features and components

Features

The monitors include the following features:

- 54.61 cm (21.5-inch) diagonal viewable screen area with 1920 x 1080 resolution, plus full-screen support for lower resolutions; includes custom scaling for maximum image size while preserving original aspect ratio
- 60.47 cm (23.8-inch) diagonal viewable screen area with 1920 x 1080 resolution, plus full-screen support for lower resolutions; includes custom scaling for maximum image size while preserving original aspect ratio
- Anti-Glare onglare panel with an LED backlight
- Wide viewing angle to allow viewing from a sitting or standing position, or when moving from side to side
- Tilt capability
- VGA video input
- DVI digital signal (Select Models)
- HDMI (High-Definition Multimedia Interface) video input (Select Models)
- Plug-and-play capability if supported by your operating system
- Security cable slot provision on rear of monitor for optional security cable
- On-Screen Display (OSD) adjustments in several languages for easy setup and screen optimization
- HDCP (High-Bandwidth Digital Content Protection) copy protection on all digital inputs
- Energy saver feature to meet requirements for reduced power consumption



NOTE: For safety and regulatory information, refer to the *Product Notices* provided in your documentation kit. To locate updates to the user guide for your product, go to <http://www.hp.com/support>, and download the latest versions of HP programs and drivers. In addition, register to receive automatic notifications when updates become available.

Rear components

Depending on your monitor model, the rear components will differ.

54.61 cm/21.5–inch model



Component	Function
1 DVI dconnector or HDMI connector	Connects the DVI cable to the monitor (Select Models) or connects the HDMI cable to the monitor (Select Models)
2 VGA connector	Connects the VGA cable to the monitor
3 Power connector	Connects the power cable to the monitor

60.47 cm/23.8–inch model

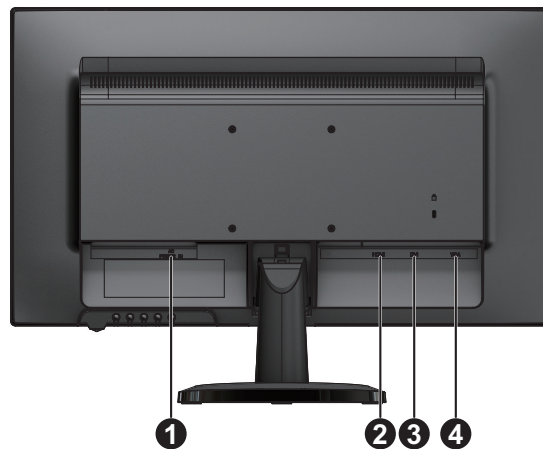

Component	Function
1 Power connector	Connects the power cable to the monitor
2 HDMI connector	Connects the HDMI cable to the monitor
3 DVI connector	Connects the DVI cable to the monitor
4 VGA connector	Connects the VGA cable to the monitor

Front bezel controls

Depending on your monitor model, the location of the front bezel controls will differ.

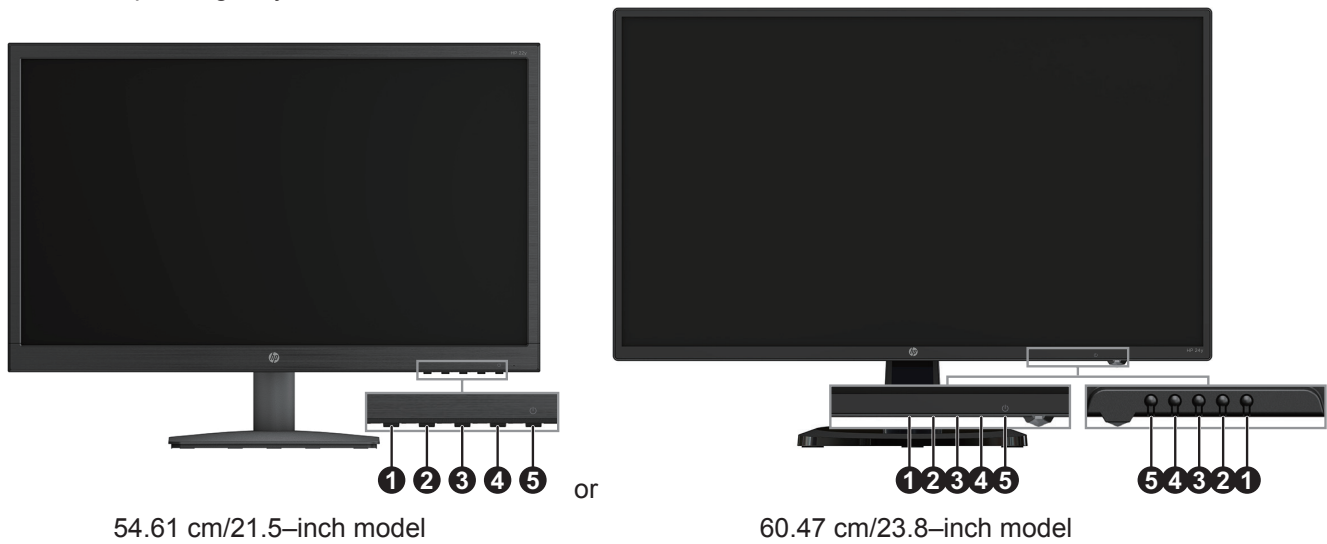

Control	Function
1 Menu/OK	Opens the OSD menu or selects items on the OSD menu.
2 Minus	If the OSD menu is on, press to navigate backward through the OSD menu and decrease adjustment levels.
3 Plus	If the OSD menu is on, press to navigate forward through the OSD menu and increase adjustment levels.
4 Exit	If the OSD menu is on, press to save any changes made, and exit the OSD menu.
5 Power	Turns the monitor on or off.



NOTE: Button 2 to 4 can be assign different function by user.

NOTE: To view an OSD menu simulator, visit the HP Customer Self Repair Services Media Library at <http://www.hp.com/go/sml>.

Setting up the monitor

Installing the monitor stand

CAUTION: Do not touch the surface of the LCD panel. Pressure on the panel may cause non-uniformity of color or disorientation of the liquid crystals. If this occurs, the screen will not recover to its normal condition.

1. Place the monitor face down on a flat and clean surface.
2. Insert stand riser and base into the monitor as shown above.

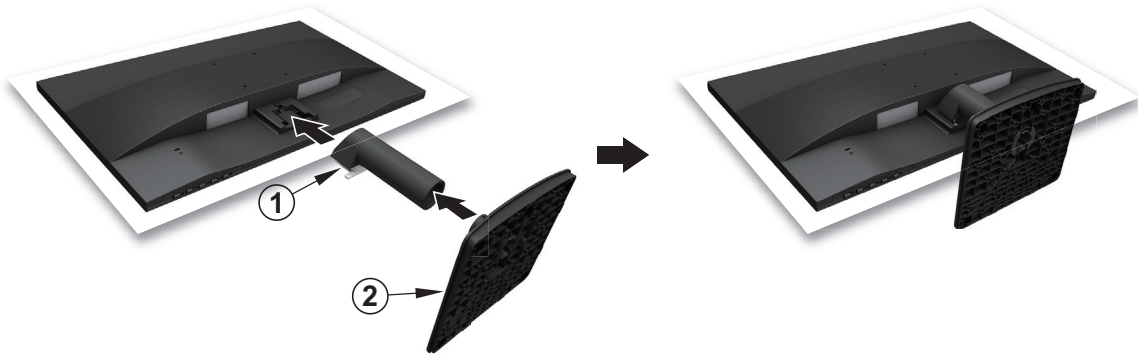

Connecting the cables

NOTE: The monitor ships with select cables. Not all cables shown in this section are included with the monitor.

1. Place the monitor in a convenient, well-ventilated location near the computer.
2. Connect a video cable.

NOTE: The monitor will automatically determine which inputs have valid video signals. The inputs can be selected by pressing the Menu button to access the On-Screen Display (OSD) menu and selecting **Input Control**.

- Connect one end of a VGA cable to the VGA connector on the rear of the monitor and the other end to the VGA connector on the source device.

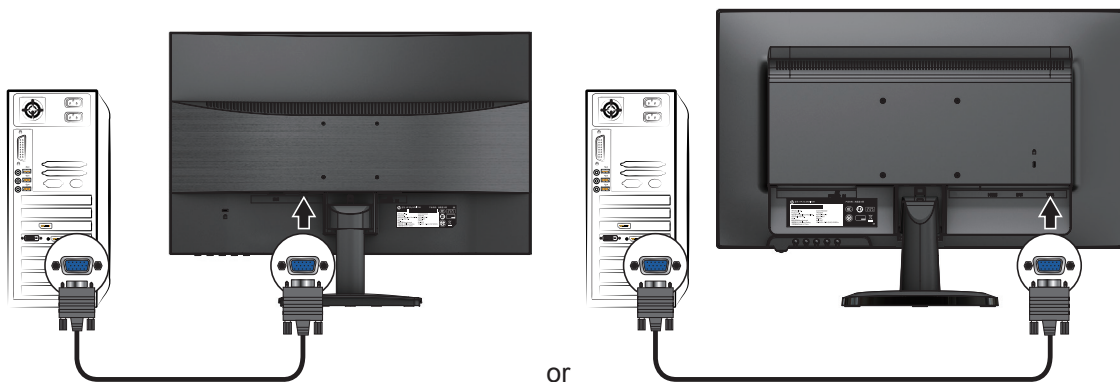

NOTE: Connector locations may vary.

- Connect one end of an DVI cable to the DVI connector on the rear of the monitor and the other end to a DVI connector on the source device. (Select Models)

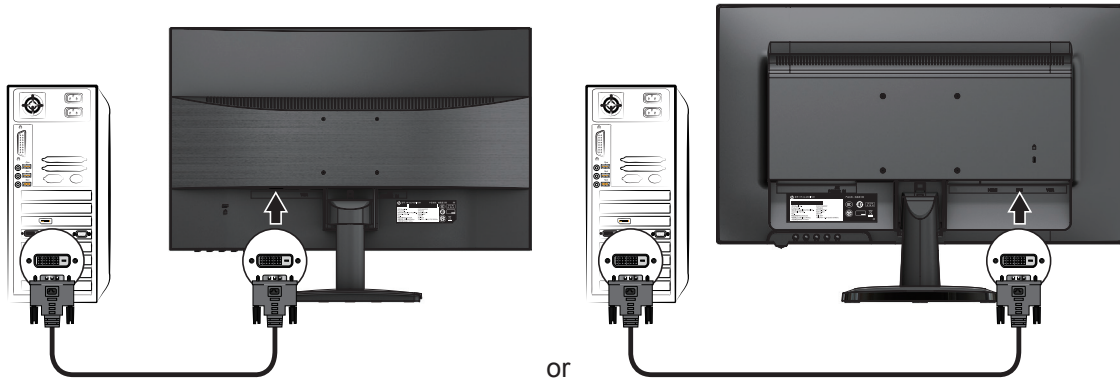

 **NOTE:** Connector locations may vary.

- Connect one end of an HDMI cable to the HDMI connector on the rear of the monitor and the other end to a HDMI connector on the source device. (Select Models)

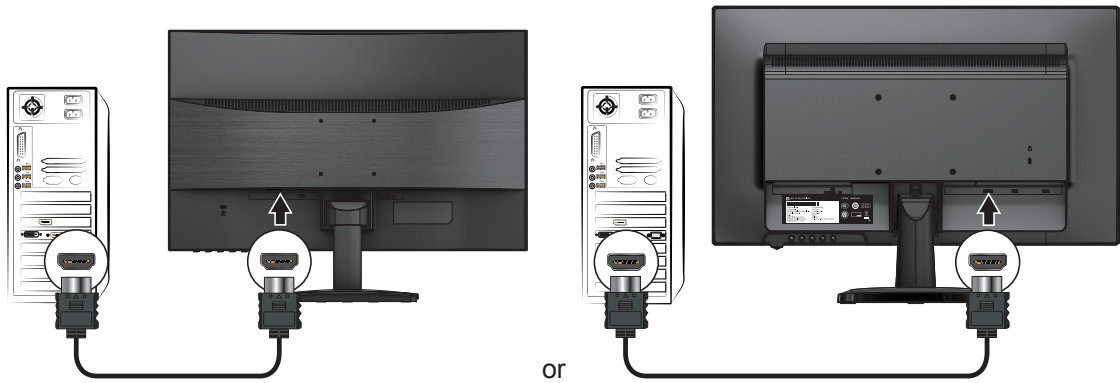

 **NOTE:** Connector locations may vary.

3. Connect one end of the power cord to the monitor and the other end to a grounded AC outlet.

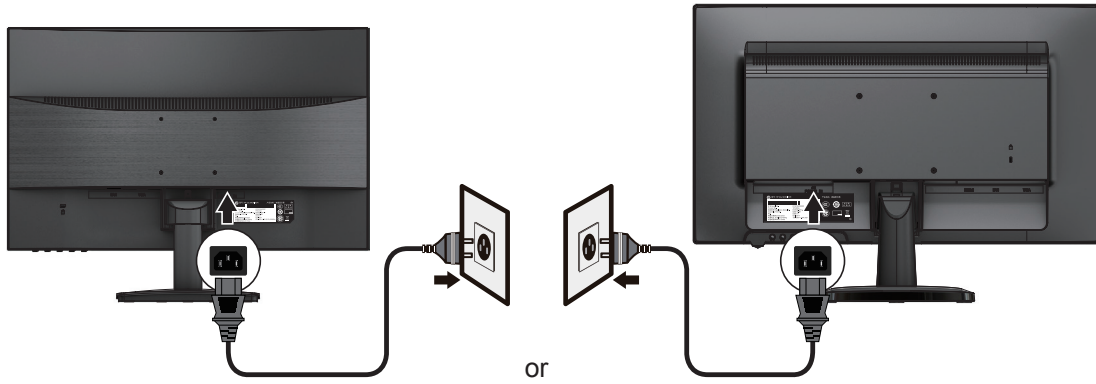

⚠ WARNING! To reduce the risk of electric shock or damage to the equipment:
Do not disable the power cord grounding plug. The grounding plug is an important safety feature.
Plug the power cord into a grounded (earthed) AC outlet that is easily accessible at all times.
Disconnect power from the equipment by unplugging the power cord from the AC outlet.
For your safety, do not place anything on power cords or cables. Arrange them so that no one may accidentally step on or trip over them. Do not pull on a cord or cable. When unplugging the power cord from the AC outlet, grasp the cord by the plug.

📝 NOTE: Connector locations may vary.

Adjusting the monitor

Tilt the display head forward or backward to set it to a comfortable eye level.

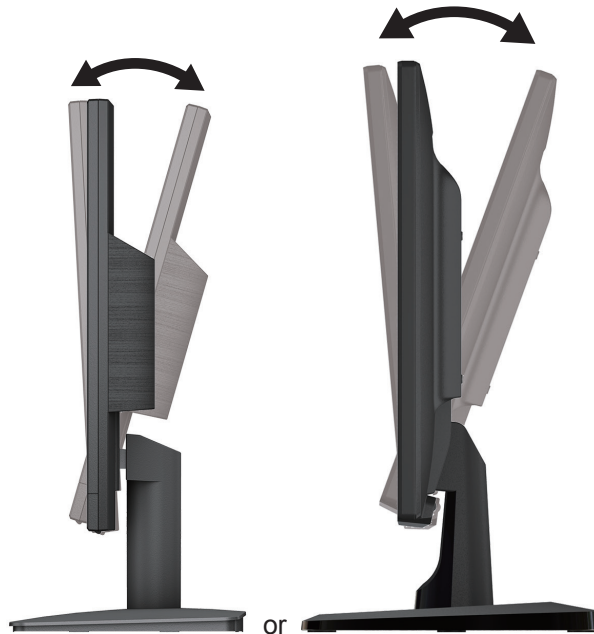

Turning on the monitor

1. Press the Power button on the computer to turn it on.
2. Press the Power button on the bottom of the monitor to turn it on.

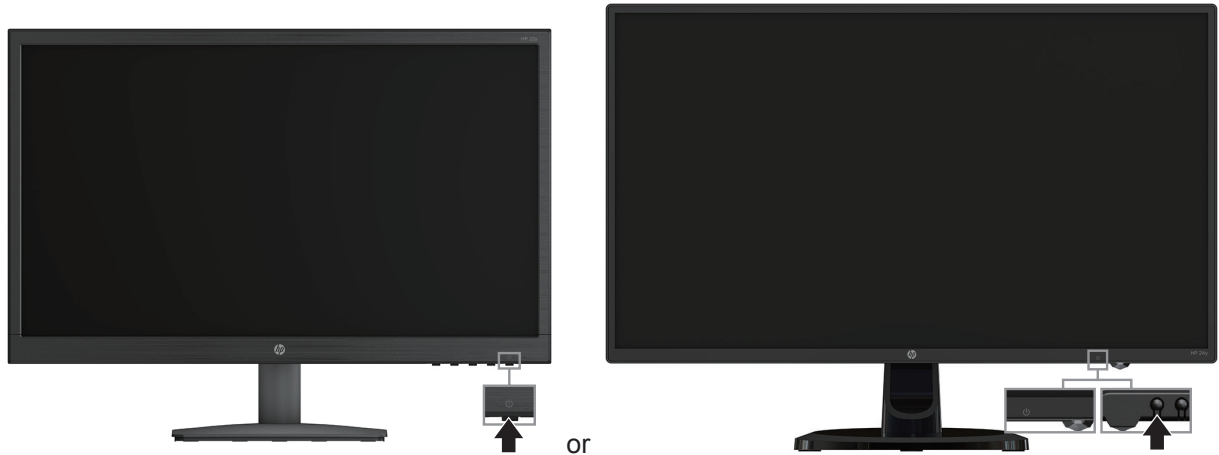

CAUTION: Burn-in image damage may occur on monitors that display the same static image on the screen for 12 or more consecutive hours of nonuse. To avoid burn-in image damage on the monitor screen, you should always activate a screen saver application or turn off the monitor when it is not in use for a prolonged period of time. Image retention is a condition that may occur on all LCD screens. A “burned-in image” on the monitor is not covered under the HP warranty.

NOTE: If pressing the Power button has no effect, the Power Button Lockout feature may be enabled. To disable this feature, press and hold the monitor Power button for 10 seconds.

NOTE: You can disable the power LED in the OSD menu. Press the Menu button on the bottom of the monitor, and then select **Power Control > Power LED > Off**.

When the monitor is powered on, a Monitor Status message is displayed for five seconds. The message shows which input is the current active signal, the status of the auto-switch source setting (On or Off; default setting is On), the current preset screen resolution, and the recommended preset screen resolution.

The monitor automatically scans the signal inputs for an active input and uses that input for the screen.

HP Watermark and Image Retention Policy

The ADS monitor models are designed with ADS (Advanced Super Dimension Switch) display technology which provides ultra-wide viewing angles and advanced image quality. ADS monitors are suitable for a wide variety of advanced image quality applications. This panel technology, however, is not suitable for applications that exhibit static, stationary or fixed images for long periods of time without the use of screen savers. These types of applications may include camera surveillance, video games, marketing logos, and templates that are displayed on the screen for a prolonged period of time. Static images may cause image retention damage that could look like stains or watermarks on the monitor's screen.

Monitors in use for 24 hours per day that result in image retention damage are not covered under the HP warranty. To avoid image retention damage, always turn off the monitor when it is not in use or use the power management setting, if supported on your system, to turn off the display when the system is idle.

Installing a security cable

You can secure the monitor to a fixed object with an optional cable lock available from HP.

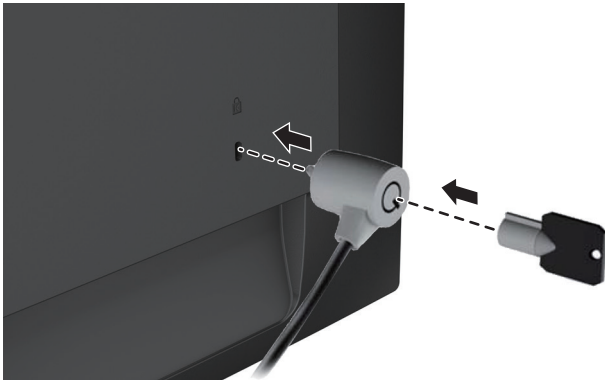

2 Using the Monitor

Downloading the monitor drivers

You can download the latest version of .INF and .ICM files from the HP monitors support Web site.

1. Go to <http://www.hp.com/support>.
2. Select **Get software and drivers**.
3. Follow the on-screen instructions to download the software.

Using the On-Screen Display (OSD) menu

Use the On-Screen Display (OSD) menu to adjust the monitor screen image based on your preferences. You can access and make adjustments in the OSD menu using the buttons on the bottom side of the monitor's front bezel.

To access the OSD menu and make adjustments, do the following:

1. If the monitor is not already on, press the Power button to turn on the monitor.
2. To access the OSD menu, press one of the Function buttons on the bottom side of the monitor's front bezel to activate the buttons, and then press the Menu button to open the OSD.
3. Use the three Function buttons to navigate, select, and adjust the menu choices. The button labels are variable depending on the menu or submenu that is active.

The following table lists the menu selections in the OSD menu.

Main Menu	Description
Brightness	Adjusts the brightness level of the screen.
Contrast	Adjusts the screen contrast.
Color Control	Selects and adjusts the screen color.
Input Control	Selects the video input signal.
Image Control	Adjusts the screen image.
Power Control	Adjusts the power settings.
Menu Control	Adjusts the on-screen display (OSD) and Function button controls.
Management	Enables/disables DDC/CI support, adjusts the audio settings, and returns all OSD menu settings to the factory default settings.
Language	Selects the language in which the OSD menu is displayed. The factory default is English.
Information	Displays important information about the monitor.
Exit	Exits the OSD menu screen.

Assigning the Function buttons

You can change the Function buttons from their default values so that when the buttons are activated you can quickly access commonly used menu items.

To assign the Function buttons:

1. Press one of the three Function buttons to activate the buttons, and then press the **Menu** button to open the OSD.
2. In the OSD menu, select **Menu Control > Assign Buttons** and then select one of the available options for the button you want to assign.

 **NOTE:** You can reassign only the three Function buttons. You can not reassign the **Menu button or the Power button**.

Adjusting to Low Blue Light Mode

Decreasing the blue light emitting from the display reduces the blue light exposure to your eyes. The monitor provides a setting to reduce blue light output and create a more relaxing and less stimulating image while reading content on the screen. To make this adjustment,

- Press the **Menu** button, select **Color Control > Viewing Modes > Low Blue Light**.

Press the check mark button (okay) to Save and Return.

 **NOTE:** To reduce the risk of serious injury, read the *Safety & Comfort Guide* provided with your user guide. It describes proper workstation setup, posture, health, and work habits for computer users. The *Safety & Comfort Guide* also provides important electrical and mechanical safety information. The *Safety & Comfort Guide* also available on the web at <http://www.hp.com/ergo>.

Using Auto-Sleep Mode

The monitor supports an OSD (On-Screen Display) menu option called **Auto-Sleep Mode** that allows you to enable or disable a reduced power state for the monitor. When Auto-Sleep Mode is enabled (enabled by default), the monitor will enter a reduced power state when the host PC signals low power mode (absence of either horizontal or vertical sync signal).

Upon entering this reduced power state (sleep mode), the monitor screen is blanked, the backlight is turned off and the power LED indicator turns amber. The monitor draws less than 0.5 W of power when in this reduced power state. The monitor will wake from the sleep mode when the host PC sends an active signal to the monitor (for example, if you activate the mouse or keyboard).

You can disable Auto-Sleep Mode in the OSD. Press one of the four Function buttons on the bottom side of the front bezel to activate the buttons, and then press the Menu button to open the OSD. In the OSD menu select **Power Control > Auto-Sleep Mode > Off**.

3 Support and troubleshooting

Solving common problems

The following table lists possible problems, the possible cause of each problem, and the recommended solutions.

Problem	Possible Cause	Solution
Screen is blank or video is flashing.	Power cord is disconnected.	Connect the power cord.
	Monitor is off.	Press the Power button. NOTE: If pressing the Power button has no effect, press and hold the Power button for 10 seconds to disable the Power button lockout feature.
	Video cable is improperly connected.	Connect the video cable properly. See Connecting the cables on page 6 for more information.
	System is in sleep mode.	Press any key on the keyboard or move the mouse to exit sleep mode.
	Video card is incompatible.	Open the OSD menu and select the Input Control menu. Set Auto-Switch Input to Off and manually select the input.
Image appears blurred, indistinct, or too dark.	Brightness is too low.	Open the OSD menu and select Brightness to adjust the brightness scale as needed.
Check Video Cable is displayed on screen.	Monitor video cable is disconnected.	Connect the appropriate video signal cable between the computer and monitor. Be sure that the computer power is off while you connect the video cable.
Input Signal Out of Range is displayed on screen.	Video resolution and/or refresh rate are set higher than what the monitor supports.	Change the settings to a supported setting. See Preset display resolutions on page 19 for more information.
The monitor is off but it did not seem to enter into sleep mode.	The monitor's power saving control is disabled.	Open the OSD menu and select Power Control > Auto-Sleep Mode and set auto-sleep to On .
OSD Lockout is displayed.	The monitor's OSD Lockout function is enabled.	Press and hold the Menu button on the bottom side of the front bezel for 10 seconds to disable the OSD Lockout function.
Power Button Lockout is displayed.	The monitor's Power Button Lockout function is enabled.	Press and hold the Power button for 10 seconds to disable the Power Button Lockout function.

Using the auto-adjustment function (analog input)

When you first set up the monitor, conduct a Factory Reset of the computer, or change the resolution of the monitor, the Auto-Adjustment feature automatically engages, and attempts to optimize your screen for you.

You may also optimize the screen performance for the VGA (analog) input at any time by using the auto button on the monitor (see your model's user guide for the specific button name) and the auto-adjustment pattern software utility (select models only).

Do not use this procedure if the monitor is using an input other than VGA. If the monitor is using a VGA (analog) input, this procedure can correct the following image quality conditions:

- Fuzzy or unclear focus
- Ghosting, streaking or shadowing effects
- Faint vertical bars
- Thin, horizontal scrolling lines
- An off-center picture

To use the auto-adjustment feature:

1. Allow the monitor to warm up for 20 minutes before adjusting.
2. Press the Menu button, and then select **Image Control>Auto-Adjustment** from the OSD menu. If the result is not satisfactory, continue with the procedure.
3. Display the auto-adjustment setup test pattern on your screen.
 - Download the auto-adjustment test pattern utility from <http://www.hp.com/support> and open the Auto-Adjustment utility.
4. Press the **ESC** key or any other key on the keyboard to exit the test pattern.

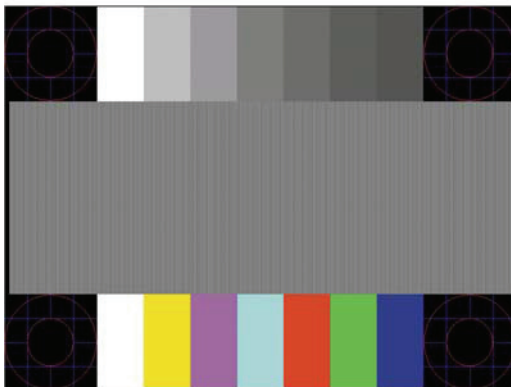

Optimizing image performance (analog input)

Two controls in the on-screen display can be adjusted to improve image performance: Clock and Phase (available in the OSD menu).

 **NOTE:** You may need to install the digitally signed monitor .INF and .ICM files in the event of an installation error.

The Clock must first be set correctly since the Phase settings are dependent on the main Clock setting. Use these controls only when the auto-adjustment function does not provide a satisfactory image.

- **Clock**—Increases/decreases the value to minimize any vertical bars or stripes visible on the screen background.
- **Phase**—Increases/decreases the value to minimize video flickering or blurring.

 **NOTE:** When using the controls, you will obtain the best results by using the auto-adjustment pattern software utility.

When adjusting the Clock and Phase values, if the monitor images become distorted, continue adjusting the values until the distortion disappears. To restore the factory settings, select **Yes** from the **Factory Reset** menu in the on-screen display.

To eliminate vertical bars (Clock):

1. Press the Menu button on the bottom of the front bezel to open the OSD menu, and then select **Image Control > Clock and Phase**.
2. Use the Function buttons on the bottom of the monitor front bezel that display up and down arrow icons to eliminate vertical bars. Press the buttons slowly so that you do not miss the optimum adjustment point.



3. After adjusting the Clock, if blurring, flickering, or bars appear on the screen, proceed to adjust the Phase.

To remove flickering or blurring (Phase):

1. Press the Menu button on the bottom of the monitor front bezel to open the OSD menu, and then select **Image Control > Clock and Phase**.
2. Press the Function buttons on the bottom of the monitor front bezel that display up and down arrow icons to eliminate flickering or blurring. Flickering or blurring may not be eliminated, depending on the computer or graphics controller card installed.



To correct screen position (Horizontal Position or Vertical Position):

1. Press the Menu button on the bottom of the front bezel to open the OSD menu, and then select **Image Position**.

2. Press the Function buttons on the bottom of the front bezel that display up and down arrow icons to properly adjust the position of the image in the display area of the monitor. The Horizontal Position shifts the image left or right; the Vertical Position shifts the image up and down.

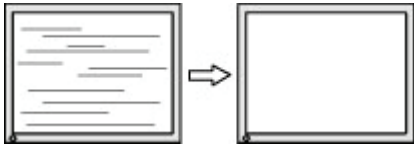

Button lockouts

Holding down the Power button or Menu button for ten seconds will lock out the functionality of that button. You can restore the functionality by holding the button down again for ten seconds. This functionality is only available when the monitor is powered on, displaying an active signal, and the OSD is not active.

Product support

For additional information on using your monitor, go to <http://www.hp.com/support>. Select **Find your Product**, and then follow the on-screen directions.

Here you can:

- Chat online with an HP technician



NOTE: When support chat is not available in a particular language, it is available in English.

- Locate an HP service center

Preparing to call technical support

If you cannot solve a problem using the troubleshooting tips in this section, you may need to call technical support. Have the following information available when you call:

- Monitor model number
- Monitor serial number
- Purchase date on invoice
- Conditions under which the problem occurred
- Error messages received
- Hardware configuration
- Name and version of the hardware and software you are using

Locating the serial number and product number

The serial number and product number are located on a label on the back of the display. You may need these numbers when contacting HP about the monitor model.

 **NOTE:** You may need to partially pivot the display head to read the label.

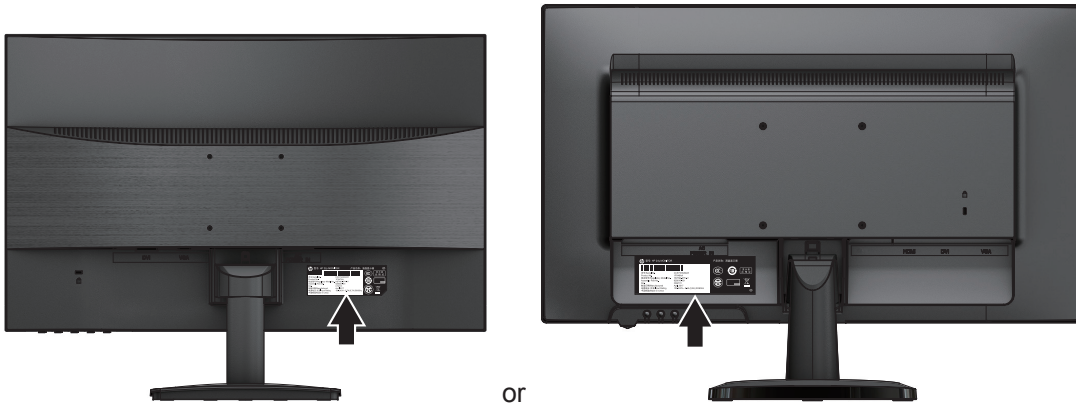

4 Maintaining the monitor

Maintenance guidelines

- Do not open the monitor cabinet or attempt to service this product yourself. Adjust only those controls that are covered in the operating instructions. If the monitor is not operating properly or has been dropped or damaged, contact an authorized HP dealer, reseller, or service provider.
- Use only a power source and connection appropriate for this monitor, as indicated on the label/back plate of the monitor.
- Turn the monitor off when not in use. You can substantially increase the life expectancy of the monitor by using a screen saver program and turning off the monitor when not in use.



NOTE: A “burned-in image” on the monitor is not covered under the HP warranty.

- Slots and openings in the cabinet are provided for ventilation. These openings must not be blocked or covered. Never push objects of any kind into cabinet slots or other openings.
- Keep the monitor in a well-ventilated area, away from excessive light, heat, or moisture.
- When removing the monitor stand, you must lay the monitor facedown on a soft area to prevent it from getting scratched, defaced, or broken.

Cleaning the monitor

1. Turn off the monitor and disconnect power from the computer by unplugging the power cord from the AC outlet.
2. Dust the monitor by wiping the screen and the cabinet with a soft, clean antistatic cloth.
3. For more difficult cleaning situations, use a 50/50 mix of water and isopropyl alcohol.



CAUTION: Spray the cleaner onto a cloth and use the damp cloth to gently wipe the screen surface. Never spray the cleaner directly on the screen surface. It may run behind the bezel and damage the electronics.



CAUTION: Do not use cleaners that contain any petroleum-based materials such as benzene, thinner, or any volatile substance to clean the monitor screen or cabinet. These chemicals may damage the monitor.

Shipping the monitor

Keep the original packing box in a storage area. You may need it later if you move or ship the monitor.

A Technical specifications

 **NOTE:** The product specifications provided in the user guide might have changed between the time of manufacturing and delivery of your product.

For the latest specifications or additional specifications on this product, go to <http://www.hp.com/go/quickspecs/> and search for your specific monitor model to find the model-specific QuickSpecs.

54.61 cm/21.5–inch model

Display	54.61 cm wide screen	21.5-inch wide screen
Type	TN	
Viewable Image Size	54.61 cm diagonal	21.5-inch diagonal
Maximum Weight (Unpacked)	2.60 kg	5.73 lb
Dimensions (include base)		
Height	38.30 cm	15.08 inches
Depth	17.03 cm	6.70 inches
Width	50.40 cm	19.84 inches
Maximum Graphic Resolution	1920 x 1080	
Optimum Graphic Resolution	1920 x 1080	
Environmental Requirements Temperature		
Operating Temperature	5 to 35° C	41 to 95° F
Storage Temperature	-20 to 60° C	-4 to 140° F
Power Source	100–240 VAC 50/60 Hz	
Input Terminal	VGA connector DVI-D connector (Select Models) HDMI connector (Select Models)	

60.47 cm/23.8–inch model

Display	60.47 cm wide screen	23.8-inch wide screen
Type	ADS	
Viewable Image Size	60.47 cm diagonal	23.8-inch diagonal
Maximum Weight (Unpacked)	3.65 kg	8.05 lb
Dimensions (include base)		
Height	40.51 cm	15.95 inches
Depth	20.99 cm	8.26 inches
Width	54.66 cm	21.52 inches
Maximum Graphic Resolution	1920 x 1080	
Optimum Graphic Resolution	1920 x 1080	
Environmental Requirements Temperature		
Operating Temperature	5 to 35° C	41 to 95° F
Storage Temperature	-20 to 60° C	-4 to 140° F
Power Source	100–240 VAC 50/60 Hz	
Input Terminal	VGA connector DVI-D connector HDMI connector	

Preset display resolutions

The display resolutions listed below are the most commonly used modes and are set as factory defaults. The monitor automatically recognizes these preset modes and they will appear properly sized and centered on the screen.

54.61 cm/21.5-inch model

Preset	Pixel Format	Horz	Horz Freq (kHz)	Vert Freq (Hz)
1	640 × 480		31.469	59.940
2	720 × 400		31.469	70.087
3	800 × 600		37.879	60.317
4	1024 × 768		48.363	60.004
5	1280 × 720		45.000	60.000
6	1280 × 800		49.702	59.810
7	1280 × 1024		63.981	60.020
8	1440 × 900		55.935	59.887
9	1600 × 900		60.000	60.000
10	1680 × 1050		65.290	59.954
11	1920 × 1080		67.500	60.000

60.47 cm/23.8-inch model

Preset	Pixel Format	Horz	Horz Freq (kHz)	Vert Freq (Hz)
1	640 × 480		31.469	59.940
2	720 × 400		31.469	70.087
3	800 × 600		37.879	60.317
4	1024 × 768		48.363	60.004
5	1280 × 720		45.000	60.000
6	1280 × 800		49.702	59.810
7	1280 × 1024		63.981	60.020
8	1440 × 900		55.935	59.887
9	1600 × 900		60.000	60.000
10	1680 × 1050		65.290	59.954
11	1920 × 1080		67.500	60.000

Entering user modes

The video controller signal may occasionally call for a mode that is not preset if:

- You are not using a standard graphics adapter.
- You are not using a preset mode.

If this occurs, you may need to readjust the parameters of the monitor screen by using the on-screen display. Your changes can be made to any or all of these modes and saved in memory. The monitor automatically stores the new setting, and then recognizes the new mode just as it does a preset mode. In addition to the factory preset modes, there are at least 10 user modes that can be entered and stored.

Energy saver feature

The monitors support a reduced power state. The reduced power state will be entered into if the monitor detects the absence of either the horizontal sync signal or the vertical sync signal. Upon detecting the absence of these signals, the monitor screen is blanked, the backlight is turned off, and the power light is turned amber. When the monitor is in the reduced power state, the monitor will utilize 0.5 watts of power. There is a brief warm-up period before the monitor will return to its normal operating mode.

Refer to the computer manual for instructions on setting energy saver features (sometimes called power management features).



NOTE: The above power saver feature only works when the monitor is connected to a computer that has energy saver features.

By selecting the settings in the monitor's Energy Saver utility, you can also program the monitor to enter into the reduced power state at a predetermined time. When the monitor's Energy Saver utility causes the monitor to enter the reduced power state, the power light blinks amber.

B Accessibility

HP designs, produces, and markets products and services that can be used by everyone, including people with disabilities, either on a stand-alone basis or with appropriate assistive devices.

Supported assistive technologies

HP products support a wide variety of operating system assistive technologies and can be configured to work with additional assistive technologies. Use the Search feature on your source device that is connected to the monitor to locate more information about assistive features.

 **NOTE:** For additional information about a particular assistive technology product, contact customer support for that product.

Contacting support

We are constantly refining the accessibility of our products and services and welcome feedback from users. If you have an issue with a product or would like to tell us about accessibility features that have helped you, please contact us at (888) 259-5707, Monday through Friday, 6 a.m. to 9 p.m. Mountain Time. If you are deaf or hard-of-hearing and use TRS/VRS/WebCapTel, contact us if you require technical support or have accessibility questions by calling (877) 656-7058, Monday through Friday, 6 a.m. to 9 p.m. Mountain Time.