

Instructions for Use

CuratOR™ EX2620-3D

Color LCD monitor

Important









Please read this “Instructions for Use”, and “Installation Manual” (separate volume) carefully to familiarize yourself with safe and effective usage.

Please retain this manual for future reference.

-
- For monitor adjustment and settings, refer to the Installation Manual.
 - The latest “Instructions for Use” is available for download from our web site :
<http://www.eizoglobal.com>
-

SAFETY SYMBOLS

This manual and this product use the safety symbols below. They denote critical information. Please read them carefully.

 <p>WARNING Failure to abide by the information in a WARNING may result in serious injury and can be life threatening.</p>	 <p>CAUTION Failure to abide by the information in a CAUTION may result in moderate injury and/or property or product damage.</p>
	<p>Indicates a warning or caution. For example,  indicates an “electrical shock” hazard.</p>
	<p>Indicates a prohibited action. For example,  means “Do not disassemble”.</p>
	<p>Indicates a mandatory action. For example,  means “Ground the unit”.</p>

This product has been adjusted specifically for use in the region to which it was originally shipped. If operated outside this region, the product may not perform as stated in the specifications.

No part of this manual may be reproduced, stored in a retrieval system, or transmitted, in any form or by any means, electronic, mechanical, or otherwise, without the prior written permission of EIZO Corporation. EIZO Corporation is under no obligation to hold any submitted material or information confidential unless prior arrangements are made pursuant to EIZO Corporation’s receipt of said information. Although every effort has been made to ensure that this manual provides up-to-date information, please note that EIZO monitor specifications are subject to change without notice.

PRECAUTIONS

● IMPORTANT

- This product has been adjusted specifically for use in the region to which it was originally shipped. If the product is used outside the region, it may not operate as specified in the specifications.
- To personal safety and proper maintenance, please read carefully this section and the caution statements on the monitor.

Location of the Caution Statements

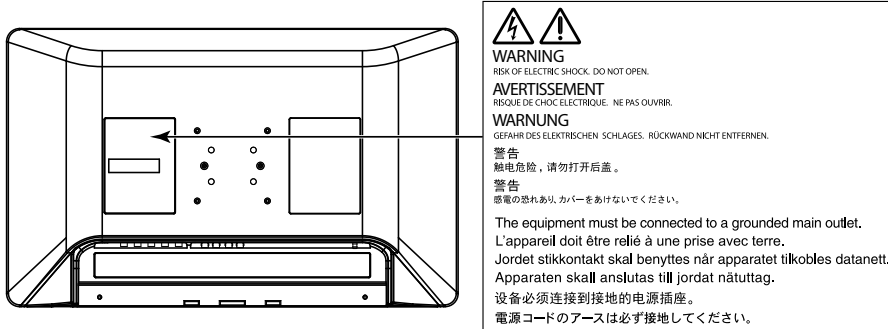

Symbols on the unit

Symbol	This symbol indicates	
	Power Switch:	Press to turn the monitor's power off.
	Power Switch:	Press to turn the monitor's power on.
	Direct current	
	Alerting electrical hazard	
	CAUTION:	Refer to "SAFETY SYMBOLS" (page 2).
	Potential equalization terminal	
	WEEE marking:	Product must be disposed of separately; materials may be recycled.
	CE marking:	EU conformity mark in accordance with the provisions of Council Directive 93/42/EEC and 2011/65/EU.
	Manufacturer	
	Date of manufacture	
RXonly	Caution: Federal law (USA) restricts this device to sale by or on the order of a licensed healthcare practitioner.	

WARNING

If the unit begins to emit smoke, smells like something is burning, or makes strange noises, disconnect all power connections immediately and contact your EIZO representative for advice. Attempting to use a malfunctioning unit may result in fire, electric shock, or equipment damage.

Do not disassemble or modify the unit.

Opening the cabinet or modifying the unit may result in fire, electric shock, or burn.



Use multiple units or prepare a standby unit.

Prepare an appropriate countermeasure in case the monitor fails.

Do not turn the bushing for fixing the AC adapter power cable.

Not doing so may result in fire, electric shock, or equipment damage.



Refer all servicing to qualified service personnel.

Do not attempt to service this product yourself as opening or removing covers may result in fire, electric shock, or equipment damage.

Keep small objects or liquids away from the unit.

Small objects accidentally falling through the ventilation slots into the cabinet or spillage into the cabinet may result in fire, electric shock, or equipment damage. If an object or liquid falls/spills into the cabinet, unplug the unit immediately. Have the unit checked by a qualified service engineer before using it again.



Install the unit correctly on a sturdy and stable location using an arm or stand.

According to the User's Manual of each product, install it correctly on a sufficiently strong desk or wall. If the unit is installed incorrectly, it may drop or fall over, and result in personal injury or equipment damage. If the unit falls, disconnect the power immediately and ask your local EIZO representative for advice. Do not continue using a damaged unit. Using a damaged unit may result in fire or electric shock.

Use the unit in an appropriate location.

Otherwise, fire, electric shock, or equipment damage may result.

- Do not place outdoors.
- Do not place in any form of transportation (ships, aircraft, trains, automobiles, etc.).
- Do not place in dusty or humid environments.
- Do not place in locations where water may be splashed on the screen (bathrooms, kitchens, etc.)
- Do not place in locations where steam comes in direct contact with the screen.
- Do not place near heat generating devices or humidifiers.
- Do not place in locations where the product is subject to direct sunlight.
- Do not place in environments with inflammable gas.
- Do not place in environments with corrosive gases (such as sulfur dioxide, hydrogen sulfide, nitrogen dioxide, chlorine, ammonia, and ozone)
- Do not place in environments with dust, components that accelerate corrosion in the atmosphere (such as sodium chloride and sulfur), conductive metals, and so on



To avoid danger of suffocation, keep the plastic packing bags away from babies and children.

Use the enclosed power cord and connect to the standard power outlet in your country.

Be sure to use within the rated voltage of the power cord. Otherwise, fire or electric shock may result.
Power supply: 100-240Vac 50/60Hz

WARNING

Use the enclosed AC adaptor.

The enclosed AC adaptor (AHM100PS24) is for use with this product only. Do not use the AC adaptor with other equipment. Do not use an AC adaptor designed for other devices with this product. Connecting to power sources that do not match the power ratings of the AC adaptor may result in fire or electric shock.

To disconnect the power cord or adapter power cable, grasp the plug firmly and pull.

Tugging on the cord or cable may damage and result in fire or electric shock.



The equipment must be connected to a grounded main outlet.

Failure to do so may result in fire or electric shock.



Use the correct voltage.

- The unit is designed for use with a specific voltage only. Connection to another voltage than specified in this "Instructions for Use" may cause fire, electric shock, or equipment damage.
Power supply: 100-240Vac 50/60Hz
- Do not overload your power circuit, as this may result in fire or electric shock.

Handle the power cord and AC adaptor with care.

Handle the power cord and AC adaptor with care.

Do not place heavy objects on, pull or tie the power cord or the AC adaptor. Using a damaged cord or AC adaptor may result in fire or electric shock.



The operator should not touch the patient while touching the product.

This product has not been designed to be touched by patients.

Never touch the plug, AC adaptor or power cord during a thunderstorm.

Touching them may result in electric shock.



Do not touch a damaged LCD panel directly with bare hands.

Liquid crystal is poisonous. If any part of your skin comes in direct contact with the panel, wash thoroughly. If liquid crystal enters your eyes or mouth, immediately flush with large amounts of water and seek medical attention.



CAUTION

Check the operational state before use.

- Begin use after ensuring that there are no problems with the displayed image.
 - When using multiple units, begin use after ensuring that the images are displayed appropriately.
 - When viewing 3D images, use 3D Polarized Eyewear, and ensure that the environmental requirements for viewing 3D images are satisfied.
-

Securely fix the cables / cords that have a fixing feature

If they are not fixed securely, the cables / codes may disconnect, and subsequently images may be cut off and your operations may be disrupted.

Handle with care when carrying the unit.

Disconnect the power cord and cables when moving the unit. Moving the unit with the power cord or cables attached is dangerous and may result in injury.

Carry or place the unit according to the correct specified methods.

- Monitors of size 30 inches and above are heavy. When unpacking and/or carrying the monitor, ensure at least two people are utilized.

Dropping the unit may result in injury or equipment damage.

Do not block the ventilation slots on the cabinet.

- Do not place any objects on the ventilation slots.
- Do not install the unit in a place with poor ventilation or inadequate space.
- Do not use the unit laid down or upside down.

Blocking the ventilation slots prevents proper airflow and may result in fire, electric shock, or equipment damage.



Do not touch the plug or AC adapter with wet hands.

Doing so may result in electrical shock.



Use an easily accessible power outlet.

This is to facilitate disconnecting the power in case of a problem.

Mind that the AC adapter becomes hot during use.

- Do not cover or place anything on top of the AC adapter. Do not place the AC adapter on top of things that trap heat such as carpets, blankets, etc. Keep the AC adapter away from direct sunlight and heat sources. Not doing so may result in fire.
 - Before moving the monitor, be sure to turn off the power switch, disconnect the power plug from the power outlet, and wait until it has cooled completely.
-

Do not suspend the AC adapter in midair.

Using the adapter while it is hanging suspended may result in fire or electrical shock.



Do not place the AC adapter in a vertical orientation.

Otherwise, dust or water may enter the adapter and may result in fire or electrical shock.



Do not subject the unit and the AC adapter to any impact due to dropping them or any other causes.

Using the adapter after it has been subjected to impact may result in fire or electrical shock.



Do not subject the LCD panel to strong impact.

Otherwise, glass will break and may result in injury.



 **CAUTION**

Periodically clean the area around the power plug and the ventilation slot of the monitor and the AC adapter.

Dust, water, or oil on the plug may result in fire.

Unplug the unit before cleaning it.

Cleaning the unit while it is plugged into a power outlet may result in electric shock.

If you plan to leave the unit unused for an extended period of time, disconnect the power cord from the wall socket after turning off the power switch for the safety and the power conservation.

Notice for this monitor

Intended use

This product is intended to be used to display (3D/2D) medical images, such as endoscopic surgery images.

Attention

- This product is not intended for diagnostic purpose.
- This product should be set to horizontal view mode when used for the purposes mentioned above.
- This product may not be covered by warranty for uses other than those described in this manual.
- The specifications stipulated in this manual are only applicable when the enclosed power cord is used.
- Only use optional products manufactured or specified by us with this product.

Precautions for Use

- Parts (such as the LCD panel) may deteriorate in the long-term. Periodically check that they are operating normally. Periodically check that they are operating normally.
- When the screen image is changed after displaying the same image for extended periods of time, an afterimage may appear. Use the screen saver or power save function to avoid displaying the same image for extended periods of time.
- If the monitor displays continuously over a long period of time, dark smudges or burn-in may appear. To maximize the life of the monitor, we recommend the monitor be turned off periodically.
- An afterimage may appear even after a short time period has elapsed depending on the displayed image. If this occurs, changing the image or leaving the power off for a few hours may solve the problem.
- The backlight of the LCD panel has a fixed lifetime. When the screen becomes dark or begins to flicker, please contact your local EIZO representative.
- The screen may have defective pixels or a small number of light dots on the screen. This is due to the characteristics of the panel itself, and is not a malfunction of the product.
- Do not press on the panel or edge of the frame strongly, as this may result in display malfunctions, such as interference patterns, etc. If pressure is continually applied to the panel, it may deteriorate or damage your panel. (If the pressure marks remain on the panel, leave the monitor with a black or white screen. The symptom may disappear.)
- Do not scratch or press on the panel with any sharp objects, as this may result in damage to the panel. Do not attempt to brush with tissues as this may scratch the panel.
- When the monitor is cold and brought into a room or the room temperature goes up quickly, dew condensation may occur on the interior and exterior surfaces of the monitor. In the same way, if the monitor is moved from a room with low temperature to a room with high temperature, dew condensation may form. In that case, do not turn the monitor on. Instead wait until the dew condensation disappears, otherwise it may cause some damage to the monitor.
- It takes about 30 minutes for the performance of electrical parts to stabilize. Please wait 30 minutes or more after the monitor power has been turned on or the monitor has recovered from the power saving mode, and then adjust the monitor.

Cleaning

Periodic cleaning is recommended to keep the monitor looking new and to prolong its operation lifetime. Gently wipe off any dirt on the cabinet or panel surface with a soft cloth soaked in a small amount of water or one of the chemicals listed below.

Chemicals that may be used for cleaning

Material name	Product name
Ethanol	Ethanol
Isopropyl alcohol	Isopropyl alcohol
Benzalkonium chloride	Welpas
Glutaral	Sterihyde
Glutaral	Cidex Plus28
Ammonia	Ammonia water
Hydrogen peroxide	Hydrogen peroxide solution
Alkyldiaminoethylglycine hydrochloride	Satenidin solution
Benzalkonium chloride	Zalkonin solution
Benzethonium chloride	Bezeton solution

Attention

- Do not use chemicals on a frequent basis. Chemicals such as alcohol and antiseptic solution may cause gloss variation, tarnishing, and fading of the cabinet or panel, and also quality deterioration of the image.
- Never use any thinner, benzene, wax, and abrasive cleaner, which may damage the cabinet or panel.
- Do not let chemicals come into direct contact with the monitor.

To use the monitor comfortably

- Look at the screen from a proper distance and from a proper angle.
- If you become fatigued or experience discomfort while viewing 3D images, stop using the monitor.

CONTENTS

PRECAUTIONS	3
● IMPORTANT	3
Notice for this monitor	8
Intended use	8
Precautions for Use	8
Cleaning	9
To use the monitor comfortably	9
CONTENTS	10
Chapter 1 Introduction	11
1-1. Features	11
1-2. Package Contents	12
1-3. Controls and Functions	12
Chapter 2 Installation / Connection	16
2-1. Before Installing the Product	16
● Installation Requirements	16
2-2. Installing the Product	17
2-3. Connecting the Power Cord	18
2-4. Connecting the Cables	19
2-5. Installing the Cable Cover	20
2-6. Turning On the Power	20
Chapter 3 If No Image Is Displayed	21
Chapter 4 Specifications	22
4-1. Specifications List	22
4-2. Displayable Input Signals (2D)	24
4-3. Displayable Input Signals (3D)	25
4-4. Optional Accessories	25
Appendix	26
Medical Standard	26
EMC Information	27
Warning for Radio interference	31

Chapter 1 Introduction

1-1. Features

● High-quality and high-resolution Full HD LCD panel

- The IPS panel enables high-resolution, high-quality medical images to be displayed.
- Front protection panel fitted
- LED Backlight
- Optical bonding for high visibility

● Supporting 3D display

- The Xpol® polarized filter is installed on the LCD panel, enabling a stereoscopic view with 3D Polarized Eyewear.
(Xpol® is a registered trademark of Arisawa Mfg. Co., Ltd.)
- Supports major 3D image input formats.
SIDE BY SIDE
LINE BY LINE
TOP AND BOTTOM
SIMUL
- Parallax adjustment function (3D display only)
Binocular parallax adjustment is possible during 3D display.

● Supporting multiple I/O

- 3G-SDI signal: 2 inputs / 2 outputs (Also supports dual-stream system)
- DVI signal: 2 inputs / 1 output
Simultaneous input of two types of HD images is possible.
- Component / Analog RGB signal: 1 input / 1 output
- S VIDEO signal: 1 input / 1 output
- Composite video signal: 1 input / 1 output
- Analog RGB signal: 1 input

● Other functions

- 2 screen display function
Parallel display of two input images is possible.
Two modes, P in P and P out P, are available.
Switching of display size is possible.
- Gamma switch function
Gamma function is installed according to usage.
Simplified DICOM image is supported.
- Color temperature switch function
Color temperature switch function is installed according to usage.
- External remote function
Remote control using RS-232C or GPI terminal is possible.
- Input signal direct switching can be assigned to a function button.
- Protection structure of IP32 (Excluding the AC adapter)

1-2. Package Contents

Check that all of the following items are contained in the package.

Note

- It is recommended that the box and packing materials be stored so that they can be used to move or transport this product.

- Monitor
- Power cord
- AC adapter (AHM100PS24)
- Cable cover (with screws)
- Monitor attachment screw (M4×12) x 4
- 3D fogless polarized glasses x 3
- User's Manual CD
- Instructions for Use

1-3. Controls and Functions

AC adapter

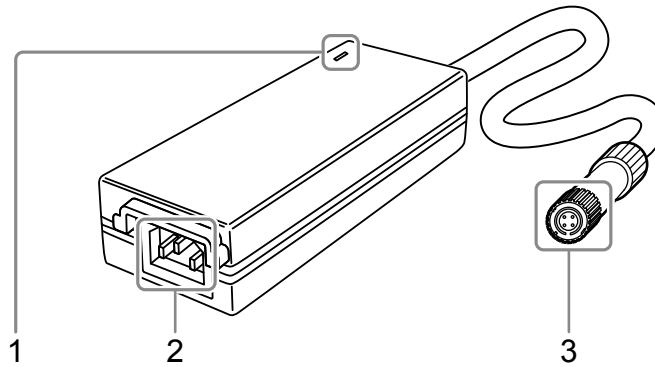

1. Main power indicator	Depending on the operation status of the main power supply, the indicator of the AC adapter turns on or off. Lit up: Power on, Not lit up: Power off
2. AC IN terminal	Connects the power cord.
3. DC OUT terminal	Connect to the DC IN terminal on the monitor.

Front

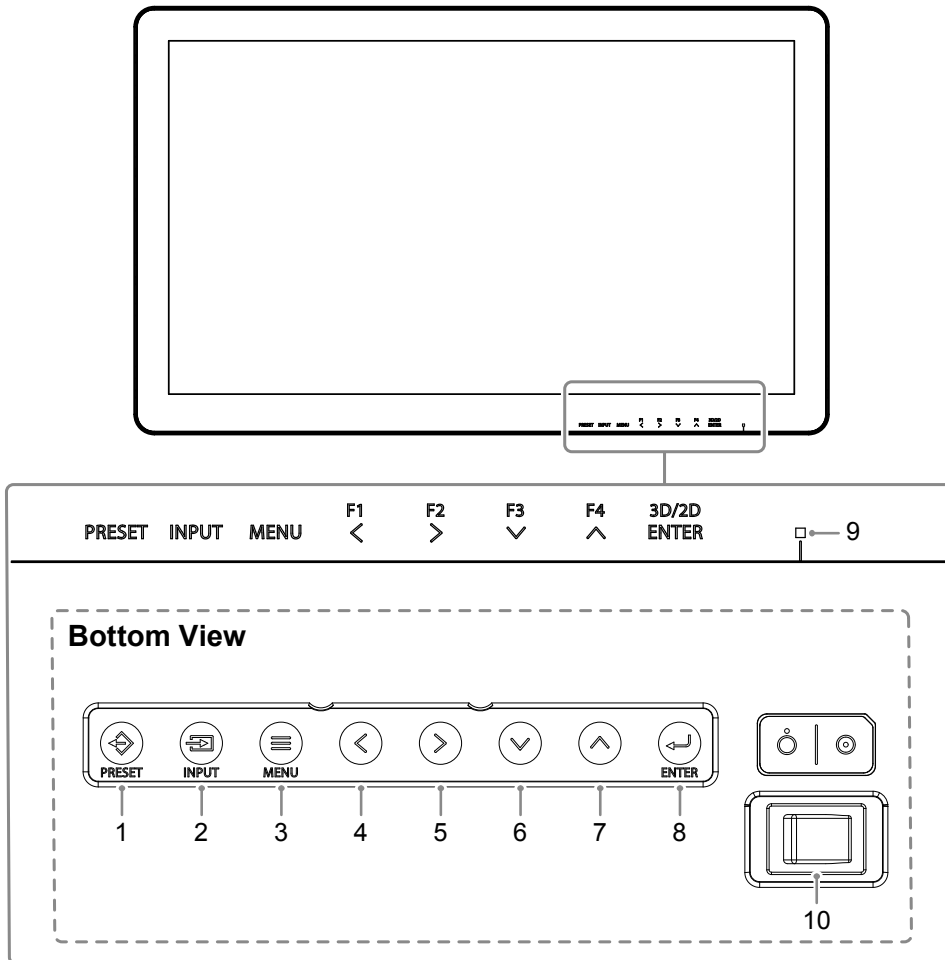

1. (PRESET) button	Displays the preset menu.
2. (INPUT) button	Displays the input select menu.
3. (MENU) button	Displays the main menu.
4. (F1) button	Executes the function assigned to this button. Select items in the menu screen.
5. (F2) button	
6. (F3) button	
7. (F4) button	
8. (3D/2D, ENTER) button	Switches the 3D and 2D displays. Select items in the menu screen.
9. Power indicator	The indicator color differs depending on the monitor's operation status. Green: Monitor in operation, Orange: Power saving mode, Off: Power off
10. Power switch	Turns the power on or off. : On, : Off

Rear

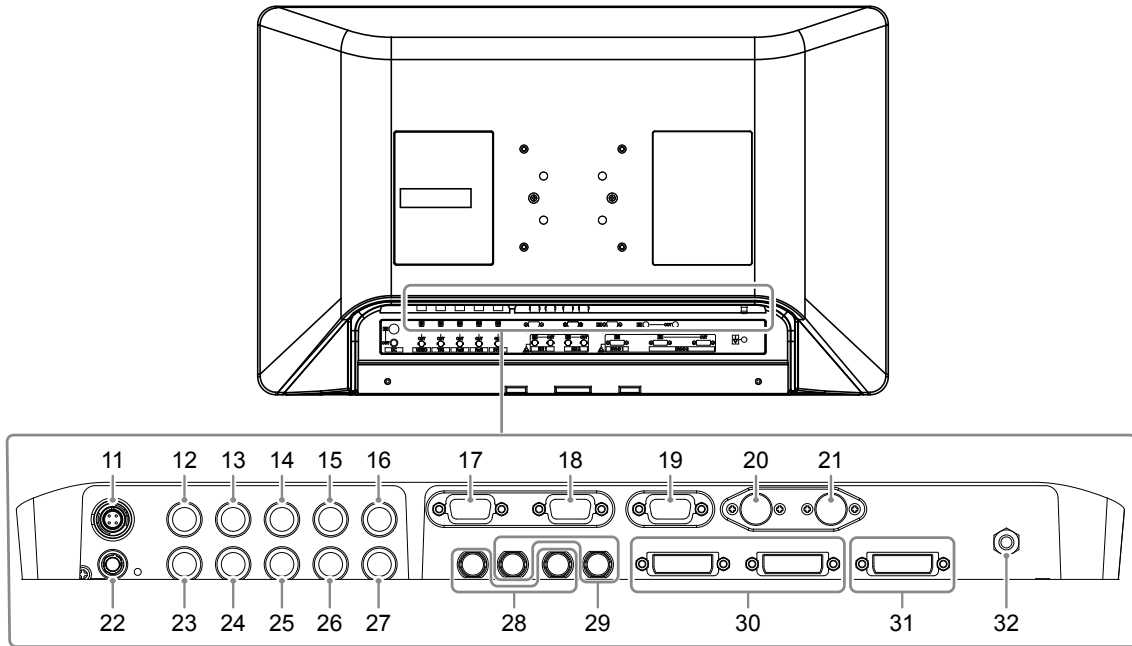

11. DC IN terminal	Connects the DC OUT terminal of the AC adapter.
12. VIDEO input terminal (BNC type)	Connects devices having Composite video output terminals.
13. Y/G input terminal (BNC type)	Connects devices having Y (luminance) for component output, or devices having G for RGB component.
14. P_B/B input terminal (BNC type)	Connects devices having P _B /C _B (blue differential) for component output, or devices having B for RGB output.
15. P_R/R input terminal (BNC type)	Connects devices having P _R /C _R (red differential) for component output, or devices having R for RGB output.
16. SYNC input terminal (BNC type)	When this product is operated externally synchronized, connects devices having C.SYNC standard signal output.
17. GPI input terminal (D-Sub 9pin)	Connects to GPI supported external devices. By assigning functions to each terminal, this product can be controlled by external devices.
18. RS-232C terminal (D-Sub 9pin)	Controls this product by connecting it to an external device. Input switching and various adjustments are possible from connected external devices.
19. HD15 input terminal (D-Sub15 pin (mini))	Connects devices having a synchronous signal with Analog RGB output such as computers.
20. S VIDEO input terminal (4pin mini DIN)	Connects devices having S VIDEO output terminals.
21. S VIDEO output terminal (4pin mini DIN)	The signal input to S VIDEO input terminal is output as is.

Rear (Continued)

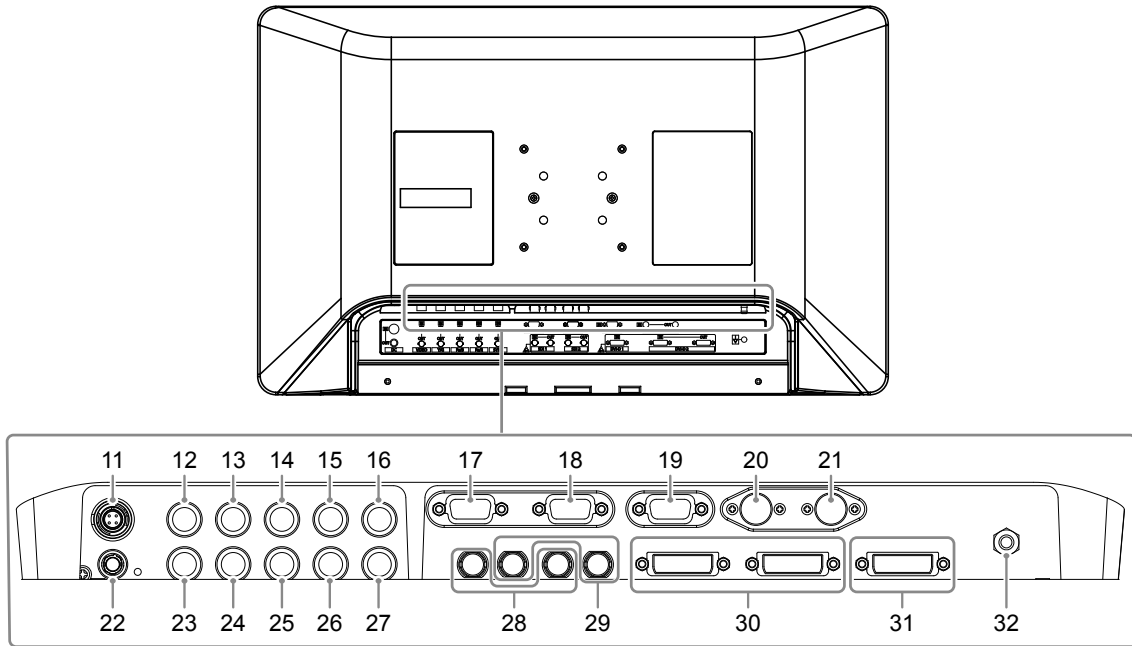

22. DC OUT terminal	Used to supply 5V power to a peripheral. Attention • No device making contact with a patient may be connected to the DC OUT terminal.
23. VIDEO input terminal (BNC type)	The signal input to VIDEO input terminal is output as is.
24. Y/G input terminal (BNC type)	The signal input to Y/G input terminal is output as is.
25. P_B/B input terminal (BNC type)	The signal input to P _B /B input terminal is output as is.
26. P_R/R input terminal (BNC type)	The signal input to P _R /R input terminal is output as is.
27. SYNC input terminal (BNC type)	The signal input to SYNC input terminal is output as is.
28. SDI 1/2 input terminal (BNC type)	Connects devices having SDI output terminals.
29. SDI 1/2 output terminal (BNC type)	The signal input to SDI 1/2 input terminal is output as is.
30. DVI-D 1/2 input terminal (DVI-D)	Connects devices having DVI-D output.
31. DVI-D 2 output terminal (DVI-D)	The signal input to DVI-D 2 input terminal is output as is.
32. ⚡ Potential equalization terminal	This is a terminal for ensuring equal potential between the monitor and other devices. Connects equipotential plugs.

Note

- Furthermore, for a VIDEO, Y/G, P_B/B, P_R/R input terminal, when not connected to any output terminal, terminated with internal 75 Ω. If a cable is connected to the output terminal, the internal terminal automatically opens. When a cable connected to the output terminal is not connected to a video device, and when the connected video device is not terminated with 75 Ω, the signal level becomes too large and cannot be displayed correctly.

Chapter 2 Installation / Connection

2-1. Before Installing the Product

Carefully read "PRECAUTIONS" (page 3) and always follow the instructions.

When introducing this product, execute thorough operational testing (of the system, cables, arms, etc.) in the environment where the product will be used.

● Installation Requirements

When installing the monitor, ensure that there is adequate space around the sides, back, top, and bottom of the monitor.

Attention

- Position the monitor so that there is no light to interfere with the screen.
 - Do not use any materials or objects that will cover the monitor or the AC adapter.
-

2-2. Installing the Product

This product should be installed using an arm or stand.

Attention

- When installing, do so by carefully following the information in the User's Manual about the arm or stand.
- Ensure the following and select components that comply with the VESA standards.
 - Clearance between the screw holes: 100 mm × 100 mm
 - Strong enough to support weight of the monitor unit (excluding the stand) and attachments such as cables.
- Use the supplied screws when installing the product.
- When using an arm or stand, attach it to meet the following tilt angles of the monitor.
 - Up 45°, down 45°
- Connect the cables after attaching an arm or stand.
- The monitor, arm, and stand are heavy. Dropping them may result in injury or equipment damage.
- Periodically check the tightness of the screws. If not sufficiently tight, the monitor may detach from the arm, which may result in injury or equipment damage.

1. Attach the arm or stand to the back of the monitor by aligning the four screw holes and secure the arm or stand using the screws supplied with the monitor.

Screw tightening torque: 1.0 N·m - 1.4 N·m

Tool required: Phillips screwdriver (#2)

Rear

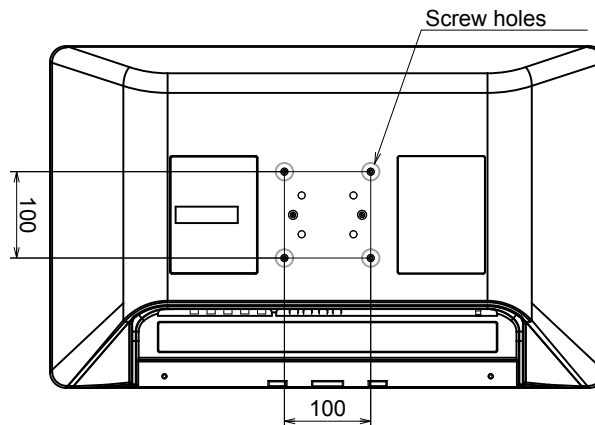

Using the supplied screws

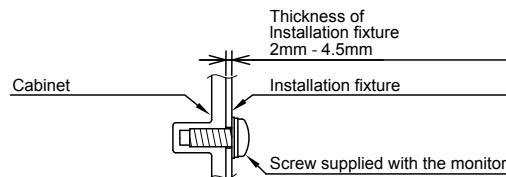

Using commercially available screws

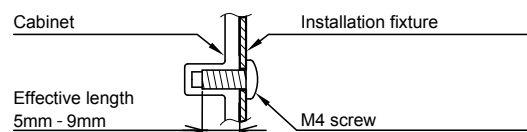

2-3. Connecting the Power Cord

Attention

- Turn off the monitor before connecting it.
- When removing the power cord, always remove the power plug from the power outlet first.

1. Connect the power cord to the AC IN terminal on the AC adapter.

Insert the power cord all the way to the back.

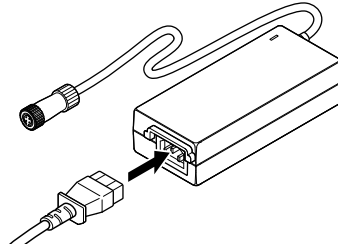

2. Connect the DC OUT terminal of the AC adapter to the DC IN terminal on the monitor.

Align the connector shape with the port shape, rotate the lock ring clockwise, and fix it securely.

Note

- If the lock ring does not rotate easily, push it in further and retry it.

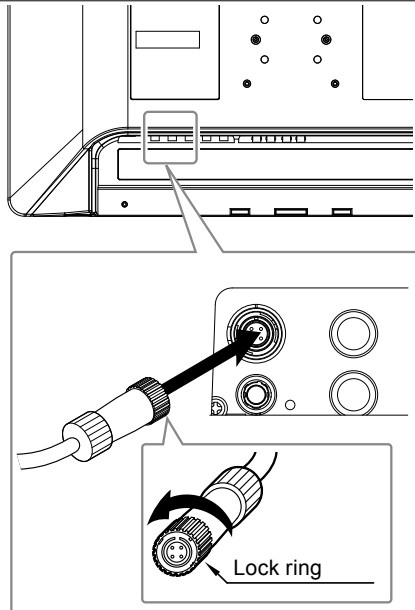

3. Check the rated value on the AC adapter and connect the power plug to the power outlet.

Attention

- Do not install the AC adapter in a vertical position with the power plug inserted from the top.

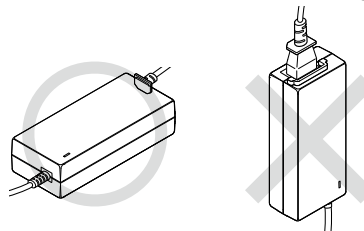

OK: Horizontal position NG: Vertical position

- Secure the adapter using a banding band such as a cable tie as necessary to prevent it from dropping.

2-4. Connecting the Cables

1. Connect the cables appropriate for the device to be used.

Attention

- Do not use damaged cables.
- Do not connect or disconnect the signal cable while the monitor is turned on.
- The terminal parts of the SDI terminal and DVI-D terminal are vulnerable to static electricity, so be sure to work with care at installation. When working with the monitor, be sure to observe the following.
 - Do not touch the connector pins.
 - Do not touch pins at the end of any cable connected to a connector.
 - Take anti-static precautions such as using an anti-static wrist strap when working.

Note

- The warning label is displayed as shown in the right-hand diagram in proximity to the SDI terminal and DVI-D terminal.



2-5. Installing the Cable Cover

1. Align the cable cover on the back of the monitor in such a way that the cables can go through the cable outlet port.
2. Insert the cable cover tabs into the grooves in the monitor.
3. Tighten the screws at the left and right holes on the bottom side of the monitor.

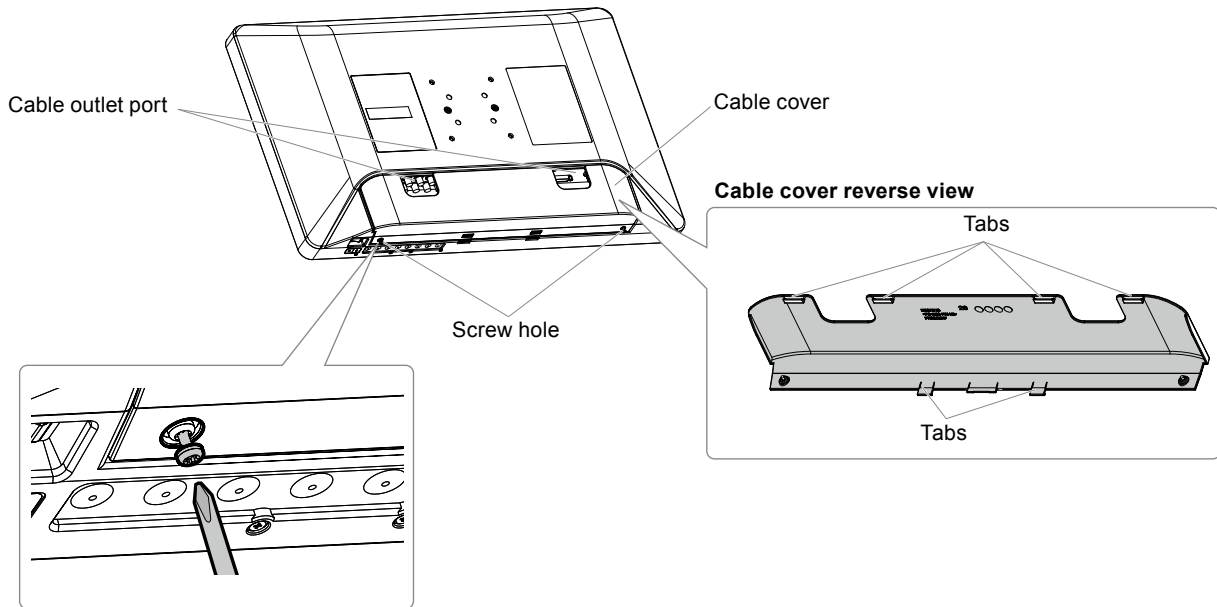

Attention

- Ensure that cables are not pinched between the cable cover and the monitor.
- Securely tighten the screws in the two locations. (Screw tightening torque: 0.4 N·m to 0.7 N·m)
- Avoid subjecting the terminal and cable to stress.
- Do not pack or transport if the cable cover is attached.

2-6. Turning On the Power

1. Turn on the power switch at the bottom of the monitor, and then turn on the monitor.

The power indicator in front of the monitor lights up green.

If the indicator does not light up, see “Chapter 3 If No Image Is Displayed” (page 21).

Note

- If the power switch at the bottom of the monitor is turned off, the monitor is turned off.

Chapter 3 If No Image Is Displayed

Problem	Possible cause and remedy
<p>1. No picture</p> <ul style="list-style-type: none"> Power indicator does not light up. 	<ul style="list-style-type: none"> Check whether the power cord is connected properly. Check whether the DC OUT terminal and the DC IN terminal are connected properly. Turn on the power switch. Check whether the main power indicator of the AC adapter is on.
<p>2. The message below appears.</p> <p>• This message appears when no signal is input. Example:</p> <div data-bbox="300 667 608 790" style="background-color: black; color: white; padding: 5px; text-align: center;"> <p>SDI 1 No Signal</p> </div> <p>• The message indicates that the input signal is outside the specified frequency range. Example:</p> <div data-bbox="300 913 608 1037" style="background-color: black; color: white; padding: 5px; text-align: center;"> <p>DVI-D 1 Not Supported</p> </div>	<p>This message appears when the signal is not input correctly even though the monitor is functioning properly.</p> <ul style="list-style-type: none"> The message shown at left may appear, because some devices to be connected do not output the signal immediately after power-on. Check whether the device to be connected is turned on. Check whether the signal cable is connected properly. Turn off the power, and then turn it on again. <p>• Check whether the device to be connected is configured to meet the resolution and vertical scan frequency requirements of the monitor.</p> <ul style="list-style-type: none"> Reboot the device to be connected.

Chapter 4 Specifications

4-1. Specifications List

Monitor

LCD Panel		
Type	Color (IPS)	
Backlight	LED	
Size	66.1 cm (26 inch)	
Resolution (H x V)	1920 × 1080	
Display Size (H x V)	576 mm × 324 mm	
Pixel Pitch	0.3 mm	
Display Colors	8-bit: 16.77 million colors 10-bit (SDI only): 1073.74 million colors (Max.)	
Viewing Angles (H / V, typical)	178° / 178°	
Brightness (typical)	580 cd/m ²	
Response Time (typical)	18 ms (black -> white -> black)	
Contrast Ratio (typical)	1400:1	
Video Signals		
Input Terminals	DVI (DVI-D) × 2	Single link, HDCP support
	SDI (BNC) × 2	3G / HD / SD-SDI
	Analog RGB (D-Sub15 pin (mini)) × 1	R / G / B : 0.7 Vp-p, 75 Ω HD / VD : TTL (High impedance)
	Component / Analog RGB (BNC × 4) × 1	Y/G: 1.0 Vp-p, 75 Ω (including synchronous signals) P _B /B: 0.7 Vp-p, 75 Ω P _R /R: 0.7 Vp-p, 75 Ω Sync: 0.3 Vp-p to 4.0Vp-p, 75 Ω
	Composite video (BNC) × 1	1.0 Vp-p, 75 Ω
	S VIDEO (4pin mini DIN) × 1	Brightness signal: 1.0 Vp-p, 75 Ω Color signal: 0.286 Vp-p, 75 Ω
Output Terminal	DVI (DVI-D) × 1	Single link, DVI-D (HDCP unsupported)
	SDI (BNC) × 2	3G / HD / SD-SDI
	Component / Analog RGB (BNC × 4) × 1	Y/G: 1.0 Vp-p, 75 Ω (including synchronous signals) P _B /B: 0.7 Vp-p, 75 Ω P _R /R: 0.7 Vp-p, 75 Ω Sync: 0.3 Vp-p to 4.0 Vp-p, 75 Ω
	Composite video (BNC) × 1	1.0 Vp-p, 75 Ω
	S VIDEO (4pin mini DIN) × 1	Brightness signal: 1.0 Vp-p, 75 Ω Color signal: 0.286 Vp-p, 75 Ω
Monitor Control		
Monitor Control Terminal	RS-232C (D-Sub 9 pin) × 1	
	GPI (D-Sub 9 pin) × 1	
Power		
Input	DC 24 V ± 10 %, 3.6 A	
Maximum Power Consumption	Max. 86.4 W	
DC OUT terminal	5 V, 1 A	
Physical Specifications		
Outside dimensions (W × H × D)	643 mm × 396 mm × 80 mm	
Net Weight	Approx. 8.5 kg	
Protection structure	IP32	

Operating Environmental Requirements	
Temperature	0 °C to 35 °C (32 °F to 95 °F)
Humidity	20 % to 85 % R.H. (no condensation)
Air Pressure	540 hPa - 1060 hPa
Transportation / Storage Environmental Requirements	
Temperature	-20 °C to 60 °C (-4 °F to 140 °F)
Humidity	10 % to 90 % R.H. (no condensation)
Air Pressure	540 hPa to 1060 hPa

AC adapter

Power	
Input	100 - 240 VAC ±10 %, 50 / 60 Hz, 1.2 A
Maximum Power Consumption	Max. 95 W
Physical Specifications	
Outside dimensions (W × H × D)	160 mm × 37 mm × 64 mm
Net Weight	Approx. 0.7 kg
Operating Environmental Requirements	
Temperature	0 °C to 35 °C (32 °F to 95 °F)
Humidity	20 % to 85 % R.H. (no condensation)
Air Pressure	540 hPa - 1060 hPa
Transportation / Storage Environmental Requirements	
Temperature	-20 °C to 60 °C (-4 °F to 140 °F)
Humidity	10 % to 90 % R.H. (no condensation)
Air Pressure	540 hPa to 1060 hPa

4-2. Displayable Input Signals (2D)

√: Supported

Signal name	Horizontal Frequency (kHz)	Vertical Frequency (Hz)	VIDEO S VIDEO	SDI 1 SDI 2	RGB / YP _B P _R	RGB / YP _B P _R HD15		DVI 1 DVI 2
					YP _B P _R mode	RGB-VIDEO mode	RGB-PC mode	
NTSC	15.734	59.940	√	-	-	-	-	-
PAL	15.625	50.000	√	-	-	-	-	-
480 / 60i	15.734	59.940	-	√	√	√	√	√
480 / 60p	31.469	59.940	-	-	√	√	√ ^{*2}	√
576 / 50i	15.625	50.000	-	√	√	√	√	√
576 / 50p	31.250	50.000	-	-	√	√	√	√
720 / 60p	45.000	60.000	-	√	√	√	√	√
720 / 50p	37.500	50.000	-	√	√	√	√	√
1080 / 60i	33.750	60.000	-	√	√	√	√	√
1080 / 60p	67.500	60.000	-	√	√	√	√ ^{*2}	√
1080 / 50i	28.125	50.000	-	√	√	√	√	√
1080 / 50p	56.250	50.000	-	√	√	√	√	√
1080 / 30p	33.750	30.000	-	√	√	√	√	√
1080 / 25p	28.125	25.000	-	√	√	√	√	√
1080 / 24p	27.000	24.000	-	√	√	√	√	√
1080 / 24PsF	27.000	48.000	-	√	√	√	√	-
720 x 400@70Hz	31.469	70.087	-	-	-	√	√	-
640 x 480@60Hz	31.469	59.940	-	-	-	√ ^{*1}	√	√
640 x 480@72Hz	37.861	72.809	-	-	-	√	√	-
640 x 480@75Hz	37.500	75.000	-	-	-	√	√	-
640 x 480@85Hz	43.269	85.008	-	-	-	√	√	-
800 x 600@56Hz	35.156	56.250	-	-	-	√	√	-
800 x 600@60Hz	37.879	60.317	-	-	-	√	√	√
800 x 600@72Hz	48.077	72.188	-	-	-	√	√	-
800 x 600@75Hz	46.875	75.000	-	-	-	√	√	-
800 x 600@85Hz	53.674	85.061	-	-	-	√	√	-
1024 x 768@60Hz	48.363	60.004	-	-	-	√ ^{*3}	√ ^{*3}	√
1024 x 768@70Hz	56.476	70.069	-	-	-	√	√	-
1024 x 768@75Hz	60.023	75.029	-	-	-	√	√	-
1024 x 768@85Hz	68.677	84.997	-	-	-	√	√	-
1152 x 864@75Hz	67.500	75.000	-	-	-	√	√	-
1280 x 768@60Hz	47.776	59.870	-	-	-	√ ^{*3}	√ ^{*3}	√
1280 x 800@60Hz	49.702	59.810	-	-	-	√	√	√
1280 x 960@60Hz	60.000	60.000	-	-	-	√	√	√
1280 x 1024@60Hz	63.981	60.020	-	-	-	√	√	√
1280 x 1024@75Hz	79.976	75.025	-	-	-	√	√	-
1400 x 1050@60Hz	65.317	59.978	-	-	-	√ ^{*3}	√ ^{*3}	√
1440 x 900@60Hz	55.935	59.887	-	-	-	√	√	√
1680 x 1050@60Hz	65.290	59.954	-	-	-	√ ^{*3}	√ ^{*3}	√
1600 x 1200@60Hz	75.000	60.000	-	-	-	√ ^{*3}	√ ^{*3}	√
1920 x 1080@60Hz	67.500	60.000	-	-	-	√ ^{*1}	√	√ ^{*4}
1920 x 1200@60Hz	74.038	59.950	-	-	-	√ ^{*3}	√ ^{*3}	√

*1 If a 640 × 480@60Hz signal is input and RGB-VIDEO mode is selected, it is recognized as 480/60p.

If a 1920 × 1080@60Hz signal is input and RGB-VIDEO mode is selected, it is recognized as 1080/60p.

*2 If a 480/60p signal is input and RGB-PC mode is selected, it is recognized as 640 × 480@60Hz.

If a 1080/60p signal is input and RGB-PC mode is selected, it is recognized as 1920 × 1080@60Hz.

*3 When the resolution of the input signal is different from that of the screen display, change the setting value of the signal format (analog adjustment).

"4:3": 1024 × 768@60Hz, 1600 × 1200@60Hz, 1400 × 1050@60Hz

"Wide": 1280 × 768@60Hz, 1920 × 1200@60Hz, 1680 × 1050@60Hz

*4 A 1920 × 1080@60Hz signal of DVI-D is recognized as 1080/60p.

Attention

- Input Sync on Green or composite Sync (VBS) as sync signal into the RGB input terminal. Some PCs cannot display images.

Note

- The input signal above is a displayable input signal when using a single product without connecting an output.

4-3. Displayable Input Signals (3D)

√: Supported

Signal name	Horizontal Frequency (kHz)	Vertical Frequency (Hz)	SDI 1 SDI 2	DVI-D 1 DVI-D 2
720 / 60p	45.000	60.000	√	√
720 / 50p	37.500	50.000	√	√
1080 / 60i	33.750	60.000	√	√
1080 / 60p	67.500	60.000	√	√
1080 / 50i	28.125	50.000	√	√
1080 / 50p	56.250	50.000	√	√
1080 / 30p	33.750	30.000	√	√
1080 / 25p	28.125	25.000	√	√
1080 / 24p	27.000	24.000	√	√
1080 / 24PsF	27.000	48.000	√	-
1024 x 768@60Hz	48.363	60.004	-	√
1280 x 1024@60Hz	63.981	60.020	-	√

4-4. Optional Accessories

The following accessories are available separately.

3D fogless polarized glasses	H3G01
Stand	HST01

Appendix

Medical Standard

- It shall be assured that the final system is in compliance to IEC60601-1-1 requirement.
- Power supplied equipment can emit electromagnetic waves, that could influence, limit or result in malfunction of the monitor. Install the equipment in a controlled environment, where such effects are avoided.

Classification of Equipment

- Type of protection against electric shock : Class I
- EMC class: EN60601-1-2:2015 Group 1 Class B
- Classification of medical device (MDD 93/42/EEC): Class I
- Mode of operation : Continuous
- IP Class : IP32

EMC Information

The EX2620-3D has a performance that appropriately displays images.

Environments of Intended Use

The EX2620-3D is intended to be used in Professional healthcare facility environments such as clinics and hospitals (including use in the vicinity of high-frequency surgical equipment such as electrosurgical knives).

The following environments are not suitable for the EX2620-3D to be used:

- Home healthcare environments
- In the vicinity of short-wave therapy equipments
- RF shielded room of the medical equipment systems for MRI
- In shielded location Special environments
- Installed in vehicles including ambulances.
- Other special environments

WARNING

The EX2620-3D requires special precautions regarding EMC and need to be installed. You need to carefully read EMC Information and the "PRECAUTIONS" section in this document, and observe the following instructions when installing and operating the product.

The EX2620-3D should not be used adjacent to or stacked with other equipment. If adjacent or stacked use is necessary, the equipment or system should be observed to verify normal operation in the configuration in which it will be used.

When using a portable RF communication equipment, keep it 30 cm (12 inches) or more away from any part, including cables, of the EX2620-3D. Otherwise, degradation of the performance of this equipment could result.

Anyone who connects additional equipment to the signal input part or signal output parts, configuring a medical system, is responsible that the system complies with the requirements of IEC/EN60601-1-2.

Images may be distorted if the product is used near a device such as high-frequency surgical equipment. Check in advance that no problems will occur during use.

Be sure to use cables that satisfy the following requirements.

Use of cables that do not satisfy the requirements could result in increased electromagnetic emissions, reduced electromagnetic immunity of this equipment, and incorrect operations.

Cables	Max. Cable Length	Shielding
AC Mains input	2 m	Un-Shielded
DC Cord	17.5 m	Shielded
BNC Cable (SDI)	30 m	Shielded
DVI Cable	5 m	Shielded
BNC Cable (Composite)	5 m	Shielded
D-Sub Cable	5 m	Shielded
S VIDEO Cable	5 m	Shielded
RS-232C Cable	5 m	Shielded

Technical Descriptions

Electromagnetic emissions		
The EX2620-3D is intended for use in the electromagnetic environment specified below. The customer or the user of the EX2620-3D should assure that it is used in such an environment.		
Emission test	Compliance	Electromagnetic environment - Guidance
RF emissions CISPR11 / EN55011	Group 1	The EX2620-3D uses RF energy only for its internal function. Therefore, its RF emission are very low and are not likely to cause any interference in nearby electronic equipment.
RF emissions CISPR11 / EN55011	Class B	The EX2620-3D is suitable for use in all establishments, including domestic establishments and those directly connected to the public low-voltage power supply network that supplies buildings used for domestic purposes.
Harmonic emissions IEC / EN61000-3-2	Class D	
Voltage fluctuations / flicker emissions IEC / EN61000-3-3	Complies	

Electromagnetic immunity			
The EX2620-3D has been tested at the following compliance levels according to the testing requirements for professional healthcare facility environments defined in IEC / EN60601-1-2. Customers and users of the EX2620-3D must ensure that the EX2620-3D is used in the following environments:			
Immunity test	Test level for professional healthcare facility environments	Compliance level	Electromagnetic environment - Guidance
Electrostatic discharge (ESD) IEC / EN61000-4-2	±8 kV contact discharge ±15 kV air discharge	±8 kV contact discharge ±15 kV air discharge	Floors should be wood, concrete or ceramic tile. If floors are covered with synthetic material, the relative humidity should be at least 30%.
Electrical fast transients / bursts IEC / EN61000-4-4	±2 kV power lines ±1 kV input / output lines	±2 kV power lines ±1 kV input / output lines	Mains power quality should be that of a typical commercial or hospital environment.
Surges IEC / EN61000-4-5	±1 kV line to line ±2 kV line to ground	±1 kV line to line ±2 kV line to ground	Mains power quality should be that of a typical commercial or hospital environment.
Voltage dips, short interruptions and voltage variations on power supply input lines IEC / EN61000-4-11	0 % U_T (100 % dip in U_T) 0.5 cycles and 1 cycle 70 % U_T (30 % dip in U_T) 25 cycles 0 % U_T (100 % dip in U_T) 5 sec	0 % U_T (100 % dip in U_T) 0.5 cycles and 1 cycle 70 % U_T (30 % dip in U_T) 25 cycles 0 % U_T (100 % dip in U_T) 5 sec	Mains power quality should be that of a typical commercial or hospital environment. If the user of the EX2620-3D requires continued operation during power mains interruptions, it is recommended that the EX2620-3D be powered from an uninterruptible power supply or a battery.
Power frequency magnetic fields IEC / EN61000-4-8	30 A/m (50 / 60 Hz)	30 A/m	Power frequency magnetic fields should be at levels characteristic of a typical location in a typical commercial or hospital environment. The product should be kept at least 15 cm away from the source of power frequency magnetic fields during use.

Electromagnetic immunity			
The EX2620-3D has been tested at the following compliance levels according to the testing requirements for professional healthcare facility environments defined in IEC / EN60601-1-2. Customers and users of the EX2620-3D must ensure that the EX2620-3D is used in the following environments:			
Immunity test	Test level for professional healthcare facility environments	Compliance level	Electromagnetic environment - Guidance
Conducted disturbances induced by RF fields IEC / EN61000-4-6	Portable and mobile RF communications equipment should be used no closer to any part of the EX2620-3D, including cables, than the recommended separation distance calculated from the equation applicable to the frequency of the transmitter. Recommended separation distance 3 Vrms 150 kHz - 80 MHz	3 Vrms	$d = 1.2\sqrt{P}$
Radiated RF fields IEC / EN61000-4-3	6 Vrms ISM bands between 150 kHz and 80 MHz 3 V/m 80 MHz - 2.7 GHz	6 Vrms 3 V/m	$d = 1.2\sqrt{P}$, 80 MHz - 800 MHz $d = 2.3\sqrt{P}$, 800 MHz - 2.7 GHz Where "P" is the maximum output power rating of the transmitter in watts (W) according to the transmitter manufacturer and "d" is the recommended separation distance in meters (m). Field strengths from fixed RF transmitters, as determined by an electromagnetic site survey ^{a)} , should be less than the compliance level in each frequency range ^{b)} . Interference may occur in the vicinity of equipment marked with the following symbol. 
Note 1	U _T is the a.c. mains voltage prior to application of the test level.		
Note 2	At 80 MHz and 800 MHz, the higher frequency range applies.		
Note 3	Guidelines regarding conducted disturbances induced by RF fields or radiated RF fields may not apply in all situations. Electromagnetic propagation is affected by absorption and reflection from structures, objects and people.		
Note 4	The ISM bands between 150 kHz and 80 MHz are 6.765 MHz to 6.795 MHz, 13.553 MHz to 13.567 MHz, 26.957 MHz to 27.283 MHz, and 40.66 MHz to 40.70 MHz.		
^{a)}	Field strengths from fixed transmitters, such as base stations for radio (cellular/cordless) telephones and land mobile radios, amateur radio, AM and FM radio broadcast and TV broadcast cannot be predicted theoretically with accuracy. To assess the electromagnetic environment due to fixed RF transmitters, an electromagnetic site survey should be considered. If the measured field strength in the location in which the EX2620-3D is used exceeds the applicable RF compliance level above, the EX2620-3D should be observed to verify normal operation. If abnormal performance is observed, additional measures may be necessary, such as reorienting or relocating the EX2620-3D.		
^{b)}	Over the frequency range 150 kHz to 80 MHz, field strengths should be less than 3 V/m.		

Recommended separation distances between portable or mobile RF communication equipment and the EX2620-3D

The EX2620-3D is intended for use in an electromagnetic environment in which radiated RF disturbances are controlled. The customer or the user of the EX2620-3D can help prevent electromagnetic interference by maintaining a minimum distance between portable and mobile RF communications equipment (transmitters) and the EX2620-3D. Immunity to proximity fields from following RF wireless communication equipments has been confirmed:

Test frequency (MHz)	Bandwidth ^{a)} (MHz)	Service ^{a)}	Modulation ^{b)}	Maximum power (W)	Minimum separation distance (m)	IEC / EN60601 test level (V/m)	Compliance level (V/m)
385	380 - 390	TETRA 400	Pulse modulation ^{b)} 18 Hz	1.8	0.3	27	27
450	430 - 470	GMRS 460, FRS 460	FM ±5 kHz deviation 1 kHz sine	2	0.3	28	28
710 745 780	704 - 787	LTE Band 13, 17	Pulse modulation ^{b)} 217 Hz	0.2	0.3	9	9
810 870 930	800 - 960	GSM 800 / 900, TETRA 800, iDEN 820 CDMA 850, LTE Band 5	Pulse modulation ^{b)} 18 Hz	2	0.3	28	28
1720 1845 1970	1700 - 1990	GSM 1800; CDMA 1900; GSM 1900; DECT; LTE Band 1, 3, 4, 25; UMTS	Pulse modulation ^{b)} 217 Hz	2	0.3	28	28
2450	2400 - 2570	Bluetooth, WLAN, 802.11 b/g/n, RFID 2450, LTE Band 7	Pulse modulation ^{b)} 217 Hz	2	0.3	28	28
5240 5500 5785	5100 - 5800	WLAN 802.11 a/n	Pulse modulation ^{b)} 217 Hz	0.2	0.3	9	9

a) For some services, only the uplink frequencies are included.

b) carrier are modulated using a 50 % duty cycle square wave signal.

The EX2620-3D is intended for use in an electromagnetic environment in which radiated RF disturbances are controlled. For other portable and mobile RF communication equipments (transmitters), minimum distance between portable and mobile RF communications equipment (transmitters) and the EX2620-3D as recommended below, according to the maximum output power of the communications equipment.

Rated maximum output power of transmitter (W)	Separation distance according to frequency of transmitter (m)		
	150 kHz to 80 MHz $d = 1.2\sqrt{P}$	80 MHz to 800 MHz $d = 1.2\sqrt{P}$	800 MHz to 2.7 GHz $d = 2.3\sqrt{P}$
0.01	0.12	0.12	0.23
0.1	0.38	0.38	0.73
1	1.2	1.2	2.3
10	3.8	3.8	7.3
100	12	12	23

For transmitters rated at a maximum output power not listed above, the recommended separation distance "d" in meters (m) can be estimated using the equation applicable to the frequency of the transmitter, where "P" is the maximum output power rating of the transmitter in watts (W) according to the transmitter manufacturer.

Note 1 At 80 MHz and 800 MHz, the separation distance for a higher frequency range applies.

Note 2 These guidelines may not apply in all situations. Electromagnetic propagation is affected by absorption and reflection from structures, objects and people.

Warning for Radio interference

For U.S.A, Canada Only

WARNING!

This equipment has been tested and found to comply with the limits for a Class A digital device, pursuant to Part 15 of the FCC Rules. These limits are designed to provide reasonable protection against harmful interference when the equipment is operated in a commercial environment. This equipment generates, uses, and can radiate radio frequency energy and if not installed and used in accordance with the instruction manual, may cause harmful interference to radio communications. Operation of this equipment in a residential area is likely to cause harmful interference in which case the user will be required to correct the interference at his own expense.

Changes or modifications not expressly approved by the party responsible for compliance could void the user's authority to operate the equipment.

Note

Use the specified cable below so as to keep interference within the limits of a Class A digital device.

- AC Cord
- Shielded Signal Cable

Canadian Notice

This Class A information technology equipment complies with Canadian ICES-003.

Cet équipement informatique de classe A est conforme à la norme ICES-003 du Canada.

For Australia, New Zealand, etc Only

Warning

Operation of this equipment in a residential environment could cause radio interference.

Warnung

Der Betrieb dieses Geräts in einer Wohnumgebung könnte Funkstörungen verursachen.

Avertissement

L'utilisation de cet équipement dans une zone résidentielle pourrait provoquer des interférences radio.



EIZO Corporation

153 Shimokashiwano, Hakusan, Ishikawa 924-8566 Japan

艺卓显像技术(苏州)有限公司

中国苏州市苏州工业园区展业路 8 号中新科技工业坊 5B

EC REP

EIZO GmbH

Siemensallee 84, 76187 Karlsruhe, Germany

<http://www.eizoglobal.com>

Copyright © 2017 EIZO Corporation. All rights reserved.



00N0N007A1 
IFU-EX26203D-6

1st Edition-June, 2017 Printed in Japan.