



Leading Media Products

Increase Sales & Additional Profit by Selling Media with Every Printer

Multi-Purpose Labeling

North America

CONTENTS

MEDIA FOR DESKTOP PRINTERS	2
Duratherm II Labels	2
Duratherm III Labels	3
Duratran II Labels	4
Duratran S Film Labels	5
Duratran II Gloss Polyester Labels	6
ThermaMAX 1000 Wax Ribbons	7
ThermaMAX 2000 Mid-Range Ribbons.....	7
ThermaMAX 3000 Resin Ribbons	7
MEDIA FOR INDUSTRIAL PRINTERS	8
Duratherm II Labels	8
Duratherm II Tag.....	9
Duratherm II Labels	9
Duratherm III Labels	10
Duratran II Labels	11
Duratran II Floodcoated Labels.....	12
Duratran II Tags	13
Duratran II Kimdura Film Labels	14
Duratran II Valeron Film Tags	15
Duratran II Gloss Polyester Labels	15
ThermaMAX 1000 Wax Ribbons	16
ThermaMAX 2000 Mid-Range Ribbons.....	16
ThermaMAX 3000 Resin Ribbons	16
DIRECT THERMAL VS. THERMAL TRANSFER	17
FREE PRINTHEAD REPLACEMENT PROGRAM*	17
CONTACT INFORMATION	18

MEDIA FOR DESKTOP PRINTERS

Duratherm II Labels

Duratherm II is a non top-coated direct thermal paper that offers high quality, cost-effective printing. This material is recommended for most general-use applications where exposure to chemicals and moisture is not anticipated. Permanent adhesive.

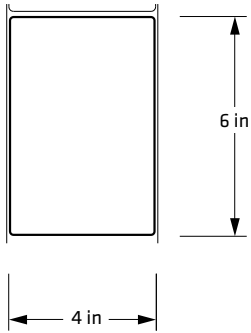

E25726



Size	ID	OD	Part Number	Qty/Roll	Rolls/Ctn	Ctn Weight	Stock/ MTO	Suggested Retail Price \$/Roll	\$/M
4" x 6"	1.5"	5"	E25726	439	8	17	Stock	\$18.08	\$41.19

MEDIA FOR DESKTOP PRINTERS

Duratherm III Labels

Duratherm III is a top-coated direct thermal paper that provides enhanced durability for applications where humidity and surface abrasion are a concern. Permanent adhesive.

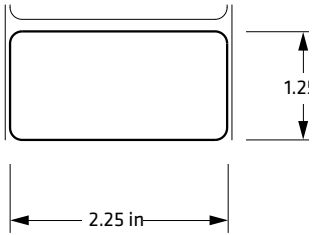

E15532

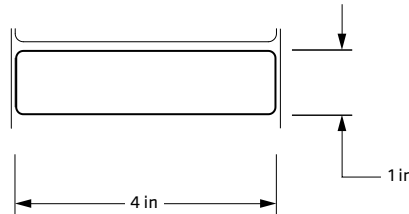

E15534

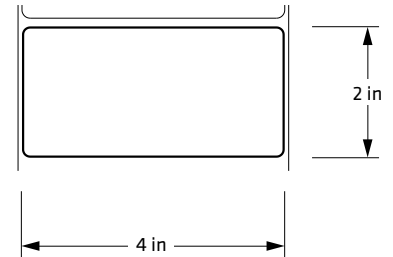

E15535

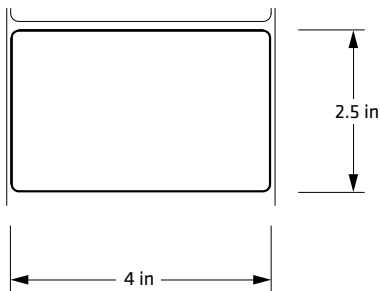

E15536

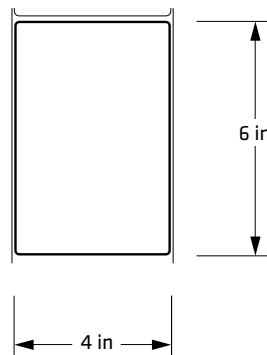

E15539



Size	ID	OD	Part Number	Qty/Roll	Rolls/Ctn	Ctn Weight	Stock/ MTO	Suggested Retail Price \$/Roll	\$/M
2.25" x 1.25"	1.5"	5"	E15532	1793	8	13	Stock	\$11.07	\$6.17
4" x 1"	1.5"	5"	E15534	2391	8	22	Stock	\$19.74	\$8.26
4" x 2"	1.5"	5"	E15535	1265	8	22	Stock	\$19.74	\$15.60
4" x 2.5"	1.5"	5"	E15536	1024	8	22	Stock	\$19.74	\$19.28
4" x 6"	1.5"	5"	E15539	439	8	22	Stock	\$19.74	\$44.97

MEDIA FOR DESKTOP PRINTERS

Duratran II Labels

Duratran™ II is a top-coated thermal transfer paper that demonstrates excellent print quality with the TMX1407 ribbon. This product is recommended where moderate abrasion, heat or sunlight are present. Permanent adhesive.

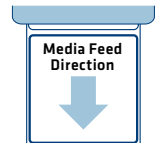
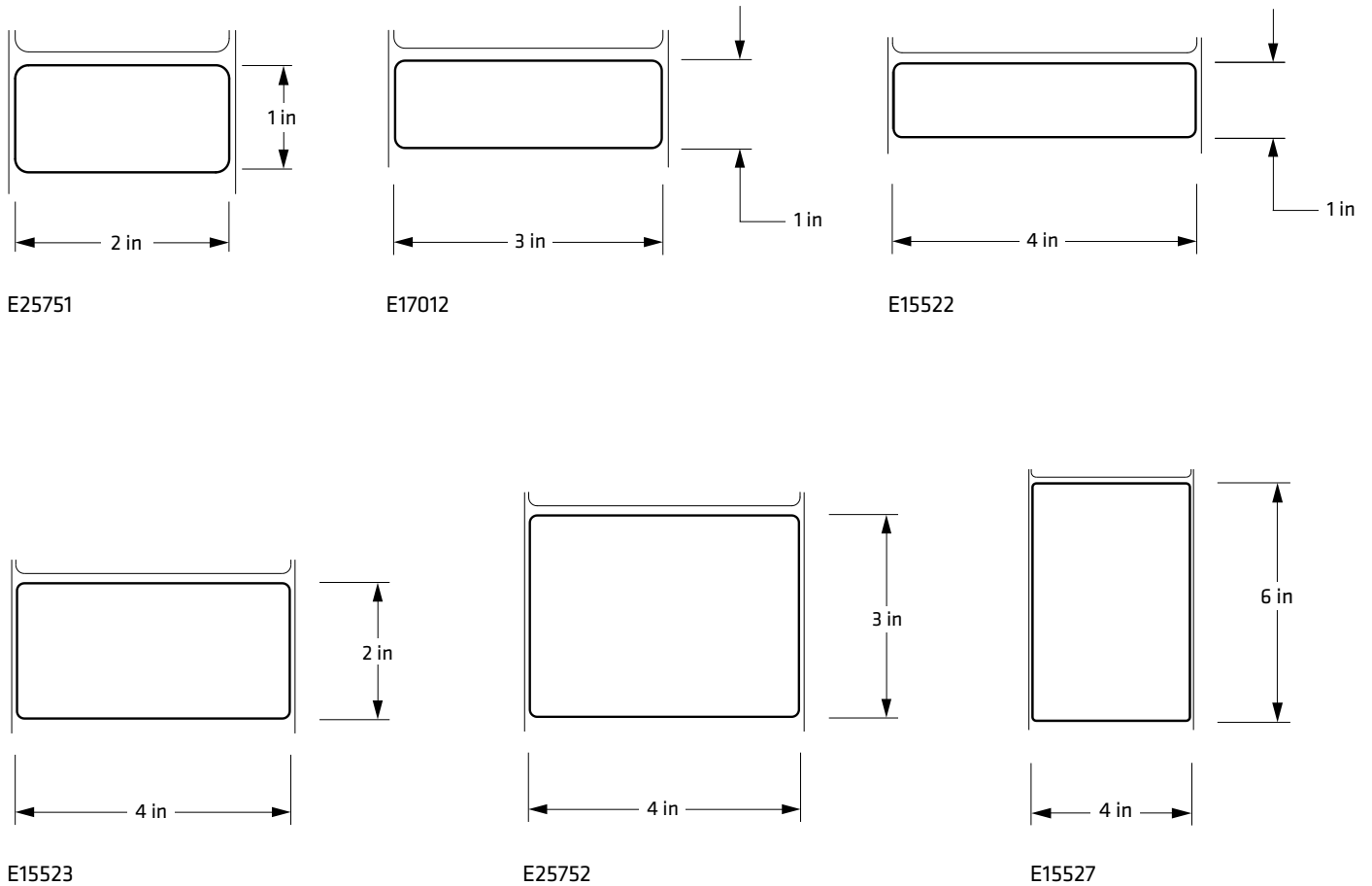

Size	ID	OD	Part Number	Qty/Roll	Rolls/Ctn	Ctn Weight	Stock/ MTO	Suggested Retail Price \$/Roll	\$/M	PF8-1/2" Core Ribbon	PF8-1" Core Ribbon
2" x 1"	1.5"	5"	E25751	2,391	8	11	MTO	\$18.21	\$7.61	11043304	11232211
3" x 1"	1.5"	5"	E17012	2,391	8	17	Stock	\$11.59	\$4.85	11043304	11233011
4" x 1"	1.5"	5"	E15522	2,391	8	21	Stock	\$15.45	\$6.46	11044304	11234012
4" x 2"	1.5"	5"	E15523	1,265	8	21	Stock	\$15.45	\$12.21	11044304	11234012
4" x 3"	1.5"	5"	E25752	860	8	21	MTO	\$42.67	\$49.62	11044304	11234012
4" x 6"	1.5"	5"	E15527	439	8	21	Stock	\$15.45	\$35.18	11044304	11234012

MEDIA FOR DESKTOP PRINTERS

Duratran S Film Labels

A 3 mil thick polypropylene thermal transfer label at an attractive price point. The matte face stock offers excellent print quality and moisture resistance; recommended for up to 6 months outdoor exposure. Demonstrates excellent print quality when printed with the TMX2202 Mid-Range ribbon. Permanent adhesive.

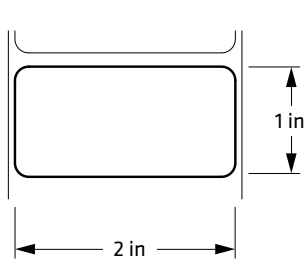

E25754

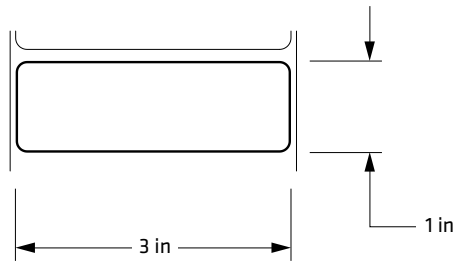

E25755

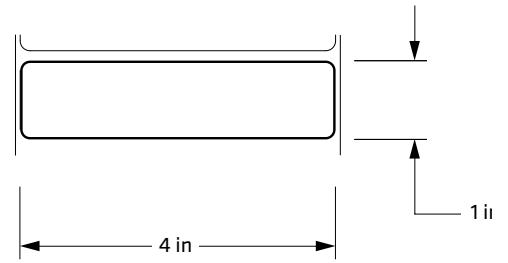

E25756

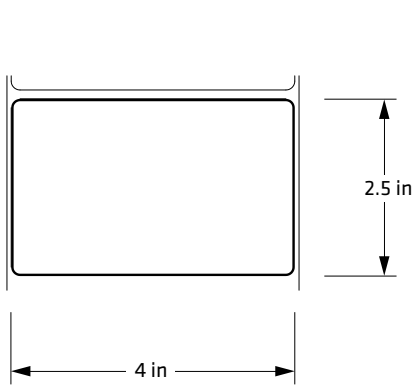

E25757

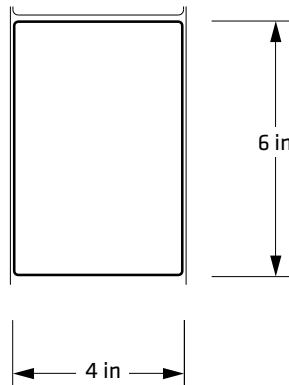

E25758



Size	ID	OD	Part Number	Qty/Roll	Rolls/Ctn	Ctn Weight	Stock/ MTO	Suggested Retail Price		PF8-1/2" Core Ribbon	PF8-1" Core Ribbon
								\$/Roll	\$/M		
2" x 1"	1.5"	5"	E25754	1,911	8	17	MTO	\$23.69	\$12.40	12042504	12232311
3" x 1"	1.5"	5"	E25755	1,911	8	17	MTO	\$30.10	\$15.75	12043204	12233111
4" x 1"	1.5"	5"	E25756	1,911	8	17	MTO	\$47.72	\$24.97	12044304	12234012
4" x 2.5"	1.5"	5"	E25757	819	8	17	MTO	\$47.72	\$58.26	12044304	12234012
4" x 6"	1.5"	5"	E25758	351	8	17	MTO	\$47.72	\$135.95	12044304	12234012

MEDIA FOR DESKTOP PRINTERS

Duratran II Gloss Polyester Labels

A high-gloss, top-coated polyester label with exceptional print quality. Excellent tear, smear and abrasion resistance; highly moisture and heat resistant. Product is UL recognized when printed with Intermec TMX3201 and TMX3202 ribbons. High-tack adhesive.

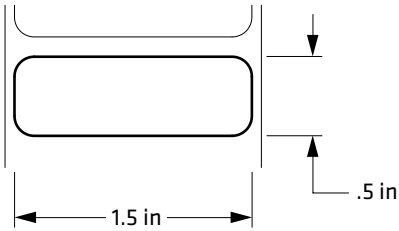

E25745

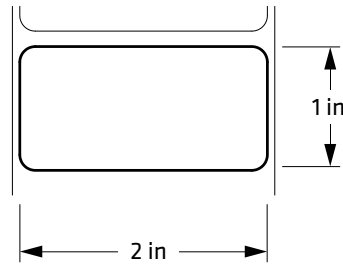

E22233

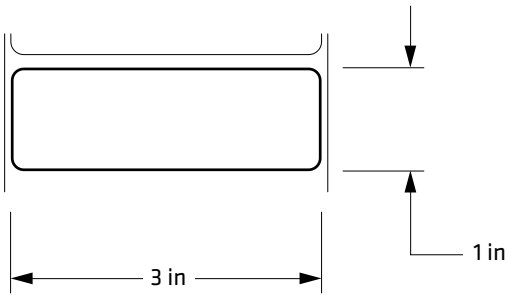

E25746

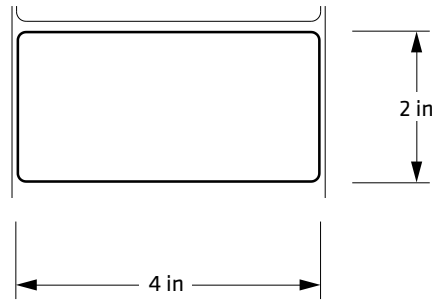

E25747

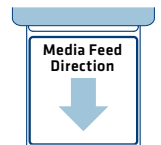

Size	ID	OD	Part Number	Qty/Roll	Rolls/Ctn	Ctn Weight	Stock/ MTO	Suggested Retail Price \$/Roll	\$/M	PF8-1/2" Core Ribbon	PF8-1" Core Ribbon
1.5" x 0.5"	1.5"	5"	E25745	4,304	8	10	MTO	\$31.92	\$7.42	13042504	13632111
2" x 1"	1.5"	5"	E22233	2,391	8	12	Stock	\$25.58	\$10.70	13042504	13632111
3" x 1"	1.5"	5"	E25746	2,391	4	20	MTO	\$52.49	\$21.95	13044304	13634012
4" x 2"	1.5"	5"	E25747	1,265	4	26	MTO	\$33.11	\$26.17	13044304	13634012

MEDIA FOR DESKTOP PRINTERS

ThermaMAX 1000 Wax Ribbons

A general-purpose, smear-resistant wax ribbon providing good durability when printing on Duratran™ II Papers and Tags. Ribbons are wound coated side out.

Size	Length	Part Number	Qty/Ctn	Ctn Weight	Stock/ MTO"	Suggested Retail Price		Printer
						\$/Roll	\$/Carton	
2.35"	10800"	11232211	36	17	Stock	\$8.58	\$308.88	PF8-1"
3.1"	10800"	11233011	24	21	Stock	\$11.32	\$271.68	PF8-1"
3.27"	3588"	11043304	24	11	Stock	\$5.00	\$120.00	PC41, PF8-1/2"
4.1"	10800"	11234012	24	19	Stock	\$14.97	\$359.28	PF8-1"
4.33"	3588"	11044304	12	7	Stock	\$6.62	\$79.44	PC41, PF8-1/2"

ThermaMAX 2000 Mid-Range Ribbons

A mid-range ribbon that provides enhanced abrasion/smear resistance and high image quality when used with Duratran II coated papers and across the Intermec Mid-Range Film product line. Ribbons are wound coated side out.

Width	Length	Part Number	Qty/Ctn	Ctn Weight	Stock/ MTO"	Suggested Retail Price		Printer
						\$/Roll	\$/Carton	
2.35"	10800"	12232311	24	9	Stock	\$16.06	\$385.44	PF8-1"
2.5"	3588"	12042504	36	9	Stock	\$6.70	\$241.20	PC41, PF8-1/2"
3.15"	10800"	12233111	24	10	MTO	\$21.52	\$516.48	PF8-1"
3.27"	3588"	12043204	36	11	Stock	\$8.78	\$316.08	PC41, PF8-1/2"
4.1"	10800"	12234012	24	19	MTO	\$28.00	\$672.00	PF8-1"
4.33"	3588"	12044304	18	7	Stock	\$11.62	\$209.16	PC41, PF8-1/2"

ThermaMAX 3000 Resin Ribbons

A high quality resin ribbon for applications that require the optimum level of smear and abrasion resistance. Excellent imaging and performance across the Intermec Ultra-Durable Film product line. Ribbons are wound coated side out. UL Recognized when used with Intermec Duratran II Gloss Polyester Labels.

Width	Length	Part Number	Qty/Ctn	Ctn Weight	Stock/ MTO"	Suggested Retail Price		Printer
						\$/Roll	\$/Carton	
2.36"	10800"	13632111	24	12	Stock	\$19.16	\$459.84	PF8-1"
2.5"	3588"	13042504	24	7	Stock	\$11.06	\$265.44	PC41, PF8-1/2"
3.1"	10800"	13633111	24	15	MTO	\$30.93	\$742.32	PF8-1"
3.1"	3588"	13633136	24	7	MTO	\$13.71	\$329.04	PC41, PF8-1/2"
4.1"	10800"	13634012	24	14	Stock	\$65.28	\$1566.72	PF8-1"
4.33"	3588"	13044304	24	7	Stock	\$19.14	\$459.36	PC41, PF8-1/2"

MEDIA FOR INDUSTRIAL PRINTERS

Duratherm II Labels

Duratherm II is a non top-coated direct thermal paper that offers high quality, cost-effective printing. This material is recommended for most general-use applications where exposure to chemicals and moisture is not anticipated. Permanent adhesive.

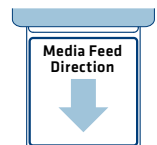
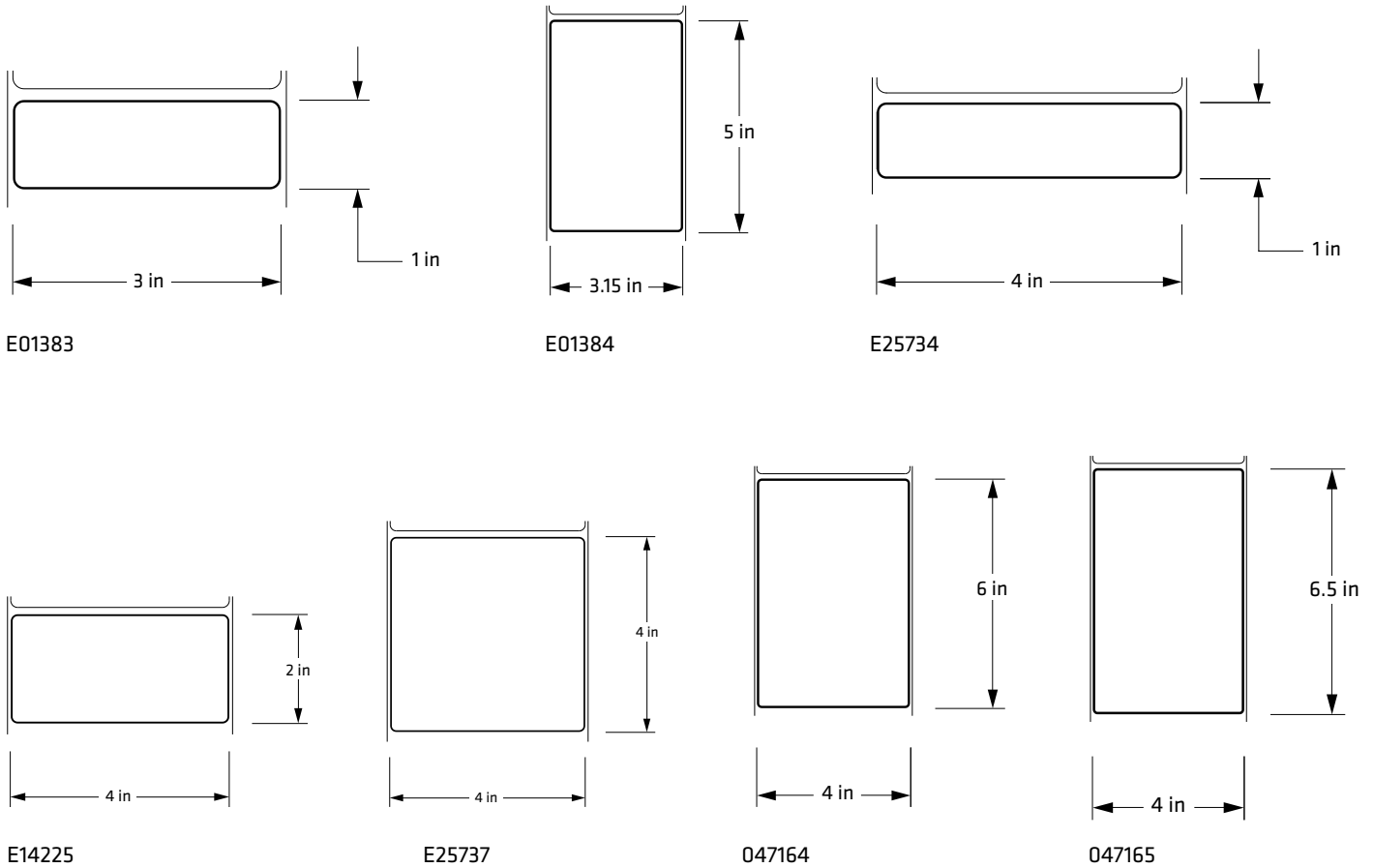

Size	ID	OD	Part Number	Qty/Roll	Rolls/Ctn	Ctn Weight	Stock/MTO	Suggested Retail Price \$/Roll	\$/M
3" x 1"	3"	8.38"	E01383	5,333	4	18	Stock	\$33.13	\$6.21
3.15" x 5"	3"	8.38"	E01384	1,170	4	19	Stock	\$26.03	\$22.25
4" x 1"	3"	8.38"	E25734	5,333	4	25	MTO	\$39.13	\$7.34
4" x 2"	3"	8.38"	E14225	2,823	8	47	Stock	\$44.18	\$15.65
4" x 4"	3"	8.38"	E25737	1,454	4	25	MTO	\$39.15	\$26.93
4" x 6"	3"	8.38"	047164	979	4	24	Stock	\$44.17	\$45.12
4" x 6.5"	3"	8.38"	047165	905	4	24	Stock	\$44.17	\$48.81

MEDIA FOR INDUSTRIAL PRINTERS

Duratherm II Tag

Duratherm II Tag is a 7-mil non top-coated direct thermal paper that offers high quality, cost-effective printing. This material is recommended for most general-use applications where exposure to chemicals and moisture is not anticipated.

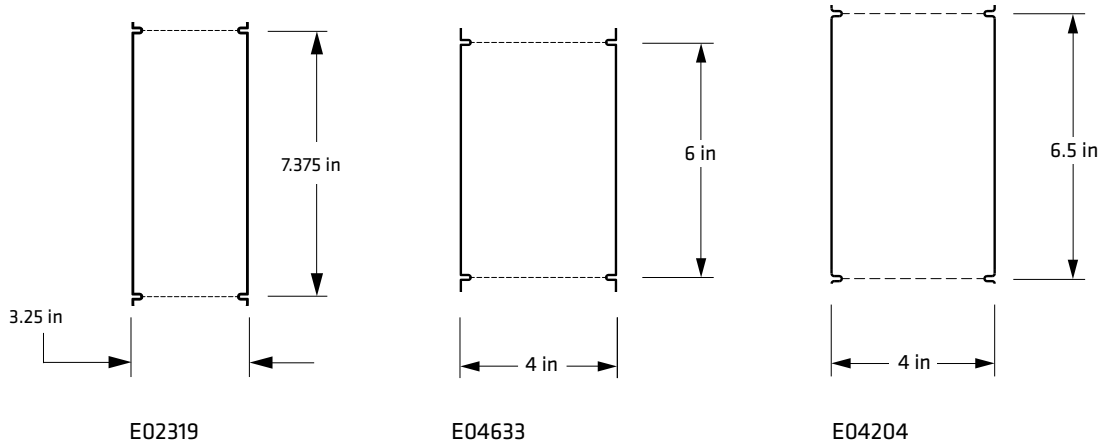

Size	ID	OD	Part Number	Qty/Roll	Rolls/Ctn	Ctn Weight	Stock/MTO	Suggested Retail Price	
								\$/Roll	\$/M
3.25" x 7.375"	3"	8.38"	E02319	813	4	20	Stock	\$31.15	\$38.32
4" x 6"	3"	8.38"	E04633	1,000	4	24	Stock	\$38.35	\$38.35
4" x 6.5"	3"	8.38"	E04204	923	8	24	Stock	\$38.35	\$41.55

MEDIA FOR INDUSTRIAL PRINTERS

Duratherm III Labels

Duratherm III is a top-coated direct thermal paper that provides enhanced durability for applications where humidity and surface abrasion are a concern. Permanent adhesive.

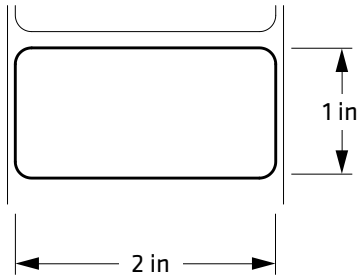

E22751

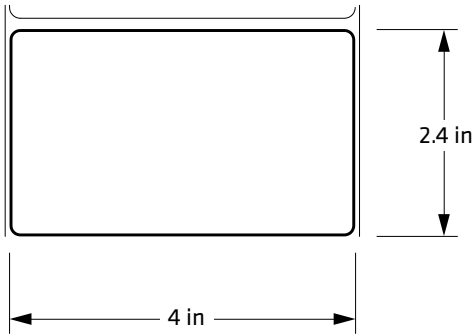

E06143

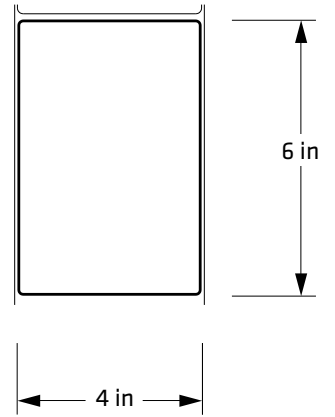

E06144



Width	ID	OD	Part Number	Qty/Roll	Rolls/Ctn	Ctn Weight	Stock/ MTO	Suggested Retail Price \$/Roll	\$/M
2" x 1"	3	8.38	E22751	4363	8	22	Stock	\$23.51	\$5.39
4" x 2.4"	3	8.38	E06143	2400	4	23	Stock	\$51.12	\$21.30
4" x 6"	3	8.38	E06144	979	4	23	Stock	\$46.37	\$47.36

Duratran II Labels

Duratran™ II is a top-coated thermal transfer paper that demonstrates excellent print quality with the TMX1407 ribbon. This product is recommended where moderate abrasion, heat or sunlight are present. Permanent adhesive.

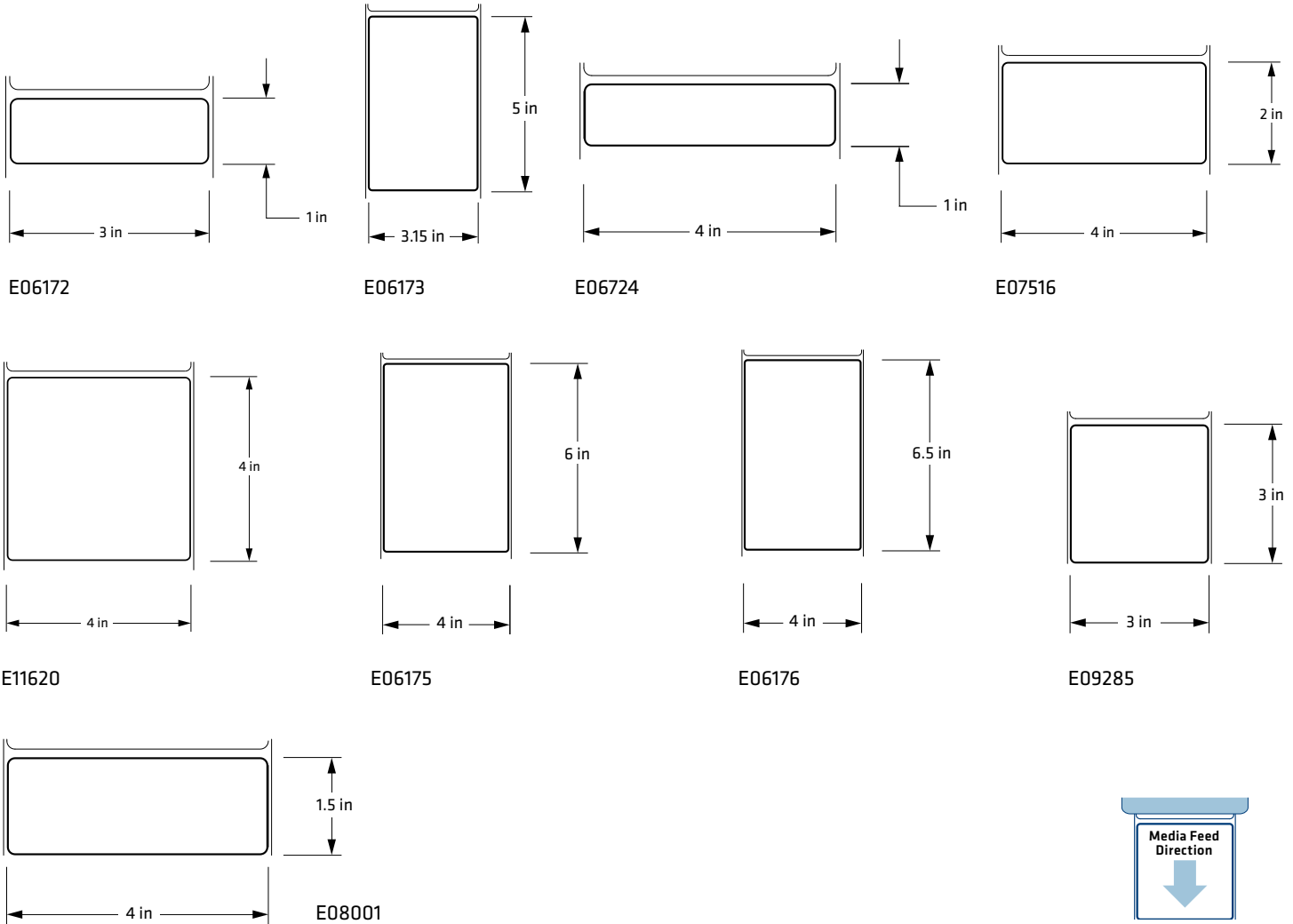

Size	ID	OD	Part Number	Qty/Roll	Rolls/Ctn	Ctn Weight	Stock/MTO	Suggested Retail Price \$/Roll	\$/M	PD/PM/PX Ribbon
3" x 1"	3"	8.38"	E06172	5,333	4	20	Stock	\$25.84	\$4.85	11233018
3.15" x 5"	3"	8.38"	E06173	1,170	4	21	Stock	\$20.45	\$17.48	11234118
3" x 3"	3"	8.38"	E09285	1,920	4	20	Stock	\$25.84	\$13.46	11234118
4" x 1"	3"	8.38"	E06724	5,333	8	48	Stock	\$34.45	\$6.46	11234118
4" x 1.5"	3"	8.38"	E08001	3,692	4	24	Stock	\$34.45	\$9.33	11234118
4" x 2"	3"	8.38"	E07516	2,823	4	24	Stock	\$25.98	\$9.20	11234118
4" x 4"	3"	8.38"	E11620	1,454	4	25	Stock	\$25.98	\$17.87	11234118
4" x 6"	3"	8.38"	E06175	979	4	24	Stock	\$32.79	\$33.49	11234118
4" x 6.5"	3"	8.38"	E06176	905	4	24	Stock	\$32.79	\$36.23	11234118

Duratran II Floodcoated Labels

Duratran™ II Floodcoated Labels are pre-printed with a scanner-friendly solid color that demonstrates excellent print quality with the TMX1407 ribbon. This product is recommended where moderate abrasion, heat or sunlight are present. Permanent adhesive.

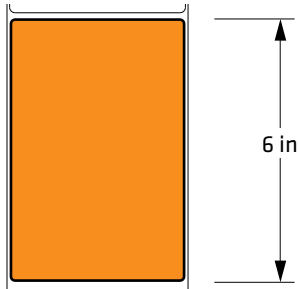

E07267-PMS021

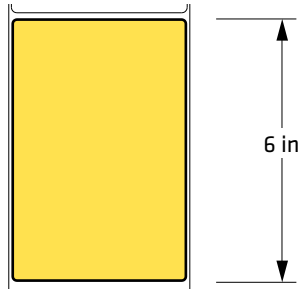

E07267-PMS115

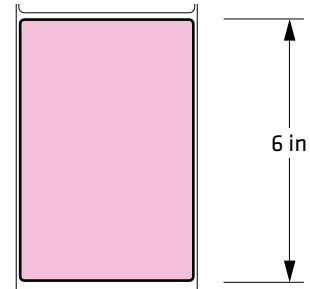

E07267-PMS236

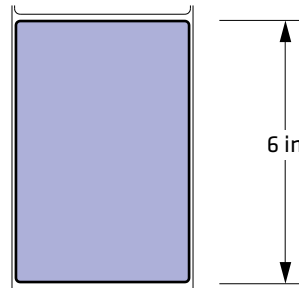

E07267-PMS2707

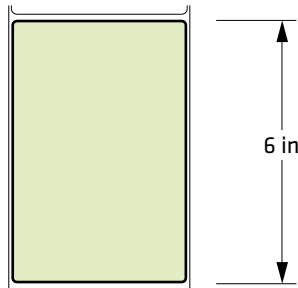

E07267-PMS365

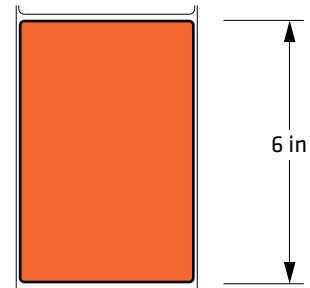

E07267-PMSWMRED



Size	ID	OD	Part Number	Qty/Roll	Rolls/Ctn	Ctn Weight	Stock/ MTO	Suggested Retail Price \$/Roll	\$/M	PD/PM/PX Ribbon
4" x 6"	3"	8.38"	E07267-PMS021	979	4	24	Stock	\$34.35	\$35.08	11234118
4" x 6"	3"	8.38"	E07267-PMS115	979	4	24	Stock	\$34.35	\$35.08	11234118
4" x 6"	3"	8.38"	E07267-PMS236	979	4	24	Stock	\$34.35	\$35.08	11234118
4" x 6"	3"	8.38"	E07267-PMS2707	979	4	24	Stock	\$34.35	\$35.08	11234118
4" x 6"	3"	8.38"	E07267-PMS365	979	4	24	Stock	\$34.35	\$35.08	11234118
4" x 6"	3"	8.38"	E07267-PMSWMRED	979	4	24	Stock	\$34.35	\$35.08	11234118

MEDIA FOR INDUSTRIAL PRINTERS

Duratran II Tags

Duratran II Tag is a 7-mil top-coated thermal transfer tag that demonstrates excellent print quality with the TMX1407 ribbon. This product is recommended where moderate abrasion, heat or sunlight are present.

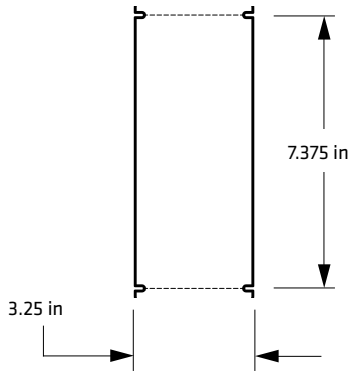

E04891

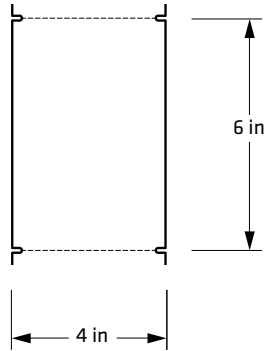

E09708



Size	ID	OD	Part Number	Qty/Roll	Rolls/Ctn	Ctn Weight	Stock/MTO	Suggested Retail Price \$/Roll	\$/M	PD/PM/PX Ribbon
3.25" x 7.375"	3"	8.38"	E04891	813	8	41	Stock	\$29.35	\$36.10	11234118
4" x 6"	3"	8.38"	E09708	1,000	4	25	Stock	\$36.12	\$36.12	11234118

Duratran II Kimdura Film Labels

A durable, high-quality polyolefin thermal transfer label. Exhibits good tear resistance and moisture resistance, as well as moderate temperature and chemical resistance. Demonstrates excellent print quality when printed with the TMX2202 Mid-Range ribbon.

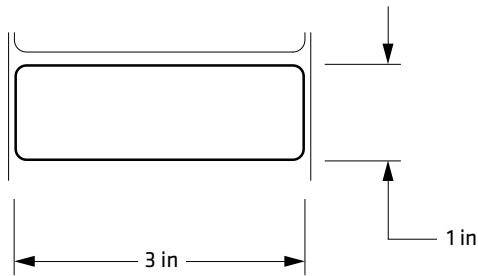

E02202

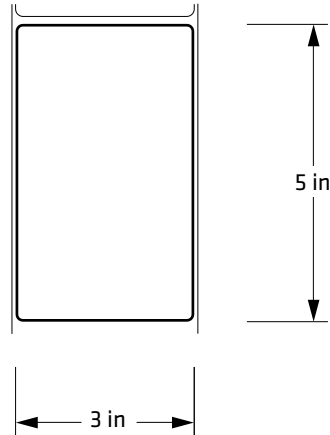

E02203

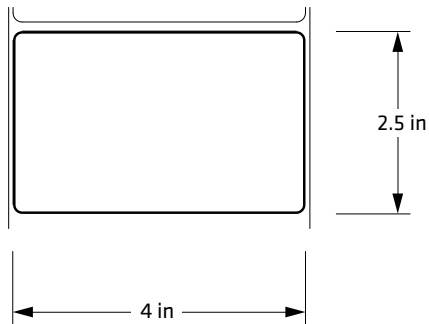

E02204

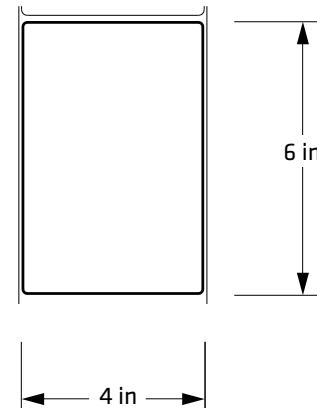

E03444

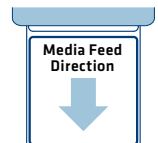

Size	ID	OD	Part Number	Qty/Roll	Rolls/Ctn	Ctn Weight	Stock/ MTO	Suggested Retail Price \$/Roll	\$/M	PD/PM/PX Ribbon
3" x 1"	3"	8.38"	E02202	4,888	8	38	Stock	\$49.04	\$10.03	12033118
3" x 5"	3"	8.38"	E02203	1,073	8	38	Stock	\$49.04	\$45.70	12033118
4" x 2.5"	3"	8.38"	E02204	2,095	4	26	Stock	\$65.37	\$31.20	12234118
4" x 6"	3"	8.38"	E03444	897	4	26	Stock	\$65.37	\$72.88	12234118

MEDIA FOR INDUSTRIAL PRINTERS

Duratran II Valeron Film Tags

A premium performance polyethylene tag with excellent tear resistance. Excellent choice when attaching with thin gauge wire or when staples are used. Demonstrates excellent print quality when printed with the TMX2202 Mid-Range ribbon.

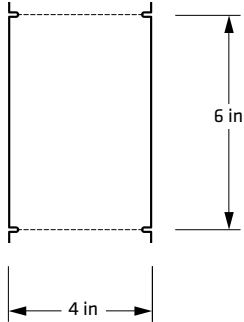

E12982

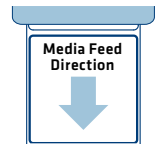

Size	ID	OD	Part Number	Qty/Roll	Rolls/Ctn	Ctn Weight	Stock/MTO	Suggested Retail Price \$/Roll	\$/M	PD/PM/PX Ribbon
4" x 6"	3"	8.38"	E12982	916	4	26	Stock	\$78.58	\$85.79	12234118

Duratran II Gloss Polyester Labels

A high-gloss, top-coated polyester label with exceptional print quality. Excellent tear, smear and abrasion resistance; highly moisture and heat resistant. Product is UL recognized when printed with Intermec TMX3202 ribbons. High-tack adhesive.

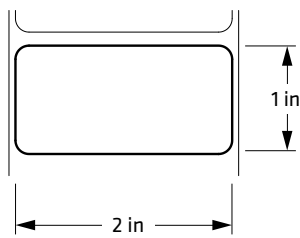

E10164

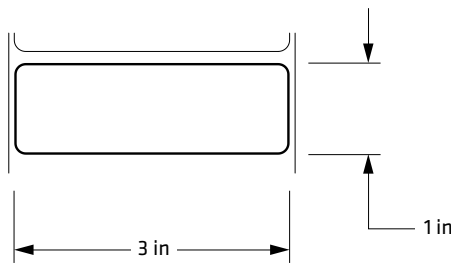

E23068

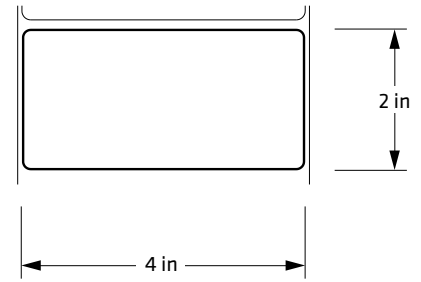

E23222



Size	ID	OD	Part Number	Qty/Roll	Rolls/Ctn	Ctn Weight	Stock/MTO	Suggested Retail Price \$/Roll	\$/M	PD/PM/PX Ribbon
2" x 1"	3"	8.38"	E10164	5,333	8	25	Stock	\$57.05	\$10.70	13632018
3" x 1"	3"	8.38"	E23068	5,333	4	19	Stock	\$85.57	\$16.05	13633018
4" x 2"	3"	8.38"	E23222	3,000	8	51	Stock	\$114.09	\$38.03	13634118

MEDIA FOR INDUSTRIAL PRINTERS

ThermaMAX 1000 Wax Ribbons

A general-purpose, smear-resistant wax ribbon providing good durability when printing on Duratran™ II Papers and Tags.

Width	Length	Part Number	Qty/Ctn	Ctn Weight	Stock/ MTO	Wind	Suggested Retail Price		Printer
							\$/Roll	\$/Carton	
2"	18024"	11232018	36	22	Stock	CSI	\$12.17	\$438.12	PD/PM/PX4i
3"	6000"	11023006	12	7	Stock	CSO	\$9.94	\$119.28	3400
3"	18024"	11233018	24	30	Stock	CSI	\$18.26	\$438.24	PD/PM/PX
4.1"	6,000"	11084106	12	6	Stock	CSO	\$13.58	\$162.96	3400
4.1"	18024"	11234118	24	27	Stock	CSI	\$24.61	\$590.64	PD/PM/PX
4.1"	18,000"	11064118	12	14	Stock	CSO	\$33.10	\$397.20	4420

ThermaMAX 2000 Mid-Range Ribbons

A mid-range ribbon that provides enhanced abrasion/smear resistance and high image quality when used with Duratran II coated papers and across the Intermec Mid-Range Film product line.

Width	Length	Part Number	Qty/Ctn	Ctn Weight	Stock/ MTO	Wind	Suggested Retail Price		Printer
							\$/Roll	\$/Carton	
2"	18024"	12232018	24	22	Stock	CSI	\$22.77	\$546.48	PD/PM/PX4i
2.09"	6000"	12022006	18	6	Stock	CSO	\$8.97	\$161.46	3240/3400
3"	6000"	12023006	18	7	Stock	CSO	\$13.46	\$242.28	3400
3.15"	18000"	12033118	24	22	Stock	CSI	\$35.87	\$860.68	PD/PM/PX
4.1"	6,000"	12084106	12	7	Stock	CSO	\$18.39	\$220.68	3400
4.1"	18024"	12234118	12	27	Stock	CSI	\$46.68	\$560.16	PD/PM/PX
4.1"	18,000"	12064118	12	14	Stock	CSO	\$46.68	\$560.16	4420

ThermaMAX 3000 Resin Ribbons

A high quality resin ribbon for applications that require the optimum level of smear and abrasion resistance. Excellent imaging and performance across the Intermec Ultra-Durable Film product line. UL Recognized when used with Intermec Duratran II Gloss Polyester Labels.

Width	Length	Part Number	Qty/Ctn	Ctn Weight	Stock/ MTO	Wind	Suggested Retail Price		Printer
							\$/Roll	\$/Carton	
2.1"	18036"	13632018	24	12	Stock	CSI	\$32.81	\$787.44	PD/PM/PX4i
3"	6000"	13023006	36	17	Stock	CSO	\$22.18	\$798.48	3400
3"	18036"	13633018	24	18	Stock	CSI	\$49.22	\$1,181.28	PD/PM/PX
4.1"	6,000"	13084106	24	12	Stock	CSO	\$30.31	\$727.44	3400
4.1"	18036"	13634118	24	24	Stock	CSI	\$68.19	\$1,636.56	PD/PM/PX
4.1"	18,000"	13064118	24	27	Stock	CSO	\$67.27	\$1,614.24	4420

DIRECT THERMAL VS. THERMAL TRANSFER

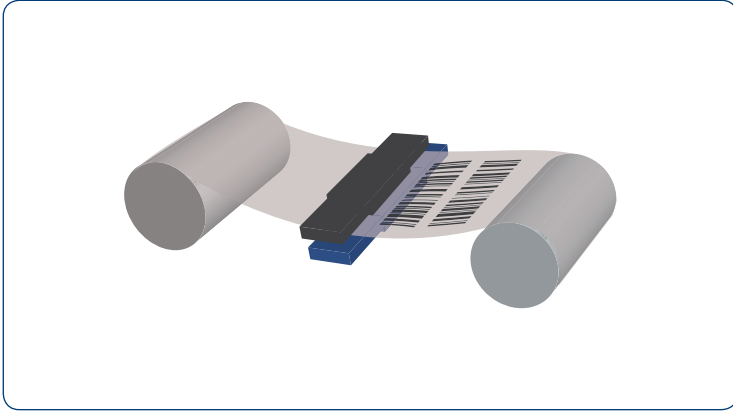

Direct Thermal Media Explained

Direct Thermal media uses a transparent heat-sensitive coating applied to its surface to image text and bar codes.

When the heat from the print head contacts the coating, it initiates a chemical reaction that turns the coating black.

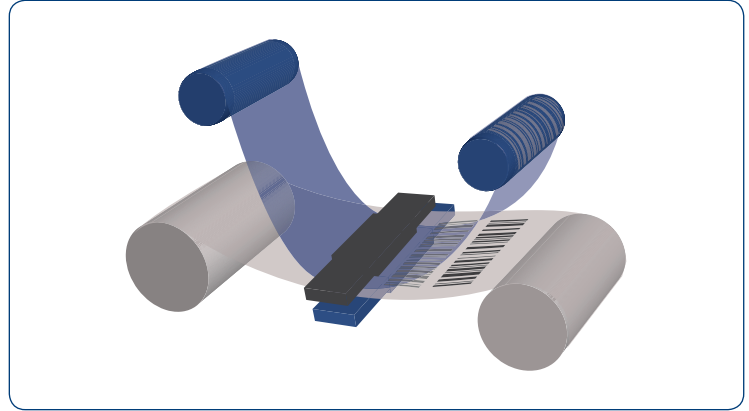

Thermal Transfer Media Explained

Thermal Transfer media uses a ribbon to image the text and bar codes on a variety of materials, both paper and film. When the ribbon is passed beneath the print head, the heat softens the ribbon ink while in contact with the label or tag, resulting in the transfer of the ink to the surface of the label or tag. There are three general classes of ribbons that are used in thermal printers: Wax, Mid-range, and Resin.

Wax ribbons are the most commonly used class and are mostly targeted to print paper labels and tags that will be exposed to relatively benign environments. Wax ribbons are also used to print on film labels and tags in some applications.

Mid-range ribbons are a hybrid design where resin is mixed with the wax to produce ribbons with durability properties that fall somewhere between the wax and resin ribbons. Mid-range ribbons are used to print on both paper and film labels and tags.

Resin ribbons are the most durable and are mostly targeted to printing on film labels and tags that will be exposed to extreme environments.

Ask about Intermec's

FREE PRINTHEAD REPLACEMENT PROGRAM*

- Provides no-cost printhead replacement for all Intermec fixed printers
- Lowers total cost of ownership, speeds up return on investment
- Applies to all Intermec media supplies

*Conditions apply. See www.intermec.com



CONTACT INFORMATION

North America

Corporate Headquarters

6001 36th Avenue West
Everett, Washington 98203
Phone: (425) 348-2600
Fax: (425) 355-9551

North Latin America

Headquarters Office

Mexico
Phone: +52 55 52-41-48-00
Fax: +52 55 52-11-81-21

South Latin America

Headquarters Office

Brazil
Phone: +55 11 3711-6776
Fax: +55 11 5502-6780

Europe/Middle East & Africa Headquarters Office

Reading, United Kingdom
Phone: +44 118 923 0800
Fax: +44 118 923 0801

Asia Pacific

Headquarters Office

Singapore
Phone: +65 6303 2100
Fax: +65 6303 2199

Internet

www.intermec.com
Worldwide Locations:
www.intermec.com/locations

Sales

Toll Free NA: (800) 934-3163
Toll in NA: (425) 348-2726
Freephone ROW:
00 800 4488 8844
Toll ROW: +44 134 435 0296

OEM Sales

Phone: (425) 348-2762

Media Sales

Phone: (513) 874-5882

Customer Service and Support

Toll Free NA: (800) 755-5505
Toll in NA: (425) 356-1799

Copyright © 2011 Intermec Technologies Corporation. All rights reserved. Intermec is a registered trademark of Intermec Technologies Corporation. All other trademarks are the property of their respective owners. Printed in the U.S.A. 01A 07/11



In a continuing effort to improve our products, Intermec Technologies Corporation reserves the right to change specifications and features without prior notice.