



FUJIFILM X100T

Owner's Manual

- [Owner's Manual \(Basic Operations: !\[\]\(f15d3c54be60b4fd0ce1da9fb3f67256_img.jpg\)\)](#)
- [Owner's Manual \(pdf, available on this website: !\[\]\(7bf135d42c40a6430c927b2fd03d7659_img.jpg\)\)](#)

About This Manual

[Introduction](#)

[Viewing This Manual](#)

Parts of the Camera

[Parts of the Camera](#)

[The Viewfinder Selector](#)

[The Selector](#)

[The \[DISP/BACK\] Button](#)

[The Command Dial](#)

[Diopter Adjustment](#)

[The Aperture Ring and Shutter Speed Dial](#)

[The Indicator Lamp](#)

[The \[VIEW MODE\] Button](#)

[The \[DRIVE\] Button](#)

Camera Displays

[Shooting: Optical Viewfinder](#)

[Playback: Electronic Viewfinder/LCD Monitor](#)

[Shooting: Electronic Viewfinder/LCD Monitor](#)

First Steps

Attaching the Strap
 Charging the Battery
 Inserting the Battery and a Memory Card

Turning the Camera on and Off
 Basic Setup

Basic Photography and Playback

Taking Photographs
 Viewing Pictures

Deleting Pictures

Basic Movie Recording and Playback

Recording Movies
 Viewing Movies

Shooting Mode

Program AE
 Shutter-Priority AE

Aperture-Priority AE
 Manual Exposure

[Q] (Quick Menu) Button

Using the [Q] Button

[Fn] (Function) Buttons

The Function Buttons

More on Photography

Bracketing
 Continuous Shooting (Burst Mode)
 Multiple Exposures
 Panoramas
 Macro Mode (Close-ups)
 Using the Self-Timer
 Interval Timer Photography
 Using the Flash
 Focus-Frame Selection
 Exposure Compensation

Focus/Exposure Lock
 Focus Mode
 Manual Focus (Focus Mode M)
 Metering
 Recording Pictures in RAW Format
 Long Time-Exposures (T/B)
 Film Simulation
 White Balance
 Advanced Filters

The Shooting Menu

Using the Shooting Menu	[FUNCTION (Fn) SETTING]
Factory Defaults—Shooting Menu	[DISP. CUSTOM SETTING]
[AUTOFOCUS SETTING]	[CONVERSION LENS]
[ISO]	[MF ASSIST]
[IMAGE SIZE]	[ADVANCED FILTER]
[IMAGE QUALITY]	[INTERVAL TIMER SHOOTING]
[DYNAMIC RANGE]	[SELF-TIMER]
[FILM SIMULATION]	[AE/AF-LOCK MODE]
[FILM SIMULATION BKT]	[AE/AF-LOCK BUTTON]
[ND FILTER]	[PHOTOMETRY]
[COLOR]	[INTERLOCK SPOT AE & FOCUS AREA]
[SHARPNESS]	[RED EYE REMOVAL]
[HIGHLIGHT TONE]	[SAVE ORG IMAGE]
[SHADOW TONE]	[FLASH MODE]
[NOISE REDUCTION]	[FLASH COMPENSATION]
[LONG EXPOSURE NR]	[SHUTTER TYPE]
[WHITE BALANCE]	[MOVIE SET-UP]
[SELECT CUSTOM SETTING]	[WIRELESS COMMUNICATION]
[EDIT/SAVE CUSTOM SETTING]	

The Playback Menu

Using the Playback Menu	[PHOTOBOOK ASSIST]
[RAW CONVERSION]	[MARK FOR UPLOAD TO]
[ERASE]	[IMAGE SEARCH]
[CROP]	[COPY]
[RESIZE]	[PRINT ORDER (DPOF)]
[PROTECT]	[instax PRINTER PRINT]
[IMAGE ROTATE]	[DISP ASPECT]
[RED EYE REMOVAL]	[WIRELESS COMMUNICATION]
[SLIDE SHOW]	[PC AUTO SAVE]

The Setup Menu

Using the Setup Menu	[SELECTOR BUTTON SETTING]
Factory Defaults—Setup Menu	[EDIT/SAVE QUICK MENU]
[DATE/TIME]	[POWER MANAGEMENT]
[TIME DIFFERENCE]	[SHUTTER COUNT]
[言語/LANG.]	[EDIT FILE NAME]
[RESET]	[WIRELESS SETTINGS]
[SILENT MODE]	[PC AUTO SAVE SETTING]
[FRAME NO.]	[GEOTAGGING SET-UP]
[FOCUS RING]	[instax PRINTER CONNECTION SETTING]
[FOCUS CHECK]	[COLOR SPACE]
[SOUND SET-UP]	[FORMAT]
[SCREEN SET-UP]	

Connections

Wireless Transfer	Printing Pictures via USB
Copying Pictures to a Computer	Viewing Pictures on TV

Accessories

Shoe-mounted flash units	Stereo microphones
Power Supplies	Other
Remote Releases	Website of the country or region of purchase
Conversion Lens	

For Your Safety

For Your Safety

Appendix

Troubleshooting/FAQ	Links
Warning Messages and Displays	Restrictions on Camera Settings
Specifications	

About This Manual

- ➔ [Introduction](#)
- ➔ [Viewing This Manual](#)

Introduction

- ⚠ All pages of this manual may be subject to change or deletion without notice.
- ⚠ This manual may not be reproduced in whole or in part without prior permission, except for individual use. Redistribution is prohibited.

Viewing This Manual

- [The Home Page](#)
- [Content Pages](#)
- [Searching the Manual](#)

The Home Page

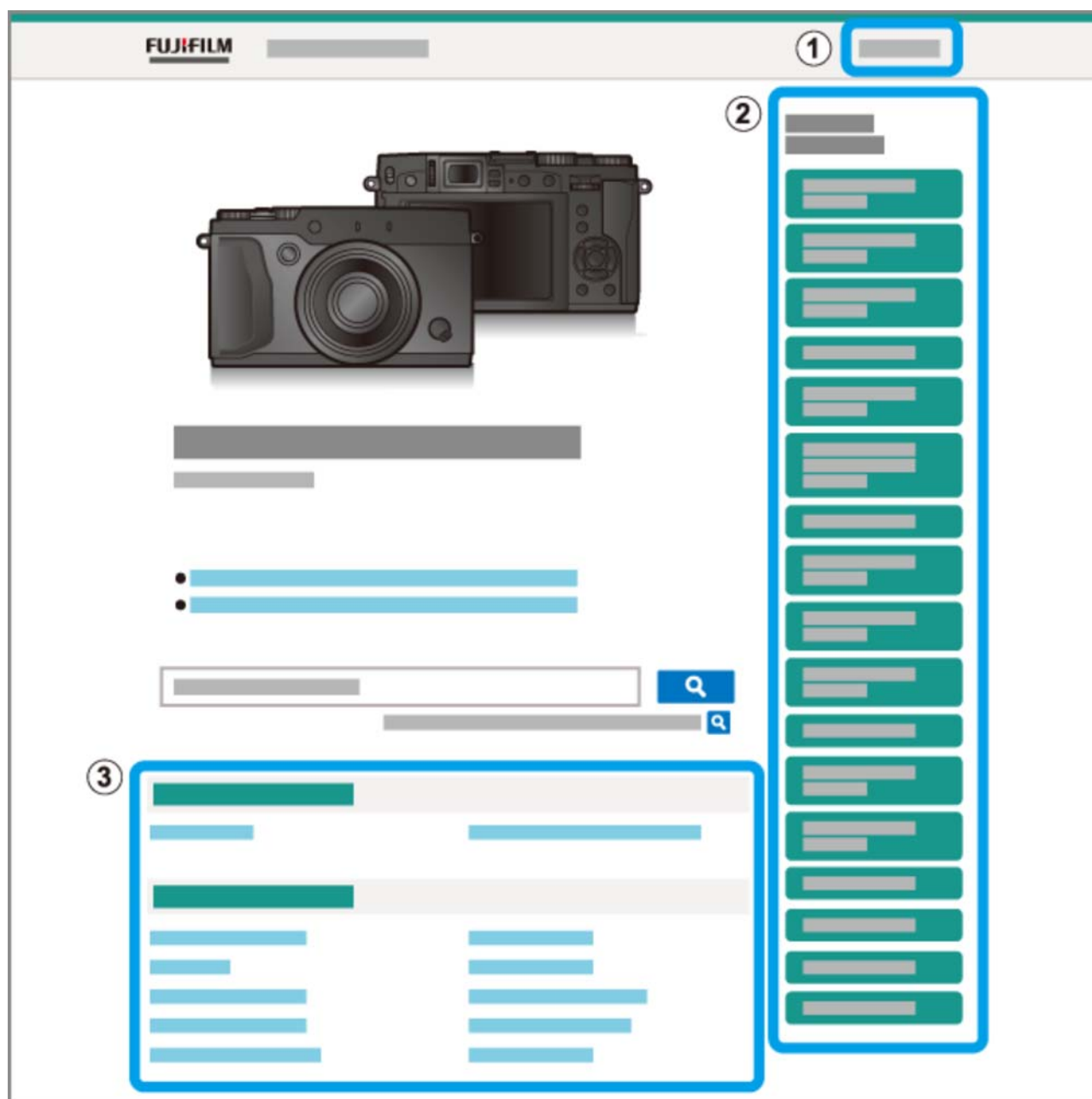

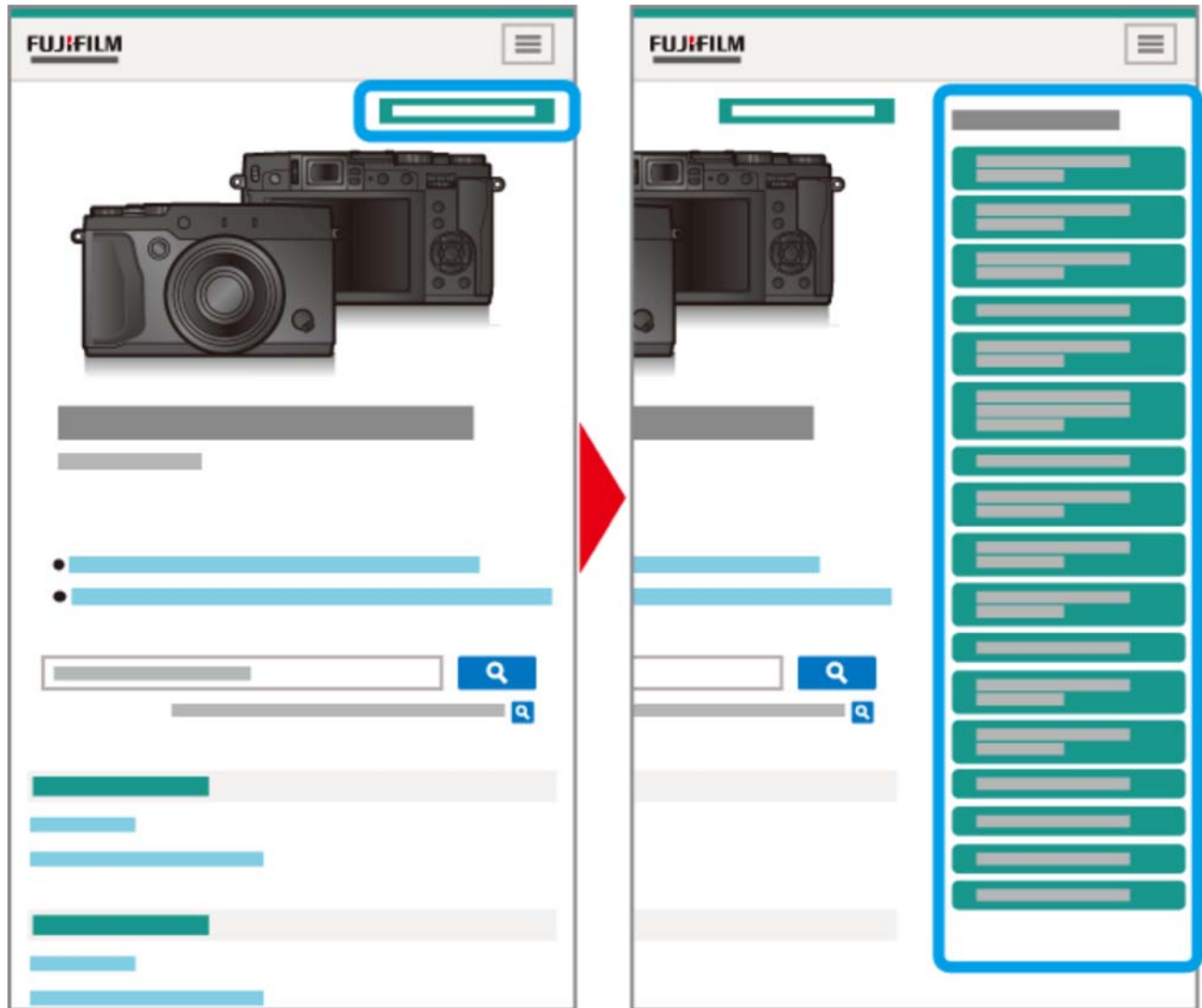

- 1 Choose a language.
- 2 A table of contents listing the main headings. Click a heading to view sub-headings and click a sub-heading to view the page for that item.
- 3 The complete table of contents. Click a sub-heading to view the page for that item.

The table of contents listing may not display on smartphones and other mobile devices. Click the button to view the table of contents and again to hide it.

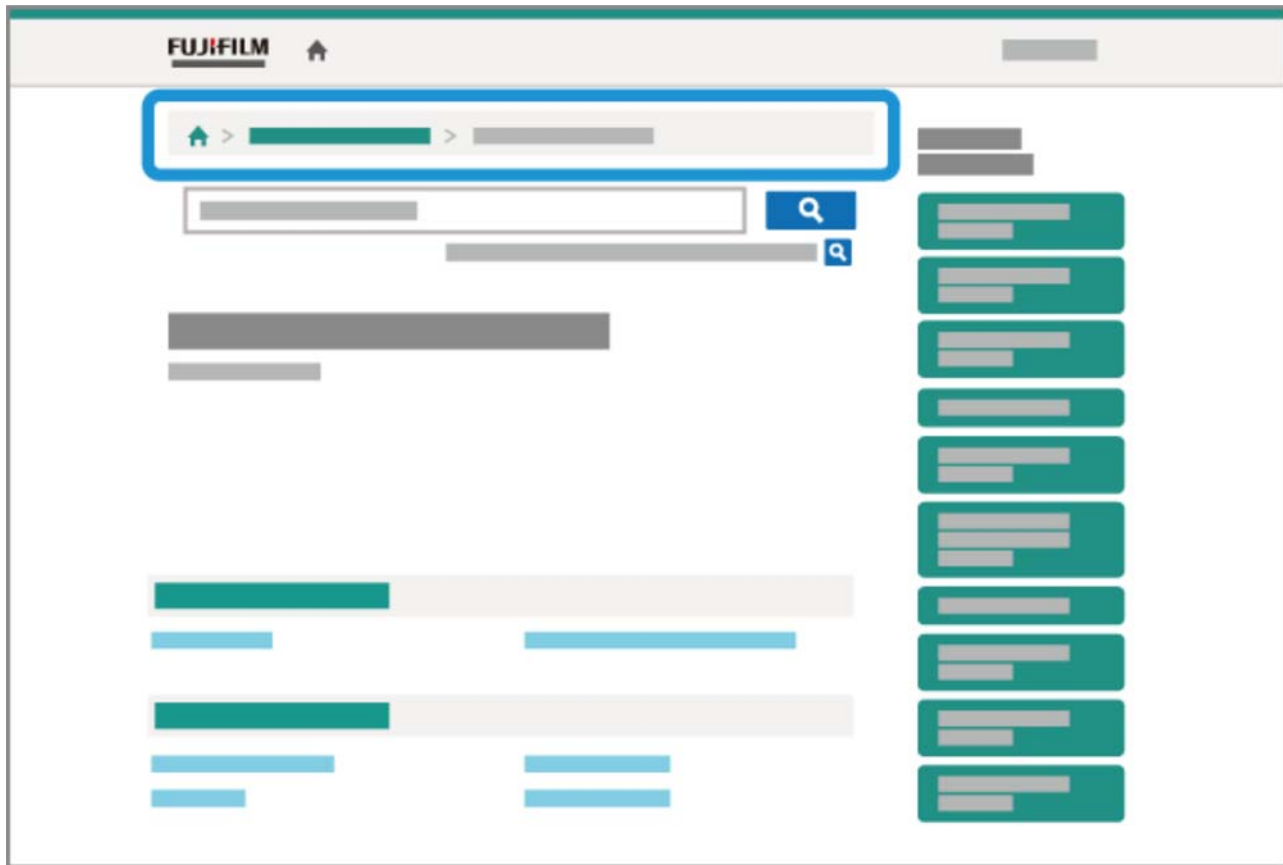

Content Pages



- The breadcrumb bar shows your current position in the manual.
- Click the  button to return to the table of contents.
- You can also navigate by clicking headings in the breadcrumb bar.

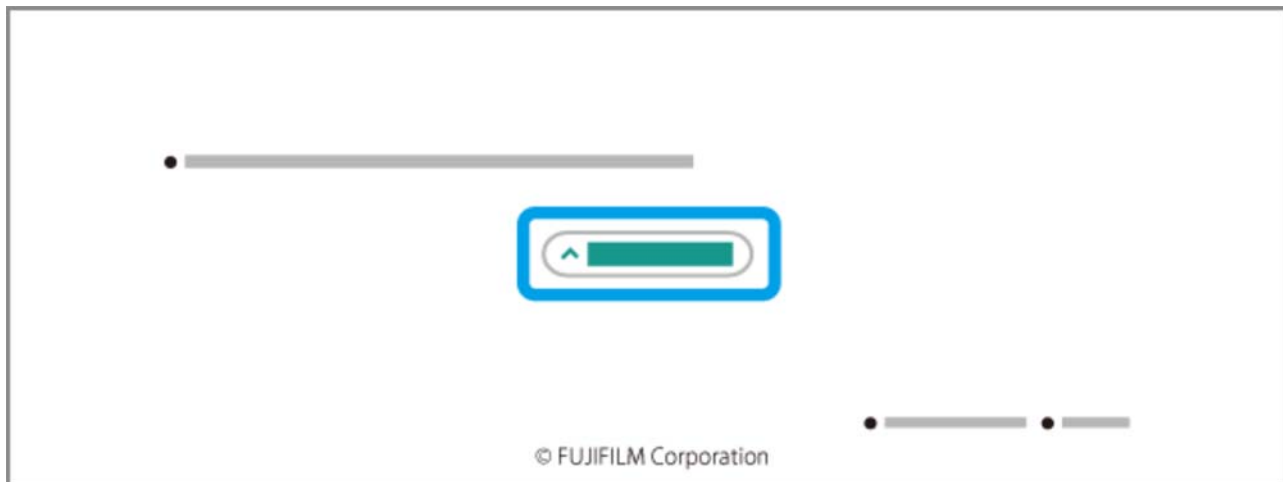

Click the button at the bottom of the page to jump to the top.

Searching the Manual



Enter a search term and click  to search the manual.

Parts of the Camera

- ➔ [Parts of the Camera](#)
- ➔ [The Selector](#)
- ➔ [The Command Dial](#)
- ➔ [The Aperture Ring and Shutter Speed Dial](#)
- ➔ [The \[VIEW MODE\] Button](#)
- ➔ [The Viewfinder Selector](#)
- ➔ [The \[DISP/BACK\] Button](#)
- ➔ [Diopter Adjustment](#)
- ➔ [The Indicator Lamp](#)
- ➔ [The \[DRIVE\] Button](#)

Parts of the Camera

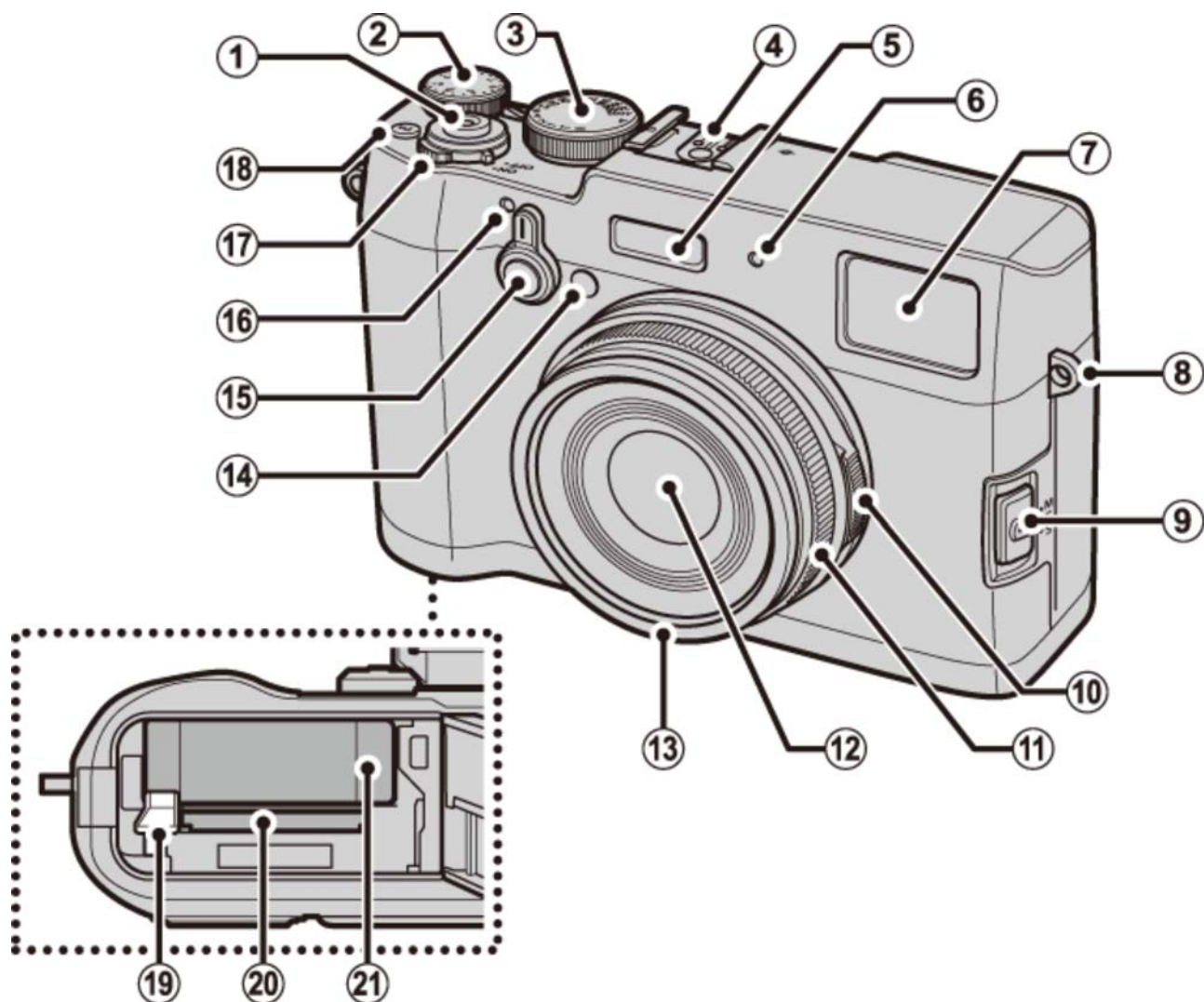

- ① Shutter button
- ② Exposure compensation dial
- ③ Shutter speed dial
- ④ Hot shoe
- ⑤ Flash
- ⑥ Microphone (L)
- ⑦ Viewfinder window
- ⑧ Strap eyelet
- ⑨ Focus mode selector
- ⑩ Aperture ring
- ⑪ Focus ring
- ⑫ Lens
- ⑬ Front ring¹
- ⑭ AF-assist illuminator
Self-timer lamp
- ⑮ Viewfinder selector
- ⑯ Microphone (R)
- ⑰ **[ON/OFF]** switch
- ⑱ **[Fn]** button (function button 1)
- ⑲ Battery latch
- ⑳ Memory card slot
- ㉑ Battery chamber

¹ Remove when attaching lens accessories.

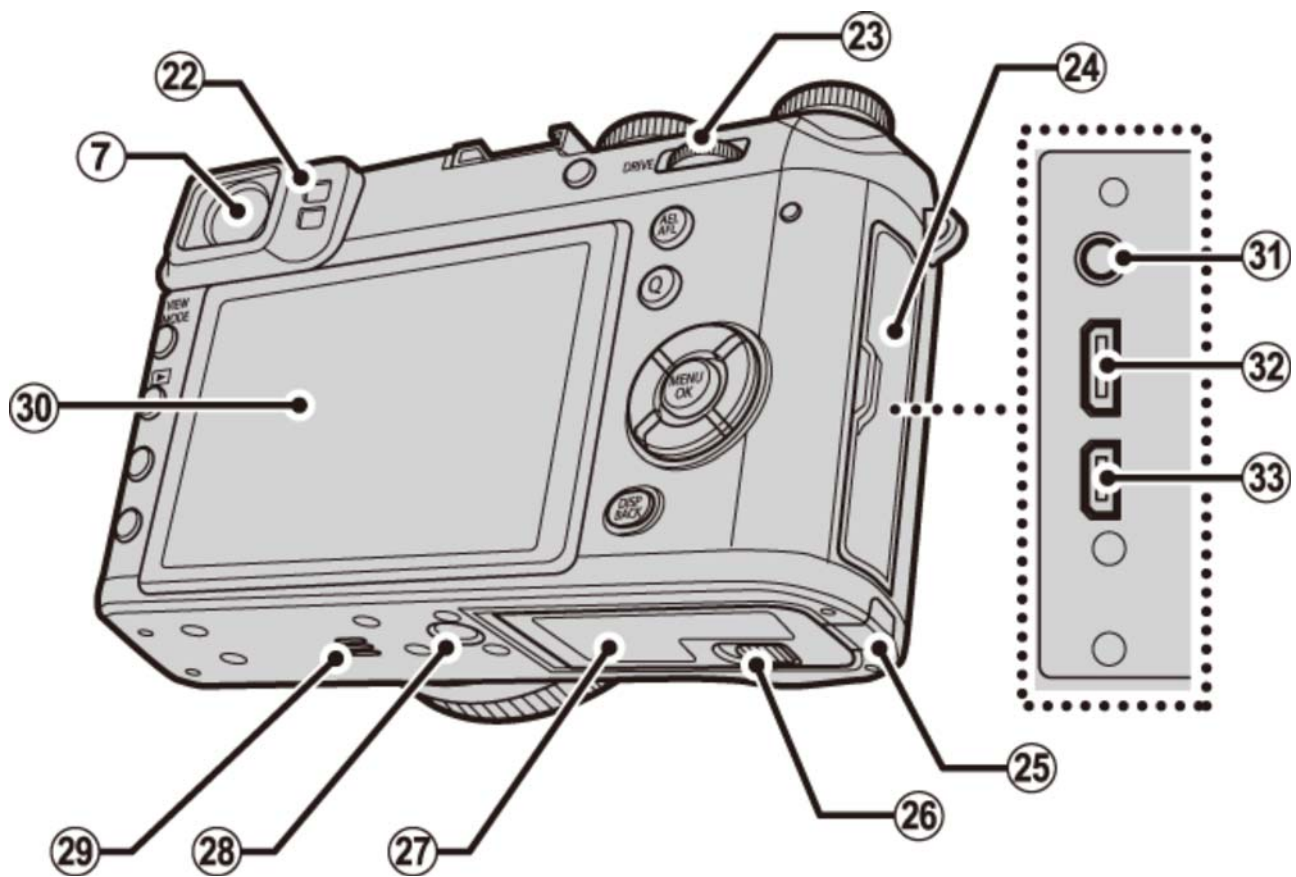

- 22 Eye sensor
- 23 Command dial
- 24 Connector cover
- 25 DC coupler cable cover
- 26 Battery-chamber cover latch
- 27 Battery-chamber cover
- 28 Tripod mount
- 29 Speaker
- 30 LCD monitor
- 31 Microphone/remote release connector
- 32 Micro USB connector
- 33 Micro HDMI connector²

² Use an HDMI cable no more than 1.5 m (4.9 ft.) long.

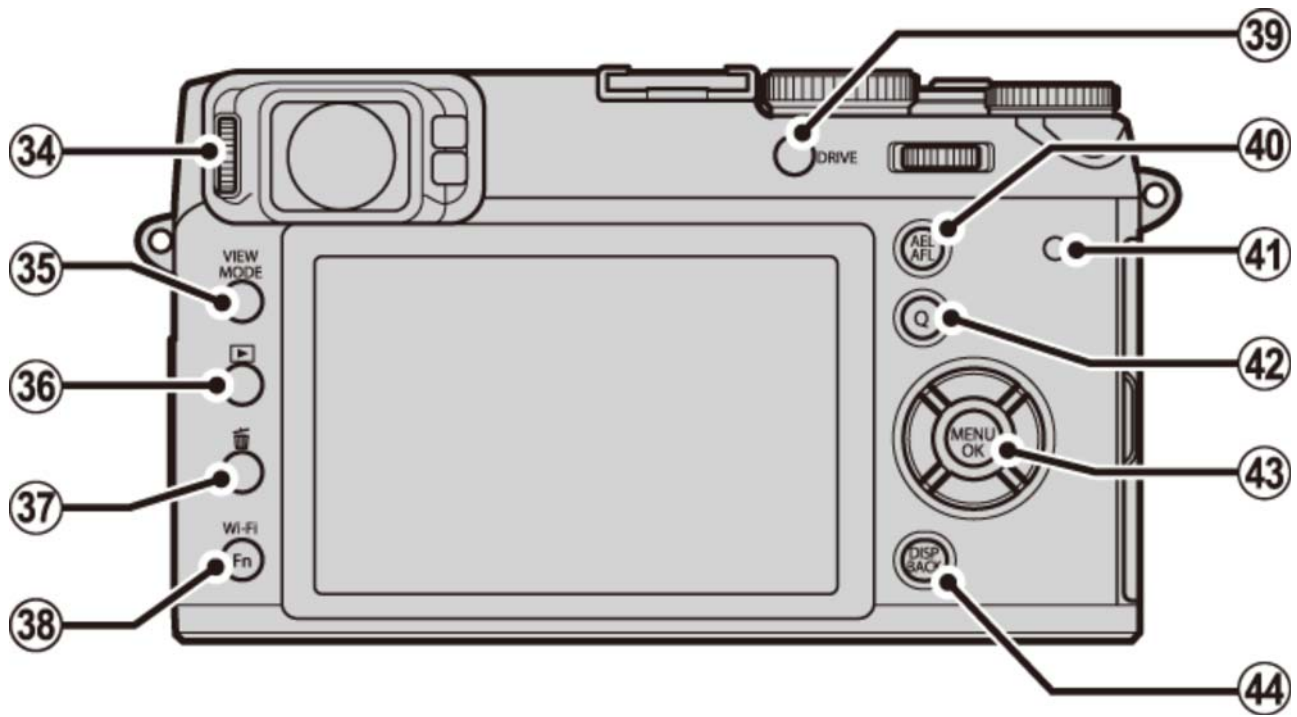

34 Diopter adjustment control

35 [VIEW MODE] button

36 [▶] (playback) button

37 [🗑️] (delete) button (playback mode)

[Fn] button (function button 6)

38 [Wi-Fi] button

[Fn] button (function button 7)

39 [DRIVE] button

40 [AEL/AFL] (autoexposure/autofocus lock) button

41 Indicator lamp

42 [Q] (quick menu) button



43 Selector/function buttons

44 [DISP] (display)/[BACK] button

The Selector

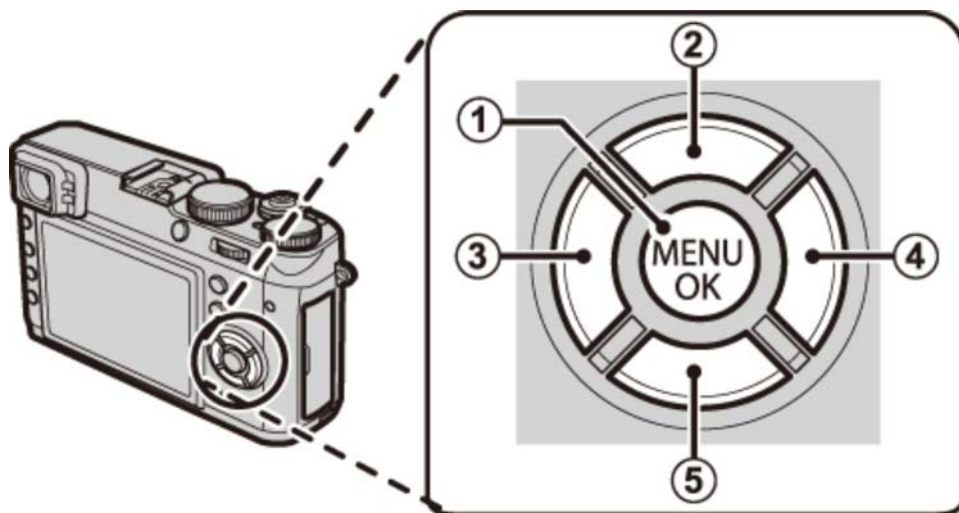
Press the selector up (2), left (3), right (4), or down (5) to highlight items and press [MENU/OK] (1) to select. The up, left, right, and down buttons also double as the macro, film simulation, white balance, and focus-area selection buttons, respectively, and as function buttons 2 through 5.



 To prevent accidental operation of the selector and the [Q] button during shooting, press [MENU/OK] until  is displayed. The controls can be unlocked by pressing [MENU/OK] until  is no longer displayed.

See Also

-  [The Function Buttons](#) ([Fn] (Function) Buttons)

The Command Dial

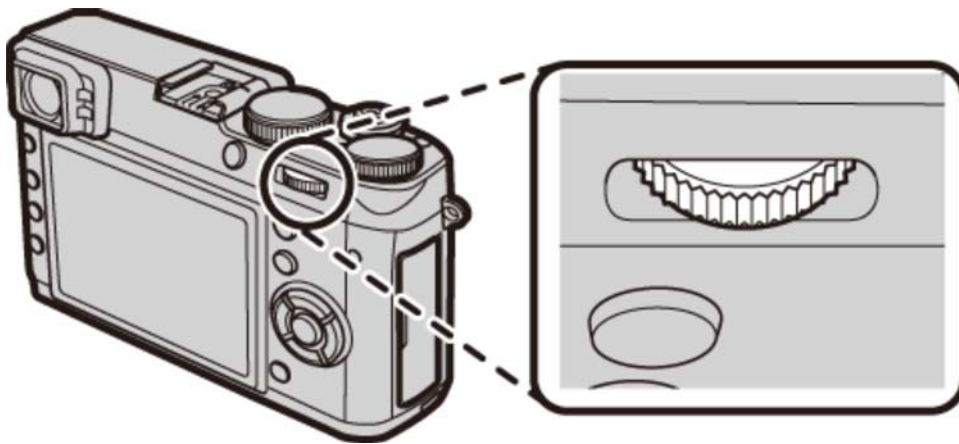

The command dial can be used to navigate the menus, to zoom in and out and choose the number of pictures displayed during playback, and to select options in the quick menu display.



Press the center of the command dial to zoom in on the active focus area during shooting or playback.

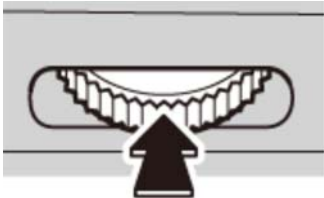

The Aperture Ring and Shutter Speed Dial

Use the aperture ring and shutter speed dial to choose from modes **[P]**, **[S]**, **[A]**, and **[M]**.

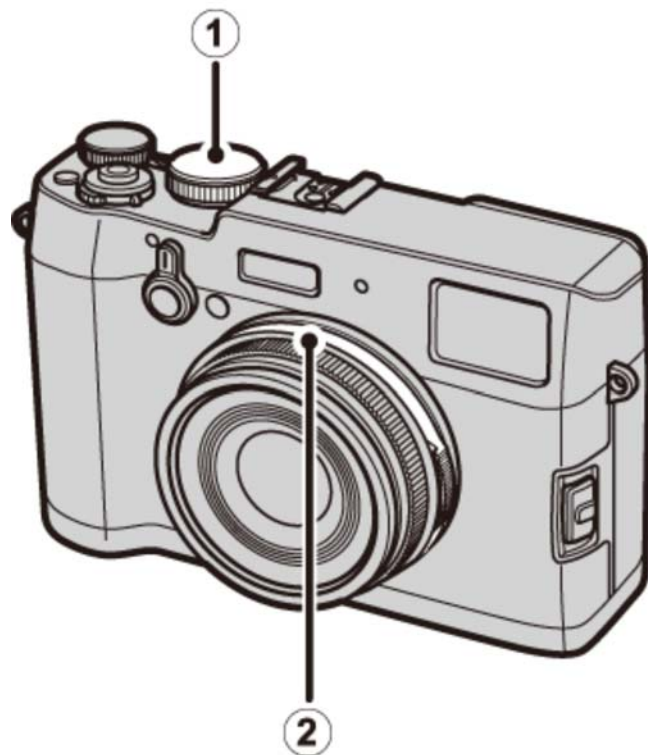

① Shutter speed dial

② Aperture ring

- ⬇ Mode P: Program AE
- ⬇ Mode S: Shutter-Priority AE
- ⬇ Mode A: Aperture-Priority AE
- ⬇ Mode M: Manual Exposure

Mode P: Program AE

Aperture and shutter speed can be adjusted using program shift.

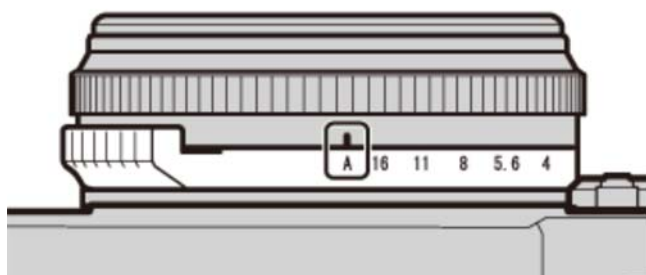

Aperture: **[A]**

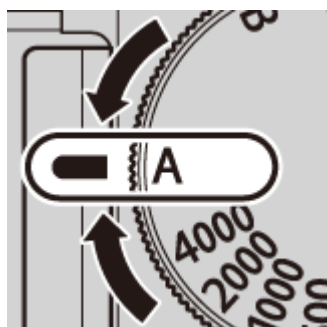

Shutter speed: **[A]**

Mode S: Shutter-Priority AE

Take pictures at the selected shutter speed. The camera adjusts aperture automatically.

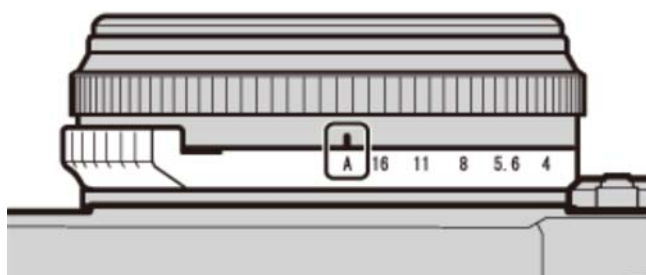

Aperture: **[A]**

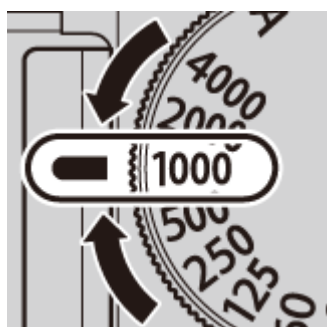

Shutter speed: **1/1000 s**

Mode A: Aperture-Priority AE

Take pictures at the selected aperture. The camera adjusts shutter speed automatically.

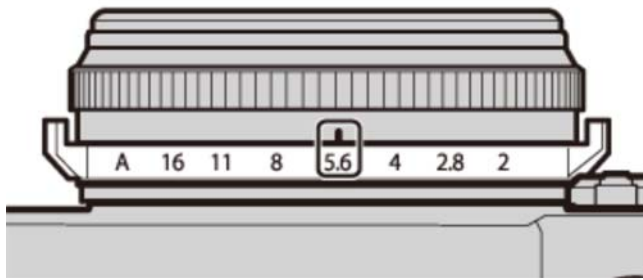

Aperture: **f/5.6**

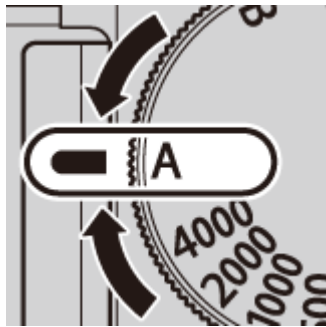

Shutter speed: **[A]**

Mode M: Manual Exposure

Take pictures at the selected aperture and shutter speed.

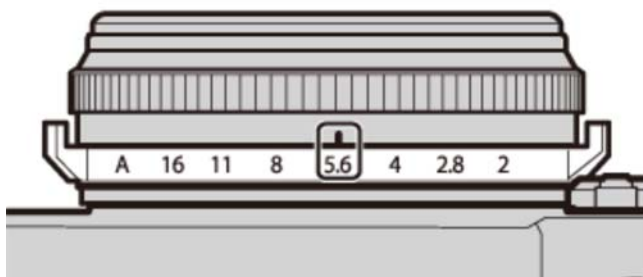

Aperture: **f/5.6**

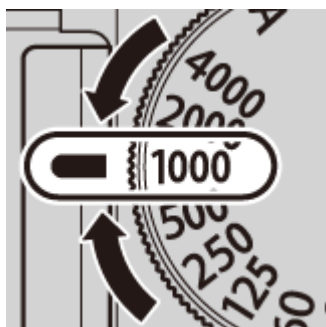



Shutter speed: **1/1000 s**

The [VIEW MODE] Button

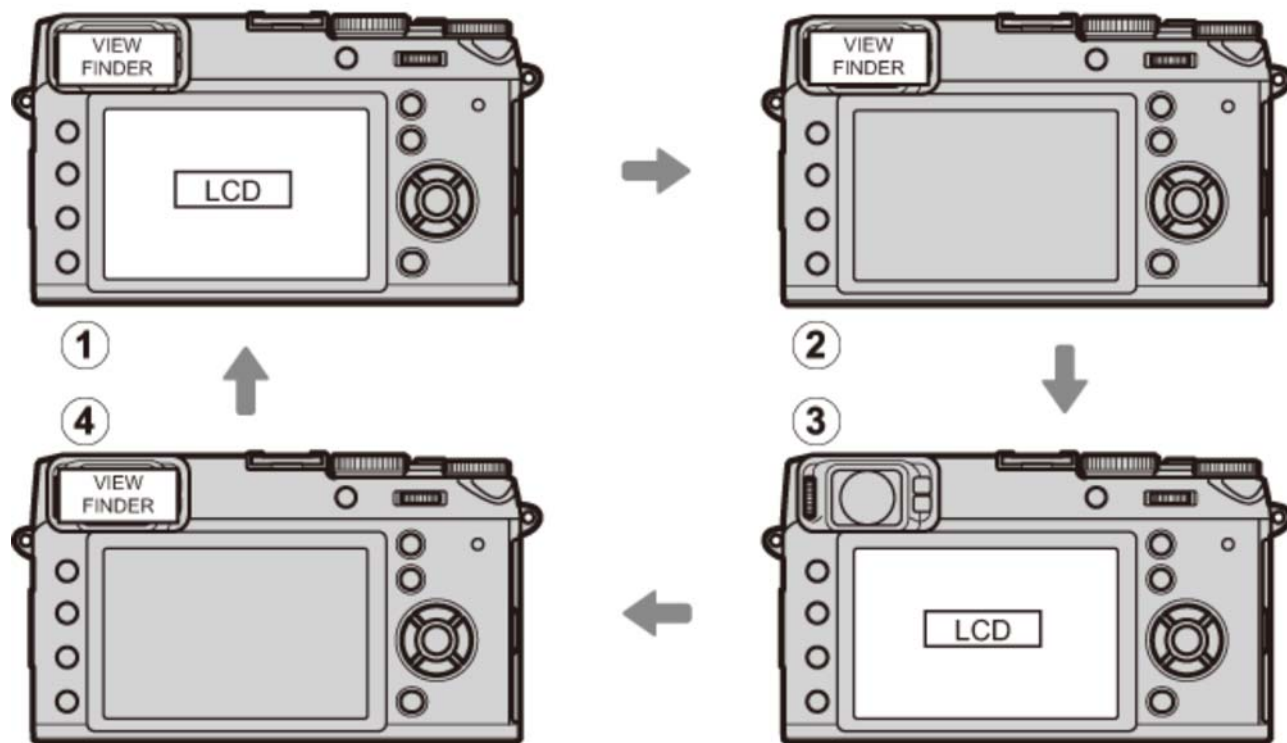
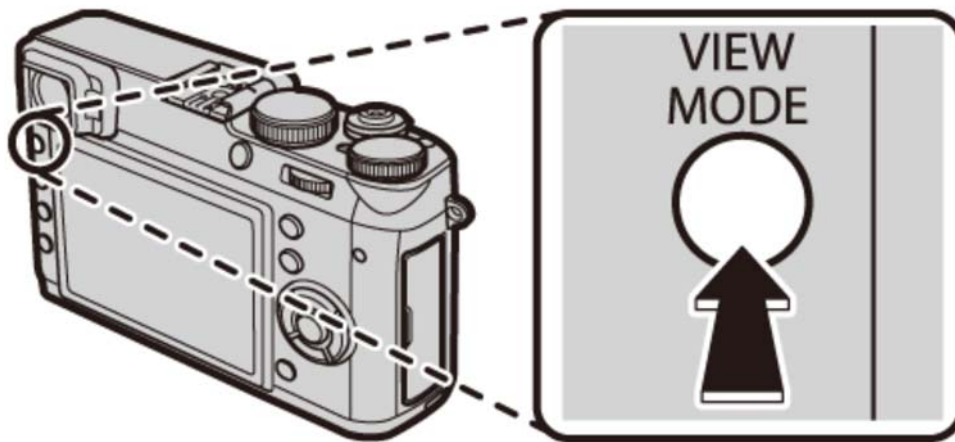
Press the [VIEW MODE] button to cycle through displays as shown below.



- ①  [EYE SENSOR]: Automatic display selection using eye sensor
- ② [VIEWFINDER ONLY]: Viewfinder only
- ③ [LCD ONLY]: LCD monitor only
- ④ [VIEWFINDER ONLY] + : Viewfinder only; eye sensor turns display on or off

The Eye Sensor

The eye sensor turns the viewfinder on when you put your eye to the viewfinder and turns it off when you take your eye away (note that the eye sensor may respond to objects other than your eye or to light shining directly on the sensor). If automatic display selection is enabled, the LCD monitor will turn on when the viewfinder turns off.

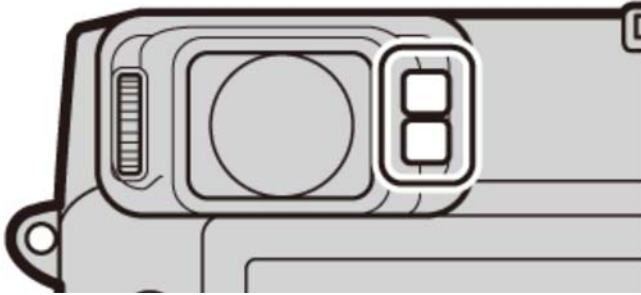

The Viewfinder Selector

Use the viewfinder selector to switch between the electronic viewfinder (EVF), the optical viewfinder (OVF), and a dual optical viewfinder/electronic range finder (ERF) display.

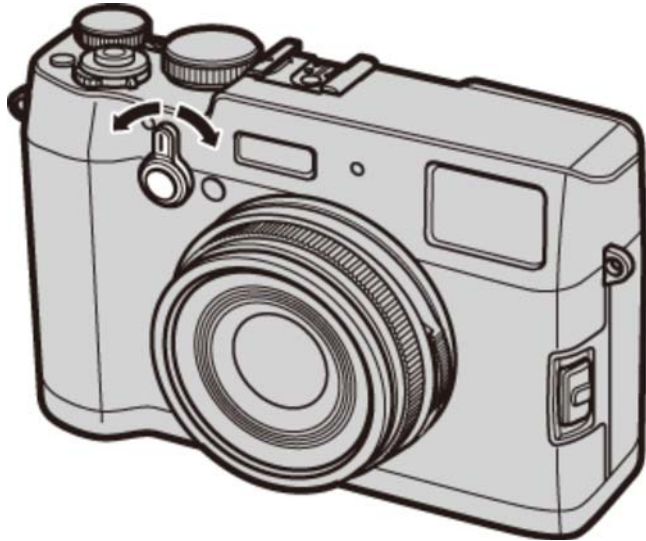

Rotate the selector as shown to choose from the following displays:



①

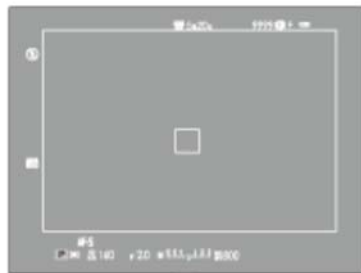

②

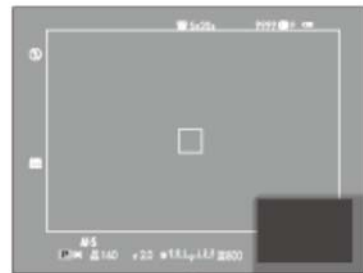

③

- ① EVF
- ② OVF
- ③ ERF (dual display)



The Hybrid (EVF/OVF/ERF) Viewfinder

The features of the different displays are described below.

Display	Description
OVF	The optical display is sharp and free of blur so that your subject's expression is always visible. In addition, the OVF shows the area just outside the frame, making it easier to compose shots on the fly. Because the viewfinder window is a slight distance from the lens, the area visible in photographs may however differ slightly from the display in the viewfinder due to parallax.
EVF	The live view display gives you a preview of the final picture (including depth of field, focus, exposure, and white balance) with exactly the same frame coverage.
ERF (dual display)	As for the optical viewfinder but with a focus preview. A magnified view of the current focus position is shown at the bottom right corner of the display.

 The brightness and clarity of the EVF and LCD monitor can be adjusted using the **[SCREEN SET-UP]** options in the setup menu.

See Also

 [\[SCREEN SET-UP\]](#) (The Setup Menu)

The [DISP/BACK] Button

The **[DISP/BACK]** button controls the display of indicators in the viewfinder and LCD monitor.

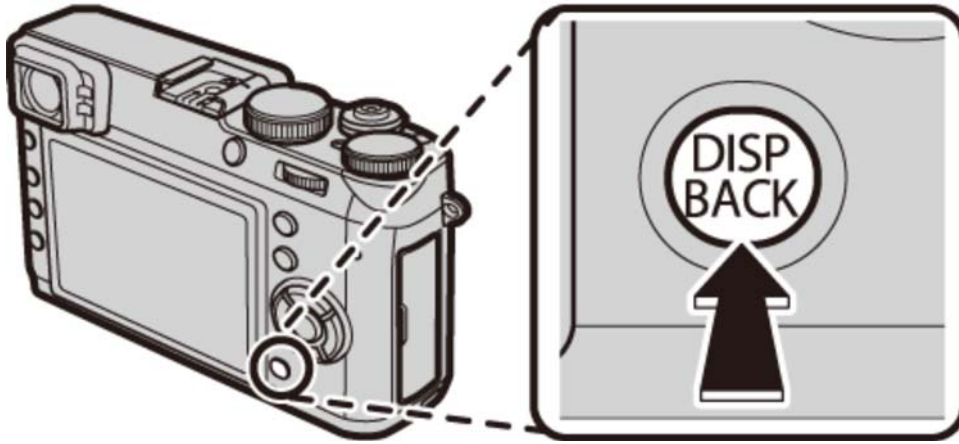

- Shooting: Optical Viewfinder
- Shooting: Electronic Viewfinder
- Shooting: LCD Monitor
- Playback: Electronic Viewfinder/LCD Monitor
- Standard Display

Shooting: Optical Viewfinder

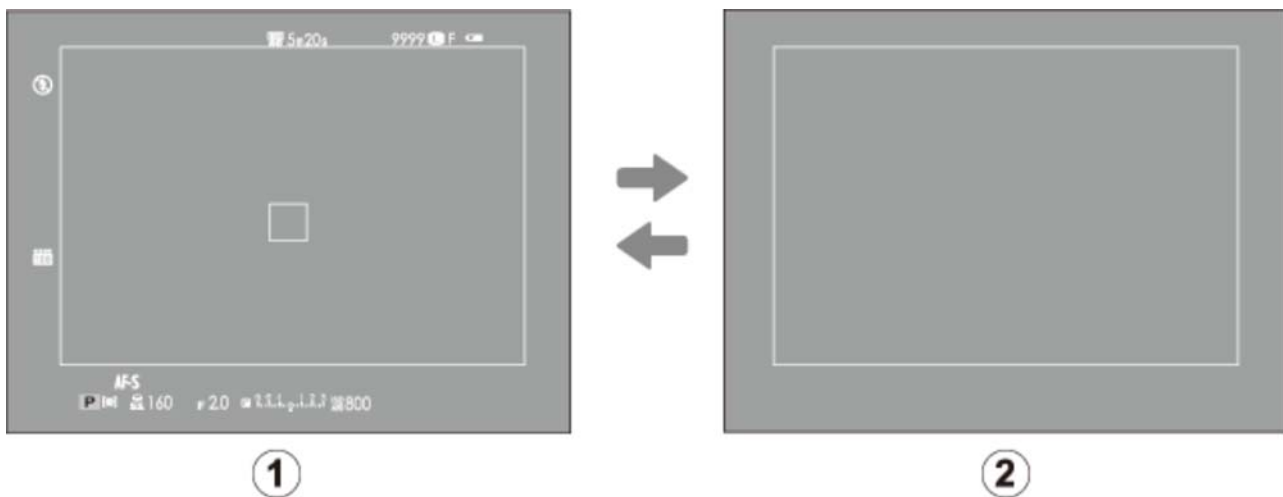

- ① Standard
- ② Information off

Shooting: Electronic Viewfinder

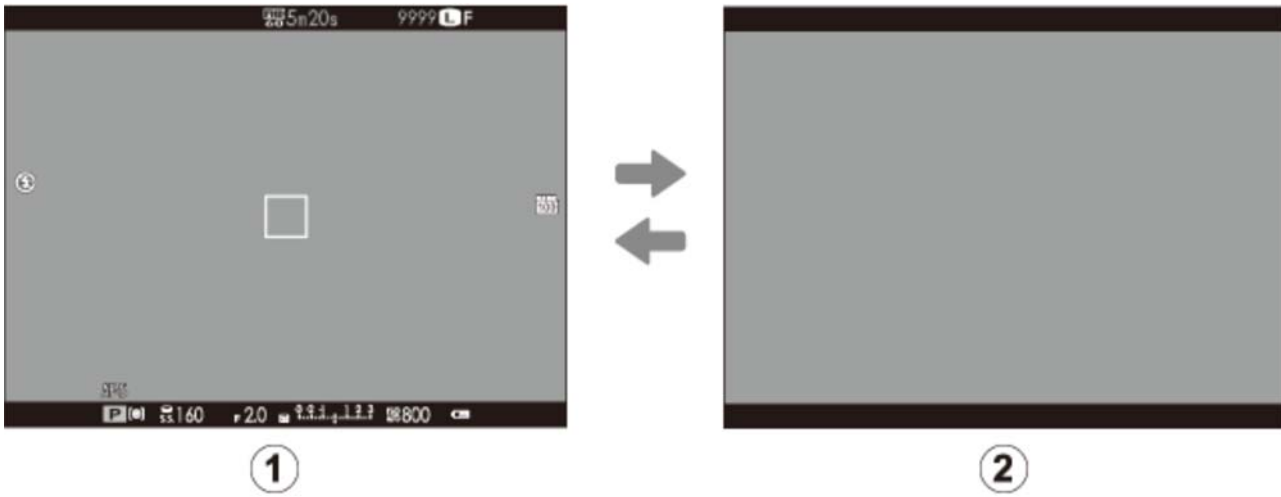

- ① Standard
- ② Information off

Shooting: LCD Monitor

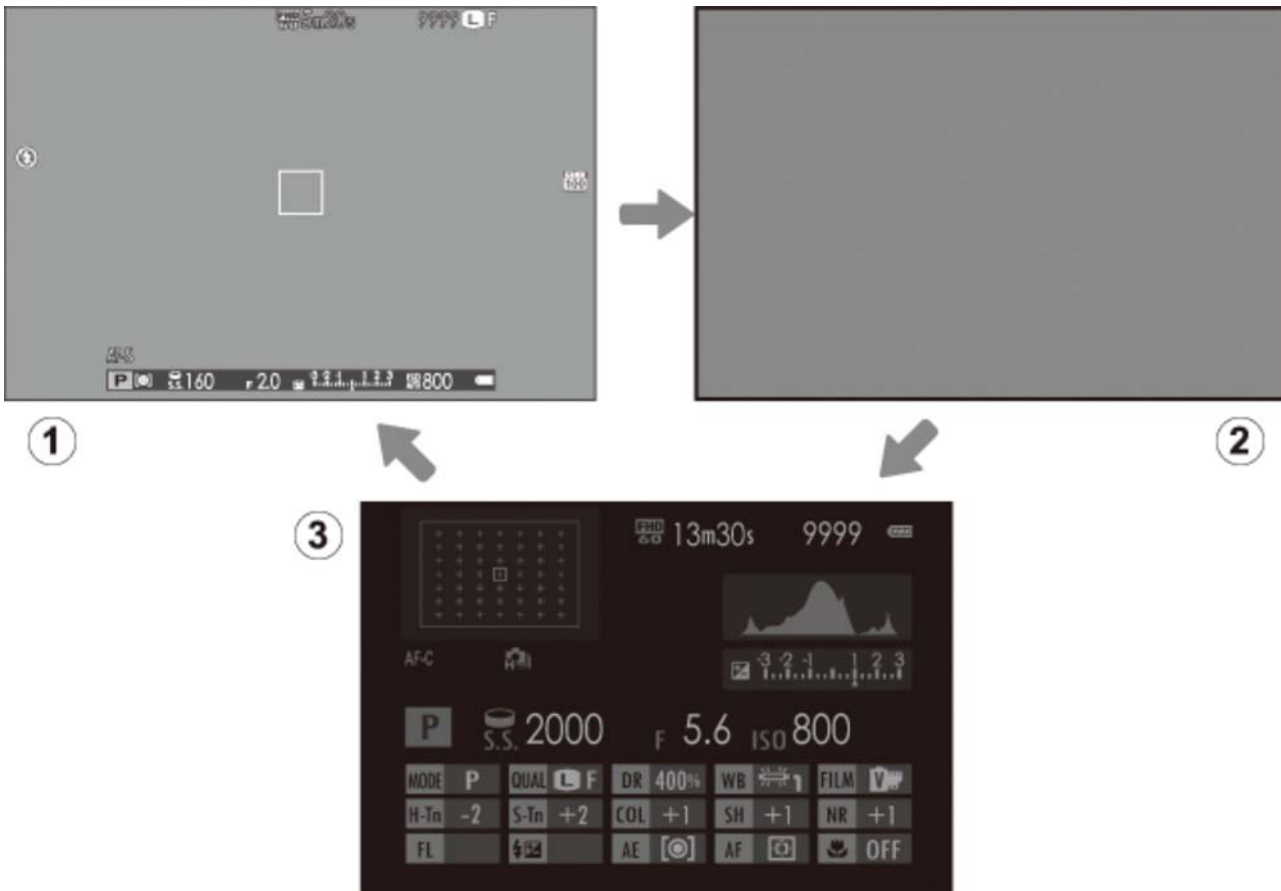

- ① Standard
- ② Information off
- ③ Info display

Playback: Electronic Viewfinder/LCD Monitor

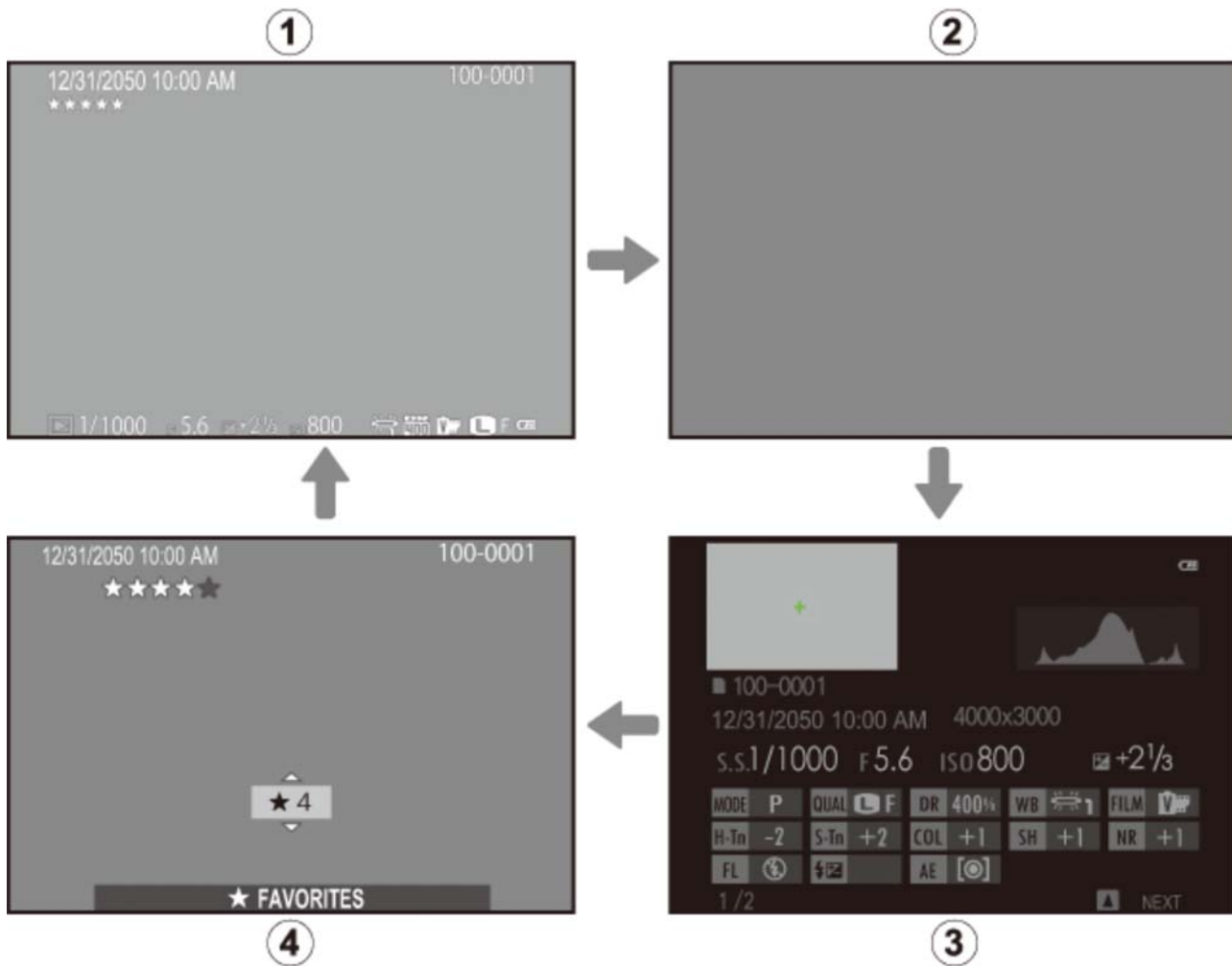

- ① Standard
- ② Information off
- ③ Info display
- ④ Favorites

❗ The optical viewfinder can not be used for playback.

Standard Display

The items shown in the standard optical viewfinder and electronic viewfinder/LCD monitor displays (display ①) can be selected as described below.

1. Select **[DISP. CUSTOM SETTING]** in the shooting menu.
2. Highlight **[OVF]** or **[EVF/LCD]** and press **[MENU/OK]**.
3. Highlight items and press **[MENU/OK]** to select or deselect. Selected items are indicated by a check mark.

<ul style="list-style-type: none"> ■ [FRAMING GUIDELINE] ■ [ELECTRONIC LEVEL] ■ [AF DISTANCE INDICATOR] ■ [MF DISTANCE INDICATOR] ■ [HISTOGRAM] ■ [APERTURE/S-SPEED/ISO] ■ [EXP. COMPENSATION] ■ [PHOTOMETRY] 	<ul style="list-style-type: none"> ■ [FLASH] ■ [WHITE BALANCE] ■ [FILM SIMULATION] ■ [DYNAMIC RANGE] ■ [FRAMES REMAINING] ■ [IMAGE SIZE/QUALITY] ■ [MOVIE MODE & REC. TIME] ■ [BATTERY LEVEL]
---	---
4. Press **[DISP/BACK]** to exit when settings are complete.

ELECTRONIC LEVEL

Selecting **[ELECTRONIC LEVEL]** displays a virtual horizon. The camera is level when the two lines overlap.

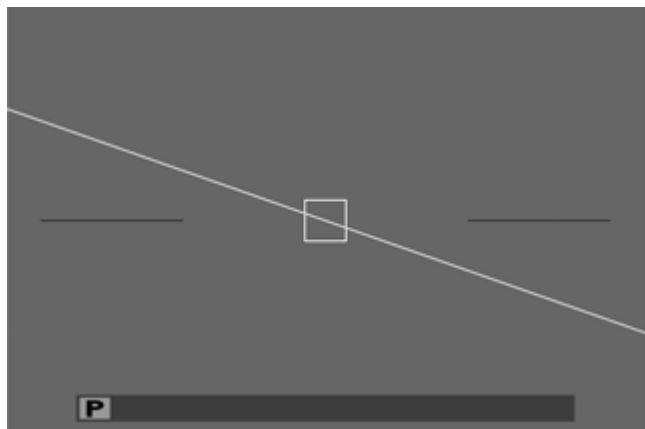

 The virtual horizon may not be displayed if the camera lens is pointed up or down.



Histograms

Histograms show the distribution of tones in the image. Brightness is shown by the horizontal axis, the number of pixels by the vertical axis.

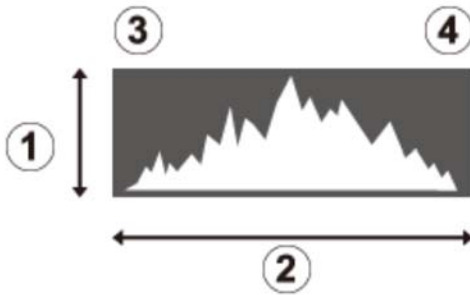

- ① No. of pixels
- ② Pixel brightness
- ③ Shadows
- ④ Highlights

Optimal exposure Pixels are distributed in an even curve throughout the tone range.



Overexposed Pixels are clustered on the right side of the graph.



Underexposed Pixels are clustered on the left side of the graph.



Diopter Adjustment

The camera is equipped with diopter adjustment to accommodate individual differences in vision. Rotate the diopter adjustment control until the viewfinder display is in sharp focus.

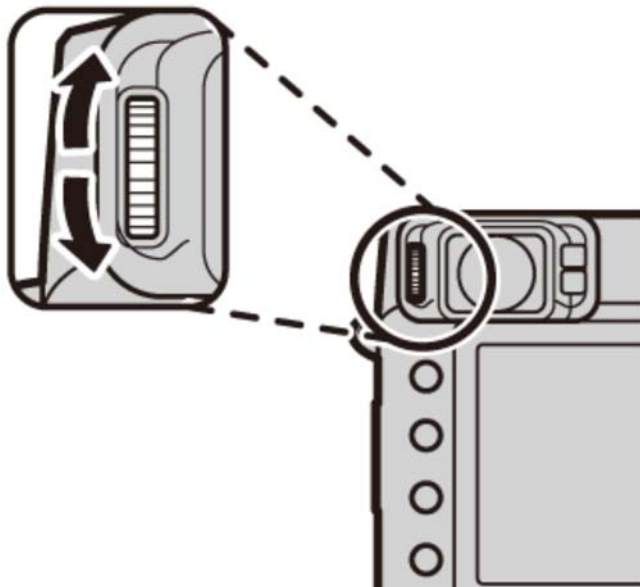

The Indicator Lamp

The indicator lamp shows camera status as follows:

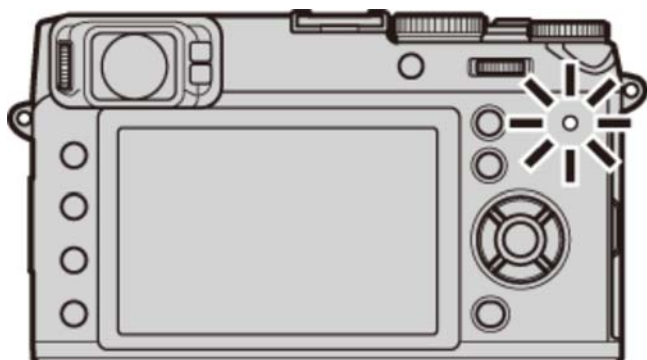

Glow green Focus locked.

Blinks green Blur, focus, or exposure warning. Picture can be taken.

Blinks green and orange Recording pictures. Additional pictures can be taken.

Glow orange Recording pictures. No additional pictures can be taken at this time.

Blinks orange Flash charging; flash will not fire when picture is taken.

Blinks red Lens or memory error.

 Warnings may also appear in the display.

 The indicator lamp turns off when the viewfinder is in use.

Battery Charging Status







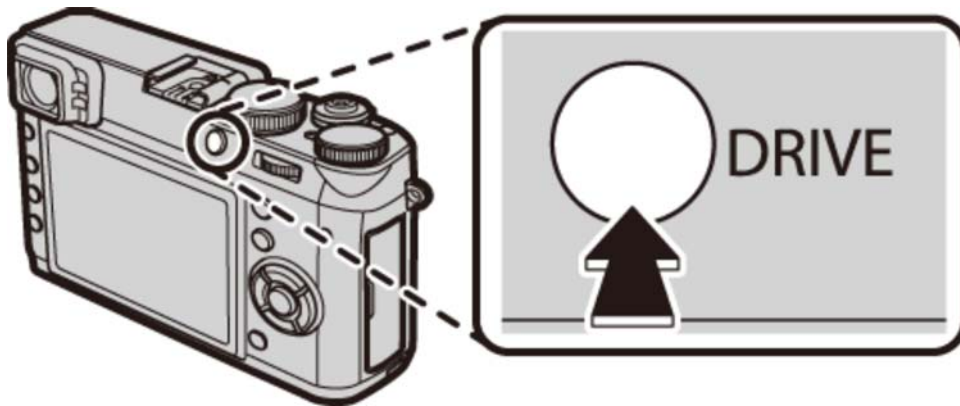

If the camera is connected to a computer to charge the battery, the indicator lamp will show charging status when the camera is off.

Indicator lamp	Battery status
On	Battery charging.
Off	Charging complete.
Blinks	Battery fault.

The [DRIVE] Button

Use the [DRIVE] button to choose drive mode (burst and bracketing) options.



-  [STILL IMAGE]
-  [CONTINUOUS SHOOTING]
-  [AE BKT]
-  [ISO BKT]
-  [FILM SIMULATION BKT]
-  [WHITE BALANCE BKT]
-  [DYNAMIC RANGE BKT]
-  [MULTIPLE EXPOSURE]
-  [MOTION PANORAMA]

 In Advanced Filter mode, drive options are unavailable and only one shot will be taken each time the shutter button is pressed.

Camera Displays

- ➔ Shooting: Optical Viewfinder
- ➔ Shooting: Electronic Viewfinder/LCD Monitor
- ➔ Playback: Electronic Viewfinder/LCD Monitor

Shooting: Optical Viewfinder

The following types of indicator may be displayed during shooting.

❗ In the description that follows, all available indicators are shown for illustrative purposes; the indicators actually displayed vary with camera settings.

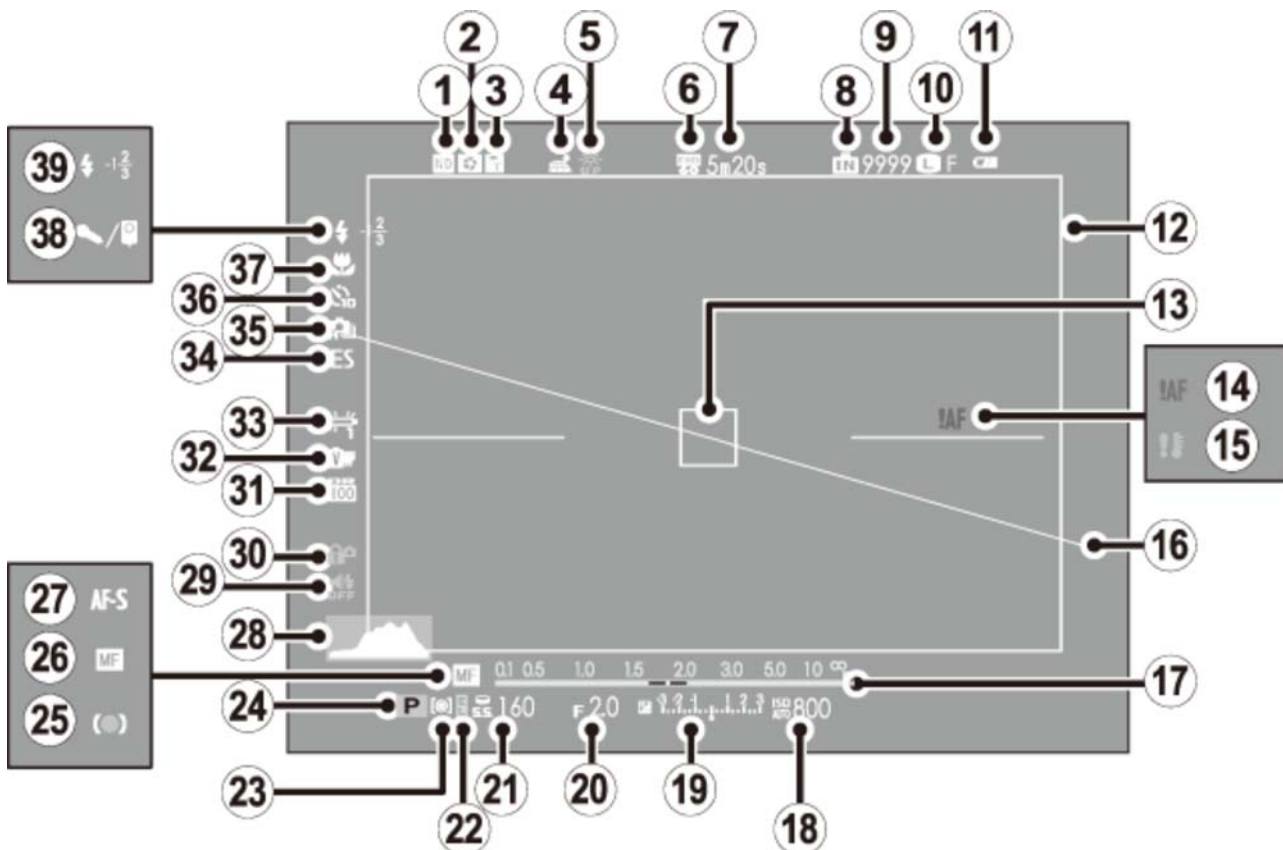

- | | |
|---|---------------------------|
| ① ND (Neutral Density) filter indicator | ②① Shutter speed |
| ② Depth-of-field preview | ②② AE lock indicator |
| ③ Conversion lens | ②③ Metering |
| ④ Location data download status | ②④ Shooting mode |
| ⑤ Monitor sunlight mode | ②⑤ Focus indicator |
| ⑥ Movie mode | ②⑥ Manual focus indicator |
| ⑦ Time remaining | ②⑦ Focus mode |
| ⑧ Internal memory indicator * | ②⑧ Histogram |
| ⑨ Number of available frames | ②⑨ Silent mode indicator |
| ⑩ Image size/quality | ③⑩ Control lock |
| ⑪ Battery level | ③① Dynamic range |

- 12 Bright frame
- 13 Focus frame
- 14 Focus warning
- 15 Temperature warning
- 16 Electronic level
- 17 Distance indicator
- 18 Sensitivity
- 19 Exposure indicator
- 20 Aperture
- 32 Film simulation
- 33 White balance
- 34 Shutter type
- 35 Continuous mode
- 36 Self-timer indicator
- 37 Macro (close-up) mode
- 38 Microphone/remote release
- 39 Flash mode/Flash compensation

* : indicates that no memory card is inserted and that pictures will be stored in the camera's internal memory.

The Electronic Range Finder (ERF)

To view the electronic range finder (ERF), rotate the viewfinder selector as shown when the optical viewfinder is displayed.

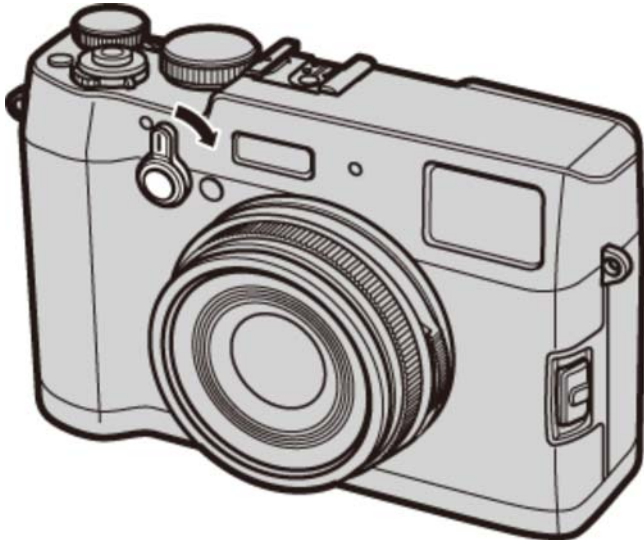

Shooting: Electronic Viewfinder/LCD Monitor

The following types of indicator may be displayed during shooting.

❗ In the description that follows, all available indicators are shown for illustrative purposes; the indicators actually displayed vary with camera settings.

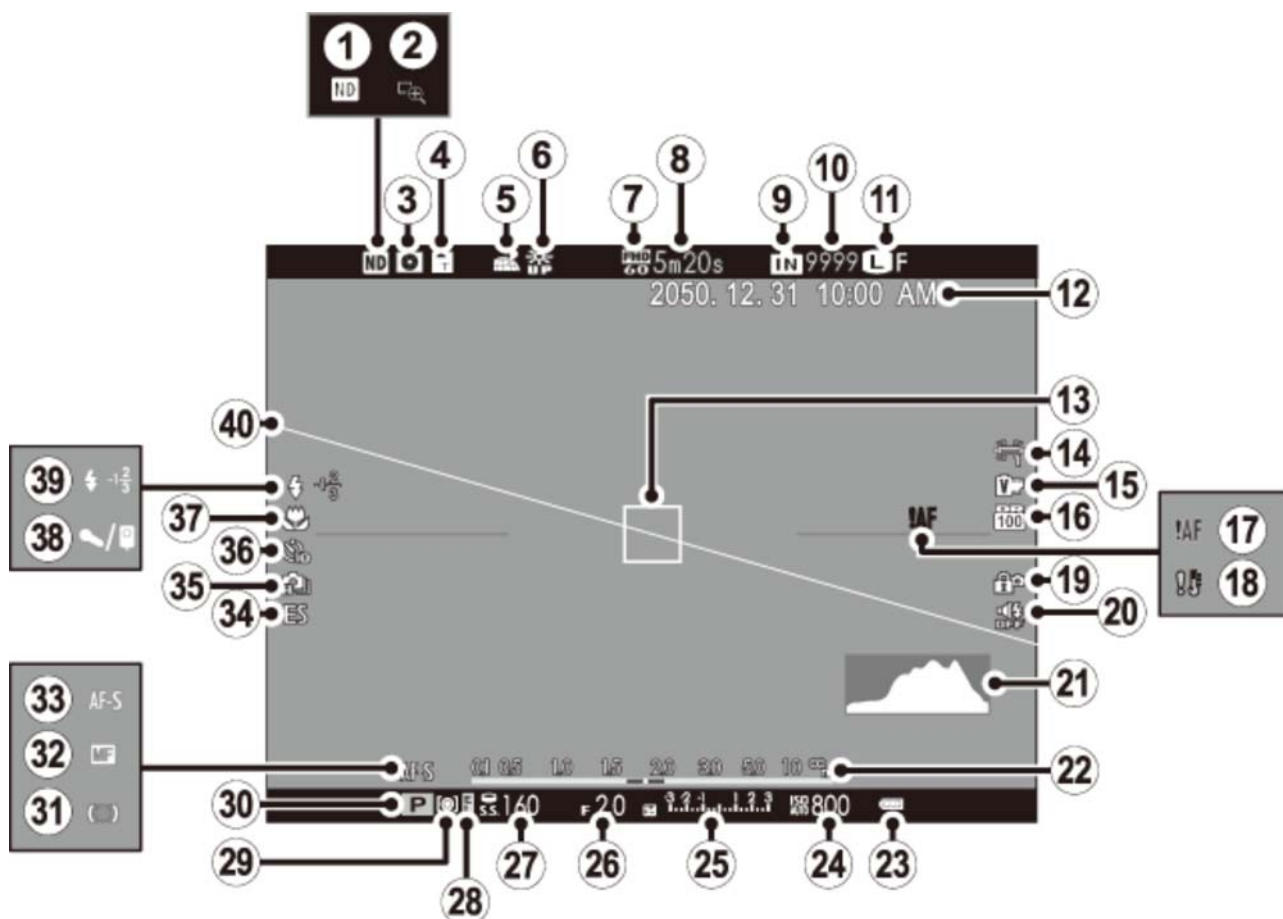

- | | |
|---|-----------------------|
| ① ND (Neutral Density) filter indicator | ②① Histogram |
| ② Focus check | ②② Distance indicator |
| ③ Depth-of-field preview | ②③ Battery level |
| ④ Conversion lens | ②④ Sensitivity |
| ⑤ Location data download status | ②⑤ Exposure indicator |
| ⑥ Monitor sunlight mode | ②⑥ Aperture |
| ⑦ Movie mode | ②⑦ Shutter speed |
| ⑧ Time remaining | ②⑧ AE lock indicator |
| ⑨ Internal memory indicator * | ②⑨ Metering |
| ⑩ Number of available frames | ③⑩ Shooting mode |

- ⑪ Image size/quality
- ⑫ Date and time
- ⑬ Focus frame
- ⑭ White balance
- ⑮ Film simulation
- ⑯ Dynamic range
- ⑰ Focus warning
- ⑱ Temperature warning
- ⑲ Control lock
- ⑳ Silent mode indicator
- ㉑ Focus indicator
- ㉒ Manual focus indicator
- ㉓ Focus mode
- ㉔ Shutter type
- ㉕ Continuous mode
- ㉖ Self-timer indicator
- ㉗ Macro (close-up) mod
- ㉘ Microphone/remote release
- ㉙ Flash mode/Flash compensation
- ㉚ Electronic level

* **IN**: indicates that no memory card is inserted and that pictures will be stored in the camera's internal memory.

The Viewfinder Display

When **[ON]** is selected for **[SCREEN SET-UP] > [EVF AUTOROTATE DISPLAYS]** in the setup menu, the indicators in the viewfinder automatically rotate to match camera orientation.

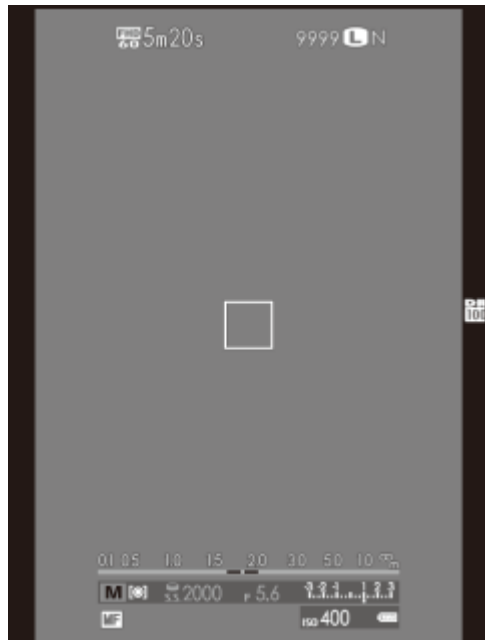

 The display in the LCD monitor is unaffected.

 The brightness and clarity of the EVF and LCD monitor can be adjusted using the **[SCREEN SET-UP]** options in the setup menu.

See Also

- ➔ [\[SCREEN SET-UP\]](#) (The Setup Menu)

Playback: Electronic Viewfinder/LCD Monitor

The following types of indicator may be displayed during playback.

- ❗ In the description that follows, all available indicators are shown for illustrative purposes; the indicators actually displayed vary with camera settings.
- ❗ The optical viewfinder can not be used for playback.

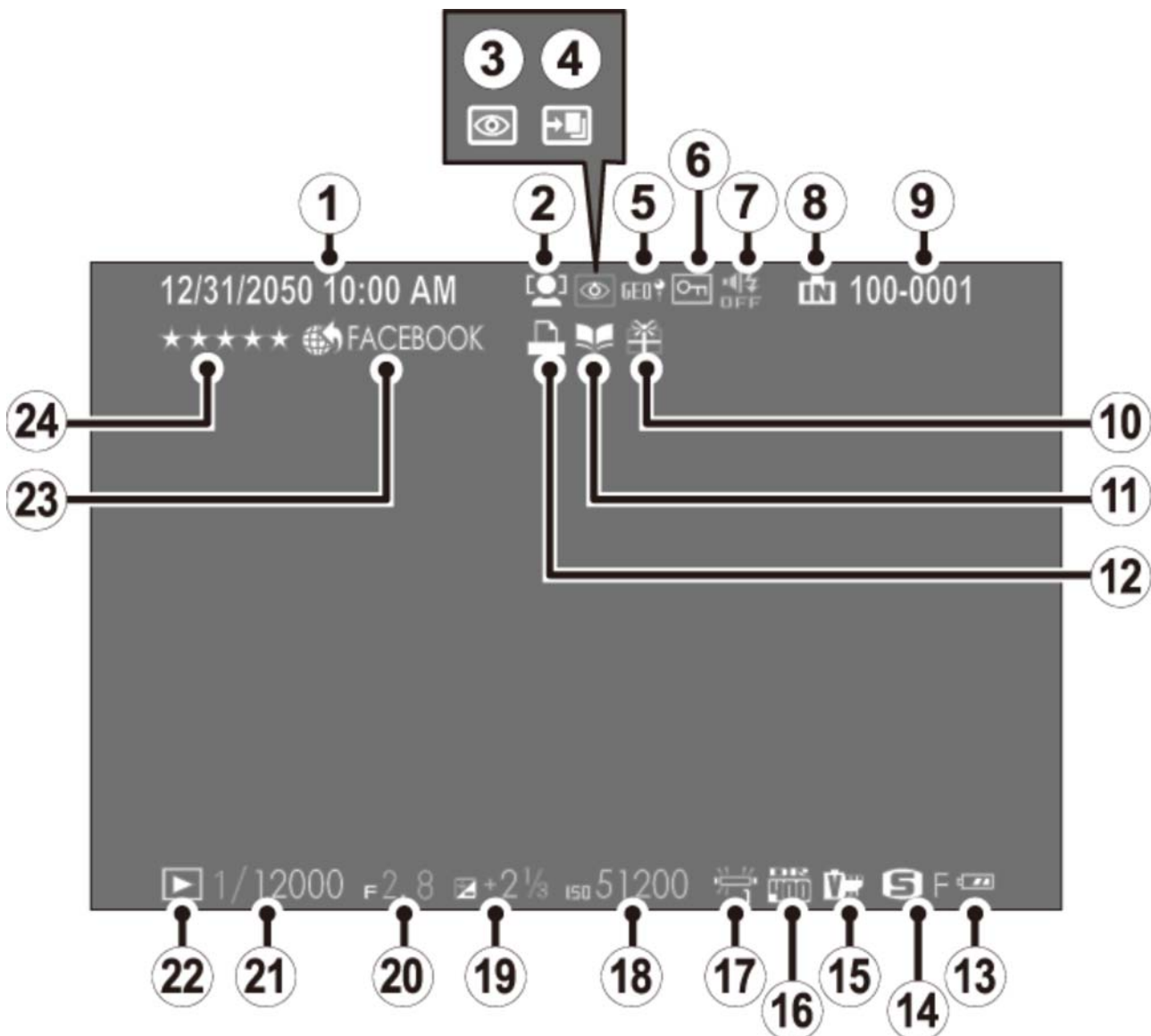

- | | |
|--|-------------------------|
| ① Date and time | ⑭ Image size/quality |
| ② Intelligent face detection indicator | ⑮ Film simulation |
| ③ Red-eye removal indicator | ⑯ Dynamic range |
| ④ Pro focus mode, pro low-light mode | ⑰ White balance |
| ⑤ Location data | ⑱ Sensitivity |
| ⑥ Protected image | ⑲ Exposure compensation |

⑦ Silent mode indicator

⑧ Internal memory indicator

⑨ Frame number

⑩ Gift image

⑪ Photobook assist

⑫ DPOF print indicator

⑬ Battery level

⑳ Aperture

㉑ Shutter speed

㉒ Playback mode indicator

㉓ Mark for upload to

㉔ Favorites

First Steps

- ➔ [Attaching the Strap](#)
- ➔ [Charging the Battery](#)
- ➔ [Inserting the Battery and a Memory Card](#)
- ➔ [Turning the Camera on and Off](#)
- ➔ [Basic Setup](#)

Attaching the Strap

Attach the strap clips to the camera and then attach the strap.

1. Open a strap clip.

Use the clip attaching tool to open a strap clip, making sure that the tool and clip are in the orientations shown.

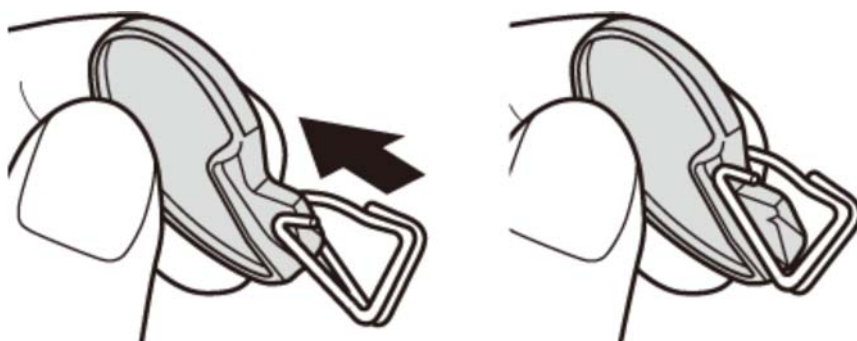

⚠ Keep the tool in a safe place. You will need it to open the strap clips when removing the strap.

2. Place the strap clip on an eyelet.

Hook the strap eyelet in the clip opening. Remove the tool, using the other hand to keep the clip in place.

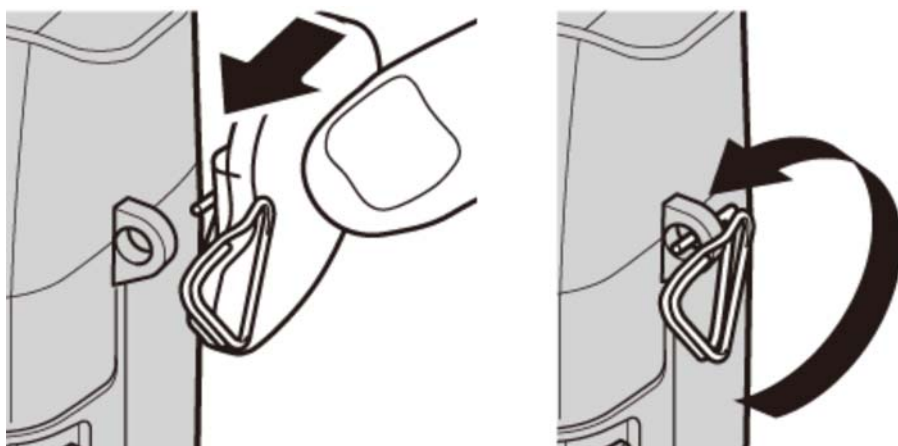

3. Pass the clip through the eyelet.

Rotate the clip fully through the eyelet until it clicks closed.



4. Attach a protective cover.

Place a protective cover over the eyelet as shown, with the black side of the cover toward the camera. Repeat Steps 1–4 for the second eyelet.

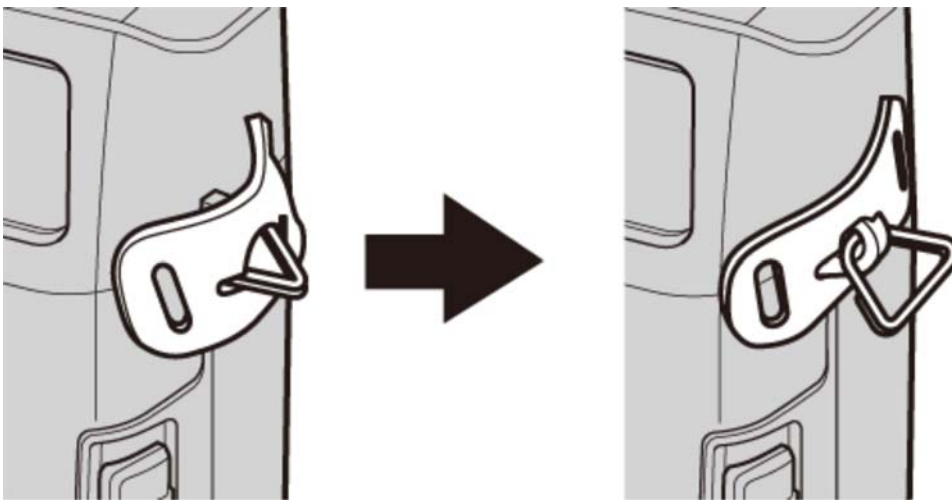

5. Insert the strap.

Insert the strap through a protective cover and strap clip.

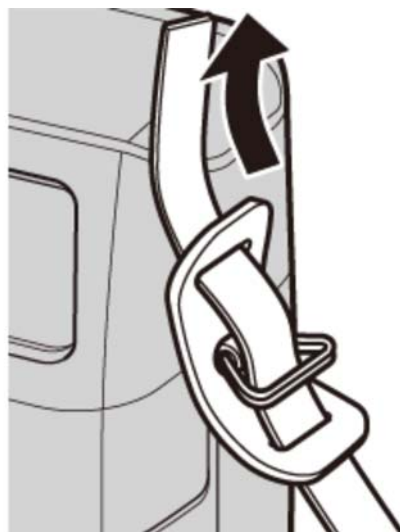

6. Fasten the strap.

Fasten the strap as shown. Repeat Steps 5–6 for the second eyelet.

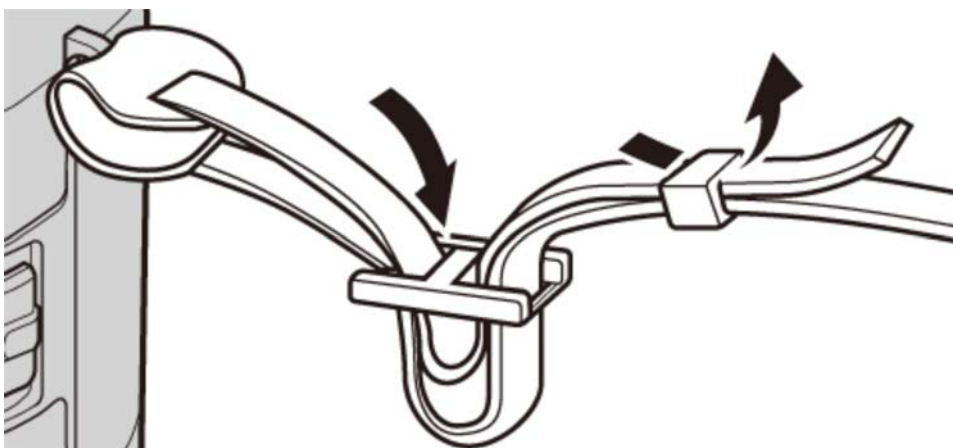

! To avoid dropping the camera, be sure the strap is correctly secured.

Charging the Battery

The battery is not charged at shipment. Charge the battery before use.

- The camera uses an NP-95 rechargeable battery.
- The battery takes about 4 hours to fully charge.

1. Place the battery in the charger.

Insert the battery in the orientation indicated by the \ominus \updownarrow \oplus labels.

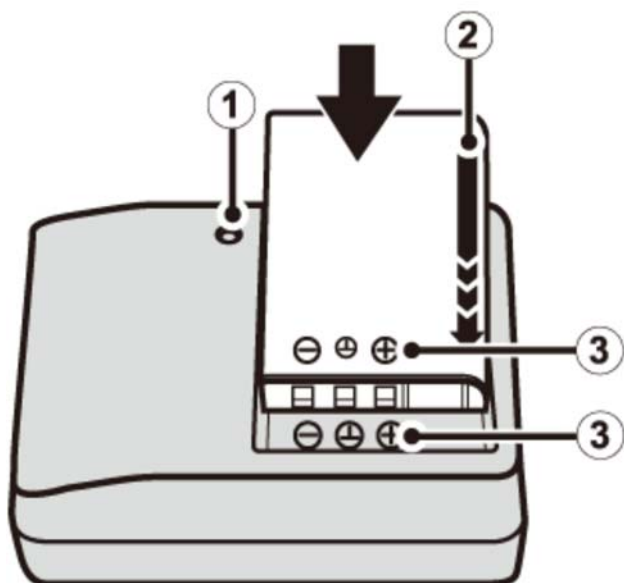

① Charge lamp

② Arrow

③ \ominus \updownarrow \oplus label

 Attach the supplied adapter before charging the battery (the adapter is attached at shipment).

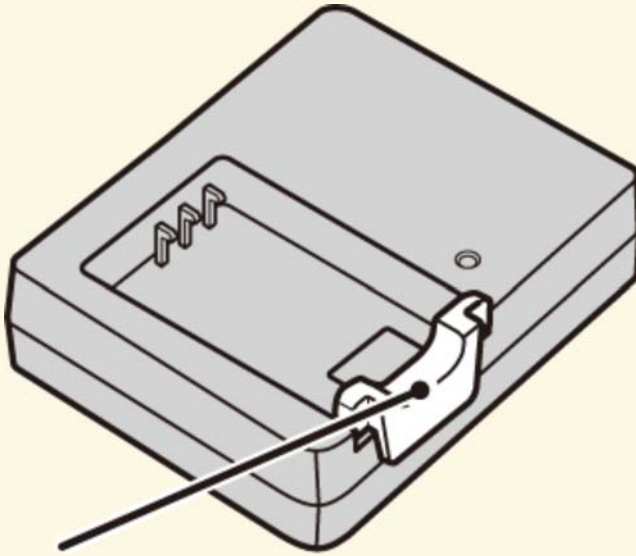

Adapter

 The supplied AC cord is for use exclusively with the supplied battery charger. Do not use the supplied charger with other cords or the supplied cord with other devices.

2. Plug the charger in.

Plug the charger into an indoor power outlet. The charging indicator will light.

3. Charge the battery.

Remove the battery when charging is complete.

 The Charging Indicator

The charging indicator shows battery charge status as follows:

Charging indicator	Battery status	Action
Off	Battery not inserted.	Insert the battery.
	Battery fully charged.	Remove the battery.
On	Battery charging.	—
Blinks	Battery fault.	Unplug the charger and remove the battery.

- ❗ Unplug the charger when it is not in use.
- ❗ Remove dirt from the battery terminals with a clean, dry cloth. Failure to observe this precaution could prevent the battery from charging.
- ❗ Do not affix stickers or other objects to the battery. Failure to observe this precaution could make it impossible to remove the battery from the camera.
- ❗ Do not short the battery terminals. The battery could overheat.
- ❗ Read the cautions in "The Battery and Power Supply".
- ❗ Use only battery chargers designated for use with the battery. Failure to observe this precaution could result in product malfunction.
- ❗ Do not remove the labels from the battery or attempt to split or peel the outer casing.
- ❗ The battery gradually loses its charge when not in use. Charge the battery one or two days before use.
- ❗ Charging times may increase at very low or very high temperatures.

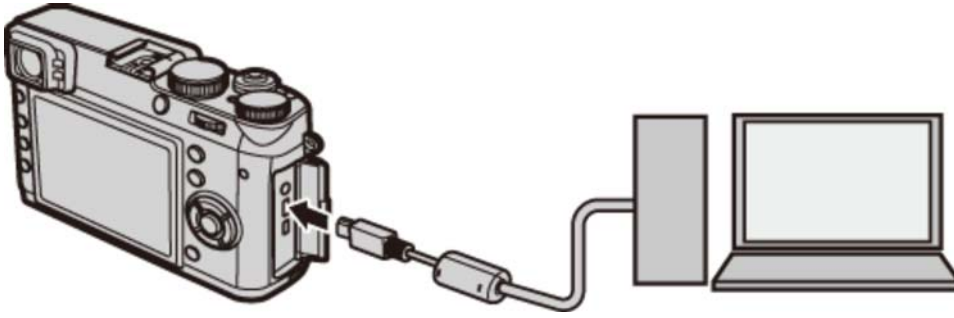

Charging via a computer

The battery can be charged by connecting the camera to a computer. Connect the supplied USB cable as shown, making sure the connectors are fully inserted.



- ❗ Connect the camera directly to the computer; do not use a USB hub or keyboard.
- ❗ If the computer goes into sleep mode while charging, charging will stop. To continue charging, disable sleep mode on the computer, and disconnect and connect the USB cable.
- ❗ Charging may be impossible depending on computer specifications, settings or conditions.

✎ The battery status icons show battery charge status when the camera is turned on, and the indicator lamp shows it when the camera is turned off.

Battery status icon when camera on	Indicator lamp when camera off	Battery status
 (yellow)	On	Battery charging.
 (green)	Off	Charging complete.
 (red)	Blinks	Battery fault.

Inserting the Battery and a Memory Card

Insert the battery and memory card as described below.

1. Open the battery-chamber cover.

Slide the battery-chamber latch as shown and open the battery-chamber cover.

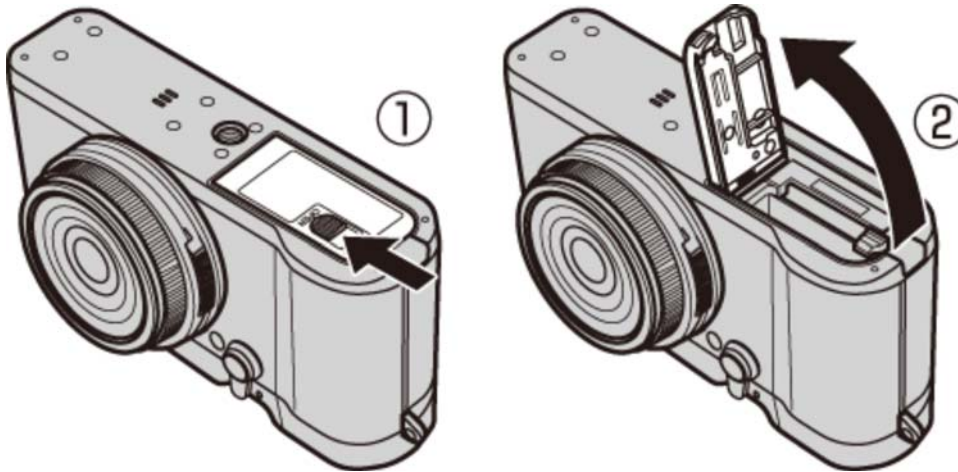

- ⚠ Do not open the battery-chamber cover when the camera is on. Failure to observe this precaution could damage image files or memory cards.
- ⚠ Do not use excessive force when handling the battery-chamber cover.

2. Insert the battery.

Using the battery to keep the battery latch pressed to one side, insert the battery contacts first in the direction shown by the arrow. Confirm that the battery is securely latched.

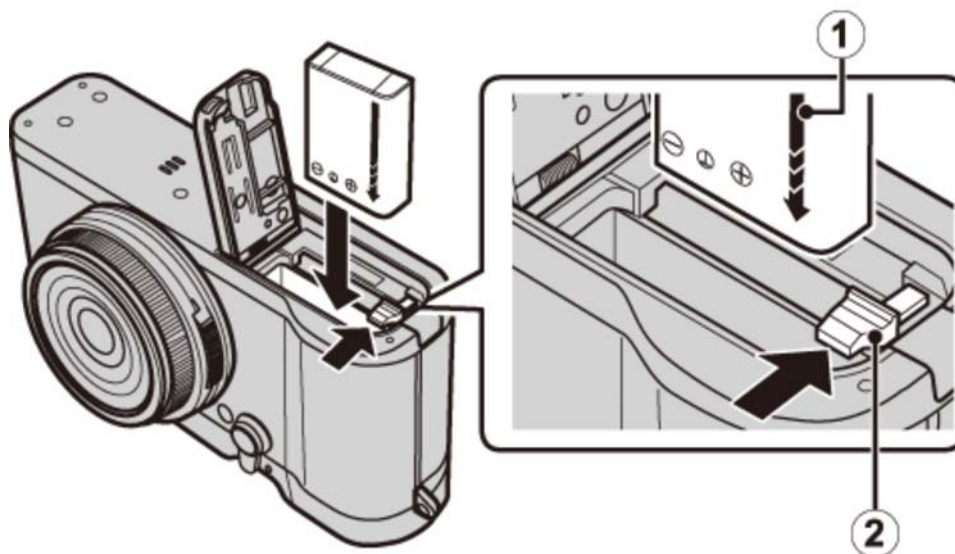

① Arrow

② Battery latch

⚠ Insert the battery in the orientation shown. ***Do not use force or attempt to insert the battery upside down or backwards.*** The battery will slide in easily in the correct orientation.

3. Insert the memory card.

Holding the memory card in the orientation shown, slide it in until it clicks into place at the back of the slot.

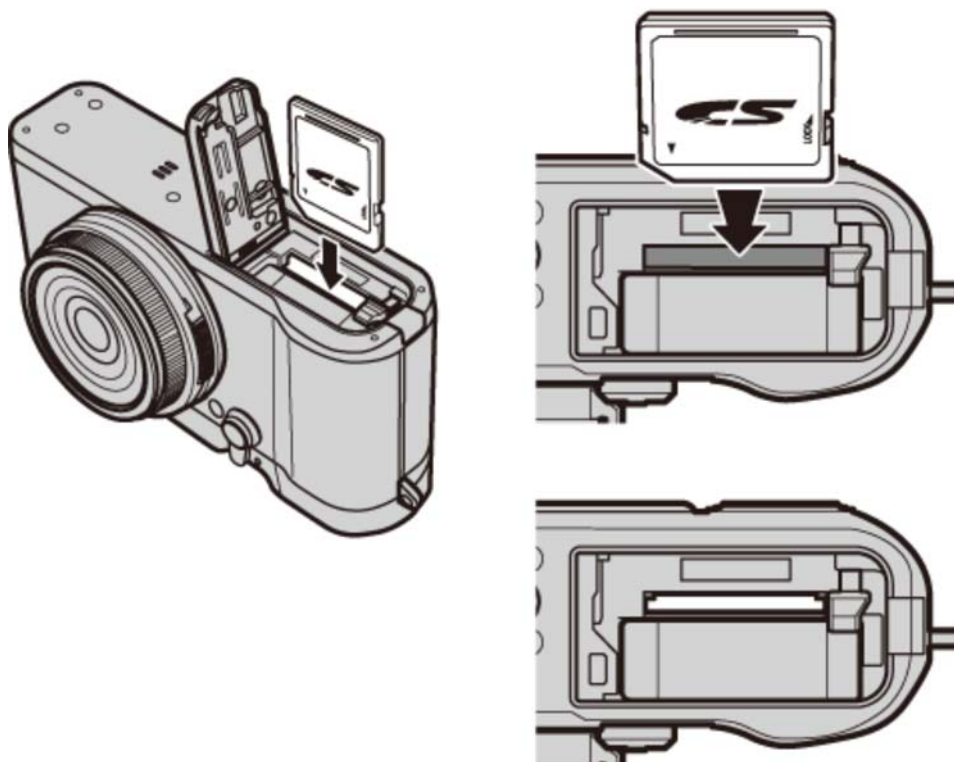

⚠ Be sure card is in the correct orientation; do not insert at an angle or use force. If the memory card is not correctly inserted or no memory card is inserted,  will appear in the LCD monitor and internal memory will be used for recording and playback.

4. Close the battery-chamber cover.

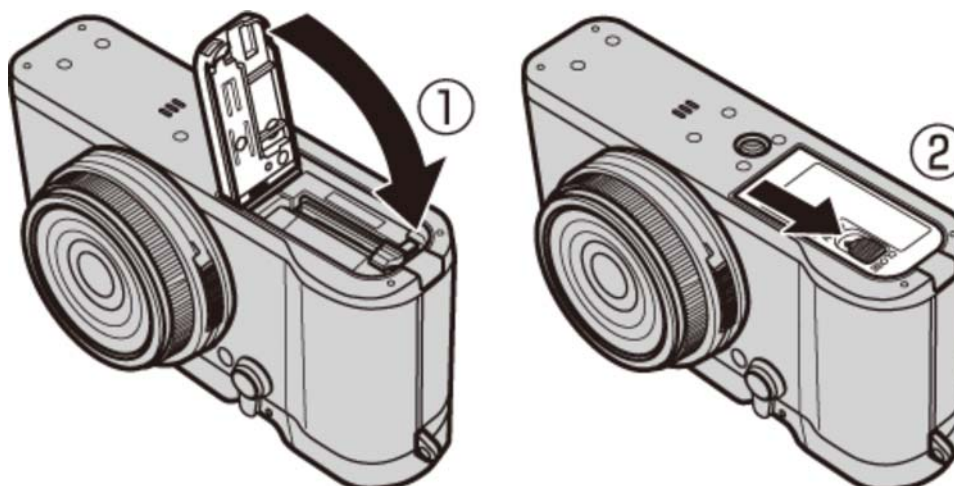

Removing the Battery and Memory Card

Before removing the battery or memory card, **turn the camera off** and open the battery-chamber cover.

To remove the battery, press the battery latch to the side, and slide the battery out of the camera as shown.

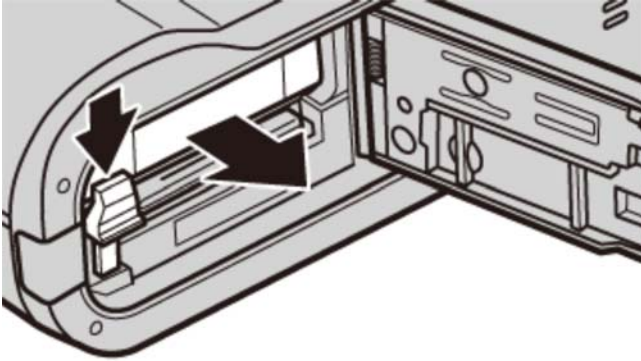

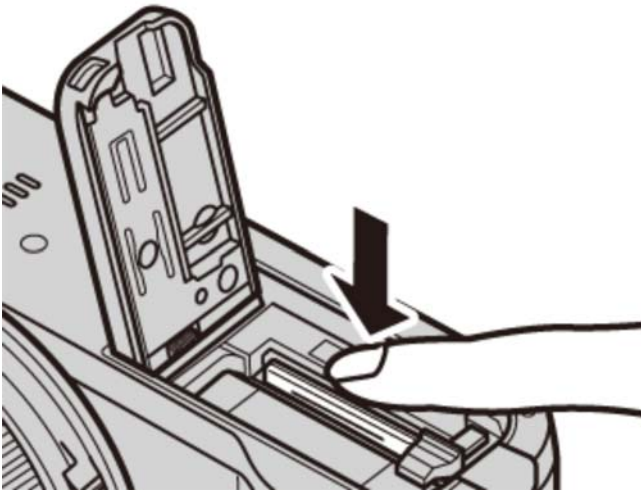

To remove the memory card, press it in and release it slowly. The card can then be removed by hand. When a memory card is removed, the card could come out of the slot too quickly. Use your finger to hold it and gently release the card.

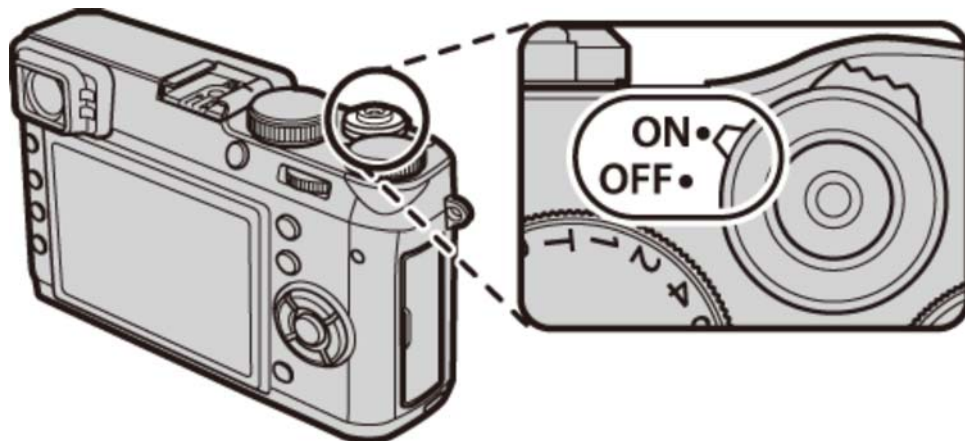

Turning the Camera on and Off

Rotate the **[ON/OFF]** switch to **[ON]** to turn the camera on. Select **[OFF]** to turn the camera off.



- ✎ Press the  button to start playback. Press the shutter button halfway to return to shooting mode.
- ✎ The camera will turn off automatically if no operations are performed for the length of time selected for **[POWER MANAGEMENT] > [AUTO POWER OFF]** in the setup menu. To reactivate the camera after it has turned off automatically, press the shutter button halfway or turn the **[ON/OFF]** switch to **[OFF]** and then back to **[ON]**.

- ⚠ Fingerprints and other marks on the lens or viewfinder can affect pictures or the view through the viewfinder. Keep the lens and viewfinder clean.

Battery Level

After turning the camera on, check the battery level in the display.

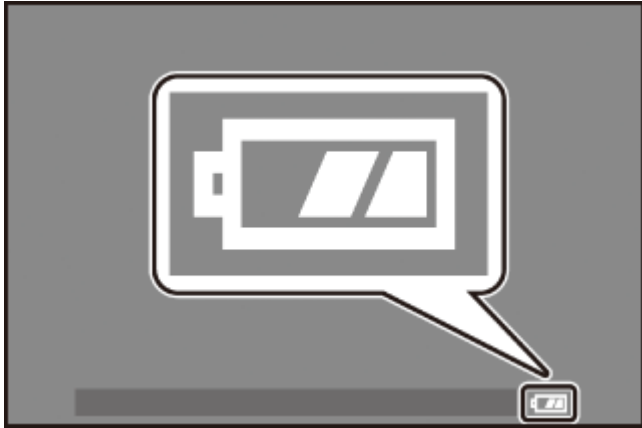

	Battery close to fully charged.
	Battery about two-thirds charged.
	Battery about one-third charged. Charge as soon as possible.
 (red)	Battery exhausted. Turn camera off and recharge battery.

Basic Setup

A language-selection dialog is displayed the first time the camera is turned on. Set up the camera as described below (you can reset the clock or change languages at any time using the **[DATE/TIME]** or **[言語/LANG.]** options in the setup menu).

Using the Selector

Press the selector up, down, left, or right to highlight items and press **[MENU/OK]** to select.

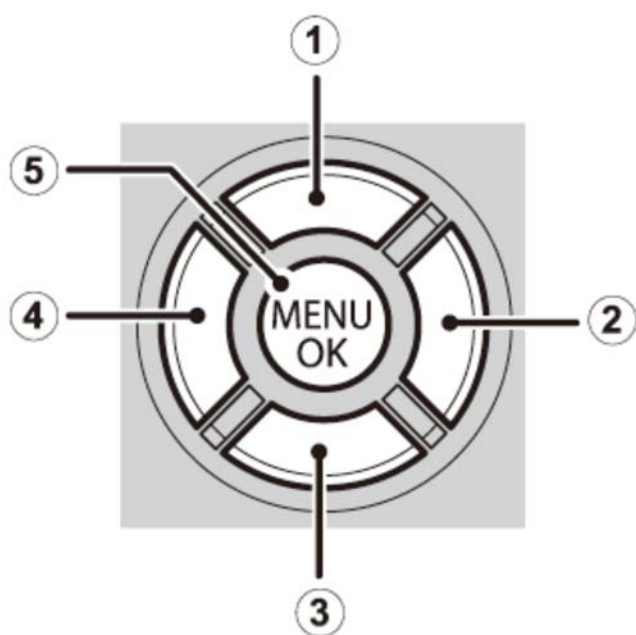

- ① Move cursor up
- ② Move cursor right
- ③ Move cursor down
- ④ Move cursor left
- ⑤ Select highlighted item

1. Turn the camera on.

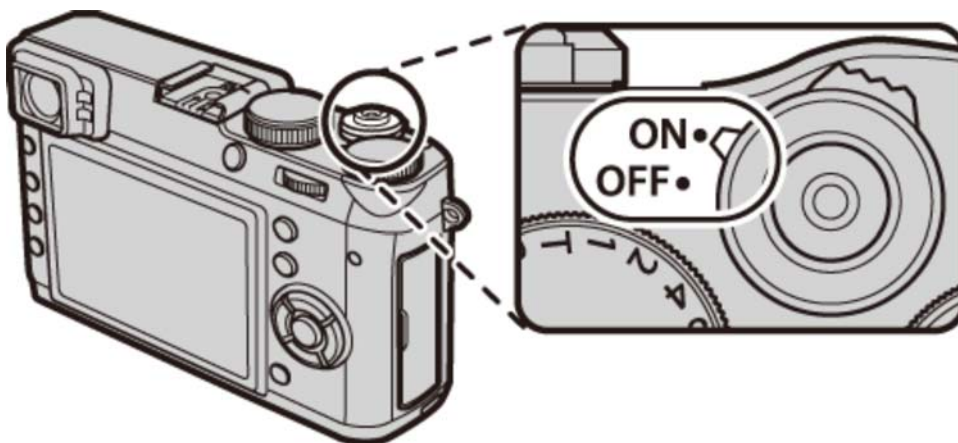

2. Highlight a language and press **[MENU/OK]**.

 Press **[DISP/BACK]** to skip the current step. Any steps you skip will be displayed the next time the camera is turned on.

3. The date and time will be displayed. Press the selector left or right to highlight the year, month, day, hour, or minute and press up or down to change. To change the order in which the year, month, and day are displayed, highlight the date format and press the selector up or down. Press **[MENU/OK]** when settings are complete.

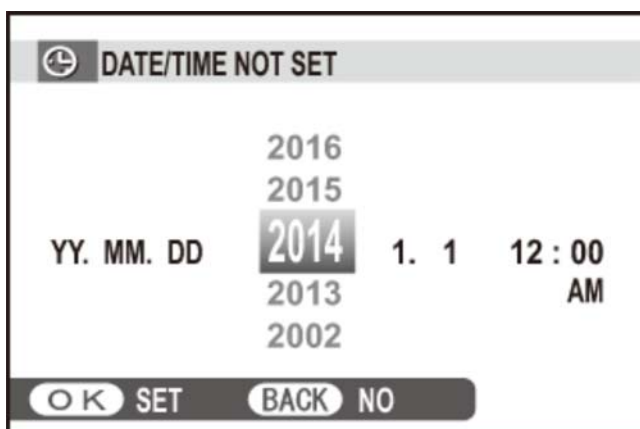

 If the battery is removed for an extended period, the camera clock will be reset and the language-selection dialog will be displayed when the camera is turned on.

Basic Photography and Playback

- ➔ [Taking Photographs](#)
- ➔ [Viewing Pictures](#)
- ➔ [Deleting Pictures](#)

Taking Photographs

This section describes how to take pictures using program AE (mode **[P]**).

1. Adjust settings for program AE.

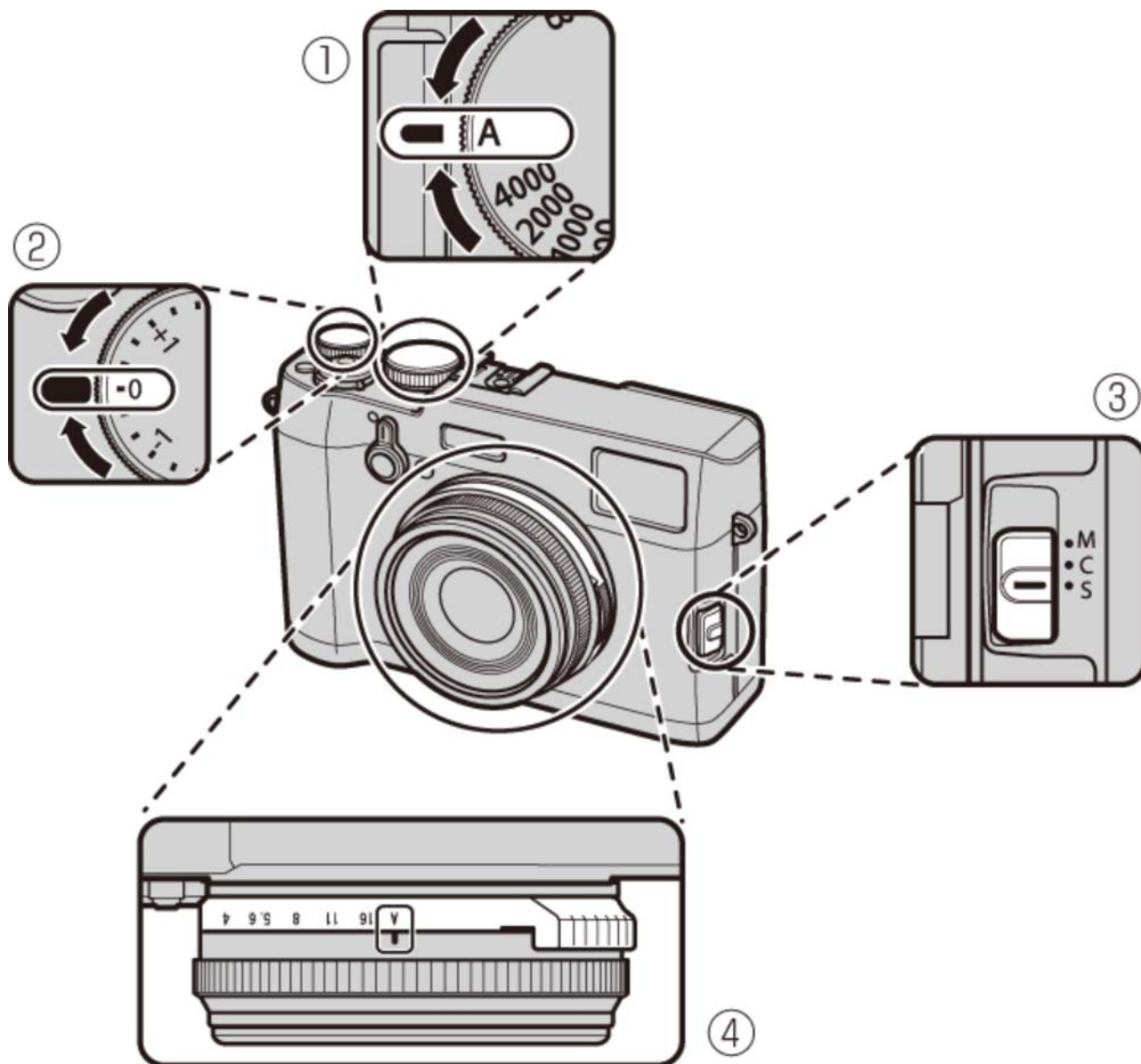

- ① **Shutter speed:** Select **[A]** (auto)
- ② **Exposure compensation:** Select **[±0]**
- ③ **Focus mode:** Select **[S]** (single AF)
- ④ **Aperture:** Select **[A]** (auto)

Confirm that **[P]** appears in the display.

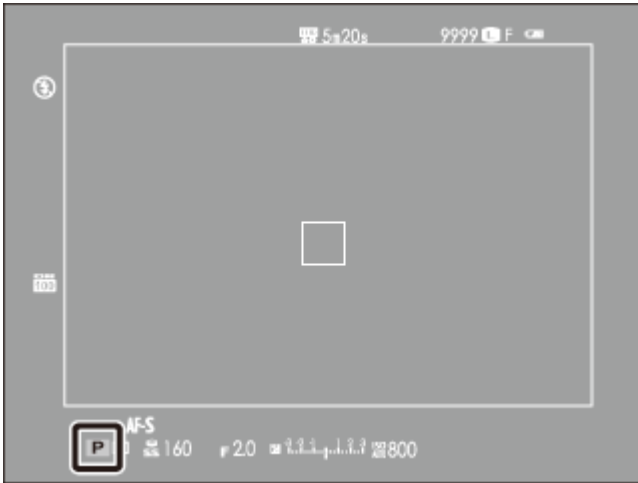

OVF

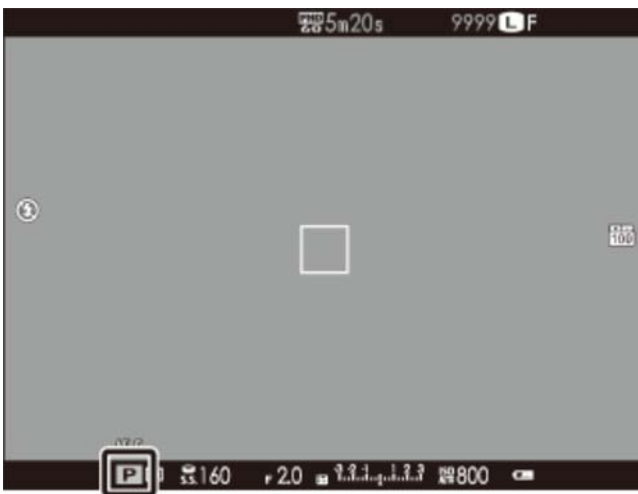

EVF/LCD

Viewfinder Display Selection

Use the viewfinder selector to switch between the optical viewfinder (OVF) and electronic viewfinder (EVF) displays.

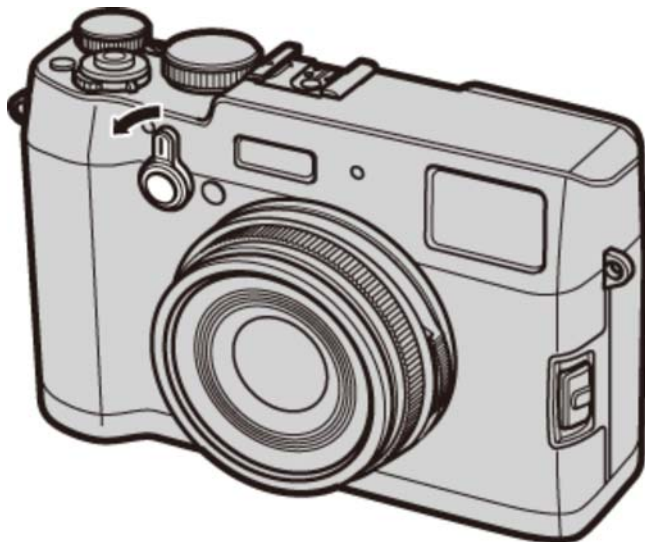

2. Ready the camera.

Hold the camera steady with both hands and brace your elbows against your sides. Shaking or unsteady hands can blur your shots.



To prevent pictures that are out of focus or too dark (underexposed), keep your fingers and other objects away from the lens and flash.

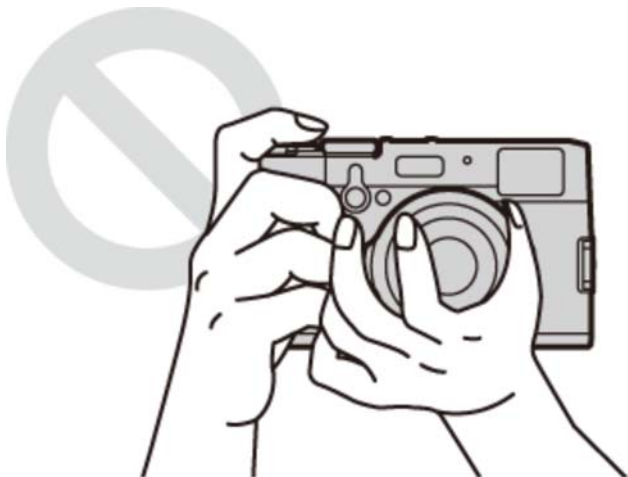

3. Focus.

Frame the picture with your subject in the center of the display and press the shutter button halfway to focus.



If the camera is able to focus, it will beep twice and focus area will glow green. Focus and exposure will lock while the shutter button is pressed halfway.

If the camera is unable to focus, the focus frame will turn red, **!AF** will be displayed. If the subject is close to the camera, select macro mode and try again.

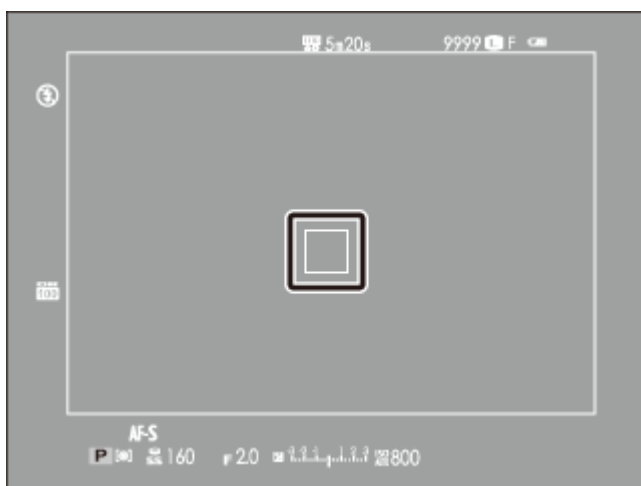

OVF

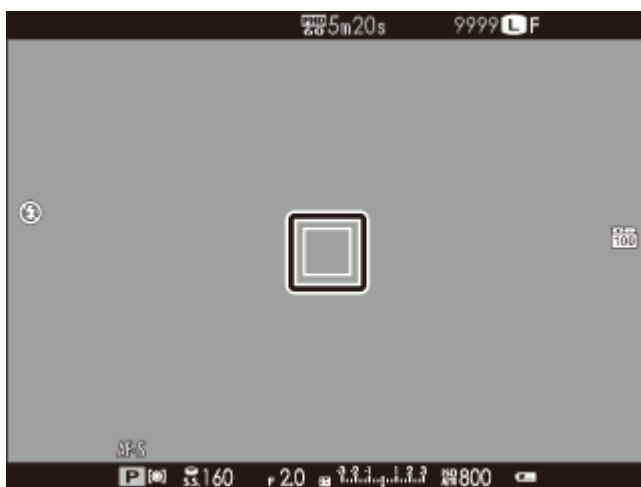

EVF/LCD

 If the subject is poorly lit, the AF-assist illuminator may light.

4. Shoot.

Smoothly press the shutter button the rest of the way down to take the picture.



 The flash may fire if lighting is poor. Camera settings can be changed to prevent the flash firing.

Viewing Pictures



- Viewing Pictures Full Frame
- Viewing Photo Information
- Zooming in on the Focus Point
- Playback Zoom
- Multi-Frame Playback

Viewing Pictures Full Frame

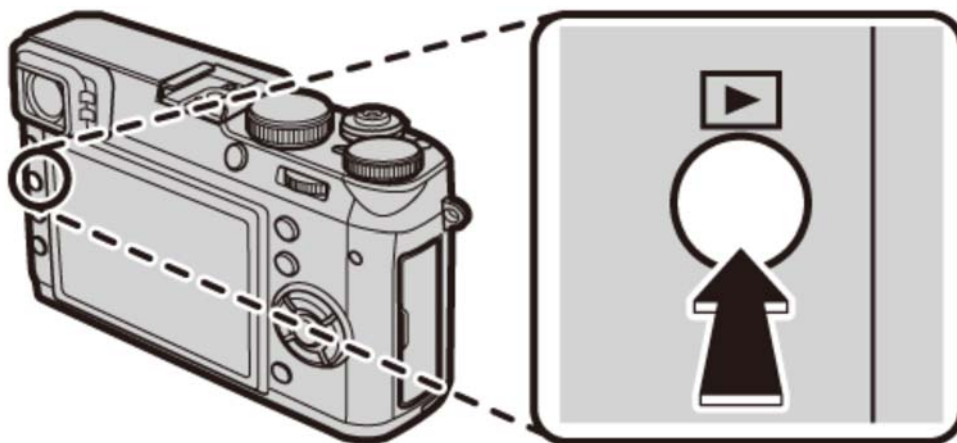
To view pictures full frame, press .



Additional pictures can be viewed by pressing the selector left or right or rotating the focus ring. Press the selector or rotate the ring right to view pictures in the order recorded, left to view pictures in reverse order. Keep the selector pressed to scroll rapidly to the desired frame.

 Pictures taken using other cameras are indicated by a  ("gift image") icon during playback. These pictures may not display correctly and may not be viewable using playback zoom.



Favorites: Rating Pictures

To rate the current picture, press **[DISP/BACK]** and press the selector up and down to select from zero to five stars.

Viewing Photo Information

The photo information display changes each time the selector is pressed up.

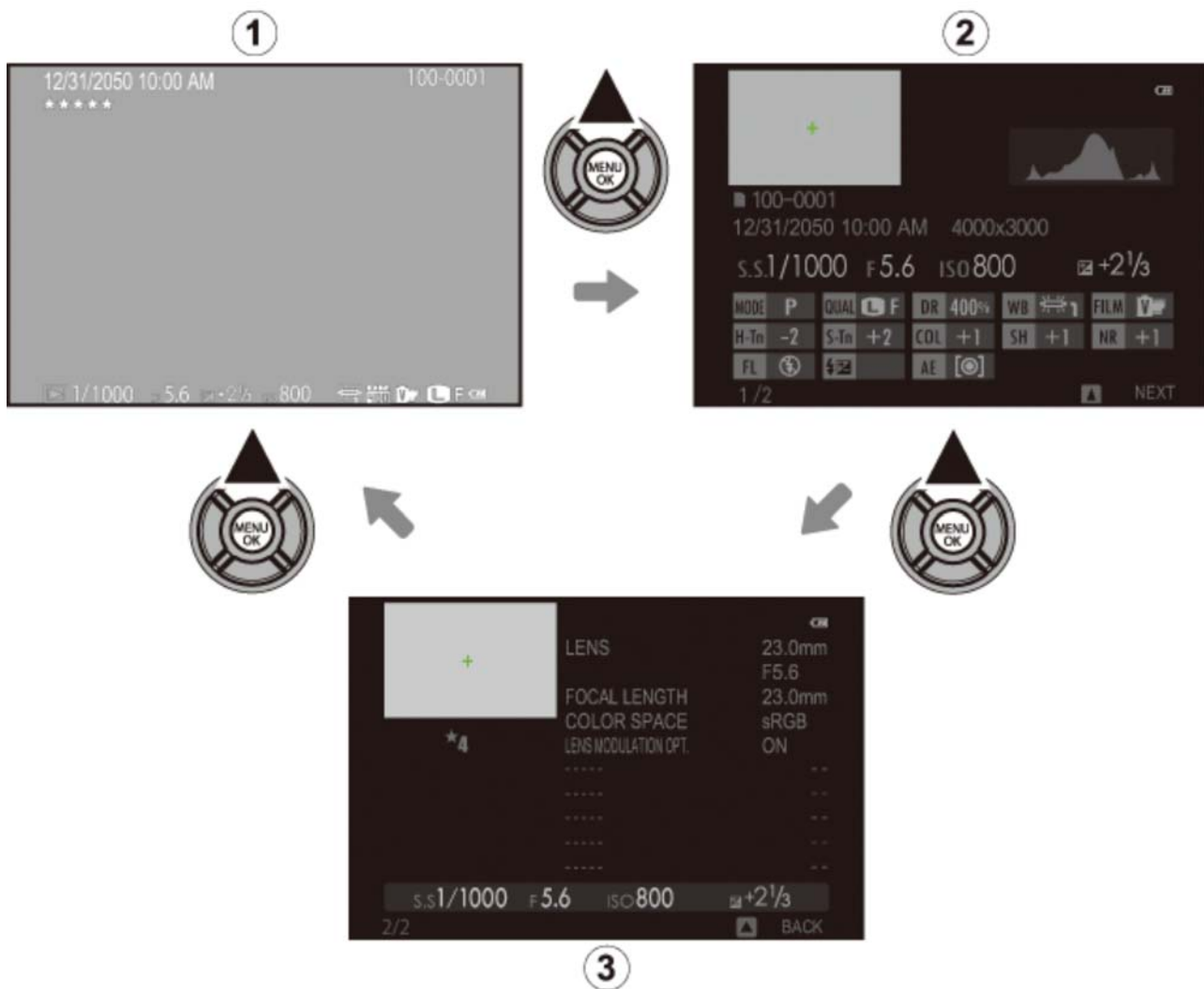
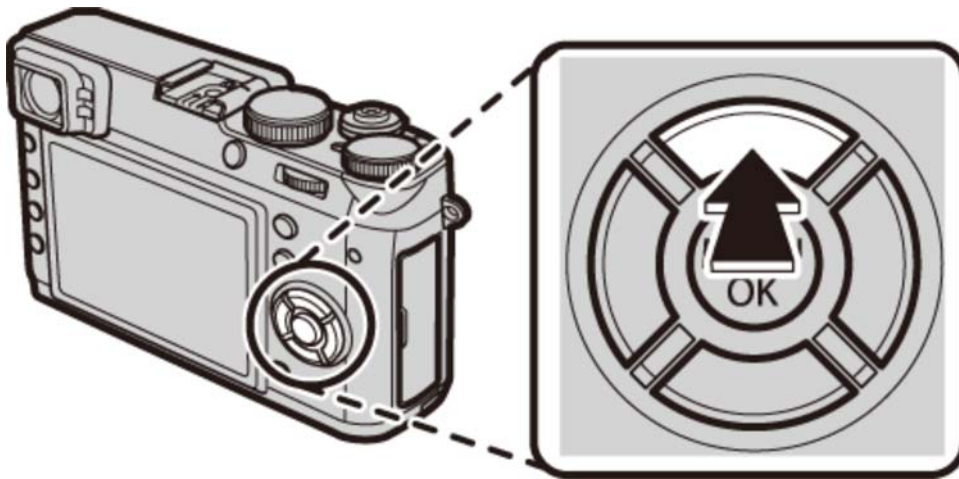

- 1** Basic data
- 2** Info display 1
- 3** Info display 2

 Press the selector left or right or rotate the focus ring to view other images.

Zooming in on the Focus Point

Press the center of the command dial to zoom in on the focus point. Press the center of the command dial again to return to full-frame playback.

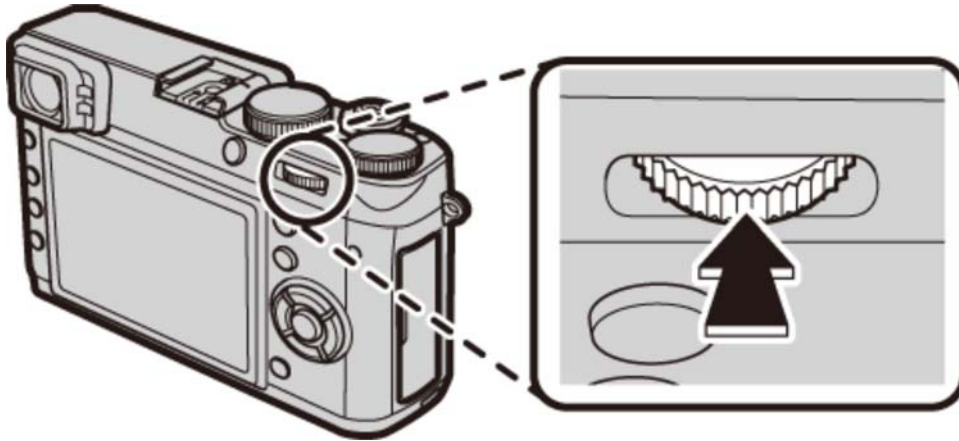

Playback Zoom

Rotate the command dial right to zoom in on the current picture, left to zoom out (to view multiple images, rotate the command dial left when the picture is displayed full frame). Press **[DISP/BACK]** or **[MENU/OK]** to exit zoom.

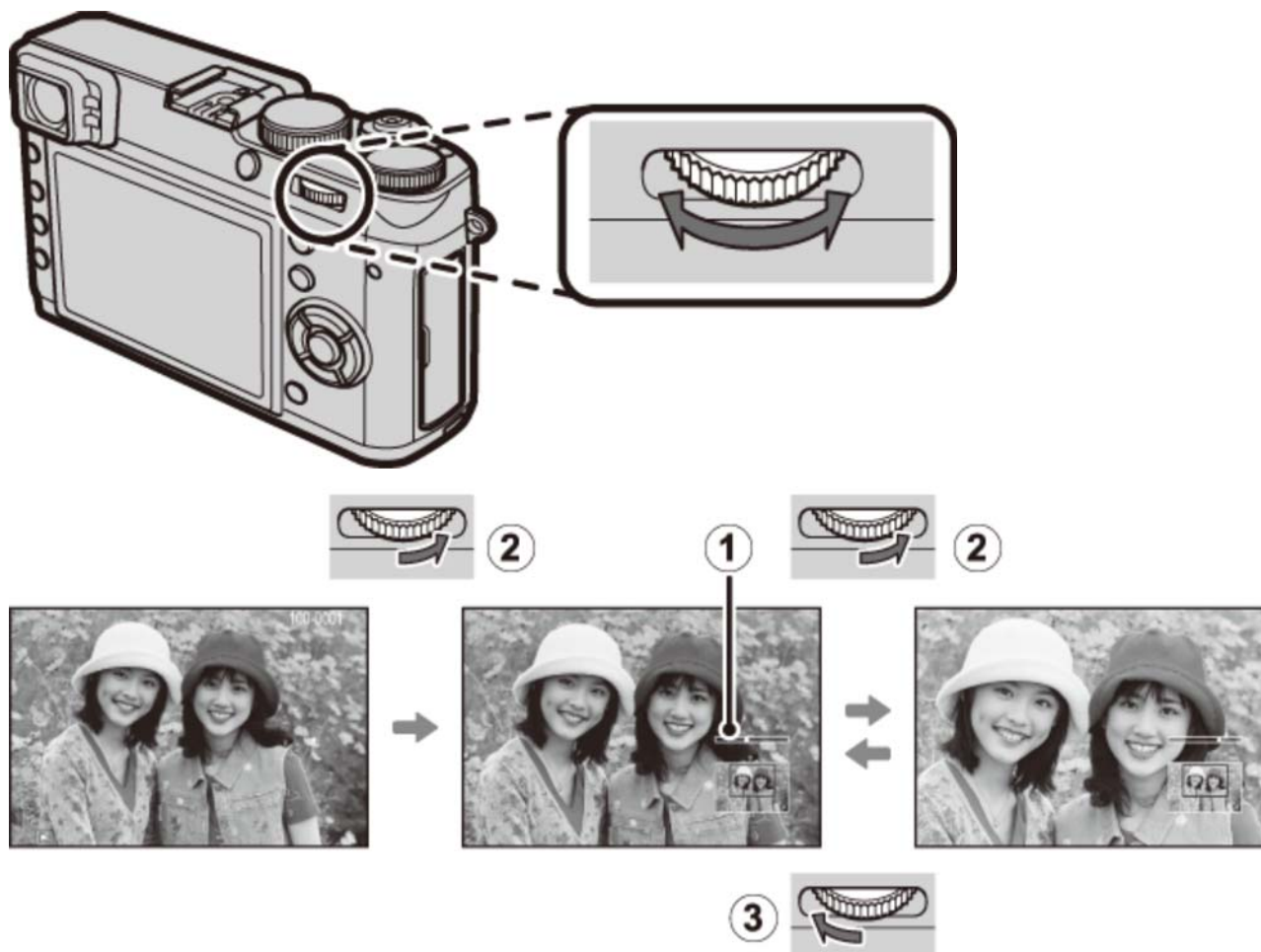

- ① Zoom indicator
- ② Rotate right
- ③ Rotate left

 The maximum zoom ratio varies with image size. Playback zoom is not available with cropped or resized copies saved at a size of **640**.

The Navigation Window

When the picture is zoomed in, the selector can be used to view areas of the image not currently visible in the display.



Navigation window shows portion of image currently displayed.

Multi-Frame Playback

To change the number of images displayed, rotate the command dial left when a picture is displayed full frame.

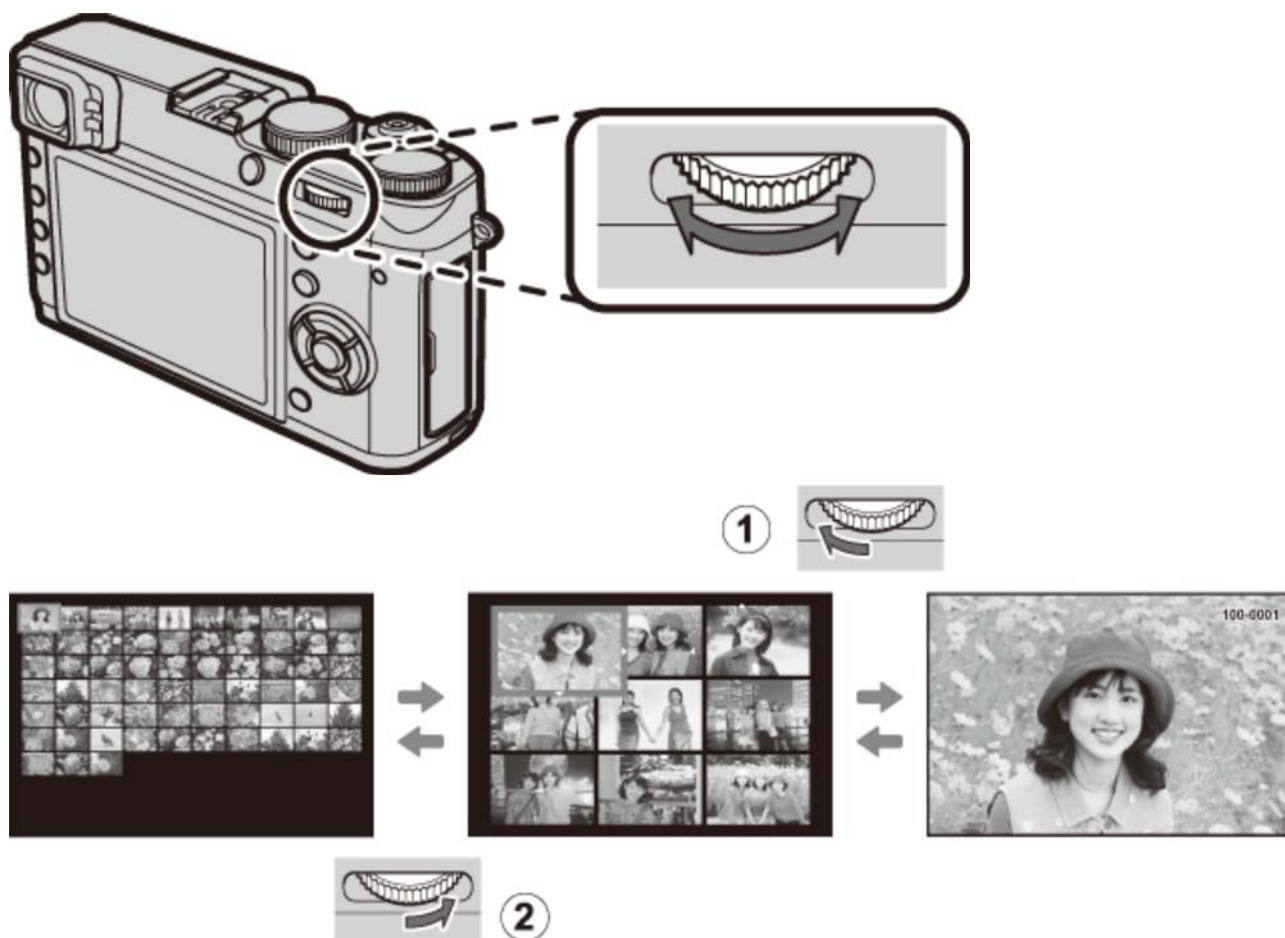

- ① Rotate left to view more images.
- ② Rotate right to view fewer images.



Use the selector to highlight images and press **[MENU/OK]** to view the highlighted image full frame (to zoom in on the selected image, rotate the command dial right when the picture is displayed full frame). In the nine- and hundred-frame displays, press the selector up or down to view more pictures.

Deleting Pictures

To delete individual pictures, multiple selected pictures, or all pictures, press the  button when a picture is displayed full frame and choose from the options on the following pages.

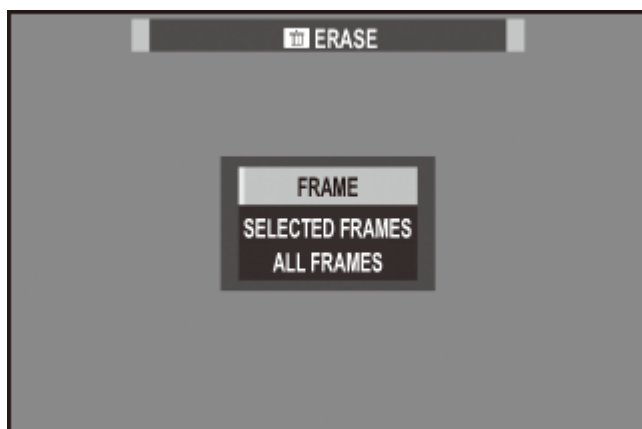
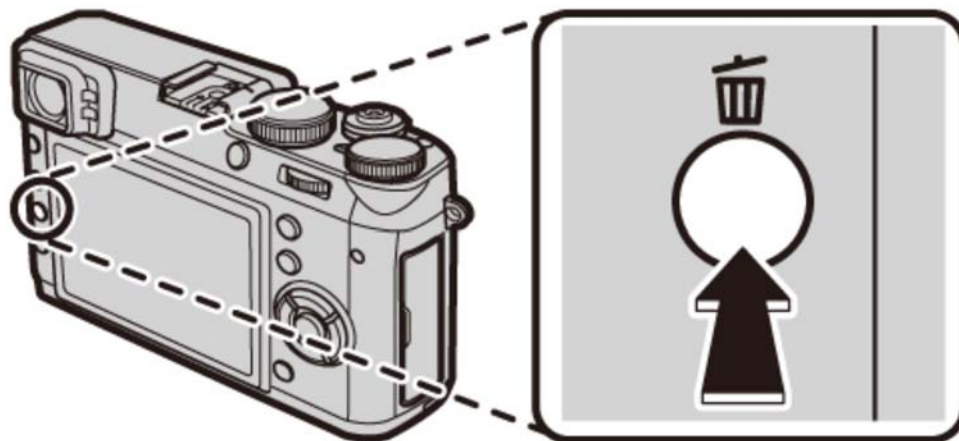
Note that deleted pictures can not be recovered. Copy important pictures to a computer or other storage device before proceeding.



-  If a message appears stating that the selected images are part of a DPOF print order, press **[MENU/OK]** to delete the pictures.
-  If a memory card is inserted, pictures will be deleted from the memory card. Otherwise pictures will be deleted from internal memory.

-  [\[FRAME\]](#)
-  [\[SELECTED FRAMES\]](#)
-  [\[ALL FRAMES\]](#)

[FRAME]



Delete pictures one at a time.

1. Press the  button in full-frame playback and select **[FRAME]**.
2. Press the selector left or right to scroll through pictures and press **[MENU/OK]** to delete (a confirmation dialog is not displayed). Repeat to delete additional pictures.

[SELECTED FRAMES]

Delete multiple selected pictures.





1. Press the  button in full-frame playback and choose **[SELECTED FRAMES]**.
2. Highlight pictures and press **[MENU/OK]** to select or deselect (pictures in photobooks or print orders are shown by ).
3. When the operation is complete, press **[DISP/BACK]** to display a confirmation dialog.
4. Highlight **[OK]** and press **[MENU/OK]** to delete the selected pictures.

[ALL FRAMES]

Delete all unprotected pictures.

1. Press the  button in full-frame playback and choose **[ALL FRAMES]**.
2. A confirmation dialog will be displayed; highlight **[OK]** and press **[MENU/OK]** to delete all unprotected pictures. Pressing **[DISP/BACK]** cancels deletion; note that any pictures deleted before the button was pressed can not be recovered.

-  If a memory card is inserted, only the pictures on the memory card will be affected; the pictures in internal memory are only deleted if no memory card is inserted.
-  If a message appears stating that the selected images are part of a DPOF print order, press **[MENU/OK]** to delete the pictures.

Basic Movie Recording and Playback

➔ [Recording Movies](#)

➔ [Viewing Movies](#)

Recording Movies

Follow the steps below to record movies with sound.

1. Press the **[Fn]** button (function button 1) to start recording.

 At default settings, movie recording is assigned to the Fn1 button. For information on choosing the roles played by the function buttons, see "The Function Buttons".

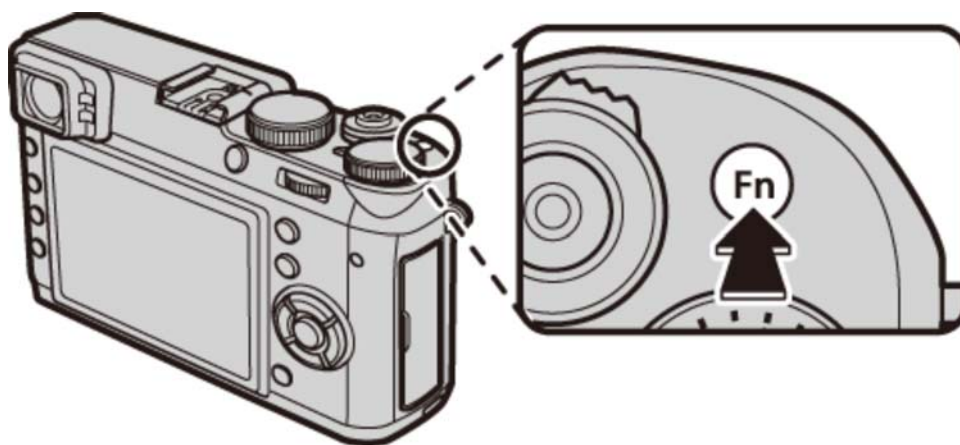

- 1 Recording indicator
- 2 Time remaining

2. Press the button again to end recording. Recording ends automatically when the maximum length is reached or the memory card is full.

❗ The indicator lamp lights while movies are being recorded.

- ✎ Sensitivity and frame size and rate can be selected using the **[MOVIE SET-UP]** option in the shooting menu.
- ✎ Movies shot in **[S]**, **[A]**, and **[M]** modes are recorded at the settings currently selected for photographs; shutter speed and/or aperture can be adjusted during shooting. In other modes, settings are adjusted automatically.
- ✎ The optical viewfinder display automatically switches to the electronic viewfinder/LCD monitor during movie recording. The electronic range finder (ERF) at the bottom right corner of the screen mirrors the electronic viewfinder.

See Also

- ➔ [The Function Buttons](#) ([Fn] (Function) Buttons)
- ➔ [\[MOVIE SET-UP\]](#) (The Shooting Menu)

Using an External Microphone

The camera can be used with external microphones.

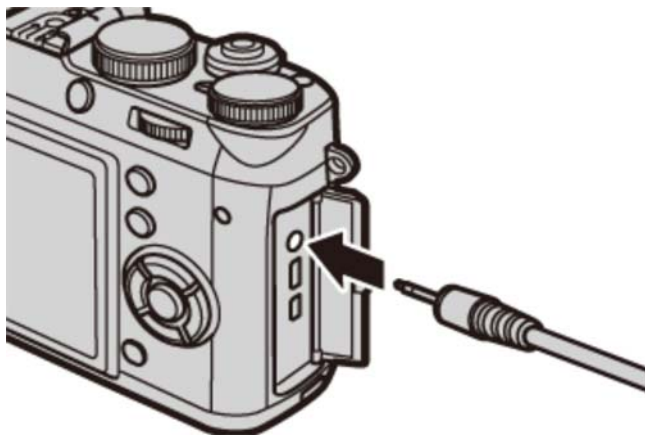

- ⚠ A 2.5 mm adapter is required when connecting microphones with a 3.5 mm diameter plug.

- ✎ A confirmation dialog will be displayed when a microphone is connected to the microphone/remote release connector. Press **[MENU/OK]** and select **[MIC/REMOTE RELEASE] > [MIC]**.

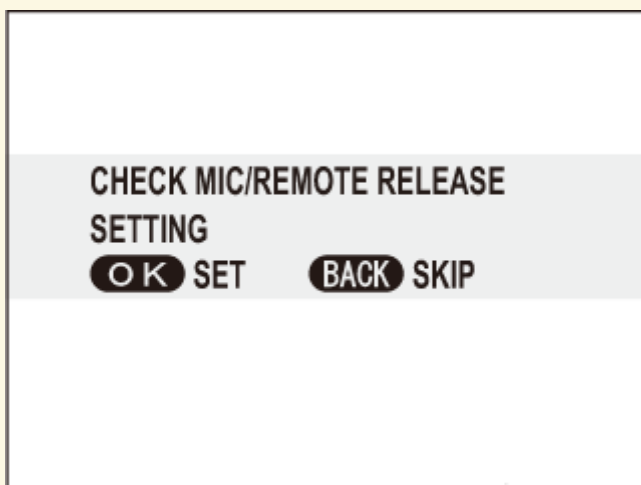

Viewing Movies

Movies are indicated by a  icon during full-frame playback.



Press  to begin playback. Progress is shown in the display.

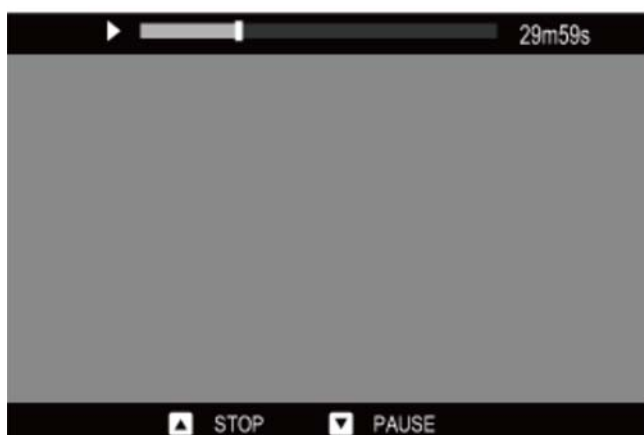

Use the selector to control playback.

Playback in progress (▶)

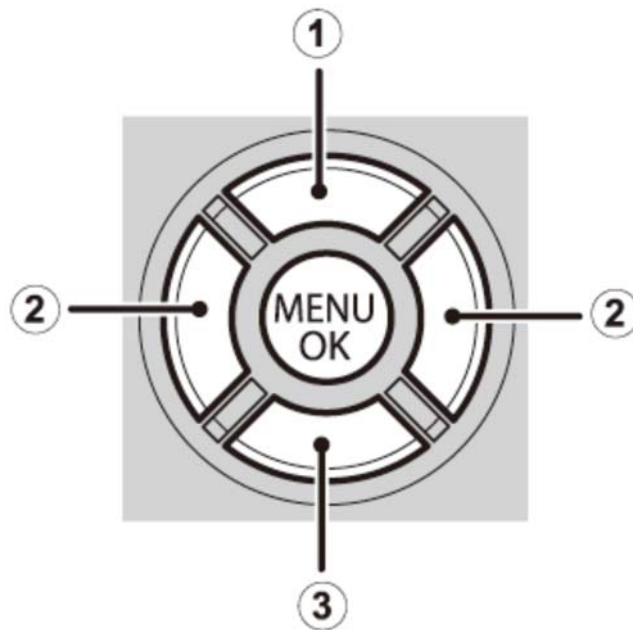

- ① End playback
- ② Adjust speed
- ③ Pause playback

Playback paused (⏸)

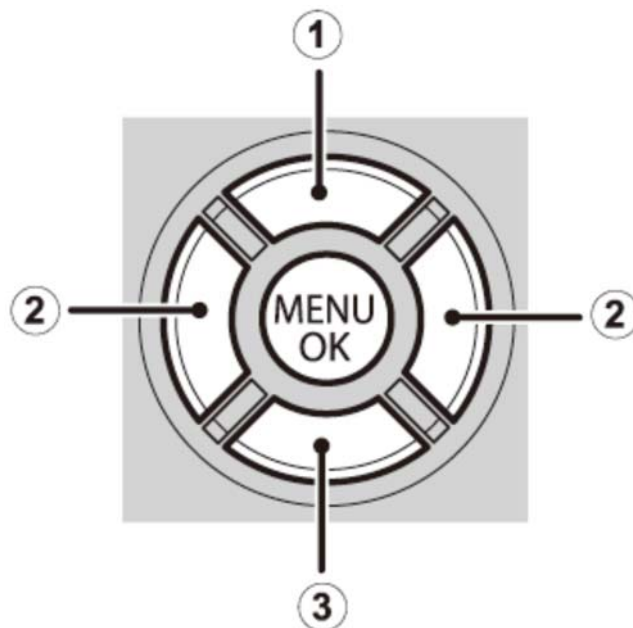

- ① End playback
- ② Single-frame advance/rewind
- ③ Playback

✎ Press the selector up or down to adjust the volume; press **[MENU/OK]** again to resume playback. Volume can also be adjusted from the setup menu.

- ❗ Do not cover the speaker during playback.
- ❗ Sound is not played back in silent mode.

Playback Speed

Press the selector left or right to adjust playback speed during playback. Speed is shown by the number of arrows (▶ or ◀).



Shooting Mode

- ➔ Program AE
- ➔ Shutter-Priority AE
- ➔ Aperture-Priority AE
- ➔ Manual Exposure

P Program AE

In this mode, the camera sets exposure automatically. If desired, you can choose different combinations of shutter speed and aperture that will produce the same exposure (program shift).

To select program AE, set shutter speed and aperture to **[A]**.

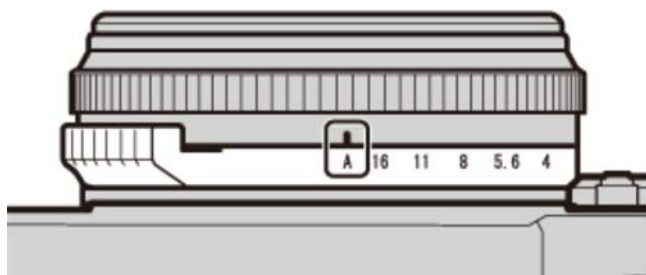

Aperture: **[A]**

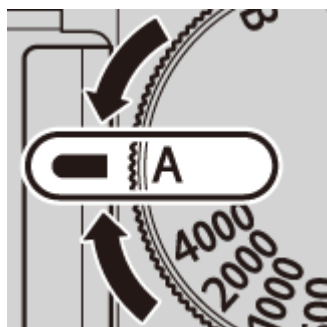

Shutter speed: **[A]**



- ❗ If the subject is outside the metering range of the camera, the shutter speed and aperture displays will show "---".

Program Shift

If desired, you can rotate the command dial to select other combinations of shutter speed and aperture without altering exposure (program shift).

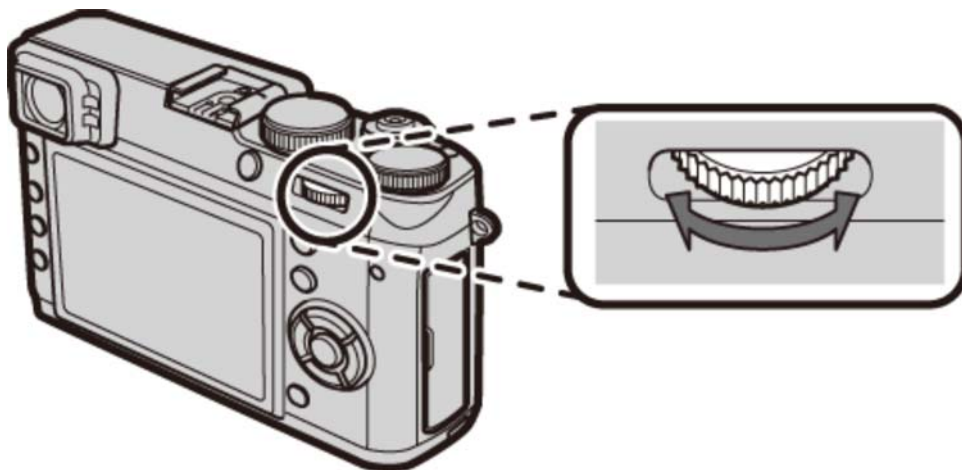

① Shutter speed

② Aperture

- ✎ The new values for shutter speed and aperture are shown in yellow.
- ✎ To cancel program shift, turn the camera off.
- ✎ Program shift will also be cancelled if a flash mode other than off is selected.

❗ Program shift is not available when a flash mode other than off is selected or **[AUTO]** is selected for **[DYNAMIC RANGE]**.

S Shutter-Priority AE

In shutter-priority AE (mode S), you select the shutter speed and let the camera choose the aperture. Set aperture to **[A]** and rotate the shutter speed dial to the desired setting.

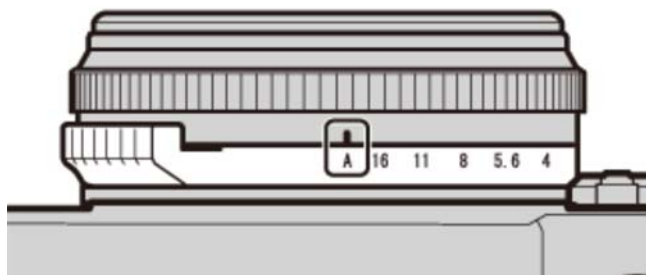

Aperture: **[A]**

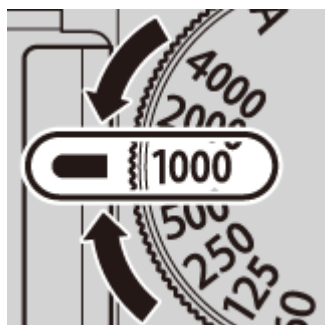

Shutter speed: 1/1000 s



Shutter speed

✎ Shutter speed can also be adjusted in increments of 1/3 EV by rotating the command dial.

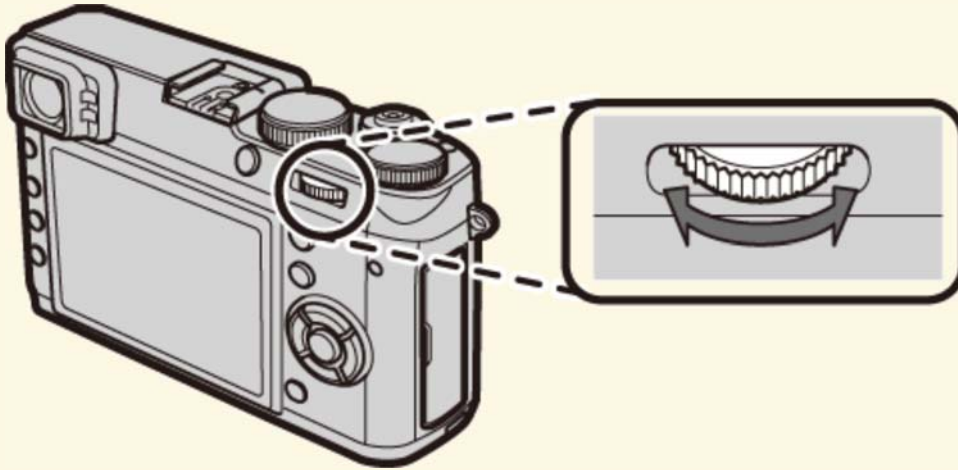

- ❗ If the correct exposure can not be achieved at the selected shutter speed, aperture will be displayed in red when the shutter button is pressed halfway.
- ❗ If the subject is outside the metering range of the camera, the aperture display will show "----".

A Aperture-Priority AE

In aperture-priority AE (mode A), you select the aperture and let the camera choose the shutter speed. Rotate the shutter speed dial to **[A]** and select the desired aperture.

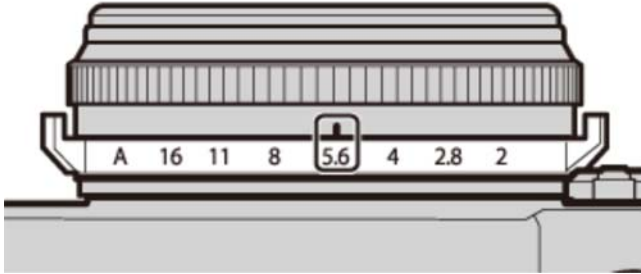

Aperture: f/5.6

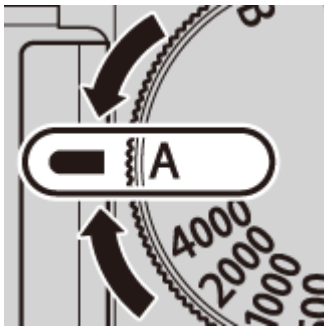

Shutter speed: [A]

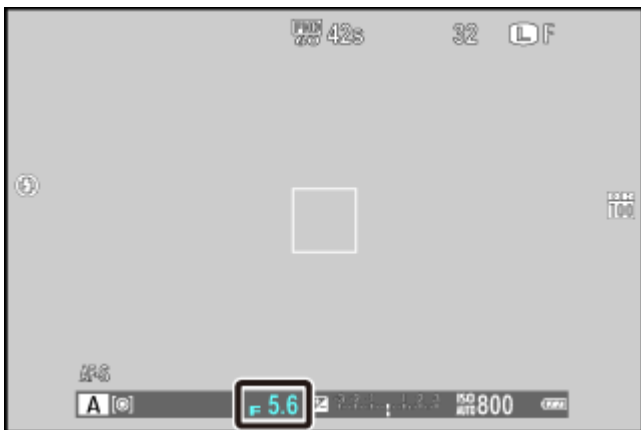

Aperture

- ❗ If the correct exposure can not be achieved at the selected aperture, the shutter speed will be displayed in red when the shutter button is pressed halfway. Adjust aperture until the correct exposure is achieved.
- ❗ If the subject is outside the metering range of the camera, the shutter speed display will show “---”.
- ❗ The slowest shutter speed available when **[ON]** is selected for **[POWER MANAGEMENT] > [OVF POWER SAVE MODE]** in the setup menu is 1/4 s.

Previewing Depth of Field

When **[PREVIEW DEPTH OF FIELD]** is assigned to a function button using the **[FUNCTION (Fn) SETTING]** option in the shooting menu, pressing the button stops aperture down to the selected setting, allowing depth of field to be previewed in the viewfinder or LCD monitor.

See Also

- ➔ [The Function Buttons \(\[Fn\] \(Function\) Buttons\)](#)

M Manual Exposure

In this mode, you choose both shutter speed and aperture. The resulting exposure is shown by an indicator in the display; if desired, exposure can be altered from the value suggested by the camera.

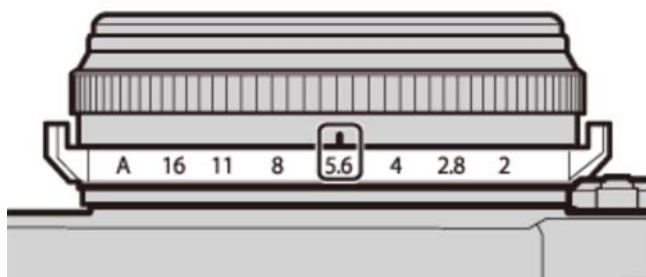

Aperture: f/5.6

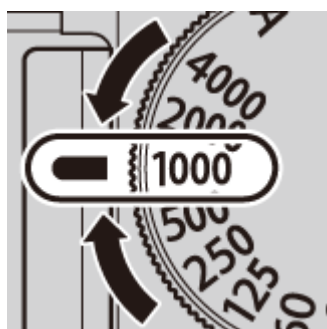

Shutter speed: 1/1000 s



- ① Shutter speed
- ② Aperture
- ③ Exposure indicator

✎ Shutter speed can also be adjusted in increments of 1/3 EV by rotating the command dial.

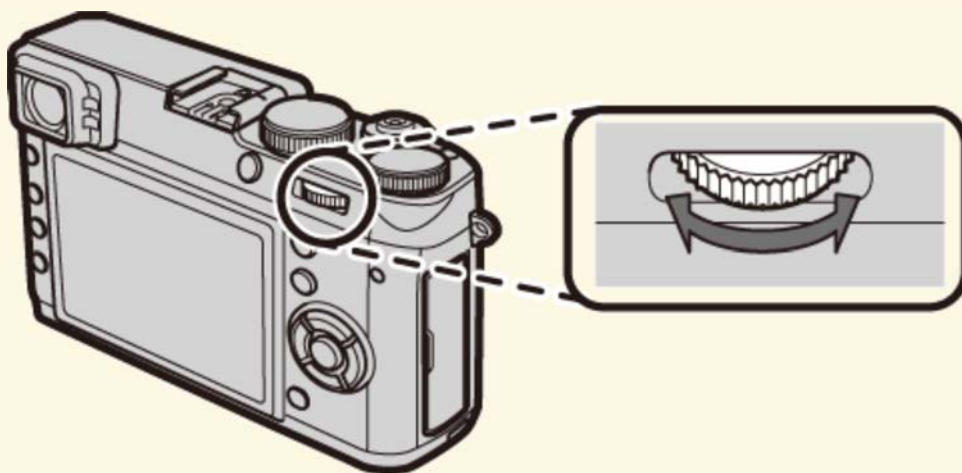

Exposure Preview

To preview exposure in the LCD monitor, select **[ON]** for **[SCREEN SET-UP] > [PREVIEW EXP. IN MANUAL MODE]**.

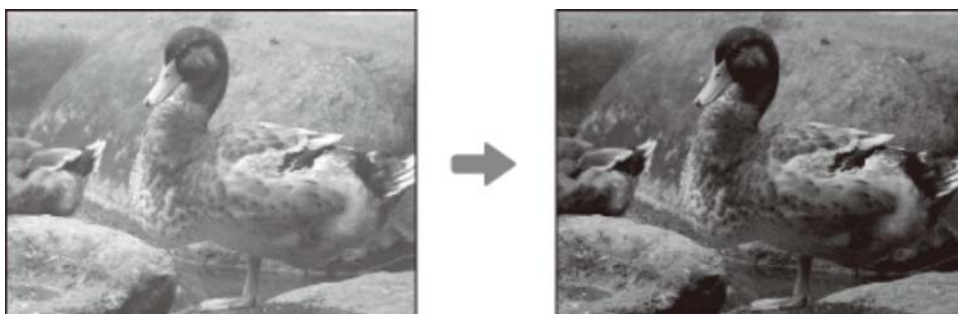

✎ Select **[OFF]** when using the flash or on other occasions on which exposure may change when the picture is taken.

[Q] (Quick Menu) Button

➔ [Using the \[Q\] Button](#)

Using the [Q] Button

Use the [Q] button to view and adjust camera settings.

1. Press [Q] to display the quick menu during shooting.

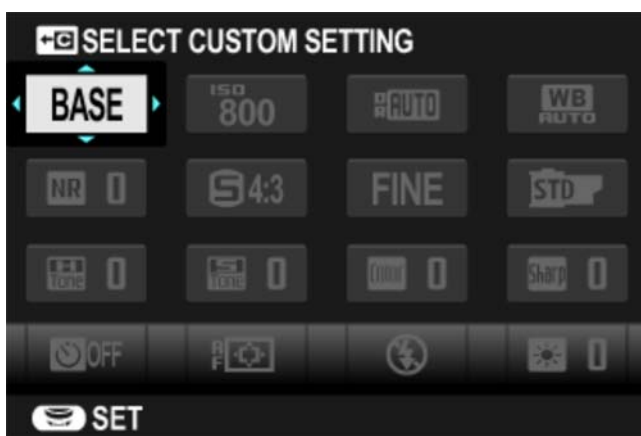
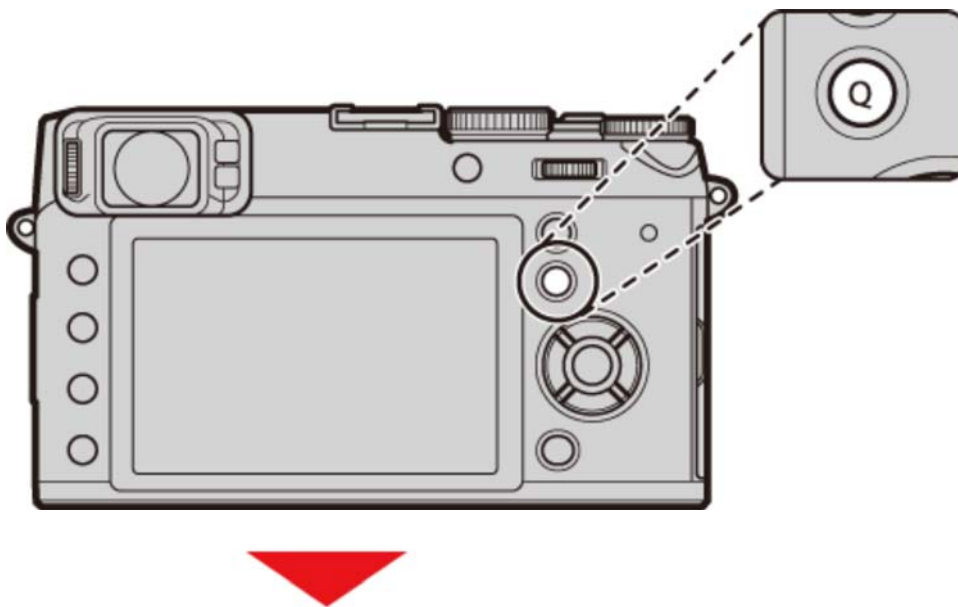

- ✎ The options displayed in the quick menu can be selected using the [EDIT/SAVE QUICK MENU] option in the setup menu. Quick menu edit options can also be displayed by pressing and holding the [Q] button.

2. Use the selector to highlight items.

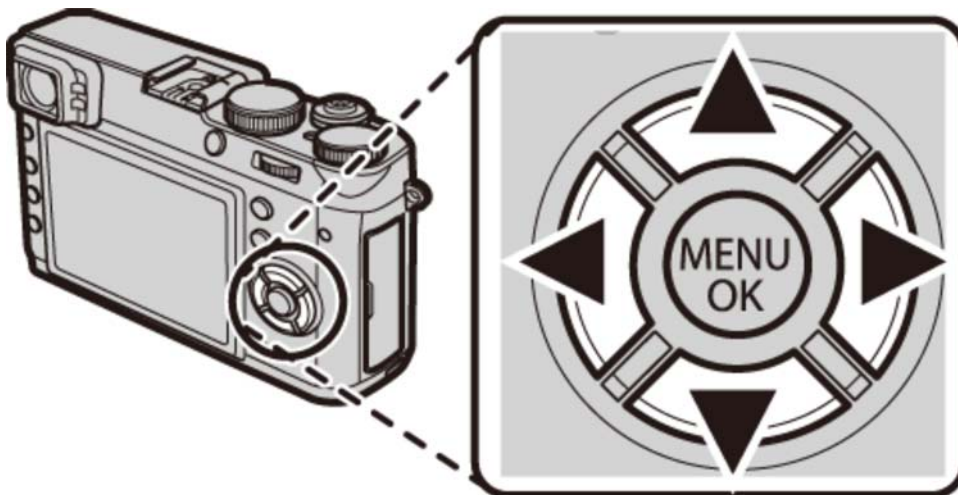

 The [Q] button can not be used to adjust custom white balance, choose a color temperature, or adjust settings for auto ISO sensitivity. These settings can be adjusted using a function button or from the menus.

3. Rotate the command dial to change the highlighted item.

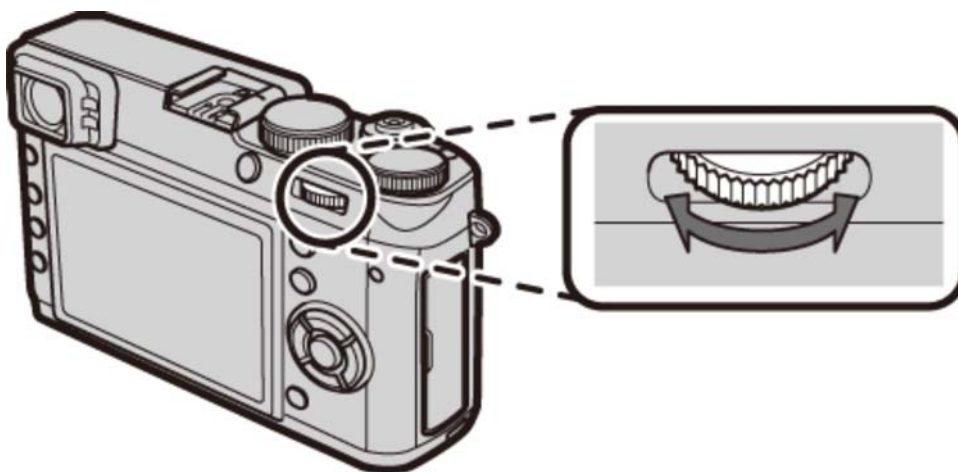

4. Press [Q] to exit when settings are complete.

 For quick access to custom settings banks, press and hold the [Q] button while the quick menu is displayed.

See Also

- ➔ [\[EDIT/SAVE QUICK MENU\]](#) (The Setup Menu)

[Fn] (Function) Buttons



➔ [The Function Buttons](#)

The Function Buttons

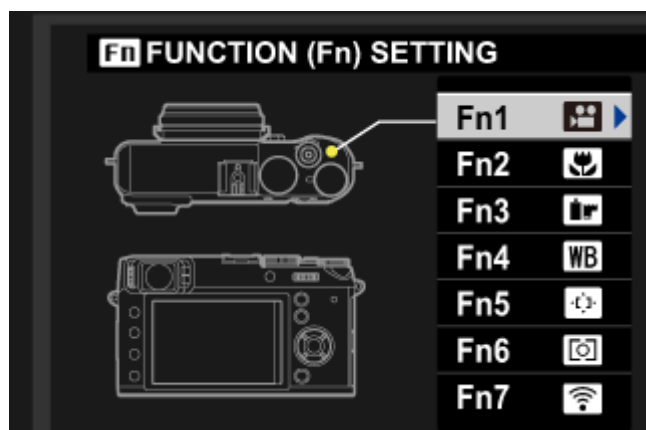
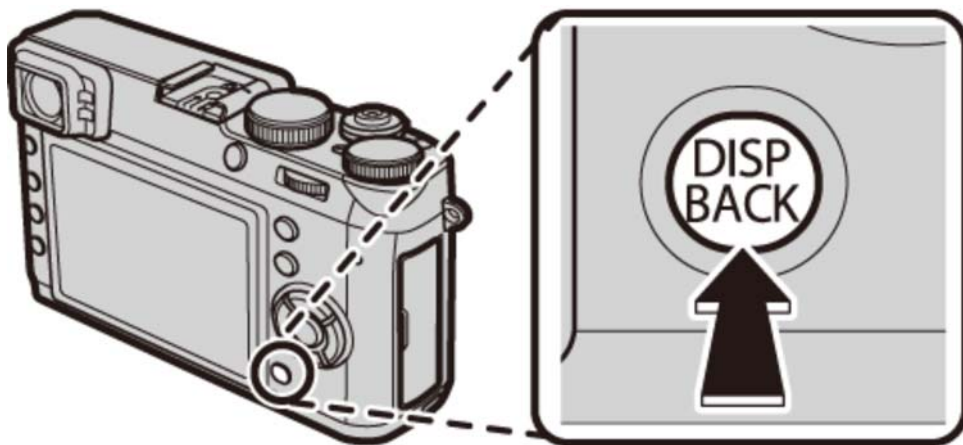
Each of the function buttons can be assigned any one of the roles listed below. Options for the selected item can then be displayed by pressing the button. To choose the roles played by the function buttons, press the **[DISP/BACK]** button until function settings options are displayed, then highlight the desired button and press the selector right.



- [ADVANCED FILTER]
- [MULTIPLE EXPOSURE]
- [MACRO]
- [PREVIEW DEPTH OF FIELD]
- [ISO]
- [SELF-TIMER]
- [IMAGE SIZE]
- [IMAGE QUALITY]
- [DYNAMIC RANGE]
- [FILM SIMULATION]
- [WHITE BALANCE]
- [ND FILTER]
- [PHOTOMETRY]
- [AF MODE]
- [FOCUS AREA]
- [CORRECTED AF FRAME]
- [FLASH MODE]
- [FLASH COMPENSATION]
- [SELECT CUSTOM SETTING]
- [MOVIE]
- [FACE DETECTION]
- [PREVIEW PIC. EFFECT]
- [HIGH PERFORMANCE]
- [RAW]
- [WIRELESS COMMUNICATION]
- [CONVERSION LENS]
- [SHUTTER TYPE]

-  You can also use the **[FUNCTION (Fn) SETTING]** option in the shooting menu to choose the roles played by the function buttons.
-  You can also display options for any of the function buttons by pressing and holding the button.

See Also

-  [\[FUNCTION \(Fn\) SETTING\] \(The Shooting Menu\)](#)

More on Photography

- ➔ [Bracketing](#)
- ➔ [Continuous Shooting \(Burst Mode\)](#)
- ➔ [Multiple Exposures](#)
- ➔ [Panoramas](#)
- ➔ [Macro Mode \(Close-ups\)](#)
- ➔ [Using the Self-Timer](#)
- ➔ [Interval Timer Photography](#)
- ➔ [Using the Flash](#)
- ➔ [Focus-Frame Selection](#)
- ➔ [Exposure Compensation](#)
- ➔ [Focus/Exposure Lock](#)
- ➔ [Focus Mode](#)
- ➔ [Manual Focus \(Focus Mode M\)](#)
- ➔ [Metering](#)
- ➔ [Recording Pictures in RAW Format](#)
- ➔ [Long Time-Exposures \(T/B\)](#)
- ➔ [Film Simulation](#)
- ➔ [White Balance](#)
- ➔ [Advanced Filters](#)

Bracketing

Automatically vary settings over a series of pictures. Bracketing options can be displayed by pressing the **[DRIVE]** button.

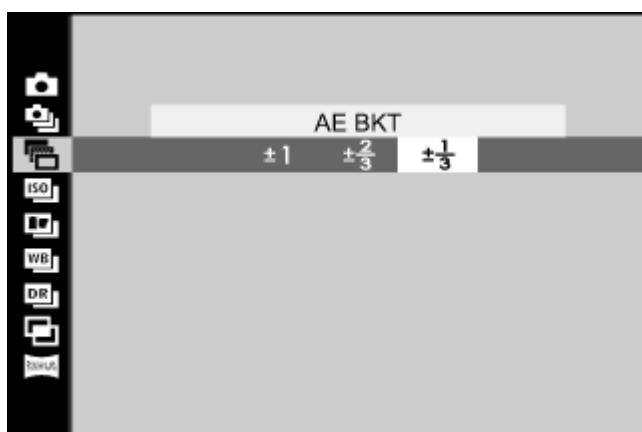
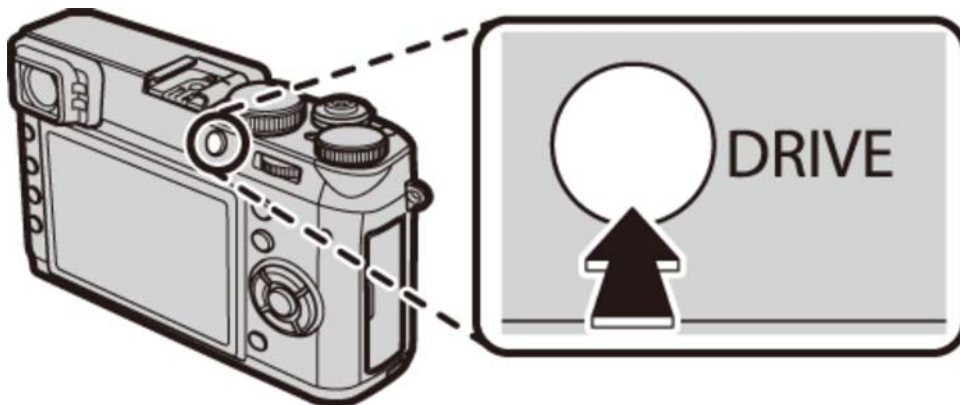

- ⬇ [AE BKT]
- ⬇ [ISO] [ISO BKT]
- ⬇ [FILM SIMULATION BKT]
- ⬇ [WB] [WHITE BALANCE BKT]
- ⬇ [DR] [DYNAMIC RANGE BKT]

[AE BKT]

Press the selector left or right to highlight a bracketing amount. Each time the shutter button is pressed, the camera will take three shots: one using the metered value for exposure, the second overexposed by the selected amount, and the third underexposed by the same amount.

 The camera may not be able to use the selected bracketing increment if the amount of over- or under- exposure exceeds the limits of the exposure metering system.

[ISO BKT]

Press the selector left or right to highlight a bracketing amount. Each time the shutter-release button is pressed, the camera will take a picture at the current sensitivity and process it to create two additional copies, one with the sensitivity raised and the other with the sensitivity lowered by the selected amount.

 This option can not be used if **[RAW]** is selected for **[IMAGE QUALITY]**.

[FILM SIMULATION BKT]

Each time the shutter is released, the camera takes one shot and processes it to create copies with the film simulation settings selected for **[FILM SIMULATION BKT]** in the shooting menu.

 This option can not be used if **[RAW]** is selected for **[IMAGE QUALITY]**.

See Also

 [\[FILM SIMULATION BKT\]](#) (The Shooting Menu)

[WHITE BALANCE BKT]

Press the selector left or right to highlight a bracketing amount. Each time the shutter button is pressed, the camera takes three shots: one at the current white balanced setting, one with fine-tuning increased by the selected amount, and another with fine-tuning decreased by the selected amount.

 This option can not be used if **[RAW]** is selected for **[IMAGE QUALITY]**.

[DYNAMIC RANGE BKT]

Each time the shutter button is pressed, the camera takes three shots at different dynamic range settings: 100% for the first, 200% for the second, and 400% for the third.

 Sensitivity is restricted to a minimum of ISO 800; the sensitivity previously in effect is restored when bracketing ends.

 This option can not be used if **[RAW]** is selected for **[IMAGE QUALITY]**.

Continuous Shooting (Burst Mode)

Capture motion in a series of pictures. Burst shooting options can be displayed by pressing the **[DRIVE]** button.

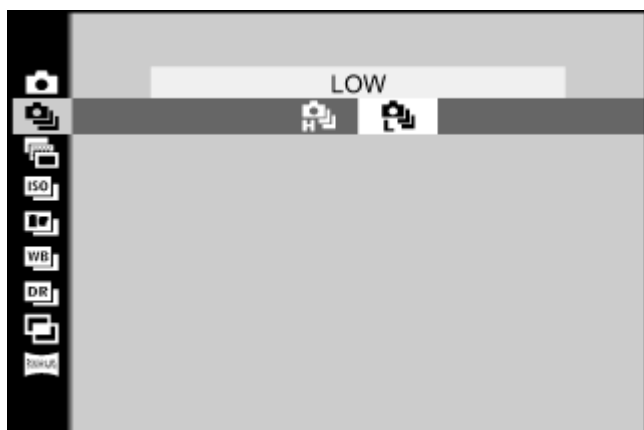
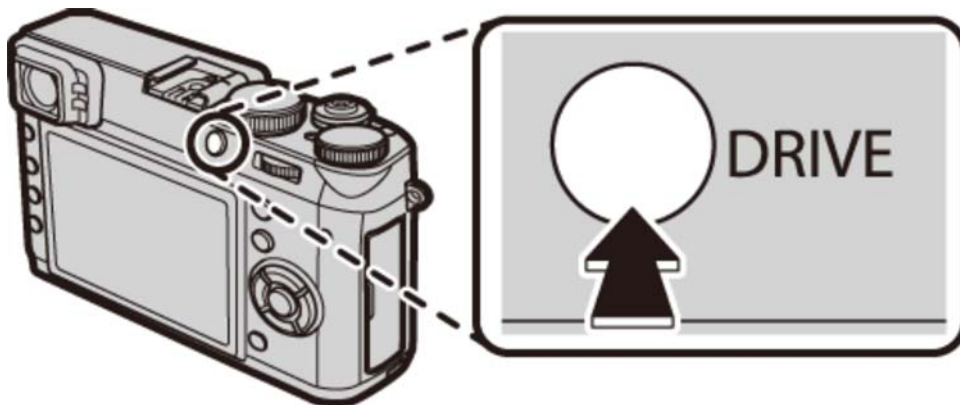

Press the selector left or right to choose a frame rate. The camera takes photographs while the shutter button is pressed.

Focus and Exposure

To vary focus and exposure with each shot, select focus mode **[C]**; in other modes, focus and exposure are determined by the first shot in each series.

 Focus tracking performance varies with aperture, sensitivity, and shooting conditions.

Multiple Exposures

Create a photograph that combines two exposures.



1. Press the **[DRIVE]** button to display drive options.

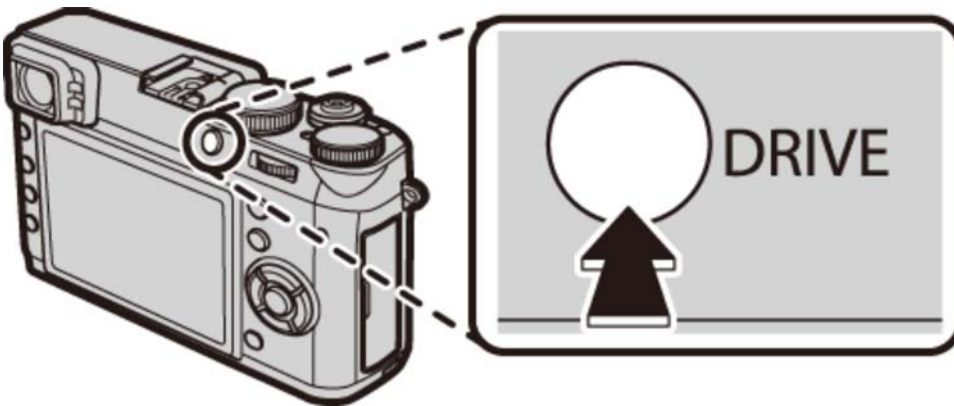

2. Highlight **[MULTIPLE EXPOSURE]** and press **[MENU/OK]** to select the highlighted option and return to shooting mode.

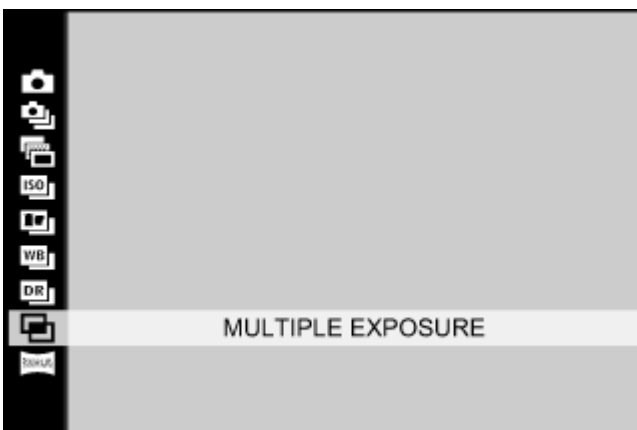

3. Take the first shot.
4. Press **[MENU/OK]**. The first shot will be shown superimposed on the view through the lens as a guide to taking the second shot.

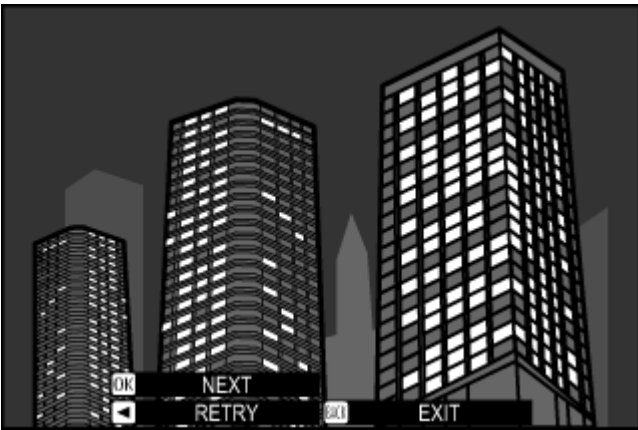

 To return to Step 3 and retake the first shot, press the selector left. To save the first shot and exit without creating a multiple exposure, press **[DISP/BACK]**.

5. Take the second shot.



6. Press **[MENU/OK]** to create the multiple exposure, or press the selector left to return to Step 5 and retake the second shot.



Panoramas

Follow an on-screen guide to take photos that will automatically be joined to form a panorama.

1. Press the **[DRIVE]** button to display drive options.

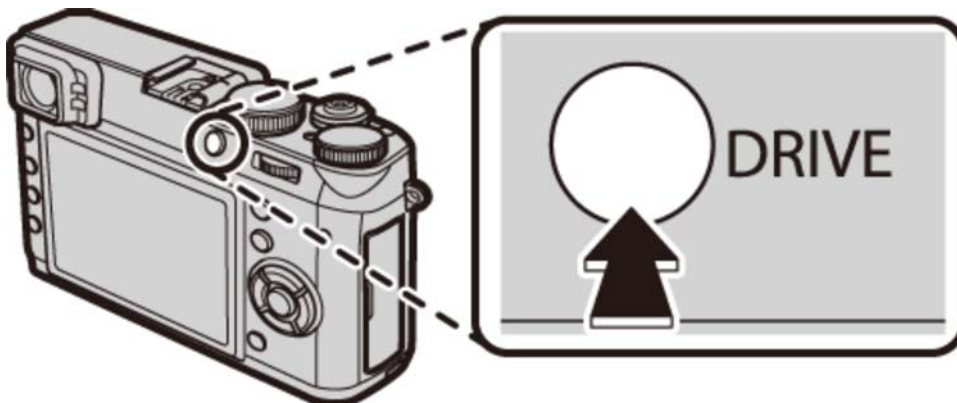

2. Highlight **[MOTION PANORAMA]** and press **[MENU/OK]** to select the highlighted option and return to shooting mode.

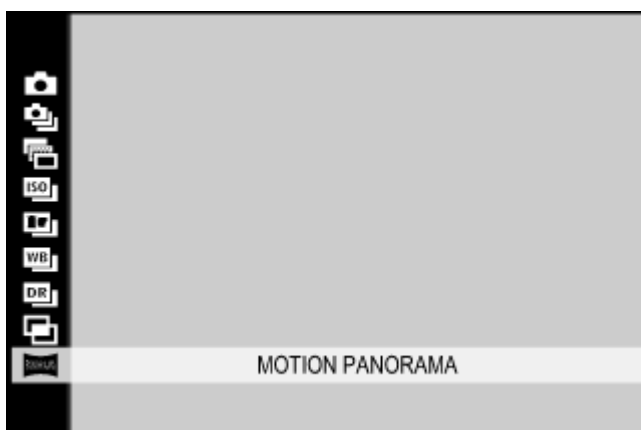

3. To select the angle through which you will pan the camera while shooting, press the selector left. Press the selector up or down to highlight an angle and press **[MENU/OK]**.

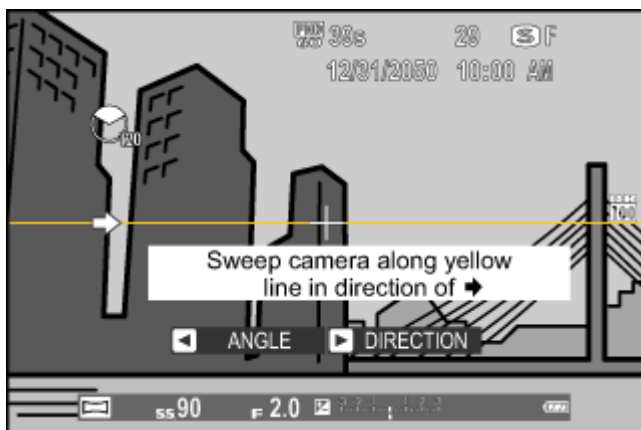

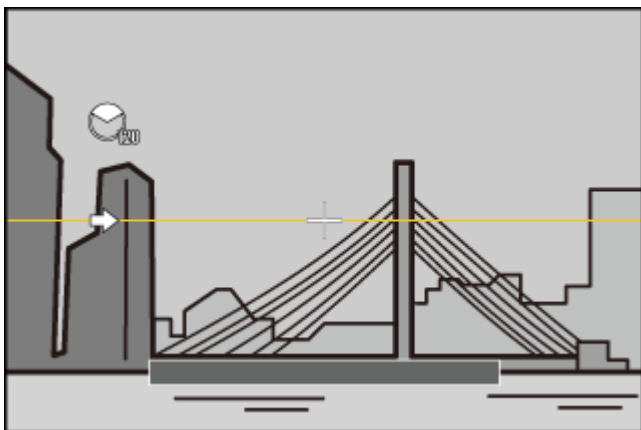

4. Press the selector right to view a choice of pan directions. Press the selector up or down to highlight a pan direction and press **[MENU/OK]**.
5. Press the shutter button all the way down to start recording. There is no need to keep the shutter button pressed during recording.
6. Pan the camera in the direction shown by the arrow. Shooting ends automatically when the progress bar is full and the panorama is complete.



 Shooting ends if the shutter button is pressed all the way down during shooting. No panorama will be recorded if the shutter button is pressed before the camera has been panned through 120°.

For Best Results

For best results, prop your elbows against your sides and move the camera slowly in a small circle at a steady speed, keeping the camera horizontal and being careful only to pan in the direction shown by the guides. Use a tripod for best results. If the desired results are not achieved, try panning at a different speed.

-  Panoramas are created from multiple frames; exposure for the entire panorama is determined by the first frame. The camera may in some cases record an greater or lesser angle than selected or be unable to stitch the frames together perfectly. The last part of the panorama may not be recorded if shooting ends before the panorama is complete.
-  Shooting may be interrupted if the camera is panned too quickly or too slowly. Panning the camera in a direction other than that shown cancels shooting.
-  The desired results may not be achieved with moving subjects, subjects close to the camera, unvarying subjects such as the sky or a field of grass, subjects that are in constant motion, such as waves and waterfalls, or subjects that undergo marked changes in brightness. Panoramas may be blurred if the subject is poorly lit.

Viewing Panoramas

When a panorama is displayed in full-frame playback, you can press the selector down to automatically pan from left to right or (if the panorama is in “tall” orientation) bottom to top.

Macro Mode (Close-ups)

To focus at close distances, press the selector up to choose a macro mode from the options listed below.

- ✎ At default settings, macro mode selection is assigned to the up button on the selector (function button 2). For information on choosing the roles assigned to the function buttons, see “The Function Buttons”.
- ✎ Macro mode can also be selected using the **[AUTOFOCUS SETTING]** option in the shooting menu.

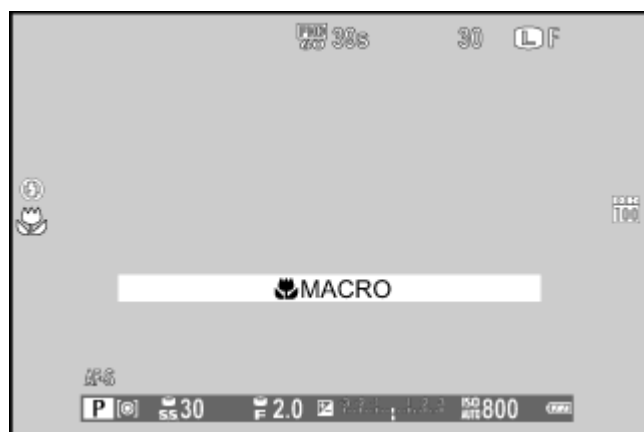
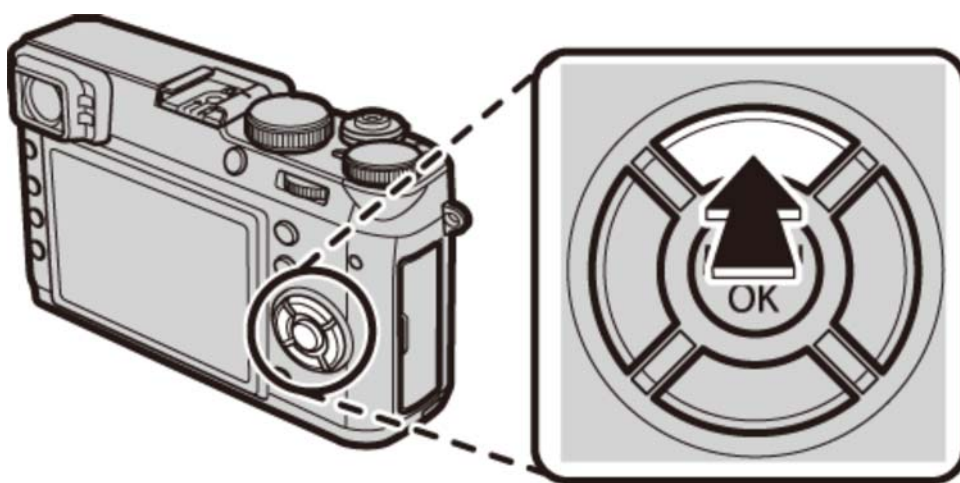

OFF Macro mode off

 **MACRO** Macro mode

❗ Macro mode is available only with the electronic viewfinder and LCD monitor. If the optical viewfinder or dual optical viewfinder/electronic range finder is on when macro mode is selected, the camera will automatically switch to the electronic viewfinder.

✎ The LCD monitor and electronic viewfinder can be used at short ranges without first enabling macro mode, but the camera may take longer to focus.

✎ The shadow cast by the lens may appear in photographs taken with the flash at very short ranges. Zoom out or increase the distance to the subject.

See Also



- ➔ [The Function Buttons](#) ([Fn] (Function) Buttons)
- ➔ [\[AUTOFOCUS SETTING\]](#) (The Shooting Menu)

Using the Self-Timer

The **[SELF-TIMER]** option in the shooting menu offers a choice of a ten-second timer for self-portraits and a two-second timer to prevent blur caused by camera shake.



Press the selector up or down to highlight the desired option and press **[MENU/OK]** to select.

-  The shutter is released two seconds after the shutter button is pressed. Use to reduce blur caused by the camera moving when the shutter button is pressed. The self-timer lamp will blink as the timer counts down.
-  The shutter is released ten seconds after the shutter button is pressed. Use for self-portraits. The self-timer lamp on the front of the camera lights when the timer starts and begins to blink shortly before the photo is taken.
- OFF** Self-timer off.

Interval Timer Photography

Adjust settings for interval timer photography.

1. Select **[INTERVAL TIMER SHOOTING]** in the shooting menu to display interval timer shooting options.

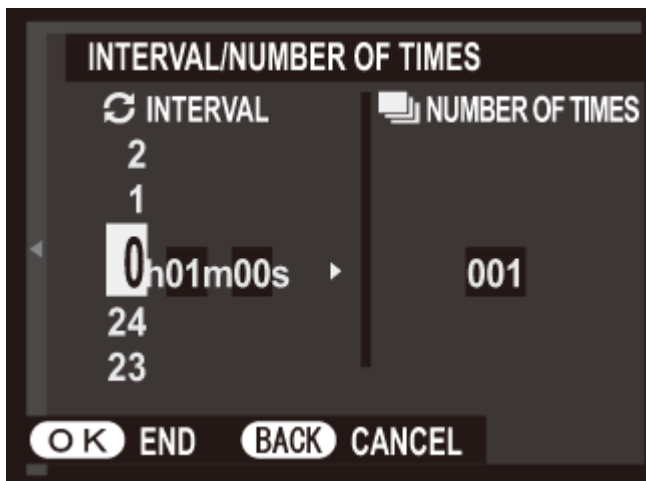

2. Use the selector to choose the interval and number of shots. Press **[MENU/OK]** to proceed.

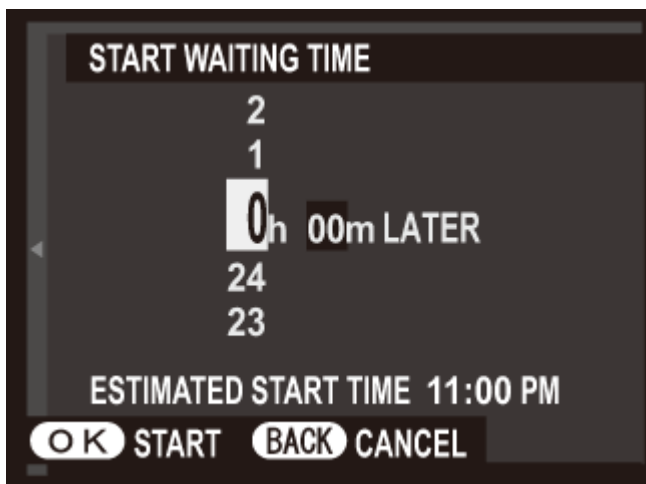

3. Use the selector to choose the starting time and then press **[MENU/OK]**. Shooting will start automatically.

⚠ Interval timer photography can not be used during panorama or multiple exposure photography. In burst mode, only one picture will be taken each time the shutter is released.

- ✎ Use of a tripod is recommended.
- ✎ Check the battery level before starting.
- ✎ The display turns off between shots and lights a few seconds before the next shot is taken. The display can be activated at any time by pressing the shutter button all the way down.

Using the Flash

Use the flash for additional lighting when shooting at night or indoors under low light. The flash mode can be selected using the **[FLASH MODE]** option in the shooting menu.



Press the selector up or down to highlight the desired flash mode and press **[MENU/OK]** to select.

[AUTO] The flash fires when required. Recommended in most situations.





 **[FORCED FLASH]** The flash fires whenever a picture is taken. Use for backlit subjects or for natural coloration when shooting in bright light.

 **[SLOW SYNCHRO]** Capture both the main subject and the background under low light (note that brightly lit scenes may be overexposed).

 **[COMMANDER]** A flash mounted on the hot shoe can be used to control optional remote flash units.



 **[EXTERNAL FLASH]** Select when using optional third-party flash units.

 **[SUPPRESSED FLASH]** The flash does not fire even when the subject is poorly lit. A tripod is recommended.

-  If  is displayed when the shutter button is pressed halfway, the flash will fire when the photo is taken.
-  Except in commander mode, the flash may fire several times with each shot. Do not move the camera until shooting is complete.
-  The flash will synchronize with the shutter at shutter speeds of 1/2000 s or slower.
-  The camera can also be used with optional FUJIFILM shoe-mounted flash units.

❗ The flash may need more time to charge when the battery is low.

Red-Eye Removal

When “intelligent face detection” is active, and on is selected for “red eye removal”, red-eye removal is available in , , .

Red-eye removal minimizes “*red-eye*” caused when light from the flash is reflected from the subject’s retinas.

Focus-Frame Selection

Follow the steps below to choose the focus point used when **[AREA]** is selected for **[AUTOFOCUS SETTING] > [AF MODE]** in the shooting menu.

1. Press the selector down to view the focus area display.

- ✎ At default settings, focus-area display is assigned to the down button on the selector (function button 5). For information on choosing the roles assigned to the function buttons, see “The Function Buttons”.
- ✎ The focus area can also be selected using the **[AUTOFOCUS SETTING]** option in the shooting menu.

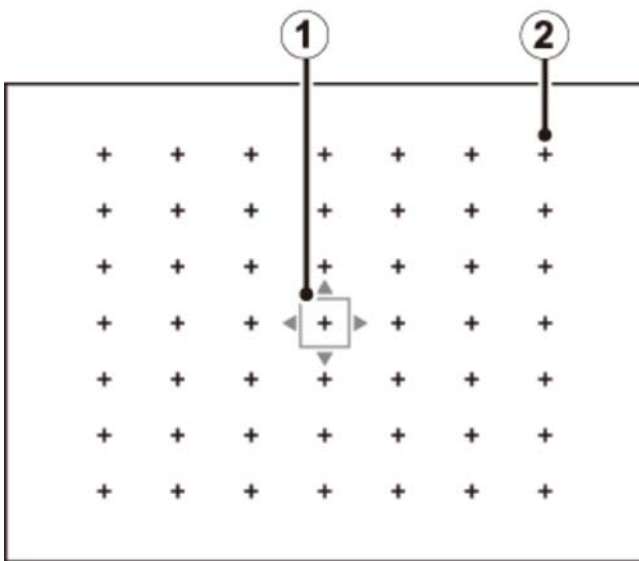
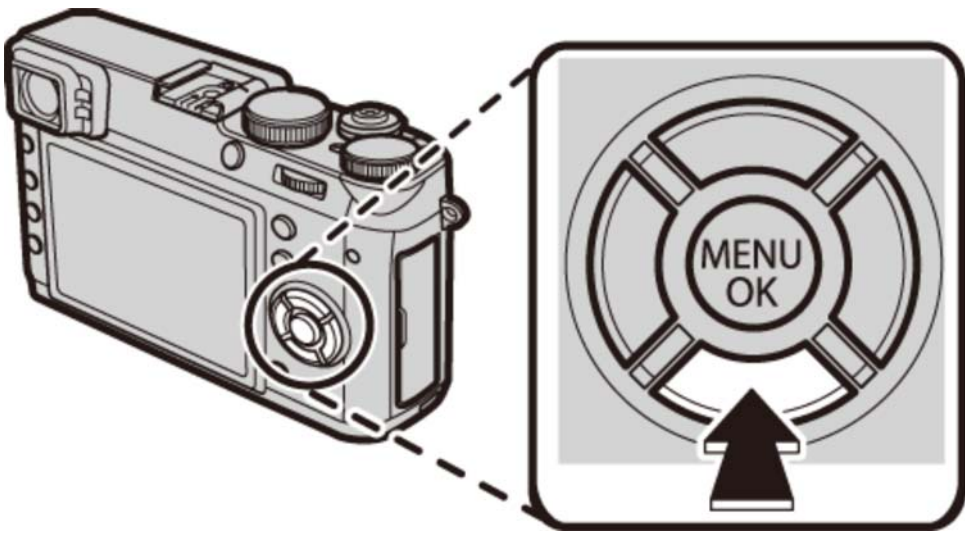

① Focus frame

② Focus point

2. Use the selector to position the focus frame.

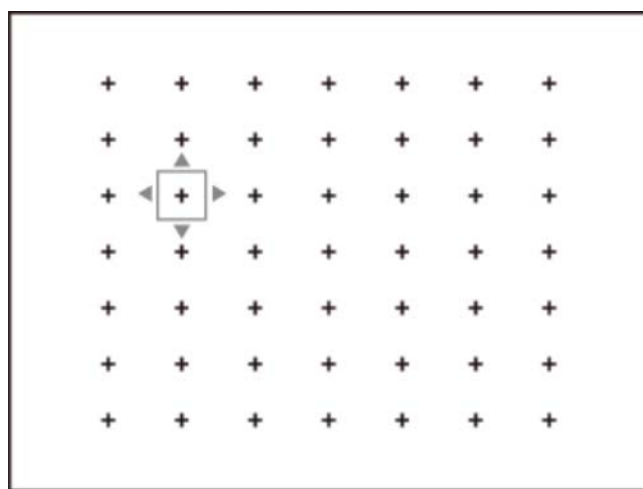
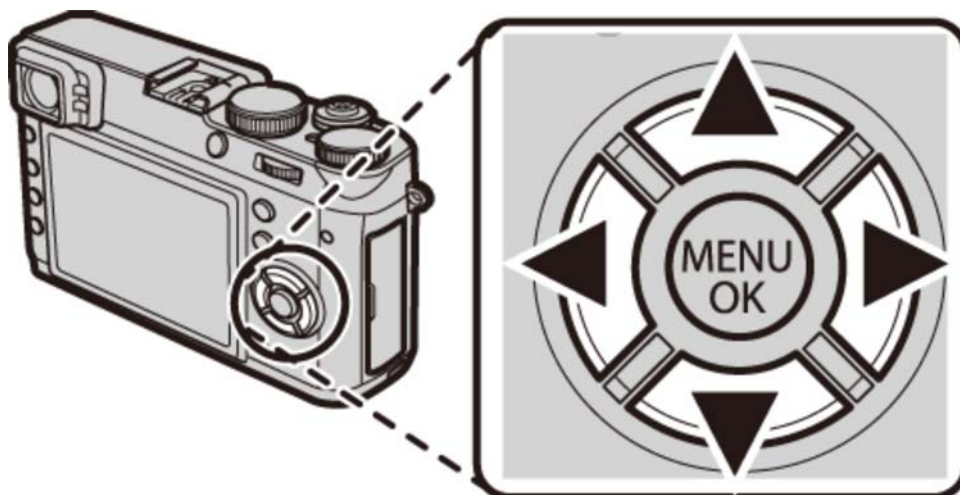

 To select the center frame, press **[DISP/BACK]**.

Rotate the command dial to choose the size of the focus frame.

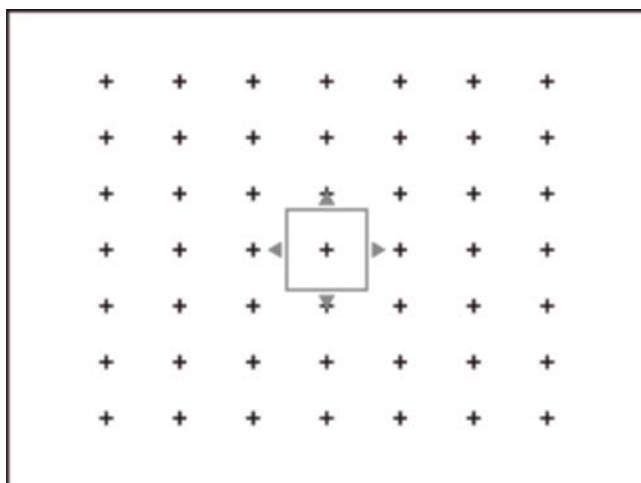
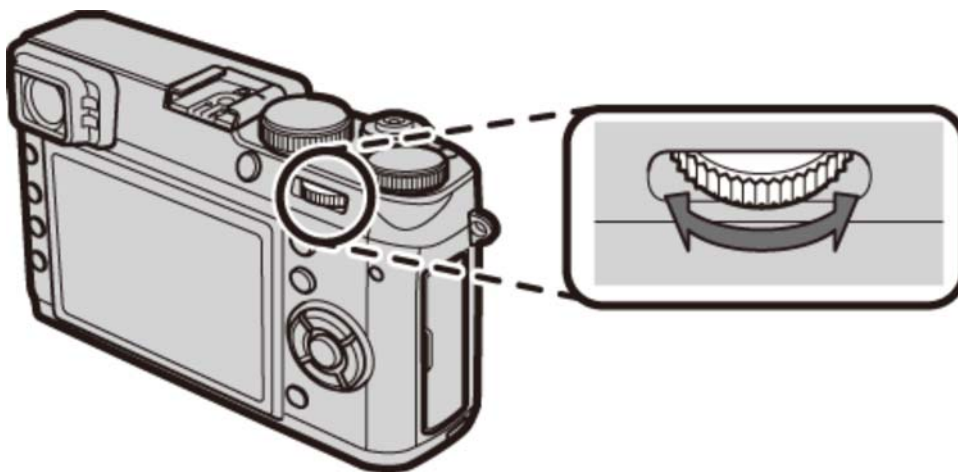

 Rotate the dial left to reduce the frame by up to 50%, right to enlarge it by up to 150%, or press the center of the dial to restore the frame to its original size.

3. Press **[MENU/OK]** to select the chosen frame.

 If **[FOCUS AREA]** is selected for **[SELECTOR BUTTON SETTING]** in the setup menu, the selector can be used to position the focus area without first pressing it down.

See Also

- ➔ [The Function Buttons](#) ([Fn] (Function) Buttons)
- ➔ [\[AUTOFOCUS SETTING\]](#) (The Shooting Menu)
- ➔ [\[SELECTOR BUTTON SETTING\]](#) (The Setup Menu)

Exposure Compensation

Rotate the exposure compensation dial to adjust exposure when photographing very bright, very dark, or high-contrast subjects.

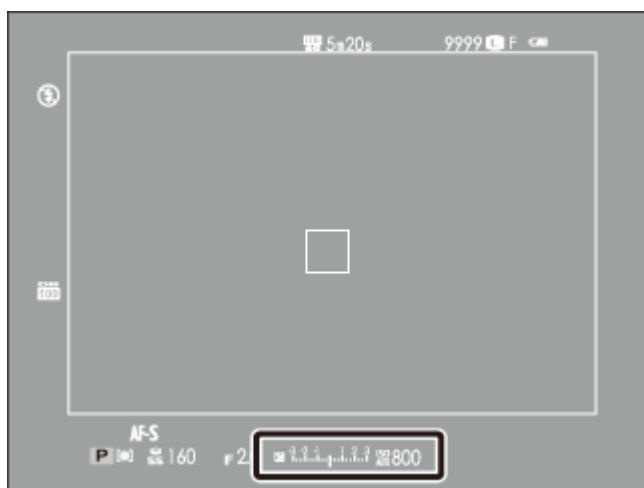
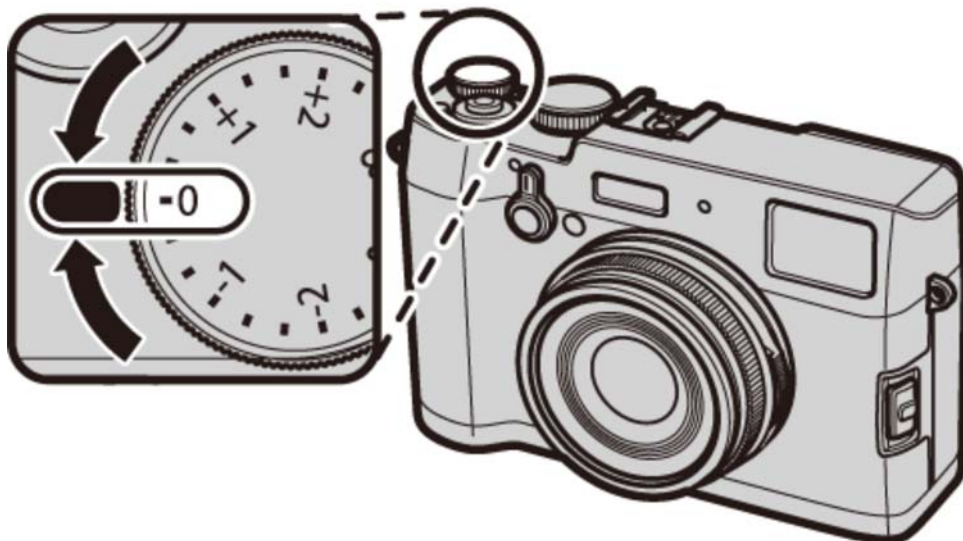

Exposure compensation indicator (OVF)



Exposure compensation indicator (EVF/LCD)

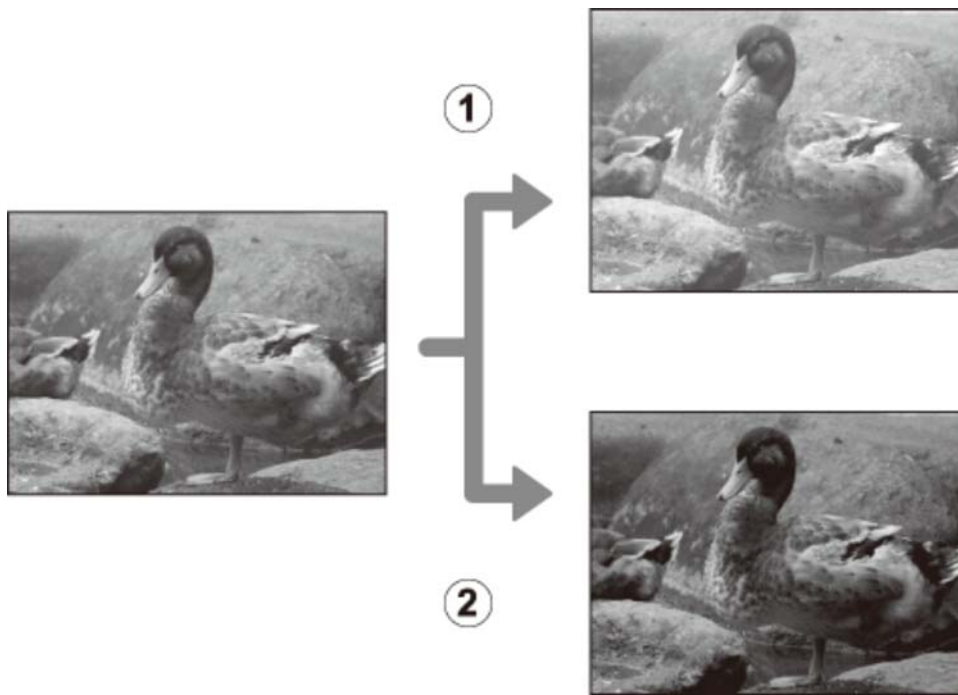

- ① Choose positive values (+) to increase exposure
- ② Choose negative values (-) to reduce exposure

⚠ When using the optical viewfinder, use the exposure indicator to check exposure.

Focus/Exposure Lock

The camera focuses and sets exposure for photographs when the shutter button is pressed halfway and focus (AF) and exposure (AE) remain locked while the shutter button is kept in this position. Use focus and exposure lock to compose photographs with off-center subjects.

1. Position the subject in the focus frame.



2. Press the shutter button halfway to set focus and exposure. The focus frame will turn green.



 This process can be repeated as often as desired before the picture is taken.

3. Recompose the photograph. Do not change the distance to the subject while the shutter button is pressed halfway.



4. Press the shutter button the rest of the way down to take the picture.



The [AEL/AFL] Button

Focus and/or exposure can also be locked using the **[AEL/AFL]** button.

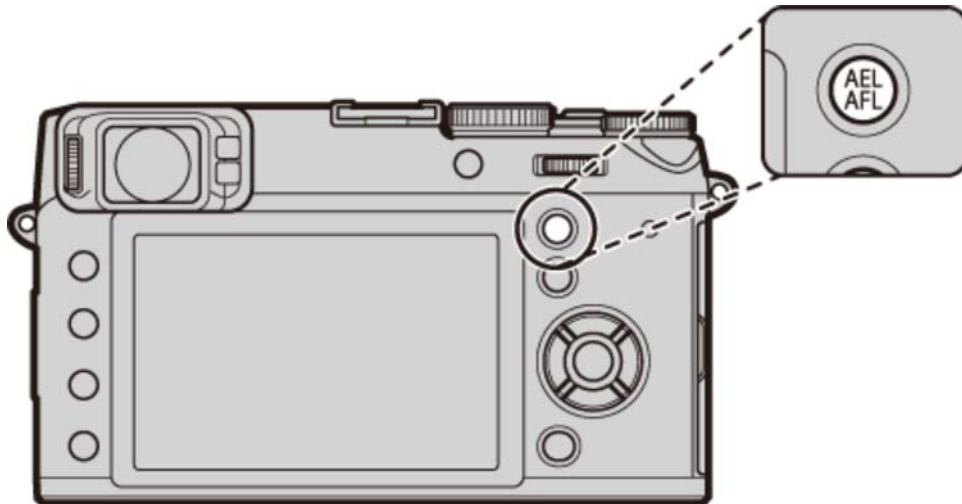

- ✎ Focus and/or exposure will remain locked while the button is pressed, regardless of whether or not the shutter button is pressed halfway.
- ✎ The role played by the **[AEL/AFL]** button can be selected using the **[AE/AF-LOCK BUTTON]** option in the shooting menu:
 - **[AE LOCK ONLY] (the default setting)**: The **[AEL/AFL]** button locks exposure only.
 - **[AF LOCK ONLY]**: The **[AEL/AFL]** button locks focus only.
 - **[AE/AF LOCK]**: The **[AEL/AFL]** button locks both focus and exposure.
- ✎ If **[AE&AF ON/OFF SWITCH]** is selected for **[AE/AF-LOCK MODE]** in the shooting menu, focus and/or exposure will lock when the button is pressed and remain locked until the button is pressed again.

Autofocus

Although the camera boasts a high-precision autofocus system, it may be unable to focus on the subjects listed below.

- Very shiny subjects such as mirrors or car bodies.



- Fast-moving subjects.

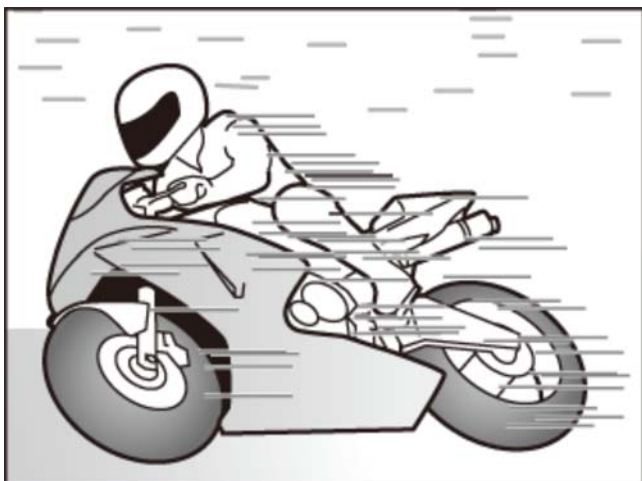

- Subjects photographed through a window or other reflective object.
- Dark subjects and subjects that absorb rather than reflect light, such as hair or fur.
- Insubstantial subjects, such as smoke or flame.
- Subjects that show little contrast with the background (for example, subjects in clothing that is the same color as the background).
- Subjects positioned in front of or behind a high-contrast object that is also in the focus frame (for example, a subject photographed against a backdrop of highly contrasting elements).

See Also

- ➔ [\[AE/AF-LOCK MODE\]](#) (The Shooting Menu)
- ➔ [\[AE/AF-LOCK BUTTON\]](#) (The Shooting Menu)

Focus Mode

Use the focus mode selector to choose how the camera focuses.

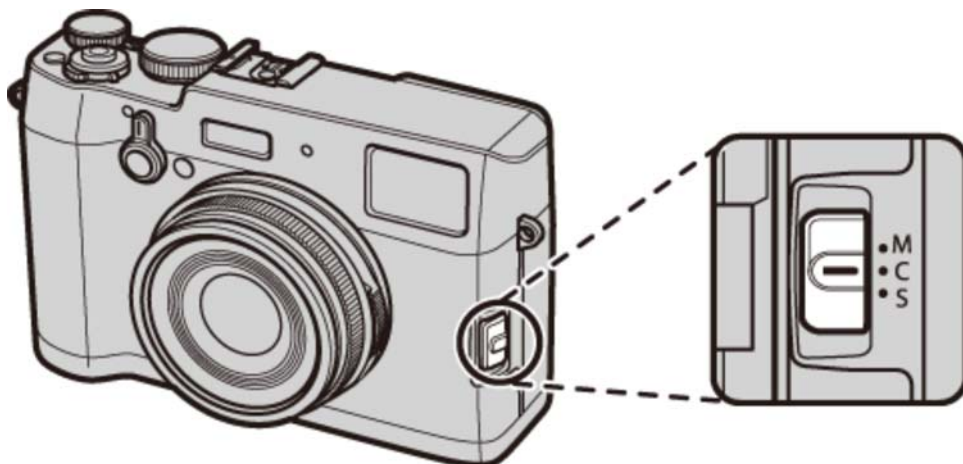

M (manual) Focus manually. Use if the camera has trouble focusing using autofocus or to take deliberately out-of-focus shots.

C (continuous AF) Focus is continually adjusted to reflect changes in the distance to the subject while the shutter button is pressed halfway. Use for subjects that are in motion.

S (single AF) Focus locks while the shutter button is pressed halfway. Choose for stationary subjects.

 If **[ON]** is selected for **[AUTOFOCUS SETTING] > [PRE-AF]** in the shooting menu, focus will be adjusted continuously in modes S and C even when the shutter button is not pressed.

The Focus Indicator

The focus indicator turns green when the subject is in focus and blinks white when the camera is unable to focus. Brackets (" () ") indicate that the camera is focusing and are displayed continuously in mode C. **MF** is displayed in manual focus mode.

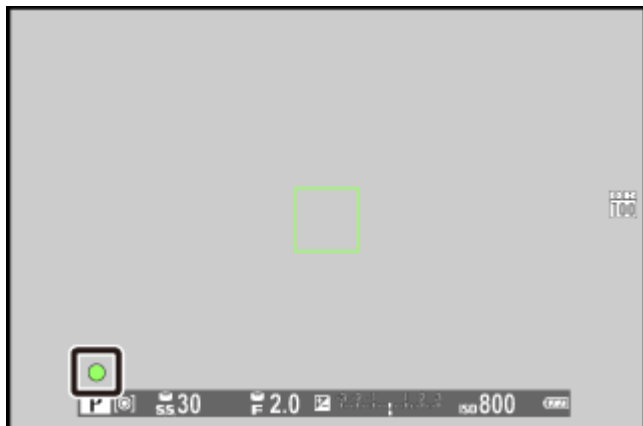

Checking Focus

To zoom in on the current focus frame for precise focus, press the center of the command dial. Press the dial again to cancel zoom.

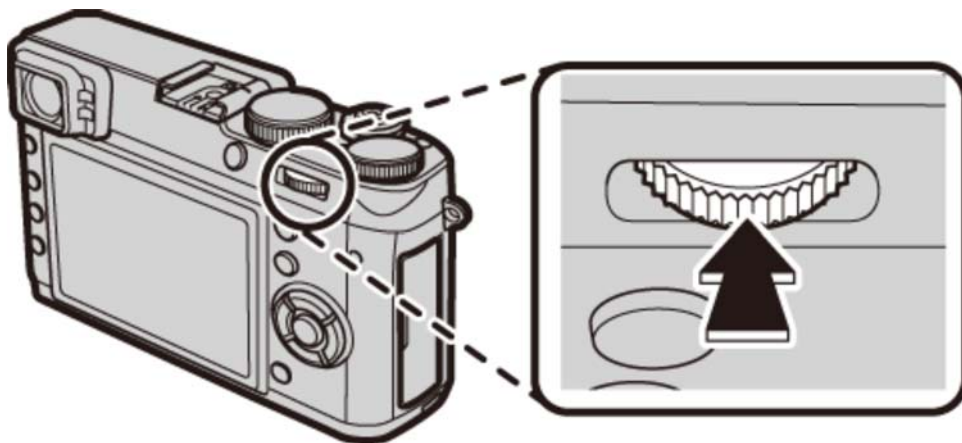

- ✎ In focus mode **[S]**, focus check is available when **[AREA]** is selected for **[AUTOFOCUS SETTING] > [AF MODE]** in the shooting menu.
- ✎ Focus check is not available when **[ON]** is selected for **[AUTOFOCUS SETTING] > [PRE-AF]** in focus mode **[C]**.

See Also

- ➔ [\[AUTOFOCUS SETTING\]](#) (The Shooting Menu)

Manual Focus (Focus Mode M)

Follow the steps below to focus the camera manually.

1. Slide the focus mode selector to **[M]**. **MF** will appear in the display.

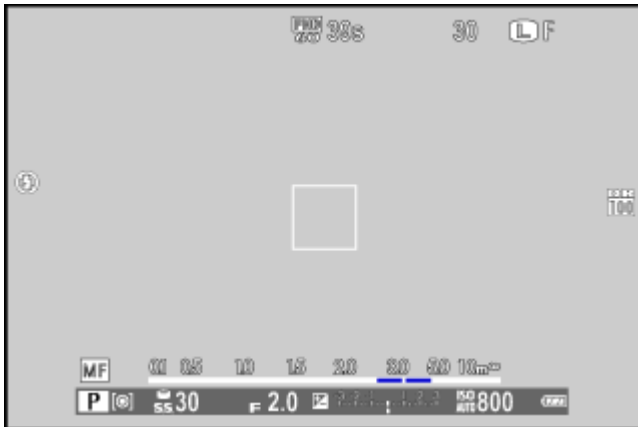
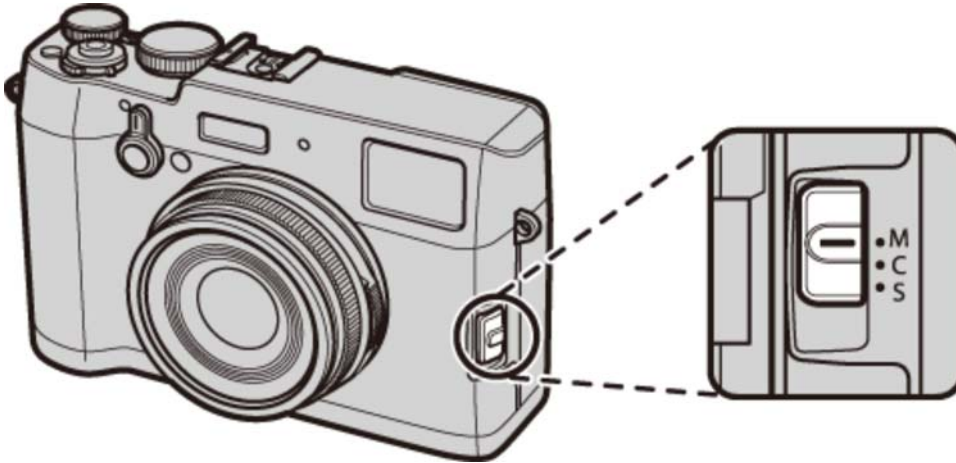

2. Focus manually using the focus ring. Rotate the ring left to reduce the focus distance, right to increase.

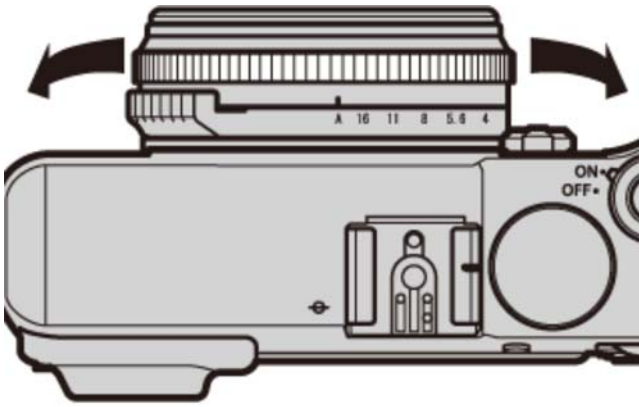

✎ Use the **[FOCUS RING]** option in the setup menu to reverse the direction of rotation for the focus ring.

3. Take pictures.

Quick Focus

To use autofocus to focus on the subject in the selected focus area, press the **[AEL/AFL]** button. Use this feature (available only in manual focus mode) to quickly focus on a chosen subject.

✎ The **[AUTOFOCUS SETTING] > [INSTANT AF SETTING]** option in the shooting menu controls how the camera focuses when the **[AEL/AFL]** button is pressed. Select **[AF-S]** for single AF (focus is adjusted each time the button is pressed), **[AF-C]** for continuous AF (focus is adjusted continuously while the button is pressed).

Checking Focus

The following options can be used to check focus in manual focus mode.

The Manual Focus Indicator

The white line indicates the distance to the subject in the focus area (in meters or feet according to the option selected for **[SCREEN SET-UP] > [FOCUS SCALE UNITS]** in the setup menu), the blue bar the depth of field, or in other words the distance in front of and behind the subject that appears to be in focus.

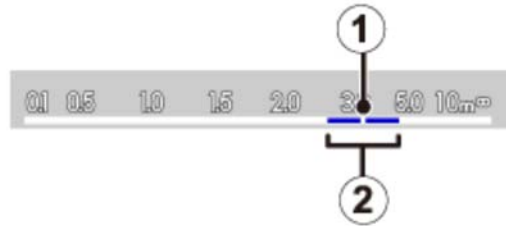

- ① Focus distance (white line)
- ② Depth of field (blue bar)

Focus Zoom

To zoom in on the current focus area for precise focus, press the center of the command dial (if **[ON]** is selected for **[FOCUS CHECK]**, the camera will also zoom in when the focus ring is rotated). Press the dial again to cancel zoom.

 The **[MF ASSIST]** menu can be displayed by pressing and holding the center of the command dial.

- **STANDARD:** Zoom in on the current focus area.
- **DIGITAL SPLIT IMAGE:** Displays a split, black-and-white image in the center of the frame. Frame the subject in the split-image area and rotate the focus ring until the three parts of the split image are correctly aligned.

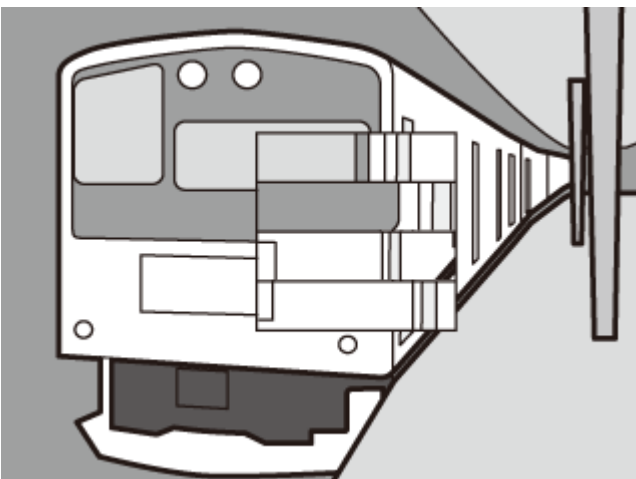



- **FOCUS PEAK HIGHLIGHT:** Highlights high-contrast outlines. Rotate the focus ring until the subject is highlighted.

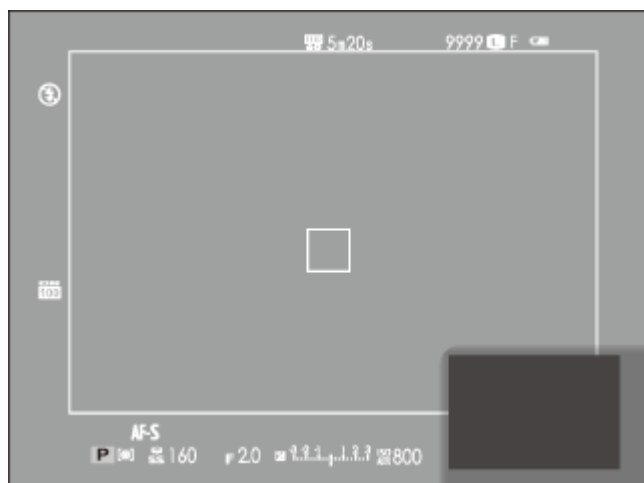

The Electronic Range Finder (ERF)

The area at the bottom right corner of the display is used for focus zoom when the electronic range finder (ERF) is enabled.



-  If **[DIGITAL SPLIT IMAGE]** is selected, the electronic range finder will show only the center segment.

See Also

- ➔ [\[FOCUS RING\]](#) (The Setup Menu)
- ➔ [\[FOCUS CHECK\]](#) (The Setup Menu)
- ➔ [\[SCREEN SET-UP\]](#) (The Setup Menu)
- ➔ [\[MF ASSIST\]](#) (The Shooting Menu)

Metering

To choose how the camera measures the brightness of the subject, press the  button.

- ✎ At default settings, metering is assigned to function button 6. For information on choosing the roles assigned to the function buttons, see “The Function Buttons”.
- ✎ Metering can also be selected in the shooting menu.

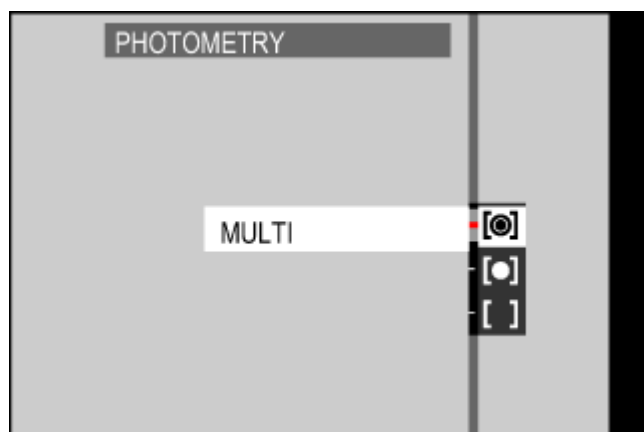
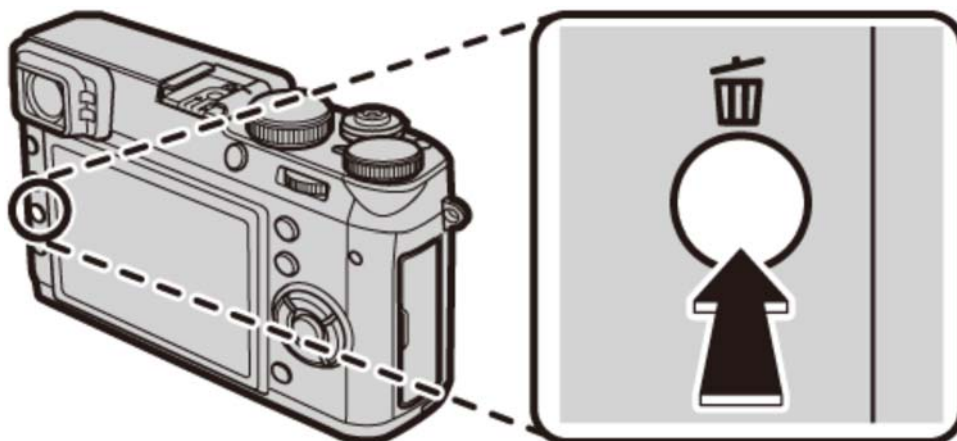



 **[MULTI]** Automatic scene recognition is used to adjust exposure for a wide range of shooting conditions.

 **[SPOT]** The camera meters lighting conditions in the selected focus area or at the center of the frame. Recommended when the background is much brighter or darker than the main subject.

 If **[INTERLOCK SPOT AE & FOCUS AREA]** is **[ON]** and **[AREA]** is selected for **[AUTOFOCUS SETTING] > [AF MODE]**, the camera will meter lighting conditions in the selected focus area. If **[INTERLOCK SPOT AE & FOCUS AREA]** is **[OFF]**, the camera will meter the center focus area.

 **[AVERAGE]** Exposure is set to the average for the entire frame. Provides consistent exposure across multiple shots with the same lighting, and is particularly effective for landscapes and portraits of subjects dressed in black or white.

See Also

-  [The Function Buttons](#) ([Fn] (Function) Buttons)
-  [\[PHOTOMETRY\]](#) (The Shooting Menu)

Recording Pictures in RAW Format

To record raw, unprocessed data from the camera image sensor, select a **[RAW]** option for image quality in the shooting menu as described below. JPEG copies of RAW images can be created using the **[RAW CONVERSION]** option in the playback menu, or RAW images can be viewed on a computer using optional **[RAW FILE CONVERTER]** software.

1. Press **[MENU/OK]** in shooting mode to display the shooting menu. Press the selector up or down to highlight **[IMAGE QUALITY]** and press **[MENU/OK]**.
2. Highlight an option and press **[MENU/OK]**. Select **[RAW]** to record only RAW images, or **[FINE+RAW]** or **[NORMAL+RAW]** to record both JPEG copy together with the RAW images. **[FINE+RAW]** uses lower JPEG compression ratios for higher-quality JPEG images, while **[NORMAL+RAW]** uses higher JPEG compression ratios to increase the number of images that can be stored.



 RAW image quality options are not available with extended ISO sensitivity.



The Function Buttons

To toggle RAW image quality on or off for a single shot, assign **[RAW]** to a function button. If a JPEG option is currently selected for image quality, pressing the button temporarily selects the equivalent JPEG+RAW option. If a JPEG+RAW option is currently selected, pressing the button temporarily selects the equivalent JPEG option, while if **[RAW]** is selected, pressing the button temporarily selects **[FINE]**. Taking a picture or pressing the button again restores the previous setting.

See Also

-  [The Function Buttons \(\[Fn\] \(Function\) Buttons\)](#)
-  [RAW FILE CONVERTER \(opens in another window\)](#)

Long Time-Exposures (T/B)

Select a shutter speed of **[T]** (time) or **[B]** (bulb) for long time-exposures.

 Use of a tripod is recommended to prevent the camera from moving during the exposure.

⌵ Time (T)

⌵ Bulb (B)

Time (T)

1. Rotate the shutter speed dial to **[T]**.

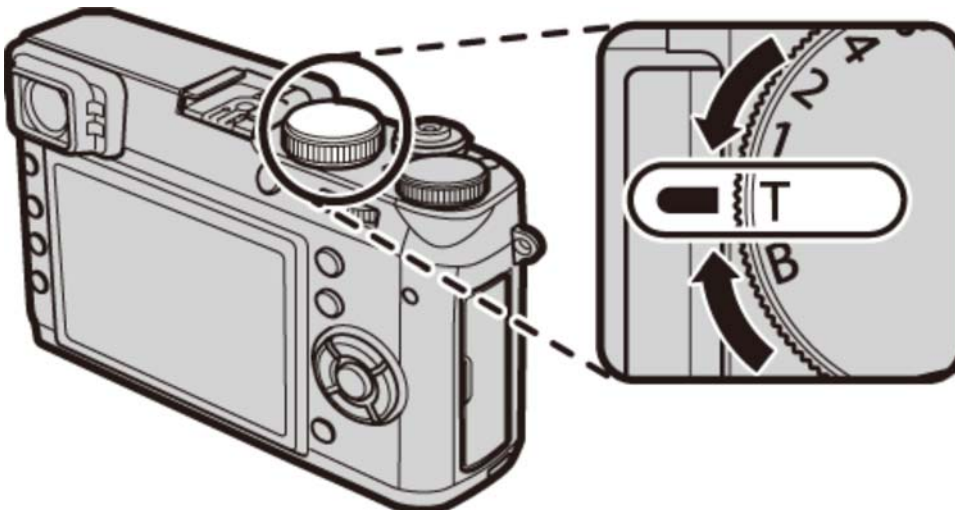

2. Rotate the command dial to choose a shutter speed between 30s and 2s in steps of 1/3 EV.

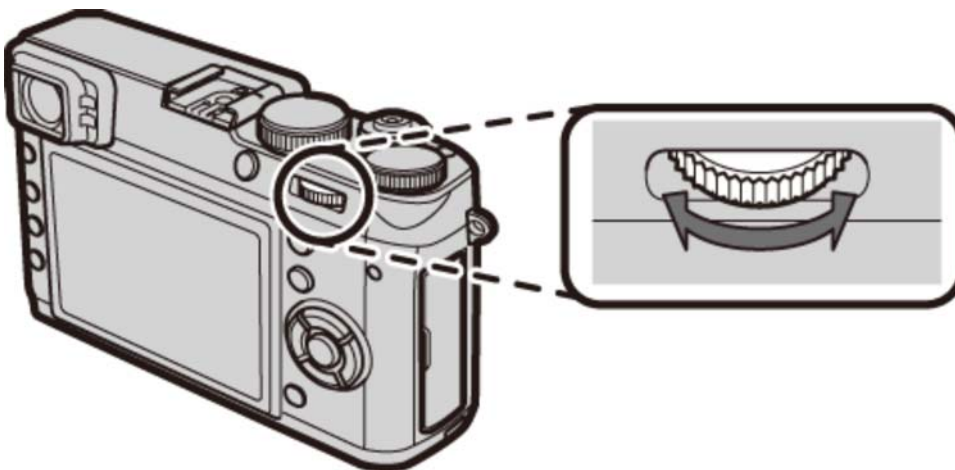

3. Press the shutter button all the way down to take a picture at the selected shutter speed. A count-down timer will be displayed while the exposure is in progress.

Bulb (B)

1. Rotate the shutter speed dial to **[B]**.

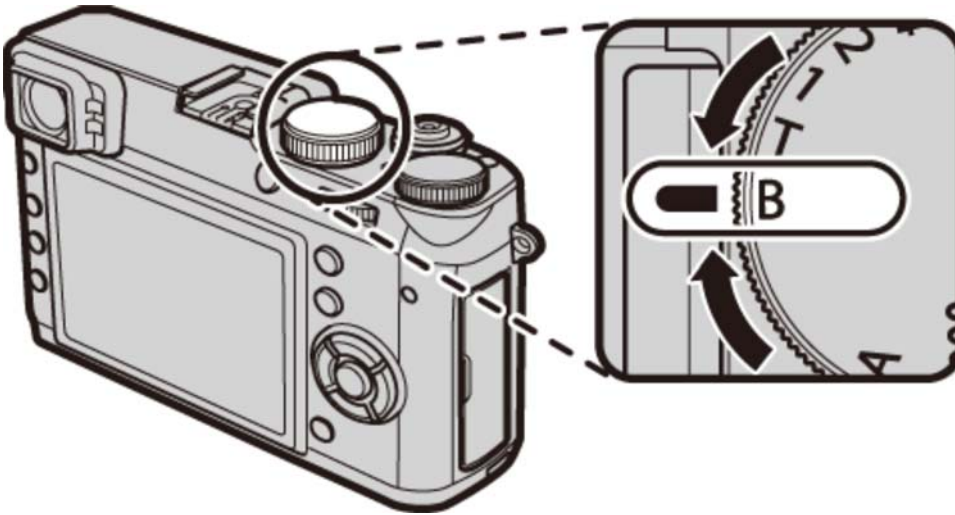

2. Press the shutter button all the way down. The shutter will remain open for up to 60 minutes while the shutter button is pressed; the display shows the time elapsed since the exposure started.









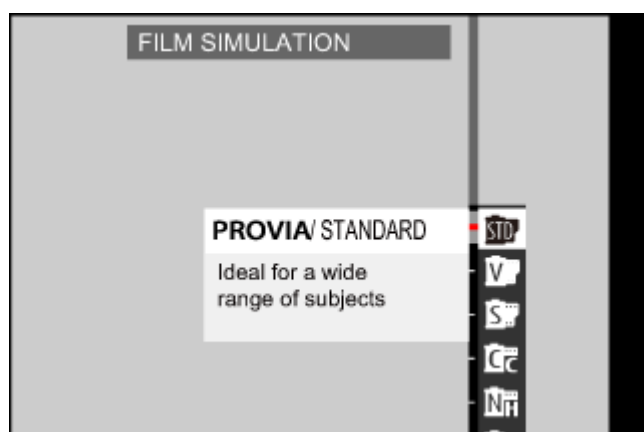
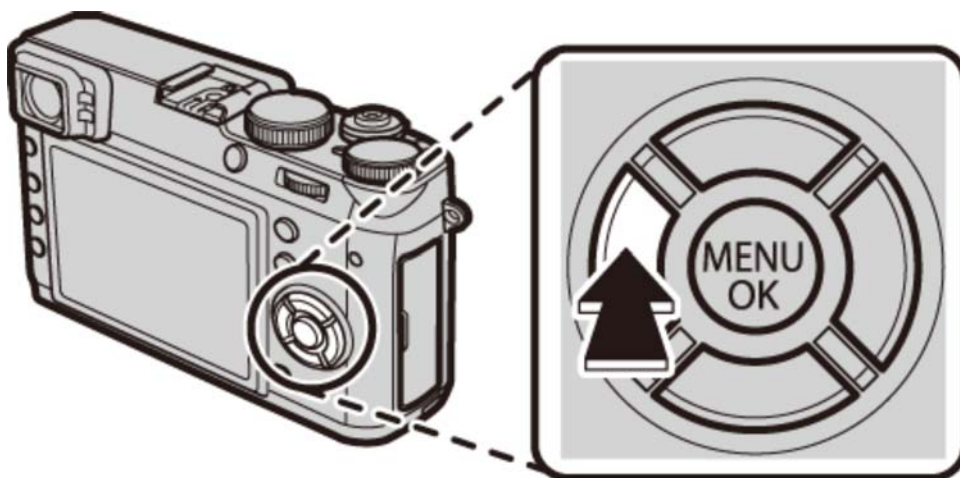



- ✎ Selecting an aperture of **[A]** fixes shutter speed at 30 s.
- ✎ To reduce “noise” (mottling) in long time-exposures, select **[ON]** for **[LONG EXPOSURE NR]** in the shooting menu. Note that this may increase the time needed to record images after shooting.

Film Simulation

Simulate the effects of different types of film, including sepia and black-and-white. Press the selector left to display a menu of film simulation types.

- ✎ At default settings, film simulation is assigned to the left button on the selector (function button 3). For information on choosing the roles assigned to the function buttons, see "The Function Buttons".
- ✎ Film simulation can also be selected in the shooting menu.



 [PROVIA/STANDARD]	Standard color reproduction. Suited to a wide range of subjects, from portraits to landscapes.
 [Velvia/VIVID]	A high-contrast palette of saturated colors, suited to nature photographs.
 [ASTIA/SOFT]	A soft-toned palette of less saturated colors.
 [CLASSIC CHROME]	Soft color and enhanced shadow contrast for a calm look.
 [PRO Neg. Hi]	Offers slightly more contrast than  (PRO Neg. Std). Recommended for outdoor portrait photography.
 [PRO Neg. Std]	A soft-toned palette. The range of hues available for skin tones is enhanced, making this a good choice for studio portrait photography.
 [MONOCHROME]	Take pictures in black and white.
 [MONOCHROME+Ye FILTER]	Take black-and-white pictures with slightly increased contrast. This setting also slightly tones down the brightness of the sky.
 [MONOCHROME+R FILTER]	Take black-and-white pictures with increased contrast. This setting also tones down the brightness of the sky.
 [MONOCHROME+G FILTER]	Soften skin tones in black-and-white portraits.
 [SEPIA]	Take pictures in sepia.

See Also

- ➔ [The Function Buttons](#) ([Fn] (Function) Buttons)
- ➔ [\[FILM SIMULATION\]](#) (The Shooting Menu)

White Balance

Adjust colors to match the light source.

1. Press the selector right to display white balance options.

- ✎ At default settings, white balance is assigned to the right button on the selector (function button 4). For information on choosing the roles assigned to the function buttons, see "The Function Buttons".
- ✎ White balance can also be selected in the shooting menu.

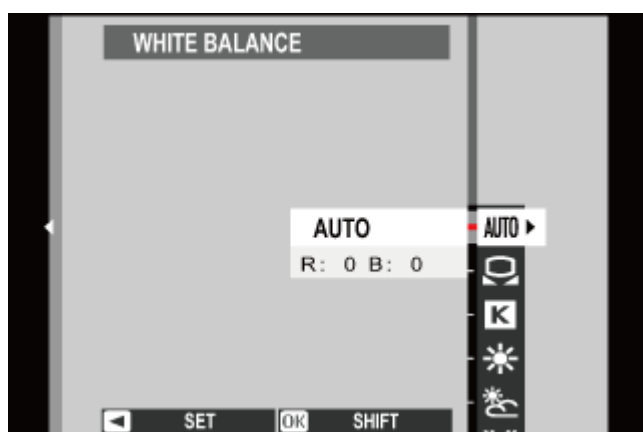
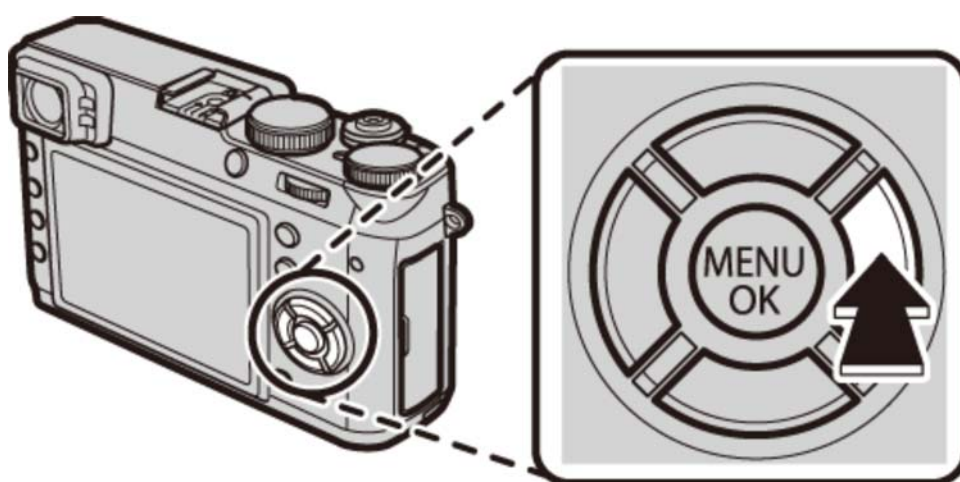

2. Press the selector up or down to highlight the desired option.

AUTO White balance adjusted automatically.

 Measure a value for white balance.

 Choose a color temperature.

 For subjects in direct sunlight.

 For subjects in the shade.

 Use under "daylight" fluorescent lights.

 Use under "warm white" fluorescent lights.

 Use under "cool white" fluorescent lights.

 Use under incandescent lighting.

 Reduces the blue cast typically associated with underwater lighting.

3. Press **[MENU/OK]**. The dialog shown below will be displayed; use the selector to fine-tune white balance and press **[MENU/OK]** to select, or press **[DISP/BACK]** to exit without fine-tuning.

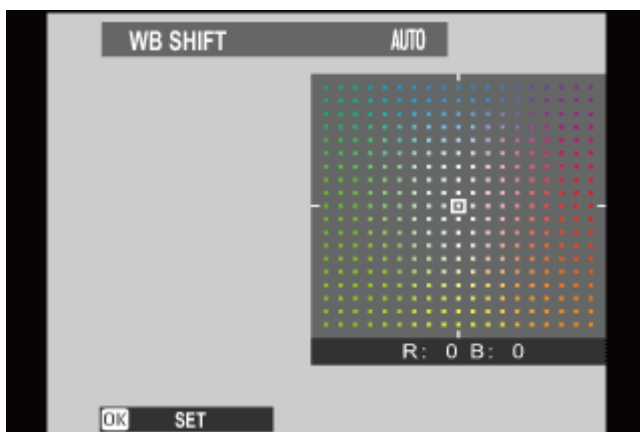

 Results vary with shooting conditions. Play pictures back after shooting to check colors.

 [Custom White Balance](#)

 [Color Temperature](#)

Custom White Balance

Choose  to adjust white balance for unusual lighting conditions. White balance measurement options will be displayed; frame a white object so that it fills the display and press the shutter button all the way down to measure white balance (to select the most recent custom value and exit without measuring white balance, press **[DISP/BACK]**, or press **[MENU/OK]** to select the most recent value and display the fine-tuning dialog).

- If **“COMPLETED!”** is displayed, press **[MENU/OK]** to set white balance to the measured value.
- If **“UNDER”** is displayed, raise exposure compensation and try again.
- If **“OVER”** is displayed, lower exposure compensation and try again.

Color Temperature

Color temperature is an objective measure of the color of a light source, expressed in Kelvin (K). Light sources with a color temperature close to that of direct sunlight appear white; light sources with a lower color temperature have a yellow or red cast, while those with a higher color temperature are tinged with blue. You can match color temperature to the light source as shown in the following table, or choose options that differ sharply from the color of the light source to make pictures “warmer” or “colder”.

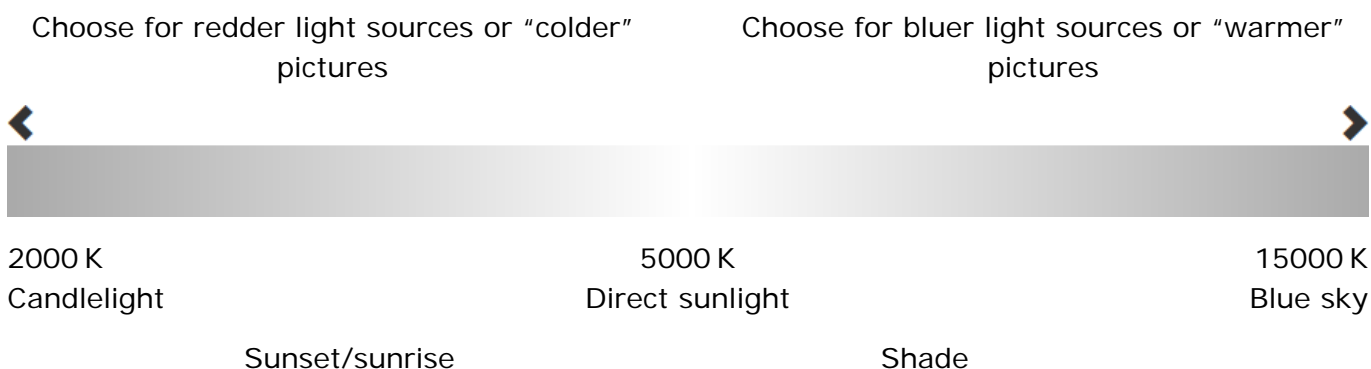



See Also

- ➔ [The Function Buttons](#) ([Fn] (Function) Buttons)
- ➔ [\[WHITE BALANCE\]](#) (The Shooting Menu)

Advanced Filters

Take photos with filter effects. Select **[ADVANCED FILTER]** in the shooting menu and choose from the following options:

 **[TOY CAMERA]** Choose for a retro toy camera effect.

 **[MINIATURE]** The tops and bottoms of pictures are blurred for a diorama effect.

 **[POP COLOR]** Create high-contrast images with saturated colors.

 **[HIGH-KEY]** Create bright, low-contrast images.

 **[LOW-KEY]** Create uniformly dark tones with few areas of emphasized highlights.

 **[DYNAMIC TONE]** Dynamic tone expression is used for a fantasy effect.

 **[SOFT FOCUS]** Create a look that is evenly soft throughout the whole image.

 **[PARTIAL COLOR (RED)]** Reds are recorded in color, while other colors are recorded in black and white.

 **[PARTIAL COLOR (ORANGE)]** Orange objects are recorded in color, while other colors are recorded in black and white.

 **[PARTIAL COLOR (YELLOW)]** Yellows are recorded in color, while other colors are recorded in black and white.

 **[PARTIAL COLOR (GREEN)]** Greens are recorded in color, while other colors are recorded in black and white.

 **[PARTIAL COLOR (BLUE)]** Blues are recorded in color, while other colors are recorded in black and white.

 **[PARTIAL COLOR (PURPLE)]** Purples are recorded in color, while other colors are recorded in black and white.

[OFF] Advanced filters off.

 Depending on the subject and camera settings, images may in some cases be grainy or vary in brightness and hue.

 Selecting an advanced filter sets the **[SCREEN SET-UP] > [IMAGE DISP.]** option in the setup menu to **[0.5 SEC]**.

The Shooting Menu

- Using the Shooting Menu
- Factory Defaults—Shooting Menu
- [AUTOFOCUS SETTING]
- [ISO]
- [IMAGE SIZE]
- [IMAGE QUALITY]
- [DYNAMIC RANGE]
- [FILM SIMULATION]
- [FILM SIMULATION BKT]
- [ND FILTER]
- [COLOR]
- [SHARPNESS]
- [HIGHLIGHT TONE]
- [SHADOW TONE]
- [NOISE REDUCTION]
- [LONG EXPOSURE NR]
- [WHITE BALANCE]
- [SELECT CUSTOM SETTING]
- [EDIT/SAVE CUSTOM SETTING]
- [FUNCTION (Fn) SETTING]
- [DISP. CUSTOM SETTING]
- [CONVERSION LENS]
- [MF ASSIST]
- [ADVANCED FILTER]
- [INTERVAL TIMER SHOOTING]
- [SELF-TIMER]
- [AE/AF-LOCK MODE]
- [AE/AF-LOCK BUTTON]
- [PHOTOMETRY]
- [INTERLOCK SPOT AE & FOCUS AREA]
- [RED EYE REMOVAL]
- [SAVE ORG IMAGE]
- [FLASH MODE]
- [FLASH COMPENSATION]

➔ [SHUTTER TYPE]

➔ [MOVIE SET-UP]

➔ [WIRELESS COMMUNICATION]

Using the Shooting Menu

Use the shooting menus to adjust shooting settings. The options available vary with the shooting mode selected.

1. Press **[MENU/OK]** to display the shooting menu.



2. Press the selector up or down to highlight the desired menu item.
3. Press the selector right to display options for the highlighted item.



4. Press the selector up or down to highlight the desired option.
5. Press **[MENU/OK]** to select the highlighted option.
6. Press **[DISP/BACK]** to exit from the menu.

See Also

- ➔ [AUTOFOCUS SETTING]
- ➔ [ISO]
- ➔ [IMAGE SIZE]
- ➔ [IMAGE QUALITY]
- ➔ [DYNAMIC RANGE]
- ➔ [FILM SIMULATION]
- ➔ [FILM SIMULATION BKT]
- ➔ [ND FILTER]
- ➔ [COLOR]
- ➔ [SHARPNESS]
- ➔ [HIGHLIGHT TONE]
- ➔ [SHADOW TONE]
- ➔ [NOISE REDUCTION]
- ➔ [LONG EXPOSURE NR]
- ➔ [WHITE BALANCE]
- ➔ [SELECT CUSTOM SETTING]
- ➔ [EDIT/SAVE CUSTOM SETTING]
- ➔ [FUNCTION (Fn) SETTING]
- ➔ [DISP. CUSTOM SETTING]
- ➔ [CONVERSION LENS]
- ➔ [MF ASSIST]
- ➔ [ADVANCED FILTER]
- ➔ [INTERVAL TIMER SHOOTING]
- ➔ [SELF-TIMER]
- ➔ [AE/AF-LOCK MODE]
- ➔ [AE/AF-LOCK BUTTON]
- ➔ [PHOTOMETRY]
- ➔ [INTERLOCK SPOT AE & FOCUS AREA]
- ➔ [RED EYE REMOVAL]
- ➔ [SAVE ORG IMAGE]
- ➔ [FLASH MODE]
- ➔ [FLASH COMPENSATION]
- ➔ [SHUTTER TYPE]
- ➔ [MOVIE SET-UP]
- ➔ [WIRELESS COMMUNICATION]

Factory Defaults—Shooting Menu

The factory default settings for the options in the shooting menus are listed below.

 These settings can be restored using the **[RESET] > [SHOOTING MENU RESET]** option in the setup menu.

[AUTOFOCUS SETTING]	
[MACRO]	[OFF]
[RELEASE/FOCUS PRIORITY]	
[AF-S PRIORITY SELECTION]	[RELEASE]
[AF-C PRIORITY SELECTION]	[RELEASE]
[INSTANT AF SETTING]	[AF-S]
[AF MODE]	[AREA]
[FACE DETECTION]	[OFF]
[PRE-AF]	[OFF]
[AF ILLUMINATOR]	[ON]
[CORRECTED AF FRAME]	[OFF]
[ISO]	[200]
[IMAGE SIZE]	L [3:2]
[IMAGE QUALITY]	[FINE]
[DYNAMIC RANGE]	P100 [100%]
[FILM SIMULATION]	STD [PROVIA/STANDARD]
[FILM SIMULATION BKT]	
[FILM 1]	STD [PROVIA/STANDARD]
[FILM 2]	V [Velvia/VIVID]
[FILM 3]	S [ASTIA/SOFT]
[ND FILTER]	[OFF]

[COLOR]	(0) [MID]
[SHARPNESS]	(0) [STANDARD]
[HIGHLIGHT TONE]	(0) [STANDARD]
[SHADOW TONE]	(0) [STANDARD]
[NOISE REDUCTION]	(0) [STANDARD]
[LONG EXPOSURE NR]	[ON]
[WHITE BALANCE]	[AUTO]
[FUNCTION (Fn) SETTING]	
Fn1	[MOVIE]
Fn2	[MACRO]
Fn3	[FILM SIMULATION]
Fn4	[WHITE BALANCE]
Fn5	[FOCUS AREA]
Fn6	[PHOTOMETRY]
Fn7	[WIRELESS COMMUNICATION]

<p>[DISPLAY CUSTOM SETTING] (OVF, EVF/LCD)</p>	<p><input type="checkbox"/> [FRAMING GUIDELINE]</p> <p><input type="checkbox"/> [ELECTRONIC LEVEL]</p> <p><input type="checkbox"/> [AF DISTANCE INDICATOR]</p> <p><input checked="" type="checkbox"/> [MF DISTANCE INDICATOR]</p> <p><input type="checkbox"/> [HISTOGRAM]</p> <p><input checked="" type="checkbox"/> [APERTURE/S-SPEED/ISO]</p> <p><input checked="" type="checkbox"/> [EXP. COMPENSATION]</p> <p><input checked="" type="checkbox"/> [PHOTOMETRY]</p> <p><input checked="" type="checkbox"/> [FLASH]</p> <p><input checked="" type="checkbox"/> [WHITE BALANCE]</p> <p><input checked="" type="checkbox"/> [FILM SIMULATION]</p> <p><input checked="" type="checkbox"/> [DYNAMIC RANGE]</p> <p><input checked="" type="checkbox"/> [FRAMES REMAINING]</p> <p><input checked="" type="checkbox"/> [IMAGE SIZE/QUALITY]</p> <p><input checked="" type="checkbox"/> [MOVIE MODE & REC. TIME] (EVF/LCD)</p> <p><input type="checkbox"/> [MOVIE MODE & REC. TIME] (OVF)</p> <p><input checked="" type="checkbox"/> [BATTERY LEVEL]</p>
[CONVERSION LENS]	[OFF]
[MF ASSIST]	[STANDARD]
[ADVANCED FILTER]	[OFF]
[SELF-TIMER]	[OFF]
[AE/AF-LOCK MODE]	[AE&AF ON WHEN PRESSING]
[AE/AF-LOCK BUTTON]	[AE LOCK ONLY]
[PHOTOMETRY]	[MULTI]
[INTERLOCK SPOT AE & FOCUS AREA]	[ON]
[RED EYE REMOVAL]	[OFF]
[SAVE ORG IMAGE]	[OFF]
[FLASH MODE]	[FORCED FLASH]
[FLASH COMPENSATION]	±0
[SHUTTER TYPE]	[MECHANICAL SHUTTER]

[MOVIE SET-UP]**[MOVIE MODE]** **[1920×1080] [60 fps]****[MOVIE ISO]****[AUTO]****[MIC LEVEL ADJUSTMENT]****[3]****[MIC/REMOTE RELEASE]****[MIC]**

AF [AUTOFOCUS SETTING]

Adjust autofocus settings.

- ⌵ [FOCUS AREA]
- ⌵ [MACRO]
- ⌵ [RELEASE/FOCUS PRIORITY]
- ⌵ [INSTANT AF SETTING]
- ⌵ [AF MODE]
- ⌵ [FACE DETECTION]
- ⌵ [PRE-AF]
- ⌵ [AF ILLUMINATOR]
- ⌵ [CORRECTED AF FRAME]

[FOCUS AREA]

Focus-area selection is available when **[AREA]** is selected for **[AF MODE]** in focus mode **[S]** or **[C]**. In focus mode **[M]**, you can press the center of the command dial to zoom in on the selected focus area or focus on the subject in the selected area at the touch of a button.

[MACRO]

Select macro (close-up) mode.

[RELEASE/FOCUS PRIORITY]

Choose how the camera focuses in focus mode **[S]** or **[C]**.

- [RELEASE]** Shutter response is prioritized over focus. Pictures can be taken when the camera is not in focus.
- [FOCUS]** Focus is prioritized over shutter response. Pictures can be only taken when the camera is in focus.



[INSTANT AF SETTING]

Choose how the camera focuses when the **[AEL/AFL]** button is used for autofocus in focus mode **[M]**.

- [AF-S]** Focus is adjusted at the time the button is pressed.
- [AF-C]** Focus is adjusted continuously while the button is pressed.

[AF MODE]

Choose how the camera selects the focus area in focus modes **[S]** and **[C]**.



-  **[MULTI]** When the shutter button is pressed halfway, the camera detects high-contrast subjects near the center of the frame and selects the focus area automatically.
-  **[AREA]** Choose the focus area manually.

[FACE DETECTION]

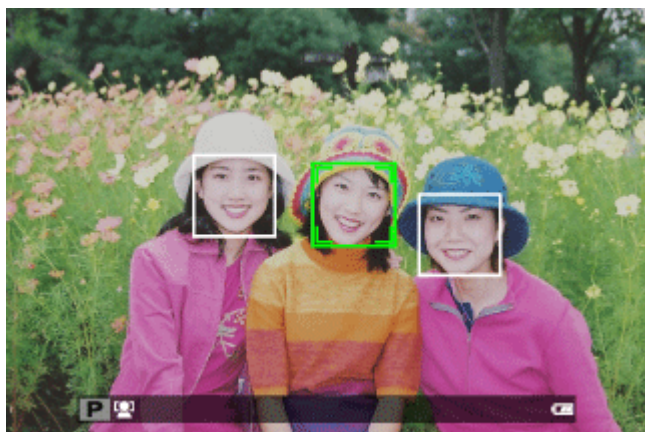
Intelligent Face Detection allows the camera to automatically detect human faces and set focus and exposure for a face anywhere in the frame for shots that emphasize portrait subjects. Choose for group portraits (in horizontal or vertical orientations) to prevent the camera from focusing on the background.



Faces can be detected with the camera in vertical or horizontal orientation; if a face is detected, it will be indicated by a green border. If there is more than one face in the frame, the camera will select the face closest to the center; other faces are indicated by white borders.

-  In some modes, the camera may set exposure for the frame as a whole rather than the portrait subject.
-  If the subject moves as the shutter button is pressed, their face may not be in the area indicated by the green border when the picture is taken.

[PRE-AF]

If **[ON]** is selected, the camera will continue to adjust focus even when the shutter-release button is not pressed halfway.

⚠ Note that this increases the drain on the battery.

[AF ILLUMINATOR]

If **[ON]** is selected, the AF-assist illuminator will light to assist autofocus.

✎ The AF-assist illuminator turns off automatically in silent mode.

- ⚠ The camera may be unable to focus using the AF-assist illuminator in some cases. If the camera is unable to focus in macro mode, try increasing the distance to the subject.
- ⚠ Avoid shining the AF-assist illuminator directly into your subject's eyes.

[CORRECTED AF FRAME]

If **[ON]** is selected, a second focus frame for focus distances of about 50 cm (1.6 ft.) will be added to the display in the optical viewfinder. The focus frame for the current focus distance is displayed in green when the shutter button is pressed halfway.

ON

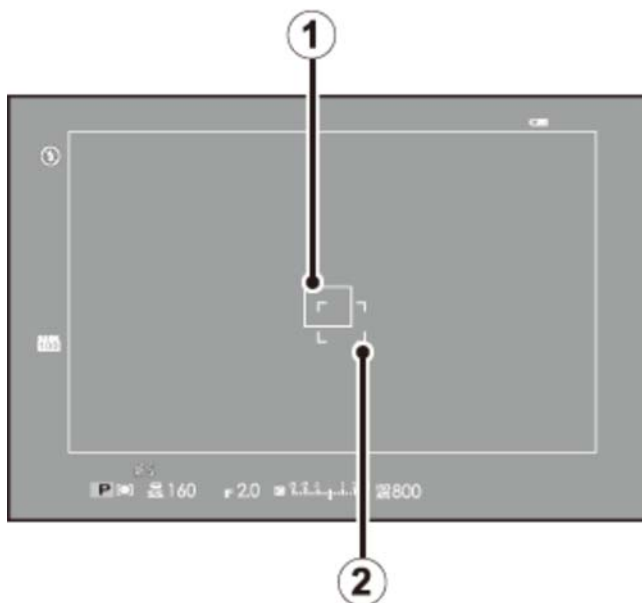

① Focus frame for focus distance of infinity

② Focus frame for focus distance of about 50 cm (1.6 ft.)

OFF

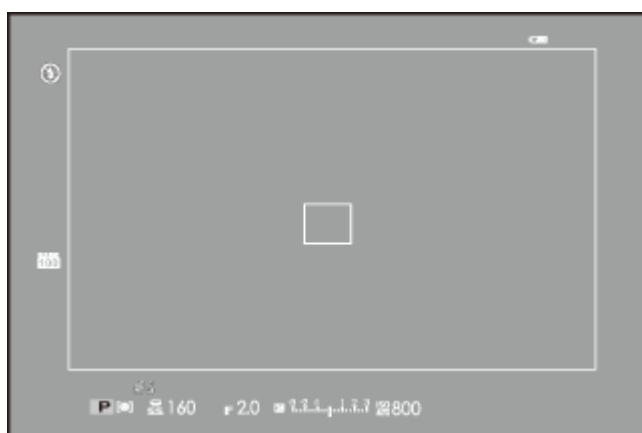

ISO [ISO]

Adjust sensitivity. The higher the sensitivity, the less light required to take a photograph; note, however, that mottling may appear at higher values. Choose a value according to shooting conditions.

[AUTO1]/[AUTO2]/[AUTO3] The camera adjusts sensitivity automatically according to subject brightness.

[6400] – [200] Sensitivity is set to the specified value, which is shown in the display.

**[H (51200)]/[H (25600)]/
[H (12800)]/[L (100)]** Extended settings for special situations. Note that these options may produce mottling or reduced dynamic range.

 **[L (100)]** is reset to ISO 200 and **[H (51200)]**, **[H (25600)]**, and **[H (12800)]** are reset to ISO 6400 when **[RAW]**, **[FINE+RAW]**, or **[NORMAL+RAW]** is selected for image quality.

[AUTO1]/[AUTO2]/[AUTO3]

The following options are available in **[AUTO1]/[AUTO2]/[AUTO3]** modes.

Option	Default
[DEFAULT SENSITIVITY]	200
[MAX. SENSITIVITY]	[AUTO1]: 800 [AUTO2]: 1600 [AUTO3]: 3200
[MIN. SHUTTER SPEED]	1/60

The camera automatically chooses a sensitivity between the default and maximum values. Sensitivity is only raised above the default value if the shutter speed required for optimal exposure would be slower than the value selected for **[MIN. SHUTTER SPEED]**.

 If the value selected for **[DEFAULT SENSITIVITY]** is higher than that selected for **[MAX. SENSITIVITY]**, **[DEFAULT SENSITIVITY]** will be set to the value selected for **[MAX. SENSITIVITY]**.

 The camera may select shutter speeds slower than **[MIN. SHUTTER SPEED]** if pictures would still be underexposed at the value selected for **[MAX. SENSITIVITY]**.

[IMAGE SIZE]

Choose the size and aspect ratio at which still pictures are recorded.

Option	Prints at sizes up to
L 3:2	34×25 cm (13.5×10 in.)
L 16:9	
L 1:1	
M 3:2	24×18 cm (9.5×7 in.)
M 16:9	
M 1:1	
S 3:2	17×13 cm (7×5 in.)
S 16:9	
S 1:1	



 The shape of the frame varies with the aspect ratio. Choose an aspect ratio according to your subject.



[IMAGE QUALITY]

Choose a file format and compression ratio. Select **[FINE]** or **[NORMAL]** to record JPEG images, **[RAW]** to record RAW images, or **[FINE+RAW]** or **[NORMAL+RAW]** to record both JPEG and RAW images. **[FINE]** and **[FINE+RAW]** use lower JPEG compression ratios for higher-quality JPEG images, while **[NORMAL]** and **[NORMAL+RAW]** use higher JPEG compression ratios to increase the number of images that can be stored.

[DYNAMIC RANGE]

Control contrast. Higher values are recommended for scenes that include both sunlight and deep shade or for increased contrast with such subjects as sunlight on water, brightly-lit autumn leaves, portraits taken against a blue sky, and white objects or people wearing white; note, however, that mottling may appear in pictures taken at higher values. If **[AUTO]** is selected, the camera will automatically select values between 100% and 200% in response to shooting conditions.

Option		Description
[AUTO]	 [100%]	Increase contrast when shooting indoors or under overcast skies.
	 [200%]	▲ ▼
	 [400%]	Reduce loss of detail in highlights and shadows when photographing high-contrast scenes.

-  If **[AUTO]** is selected, shutter speed and aperture will be displayed when the shutter button is pressed halfway.
-  **[200%]** is available at sensitivities of ISO 400 and above, **[400%]** at sensitivities of ISO 800 and above.

[FILM SIMULATION]

Simulate the effects of different types of film, including sepia and black-and-white.

- STD
[PROVIA/STANDARD] Standard color reproduction. Suited to a wide range of subjects, from portraits to landscapes.
- V
[Velvia/VIVID] A high-contrast palette of saturated colors, suited to nature photographs.
- S
[ASTIA/SOFT] A soft-toned palette of less saturated colors.
- C
[CLASSIC CHROME] Soft color and enhanced shadow contrast for a calm look.
- NR
[PRO Neg. Hi] Offers slightly more contrast than NE (PRO Neg. Std). Recommended for outdoor portrait photography.
- NE
[PRO Neg. Std] A soft-toned palette. The range of hues available for skin tones is enhanced, making this a good choice for studio portrait photography.
- B
[MONOCHROME] Take pictures in black and white.
- Bv
[MONOCHROME+Ye FILTER] Take black-and-white pictures with slightly increased contrast. This setting also slightly tones down the brightness of the sky.
- BR
[MONOCHROME+R FILTER] Take black-and-white pictures with increased contrast. This setting also tones down the brightness of the sky.
- Bg
[MONOCHROME+G FILTER] Soften skin tones in black-and-white portraits.
- SEPIA
[SEPIA] Take pictures in sepia.

[FILM SIMULATION BKT]

Choose film types for film simulation bracketing.

ND [ND FILTER]

Selecting **[ON]** enables the camera's built-in Neutral Density (ND) filter, reducing exposure by the equivalent of 3 EV. This allows slower shutter speeds or wider apertures to be used with brightly lit subjects, making it possible to blur motion or soften background details without risk of overexposure.

Color [COLOR]

Adjust color density.

[SHARPNESS]

Sharpen or soften outlines.

[HIGHLIGHT TONE]

Adjust the appearance of highlights.

[SHADOW TONE]

Adjust the appearance of shadows.

NR [NOISE REDUCTION]

Reduce noise in pictures taken at high sensitivities.

[LONG EXPOSURE NR]

Select **[ON]** to reduce mottling in long time-exposures.

WB [WHITE BALANCE]

Adjust colors to match the light source.

1. Select **[WHITE BALANCE]** in the shooting menu.

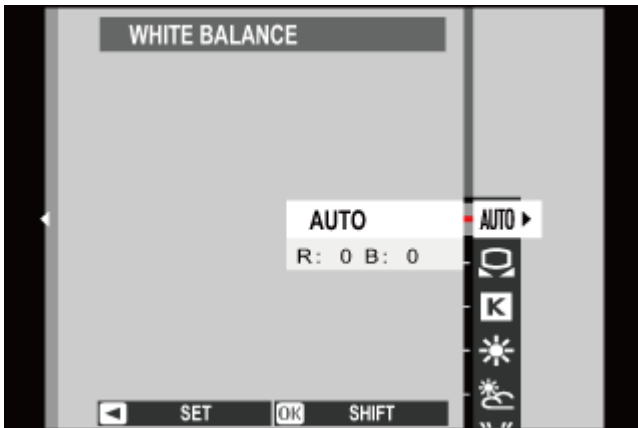

2. Press the selector up or down to highlight the desired option.

AUTO White balance adjusted automatically.



Measure a value for white balance.



Choose a color temperature.



For subjects in direct sunlight.



For subjects in the shade.



Use under "daylight" fluorescent lights.



Use under "warm white" fluorescent lights.



Use under "cool white" fluorescent lights.





Use under incandescent lighting.

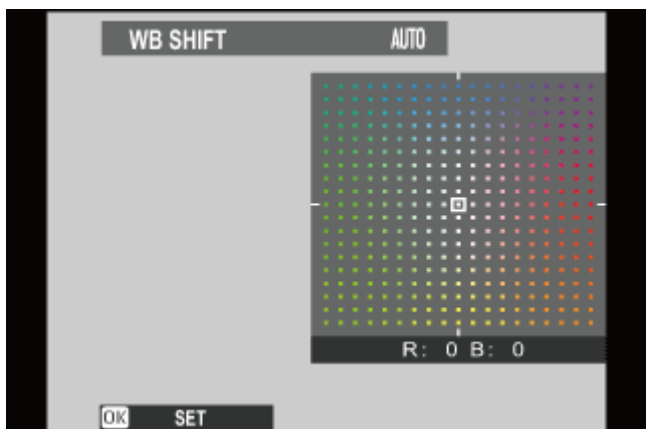

Reduces the blue cast typically associated with underwater lighting.

3. Press **[MENU/OK]**. The dialog shown below will be displayed; use the selector to fine-tune white balance and press **[MENU/OK]** to select, or press **[DISP/BACK]** to exit without fine-tuning.



 Results vary with shooting conditions. Play pictures back after shooting to check colors.

-  Custom White Balance
-  Color Temperature

Custom White Balance

Choose  to adjust white balance for unusual lighting conditions. White balance measurement options will be displayed; frame a white object so that it fills the display and press the shutter button all the way down to measure white balance (to select the most recent custom value and exit without measuring white balance, press **[DISP/BACK]**, or press **[MENU/OK]** to select the most recent value and display the fine-tuning dialog).

- If **“COMPLETED!”** is displayed, press **[MENU/OK]** to set white balance to the measured value.
- If **“UNDER”** is displayed, raise exposure compensation and try again.
- If **“OVER”** is displayed, lower exposure compensation and try again.

Color Temperature

Color temperature is an objective measure of the color of a light source, expressed in Kelvin (K). Light sources with a color temperature close to that of direct sunlight appear white; light sources with a lower color temperature have a yellow or red cast, while those with a higher color temperature are tinged with blue. You can match color temperature to the light source as shown in the following table, or choose options that differ sharply from the color of the light source to make pictures “warmer” or “colder”.



[SELECT CUSTOM SETTING]

Recall settings saved with [EDIT/SAVE CUSTOM SETTING].

See Also

 [\[EDIT/SAVE CUSTOM SETTING\]](#) (Shooting Menu)

[EDIT/SAVE CUSTOM SETTING]

Save custom camera settings for commonly-encountered situations.

1. Select **[EDIT/SAVE CUSTOM SETTING]** in the shooting menu.
2. Highlight a custom settings bank and press **[MENU/OK]** to select.



3. Adjust the following settings as desired.

- **[ISO]**
- **[DYNAMIC RANGE]**
- **[FILM SIMULATION]**
- **[WHITE BALANCE]**
- **[COLOR]**
- **[SHARPNESS]**
- **[HIGHLIGHT TONE]**
- **[SHADOW TONE]**
- **[NOISE REDUCTION]**

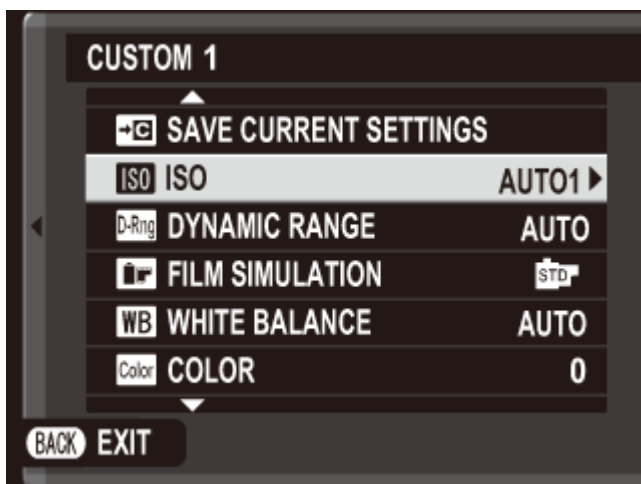

 To replace the settings in the current bank with the settings currently selected with the camera, highlight **[SAVE CURRENT SETTINGS]** and press **[MENU/OK]**.

4. Press **[DISP/BACK]**. A confirmation dialog will be displayed; highlight **[OK]** and press **[MENU/OK]**.

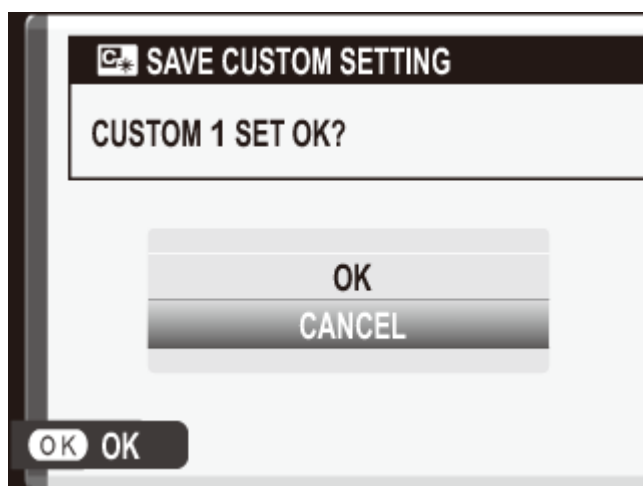

 Settings can be recalled using the **[SELECT CUSTOM SETTING]** option in the shooting menu.

See Also

- ➔ [\[SELECT CUSTOM SETTING\]](#) (The Shooting Menu)

Fn [FUNCTION (Fn) SETTING]

Choose the roles played by the **[Fn]** buttons.

1. Display the shooting menu and select **[FUNCTION (Fn) SETTING]**.
2. Press the selector up or down to highlight the desired button and press **[MENU/OK]** to select. You will be given the following choice of functions to assign to the selected button.

<ul style="list-style-type: none"> ▪ [ADVANCED FILTER] ▪ [MULTIPLE EXPOSURE] ▪ [MACRO] ▪ [PREVIEW DEPTH OF FIELD] ▪ [ISO] ▪ [SELF-TIMER] ▪ [IMAGE SIZE] ▪ [IMAGE QUALITY] ▪ [DYNAMIC RANGE] ▪ [FILM SIMULATION] ▪ [WHITE BALANCE] ▪ [ND FILTER] ▪ [PHOTOMETRY] ▪ [AF MODE] 	<ul style="list-style-type: none"> ▪ [FOCUS AREA] ▪ [CORRECTED AF FRAME] ▪ [FLASH MODE] ▪ [FLASH COMPENSATION] ▪ [SELECT CUSTOM SETTING] ▪ [MOVIE] ▪ [FACE DETECTION] ▪ [PREVIEW PIC. EFFECT] ▪ [HIGH PERFORMANCE] ▪ [RAW] ▪ [WIRELESS COMMUNICATION] ▪ [CONVERSION LENS] ▪ [SHUTTER TYPE]
--	--

 Select **[NONE]** to assign no function to the selected button.

3. Highlight the desired function and press **[MENU/OK]** to assign it to the selected button.

See Also

-  [The Function Buttons \(\[Fn\] \(Function\) Buttons\)](#)

[DISP. CUSTOM SETTING]

Choose the information displayed in the optical viewfinder or in the electronic viewfinder and LCD monitor.

1. Select **[DISP. CUSTOM SETTING]** in the shooting menu.
2. Highlight **[OVF]** or **[EVF/LCD]** and press **[MENU/OK]**.
3. Highlight items and press **[MENU/OK]** to select or deselect. Selected items are indicated by a check mark.

- | | |
|----------------------------------|---------------------------------------|
| ▪ [FRAMING GUIDELINE] | ▪ [FLASH] |
| ▪ [ELECTRONIC LEVEL] | ▪ [WHITE BALANCE] |
| ▪ [AF DISTANCE INDICATOR] | ▪ [FILM SIMULATION] |
| ▪ [MF DISTANCE INDICATOR] | ▪ [DYNAMIC RANGE] |
| ▪ [HISTOGRAM] | ▪ [FRAMES REMAINING] |
| ▪ [APERTURE/S-SPEED/ISO] | ▪ [IMAGE SIZE/QUALITY] |
| ▪ [EXP. COMPENSATION] | ▪ [MOVIE MODE & REC. TIME] |
| ▪ [PHOTOMETRY] | ▪ [BATTERY LEVEL] |

4. Press **[DISP/BACK]** to exit when settings are complete.

[CONVERSION LENS]

Adjust settings for optional conversion lenses.

WIDE Choose when using an optional WCL-X100 conversion lens.

TELE Choose when using an optional TCL-X100 conversion lens.

OFF Choose when no conversion lens is attached.

 [Attach The Conversion Lens](#)

 [Using a Wide Conversion Lens](#)

Attach The Conversion Lens

1. Remove the front ring.

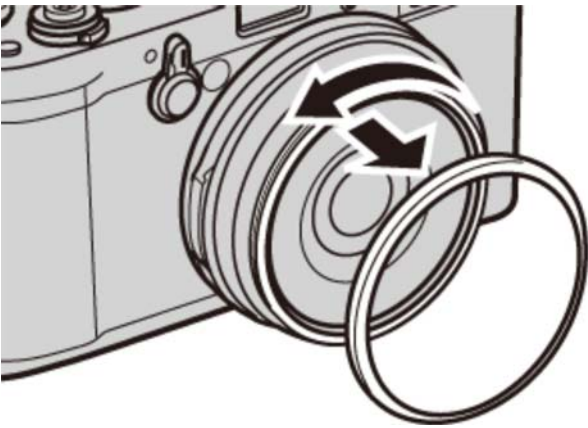

 If you have trouble removing the front ring, grip the entire ring and rotate it as shown.

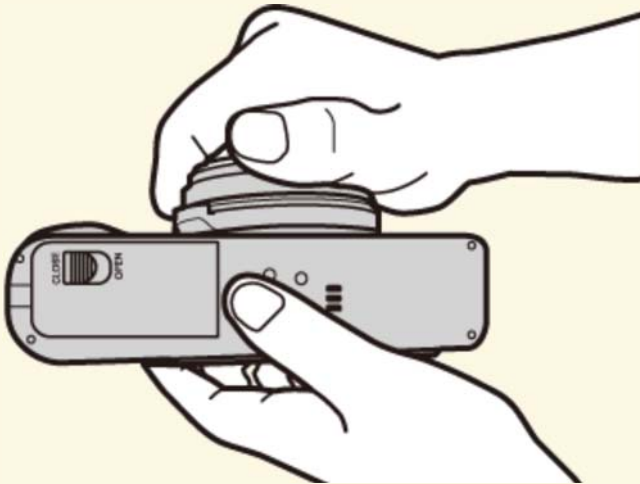

2. Attach the conversion lens.

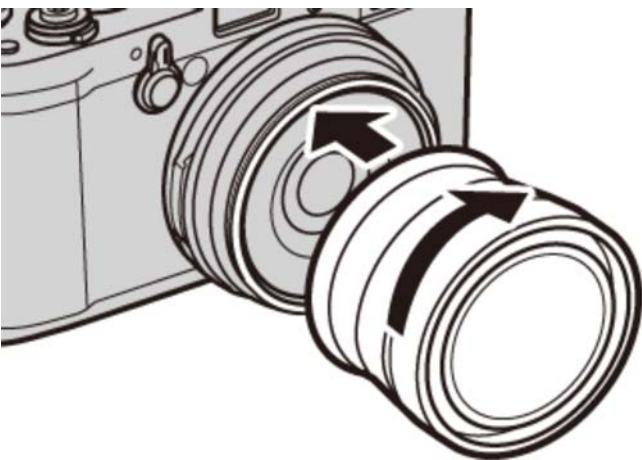

 Keep the front ring and lens cap in a safe place when not in use.

Using a Wide Conversion Lens

When using an optional WCL-X100 wide conversion lens, select **[WIDE]** for **[CONVERSION LENS]**. An icon will be displayed.

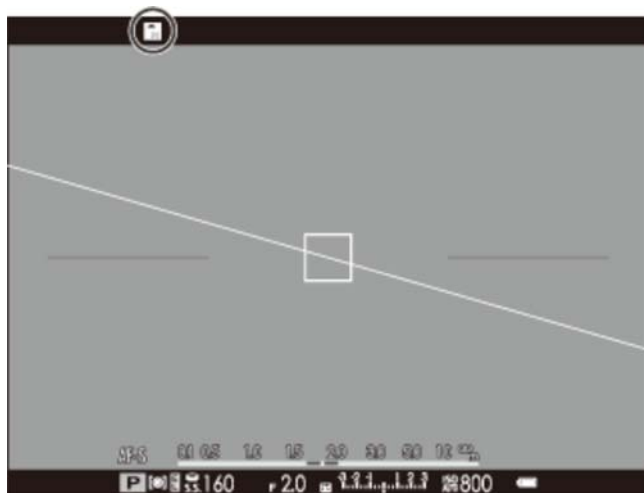

Because the optical viewfinder does not cover the full field of view of the conversion lens, the bright frame is replaced by brackets showing approximately 80% of the field of view. For accurate framing, compose pictures using the electronic viewfinder or LCD monitor.

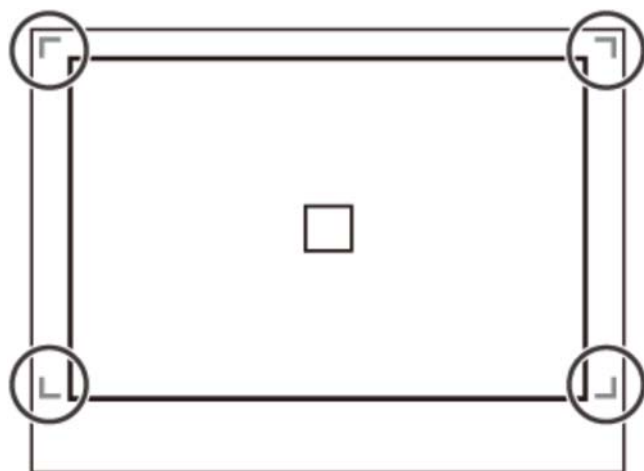

 The built-in flash may fail to light the entire subject. We recommend using an optional external flash designated for use with this camera.

[MF ASSIST]

Choose how focus is displayed in manual focus mode.

[STANDARD] Focus is displayed normally (focus peaking and digital split image are not available).

[DIGITAL SPLIT IMAGE] A black-and-white split-image display.

[FOCUS PEAK HIGHLIGHT] The camera heightens high-contrast outlines. Choose a color and peaking level.

See Also

➔ [Manual Focus \(Focus Mode M\)](#) (More on Photography)

[ADVANCED FILTER]

Take photos with filter effects.

 **[TOY CAMERA]** Choose for a retro toy camera effect.

 **[MINIATURE]** The tops and bottoms of pictures are blurred for a diorama effect.

 **[POP COLOR]** Create high-contrast images with saturated colors.

 **[HIGH-KEY]** Create bright, low-contrast images.

 **[LOW-KEY]** Create uniformly dark tones with few areas of emphasized highlights.

 **[DYNAMIC TONE]** Dynamic tone expression is used for a fantasy effect.

 **[SOFT FOCUS]** Create a look that is evenly soft throughout the whole image.

 **[PARTIAL COLOR (RED)]** Reds are recorded in color, while other colors are recorded in black and white.

 **[PARTIAL COLOR (ORANGE)]** Orange objects are recorded in color, while other colors are recorded in black and white.

 **[PARTIAL COLOR (YELLOW)]** Yellows are recorded in color, while other colors are recorded in black and white.

 **[PARTIAL COLOR (GREEN)]** Greens are recorded in color, while other colors are recorded in black and white.

 **[PARTIAL COLOR (BLUE)]** Blues are recorded in color, while other colors are recorded in black and white.

 **[PARTIAL COLOR (PURPLE)]** Purples are recorded in color, while other colors are recorded in black and white.

[OFF] Advanced filters off.

 Depending on the subject and camera settings, images may in some cases be grainy or vary in brightness and hue.

 Selecting an advanced filter sets the **[SCREEN SET-UP] > [IMAGE DISP.]** option in the setup menu to **[0.5 SEC]**.

[INTERVAL TIMER SHOOTING]

Adjust settings for interval timer photography.

1. Select **[INTERVAL TIMER SHOOTING]** in the shooting menu to display interval timer shooting options.

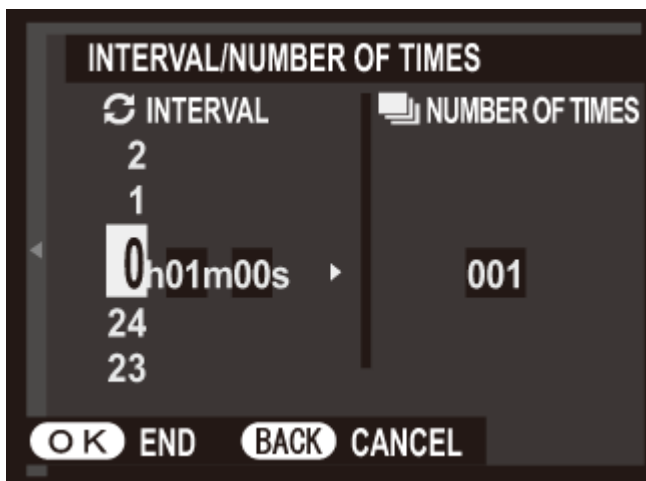

2. Use the selector to choose the interval and number of shots. Press **[MENU/OK]** to proceed.

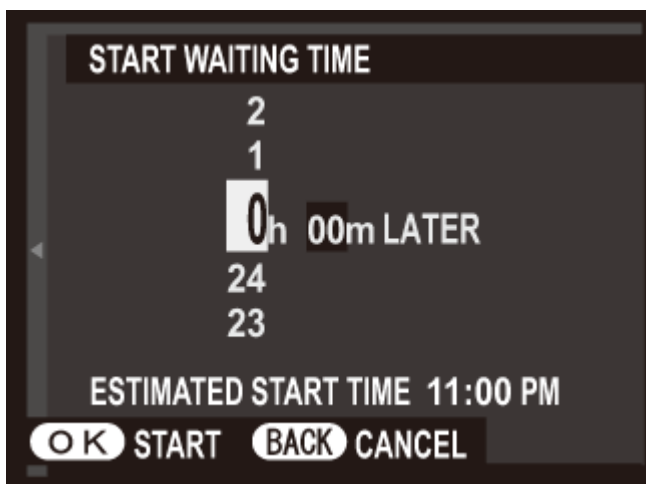

3. Use the selector to choose the starting time and then press **[MENU/OK]**. Shooting will start automatically.

 Interval timer photography can not be used during panorama or multiple exposure photography. In burst mode, only one picture will be taken each time the shutter is released.

- ✎ Use of a tripod is recommended.
- ✎ Check the battery level before starting.
- ✎ The display turns off between shots and lights a few seconds before the next shot is taken. The display can be activated at any time by pressing the shutter button all the way down.

[SELF-TIMER]

Use the timer for self-portraits or to prevent blur caused by camera shake.

 The shutter is released two seconds after the shutter button is pressed. Use to reduce blur caused by the camera moving when the shutter button is pressed. The self-timer lamp will blink as the timer counts down.

 The shutter is released ten seconds after the shutter button is pressed. Use for self-portraits. The self-timer lamp on the front of the camera lights when the timer starts and begins to blink shortly before the photo is taken.

OFF Self-timer off.

AE-L [AE/AF-LOCK MODE]

If **[AE&AF ON WHEN PRESSING]** is selected, exposure and/or focus will lock while the **[AEL/AFL]** button is pressed. If **[AE&AF ON/OFF SWITCH]** is selected, exposure and/or focus will lock while the **[AEL/AFL]** button is pressed and remain locked until the button is pressed again.

[AE/AF-LOCK BUTTON]

Choose whether the **[AEL/AFL]** button locks exposure (AE), focus (AF), or both.

[AE LOCK ONLY] The **[AEL/AFL]** button locks exposure only.

[AF LOCK ONLY] The **[AEL/AFL]** button locks focus only.

[AE/AF LOCK] The **[AEL/AFL]** button locks both exposure and focus.

[PHOTOMETRY]

Choose how the camera measures the brightness of the subject.

 **[MULTI]** Automatic scene recognition is used to adjust exposure for a wide range of shooting conditions.

 **[SPOT]** The camera meters lighting conditions in the selected focus area or at the center of the frame. Recommended when the background is much brighter or darker than the main subject.

 If **[INTERLOCK SPOT AE & FOCUS AREA]** is **[ON]** and **[AREA]** is selected for **[AUTOFOCUS SETTING] > [AF MODE]**, the camera will meter lighting conditions in the selected focus area. If **[INTERLOCK SPOT AE & FOCUS AREA]** is **[OFF]**, the camera will meter the center focus area.

 **[AVERAGE]** Exposure is set to the average for the entire frame. Provides consistent exposure across multiple shots with the same lighting, and is particularly effective for landscapes and portraits of subjects dressed in black or white.

[INTERLOCK SPOT AE & FOCUS AREA]



Select **[ON]** to meter the current focus frame when **[AREA]** is selected for **[AUTOFOCUS SETTING]** > **[AF MODE]** and **[SPOT]** is selected for **[PHOTOMETRY]**.

See Also

- ➔ [\[PHOTOMETRY\]](#) (The Shooting Menu)
- ➔ [\[AUTOFOCUS SETTING\]](#) (The Shooting Menu)

[RED EYE REMOVAL]

Choose **[ON]** to remove red-eye effects caused by the flash when shooting with Intelligent Face Detection.





-  Red-eye reduction is performed only when a face is detected.
-  Red-eye removal is not available with RAW images.





[SAVE ORG IMAGE]

Choose **[ON]** to save unprocessed copies of pictures taken using **[RED EYE REMOVAL]**.

[FLASH MODE]



Choose a flash mode.

- [AUTO]**
The flash fires when required. Recommended in most situations.
-  **[FORCED FLASH]**
The flash fires whenever a picture is taken. Use for backlit subjects or for natural coloration when shooting in bright light.
-  **[SLOW SYNCHRO]**
Capture both the main subject and the background under low light (note that brightly lit scenes may be overexposed).
-  **[COMMANDER]**
A flash mounted on the hot shoe can be used to control optional remote flash units.
-  **[EXTERNAL FLASH]**
Select when using optional third-party flash units.
-  **[SUPPRESSED FLASH]**
The flash does not fire even when the subject is poorly lit. A tripod is recommended.

-  If  is displayed when the shutter button is pressed halfway, the flash will fire when the photo is taken.
-  Except in commander mode, the flash may fire several times with each shot. Do not move the camera until shooting is complete.
-  The flash will synchronize with the shutter at shutter speeds of 1/2000 s or slower.
-  The camera can also be used with optional FUJIFILM shoe-mounted flash units.

-  The flash may need more time to charge when the battery is low.

Red-Eye Removal

When "intelligent face detection" is active, and on is selected for "red eye removal", red-eye removal is available in   .

Red-eye removal minimizes "*red-eye*" caused when light from the flash is reflected from the subject's retinas.

[FLASH COMPENSATION]

Adjust flash brightness.

 Note that the desired results may not be achieved depending on shooting conditions and the distance to the subject.

[SHUTTER TYPE]

Choose the shutter type. Choose the electronic shutter to mute the shutter sound.

MECHANICAL SHUTTER Take pictures with the mechanical shutter.

ELECTRONIC SHUTTER Take pictures with the electronic shutter.

MECHANICAL+ELECTRONIC The camera chooses the shutter type according to shooting conditions.

 If [**ELECTRONIC SHUTTER**] or [**MECHANICAL+ELECTRONIC**] is selected, shutter speeds faster than 1/4,000 s can be chosen by rotating the shutter speed dial to 4000 and then rotating the command dial.

 Regardless of the option selected, the mechanical shutter is used for motion panoramas. When the electronic shutter is used, the flash turns off, shutter speed and sensitivity are restricted to values of 1/32,000–1 s and ISO 6400–200 respectively, and long exposure noise reduction has no effect. In burst mode, focus and exposure are fixed at the values for the first shot in each burst.

 Distortion may be visible in shots of moving subjects taken with the electronic shutter, while banding and fog may occur in shots taken under fluorescent lights or other flickering or erratic illumination. When taking pictures with the shutter muted, respect your subjects' image rights and right to privacy.

[MOVIE SET-UP]

Adjust movie settings.

-  [MOVIE MODE]
-  [MOVIE ISO]
-  [MIC LEVEL ADJUSTMENT]
-  [MIC/REMOTE RELEASE]

[MOVIE MODE]

Choose a frame size and rate for movies.

[MOVIE ISO]

Choose the sensitivity for movie recording.

 [MOVIE ISO] does not affect the option selected for recording photographs.

[MIC LEVEL ADJUSTMENT]

Adjust the microphone recording level.

[MIC/REMOTE RELEASE]

Specify whether the device connected to the microphone/remote release connector is a microphone or a remote release.

[WIRELESS COMMUNICATION]

Connect to a smartphone or tablet over a wireless network.

See Also

- ➔ [Wireless Transfer](#) (Connections)
- ➔ [The FUJIFILM Smartphone/Tablet/Computer App](#) (opens in another window)

The Playback Menu

- ➔ Using the Playback Menu
- ➔ [RAW CONVERSION]
- ➔ [ERASE]
- ➔ [CROP]
- ➔ [RESIZE]
- ➔ [PROTECT]
- ➔ [IMAGE ROTATE]
- ➔ [RED EYE REMOVAL]
- ➔ [SLIDE SHOW]
- ➔ [PHOTOBOOK ASSIST]
- ➔ [MARK FOR UPLOAD TO]
- ➔ [IMAGE SEARCH]
- ➔ [COPY]
- ➔ [PRINT ORDER (DPOF)]
- ➔ [instax PRINTER PRINT]
- ➔ [DISP ASPECT]
- ➔ [WIRELESS COMMUNICATION]
- ➔ [PC AUTO SAVE]

Using the Playback Menu

1. Press the  button to enter playback mode.
2. Press **[MENU/OK]** to display the playback menu.

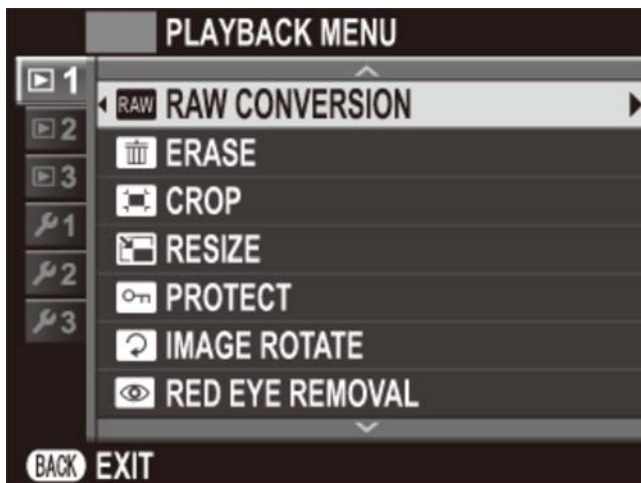

3. Press the selector up or down to highlight the desired menu item.
4. Press the selector right to display options for the highlighted item.
5. Press the selector up or down to highlight the desired option.
6. Press **[MENU/OK]** to select the highlighted option.
7. Press **[DISP/BACK]** to exit from the menu.

See Also

- ➔ [\[RAW CONVERSION\]](#)
- ➔ [\[ERASE\]](#)
- ➔ [\[CROP\]](#)
- ➔ [\[RESIZE\]](#)
- ➔ [\[PROTECT\]](#)
- ➔ [\[IMAGE ROTATE\]](#)
- ➔ [\[RED EYE REMOVAL\]](#)
- ➔ [\[SLIDE SHOW\]](#)
- ➔ [\[PHOTOBOOK ASSIST\]](#)
- ➔ [\[MARK FOR UPLOAD TO\]](#)
- ➔ [\[IMAGE SEARCH\]](#)
- ➔ [\[COPY\]](#)
- ➔ [\[PRINT ORDER \(DPOF\)\]](#)
- ➔ [\[instax PRINTER PRINT\]](#)
- ➔ [\[DISP ASPECT\]](#)
- ➔ [\[WIRELESS COMMUNICATION\]](#)
- ➔ [\[PC AUTO SAVE\]](#)

RAW [RAW CONVERSION]

Create JPEG copies of RAW pictures. The original image data are unaffected, allowing a single RAW image to be processed in a multitude of different ways.

1. Display the desired picture.
2. Highlight **[RAW CONVERSION]** in the playback menu and press **[MENU/OK]** to display RAW conversion options.

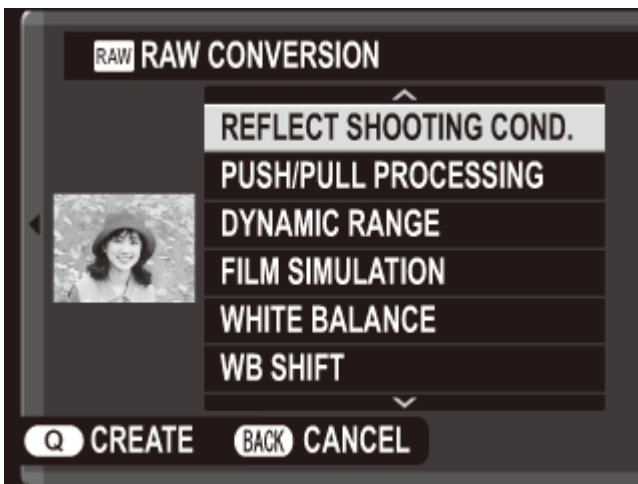

 These options can also be displayed by pressing the **[Q]** button during playback.

- 3.** Press the selector up or down to highlight a setting and press the selector right to select. Press the selector up or down to highlight the desired option and press **[MENU/OK]** to select and return to the settings list. Repeat this step to adjust additional settings.

[REFLECT SHOOTING COND.]	Create a JPEG copy using the settings in effect at the time the photo was taken.
[PUSH/PULL PROCESSING]	Adjust exposure by –1 EV to +1 EV in increments of 1/3 EV.
[DYNAMIC RANGE]	Enhance details in highlights for natural contrast.
[FILM SIMULATION]	Simulate the effects of different types of film.
[WHITE BALANCE]	Adjust white balance.
[WB SHIFT]	Fine-tune white balance.
[COLOR]	Adjust color density.
[SHARPNESS]	Sharpen or soften outlines.
[HIGHLIGHT TONE]	Adjust highlights.
[SHADOW TONE]	Adjust shadows.
[NOISE REDUCTION]	Process the copy to reduce mottling.
[COLOR SPACE]	Choose the color space used for color reproduction.

- 4.** Press the **[Q]** button to preview the JPEG copy and press **[MENU/OK]** to save.

[ERASE]

- ⬇ [FRAME]
- ⬇ [SELECTED FRAMES]
- ⬇ [ALL FRAMES]

[FRAME]

Delete pictures one at a time.

1. Select **[FRAME]** for **[ERASE]** in the playback menu.
2. Press the selector left or right to scroll through pictures and press **[MENU/OK]** to delete (a confirmation dialog is not displayed). Repeat to delete additional pictures.

[SELECTED FRAMES]

Delete multiple selected pictures.





1. Select **[SELECTED FRAMES]** for **[ERASE]** in the playback menu.
2. Highlight pictures and press **[MENU/OK]** to select or deselect (pictures in photobooks or print orders are shown by ).
3. When the operation is complete, press **[DISP/BACK]** to display a confirmation dialog.
4. Highlight **[OK]** and press **[MENU/OK]** to delete the selected pictures.

[ALL FRAMES]

Delete all unprotected pictures.

1. Select **[ALL FRAMES]** for **[ERASE]** in the playback menu.
2. A confirmation dialog will be displayed; highlight **[OK]** and press **[MENU/OK]** to delete all unprotected pictures. Pressing **[DISP/BACK]** cancels deletion; note that any pictures deleted before the button was pressed can not be recovered.

-  If a memory card is inserted, only the pictures on the memory card will be affected; the pictures in internal memory are only deleted if no memory card is inserted.
-  If a message appears stating that the selected images are part of a DPOF print order, press **[MENU/OK]** to delete the pictures.

[CROP]

Create a small copy of the current picture.

1. Display the desired picture.
2. Select **[CROP]** in the playback menu.
3. Use the selector and command dial to select the crop.
4. Press **[MENU/OK]** to display a confirmation dialog.
5. Press **[MENU/OK]** again to save the cropped copy to a separate file.

 Larger crops produce larger copies; all copies have an aspect ratio of 3 : 2. If the size of the final copy will be **640**, **[YES]** will be displayed in yellow.

Intelligent Face Detection

If the picture was shot with Intelligent Face Detection,  will be displayed in the monitor. Press the selector down to zoom in on the selected face.



[RESIZE]

Create a resized copy of the current picture.

1. Display the desired picture.
2. Select **[RESIZE]** in the playback menu.
3. Highlight a size and press **[MENU/OK]** to display a confirmation dialog.
4. Press **[MENU/OK]** again to save the resized copy to a separate file.

 The sizes available vary with the size of the original image.

 **[PROTECT]**

Protect pictures from accidental deletion. Highlight one of the following options and press **[MENU/OK]**.

[FRAME] Protect selected pictures. Press the selector left or right to view pictures and press **[MENU/OK]** to select or deselect. Press **[DISP/BACK]** when the operation is complete.

[SET ALL] Protect all pictures.



[RESET ALL] Remove protection from all pictures.

 Protected pictures will be deleted when the memory card is formatted.

[IMAGE ROTATE]

Rotate pictures.





1. Display the desired picture.
2. Select **[IMAGE ROTATE]** in the playback menu.
3. Press the selector down to rotate the picture 90° clockwise, up to rotate it 90° counterclockwise.
4. Press **[MENU/OK]**. The picture automatically be displayed in the selected orientation whenever it is played back on the camera.

-  Protected pictures can not be rotated. Remove protection before rotating pictures.
-  The camera may not be able to rotate pictures created with other devices. Pictures rotated on the camera will not be rotated when viewed on a computer or on other cameras.
-  Pictures taken with **[SCREEN SET-UP] > [AUTOROTATE PB]** are automatically displayed in the correct orientation during playback.

[RED EYE REMOVAL]

Remove red-eye from portraits. The camera will analyze the image; if red-eye is detected, the image will be processed to create a copy with reduced red-eye.



1. Display the desired picture.
2. Select **[RED EYE REMOVAL]** in the playback menu.
3. Press **[MENU/OK]**.

-  Red eye may not be removed if the camera is unable to detect a face or the face is in profile. Results may differ depending on the scene. Red eye can not be removed from pictures that have already been processed using red-eye removal or pictures created with other devices.
-  The amount of time needed to process the image varies with the number of faces detected.
-  Copies created with **[RED EYE REMOVAL]** are indicated by a  icon during playback.
-  Red eye removal can not be performed on RAW images.

[SLIDE SHOW]

View pictures in an automated slide show. Choose the type of show and press **[MENU/OK]** to start. Press **[DISP/BACK]** at any time during the show to view on-screen help. The show can be ended at any time by pressing **[MENU/OK]**.

[NORMAL]/[FADE-IN] Press the selector left or right to go back or skip ahead one frame. Select **[FADE-IN]** for fade transitions between frames.

[NORMAL]  **[FADE-IN]**  As above, except that camera automatically zooms in on faces.

[MULTIPLE] Display several pictures at once.

 The camera will not turn off automatically while a slide show is in progress.

[PHOTOBOOK ASSIST]

Create books from your favorite photos.

- ⌵ [Creating a PhotoBook](#)
- ⌵ [Viewing Photobook](#)
- ⌵ [Editing and Deleting Photobooks](#)

Creating a PhotoBook

1. Select **[NEW BOOK]** for **[PHOTOBOOK ASSIST]** in the playback menu and choose from the following options:

[SELECT FROM ALL] Choose from all available pictures.

[SELECT BY IMAGE SEARCH] Choose from pictures matching selected search conditions.

 Neither photographs **640** or smaller nor movies can be selected for photobooks.

2. Scroll through the images and press the selector up to select or deselect. To display the current image on the cover, press the selector down. Press **[MENU/OK]** to exit when the book is complete.

 The first picture selected becomes the cover image. Press the selector down to select a different image for the cover.

3. Highlight **[COMPLETE PHOTOBOOK]** and press **[MENU/OK]** (to select all photos or all photos matching the specified search conditions for the book, choose **[SELECT ALL]**). The new book will be added to the list in the photobook assist menu.

- ⚠ Books can contain up to 300 pictures.
- ⚠ Books that contain no photos are automatically deleted.



Photobooks

Photobooks can be copied to a computer using the supplied MyFinePix Studio software.

See Also

➔ [MyFinePix Studio](#) (opens in another window)

Viewing Photobooks

Highlight a book in the photobook assist menu and press **[MENU/OK]** to display the book, then press the selector left or right to scroll through the pictures.

Editing and Deleting Photobooks

Display the photobook and press **MENU/OK**. The following options will be displayed; select the desired option and follow the on-screen instructions.





[EDIT] Edit the book as described in "Creating a PhotoBook".

[ERASE] Delete the book.

[MARK FOR UPLOAD TO]

Select pictures for upload to YouTube, Facebook or MyFinePix.com using MyFinePix Studio (Windows only).

1. Select **[YouTube]** to choose movies for upload to YouTube, **[Facebook]** to choose photos and movies for upload to Facebook, or **[MyFinePix.com]** to choose photos for upload to MyFinePix.com.
2. Press the selector left or right to display pictures and press **[MENU/OK]** to select or deselect. Press **[DISP/BACK]** to exit when all the desired pictures are selected.

-  Only movies can be selected for upload to YouTube.
-  Only photos can be selected for upload to MyFinePix.com.
-  During playback, selected pictures are indicated by **[YouTube]**, **[Facebook]** or **[MyFinepix.com]** icons.
-  Choose **[RESET ALL]** to deselect all pictures. If the number of pictures affected is very large, some time may be required to complete the operation. Press **[DISP/BACK]** to exit before the operation is complete.

Uploading Pictures (Windows Only)

Selected pictures can be uploaded using the **[YouTube/Facebook/MyFinePix.com Upload]** option in MyFinePix Studio.

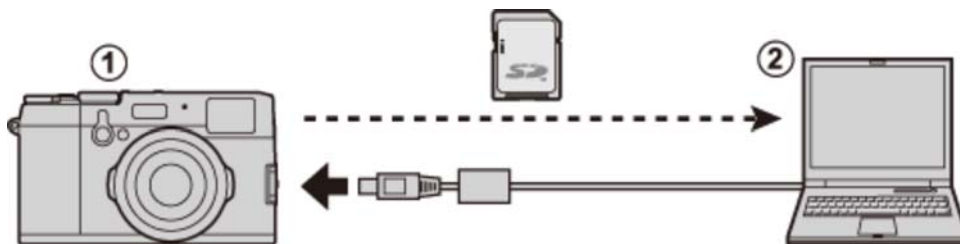

- ① Select with camera
- ② Upload from computer

See Also

-  [MyFinePix Studio](#) (opens in another window)

[IMAGE SEARCH]

Search for images by various criteria.

1. Select **[IMAGE SEARCH]** in the playback menu, highlight one of the following search criteria, and press **[MENU/OK]**:

[BY DATE] Find all pictures taken on a selected date.

[BY FACE] Find all pictures based on specified face information.

[BY FAVORITES] Find all pictures with a specified rating.

[BY TYPE OF DATA] Find all still pictures, all movies, or all RAW pictures.

[BY UPLOAD MARK] Find all pictures selected for upload to a specified destination.

2. Select a search condition. Only pictures that match the search condition will be displayed. To delete or protect selected pictures or to view the selected pictures in a slide show, press **[MENU/OK]** and choose from the following options:

- **[ERASE]**

- **[PROTECT]**

- **[SLIDE SHOW]**

COPY [COPY]

Copy pictures from internal memory to a memory card.

1. Select **[COPY]** in the playback menu.
2. Highlight one of the following options and press the selector right:

IN [INTERNAL MEMORY] → **SD** [CARD]

Copy pictures from internal memory to a memory card.

SD [CARD] → **IN** [INTERNAL MEMORY]

Copy pictures from a memory card to internal memory.

3. Highlight one of the following options and press **[MENU/OK]**:

[FRAME] Copy selected pictures. Press the selector left or right to view pictures and press **[MENU/OK]** to copy the current picture.

[ALL FRAMES] Copy all pictures.

❗ Copying ends when the destination is full.

❗ DPOF print information is not copied.

[PRINT ORDER (DPOF)]

The **[PRINT ORDER (DPOF)]** option in the playback menu can be used to create a digital “print order” for PictBridge-compatible printers or devices that support DPOF.

 DPOF

DPOF (Digital Print Order Format) is standard that allows pictures to be printed from “print orders” stored on the memory card. The information in the order includes the pictures to be printed and the number of copies of each picture.



⬇ [WITH DATE]/[WITHOUT DATE]

⬆ [RESET ALL]

[WITH DATE]/[WITHOUT DATE]

To modify the DPOF print order, select **[PRINT ORDER (DPOF)]** in the playback menu and press the selector up or down to highlight **[WITH DATE]** or **[WITHOUT DATE]**.

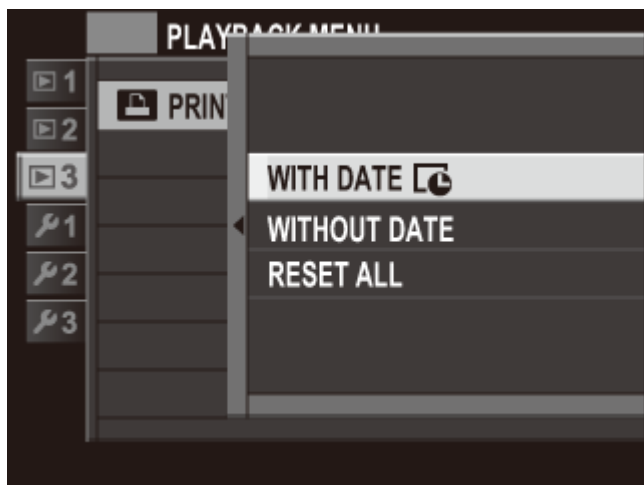



[WITH DATE] Print date of recording on pictures.

[WITHOUT DATE] Print pictures without date.

Press **[MENU/OK]** and follow the steps below.

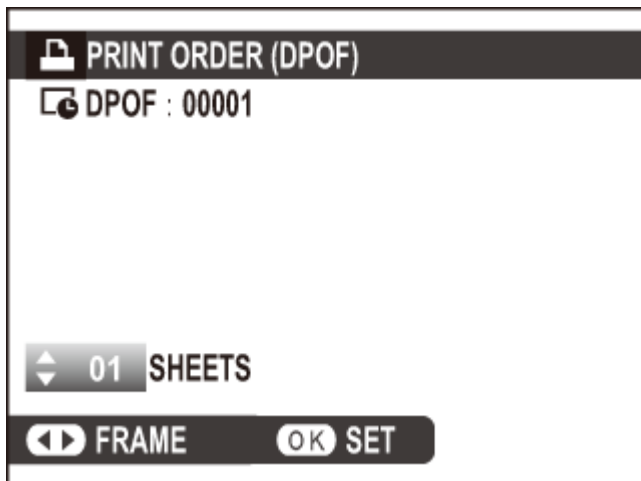
1. Press the selector left or right to display a picture you wish to include in or remove from the print order.
2. Press the selector up or down to choose the number of copies (up to 99). To remove a picture from the order, press the selector down until the number of copies is 0.



3. Repeat steps 1–2 to complete the print order. Press **[MENU/OK]** to save the print order when settings are complete, or **[DISP/BACK]** to exit without changing the print order.
4. The total number of prints is displayed in the monitor. Press **[MENU/OK]** to exit.
The pictures in the current print order are indicated by  icon during playback.

[RESET ALL]

To cancel the current print order, select **[RESET ALL]** for **[PRINT ORDER (DPOF)]**. The confirmation shown below will be displayed; press **[MENU/OK]** to remove all pictures from the order.

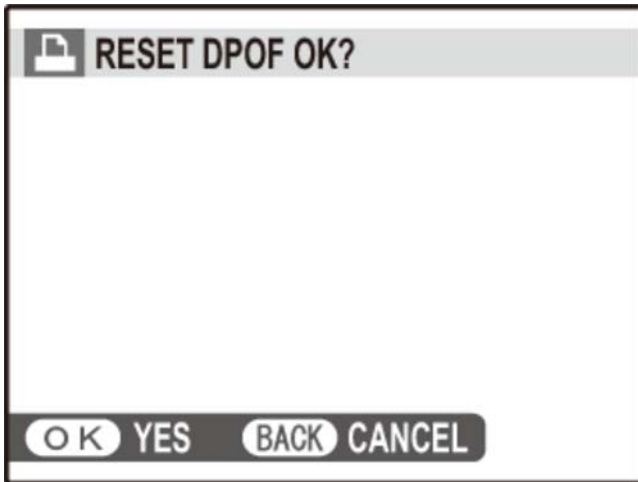

- ✎ Print orders can contain a maximum of 999 pictures.
- ✎ If a memory card is inserted containing a print order created by another camera, the message shown below will be displayed. Pressing **[MENU/OK]** cancels the print order; a new print order must be created as described above.

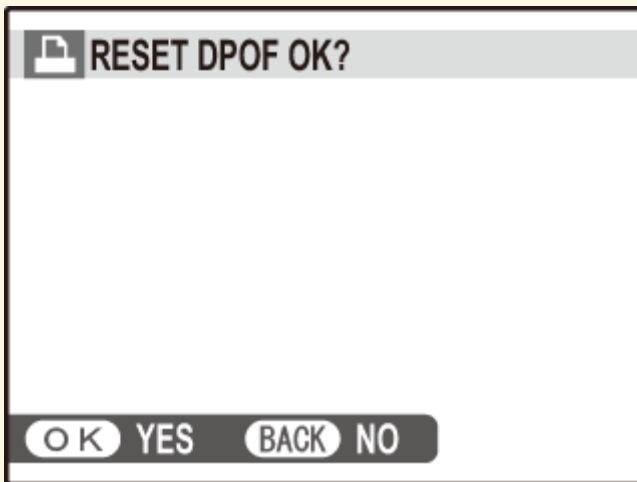

[instax PRINTER PRINT]

Print pictures on optional FUJIFILM instax SHARE printers. See the printer manual for details.

See Also

 [Printer manual \(PDF: !\[\]\(bbb3388d591ef640dd8a8c4262f2866a_img.jpg\)](#))

[DISP ASPECT]

Choose how High Definition (HD) devices display pictures with an aspect ratio of 3 : 2 (this option is available only when an HDMI cable is connected).

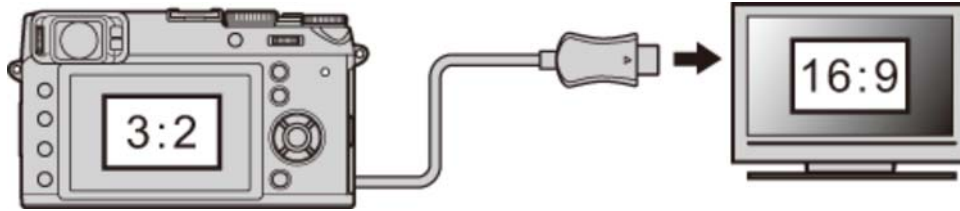

16 : 9



3 : 2



 Select 16 : 9 to display the image so that it fills the screen with its top and bottom cropped out, 3 : 2 to display the entire image with black bands at either side.

[WIRELESS COMMUNICATION]

Connect to a smartphone or tablet over a wireless network.

See Also

-  [The FUJIFILM Smartphone/Tablet/Computer App](#) (opens in another window)

[PC AUTO SAVE]

Upload pictures to a computer over a wireless network.

See Also

-  [The FUJIFILM Smartphone/Tablet/Computer App](#) (opens in another window)

The Setup Menu

- Using the Setup Menu
- Factory Defaults—Setup Menu
- [DATE/TIME]
- [TIME DIFFERENCE]
- [言語/LANG.]
- [RESET]
- [SILENT MODE]
- [FRAME NO.]
- [FOCUS RING]
- [FOCUS CHECK]
- [SOUND SET-UP]
- [SCREEN SET-UP]
- [SELECTOR BUTTON SETTING]
- [EDIT/SAVE QUICK MENU]
- [POWER MANAGEMENT]
- [SHUTTER COUNT]
- [EDIT FILE NAME]
- [WIRELESS SETTINGS]
- [PC AUTO SAVE SETTING]
- [GEOTAGGING SET-UP]
- [instax PRINTER CONNECTION SETTING]
- [COLOR SPACE]
- [FORMAT]

Using the Setup Menu

1. Display the setup menu.

- i. Press **[MENU/OK]** to display the menu for the current mode.
- ii. Press the selector left to highlight the tab for the current menu.



- iii. Press the selector down to highlight the setup menu tab containing the desired option.



- iv. Press the selector right to place the cursor in the setup menu.

2. Adjust settings.

- i. Press the selector up or down to highlight a menu item.

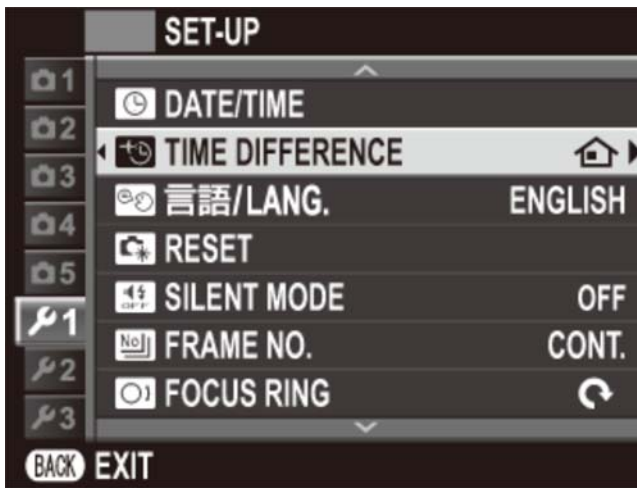

- ii. Press the selector right to display options for the highlighted item.

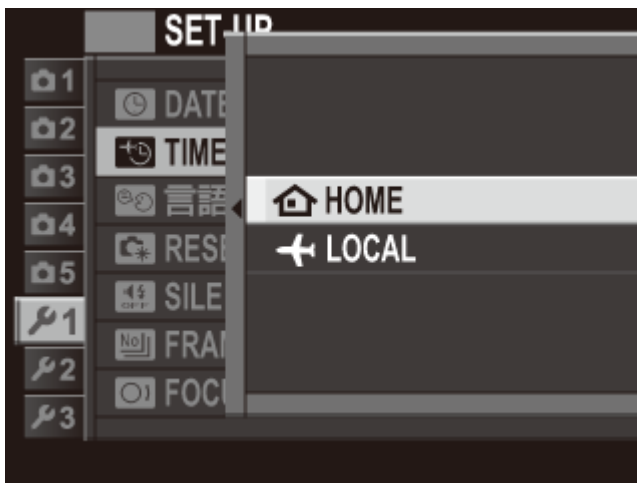

- iii. Press the selector up or down to highlight an option.
- iv. Press **[MENU/OK]** to select the highlighted option.
- v. Press **[DISP/BACK]** to exit from the menu.

See Also

- ➔ [DATE/TIME]
- ➔ [TIME DIFFERENCE]
- ➔ [言語/LANG.]
- ➔ [RESET]
- ➔ [SILENT MODE]
- ➔ [FRAME NO.]
- ➔ [FOCUS RING]
- ➔ [FOCUS CHECK]
- ➔ [SOUND SET-UP]
- ➔ [SCREEN SET-UP]
- ➔ [SELECTOR BUTTON SETTING]
- ➔ [EDIT/SAVE QUICK MENU]
- ➔ [POWER MANAGEMENT]
- ➔ [SHUTTER COUNT]
- ➔ [EDIT FILE NAME]
- ➔ [WIRELESS SETTINGS]
- ➔ [PC AUTO SAVE SETTING]
- ➔ [GEOTAGGING SET-UP]
- ➔ [instax PRINTER CONNECTION SETTING]
- ➔ [COLOR SPACE]
- ➔ [FORMAT]

Factory Defaults—Setup Menu

The factory default settings for the options in the setup menus are listed below.

 These settings can be restored using the **[RESET]** > **[SET-UP RESET]** option in the setup menu.

[SILENT MODE]	[OFF]
[FRAME NO.]	[CONTINUOUS]
[FOCUS RING]	[CW]
[FOCUS CHECK]	[OFF]
[SOUND SET-UP]	
[OPERATION VOL.]	
[SHUTTER VOLUME]	
[SHUTTER SOUND]	[SOUND 1]
[PLAYBACK VOLUME]	[7]
[SCREEN SET-UP]	
[IMAGE DISP.]	[OFF]
[EVF AUTOROTATE DISPLAYS]	[ON]
[PREVIEW EXP. IN MANUAL MODE]	[ON]
[MONITOR SUNLIGHT MODE]	[OFF]
[EVF BRIGHTNESS]	[AUTO]
[EVF COLOR]	[0]
[LCD BRIGHTNESS]	[0]
[LCD COLOR]	[0]
[PREVIEW PIC. EFFECT]	[ON]
[FRAMING GUIDELINE]	[GRID 9]
[AUTOROTATE PB]	[ON]

[FOCUS SCALE UNITS]	[METERS]
[SELECTOR BUTTON SETTING]	[Fn BUTTON]
[EDIT/SAVE QUICK MENU]	
[Q1]	[SELECT CUSTOM SETTING]
[Q2]	[ISO]
[Q3]	[DYNAMIC RANGE]
[Q4]	[WHITE BALANCE]
[Q5]	[NOISE REDUCTION]
[Q6]	[IMAGE SIZE]
[Q7]	[IMAGE QUALITY]
[Q8]	[FILM SIMULATION]
[Q9]	[HIGHLIGHT TONE]
[Q10]	[SHADOW TONE]
[Q11]	[COLOR]
[Q12]	[SHARPNESS]
[Q13]	[SELF-TIMER]
[Q14]	[AF MODE]
[Q15]	[FLASH MODE]
[Q16]	[EVF/LCD COLOR]
[POWER MANAGEMENT]	
[AUTO POWER OFF]	[2 MIN]
[OVF POWER SAVE MODE]	[OFF]
[HIGH PERFORMANCE]	[OFF]
[EDIT FILE NAME]	
[sRGB]	[DSCF]
[AdobeRGB]	[DSF]
[WIRELESS SETTINGS]	
[RESIZE IMAGE FOR SMARTPHONE 	[ON]

[GEOTAGGING SET-UP]	
[GEOTAGGING]	[ON]
[LOCATION INFO]	[ON]
[COLOR SPACE]	[sRGB]

[DATE/TIME]

Set the camera clock.

1. Select **[DATE/TIME]** in the playback menu.
2. Press the selector left or right to highlight the year, month, day, hour, or minute and press up or down to change. To change the order in which the year, month, and day are displayed, highlight the date format and press the selector up or down.

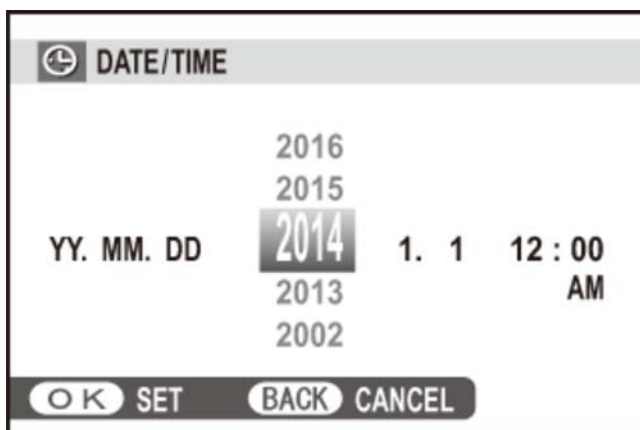

3. Press **[MENU/OK]** when settings are complete.

[TIME DIFFERENCE]

Switch the camera clock instantly from your home time zone to the local time at your destination when traveling. To specify the difference between local time and your home time zone:

1. Highlight **[LOCAL]** and press **[MENU/OK]**.
2. Use the selector to choose the time difference between local time and your home time zone. Press **[MENU/OK]** when settings are complete.

To set the camera clock to local time, highlight **[LOCAL]** and press **[MENU/OK]**. To set the clock to the time in your home time zone, select **[HOME]**. If **[LOCAL]** is selected,  will be displayed for three seconds when the camera is turned on.

 [言語/LANG.]

Choose a language.

[RESET]

Reset shooting or setup menu options to default values.

1. Select **[RESET]** in the playback menu.
2. Highlight the desired option and press the selector right.
3. A confirmation dialog will be displayed; highlight **[OK]** and press **[MENU/OK]**.

 **[DATE/TIME]**, **[TIME DIFFERENCE]**, **[SHUTTER COUNT]**, custom white balance, wireless network and PC auto save options, and custom settings banks created using **[EDIT/SAVE CUSTOM SETTING]** are not affected.

[SILENT MODE]

Select **[ON]** to disable the speaker, flash, and illuminator in situations in which camera sounds or lights may be unwelcome.  appears in the display when silent mode is on.

[FRAME NO.]

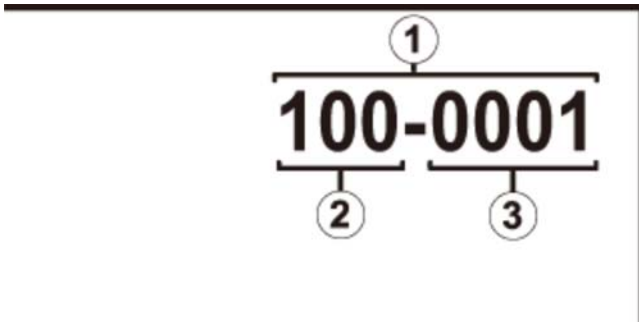

New pictures are stored in image files named using a four-digit file number assigned by adding one to the last file number used. The file number is displayed during playback as shown at right. **[FRAME NO.]** controls whether file numbering is reset to 0001 when a new memory card is inserted or the current memory card or internal memory is formatted.



- ① Frame number
- ② Directory number
- ③ File number

[CONTINUOUS] Numbering continues from the last file number used or the first available file number, whichever is higher. Choose this option to reduce the number of pictures with duplicate file names.

[RENEW] Numbering is reset to 0001 after formatting or when a new memory card is inserted.

-  If the frame number reaches 999-9999, the shutter release will be disabled.
-  Selecting **[RESET]** sets **[FRAME NO.]** to **[CONTINUOUS]** but does not reset the file number.
-  Frame numbers for pictures taken with other cameras may differ.

[FOCUS RING]





Choose the direction in which the focus ring is rotated to increase the focus distance in manual focus mode.

MF [FOCUS CHECK]

The image will be magnified in the display to assist focus when the focus ring is rotated in manual focus mode.

[SOUND SET-UP]

Adjust sound settings.

-  [OPERATION VOL.]
-  [SHUTTER VOLUME]
-  [SHUTTER SOUND]
-  [PLAYBACK VOLUME]

[OPERATION VOL.]

Adjust the volume of the sounds produced when camera controls are operated. Choose  OFF (mute) to disable control sounds.

[SHUTTER VOLUME]

Adjust the volume of the sounds produced when the shutter is released. Choose  OFF (mute) to disable the shutter sound.

[SHUTTER SOUND]

Choose the sound made by the shutter.

[PLAYBACK VOLUME]

Adjust the volume for movie playback.

[SCREEN SET-UP]

Adjust display settings.

- ⌵ [IMAGE DISP.]
- ⌵ [EVF AUTOROTATE DISPLAYS]
- ⌵ [PREVIEW EXP. IN MANUAL MODE]
- ⌵ [MONITOR SUNLIGHT MODE]
- ⌵ [EVF BRIGHTNESS]
- ⌵ [EVF COLOR]
- ⌵ [LCD BRIGHTNESS]
- ⌵ [LCD COLOR]
- ⌵ [PREVIEW PIC. EFFECT]
- ⌵ [FRAMING GUIDELINE]
- ⌵ [AUTOROTATE PB]
- ⌵ [FOCUS SCALE UNITS]

[IMAGE DISP.]

Choose how long images are displayed after shooting. Colors may differ slightly from those in the final image.

CONTINUOUS Pictures are displayed until the **[MENU/OK]** button is pressed or the shutter button is pressed halfway. To zoom in on the active focus point, press the center of the command dial; press again to cancel zoom.

[1.5 SEC]/[0.5 SEC] Pictures are displayed for 1.5 seconds (**[1.5 SEC]**) or 0.5 seconds (**[0.5 SEC]**) or until the shutter button is pressed halfway.

[OFF] Pictures are not displayed after shooting.

[EVF AUTOROTATE DISPLAYS]

Choose whether the indicators in the viewfinder rotate to match camera orientation.

 The display in the LCD monitor is unaffected.

[PREVIEW EXP. IN MANUAL MODE]

Select **[ON]** to enable exposure preview in manual exposure mode. Select **[OFF]** when using a flash or on other occasions on which exposure may change when the picture is taken.

[MONITOR SUNLIGHT MODE]

Select **[ON]** to make the display in the monitor easier to read in bright light.

 Press and hold the **[VIEW MODE]** button for monitor sunlight mode.

[EVF BRIGHTNESS]

Adjust the brightness of the display in the electronic viewfinder, or choose **[AUTO]** for automatic brightness adjustment.

[EVF COLOR]

Adjust the hue of the display in the electronic viewfinder.

[LCD BRIGHTNESS]

Adjust monitor brightness.

[LCD COLOR]

Adjust monitor hue.

[PREVIEW PIC. EFFECT]

Choose **[ON]** to preview the effects of film simulation, white balance, and other settings in the monitor. Choose **[OFF]** to make shadows in low-contrast, back-lit scenes and other hard-to-see subjects more visible.

 If **[OFF]** is selected, the effects of camera settings will not be visible in the monitor and colors and tone will differ from those in the final picture. The display will however be adjusted to show the effects of advanced filters and of monochrome and sepia settings.

[FRAMING GUIDELINE]

Choose the type of framing grid available in shooting mode.

GRID 9



For "rule of thirds" composition.

GRID 24

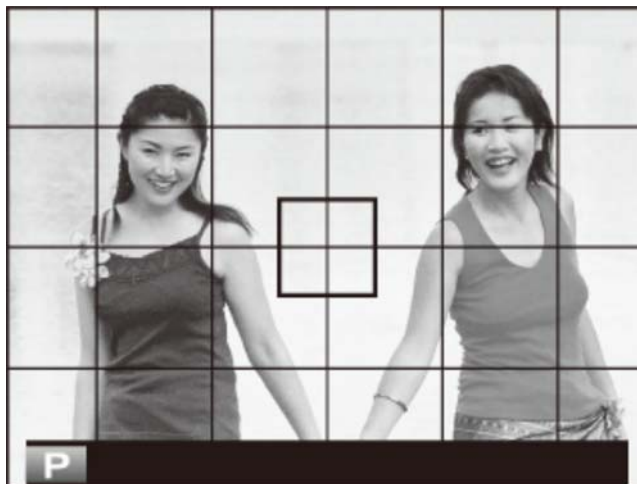

A six-by-four grid.

HD FRAMING



Frame HD pictures in the crop shown by the lines at the top and bottom of the display.

[AUTOROTATE PB]

Choose **[ON]** to automatically rotate "tall" (portrait-orientation) pictures during playback.

[FOCUS SCALE UNITS]

Choose the units used for the focus distance indicator.

[SELECTOR BUTTON SETTING]

Choose the roles played by the up, down, left, and right buttons on the selector.

[Fn BUTTON] The selector buttons serve as function buttons.

[FOCUS AREA] The selector can be used to position the focus area.

[EDIT/SAVE QUICK MENU]

Choose the items displayed in the quick menu.

1. Display the setup menu and select **[EDIT/SAVE QUICK MENU]**.
2. Highlight the item you wish to change and press **[MENU/OK]**. You will be given the following choice of items to assign to the selected position in the quick menu.

- | | |
|----------------------------------|---------------------------------|
| ▪ [SELECT CUSTOM SETTING] | ▪ [AF MODE] |
| ▪ [ISO] | ▪ [FLASH MODE] |
| ▪ [DYNAMIC RANGE] | ▪ [FLASH COMPENSATION] |
| ▪ [WHITE BALANCE] | ▪ [MF ASSIST] |
| ▪ [NOISE REDUCTION] | ▪ [MOVIE MODE] |
| ▪ [IMAGE SIZE] | ▪ [MOVIE ISO] |
| ▪ [IMAGE QUALITY] | ▪ [MIC LEVEL ADJUSTMENT] |
| ▪ [FILM SIMULATION] | ▪ [SILENT MODE] |
| ▪ [HIGHLIGHT TONE] | ▪ [EVF/LCD BRIGHTNESS] |
| ▪ [SHADOW TONE] | ▪ [EVF/LCD COLOR] |
| ▪ [COLOR] | ▪ [ADVANCED FILTER] |
| ▪ [SHARPNESS] | ▪ [CONVERSION LENS] |
| ▪ [SELF-TIMER] | ▪ [SHUTTER TYPE] |
| ▪ [FACE DETECTION] | ▪ [ND FILTER] |
| ▪ [PHOTOMETRY] | |

 Select **[NONE]** to assign no item to the selected position.

 When **[SELECT CUSTOM SETTING]** is selected, the quick menu shows current settings as **[BASE]**.

3. Highlight the desired item and press **[MENU/OK]** to assign it to the selected position in the quick menu.

[POWER MANAGEMENT]

Adjust power management settings.

- ⌵ [AUTO POWER OFF]
- ⌵ [OVF POWER SAVE MODE]
- ⌵ [HIGH PERFORMANCE]

[AUTO POWER OFF]

Choose the length of time before the camera turns off automatically when no operations are performed. Shorter times reduce the drain on the battery; if **[OFF]** is selected, the camera must be turned off manually. Note that in some situations the camera turns off automatically even when **[OFF]** is selected.

[OVF POWER SAVE MODE]

Select **[ON]** to reduce power consumption and increase the number of pictures that can be taken on a single charge when pictures are framed in the optical viewfinder.

 Power consumption is not reduced when the electronic viewfinder or electronic range finder is used.

[HIGH PERFORMANCE]

Select **[ON]** for faster focus and to reduce the time needed to restart the camera after it has been turned off.

 [SHUTTER COUNT]

View the approximate number of times the shutter has been released. Other actions may also increment the counter, for example turning the camera off, changing the viewfinder display selection, or choosing playback mode.

[EDIT FILE NAME]

Replace the default file name prefix ("DSCF" or "_DSF"). Enter the desired prefix, then highlight **[SET]** and press **[MENU/OK]**.

[WIRELESS SETTINGS]

Adjust settings for connection to wireless networks.

- ⌵ [\[GENERAL SETTINGS\]](#)
- ⌵ [\[RESIZE IMAGE FOR SMARTPHONE\]](#) 
- ⌵ [\[PC AUTO SAVE SETTINGS\]](#)

[GENERAL SETTINGS]

Choose a name (**[NAME]**) to identify the camera on the wireless network (the camera is assigned a unique name by default) or select **[RESET WIRELESS SETTINGS]** to restore default settings.

[RESIZE IMAGE FOR SMARTPHONE]

Choose **[ON]** (the default setting, recommended in most circumstances) to resize larger images to  for upload to smartphones, **[OFF]** to upload images at their original size. Resizing applies only to the copy uploaded to the smartphone; the original is not affected.

[PC AUTO SAVE SETTINGS]

Choose **[DELETE REGISTERED DESTINATION PC]** to remove selected destinations, **[DETAILS OF PREVIOUS CONNECTION]** to view computers to which the camera has recently connected.

See Also

- ➔ [The FUJIFILM Smartphone/Tablet/Computer App](#) (opens in another window)

[PC AUTO SAVE SETTING]

Choose an upload destination. Choose **[SIMPLE SETUP]** to connect using WPS, **[MANUAL SETUP]** to configure network settings manually.

See Also

-  [The FUJIFILM Smartphone/Tablet/Computer App](#) (opens in another window)

[GEOTAGGING SET-UP]

View location data downloaded from a smartphone and choose whether to save the data with your pictures.

[GEOTAGGING] Choose whether location data downloaded from a smartphone are embedded in pictures as they are taken.

[LOCATION INFO] Display the location data last downloaded from a smartphone.

See Also

 [The FUJIFILM Smartphone/Tablet/Computer App](#) (opens in another window)

[instax PRINTER CONNECTION SETTING]

Enter a printer name (SSID) and password for connection to an optional FUJIFILM instax SHARE printer. See the printer manual for details.

See Also

 [Printer manual \(PDF: !\[\]\(bbb3388d591ef640dd8a8c4262f2866a_img.jpg\)](#))

COLOR SPACE

Choose the gamut of colors available for color reproduction.

sRGB Recommended in most situations.

Adobe RGB For commercial printing.

 [FORMAT]

If a memory card is inserted in the camera, this option will format the memory card. If no memory card is inserted, this option will format internal memory.

- ⓘ All data—including protected pictures—will be deleted from the memory card or internal memory. Be sure important files have been copied to a computer or other storage device.
- ⓘ Do not open the battery-chamber cover during formatting.

Connections

- ➔ [Wireless Transfer](#)
- ➔ [Copying Pictures to a Computer](#)
- ➔ [Printing Pictures via USB](#)
- ➔ [Viewing Pictures on TV](#)

Wireless Transfer

Access wireless networks and connect to computers, smartphones, or tablets. Visit the following website for information on camera wireless LAN features and on downloading related apps.

See Also

➔ [The FUJIFILM Smartphone/Tablet/Computer App](#) (opens in another window)

⬇ [Wireless Connections: Smartphones](#)

⬇ [Wireless Connections: Computers](#)

Wireless Connections: Smartphones

Install the “FUJIFILM Camera Remote” app on your smartphone to browse the images on the camera, download selected images, control the camera remotely, or copy location data to the camera. To connect to the smartphone, press the camera **[Wi-Fi]** button in playback mode.

✎ At default settings, **[WIRELESS COMMUNICATION]** is assigned to the **[Wi-Fi]** button (function button 7). For information on choosing the roles assigned to the function buttons, see “The Function Buttons”. You can also connect using the **[WIRELESS COMMUNICATION]** options in the shooting and playback menu.

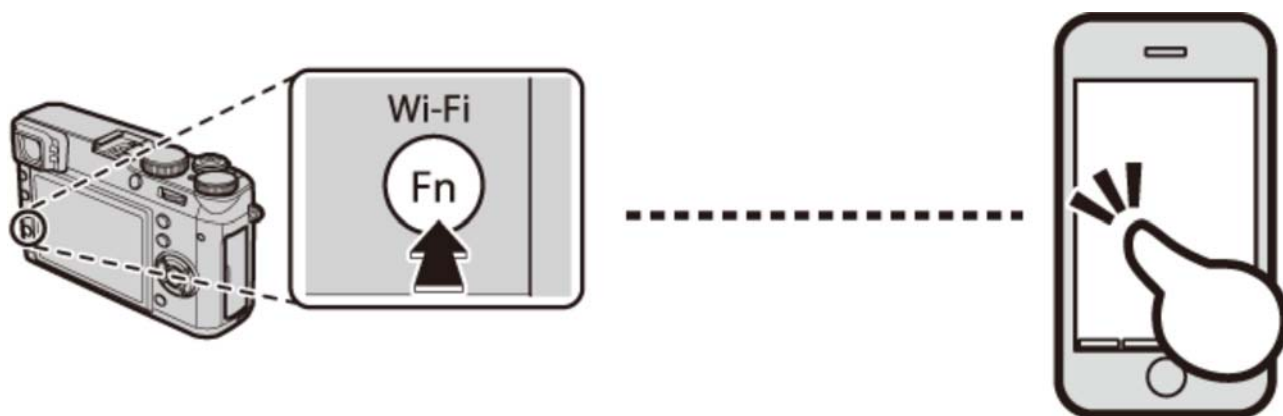

Wireless Connections: Computers

Once you have installed the “FUJIFILM PC AutoSave” application and configured your computer as a destination for the images copied from the camera, you can upload pictures from the camera using the **[PC AUTO SAVE]** option in the camera playback menu or by pressing and holding the **[Wi-Fi]** button in playback mode.

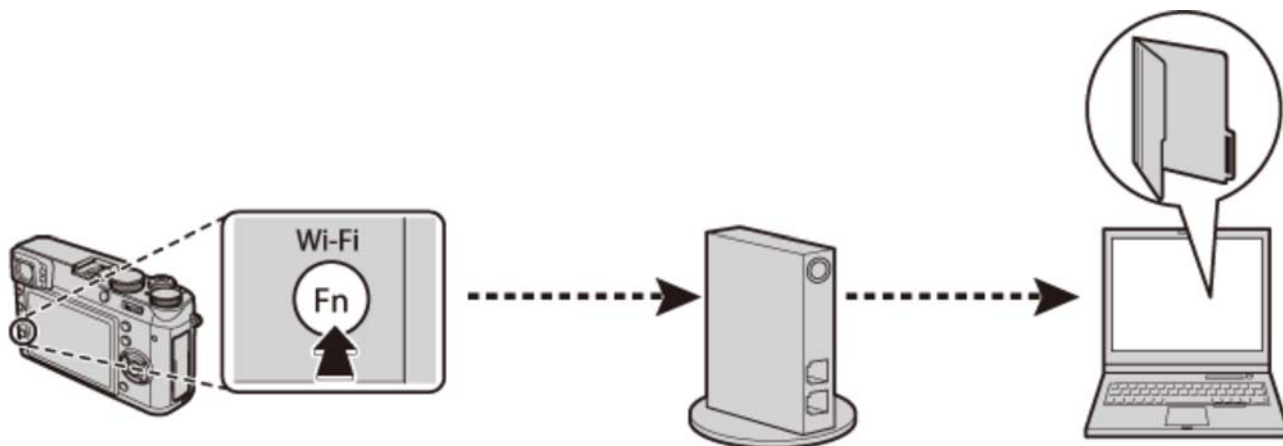

See Also

- ➔ [The Function Buttons](#) ([Fn] (Function) Buttons)
- ➔ [\[WIRELESS COMMUNICATION\]](#) (The Shooting Menu)
- ➔ [\[PC AUTO SAVE\]](#) (The Playback Menu)

Copying Pictures to a Computer

Connect the camera to the computer using the supplied USB cable and copy pictures as described below.

1. Start the computer.
2. Turn the camera off.
3. Use the supplied USB cable to connect the camera and computer.

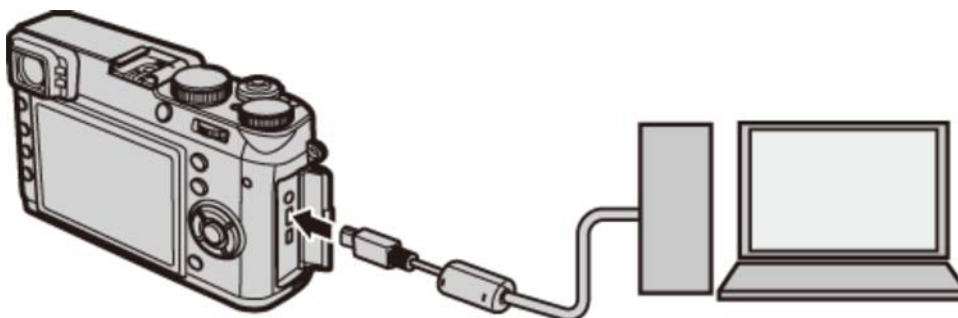

⚠ Be sure the connectors are in the correct orientation and fully inserted. Connect the camera directly to the computer; do not use a USB hub or keyboard.

4. Turn the camera on.
5. Copy pictures to the computer using MyFinePix Studio or applications provided with your operating system.

MyFinePix Studio/RAW FILE CONVERTER

Use MyFinePix Studio (available for Windows only) to copy pictures to a computer, where they can be viewed, organized, and printed. To view RAW images on the computer, use RAW FILE CONVERTER.

- ❗ If a memory card containing a large number of images is inserted, there may be a delay before the software starts and you may be unable to import or save images. Use a memory card reader to transfer pictures.
- ❗ Make sure that the computer does not display a message stating that copying is in progress and that the indicator lamp is out before turning the camera off or disconnecting the USB cable (if the number of images copied is very large, the indicator lamp may remain lit after the message has cleared from the computer display). Failure to observe this precaution could result in loss of data or damage to the memory card.
- ❗ Disconnect the camera before inserting or removing memory cards.
- ❗ In some cases, it may not be possible to access pictures saved to a network server using the supplied software in the same way as on a standalone computer.
- ❗ The user bears all applicable fees charged by the phone company or Internet service provider when using services that require an Internet connection.

See Also

- ➔ [MyFinePix Studio](#) (opens in another window)
- ➔ [RAW FILE CONVERTER powered by SilkyPix](#) (opens in another window)

Printing Pictures via USB

If the printer supports PictBridge, the camera can be connected directly to the printer and pictures can be printed without first being copied to a computer.



PictBridge

- ⬇ [Connecting the Camera](#)
- ⬇ [Printing Selected Pictures](#)
- ⬇ [Printing the DPOF Print Order](#)

Connecting the Camera

1. Connect the USB cable as shown and turn the printer on.

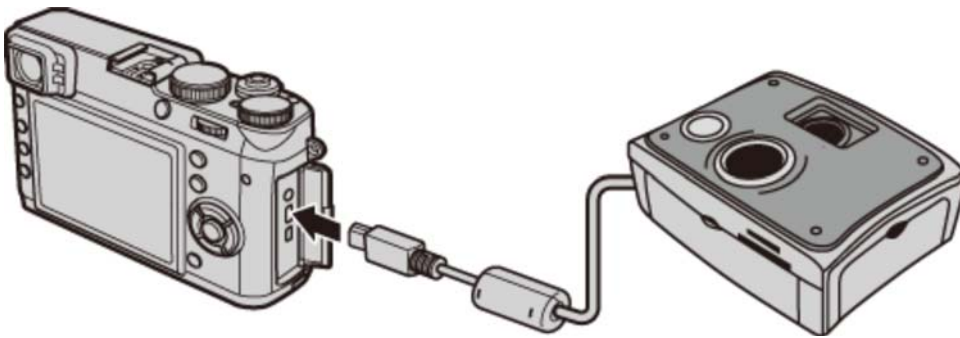

2. Turn the camera on. **[USB]** will be displayed in the monitor, followed by the PictBridge display.

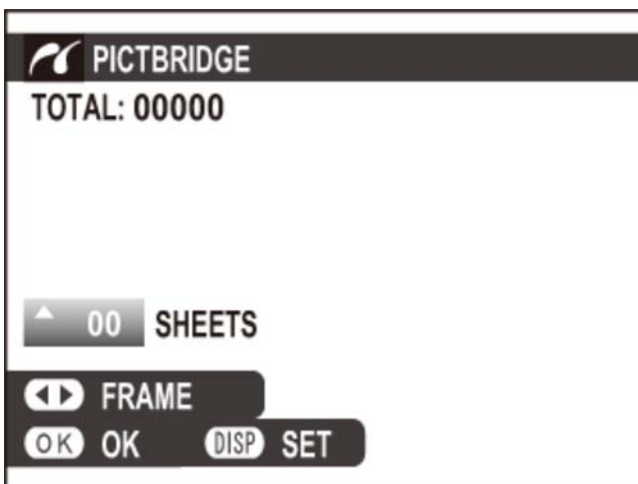
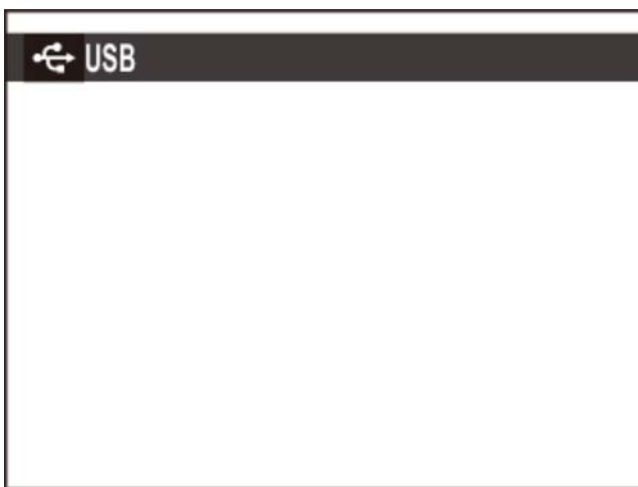

Printing Selected Pictures

1. Press the selector left or right to display a picture you wish to print.
To print one copy of the current picture, proceed directly to Step 3.
2. Press the selector up or down to choose the number of copies (up to 99). Repeat steps 1–2 to select additional pictures.
3. Press **[MENU/OK]** to display a confirmation dialog.

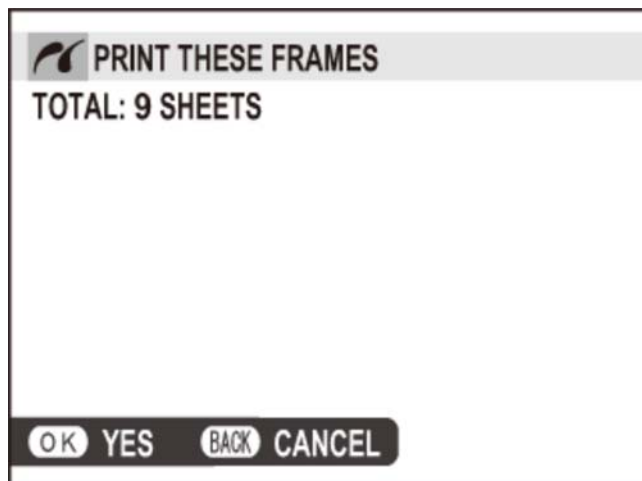

4. Press **[MENU/OK]** to start printing.

 If no pictures are selected when the **[MENU/OK]** button is pressed, the camera will print one copy of the current picture.

Printing the Date of Recording

To print the date of recording on pictures, press **[DISP/BACK]** in the PictBridge display and select **[PRINT WITH DATE]** (to print pictures without the date of recording, select **[PRINT WITHOUT DATE]**). To ensure that the date is correct, set the camera clock before taking pictures. Some printers do not support date printing.

Printing the DPOF Print Order

To print the print order created with **[PRINT ORDER (DPOF)]** in the playback menu.

1. In the PictBridge display, press **[DISP/BACK]** to open the PictBridge menu.
2. Press the selector up or down to highlight **[PRINT DPOF]**.

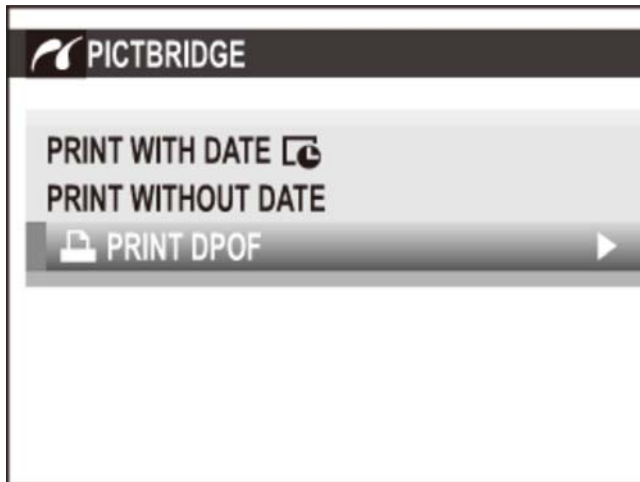

3. Press **[MENU/OK]** to display a confirmation dialog.

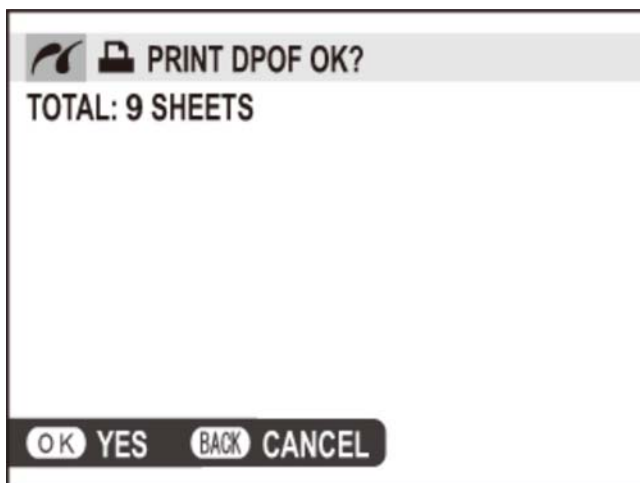

4. Press **[MENU/OK]** to start printing.

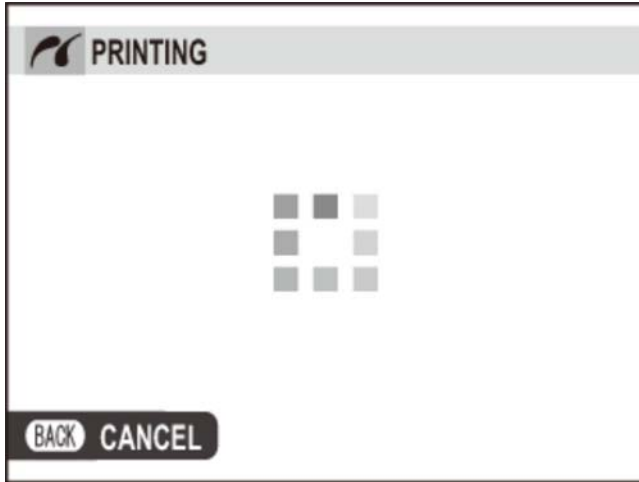

During Printing

A message is displayed during printing. Press **[DISP/BACK]** to cancel before all pictures are printed (depending on the printer, printing may end before the current picture has printed). If printing is interrupted, turn the camera off and then on again.



Disconnecting the Camera

Confirm that the above message is not displayed and turn the camera off. Disconnect the USB cable.

-  Pictures can be printed from internal memory or a memory card that has been formatted in the camera.
-  When pictures are printed via direct USB connection, page size, print quality, and border selections are made using the printer.

See Also

-  [\[PRINT ORDER \(DPOF\)\]](#) (The Playback Menu)

Viewing Pictures on TV

To show pictures to a group, connect the camera to a TV using an HDMI cable (available separately from third-party suppliers; note that the TV can only be used for playback, not shooting).

1. Turn the camera off.
2. Connect the cable as shown below.

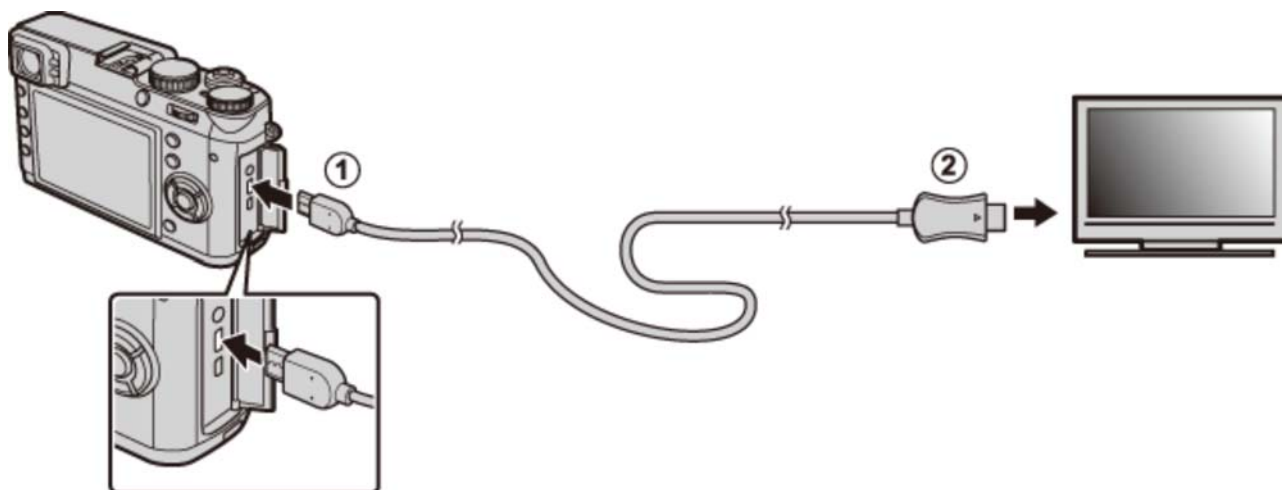

- 1 Insert into Micro HDMI connector
- 2 Insert into HDMI connector

! Use an HDMI cable no more than 1.5 m (4.9 ft.) long.

✎ Be sure the connectors are fully inserted.

3. Tune the television to the HDMI input channel. See the documentation supplied with the television for details.
4. Turn the camera on and press  button. The camera monitor turns off and pictures and movies are played back on the TV. Note that the camera volume controls have no effect on sounds played on the TV; use the television volume controls to adjust the volume.

✎ The USB cable can not be used while an HDMI cable is connected.

✎ Some televisions may briefly display a black screen when movie playback begins.

Accessories

- ➔ [Shoe-mounted flash units](#)
- ➔ [Power Supplies](#)
- ➔ [Remote Releases](#)
- ➔ [Conversion Lens](#)
- ➔ [Stereo microphones](#)
- ➔ [Other](#)
- ➔ [Website of the country or region of purchase](#)

For more information, visit the website of the country or region of purchase (the new window will open).

[Check the website »](#)

Shoe-mounted flash units



Shoe mount flash EF-20



Shoe mount flash EF-42



Shoe mount flash EF-X20

- EF-20** This clip-on flash unit (powered by two AA batteries) has a Guide Number of 20/65 (ISO 100, m/ft.) and supports TTL flash control. The flash head can be rotated upwards 90° for bounce lighting.
- EF-42** This clip-on flash unit (powered by four AA batteries) has a Guide Number of 42/137 (ISO 100, m/ft.) and supports TTL flash control and auto power zoom in the range 24–105 mm (35 mm format equivalent). The flash head can be rotated 90° up, 180° left, or 120° right for bounce lighting.
- EF-X20** This clip-on flash unit (powered by two AAA alkaline or Ni-MH batteries) has a Guide Number of 20/65 (ISO 100, m/ft.). With the FUJIFILM's unique flash control technology "i Flash technology", it can automatically optimize the amount of light suitable to every shooting condition. Built-in "Slave Mode" for advanced photography.

For more information, visit the website of the country or region of purchase (the new window will open).

[Check the website »](#)

Power Supplies

- 📌 [Rechargeable Li-ion batteries](#)
- 📌 [Battery chargers](#)

Rechargeable Li-ion batteries



NP-95

NP-95 Additional large-capacity NP-95 rechargeable batteries can be purchased as required.

Battery chargers

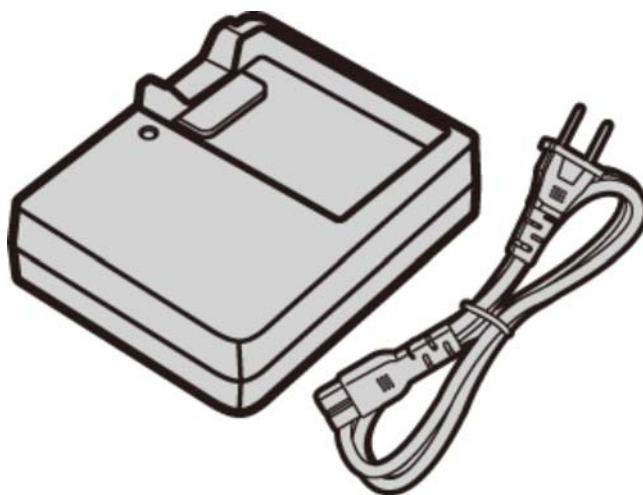

BC-65N

BC-65N Replacement battery chargers can be purchased as required. At +20 °C/+68 °F, the BC-65N charges an NP-95 in about 240 minutes.

For more information, visit the website of the country or region of purchase (the new window will open).

[Check the website »](#)

Remote Releases



Remote Releases RR-90

RR-90 Use to reduce camera shake or keep the shutter open during a time exposure.

Using a Remote Release

An optional RR-90 remote release can be used for long time-exposures.

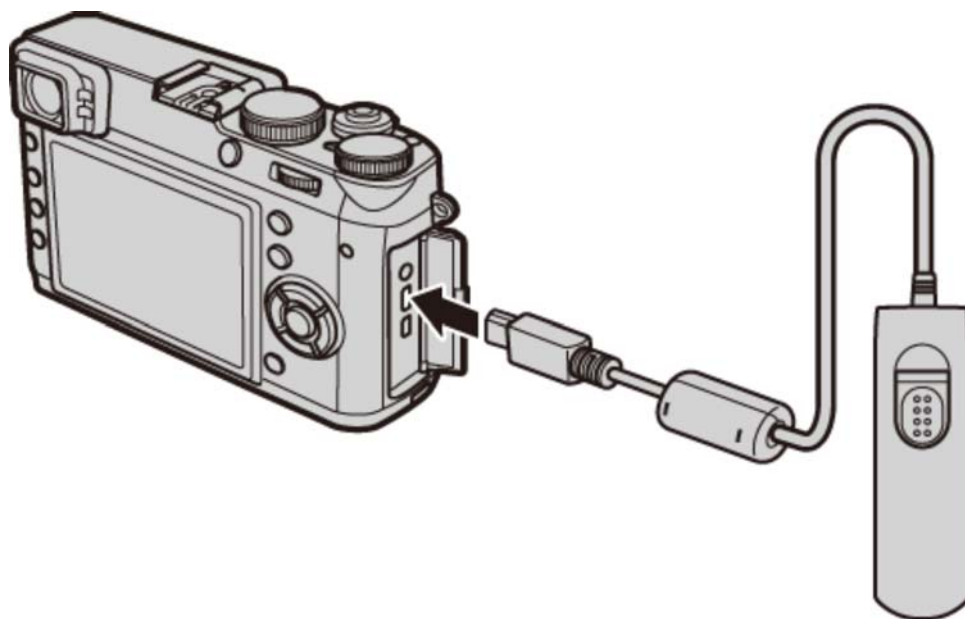

Third-Party Remote Releases

Electronic releases from third-party suppliers can be connected via the microphone/remote release connector.

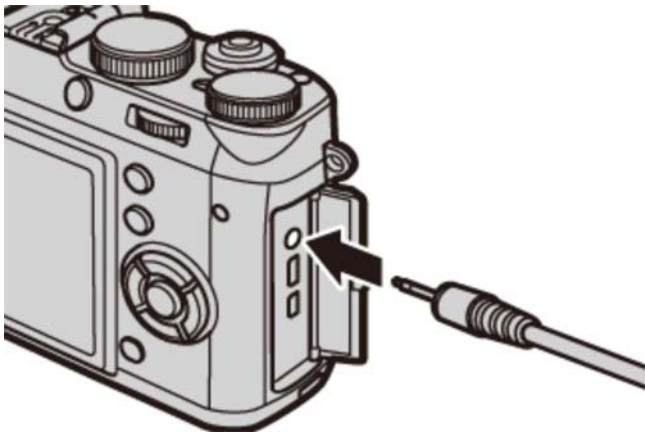

- ✎ A confirmation dialog will be displayed when a third-party release is connected; press **[MENU/OK]** and select **[REMOTE]** for **[MIC/REMOTE RELEASE]**.

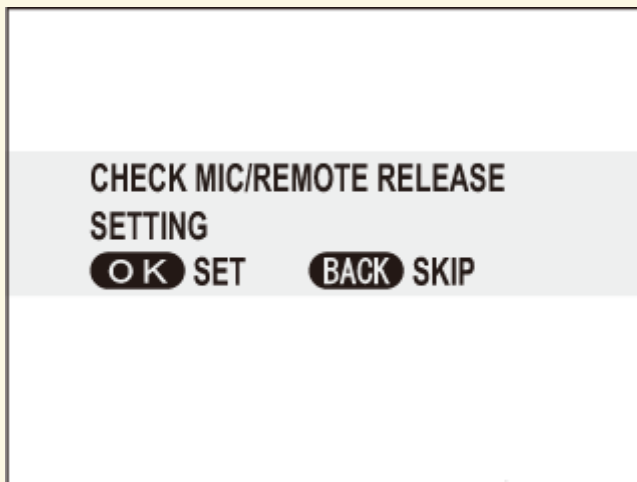

For more information, visit the website of the country or region of purchase (the new window will open).

[Check the website »](#)

Conversion Lens

📌 [Tele Conversion Lens](#)

📌 [Wide Conversion Lens](#)

Tele Conversion Lens

TCL-X100 When attached to the X100T, the TCL-X100 increases the focal length by approximately 1.4× to 33 mm (equivalent to 50 mm in 35 mm format).

Wide Conversion Lens

WCL-X100 When attached to the X100T, the WCL-X100 increases the angle of view for wider-angle shots.

For more information, visit the website of the country or region of purchase (the new window will open).

[Check the website »](#)

Stereo microphones



MIC-ST1

MIC-ST1 An external microphone for movie recording.

For more information, visit the website of the country or region of purchase (the new window will open).

[Check the website »](#)

Other

- ⬇ Adapter rings
- ⬇ Lens hoods
- ⬇ Protector filters
- ⬇ Leather cases
- ⬇ Hand Grip
- ⬇ Grip Belt

Adapter rings

AR-X100 An aluminum adapter ring exclusively for use with the X100T/X100S/X100. It is used when attaching the LH-X100 lens hood or ϕ 49 mm filters available from third-party suppliers.

Attaching Adapter Rings

1. Remove the front ring.

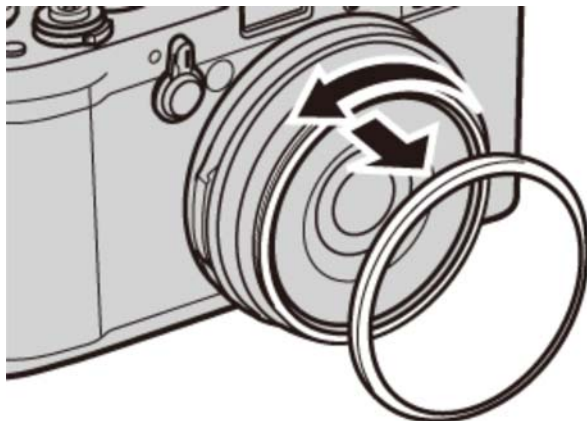

 If you have trouble removing the front ring, grip the entire ring and rotate it as shown.

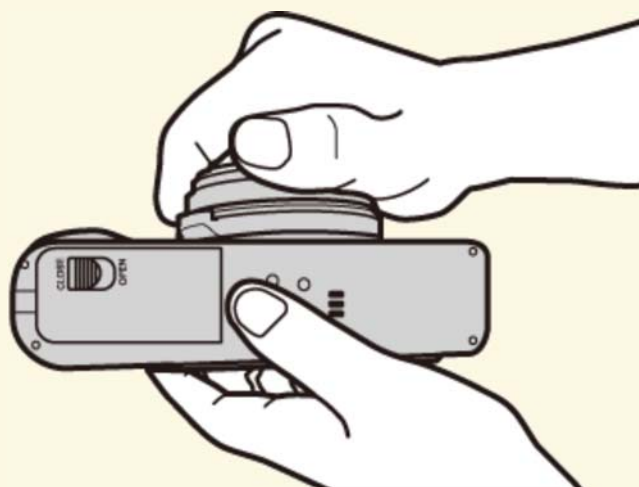

2. Attach the adapter ring as shown, with the projections facing out.

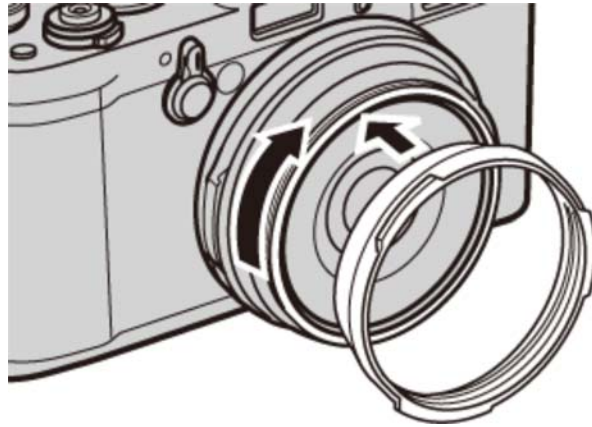



- ⚠ Keep the front ring and lens cap in a safe place when not in use.
- ⚠ Attach the adapter ring before attaching LH-X100 lens hood, PRF-49S protector filter, or third-party filters.

Lens hoods

LH-X100 This aluminum lens hood, exclusively for use with the X100T/X100S/X100, comes with an AR-X100 adapter ring made of the same material. The adapter ring is required when attaching the hood.

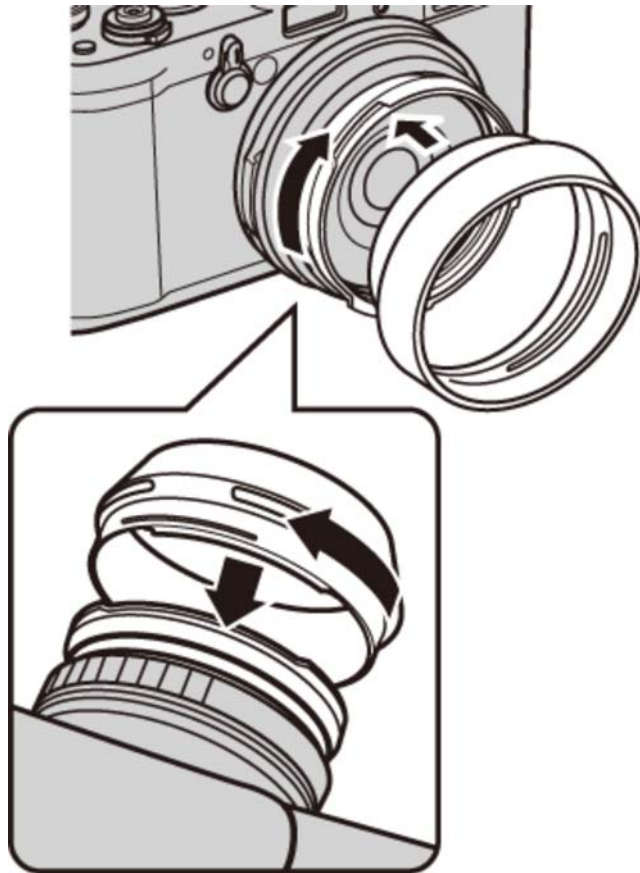
Attach the adapter ring before attaching the lens hood.





 Align the indentations and rotate as shown.

Protector filters

PRF-49S A protective filter exclusively for use with the X100T/X100S/X100.

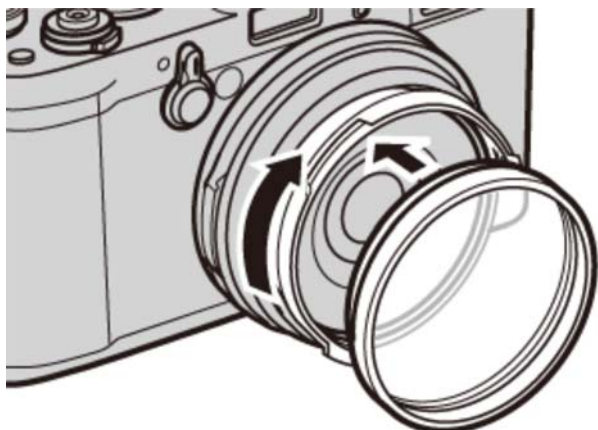
Attach the adapter ring before attaching the filter.



 Requires AR-X100 adapter ring.

Leather cases

LC-X100S This leather case, exclusively for use with the X100T/X100S/X100, combines practicality with the luxury of leather and comes with a shoulder strap made of the same material. Pictures can be taken and batteries and memory cards inserted or removed with the camera still in its case.

Hand Grip

MHG-X100 To increase the camera's grip. Both battery and memory card can be swapped with the grip in place. Additionally, a tripod screw hole can be placed in centre of the optical axis and the base parts are equipped with a 38mm width dovetail protrusion plate, allowing use as a quick shoe mount when using a dovetail groove tripod pedestal.

Grip Belt

GB-001 GB-001 enhances the camera's hold, allowing users to carry the camera firmly with just one hand.

For more information, visit the website of the country or region of purchase (the new window will open).

[Check the website »](#)

Website of the country or region of purchase

Select the website of your country or region (the new window will open).

North America

Latin America

Europe

Asia Pacific

Middle East&Africa

For Your Safety

➔ [For Your Safety](#)

For Your Safety

Safety precautions are described in the following pdf:

See Also

[➔ For Your Safety \(PDF: !\[\]\(c3d993ca47bfe2a953c700506ce31fa0_img.jpg\)\)](#)

Appendix

- ➔ [Troubleshooting/FAQ](#)
- ➔ [Warning Messages and Displays](#)
- ➔ [Specifications](#)
- ➔ [Links](#)
- ➔ [Restrictions on Camera Settings](#)

Troubleshooting/FAQ

- ⌵ [Power and Battery](#)
- ⌵ [Menus and Displays](#)
- ⌵ [Shooting](#)
- ⌵ [Playback](#)
- ⌵ [Connections/Miscellaneous](#)

Power and Battery

Problem	Solution
The camera does not turn on.	<ul style="list-style-type: none"> ⚙ The battery is exhausted: Charge the battery or insert a fully-charged spare battery. ⚙ The battery is inserted incorrectly: Reinsert in the correct orientation. ⚙ The battery-chamber cover is not latched: Latch the battery-chamber cover. ⚙ The camera was turned on immediately after having been turned off: Press the shutter button halfway.
The battery runs down quickly.	<ul style="list-style-type: none"> ⚙ The battery is cold: Warm the battery by placing it in a pocket or other warm place and reinsert it in the camera immediately before taking a picture. ⚙ There is dirt on the battery terminals: Clean the terminals with a soft, dry cloth. ⚙ The battery has been charged many times: The battery has reached the end of its charging life. Purchase a new battery. ⚙ [C] is selected for focus mode: Select a different focus mode.
The camera turns off suddenly.	<ul style="list-style-type: none"> ⚙ The battery is exhausted: Charge the battery or insert a fully-charged spare battery. ⚙ The camera has entered sleep mode: Press the shutter button halfway.
Charging does not start.	Reinsert the battery in the correct orientation and make sure that the charger is plugged in.
Charging is slow.	Charge the battery at room temperature.

Problem	Solution
The charging lamp blinks, but the battery does not charge.	<ul style="list-style-type: none"> ⚙ There is dirt on the battery terminals: Clean the terminals with a soft, dry cloth. ⚙ The battery has been charged many times: The battery has reached the end of its charging life. Purchase a new battery. If the battery still fails to charge, contact your FUJIFILM dealer.

Menus and Displays

Problem	Solution
Menus and displays are not in English.	Select [ENGLISH] for [言語/LANG.] .

Shooting

Problem	Solution
No picture is taken when the shutter button is pressed.	<ul style="list-style-type: none"> ⚙ Memory is full: Insert a new memory card or delete pictures. ⚙ Memory is not formatted: Format the memory card or internal memory. ⚙ There is dirt on the memory card contacts: Clean the contacts with a soft, dry cloth. ⚙ The memory card is damaged: Insert a new memory card. ⚙ The battery is exhausted: Charge the battery or insert a fully-charged spare battery. ⚙ The camera has turned off automatically: Turn the camera on. ⚙ The indicator lamp was orange when you attempted to record a panorama: Wait until the indicator lamps turns off.
The display goes dark after shooting.	The display may darken while the flash charges. Wait for the flash to charge.
Mottling (“noise”) appears in the monitor or viewfinder when the shutter button is pressed halfway.	⚙ Gain is increased to aid composition when the subject is poorly lit and aperture is stopped down, which may result in noticeable mottling when images are previewed in the displays. Images taken with the camera are unaffected.

Problem	Solution
<p>The camera does not focus.</p>	<ul style="list-style-type: none"> ⚙ The subject is close to the camera: Select macro mode. ⚙ The subject is far away from the camera: Cancel macro mode. ⚙ The subject is not suited to autofocus: Use focus lock.
<p>No face is detected.</p>	<ul style="list-style-type: none"> ⚙ The subject's face is obscured by sunglasses, a hat, long hair, or other objects: Remove the obstructions. ⚙ The subject's face occupies only a small area of the frame: Change the composition so that the subject's face occupies a larger area of the frame. ⚙ The subject's head is tilted or horizontal: Ask the subject to hold their head straight. ⚙ The camera is tilted: Keep the camera level. ⚙ The subject's face is poorly lit: Shoot in bright light.
<p>Wrong subject is selected.</p>	<p>The selected subject is closer to the center of the frame than the main subject. Recompose the picture or turn face detection off and frame the picture using focus lock.</p>
<p>The flash does not fire.</p>	<ul style="list-style-type: none"> ⚙ The flash is charging: Wait for the flash to charge before pressing the shutter button. ⚙ The flash is off: Choose a different flash mode. ⚙ The battery is exhausted: Charge the battery or insert a fully-charged spare battery. ⚙ The camera is in bracketing or continuous mode: Select single frame mode. ⚙ The camera is in silent mode: Turn silent mode off.
<p>Some flash modes are not available.</p>	<ul style="list-style-type: none"> ⚙ The camera is in silent mode: Turn silent mode off.
<p>The flash does not fully light the subject.</p>	<ul style="list-style-type: none"> ⚙ The subject is not in range of the flash: Position the subject in range of the flash. ⚙ The flash window is obstructed: Hold the camera correctly. ⚙ Shutter speed is faster than 1/2000 s: Choose a slower shutter speed.

Problem	Solution
Pictures are blurred.	<ul style="list-style-type: none"> ⚙️ The lens is dirty: Clean the lens. ⚙️ The lens is blocked: Keep objects away from the lens. ⚙️ !AF is displayed during shooting and the focus frame is displayed in red: Check focus before shooting.
Pictures are mottled.	<ul style="list-style-type: none"> ⚙️ A slow shutter speed is selected at high temperatures: This is normal and does not indicated a malfunction. ⚙️ The camera has been used continuously at high temperatures or a temperature warning is displayed: Turn the camera off and wait for it to cool down.
The viewfinder display is not clear.	<ul style="list-style-type: none"> ⚙️ Diopter adjustment is not adjusted correctly: Slide the diopter adjustment control up and down until the viewfinder display is in sharp focus.
Sounds made by the camera are recorded with movies.	<ul style="list-style-type: none"> ⚙️ The focus mode selector is set to [C]. Select a different focus mode. ⚙️ Intelligent Face Detection is on: Turn Intelligent Face Detection off.

Playback



Problem	Solution
Pictures are grainy.	The pictures were taken with a different make or model of camera.
Playback zoom unavailable.	The picture has been saved at 640 , or is from another make or model of camera.
No sound in movie playback.	<ul style="list-style-type: none"> ⚙️ The camera is in silent mode: Turn silent mode off. ⚙️ Playback volume is too low: Adjust playback volume. ⚙️ The microphone was obstructed: Hold the camera correctly during recording. ⚙️ The speaker is obstructed: Hold the camera correctly during playback.
Selected pictures are not deleted.	Some of the pictures selected for deletion are protected. Remove protection using the device with which it was originally applied.
File numbering is unexpectedly reset.	The battery-chamber cover was opened while the camera was on. Turn the camera off before opening the battery-chamber cover.





Connections/Miscellaneous





Problem	Solution
No picture or sound.	<ul style="list-style-type: none"> ⚙ The camera is not properly connected: Connect the camera properly. Note that once the camera is connected, pictures will be displayed on the TV instead of in the camera monitor. ⚙ Input on the television is set to "TV": Set input to "HDMI". ⚙ The volume on the TV is too low: Adjust the volume.
The computer does not recognize the camera.	Be sure the camera and computer are correctly connected.
Can not transfer RAW or JPEG files to computer.	Use MyFinePix Studio to transfer pictures (Windows only).
Pictures can not be printed.	<ul style="list-style-type: none"> ⚙ The camera is not properly connected: Connect the camera correctly. ⚙ The printer is off: Turn the printer on.
Only one copy is printed/the date is not printed.	The printer is not PictBridge compatible.
The camera is unresponsive.	<ul style="list-style-type: none"> ⚙ Temporary camera malfunction: Remove and reinsert the battery. ⚙ The battery is exhausted: Charge the battery or insert a fully-charged spare battery.
The camera does not function as expected.	Remove and reinsert the battery. If the problem persists, contact your FUJIFILM dealer.
No sound.	Turn silent mode off.
The hybrid viewfinder does not function as expected.	<ul style="list-style-type: none"> ⚙ The viewfinder is temporarily malfunctioning due to an impact caused, for example, by the camera being dropped: Turn the camera on and then off again.

Warning Messages and Displays

The following warnings are displayed in the LCD monitor:

Warning	Description
 (red)	Low battery. Charge the battery or insert a fully-charged spare battery.
 (blinks red)	Battery exhausted. Charge the battery or insert a fully-charged spare battery.
!AF (displayed in red with red focus frame)	The camera can not focus. Try one of the following solutions: <ul style="list-style-type: none"> • Use focus lock to focus on another subject at the same distance, then recompose the picture. • Use macro mode to focus when taking close-ups.
Aperture or shutter speed displayed in red	The subject is too bright or too dark and the picture will be over- or under-exposed. If the subject is dark, use the flash.
[FOCUS ERROR]	Camera malfunction. Turn the camera off and then on again. If the message persists, contact a FUJIFILM dealer.
[TURN OFF THE CAMERA AND TURN ON AGAIN]	
[LENS CONTROL ERROR]	
[CARD NOT INITIALIZED]	<ul style="list-style-type: none"> • The memory card or internal memory is not formatted or the memory card was formatted in a computer or other device: Format the memory card or internal memory using the [FORMAT] option in the camera setup menu. • The memory card contacts require cleaning: Clean the contacts with a soft, dry cloth. If the message is repeated, format the card. If the message persists, replace the card. • Camera malfunction: Contact a FUJIFILM dealer.
[PROTECTED CARD]	The memory card is locked. Unlock the card.
[BUSY]	The memory card is incorrectly formatted. Use the camera to format the card.
	Turn the camera off and wait for it to cool. If no action is taken, the camera will turn off automatically.
[CARD ERROR]	The memory card is not formatted for use in the camera. Format the card.

Warning	Description
	<p>The memory card contacts require cleaning or the memory card is damaged. Clean the contacts with a soft, dry cloth. If the message is repeated, format the card. If the message persists, replace the card.</p> <p>Incompatible memory card. Use a compatible card.</p> <p>Camera malfunction. Contact a FUJIFILM dealer.</p>
 [MEMORY FULL]	<p>The memory card or internal memory is full and pictures can not be recorded or copied. Delete pictures or insert a memory card with more free space.</p>
 [MEMORY FULL]	
[INTERNAL MEMORY IS FULL INSERT A NEW CARD]	
[WRITE ERROR]	<ul style="list-style-type: none"> • Memory card error or connection error: Reinsert the card or turn the camera off and then on again. If the message persists, contact a FUJIFILM dealer. • Not enough memory remaining to record additional pictures: Delete pictures or insert a memory card with more free space. • The memory card or internal memory is not formatted: Format the memory card or internal memory.
[READ ERROR]	<ul style="list-style-type: none"> • The file is corrupt or was not created with the camera: The file can not be viewed. • The memory card contacts require cleaning: Clean the contacts with a soft, dry cloth. If the message is repeated, format the card. If the message persists, replace the card. • Camera malfunction: Contact a FUJIFILM dealer.
[FRAME NO. FULL]	<p>The camera has run out of frame numbers (current frame number is 999–9999). Format the memory card and select [RENEW] for [FRAME NO.]. Take a picture to reset frame numbering to 100–0001, then select [CONTINUOUS] for [FRAME NO.].</p>
[TOO MANY FRAMES]	<ul style="list-style-type: none"> • A search has returned more than 30,000 results: Choose a search that returns fewer results. • More than 999 images are selected for deletion: Choose fewer images.
[PROTECTED FRAME]	<p>An attempt was made to delete or rotate to a protected picture. Remove protection and try again.</p>
 [CAN NOT crop]	 pictures can not be cropped.
[CAN NOT crop]	<p>The picture is damaged or was not created with the camera.</p>

Warning	Description
 [CANNOT EXECUTE]	
 [CANNOT EXECUTE]	An attempt was made to create a resized copy at a size equal to or larger than the original. Choose a smaller size.
 [CANNOT EXECUTE]	
[CAN NOT ROTATE]	
 [CAN NOT ROTATE]	Movies can not be rotated.
 [CANNOT EXECUTE]	Red-eye removal can not be applied to the selected picture.
 [CANNOT EXECUTE]	Red-eye removal can not be applied to movies.
[NO CARD]	No memory card inserted when [COPY] is selected. Insert a memory card.
 [NO IMAGE]	The source selected for [COPY] contains no images. Select a different source.
 [NO IMAGE]	
[DPOF FILE ERROR]	The DPOF print order on the current memory card contains more than 999 images. Copy the pictures to internal memory and create a new print order.
[CAN NOT SET DPOF]	The picture can not be printed using DPOF.
 [CAN NOT SET DPOF]	Movies can not be printed using DPOF.
[COMMUNICATION ERROR]	A connection error occurred while pictures were being printed or copied to a computer or other device. Confirm that the device is turned on and that the USB cable is connected.
[PRINTER ERROR]	Printer out of paper or ink, or other printer error. Check printer (see printer manual for details). To resume printing, turn the printer off and then turn it back on.
[PRINTER ERROR RESUME?]	Printer out of paper or ink, or other printer error. Check printer (see printer manual for details). If printing does not resume automatically, press [MENU/OK] to resume.

Warning	Description
[CANNOT BE PRINTED]	An attempt was made to print a movie, a picture not created with the camera, or a picture in a format not supported by the printer. Movies and some pictures created with other devices can not be printed; if the picture is a still picture created with the camera, check the printer manual to confirm that the printer supports the JFIF–JPEG or Exif–JPEG format. If it does not, the pictures can not be printed.

Specifications

Model Name	FUJIFILM X100T
Number of effective pixels	16.3 million pixels
Image sensor	23.6mm × 15.6mm (APS-C) X-Trans CMOS II with primary color filter
Storage media	<ul style="list-style-type: none"> • Internal memory (approx. 55MB) • SD memory card / SDHC memory card / SDXC (UHS-I) memory card¹
File format	<p>still image JPEG (Exif Ver 2.3)², RAW (RAF format), RAW+JPEG (Design rule for Camera File system compliant / DPOF-compatible)</p> <p>movie MOV (H.264, Audio : Linear PCM / stereo sound)</p>
Number of recorded pixels	<p>L (3:2) 4896 × 3264 / (16:9) 4896 × 2760 / (1:1) 3264 × 3264</p> <p>M (3:2) 3456 × 2304 / (16:9) 3456 × 1944 / (1:1) 2304 × 2304</p> <p>S (3:2) 2496 × 1664 / (16:9) 2496 × 1408 / (1:1) 1664 × 1664</p> <p><Motion Panorama></p> <p>180° Vertical : 9600 × 2160 Horizontal : 9600 × 1440</p> <p>120° Vertical: 6400 × 2160 Horizontal: 6400 × 1440</p>
Lens	<p>name Fujinon Single focal length lens</p> <p>focal length f=23mm, equivalent to 35mm on a 35mm format</p> <p>full-aperture F2</p> <p>constitution 6 groups 8 lenses (1 aspherical glass molded lenses included)</p>
Aperture	F2.0 – F16 1/3EV step (controlled with 9-blade aperture diaphragm)

Focus distance (from lens surface)	<p>Normal Approx. 50cm / 1.6 ft. to infinity</p> <p>Macro Approx. 10cm - 2.0m / 3.9 in.- 6.6 ft.</p>
Sensitivity	AUTO1 / AUTO2 / AUTO3 (Control available up to ISO6400), Equivalent to ISO 200 - 6400 (Standard Output Sensitivity) Extended output sensitivity equivalent to ISO 100, 12800, 25600 and 51200
Exposure control	TTL 256-zone metering, Multi / Spot / Average
Exposure mode	Programmed AE, Shutter priority AE, Aperture priority AE, Manual exposure
Face detection	YES
Exposure compensation	-3.0EV – +3.0EV 1/3EV step
Shutter speed	<p>Mechanical Shutter (P mode) 4 sec. to 1/4000* sec., (All other modes) 30 sec. to 1/4000* sec. Bulb (max.60min.), Time 2 sec. to 30 sec.</p> <p>Electronic Shutter³ 1 sec. to 1/32000* sec. (P / A / S /M mode) Bulb / Time 1 sec. fixed</p> <p>Mechanical + Electronic Shutter³ (P mode) 4 sec. to 1/32000* sec., (All other modes) 30 sec. to 1/32000* sec. Bulb (max.60min.), Time 2 sec. to 30 sec. Mechanical Shutter : Bulb - Mechanical Shutter limit Electronic Shutter : Mechanical Shutter limit - 1/32000 * F2 up to 1/1000 sec., 1/4000 sec. at F8 or smaller aperture</p>
Continuous shooting	<p>TOP High : approx. 6.0 fps (max. 25 frames) Low : approx. 3.0 fps (up to the capacity of the card) * Max. number of frames can be shot in JPEG setting</p> <p>LAST -</p> <p>Best Frame capture -</p>

Auto bracketing	<p>AE Bracketing: $\pm 1/3\text{EV}$, $\pm 2/3\text{EV}$, $\pm 1\text{EV}$</p> <p>Film Simulation Bracketing: Any 3 type of Film Simulation selectable</p> <p>Dynamic Range Bracketing: 100% / 200% / 400%</p> <p>ISO sensitivity Bracketing: $\pm 1/3\text{EV}$, $\pm 2/3\text{EV}$, $\pm 1\text{EV}$</p> <p>White Balance Bracketing (± 1, ± 2, ± 3)</p>
Focus	<p>mode Single AF / Continuous AF / MF</p> <p>type Intelligent Hybrid AF (TTL contrast AF / TTL phase detection AF), AF assist illuminator available</p> <p>AF frame selection Multi / Area</p>
White balance	<p>Automatic scene recognition</p> <p>Preset Fine, Shade, Fluorescent light (Daylight), Fluorescent light (Warm White), Fluorescent light (Cool White), Incandescent light, Underwater, Custom, Color temperature selection</p>
Self-timer	10 sec. / 2 sec. delay
Interval timer shooting	Yes (Setting: Interval, Number of shots, Starting time)
Flash	<p>Auto flash (Super Intelligent Flash)</p> <p>Effective range : (ISO 1600)</p> <p>Approx. 50 cm - 9 m / 1.6 ft. - 29.5 ft.</p>
Flash modes	<p>Red-eye Removal OFF Auto, Forced Flash, Suppressed Flash, Slow Synchro, Commander</p> <p>Red-eye Removal ON Red-eye Reduction Auto, Red-eye Reduction & Forced Flash, Suppressed Flash, Red-eye Reduction & Slow Synchro, Commander</p>
Hot shoe	Yes (Dedicated TTL Flash compatible)

Viewfinder	<p>Hybrid viewfinder</p> <p>Optical viewfinder (OVF) Reverse Galilean viewfinder with electronic bright frame display 0.5 x magnifications Coverage of frame area vs. capturing area : approx. 92%</p> <p>Electronic viewfinder (EVF) 0.48-in., Approx. 2,360K-dot color LCD viewfinder Coverage of viewing area vs. capturing area : approx. 100% 0.65 x magnifications</p> <p>Electronic rangefinder (ERF) Displays the enlarged focus area on the optical viewfinder</p> <p>Eye sensor installed</p> <p>Eye point Approx. 15 mm</p> <p>Diopter adjustment -2 - +1 m⁻¹(dpt)</p>
LCD monitor	3.0-inch, aspect ratio 3:2 approx. 1040K-dot, TFT color LCD monitor (Approx. 100% coverage)
Movie recording	1920 × 1080 pixels / 1280 × 720 pixels (60 fps, 50 fps, 30 fps, 25 fps, 24 fps) with stereo sound
Photography functions	Face Detection, Select Custom setting, Shutter Type, Conversion Lens, Auto Red-eye Removal, Color, Sharpness, Highlight Tone, Shadow Tone, Noise Reduction, Dynamic Range, Multiple Exposure, Motion Panorama, Film Simulation (PROVIA/STANDARD, Velvia/VIVID, ASTIA/SOFT, CLASSIC CHROME, PRO Neg Hi, PRO Neg. Std, MONOCHROME, MONOCHROME+Ye FILTER, MONOCHROME+R FILTER, MONOCHROME+G FILTER, SEPIA) , Advanced filter (Toy camera / Miniature / Pop color / High-key / Low-key / Dynamic tone / Partial color / Soft focus), Electronic level, Histogram display, Framing guideline, Frame No. memory, Pre-AF, Focus Check, Focus Peak Highlight, Digital Split Image™ ⁴ , Release/Focus Priority, Instant AF Setting, Interlock Spot AE & Focus Area, Edit/Save Quick Menu, Corrected AF Frame, 7 Function Buttons
Playback functions	RAW Conversion, Erase, Crop, Resize, Protect, Image Rotate, Auto Red-eye Removal, Slide Show, Photobook Assist, Mark For Upload To, Image Search, Copy, Panorama, Favorites, Face Detection, Multi-frame playback (with micro thumbnail), Histogram display, Exposure warning, Autorotate Playback
Other functions	PictBridge, Exif Print, 35 Languages, Date/Time, Time difference, Shutter sound, Silent mode, Quick start Mode, High Performance, Preview exp. in Manual mode, Monitor sunlight mode, EVF Brightness, EVF Color, LCD Brightness, LCD Color, Preview Pic. Effect, DISP. Custom Setting, Shutter Count, OVF Power Save Mode, Auto Power OFF

Wireless transmitter	<p>Standard IEEE 802.11b / g / n (standard wireless protocol)</p> <p>Access mode Infrastructure</p>
Wireless function	Geotagging, Wireless communication (Image transfer), View & Obtain Images, Remote camera shooting, instax printer print, PC Autosave
Terminal	<p>Video output -</p> <p>Digital interface USB2.0 (High-Speed) / micro USB terminal * connectable with Remote Release RR-90 (sold separately)</p> <p>HDMI output HDMI Micro connector (Type D)</p> <p>Audio input Microphone / shutter release input: Ø2.5mm, stereo mini connector</p>
Power supply	NP-95 Li-ion battery (included)
Dimensions	126.5mm (W) × 74.4mm (H) × 52.4mm (D) / 5.0in. (W) × 2.9in. (H) × 2.1in. (D) (Minimum Depth : 31.0mm / 1.2 in.)
Weight	Approx. 440g / 15.5 oz. (including battery and memory card) Approx. 400g / 14.1 oz. (excluding accessories, battery and memory card)
Operating Temperature	0 – 40°C (+32°F – +104°F)
Operating Humidity	10 – 80% (no condensation)
Guide to the number of available frames for battery operation ³	Approx. 330 frames ⁵ (up to 700 frames when OVF POWER SAVE MODE is ON)

Accessories included	Li-ion battery NP-95 Battery charger BC-65N Shoulder strap USB cable Lens cap Metal strap clip Protective cover Clip attaching tool Owner's Manual(Basic Operations)
Optional accessories	Hand Grip MHG-X100 Li-ion Battery NP-95 Battery Charger BC-65N Leather Case LC-X100S, LC-X100S B Wide Conversion Lens WCL-X100S, WCL-X100B Tele Conversion Lens TCL-X100S, TCL-X100B Lens Hood LH-X100, LH-X100 B Adapter Ring AR-X100, AR-X100 B Shoe Mount Flash EF-20, EF-42, EF-X20 Protector Filter PRF-49S ⁶ Stereo Microphone MIC-ST1 Remote Release RR-90 Grip Belt GB-001

1 Please see the Fujifilm website ([Memory Cards](#)) to check memory card compatibility.

2 Exif 2.3 is a digital camera file format that contains a variety of shooting information for optimal printing.

3 The Electronic Shutter may not be suitable for fast-moving objects. Flash can not be used.

4 Digital Split Image is a trademark or a registered trademark of FUJIFILM Corporation.

5 Approximate number of frames / period that can be taken with a fully-charged battery based on CIPA standard.

6 Lens hood or Adapter Ring required.

Links

For more information on FUJIFILM digital camera, visit our websites (the new window will open).

FUJIFILM X100T Product Information

Optional accessories and support information can be found on the following website.

Free FUJIFILM Apps

The FUJIFILM app gives you more opportunities to enjoy your pictures on smart phones, tablets, and computers.

MyFinePix Studio

MyFinePix Studio (Windows only) can be used to copy pictures to a computer, where they can be stored, viewed, organized, and printed.

RAW FILE CONVERTER powered by SilkyPix

RAW FILE CONVERTER can be used to view RAW images on your computer.

Restrictions on Camera Settings

The following table lists the settings available in each mode.

See Also

- ➔ [Restrictions on Camera Settings \(PDF: !\[\]\(aca6fcc8bd95e8255b9ea1b1d08ef300_img.jpg\)\)](#)