

Ladder Racks and Accessories

The perfect cable management solution
for ceilings, walls, computer rooms,
and wiring closets.

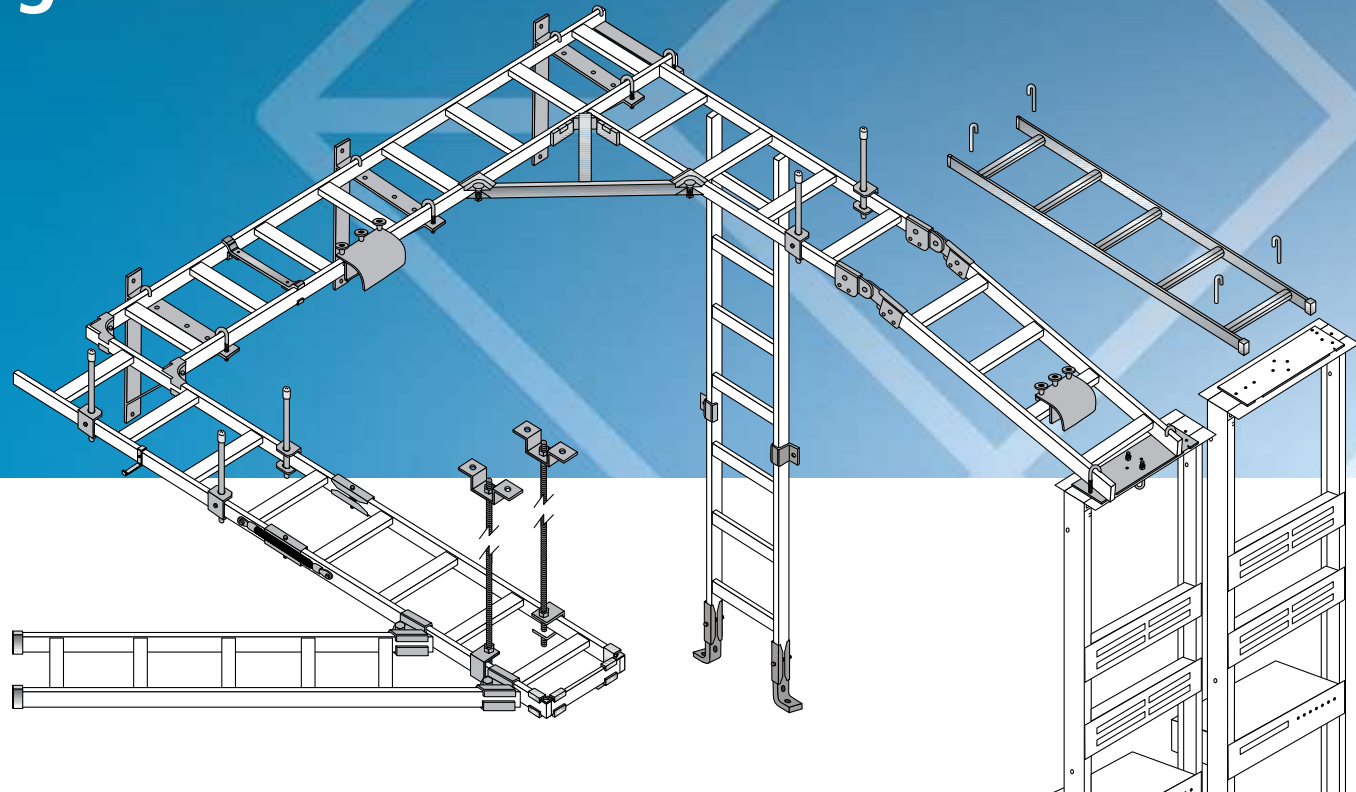

FEATURES

- » Route and manage large bundles of data, computer, or communications cable.
- » Use with modular networking frames and cable management racks.
- » The 6-foot (1.8-m) length eliminates the need to cut racks for shorter runs.
- » Choose from many accessories for a total cable management solution.
- » Available in black and gray.

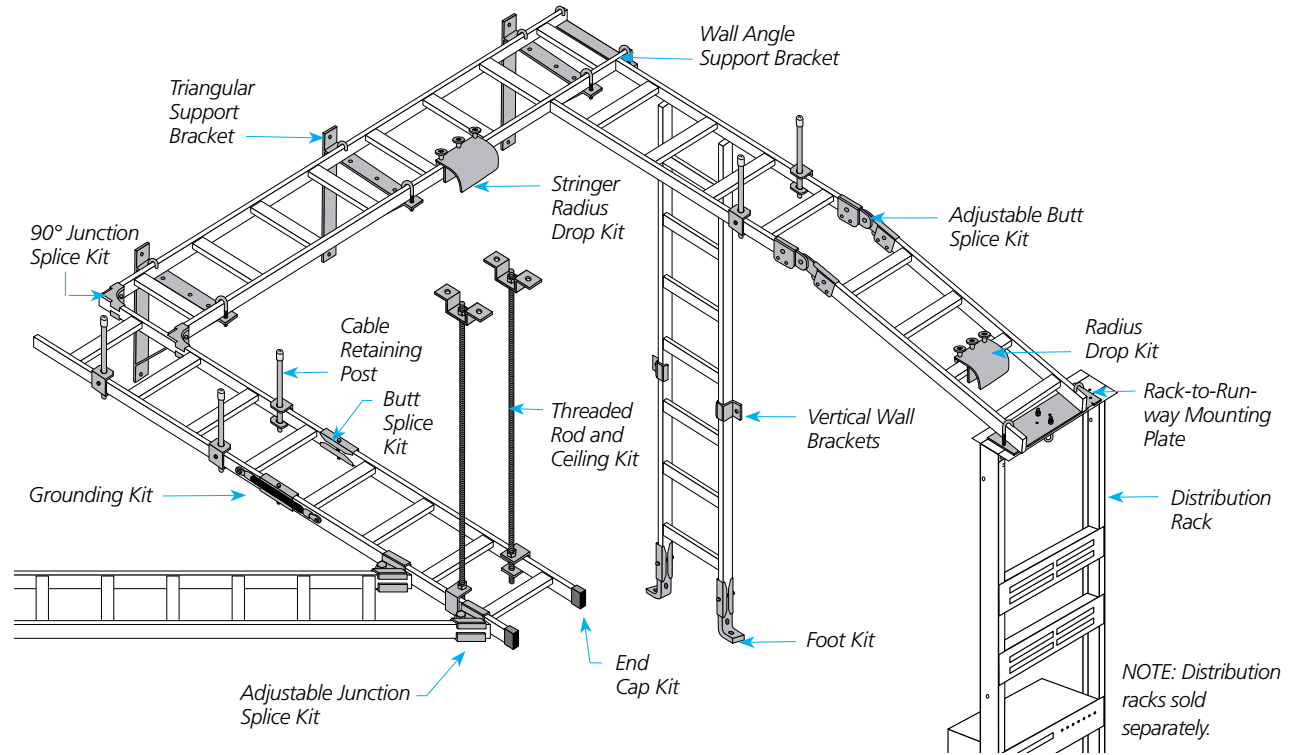

OVERVIEW

Ladder Racks

(RM650, RM663, RM651, RM664)

- Two sizes available: 6' x 12" or 10' x 12".
- Constructed of 16-gauge tubular steel.
- Side rails are made of $\frac{3}{8}$ " x $1\frac{1}{2}$ " tubing; stringers consist of $\frac{1}{2}$ " x 1" tubing.
- Have an 11.25" inside width and a 12" outside width.

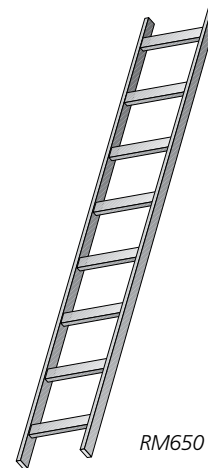

Foot Kit for Ladder Rack (RM649-R2)

- Used to secure the Ladder Rack to the wall or floor of a computer room, wiring closet, or data center.
- Foot kit brackets attach to the Ladder Rack and the wall or floor.
- This kit contains two feet, four splice plates, two trimmed-head square-neck bolts and nuts.
- This kit does not include hardware for attaching to a floor or wall.

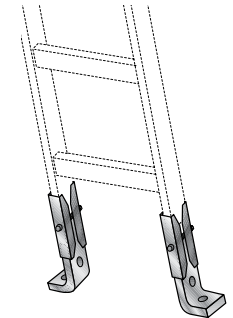

Cable Runway Radius (RM652, RM666)

- Creates a smooth gradual bend for cable placement where a 90° run is required.
- Maintains cable bend radius.
- Attaches to the Ladder Rack using the Butt Splice Kit (RM657).
- Outside corner bend width of 12".
- 33° angle between stringers.
- Constructed of 3/8" x 1 1/2" tubular steel.

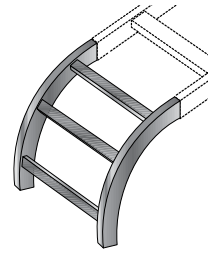

Rack-to-Runway Mounting Plate (RM653-R2, RM665-R2)

- A universal mounting plate used to secure the Ladder Rack to the top of equipment racks; can be mounted either parallel or perpendicular.
- Comes with (1) plate, (4) 5/16" - 18 x 2 1/4" J-bolts, and (4) 5/16" - 18 hex nuts with attached lockwasher.
- Made of 11-gauge steel; 19"W x 5.375"L.

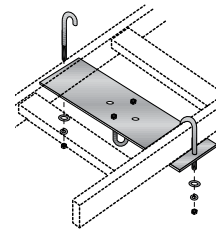

Bracket, Triangular (RM654-R2, RM667-R2)

- Provides wall support (parallel) for the Ladder Rack.
- Comes with (1) bracket, (2) 5/16" - 18 x 2 1/4" J-bolts, and (2) 5/16" - 18 hex nuts with attached lockwasher.
- 12" width.

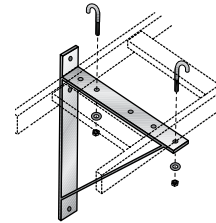

Bracket, Wall Angle (RM655, RM668)

- Provides wall support (perpendicular) for the Ladder Rack.
- Comes with (1) bracket, (2) 5/16" - 18 x 2 1/4" J-bolts, and (2) 5/16" - 18 hex nuts with attached lockwasher.
- 2" x 2" x 3/16" steel design.

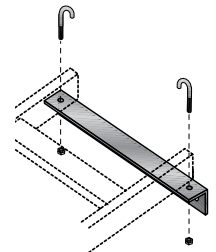

Wall Bracket, Vertical (RM860)

- Secures Ladder Rack section to wall or other flat surface.

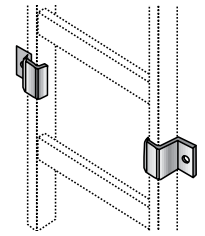

90° Junction Splice Kit (RM656)

- Used to complete a right angle Ladder Rack T-junction.
- Comes with (4) corner clamp latches, (2) 3/8" - 16 x 1 3/8" round head square neck bolts, (2) 3/8" - 16 hex nuts, and (2) split lock washers.

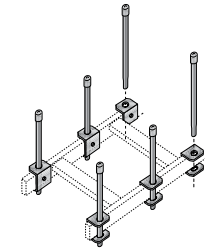

Butt Splice Kits (RM657, RM861)

- Used to join Ladder Racks end to end to form a continuous extended runway.
- Includes all necessary hardware.
- Adjustable Butt Splice Kit adjusts to any angle from 0 to 90 degrees.

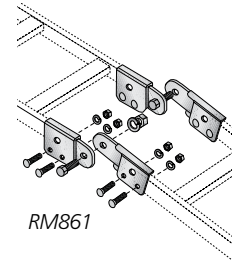

Adjustable Junction Splice Kit (RM862)

- Connects two Ladder Rack sections at any angle.
- Includes all necessary hardware.

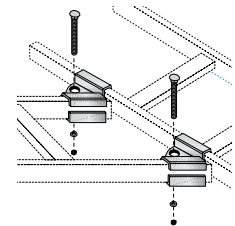

Cable Retaining Post (RM658-R2, RM669-R2)

- Mounts on the Ladder Rack side stringers to form side legs for cable retention. The post extends 6" above the top of the Rack.
- Comes with (1) post, (1) bracket, (1) end cap, and 1/4" - 20" x 1" hex capscrew and hex nut with attached lockwasher.
- 3/8" x 1 1/2" x 0.65" wall rectangular steel tubing.

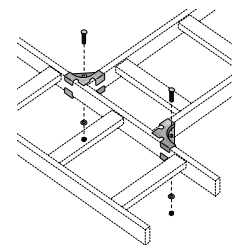

Threaded Ceiling Kit (RM659-R3)

- Used to suspend the Ladder Rack from the ceiling.
- Recommended spacing is 5 feet between kits.
- This kit contains brackets only; it must be used with the Threaded Rod (RM660).
- $\frac{5}{8}$ " diameter.

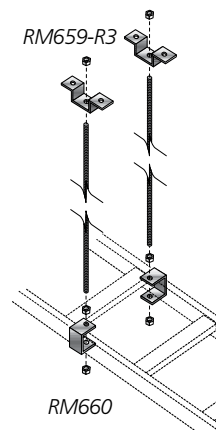

Threaded Rod (RM660)

- Used to support racks from the ceiling.
- 6' long, $\frac{5}{8}$ " diameter.

J-Bolt Kit (RM662)

- Used to attach the Ladder Rack to a Wall Angle Bracket (RM655).
- Comes with (2) $\frac{3}{16}$ " - 18 x 2 $\frac{1}{4}$ " J-bolts and (2) $\frac{3}{16}$ " - 18 hex nuts with attached lockwasher.

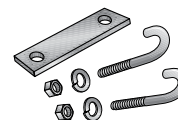

Radius Drop Kit (RM867-R2, RM866)

- Mount over Ladder Rack Cross Member to provide bend radius for cable.
- Aluminum construction.
- Includes all necessary hardware.

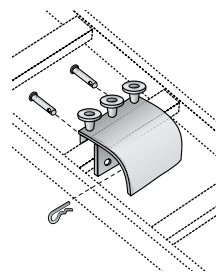

Stringer Radius Drop Kit (RM864-R2, RM863)

- Mounts over Ladder Rack stringer to provide bend radius for cable.
- Aluminum construction.
- Includes all necessary hardware.

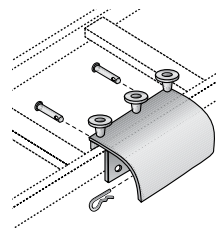

Grounding Kit (RM865)

- Eight-inch braided copper grounding strap.
- Requires drilling mounting-screw holes in Ladder Rack stringers.
- Includes all necessary hardware.

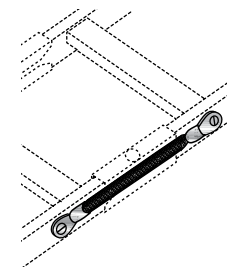

L-Bracket Kit (RM692)

- Supports cables such as power cables that need to be separated from the main cable run.
- Mounts onto the Ladder Rack stringer and includes mounting hardware.

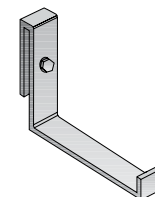

Corner Support Bracket Kit (RM693)

- Provides extra support for 90° Ladder Rack junctions.

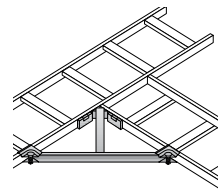

Movable Cross Member (RM695)

- Helps to support cable at drop locations between welded cross members.
- For maximum cable protection, use the Movable Cross Member together with the Radius Drop Kit.
- Includes mounting hardware.

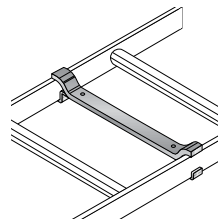

End Cap Kit (RM661)

- Protects and covers exposed ends of the Ladder Rack.
- Reduces chance of cable damage or personal injury.
- Includes (2) End Caps.
- Made of thermoplastic rubber.

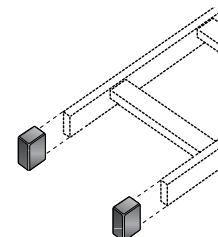

Runway Termination Kit (RM694)

- Finishes and stabilizes the last section when the Ladder Rack ends away from a wall.

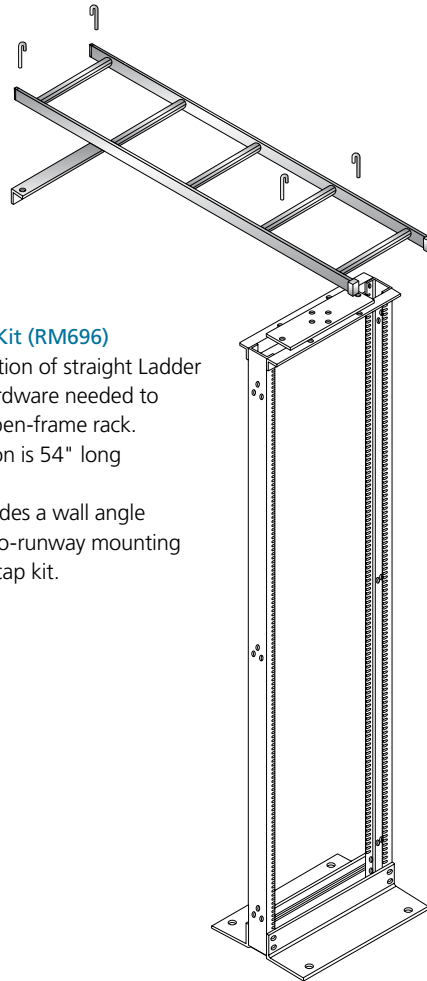
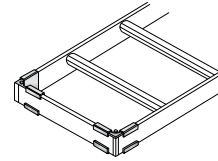

The Rack-to-Wall Kit (RM696)

- Includes one section of straight Ladder Rack and the hardware needed to fasten it to an open-frame rack.
- The ladder section is 54" long by 12" wide.
- The kit also includes a wall angle support, a rack-to-runway mounting kit, and an end-cap kit.

Buying Tips

NOTE: Relay racks sold separately. For details, contact our FREE Tech Support.

Item	Code
Ladder Racks	
6' x 12", Black	RM650
6' x 12", Gray	RM663
10' x 12", Black	RM651
10' x 12", Gray	RM664
Foot Kit for Ladder Rack	RM649-R2
Cable Runway Radius	
Black	RM652
Gray	RM666
Rack-to-Runway Mounting Plate	
Black	RM653-R2
Gray	RM665-R2
Bracket, Triangular	
Black	RM654-R2
Gray	RM667-R2
Bracket, Wall Angle	
Black	RM655
Gray	RM668
Wall Bracket, Vertical	RM860
90° Junction Splice Kit	RM656
Butt Splice Kits	
Black	RM657
Gray	RM861
Adjustable Junction Splice Kit	RM862
Cable Retaining Post	
Black	RM658-R2
Gray	RM669-R2
Threaded Ceiling Kit	RM659-R3
Threaded Rod	RM660
J-Bolt Kit (2 Bolts with Nuts)	RM662
Radius Drop Kit	
Black	RM867-R2
Gray	RM866
Stringer Radius Drop Kit	
Black	RM864-R2
Gray	RM863
Grounding Kit	RM865
L-Bracket Kit	RM692
Corner Support Bracket Kit	RM693
Movable Cross Member	RM695
End Cap Kit	RM661
Runway Termination Kit	RM694
Rack-to-Wall Kit	RM696