



PLN2400
LED LCD Monitor

USER'S GUIDE

www.planar.com

Content

Operation Instructions	1
Unpacking Instructions	3
Safety Precautions	3
Consignes de sécurité	4
Package Overview	5
First Setup	6
Front View of the Product.....	7
Rear View of the Product	8
Quick Installation.....	10
Basic Operation	11
OSD Menu	13
Supporting Timing Modes	19
Technical Information	20
Wall Mount Instructions	21
Care and Maintenance Wall	22
Troubleshooting	22
Planar Support	23

Operation Instructions

Thank you for purchasing the PLN2400 monitor. Please read this guide thoroughly before installation.

FCC RADIO FREQUENCY INTERFERENCE STATEMENT WARNING: (FOR FCC CERTIFIED MODELS)

This LED LCD Monitor has been tested and found compliant with the limits for a Class B digital device, pursuant to part 15 of the FCC Rules. These limits are designed to provide proper protection against harmful interference to a residential installation. This LED LCD Monitor generates, uses, and can radiate radio frequency energy. Harmful interference to radio communication may be the result if it's not properly installed and used. However, there is no guarantee that interference will not occur in a particular installation. If this LED LCD Monitor does cause serious interference to radio or television reception, resetting may correct it. Moreover, users are encouraged to reduce interference by doing one or more of the following:

- Reorient or relocate the receiving antenna.
- Move the LED LCD Monitor and the receiver further away from each other.
- Connect the LED LCD Monitor into an outlet on a circuit different from that to which the receiver is connected.
- Consult your local dealer or a qualified technician.

FCC Warning:

To assure a continued FCC compliance, a user must use a grounded power supply cord and the provided shielded video interface cable with bonded ferrite cores. Also, any unauthorized changes or modifications to this LED LCD Monitor would void the user's authority to operate this device.

Note: If necessary, shielded interface cables and AC power cord must be used to meet the emission level limits.

Shielded cables must be used with this unit to ensure compliance with the Class B FCC limits.



According to WEEE regulation, this LED LCD Monitor can't be handled as normal trash in Europe when it is out of usage. Please refer to the recycle information on Planar's website to handle it.

For more information on how to recycle your product, please visit <http://www.planar.com/about/green/>

COMMUNIQUE D'AVERTISSEMENT DE LA FCC CONCERNANT LES INTERFERENCE DE FREQUENCE RADIO: (SEULEMENT POUR MODELES CERTIFIE PAR LA FCC)

Ce moniteur a été testé et a été trouvé conforme aux limites pour un appareil numérique de Class B, suivant la partie 15 des règlements de la FCC. Ces limites ont été développées pour offrir une protection satisfaisante contre les interférences nuisibles dans une installation résidentielle. Ce moniteur génère, utilise et peut radier de l'énergie de fréquence radio. Ceci peut causer des interférences nuisibles à des communication radio si l'appareil n'est pas convenablement installé et utilisé. Il n'y a néanmoins aucune garantie que des interférences n'apparaîtront pas dans une installation particulière. Si ce moniteur cause de sérieuses interférences à la réception de signaux radios ou télévisées, une possibilité est de réinitialiser le moniteur. Les usagers sont aussi encouragés à corriger les interférences en appliquant une ou plusieurs des démarches suivantes:

- Réorientez ou déplacez l'antenne de réception.
- Placez le moniteur et le récepteur plus loin l'un de l'autre.
- Connectez le moniteur à une prise différente de celle à laquelle le récepteur est connecté.
- Consultez votre revendeur local ou un technicien qualifié.

Avertissement de la FCC:

Pour assurer une conformité continue au règlements de la FCC, l'utilisateur doit utiliser un cordon d'alimentation mis à terre et le câble d'interface vidéo protégé avec noyaux en ferrite, fourni avec l'appareil. Chaque modification ou changement non-autorisé appliqué à ce moniteur peut faire perdre à l'utilisateur son droit d'opération de cet appareil.

Note: Si nécessaire, des câbles d'interface protégés et un cordon d'alimentation alternante doivent être utilisés pour être conforme aux limites d'émission.

Des câbles blindés doivent être utilisés avec cet appareil pour assurer la conformité aux limites FCC Class B.

Unpacking Instructions

- Remove the LED LCD Monitor out of the package and take off EPE Foam.
- Remove stand and base from EPE Foam and attach to base.
- Adjust the display between -5° and 15°.

Safety Precautions

Follow all warnings, precautions and maintenance as recommended in this user's manual to maximize the life of your unit.

DO :

- Turn off the product before cleaning.
- Surface may be cleaned using a soft clean cloth moistened with mild window glass commercial cleaners or 50/50 mixture of water and isopropyl alcohol.
- Use a soft cloth moistened with mild detergent to clean the display housing.
- Disconnect the power plug from AC outlet if the product is not going to be used for an extended period of time.

Don't :

- Do not touch the LED display screen surface with sharp or hard objects.
- Do not use abrasive cleaners, waxes or solvents for your cleaning.
- Do not operate the product under the following conditions:
 - Over 16 hours per day.
 - Extremely hot, cold or humid environment.
 - Areas susceptible to excessive dust and dirt.
 - Near any appliance generating a strong magnetic field.
 - In direct sunlight.
- If smoke, abnormal noise or odor emits from your LED LCD Monitor, remove the power cord immediately and call your service center.
- Never remove the rear cover of your LED LCD Monitor. The display unit inside contains high-voltage parts and may cause electric shock.
- Never try to repair your LED LCD Monitor yourself. Always call your service center or a qualified technician to fix it.
- Due to safety concerns, if the VESA mounting kit is purchased separately, please make sure the mounting kit is UL-listed, and replaceable only by service personnel.

Consignes de sécurité

Respectez tous les avertissements, les précautions et conseils d'entretien recommandés dans ce manuel de l'utilisateur pour maximiser la durée de vie de votre appareil.

A faire:

- Éteindre le produit avant de le nettoyer.
- La surface de l'écran tactile peut être nettoyée avec un chiffon doux et propre imprégné d'un nettoyant doux du commerce pour vitres ou d'un mélange à 50/50 d'alcool isopropylique et d'eau.
- Utilisez un chiffon doux imprégné d'un détergeant doux pour nettoyer le carter de l'affichage.
- Débranchez la fiche d'alimentation de la prise de courant secteur si le produit ne doit pas être utilisé pendant une période prolongée.

A ne pas faire:

- Ne touchez pas la surface de l'écran LED avec des objets coupants ou durs.
- N'utilisez pas des produits de nettoyage abrasifs, de la cire ou des solvants pour le nettoyage.
- N'utilisez pas le produit dans les conditions suivantes:
 - Plus de 16 heures par jour.
 - Environnement extrêmement chaud, froid ou humide.
 - Endroits poussiéreux ou sales.
 - Près d'appareils générant un fort champ magnétique.
 - Sous la lumière directe du soleil.
- Si de la fumée, un bruit anormal ou une odeur s'échappait de votre moniteur LCD LED, débranchez immédiatement le cordon d'alimentation et appelez votre centre de réparation.
- Ne retirez jamais le couvercle arrière de votre moniteur LCD LED. L'unité d'affichage contient des éléments où circule un voltage élevé et présentant un risque d'électrocution.
- N'essayez jamais de réparer vous-même votre moniteur LCD LED. Faites toujours appel à votre centre de service ou à un technicien qualifié pour toute réparation.
- Pour des raisons de sécurité, is vous achetez séparément le kit de fixation VESA, assurez-vous que celui-ci est certifié UL, et qu'il peut être remplacé uniquement par un technicien qualifié.

Package Overview

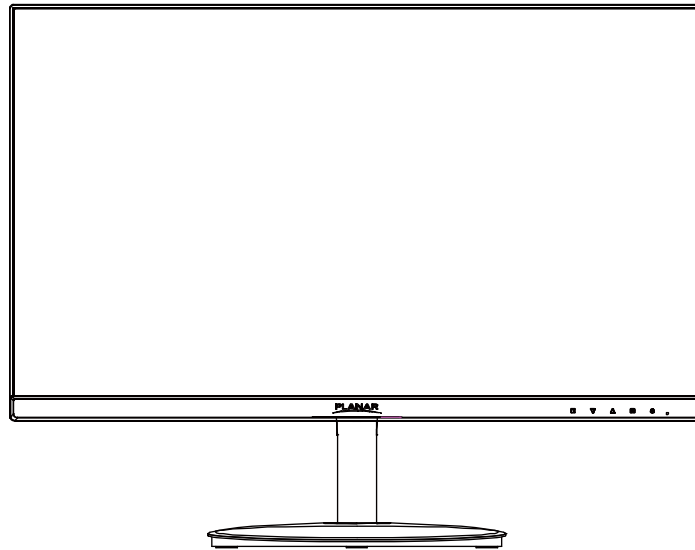

LED LCD Monitor

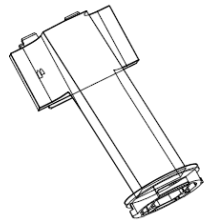

Stand

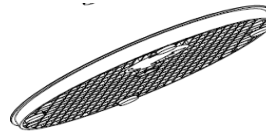

Base

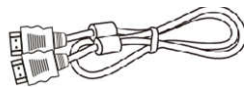

HDMI Cable

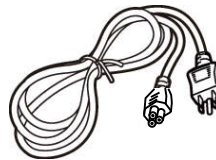

Power Cord



User's Guide

First Setup

Install the Stand Base

1. Lay the LED LCD Monitor flat on a table with the LED screen face down. To prevent the LED LCD Monitor from being scratched, put a piece of soft cloth on the table on which the screen will be set.
2. Insert Stand into the monitor, then secure Base to Stand by turning clockwise, as shown below.
3. Stand the LED LCD Monitor up

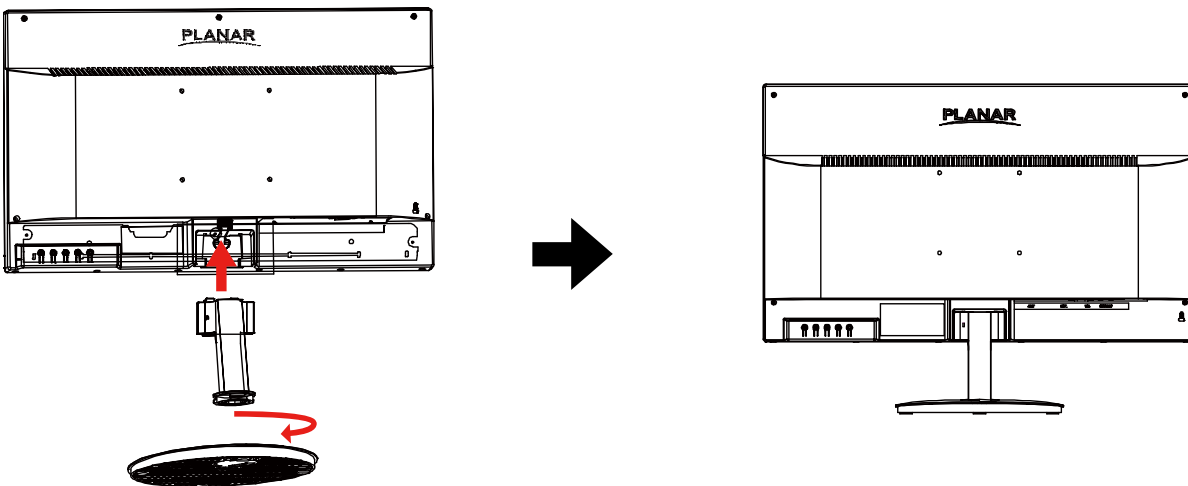

Disconnecting the Stand Base

1. Lay the LED LCD Monitor flat on a table with the LED screen face down. To prevent the LED LCD Monitor from being scratched, put a piece of soft cloth on the table on which the screen will be set.
2. Press the release button and pull away the monitor to remove the stand from the monitor.
3. Pull the release lever and turn counter-clockwise to remove base from stand.

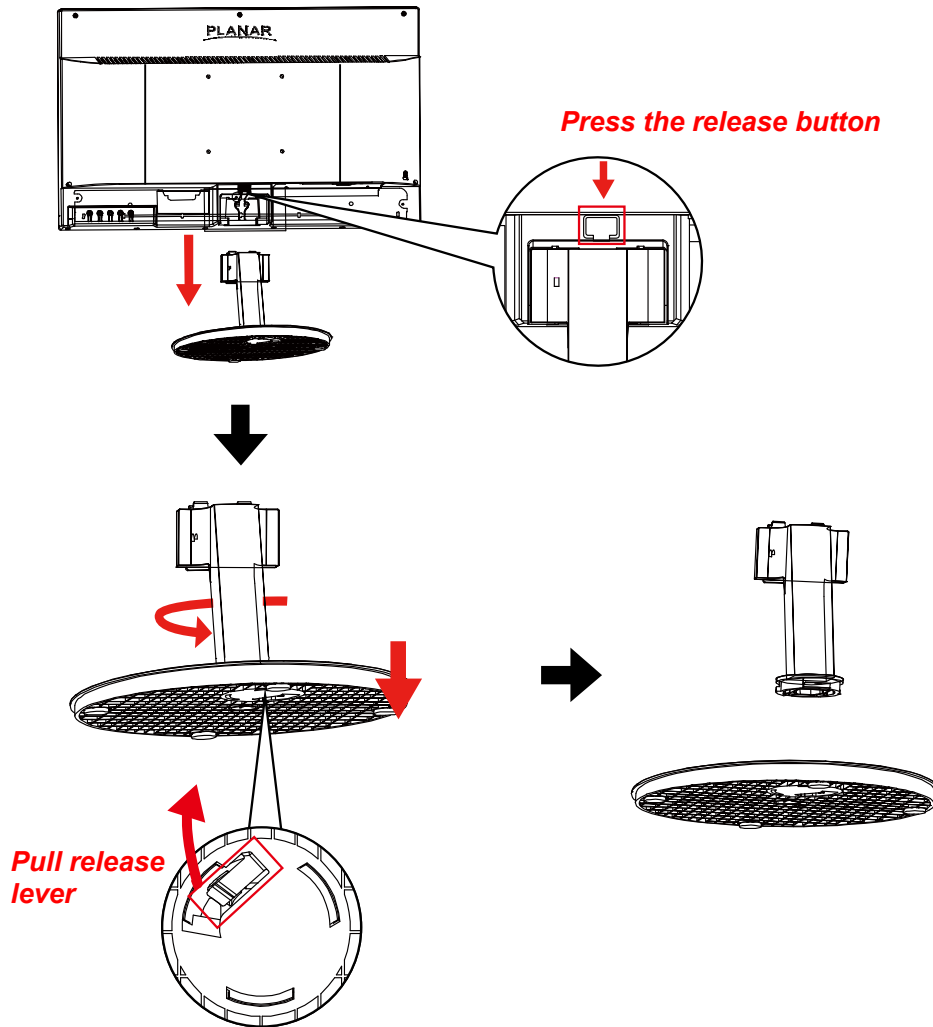

Front View of the Product

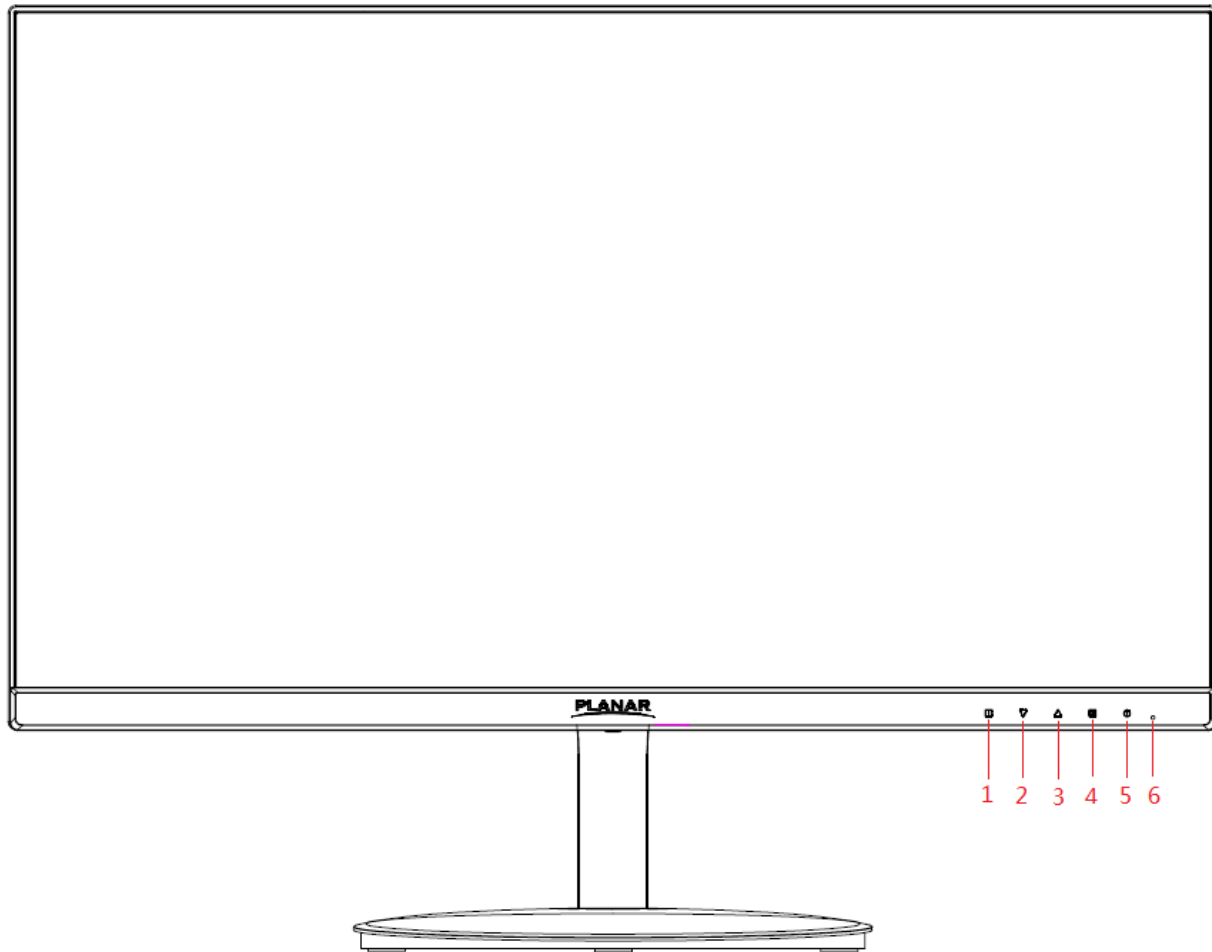

1	Menu / Exit
2	Brightness / Down
3	Blue Light Reducer / Up
4	Input select / Enter
5	Power On / Off
6	LED Indicator

*Hot keys Instructions please see "Basic Operation" on page10.

Rear View of the Product

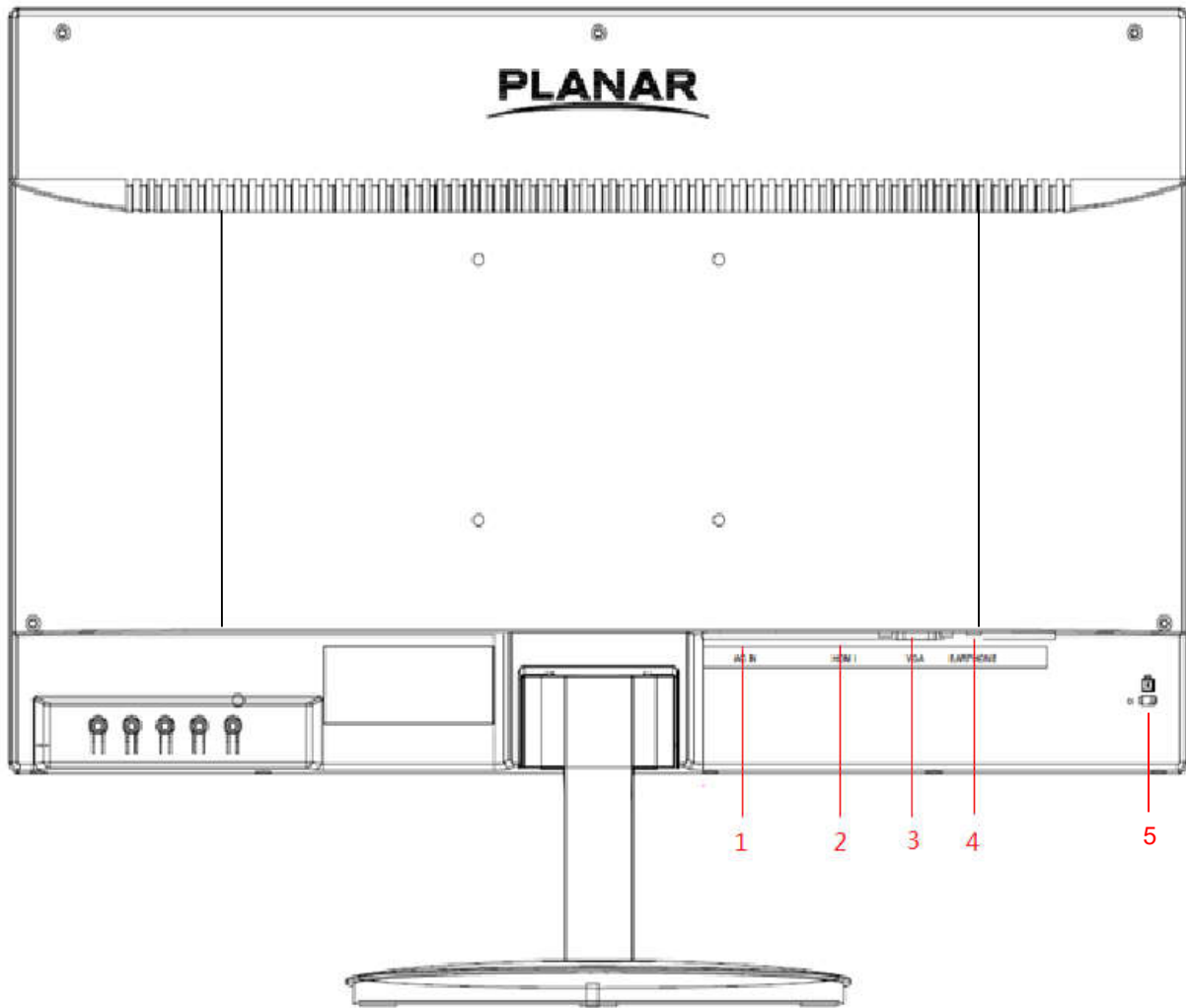

1	Power Input (AC input)
2	HDMI Input (HDMI 19 pin)
3	VGA Input (VGA 15 pin)
4	Audio Output (EARPHONE)
5	Kensington Lock

Quick Installation

1. Connect either HDMI or VGA Video Source from the monitor to the computer. Make sure both monitor and computer are powered OFF. Please note the monitor ships with an HDMI cable only.
2. Connect the power cord to a properly grounded AC outlet, then to the monitor.
3. Power-ON computer and then POWER-ON the monitor.
4. Set the timing mode on your computer. Recommended resolution and refresh rate is 1920x 1080@60Hz.

Figure 1:

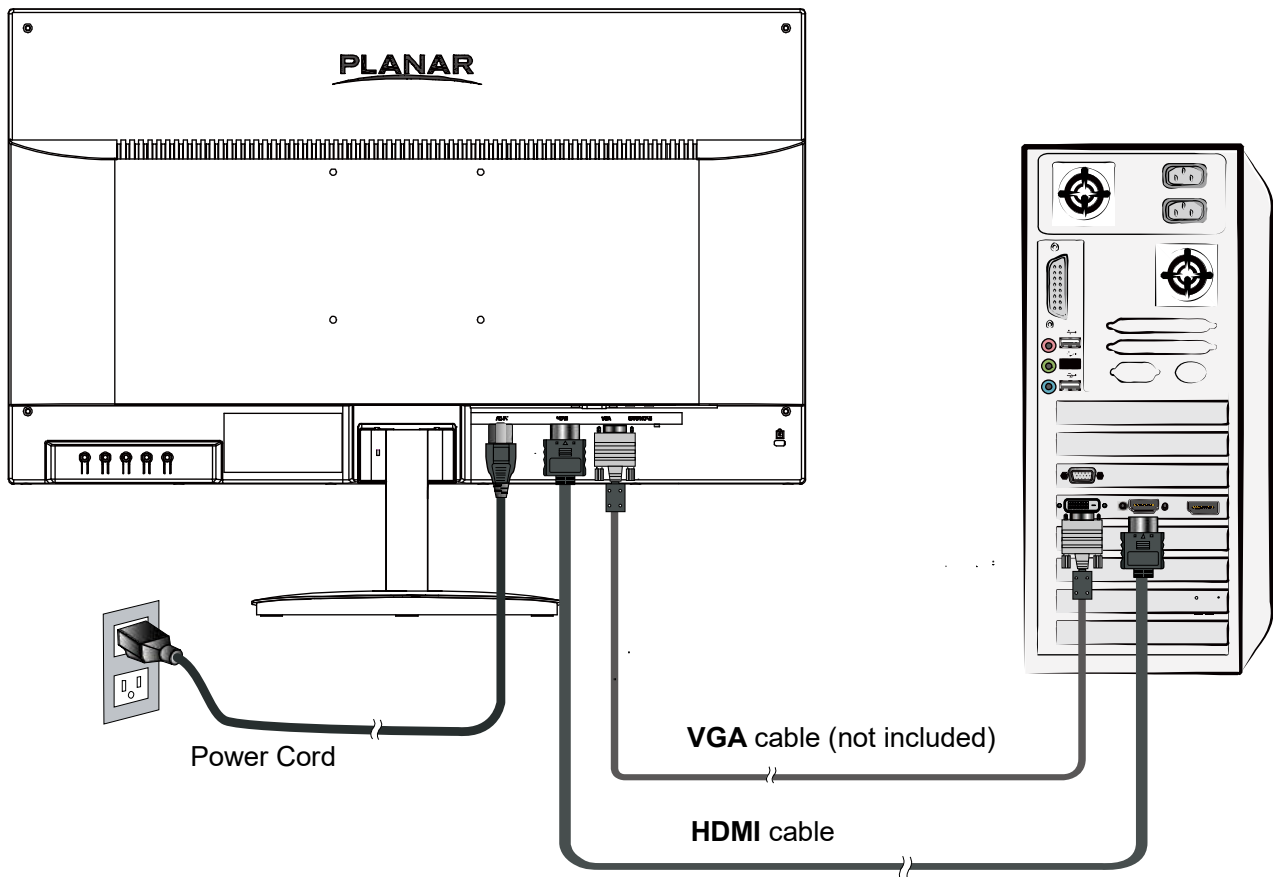

Basic Operation

Before using the LED LCD Monitor:

- Connect external equipment properly.
- Insert the power plug, and the power LED indicator will light orange.





Power On/Off

To turn the LED LCD Monitor on/off:

Press  button on the front. The power LED indicator light will be blue when the LED LCD Monitor is on.

Using the OSD Menu

Use OSD menus to adjust settings by using the menu button on the front of the LED LCD Monitor.

	Displays main menu
	Exits from OSD menu
	Selects between VGA or HDMI
	Select the desired item when in OSD menu
	When not in OSD menu, directly enters Brightness Menu
	Select the desired item when in OSD menu
	When not in OSD menu, directly enters Blue Light Reducer Menu

OSD lock out Function

When LED LCD Monitor is on and the OSD menu is not activated, the “Lock Out” function can be enabled.

Option 1: OSD lock-all 4 buttons are locked except the “POWER” button.

Press and hold the button  for 5 seconds to lock the OSD buttons.

The LED LCD Monitor will show an “OSD locked” message for 5 seconds and the message will disappear automatically.

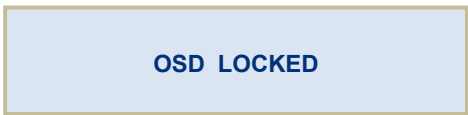

Repeat this step to unlock.

Option 2: OSD & Power button lock-all 5 buttons including the “POWER” button are locked.

Press and hold the  button for 5 seconds to lock all 5 buttons.

The LED LCD Monitor will show a “Power button locked” message for 5 seconds and the Message will disappear automatically.

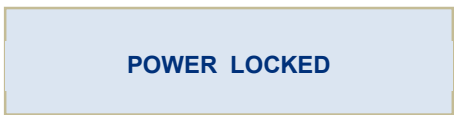

Repeat this step to unlock.

OSD Menu

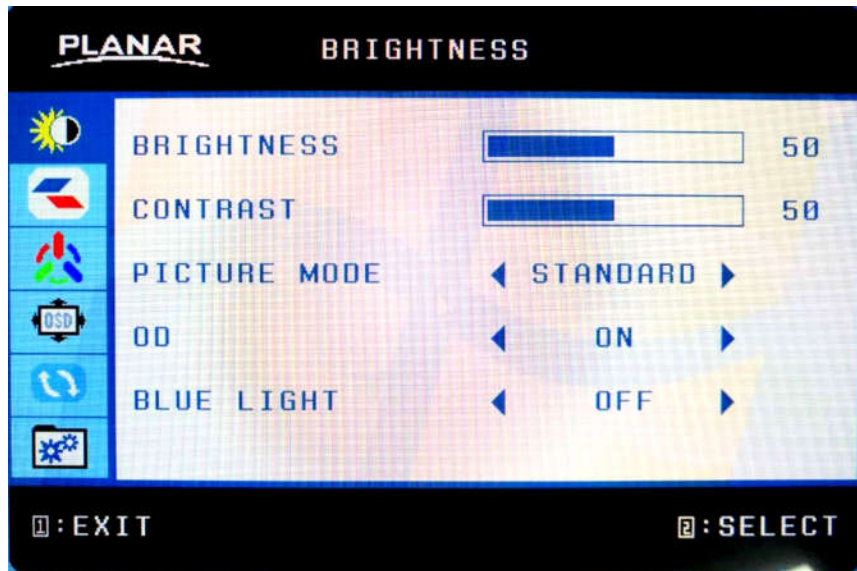

BRIGHTNESS

- **BRIGHTNESS: Adjust backlight levels**
Adjust between 0-100.
- **CONTRAST: Adjust contrast levels**
Adjust between 0-100.
- **PICTURE MODE : Select from preset modes**
Standard, Movie, Game, Text.
- **OD: Turn Overdrive on or off**
ON/OFF.
- **BLUE LIGHT: Reduces blue light**
OFF: Video (15% reduction), Web Browsing (30% reduction), Reading (50% reduction), Low Light(70% reduction).



IMAGE

- **ASPECT : Select aspect ratio**
Wide, 4:3.

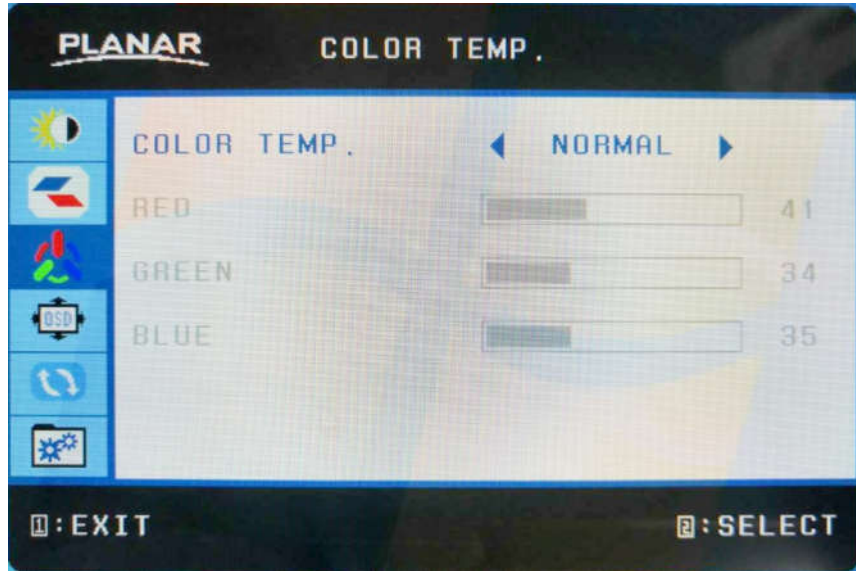

COLOR TEMP

- **COLOR TEMP : Choose color temperature**
User, Warm, Normal, Cool
Under USER, the following colors can be adjusted
- **R: Red**
0-100
- **G : Green**
0-100
- **B : Blue**
0-100

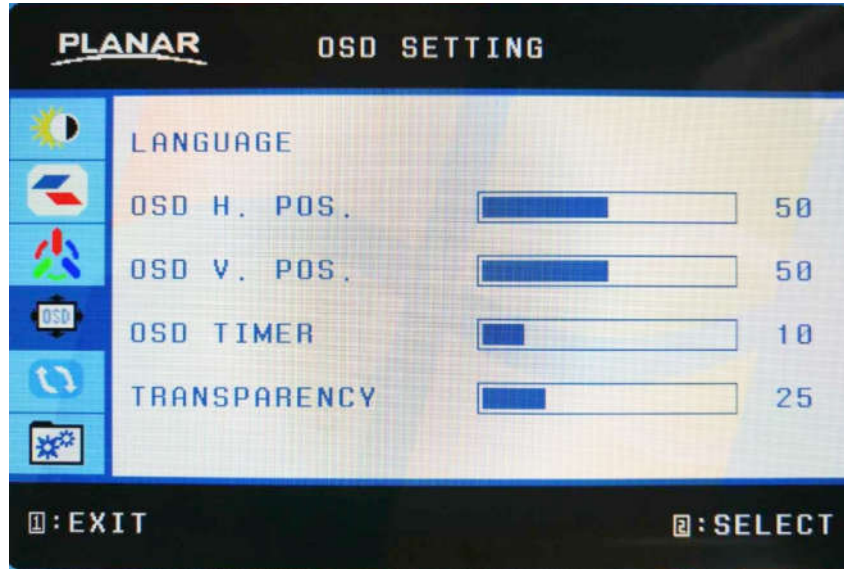

OSD SETTING

- **LANGUAGE** : Choose language
English, French, German, Italian, Spanish, Russian
- **OSD H. POS** : Adjust horizontal position of OSD
0~100
- **OSD V. POS** : Adjust vertical position of OSD
0~100
- **OSD TIMER** : Adjust OSD time out
0~60
- **TRANSPARENCY**: Adjust OSD transparency
0~100

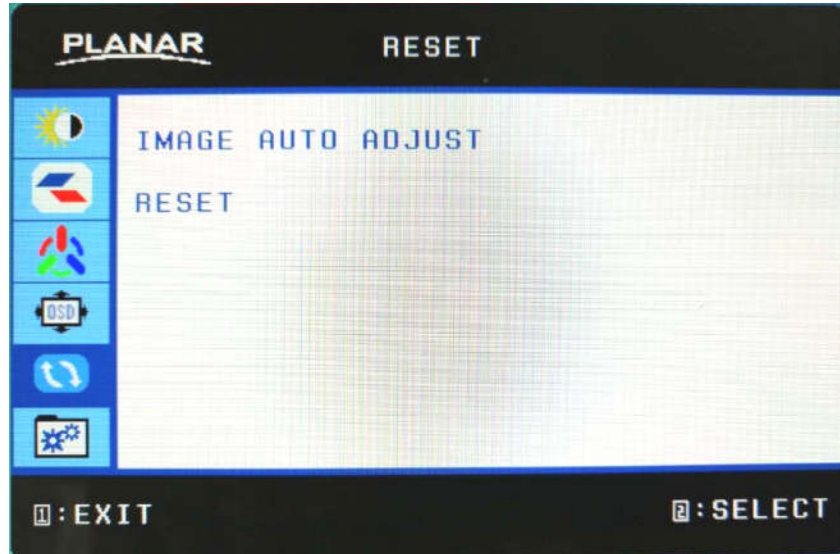

RESET

- **IMAGE AUTO ADJUST:** Adjust display automatically
(Only available in VGA input).
- **RESET :** Reset to factory default

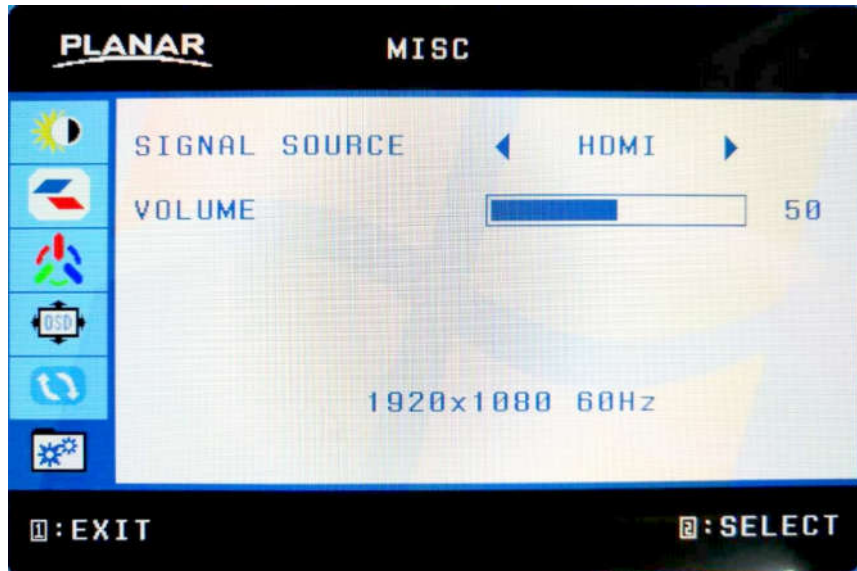

MISC

- **SIGNAL SOURCE** : Select Input source
HDMI, VGA
- **VOLUME** : Adjusts volume of earphone
0-100

Supporting Timing Modes

STANDARD	RESOLUTION
VGA	640 x 480 @ 60Hz
MAC	640 x 480 @ 67Hz
VESA	800 x 600 @ 56Hz
VESA	800 x 600 @ 60Hz
VESA	800 x 600 @ 72Hz
VESA	800 x 600 @ 75Hz
MAC	832 x 624 @ 75Hz
VESA	1024 x 768 @ 60Hz
VESA	1024 x 768 @ 70Hz
VESA	1024 x 768 @ 75Hz
VESA	1280 x 720 @ 60Hz
VESA	1280 x 800 @ 60Hz
VESA	1280 x 1024 @ 60Hz
VESA	1280 x 1024 @ 75Hz
VESA	1440 x 900 @ 60Hz
VESA	1440 x 900 @ 75Hz
VESA	1680 x 1050 @ 60Hz
VESA	1920 x 1080 @ 60Hz

Note:

HDMI supports 480i, 480p, 576i, 576p, 720p, 1080i, and 1080p.

Warning 1.: The equipment is only suitable for mounting at heights ≤ 2 m.

Attention 1.: L'équipement est seulement adapté pour le montage à des hauteurs ≤ 2 m

Technical Information

Panel	23.8" TFT (with LED backlight)	
Power Management	Normal	On: 22 Watts (typical), 24 Watts (maximum)
	Standby Mode: < 0.5Watt Off: < 0.5 Watt	
Displayable Resolution	FHD 1920x1080 max	
Pixel Dimension	0.2745(H)x0.2745(V)mm	
Display Color	16.7M	
Tilt	-5° ~ 15°	
Active Display Area	527.04mm x 296.46mm	
Temperature	Operating: 5° ~ +40°	
	Storage: -20° ~ +60°	
Compliance	FCC-B ,CE, UL/CUL	
Power	AC 110V~240V	

Wall-Mount Installation Instructions

Attaching The Optional Wall Mount Arm (not supplied)

Follow these steps to finish installing the wall mounting arm:

1. Place the wall mounting arm onto the back of the LED LCD Monitor.
Line up the holes of the arm with the holes in the back of the monitor.
2. Insert the 4 screws into the holes and tighten.
3. Reconnect the cables. Refer to the User's Guide that came with the optional wall mounting arm for instructions on attaching it to the wall.

NOTE

100 mmx100 mm VESA high hole (n=4), M4, pitch =0.7 mm screw mounting kit not included.

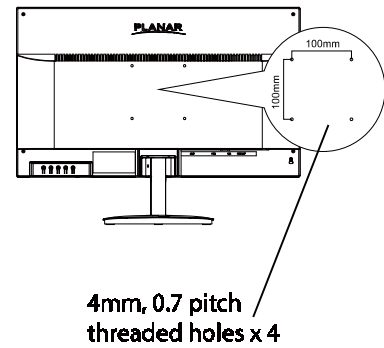

Care and Maintenance

Care

- Avoid exposing your LED LCD monitor directly to sunlight or other heat source. Place your LED LCD monitor away from the sun to reduce glare.
- Put your LED LCD monitor in a well ventilated area.
- Do not place any heavy things on top of your LED LCD monitor.
- Make certain your LED LCD monitor is installed in a clean and moisture-free area.
- Keep your LED LCD monitor away from magnets, motors, transformers, speakers and TV sets.

Note

- Move the LED out of the package and take off the plastic bag and Polystyrene Foam.
- Pull the base from Parallel versus Panel to Vertical.
- Adjust the Panel within -5° leaning forward and 15° leaning backward.

Safety Tips

- If smoke, abnormal noise or odor came out from your LED LCD monitor, caution you should remove the power cord immediately and call your service center.
- Si de fumée, un bruit anormal ou une odeur s'échappait de votre moniteur, débranchez immédiatement le cordon d'alimentation et appelez votre centre de service.
- Never remove the rear cover of your LED LCD monitor cabinet. The display unit inside contains high-voltage parts and may cause electric shock to human bodies.
- Never try to repair your LED LCD monitor yourself. Always call your service center or a qualified technician to fix it.

Troubleshooting

No power

- Make sure A/C power cord is securely connected to the power adapter and the power supply if firmly connected to the LED LCD Monitor.
- Plug another electrical device into the power outlet to verify that the outlet is supplying proper voltage.
- Make sure all signal cables are installed.

Power on but no screen image

- Make sure the video cable supplied with the LED LCD Monitor is tightly secured to the video output port on back of the computer. If not, tightly secure it.
- Adjust brightness.

Wrong or abnormal colors

- If any colors (red, green, blue) are missing, check the video cable to make sure it is securely connected. Loose or broken pins in the cable connector could cause an improper connection.
- Connect the LED LCD Monitor to another computer.

Planar Support

Cables and Accessories

To find cables and accessories for your Planar monitor, touch screen or other Planar products visit our online store at www.PlanarOnline.com.

Technical Support

Visit Planar at <http://www.planar.com/support> for operations manuals, touchscreen drivers, warranty information and access to Planar's Technical Library for online trouble shooting. To speak with Planar Customer Support please have your model and serial number available and dial:

Planar Support

Tel: 1-866-PLANAR1 (866-752-6271) or + 1 503-748-5799 outside the US.

Hours: 24 hours a day, 7 days a week.

Toll or long distance charges may apply.

Planar Systems, Inc.

Customer Service

24x7 Online Technical Support: <http://www.planar.com/support>

1195 NE Compton Drive, Hillsboro, OR 97006

Tel: 1-866-PLANAR1 (866-752-6271), or + 1 503-748-5799 outside the United States,

Hours: 24 hours a day, 7 days a week

©2019 Planar Systems, Inc.

Planar is a registered trademark of Planar Systems, Inc. Other brands and names are the property of their respective owners. Technical information in this document is subject to change without notice.