

Panasonic[®]

Operating Instructions

DAB-FM Radio

Model No. **RF-D100BT**

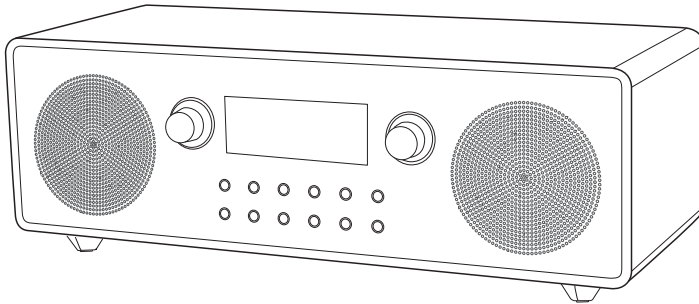





Thank you for purchasing this product.
For optimum performance and safety, please read these instructions carefully.
Please keep this manual for future reference.

"EB" indicates the United Kingdom model.

Unless otherwise indicated, illustrations in these operating instructions are of model for Australia and New Zealand. Your system and the illustrations can look differently.

The symbols on this product (including the accessories) represent the following:

	AC
	DC
	Class II equipment (The construction of the product is double-insulated.)
	ON
	Standby

Safety precautions

WARNING!

Unit

- To reduce the risk of fire, electric shock or product damage,
 - Do not expose this unit to rain, moisture, dripping or splashing.
 - Do not place objects filled with liquids, such as vases, on this unit.
 - Use the recommended accessories.
 - Do not remove covers.
 - Do not repair this unit by yourself. Refer servicing to qualified service personnel.

CAUTION!

Unit

- Do not place sources of naked flames, such as lighted candles, on this unit.
- This unit may receive radio interference caused by mobile telephones during use. If such interference occurs, please increase separation between this unit and the mobile telephone.
- The speakers do not have magnetic shielding. Do not put them near PCs or other equipment easily influenced by magnetism.

AC mains lead

- The mains plug is the disconnecting device. Install this unit so that the mains plug can be unplugged from the socket outlet immediately.

Battery

- Danger of explosion if battery is incorrectly replaced. Replace only with the type recommended by the manufacturer.
- When disposing of the batteries, please contact your local authorities or dealer and ask for the correct method of disposal.
- Do not heat or expose to flame.
- Do not leave the battery(ies) in a car exposed to direct sunlight for a long period of time with doors and windows closed.
- Do not break open or short-circuit the battery.
- Do not charge the alkaline or manganese battery.
- Do not use the battery if the cover has peeled off.
- Remove the battery if you do not use the unit for a long period of time or if the unit is to be powered exclusively by AC power. Keep in a cool, dark area.

Small objects

- The [- VOLUME +] and [TUNE/MENU SELECT] knob can come off when pulled hard. To prevent children from swallowing, do not pull it off.

Table of contents

Safety precautions	2
Sales and Support Information	3
Supplied accessories	3
References	3
Overview of controls	4
Power sources	5
Getting started	6
DAB/DAB+	6
FM radio	7
Bluetooth®	7
External music device	8
System settings	8
Troubleshooting	10
Maintenance	10
Specifications	11

Sales and Support Information

For the United Kingdom and Ireland

Customer Communications Centre

- For customers within the UK: 0344 844 3899
- For customers within Ireland: 01 289 8333
- Monday – Friday 9:00am – 5:00pm (Excluding public holidays).
- For further support on your product, please visit our website: www.panasonic.co.uk

Direct Sales at Panasonic UK

- Order accessory and consumable items for your product with ease and confidence by phoning our Customer Communications Centre Monday – Friday 9:00am – 5:00pm (Excluding public holidays).
- Or go on line through our Internet Accessory ordering application at www.pas-europe.com.
- Most major credit and debit cards accepted.
- All enquiries transactions and distribution facilities are provided directly by Panasonic UK.
- It couldn't be simpler!
- Also available through our Internet is direct shopping for a wide range of finished products. Take a browse on our website for further details.

Supplied accessories

Check and identify the supplied accessories.

1 AC adaptor

For the United Kingdom and Ireland
(TPBPA813)



For Continental Europe
(TPBPA812)



For Australia and New Zealand
(TPBPA814)



Note:

Product numbers correct as of April 2018. These may be subject to change.

References

About Bluetooth®

Panasonic bears no responsibility for data and/or information that is compromised during a wireless transmission.

Frequency band

- This system uses the 2.4 GHz frequency band.

Certification

- This system conforms to the frequency restrictions and has received certification based on frequency laws. Thus, a wireless permit is not necessary.
- The actions below are punishable by law in some countries:
 - Taking apart or modifying the unit.
 - Removing specification indications.

Restrictions of use

- Wireless transmission and/or usage with all Bluetooth® equipped devices is not guaranteed.
- All devices must conform to standards set by the Bluetooth SIG, Inc.
- Depending on the specifications and settings of a device, it can fail to connect or some operations can be different.
- This system supports Bluetooth® security features. But depending on the operating environment and/or settings, this security is possibly not sufficient. Transmit data wirelessly to this system with caution.
- This system cannot transmit data to a Bluetooth® device.

Range of use

- Use this device at a maximum range of 10 m.
- The range can decrease depending on the environment, obstacles or interference.

Interference from other devices

- This system may not function properly and troubles such as noise and sound jumps may arise due to radio wave interference if this unit is located too close to other Bluetooth® devices or the devices that use the 2.4 GHz band.
- This system may not function properly if radio waves from a nearby broadcasting station, etc. is too strong.

Intended usage

- This system is for normal, general use only.
- Do not use this system near an equipment or in an environment that is sensitive to radio frequency interference (example: airports, hospitals, laboratories, etc.).

Licenses

The Bluetooth® word mark and logos are registered trademarks owned by the Bluetooth SIG, Inc. and any use of such marks by Panasonic Corporation is under license. Other trademarks and trade names are those of their respective owners.

Overview of controls

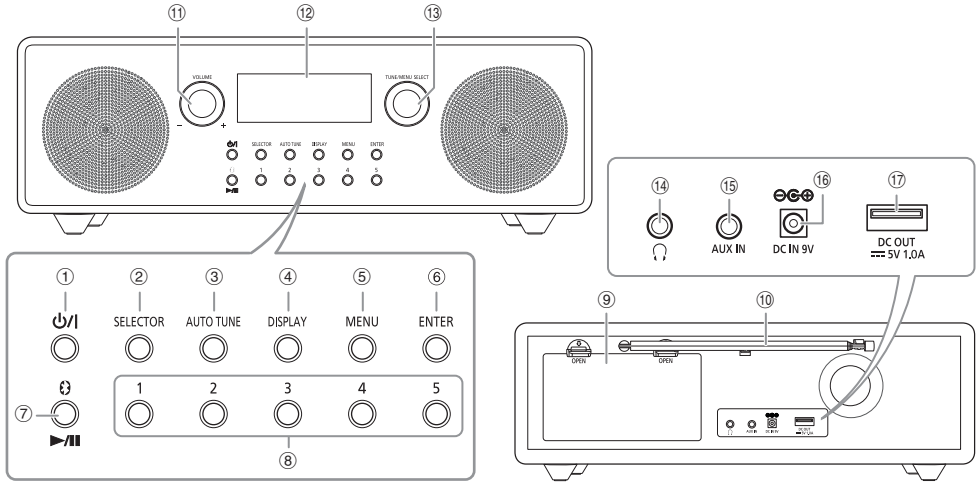

- ① **Standby/on switch** [⏻/⏻]
Press to switch the unit from on to standby mode or vice versa. In standby mode, the unit is still consuming a small amount of power.
- ② **Select the audio source**

DAB → FM → Bluetooth → AUX
- ③ Auto tuning for FM stations
- ④ View available information
- ⑤ View available menu
- ⑥ Confirm an option
- ⑦ **Select “Bluetooth” as the audio source**
During Bluetooth® source playback, press to pause or resume the playback.
- ⑧ Direct preset buttons
- ⑨ Battery compartment (⇒ 5)
- ⑩ **Antenna**
Extend the antenna, adjust the length, angle and direction for best reception.
- ⑪ Adjust the volume level
- ⑫ Display panel
- ⑬ Select desired frequency in manual tuning
View available options
- ⑭ **Headphones jack** (⌀)
Plug type: Ø 3.5 mm stereo (not supplied)
Excessive sound pressure from earphones and headphones can cause hearing loss.
Listening at full volume for long periods may damage the user's ears.
- ⑮ AUX IN jack (⇒ 8)
- ⑯ DC IN terminal (⇒ 5)
- ⑰ **For Australia and New Zealand**
USB port (⇒ 5)

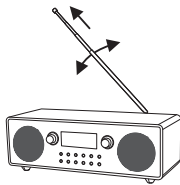

Signal strength indicator

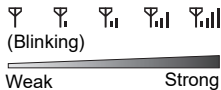

Power sources

Using the household mains socket

Connect the AC adaptor firmly to the unit and the household mains socket.

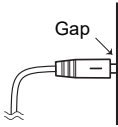
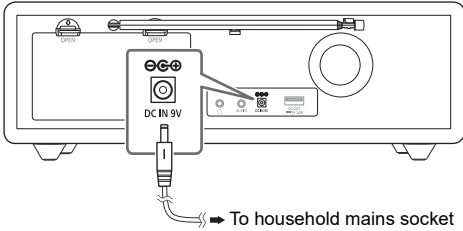

When the DC IN plug is fully inserted, there will be a gap between the plug and the panel, there is no problem using the unit.

Note:

- Do not use any other AC adaptors except the supplied one.
- The unit is in the standby condition when the AC adaptor is connected. The primary circuit is always "live" as long as the AC adaptor is connected to an electrical outlet.

Charging a portable device

For Australia and New Zealand

The USB port at the rear of the unit can be used to charge a portable device.

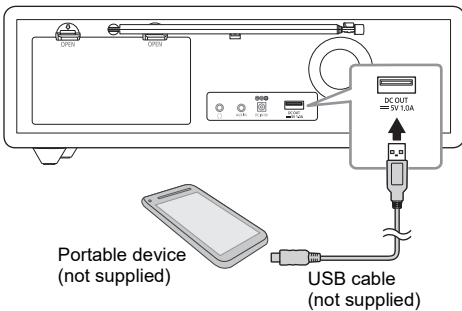

Note:

- You can charge the portable device only when the unit is connected to the household mains socket, either switched on or in standby mode.
- Some devices cannot be charged as the maximum USB charging current is 1.0 A only.
- Depending on the type and placement of the portable device that is connected to the USB port, you may notice a degradation in radio signal reception.

Using the batteries (not supplied)

Use alkaline or manganese batteries.

Install the batteries so that the poles (+ and -) align with those in the unit.

This unit will use the batteries as the power source when you disconnect the AC adaptor. The battery indicator will light up.

The battery indicator shows the battery levels.

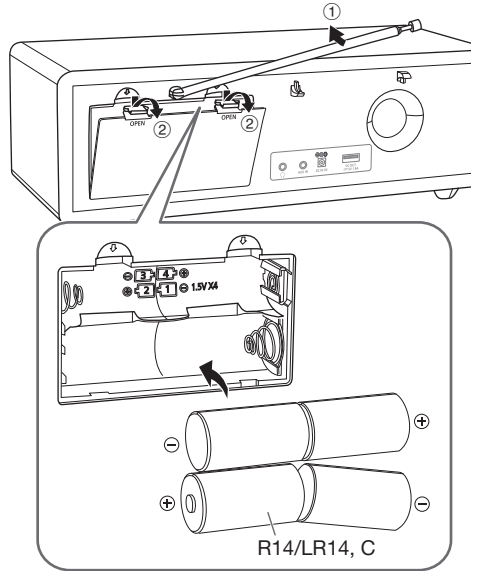
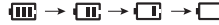

Caution!

Be careful when adjusting the antenna or in handling the unit, always keep the antenna away from your face to avoid an injury.

Note:

When the battery indicator "⚡" begins flashing, replace all 4 of the batteries.

Getting started

- 1 Extend the antenna.
- 2 Press [**⏻/1**] to switch on the unit.

The first time you switch on the unit, it will enter DAB mode and automatically scan for stations. It sets the time and date (if data is available) and starts playing the first station it finds.



Number of stations found

Note:

In standby mode, the unit shows the time and date (only when the unit is powered by AC).

DAB/DAB+

DAB (Digital Audio Broadcasting) is a procedure of broadcasting the radio digitally. It gives less interference and better sound quality.

This unit supports DAB in "BAND III" bands.

DAB operation

The first time you enter DAB mode, or if the station list is empty, the unit will start the full scan and memorise the stations.

You can perform the full scan procedure when there is a new station or a station becomes available.

- 1 Press [**SELECTOR**] to select "DAB".
- 2 Press [**MENU**] to select "Full scan" and then press [**ENTER**] to start full scan.
To cancel, press [**MENU**].

Remove unavailable listed stations

This unit indicates those stations that are closed or no longer available with a question mark in front of the station name. You can remove these stations from the station list.

- 1 Press [**MENU**] and then turn [**TUNE/MENU SELECT**] to select "Prune".
- 2 Press [**ENTER**].
- 3 Turn [**TUNE/MENU SELECT**] to select "Yes" and then press [**ENTER**].
To cancel, select "No".



Listening to a station

- 1 Turn [**TUNE/MENU SELECT**] to select a station from the station list.
- 2 Press [**ENTER**] to tune to the selected station.

Note:

"**☐**" indicates a secondary service station. Secondary service stations are always listed next to their primary station in the station list.

Presetting stations

You can preset up to 5 stations into the direct preset buttons.

- 1 While listening to a station, press and hold the desired direct preset button ([1] to [5]).
Example: press and hold [2] to store current station into preset 2.



- 2 Press [**ENTER**] to preset the station.

Listening to a preset station

Press the direct preset button ([1] to [5]) to listen to the preset station.

Manual tuning

You can perform manual tuning to a particular channel or frequency. This can be useful when you are adjusting the antenna to achieve the best possible reception and scanning a particular channel to update the station list.

- 1 Press [**MENU**].
- 2 Turn [**TUNE/MENU SELECT**] to select "Manual tune" and then press [**ENTER**].
- 3 Turn [**TUNE/MENU SELECT**] to select a frequency or channel and then press [**ENTER**].
The display shows the received signal strength of the selected frequency. Adjust the antenna to achieve the best reception.



Threshold indicator

Adjust the antenna so that the received signal strength (solid rectangles) exceeds the threshold indicator.

Viewing available information

You can view various information about the DAB broadcast such as dynamic label information (if available), signal strength, program type, ensemble name, channel number, bit rate, DAB variant and date.

Press [**DISPLAY**] to view the available information.
Press and hold [**DISPLAY**] to show the default display.

FM radio

- 1 Press [SELECTOR] to select "FM".
- 2 Press [AUTO TUNE] to tune to a station.

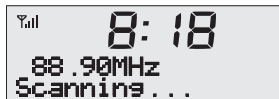

The unit stops tuning when it finds a station.
Press [AUTO TUNE] again to tune to the next station.

Manual tuning

Turn [TUNE/MENU SELECT] to tune to the required station.

Presetting stations

You can preset up to 5 stations into the direct preset buttons.

These direct preset buttons are preset with a default frequency for your convenience.

- 1 While listening to a station, press and hold the desired direct preset button ([1] to [5]).
- 2 Press [ENTER] to preset the station.

■ Listening to a preset station

Press the direct preset button ([1] to [5]) to listen to the preset station.

Viewing available information

This unit can show the text data transmitted by the radio data system (RDS) available in some areas, such as radio text, programme service, programme type and date.

Press [DISPLAY].

Note:
RDS may not be available if reception is poor.

Bluetooth®

You can connect and play an audio device wirelessly through Bluetooth®.

Preparation

- Switch on the unit.
- Switch on the Bluetooth® feature of the device and put the device near the system.
- Read the operating instructions of the device for details.

Pairing a device

Preparation

If this system is connected to a Bluetooth® device, disconnect it (⇒ 8).

- 1 Press and hold [⊗].
If "Pairing" is shown, continue with step 5.
- 2 Press [MENU].
- 3 Turn [TUNE/MENU SELECT] to select "Pairing" and then press [ENTER].
- 4 Turn [TUNE/MENU SELECT] to select "Yes" and then press [ENTER].
"Pairing" is shown.
To cancel, select "No".
- 5 Select "RF-D100BT" from the Bluetooth® menu of the device.
If prompted for a passkey, input "0000" or "1234".
The device connects with this system automatically after pairing is complete.
The MAC address (example: 6C:5A:B5:B3:1D:0F) may be shown before "RF-D100BT" is shown.

Note:
You can pair up to 8 devices with this system. If a 9th device is paired, the device that has not been used for the longest time will be replaced.

Connecting a device

Preparation

If this system is connected to a Bluetooth® device, disconnect it (⇒ 8).

- 1 Press [⊗].
"Bluetooth Ready" is shown.
- 2 Select "RF-D100BT" from the Bluetooth® menu of the device.
- 3 Start playback on the device.
Press [▶/||] to pause or resume the playback.

Note:
• A device must be paired to connect.
• This system can only connect to one device at a time.
• When "Bluetooth" is selected as the source, this system will automatically try to connect to the last connected device.

Disconnecting a device

While a Bluetooth® device is connected

- 1 Press [MENU].
- 2 Turn [TUNE/MENU SELECT] to select “Disconnect” and then press [ENTER].
- 3 Turn [TUNE/MENU SELECT] to select “Yes” and then press [ENTER].
“Bluetooth Ready” is shown.
To cancel, select “No”.

Alternatively, press and hold [] until “Pairing” is shown to disconnect the device.

External music device

You can play music from an external music device.

Preparation

- Switch off the equaliser (if any) of the external music device to prevent sound distortion.
- Decrease the volume of the system before you connect or disconnect the external music device.

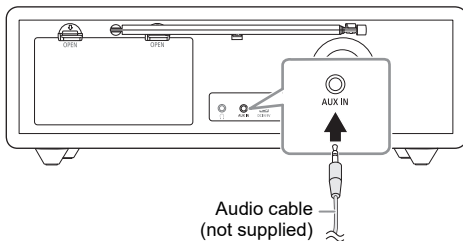

- 1 **Connect the external music device using an audio cable (not supplied).**
Plug type: Ø 3.5 mm stereo
- 2 Press [SELECTOR] repeatedly to select “AUX”.
- 3 Play the external music device.

To adjust the input level

- 1 Press [MENU].
- 2 Turn [TUNE/MENU SELECT] to select “Input level” and then press [ENTER].
- 3 Turn [TUNE/MENU SELECT] to select “Normal” or “High” and then press [ENTER].

Note:

- The default setting is “Normal”.
- Select “Normal” if the sound is distorted during “High” input level.
- Read the operating instructions of the external music device for details.

System settings

To view the System menu

When in DAB, Bluetooth or AUX mode

- 1 Press [MENU].
- 2 Turn [TUNE/MENU SELECT] to select “System” and then press [ENTER].

When in FM mode

Press [MENU].

To navigate around the menu

Turn [TUNE/MENU SELECT] to select an item or option. Press [ENTER] to confirm.

Example: Backlight setting displays



Indicates current setting

Alarm

The Alarm Wizard is shown.

• Alarm: Alarm Off, Alarm On

Select “Alarm On” to switch on the alarm.

• **On time:** Set the hours and minutes of start time.

• **Snooze: Snooze On, Snooze Off**
Select “Snooze On” to switch on the snooze function. Snooze interval is 5 minutes.

• Source: Buzzer, DAB, FM

Set the audio source.

If FM or DAB is set, select the last station you tuned in to (“Last listened”) or a preset station as the audio source.

• Set the volume

The alarm starts at a low volume and increases gradually to the preset level.

“☺” is shown after you set the alarm.

Stop the alarm

Press and hold [ENTER] to stop the alarm.

“Alarm Off” is shown.

Snooze function

Press any button or turn any knob to put the alarm into snooze mode.

The unit will switch into standby mode and the “☺” indicator blinks slowly.

Press [/|] to switch on the unit will also stop the snooze mode.

Note:

- The alarm does not work when the unit is powered by batteries.
- Check that the date and time are set correctly, or else the alarm may not work as desired.
- The alarm will come on at the set time every day for a duration of 59 minutes.
- You need to set the alarm again every time you disconnect and connect the AC power or after you replace the batteries.

Kitchen timer	<p>The kitchen timer is a convenient countdown timer. Set the desired duration. You can set up to 99 minutes.</p> <p>"△" is shown after you set the timer. To cancel, select "Off".</p> <p>Note:</p> <ul style="list-style-type: none"> The countdown is shown on the display for 10 seconds. To view the remaining time, select "Kitchen timer" and then press [ENTER], or press [DISPLAY] in standby mode.
Sleep	<p>The sleep timer switches off the unit after the set time (in minutes).</p> <p>Sleep off, 30 minutes, 60 minutes, 90 minutes, 120 minutes</p> <p>"SLEEP" is shown after you set the timer. To cancel, select "Sleep off".</p>
Equaliser	<p>Heavy, Soft, Clear, Vocal, Flat</p> <p>"EQ" is shown after you select the effect. To cancel, select "Flat".</p>
Time	<p>The time and date information are updated automatically with the DAB/RDS broadcast (if available). You can also set the time and date manually with the Time menu. This is a 24 hour clock.</p> <ul style="list-style-type: none"> Set time: Set the hours and minutes. Set date: Set the day, month and year.
Dimmer	<ul style="list-style-type: none"> Off: Switches off the function. Dimmer 1: Decrease the brightness of the backlight. Dimmer 2: Further decrease the brightness of the backlight.
Backlight	<ul style="list-style-type: none"> On: The backlight is always on. 10 sec: The backlight switches off after 10 seconds of inactivity.
Language	<p>You can change the language for the display panel.</p> <p>English, Français, Deutsch, Italiano</p>
Auto Power Off (Bluetooth and AUX mode only)	<ul style="list-style-type: none"> On: The unit automatically switches off when you do not use it for approximately 20 minutes. Off <p>Note: This function does not work when you are in radio source.</p>
Factory Reset	<p>No, Yes</p> <p>Select "Yes" to reset the unit to factory default setting.</p>

Troubleshooting

General

Sound is distorted or no sound.

- Adjust the volume.
- Check and adjust the antenna.
- Move the unit to another location and do a full scan again.
- An AC mains lead or fluorescent light is near the cables. Keep other appliances and cords away from the cables of this unit.
- The batteries are weak. Replace them with new ones.

Reception is poor or beat sound is heard.

- Keep the antenna away from computers, TVs, other cables and cords. Move mobile telephones away from the unit if the interference is apparent.

Bluetooth®

Pairing cannot be done.

- Check the Bluetooth® device condition.
- The device is out of the 10 m communication range. Move the device nearer to the system.

The device cannot be connected.

- The pairing of the device was unsuccessful. Do pairing again.
- The pairing of the device has been replaced. Do pairing again.
- This unit might be connected to a different device. Disconnect the other device and try connecting the device again.

The device is connected but audio cannot be heard through the system.

- For some built-in Bluetooth® devices, you have to set the audio output to "RF-D100BT" manually. Read the operating instructions of the device for details.

Sound from the device is interrupted.

- The device is out of the 10 m communication range. Move the device nearer to the system.
- Remove any obstacle between the system and the device.
- Other devices that use the 2.4 GHz frequency band (wireless router, microwaves, cordless phones, etc.) are interfering. Move the device nearer to the system and distance it from the other devices.

Messages

"Alarm Not saved"

- The changes made to the alarm was not saved, the changes will be lost.

"No DAB Station"

- No DAB station available.
- Check the antenna.
- Move the unit to another location and do a full scan again.

"Service not available"

- No DAB reception.

"Time Not saved"

- The changes made to the time was not saved, the changes will be lost.

"USB Overcurrent Remove Device"

- The USB device is using too much power. Disconnect the USB device, switch off the unit and then switch on again.

Maintenance

Disconnect the AC adaptor before maintenance.

Clean this system with a soft, dry cloth.

- Never use alcohol, paint thinner or benzine to clean this system.
- Before using chemically treated cloth, read the instructions that came with the cloth carefully.

Specifications

Power supply

AC adaptor
 Input AC 100 V to 240 V, 50/60 Hz
 Output

For Australia and New Zealand DC 9 V, 2.5 A

For others DC 9 V, 2 A

Main unit

Input
For Australia and New Zealand DC 9 V, 2.5 A
For others DC 9 V, 2 A

Battery DC 6 V (4 x R14/LR14)

Power consumption in standby mode

With "Dimmer" set to "Off" 0.9 W (approximate)

Battery life

(Operate at 100mW with backlight off)

Power source	Manganese R14 battery	Alkaline LR14 battery
Bluetooth®	Approx. 3 H	Approx. 8 H
FM/DAB	Approx. 3 H	Approx. 8 H

Dimensions (W x H x D) 317 mm x 110 mm x 141 mm

Mass

With batteries 2.3 kg

Without batteries 2.1 kg

AC adaptor 0.2 kg

Operating temperature range 0°C to +40°C

Operating humidity range
 20% to 80% RH (no condensation)

RMS output power stereo mode (both ch driven)

Front ch 5 W per channel (6 Ω), 1 kHz, 10% THD

Total RMS stereo mode power 10 W

RMS output power (battery operation)

Front ch 2.5 W per channel (6 Ω), 1 kHz

Total RMS stereo mode power 5 W

Terminals

AUX IN Stereo, 3.5 mm jack

Headphones jack Stereo, 3.5 mm jack

For Australia and New Zealand

USB port power DC OUT 5 V 1 A

Tuner

Preset memory FM 5 stations

Frequency modulation (FM)

Frequency range
 87.50 MHz to 108.00 MHz (50 kHz step)

DAB

DAB memories 5 channels

Frequency band (wavelength)

Band III
 5A to 13F (174.928 MHz to 239.200 MHz)

Sensitivity *BER 4x10⁻⁴

Min requirement -98 dBm

Bluetooth®

Version Bluetooth® Ver. 4.2

Class Class 2

Supported profiles A2DP, AVRCP

Operating frequency 2.4 GHz band FH-SS

Frequency band 2402 MHz to 2480 MHz

Operation distance 10 m line of sight

Maximum RF power 3 dBm

Supported codec SBC

Speaker (built-in)

Full range 6.5 cm cone type x 1/ch

Note:

Specifications are subject to change without notice. Mass and dimensions are approximate.



English

Declaration of Conformity (DoC)

Hereby, "Panasonic Corporation" declares that this product is in compliance with the essential requirements and other relevant provisions of Directive 2014/53/EU.

Customers can download a copy of the original DoC to our RE products from our DoC server:

<http://www.ptc.panasonic.eu>

Contact to Authorised Representative:

Panasonic Marketing Europe GmbH, Panasonic Testing Centre, Winsbergring 15, 22525 Hamburg, Germany

Type of wireless	Frequency band	Maximum power (dBm E.I.R.P.)
Bluetooth®	2402 – 2480 MHz	3 dBm

Ελληνικά

Δήλωση συμμόρφωσης (DoC)

Η "Panasonic Corporation" δηλώνει ότι το προϊόν αυτό είναι συμμορφωμένο προς τις βασικές απαιτήσεις και άλλες σχετικές διατάξεις της Οδηγίας 2014/53/ΕΕ.

Οι πελάτες μπορούν να κατεβάσουν ένα αντίγραφο του πρωτοτύπου DoC για τα RE προϊόντα μας από τον DoC server μας:

<http://www.ptc.panasonic.eu>

Επικοινωνήστε με τον Εξουσιοδοτημένο Αντιπροσωπτό μας:

Panasonic Marketing Europe GmbH, Panasonic Testing Centre, Winsbergring 15, 22525 Hamburg, Γερμανία

Τύπο ασύρματης	Ζώνη συχνοτήτων	Μέγιστη ισχύς (dBm e.i.r.p.)
Bluetooth®	2402 – 2480 MHz	3 dBm

Português

Declaração de Conformidade (DoC)

Com o presente documento, a "Panasonic Corporation" declara que este produto se encontra em conformidade com os requisitos específicos e demais especificações referentes à Diretiva 2014/53/UE.

Os clientes podem baixar uma cópia da declaração de conformidade (DoC) para nossos produtos RE do Server DoC:

<http://www.ptc.panasonic.eu>

Contacto com um Representante Autorizado:

Panasonic Marketing Europe GmbH, Panasonic Testing Centre, Winsbergring 15, 22525 Hamburg, Alemanha

Tipo de ligação sem fios	Banda de frequência	Potência máxima (dBm e.i.r.p.)
Bluetooth®	2402 – 2480 MHz	3 dBm

Lietuviškai

Atitikties deklaracija (AD)

Bendrovė "Panasonic Corporation" patvirtina, kad šis gaminys atitinka direktyvos 2014/53/ES esminius reikalavimus ir kitas taikytinas nuostatas.

Mūsų RE gaminių originalios atitikties deklaracijos kopija klientai gali atsisiųsti iš mūsų AD serverio:

<http://www.ptc.panasonic.eu>

Įgaliojoto atstovo adresas:

Panasonic Marketing Europe GmbH, Panasonic Testing Centre, Winsbergring 15, 22525 Hamburg, Vokietija

Bevielių ryšio tinklas	Dažnių diapazonas	Maksimali siuntimo galia (dBm e.i.r.p.)
Bluetooth®	2402 – 2480 MHz	3 dBm

Slovensko

Izjava o skladnosti (DoC)

"Panasonic Corporation" v tem dokumentu izjavlja, da je izdelek v skladu z bistvenimi zahtevami in drugimi pomembnimi določbami Direktive 2014/53/EU.

Stranka lahko naloži izvod izvirnega DoC o naših izdelkih RE s strežnika DoC:

<http://www.ptc.panasonic.eu>

Naslov pooblaščenega predstavnika:

Panasonic Marketing Europe GmbH, Panasonic Testing Centre, Winsbergring 15, 22525 Hamburg, Nemčija

Vrsta brezžične povezave	Frekvenčni pas	Največja moč (dBm EIRP)
Bluetooth®	2402 – 2480 MHz	3 dBm

Slovensky

Vyhlasenie o zhode (DoC)

"Panasonic Corporation" týmto vyhlasuje, že tento výrobok je v súlade so základnými požiadavkami a ďalšími príslušnými ustanoveniami smernice 2014/53/EÚ.

Zákazníci si môžu stiahnuť kópiu pôvodného DoC na naše RE výrobky z nášho servera DoC:

<http://www.ptc.panasonic.eu>

Kontakt na splnomocneného zástupcu:

Panasonic Marketing Europe GmbH, Panasonic Testing Centre, Winsbergring 15, 22525 Hamburg, Nemecko

Typ bezdrôtového pripojenia	Frekvenčné pásmo	Maximálny výkon (dBm e.i.r.p.)
Bluetooth®	2402 – 2480 MHz	3 dBm

Español

Declaración de Conformidad (DoC)

Por la presente, "Panasonic Corporation" declara que este producto es de conformidad con los requisitos sustanciales y con las disposiciones pertinentes de la Directiva 2014/53/UE.

Los usuarios pueden descargar una copia de la declaración de conformidad original (DoC) de los productos RE del servidor DoC:

<http://www.ptc.panasonic.eu>

Contacto con el representante autorizado:

Panasonic Marketing Europe GmbH, Panasonic Testing Centre, Winsbergring 15, 22525 Hamburg, Alemania

Tipo de red inalámbrica	Banda de frecuencia	Potencia máxima (dBm p.i.r.e)
Bluetooth®	2402 – 2480 MHz	3 dBm

Eesti keel

Vastavusdeklaratsioon (DoC)

Käesolevaga kinnitab "Panasonic Corporation", et see toode vastab direktiivi 2014/53/EL olulistele nõuetele ja teistele asjakohastele sätetele.

Kliendid saavad koopia meie RE toodetele kehtiva originaalvastavusdeklaratsiooni koopia alla laadida meie DoC-serverist:

<http://www.ptc.panasonic.eu>

Võtke ühendust volitatud esindajaga:

Panasonic Marketing Europe GmbH, Panasonic Testing Centre, Winsbergring 15, 22525 Hamburg, Saksamaa

Juhtmevaba seadme tüüp	Sagedusriba	Maksimaalne võimsus (dBm EIRP)
Bluetooth®	2402 – 2480 MHz	3 dBm

Latviski

Atbilstības deklarācija (DoC)

Ar šo "Panasonic Corporation" paziņo, ka šis izstrādājums atbilst pamatprasībām un pārējiem Direktīvas 2014/53/ES noteikumiem.

Pircēji var lejupielādēt oriģinālo DoC kopiju mūsu RE izstrādājumos no mūsu DoC servera:

<http://www.ptc.panasonic.eu>

Lūdzam sazināties ar pilnvaroto parstāvi:

Panasonic Marketing Europe GmbH, Panasonic Testing Centre, Winsbergring 15, 22525 Hamburg, Vācijā

Bezvadu tips	Frekvenču josla	Maksimālā jauda (dBm EIRP)
Bluetooth®	2402 – 2480 MHz	3 dBm

Български

Декларация за съответствие (DoC)

С настоящото "Panasonic Corporation" декларира, че този продукт е в съответствие с основните изисквания и други съответни разпоредби на Директива 2014/53/ЕС.

Потребителите могат да свалят копие от оригиналните DoC към нашите продукти от типа RE от сървъра, на който се съхраняват DoC:

<http://www.ptc.panasonic.eu>

Свържете се с нашия упълномощен представител:

Panasonic Marketing Europe GmbH, Panasonic Testing Centre, Winsbergring 15, 22525 Hamburg, Германия

Вид безжична връзка	Честотна лента	Максимална мощност (dBm e.i.r.p.)
Bluetooth®	2402 – 2480 MHz	3 dBm

Român

Declarație de Conformitate (DoC)

"Panasonic Corporation" declară prin prezenta că acest produs este conform cu cerințele esențiale și alte prevederi relevante ale Directivei 2014/53/UE.

Clienții pot descărca o copie a DoC-ului original al produselor noastre RE de la adresa noastră DoC din Internet:

<http://www.ptc.panasonic.eu>

Contactați Reprezentantul Autorizat:

Panasonic Marketing Europe GmbH, Panasonic Testing Centre, Winsbergring 15, 22525 Hamburg, Germania

Tip de wireless	Interval de frecvență	Putere maximă (dBm e.i.r.p.)
Bluetooth®	2402 – 2480 MHz	3 dBm

Magyar

Megfelelőségi Nyilatkozat (DoC)

Ezennel a, "Panasonic Corporation" kijelenti, hogy a jelen termék kielégíti az 2014/53/EU Irányelv létfontosságú követelményeit és más vonatkozó rendelkezéseit.

A vásárlók letölthetik az RE termékek eredeti DoC másolatát a DoC szerverünkről:

<http://www.ptc.panasonic.eu>

A hivatalos képviselő elérhetősége:

Panasonic Marketing Europe GmbH, Panasonic Testing Centre, Winsbergring 15, 22525 Hamburg, Németország

Wireless típus	Frekvenciasáv	Maximális teljesítmény (dBm e.i.r.p.)
Bluetooth®	2402 – 2480 MHz	3 dBm

Hrvatski

Deklaracija o podobnosti (DoC)

Ovime "Panasonic Corporation" izjavljuje da ovaj proizvod udovoljava osnovnim zahtjevima i ostalim relevantnim odredbama Direktive 2014/53/EU.

Kupci mogu preuzeti kopiju originalne DoC za naše RE proizvode s našeg DoC poslužitelja:

<http://www.ptc.panasonic.eu>

Adresa ovlaštenog predstavništva:

Panasonic Marketing Europe GmbH, Panasonic Testing Centre, Winsbergring 15, 22525 Hamburg, Njemačka

Vrsta bežične mreže	Frekvencijski pojas	Maksimalna snaga (dBm e.i.r.p.)
Bluetooth®	2402 – 2480 MHz	3 dBm

Česky

Deklarace shody (DoC)

"Panasonic Corporation" tímto prohlašuje, že tento výrobek splňuje základní požadavky a další relevantní ustanovení Směrnice 2014/53/EU.

Zákazníci si mohou stáhnout kopii originálu deklaráce shody (DoC) pro naše výrobky RE z našeho serveru DoC:

<http://www.ptc.panasonic.eu>

Kontakt na Autorizovaného obchodního zástupce:

Panasonic Marketing Europe GmbH, Panasonic Testing Centre, Winsbergring 15, 22525 Hamburg, Německo

Typ bezdrátového připojení	Frekvenční pásmo	Maximální výkon (dBm e.i.r.p.)
Bluetooth®	2402 – 2480 MHz	3 dBm

Panasonic Warranty

1. Subject to the conditions of this warranty Panasonic or its Authorised Service Centre will perform necessary service on the product, without charge for parts or labour, if in the opinion of Panasonic the product is found to have a manufacturing defect within one (1) year or (12 months) (the "warranty period") from the date of purchase appearing on your purchase receipt.
2. This warranty only applies to Panasonic products purchased in Australia and sold by Panasonic Australia, its Authorised Distributors, or Dealers, and only where the products are used and serviced within Australia or its territories. Warranty cover only applies to the services that are carried out by a Panasonic Authorised Service Centre and only if valid proof of purchase is presented when the warranty service is requested.
3. This warranty only applies if the product has been installed and/or used in accordance with the manufacturer's recommendations (as noted in the operating instructions) under normal use and reasonable care (in the opinion of Panasonic). The warranty does not cover damage, malfunction or failure resulting from use of incorrect voltages, incorrect installation, accident, misuse, neglect, build-up of dirt or dust, abuse, maladjustment of customer controls, mains supply problems, thunderstorm activity, infestation by insects or vermin, tampering or repair by unauthorised persons (including unauthorised alterations), exposure to abnormally corrosive conditions, or any foreign object or matter having entered the product.
4. This warranty does not cover the following items unless the fault or defect existed at the time of purchase:
 - (a) Consumable parts
 - (b) Cosmetic parts
 - (c) Worn or damaged parts
 - (d) Information stored on Hard Disk Drives, Optical Discs, USB Devices, SD Cards, Tapes
 - (e) DTV reception issues caused by TV Aerial / Cabling / Wall socket(s)
5. Some products may be supplied with Ethernet connection hardware. The warranty is limited on such products and will not cover:
 - (a) Internet and or DLNA connection / setup related problems
 - (b) Access fees and or charges incurred for internet connection
 - (c) Incompatible software or software not specifically stipulated in the product operations manual; and
 - (d) Any indirect or consequential costs associated with the incorrect use or misuse of the hardware, its connection to the internet or any other device.
6. To claim warranty service, when required, you should:
 - Contact Panasonic's Customer Care Centre on 132 600 for Service Centre information.
 - Confirm the opening and acceptance times with the Authorised Service Centre that you choose.
 - Then send or take the product to a Panasonic Authorised Service Centre together with your proof of purchase receipt.
 - Any freight and insurance costs associated with the transport of the product to and/or from your nearest Authorised Service Centre must be arranged and paid for by you.
7. The warranties hereby conferred do not extend to, and exclude, any costs associated with the installation, de-installation or re-installation of a product, including costs related to the mounting, de-mounting or remounting of any screen, (and any other ancillary activities), delivery, handling, freighting, transportation or insurance of the product or any part thereof or replacement of and do not extend to, and exclude, any damage or loss occurring by reason of, during, associated with, or related to such installation, de-installation, re-installation or transit.

Panasonic Authorised Service Centres are located in major metropolitan areas and most regional centres of Australia, however, coverage will vary dependant on product. For advice on exact Authorised Service Centre locations for your product, please telephone our Customer Care Centre on 132 600 or visit our website and use the Service Centre Locator.

In addition to your rights under this warranty, Panasonic products come with consumer guarantees that cannot be excluded under the Australian Consumer Law. If there is a major failure with the product, you can reject the product and elect to have a refund or to have the product replaced or if you wish you may elect to keep the goods and be compensated for the drop in value of the goods. You are also entitled to have the product repaired or replaced if the product fails to be of acceptable quality and the failure does not amount to a major failure.

If there is a major failure in regard to the product which cannot be remedied then you must notify us within a reasonable period by contacting the Panasonic Customer Care Centre. If the failure in the product is not a major failure then Panasonic may choose to repair or replace the product and will do so in a reasonable period of time from receiving notice from you.

**THIS WARRANTY CARD AND THE PURCHASE DOCKET (OR SIMILAR PROOF OF PURCHASE)
SHOULD BE RETAINED BY THE CUSTOMER AT ALL TIMES**

If you require assistance regarding warranty conditions or any other enquiries, please visit the **Panasonic Australia** website www.panasonic.com.au or contact by phone on **132 600**
If phoning in, please ensure you have your operating instructions available.

Panasonic Australia Pty. Limited

ACN 001 592 187 ABN 83 001 592 187
1 Innovation Road, Macquarie Park NSW 2113
www.panasonic.com.au

Disposal of Old Equipment and Batteries
Only for European Union and countries with recycling systems



These symbols on the products, packaging, and/or accompanying documents mean that used electrical and electronic products and batteries must not be mixed with general household waste.

For proper treatment, recovery and recycling of old products and used batteries, please take them to applicable collection points in accordance with your national legislation.

By disposing of them correctly, you will help to save valuable resources and prevent any potential negative effects on human health and the environment.

For more information about collection and recycling, please contact your local municipality.

Penalties may be applicable for incorrect disposal of this waste, in accordance with national legislation.



Note for the battery symbol (bottom symbol):

This symbol might be used in combination with a chemical symbol. In this case it complies with the requirement set by the Directive for the chemical involved.

Manufactured by: Panasonic Corporation
Kadoma, Osaka, Japan
Importer for Europe: Panasonic Marketing Europe GmbH
Panasonic Testing Centre
Winsbergring 15, 22525 Hamburg, Germany



Panasonic Corporation
Web Site: <http://www.panasonic.com>



YOM200181-0001

TQBJ2141
L0418CH3058