

CyberPower®

USER'S MANUAL

PFC SINEWAVE SERIES

OR1000PFCRT2U/OR1500PFCRT2U/
OR2200PFCRT2U

IMPORTANT SAFETY INSTRUCTIONS

This manual contains important instructions. Please read and follow all instructions carefully during installation and operation of the unit. Read this manual thoroughly before attempting to unpack, install, or operate the UPS.

CAUTION! To prevent the risk of fire or electric shock, install in a temperature and humidity controlled indoor area free of conductive contaminants. (Please see specifications for acceptable temperature and humidity range).

CAUTION! For pluggable equipment, the socket-outlet shall be installed near the equipment and shall be easily accessible.

CAUTION! To reduce the risk of electric shock, do not remove the cover except to service the battery. Ensure the input power is removed before servicing the batteries. There are no user serviceable parts inside except for the battery.

CAUTION! Hazardous live parts inside can be energized by the battery even when the AC input power is disconnected.

CAUTION! The UPS must be connected to an AC power outlet with fuse or circuit breaker protection. Do not plug into an outlet that is not grounded. If you need to de-energize this equipment, turn off and unplug the unit.

CAUTION! To avoid electric shock, turn off the unit and unplug it from the AC power source before servicing the battery or installing a computer component.

CAUTION! To reduce the risk of fire, connect only to a circuit provided with 20 amperes maximum branch circuit over current protection in accordance with the National Electric Code, ANSI/NFPA 70.

CAUTION! The UPS is suitable for use in a computer room as defined in the Standard for the Protection of Electronic Computer/Data Processing Equipment, ANSI/NFPA 75.

CAUTION! The EPO function is provided in UPS. EPO remote switch which is Push-Back button is installed computer room outside by a phone line and not connected any other equipment.

CAUTION! DO NOT USE FOR MEDICAL OR LIFE SUPPORT EQUIPMENT! Under no circumstances this unit should be used for medical applications involving life support equipment and/or patient care.

CAUTION! DO NOT USE WITH OR NEAR AQUARIUMS! To reduce the risk of fire, do not use with or near aquariums. Condensation from the aquarium can come in contact with metal electrical contacts and cause the machine to short out.

CAUTION! DO NOT USE WITH LASER PRINTERS! The power demands of laser printers are too large for a UPS.

CAUTION! DO NOT INSTALL THE UPS WHERE IT WOULD BE EXPOSED TO DIRECT SUNLIGHT OR NEAR A STRONG HEAT SOURCE!

CAUTION! DO NOT BLOCK OFF VENTILATION OPENINGS AROUND THE HOUSING!

CAUTION! DO NOT CONNECT DOMESTIC APPLIANCES SUCH AS HAIR DRYERS TO UPS OUTPUT SOCKETS.

INSTALLING YOUR UPS SYSTEM

UNPACKING

The box should contain the following:

(a) UPS unit x1; (b) User manual x1; (c) USB A+B type cable x1; (d) Rackmount bracket x2; (e) Vertical stand x2; (f) Warranty registration card x1

AUTOMATIC VOLTAGE REGULATOR(AVR)

The **OR1000PFCRT2U/OR1500PFCRT2U/OR2200PFCRT2U** can stabilize inconsistent utility power. Incoming utility power fluctuations may be damaging to important data and hardware but Automatic Voltage Regulation (AVR) helps protect the computer against experiencing dangerous voltage levels. AVR automatically adjusts low or high voltages to keep equipment working at safe AC power levels (110/120V) without switching to battery. Your equipment can operate normally even during the power problems such as brownouts and blackouts. The unit's powerful sealed lead-acid batteries will provide power only if the incoming voltage drops below 90V or increases above 140V.

SYSTEM BLOCK DIAGRAM

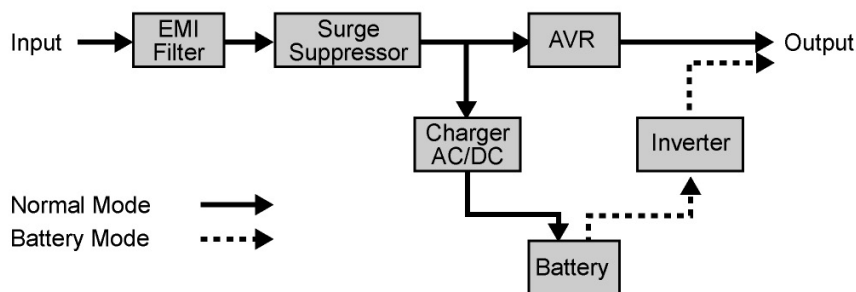

HARDWARE INSTALLATION GUIDE

1. Battery charge loss may occur during shipping and storage. The first time the UPS is used, it is strongly recommended to charge the batteries for at least 18 hours to ensure that the batteries are at their maximum charge capacity. To recharge the batteries, simply plug the UPS into an AC outlet, the batteries will charge whether the UPS is powered on or not.
2. With the UPS off and unplugged, connect your computer, monitor, and any externally powered data storage device (Hard drive, Tape drive, etc.) into the outlets. **DO NOT plug a laser printer, copier, space heater, vacuum, paper shredder or other large electrical device into the UPS. The power demands of these devices will overload and possibly damage the unit.**
3. To protect a fax, telephone, modem line or network cable, connect the telephone or network cable from the wall jack outlet to the jack marked "IN" on the UPS. Then, connect a telephone cable or network cable from the jack marked "OUT" on the UPS to the modem, computer, telephone, fax machine, or network device.
4. Plug the UPS into a 2 pole, 3 wire grounded receptacle (wall outlet). Make sure the wall branch outlet is protected by a fuse or circuit breaker and does not service equipment with large electrical demands (e.g. air conditioner, copier, etc). The warranty prohibits the use of extension cords, outlet strips, and surge strips.

INSTALLING YOUR UPS SYSTEM (continued)

5. Press the power switch to turn the UPS on. The Power-On indicator light will illuminate. If an overload is detected, an audible alarm will sound and the UPS will emit one long beep. In order to reset it, turn the unit off and unplug some equipment from outlets. Make sure the total load of the equipment connected to the UPS is within the unit's safe range, (refer to the technical specifications), and then turn the unit on.
6. To maintain an optimal battery charge, leave the UPS plugged into an AC outlet at all times.
7. Before storing the UPS for an extended period of time, turn the unit OFF. Then cover it and store it with the batteries fully charged. Recharge the batteries every three months or so, to ensure good battery capacity and long battery life; further, this might also prevent damage to the unit from an unlikely battery leakage.
8. The unit provides one Serial port and one USB port to allow connection and communication between the unit and any attached computers. The Serial Port as well as its paired USB port allow for bi-directional communication among the UPS and the primary connected computer running the PowerPanel® Business Edition Software. The computer can monitor the UPS and alter its various programmable parameters. When there is a power failure, the computer connected to the port will start to shut down after a user controlled delay based on the settings given to the PowerPanel® Business Edition Software.

Note: If the USB port is used, the serial port will be disabled. They cannot be used simultaneously.

Note: PowerPanel® Business Edition Software is available on our website. Please visit www.cyberpowersystems.com and go to Products/Software page for free download.

9. EPO (Emergency Power Off) Port:
Follow the appropriate circuit diagram below to wire the cable to your EPO configuration. The EPO remote switch is a switch installed in an outside area, connected to the unit via an ordinary RJ-11 phone line. In case of an emergency, it can be used to immediately cut-off power from the UPS unit.

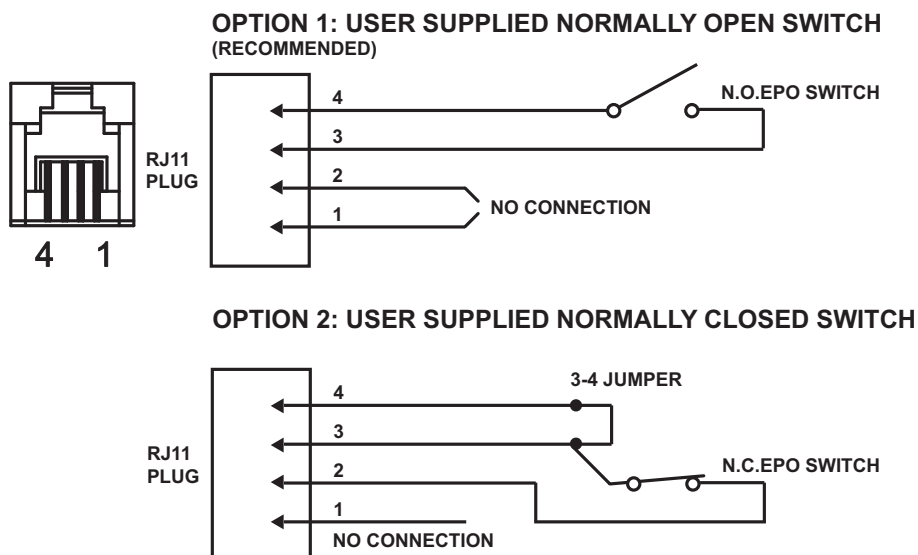

BASIC OPERATION

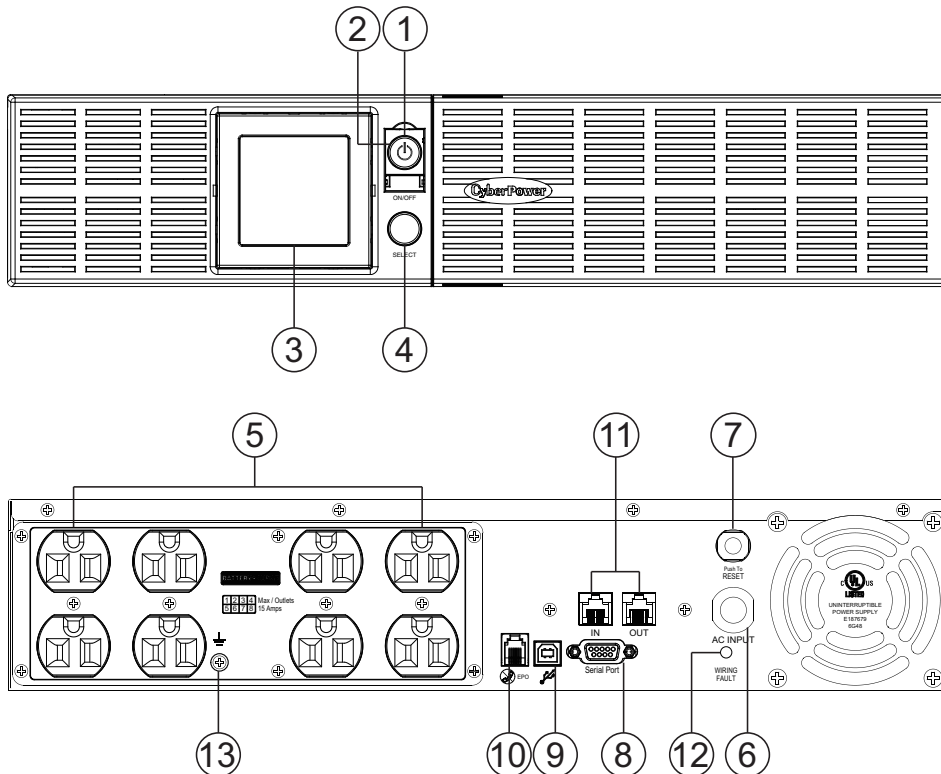

FRONT / REAR PANEL DESCRIPTION

1. Power Switch

Master on/off switch for equipment connected to the UPS.

2. Power On Indicator

An LED ring around the Power Switch indicates that the AC utility input power condition is normal and that the UPS outlets are providing power, free of surges and spikes.

3. Multifunction LCD Readout

An LCD that shows various UPS information using icons and messages.

4. Display Toggle Button

Used to select among a variety of information the LCD can display.

5. Battery Backup, Surge Protected and AVR protected Outlets

This unit provides a total of 8 outlets with battery backup and surge protection. They ensure that connected equipment will keep an uninterrupted operation over a period of time, during a power failure.

6. AC Input Power Cord

Connect the AC Power cord to a properly wired and grounded outlet.

7. Input Circuit Breaker

The circuit breaker serves to provide input overload and fault protection.

8. Serial Port

The serial port allows communication between the UPS and the computer. The UPS can control the computer's shutdown in case of an emergency, and the computer can monitor the UPS and alter its various programmable parameters.

BASIC OPERATION (continued)

9. USB port to PC

This is a connectivity port allowing communication and control between the UPS and the connected computer. You should install on your computer the PowerPanel® Business Edition software appropriate to the operating system you are using.

10. EPO (Emergency Power Off) Port

Allow for an emergency UPS Power-Off from a remote location.

11. Surge Protected Communication Ports - RJ11/RJ45

These ports are used to protect from various surge-conditions the standard RJ-45/RJ-11 based, (ADSL, LAN, Phone/Modem-Lines), cabling systems.

12. Wiring Fault Indicator (Red)

This LED indicator will illuminate to warn the user that a wiring problem exists, such as bad ground, missing ground or reversed wiring. If this is illuminated, disconnect all electrical equipments from the outlet and have an electrician verify the outlet is properly wired. The unit will not provide surge protection without being plugged into a grounded and properly wired wall outlet.

13. TVSS Screw

Use the Transient Voltage Surge Supression screw to ground the UPS.

BATTERY REPLACEMENT

Read and follow the IMPORTANT SAFETY INSTRUCTIONS before servicing the batteries: Replacement of batteries located in an OPERATOR ACCESS AREA. Contact your dealer or call the number on this manual for more information on battery replacement.

CAUTION! RISK OF EXPLOSION IF BATTERY IS REPLACED BY AN INCORRECT TYPE. DISPOSE OF USED BATTERIES ACCORDING TO THE INSTRUCTIONS.

CAUTION! When replacing batteries, replace with the same number of the following battery: CyberPower (**RB1290X2C**) for model OR1000PFCRT2U, CyberPower (**RB1270X4G**) for model OR1500PFCRT2U and CyberPower (**RB1290X4H**) for model OR2200PFCRT2U.

CAUTION! Risk of Energy Hazard, 12 V, maximum 7Ah (for OR1500PFCRT2U) or 9Ah (for the OR1000PFCRT2U and OR2200PFCRT2U) battery. Before replacing batteries, remove conductive jewelry such as chains, wrist watches, and rings. High energy conducted through these materials could cause severe burns.

CAUTION! Do not dispose of batteries in a fire. The batteries may explode. Follow all local ordinances regarding the proper disposal of batteries.

CAUTION! Do not open or mutilate batteries. Released material is harmful to the skin and eyes. It may be toxic.

Take the following precautions before replacing the battery:

1. Remove all watches, rings or other metal objects from your hands.
2. Only use tools with insulated handles.
3. DO NOT lay tools or other metal parts on top of battery or any battery terminals.
4. Wear rubber gloves and shoes.
5. Determine if the battery is grounded. If so, remove source of ground. **CAUTION: CONTACT WITH A GROUNDED BATTERY CAN RESULT IN ELECTRICAL SHOCK!** The likelihood of such a shock will be greatly reduced if such grounding is removed during installation and maintenance.

BATTERY REPLACEMENT (continued)

BATTERY REPLACEMENT PROCEDURE

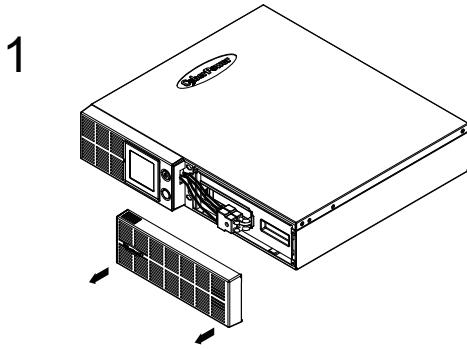

Remove the front panel on the right side.

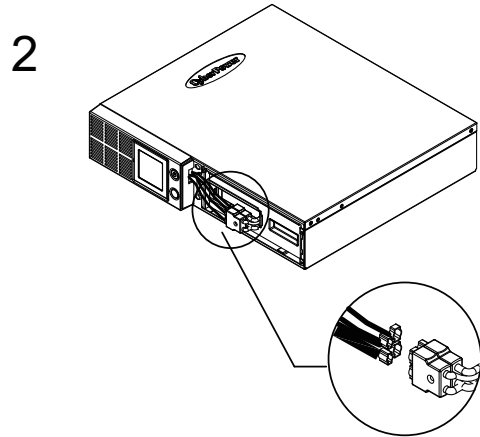

Disconnect the black wire and red wire from the battery.

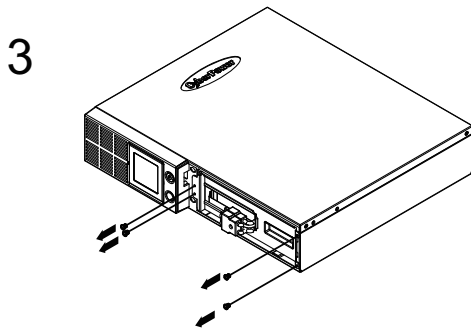

Remove the four retaining screws.

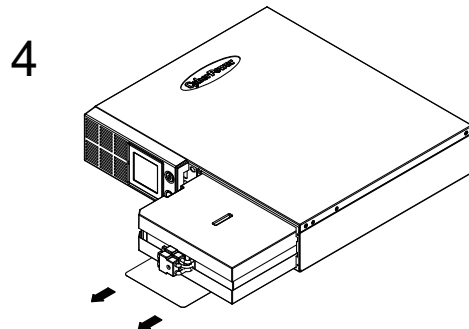

Insert the new battery pack. Assemble the screws, cable and front panel in the reverse sequence of above steps.* Recharge the unit for 18 hours to ensure the UPS performs expected runtime.

*BATTERY WIRING

Connect RED battery cable/connector to RED connector (positive to positive) on battery pack.
Connect BLACK battery cable/connector to BLACK connector (negative to negative) on battery pack.

REMINDER! The used batteries are considered hazardous waste and must be disposed through recycling. Most retailers that sell lead-acid batteries collect used batteries for recycling, as required by the local regulations.

DEFINITION FOR ILLUMINATED LCD INDICATORS

- 1. Input Voltage Meter:** This meter measures the AC voltage from the wall outlet. The INPUT voltage readout is used to identify the input voltage information. This can be used as a diagnostic tool to identify poor-quality input power. Units are listed in V (Volts).
- 2. Output Voltage Meter:** The Output Voltage screen measures, in real time, the AC voltage that the UPS is providing to your connected equipment via the UPS outlets. Units are listed in V (Volts). In the event of a complete loss of power, severe brownout, or over voltage, the UPS relies on its internal battery to back up to supply a consistent 110/120V output.

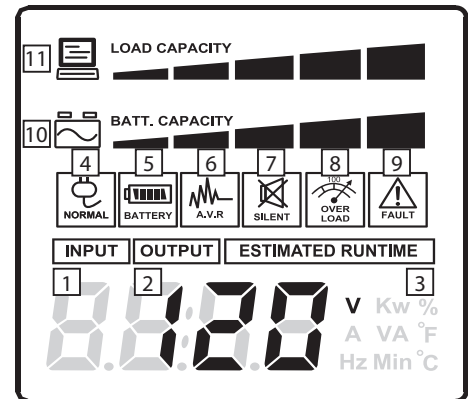

The LCD displays detailed information on the UPS status and current power conditions to alert you to potential power problems before they affect your equipment. Note! All related UPS information is based on that you should turn on the UPS.

- 3. Estimated Runtime:** The Estimated Runtime Screen displays how many minutes of runtime can be expected of the UPS if it were to experience a power outage. When runtime becomes shorted, the battery capacity will decrease. (The battery capacity bar indicator will be falling.) **Note:** The number displayed may be less than actual runtimes for low loads.
- 4. Normal Icon:** This icon illuminates when the UPS is working under normal conditions.
- 5. Battery Icon:** When there is a severe brownout or blackout, this icon will appear followed by an alarm, (two short beeps), indicating that the UPS is now working using its internal batteries. Once the batteries are running out of power, (over a period of time), the alarm will beep rapidly every 1/2 second. If this happens and main power has not been restored, it is recommended that you save your files and turn off your equipment manually as soon as possible.
- 6. Automatic Voltage Regulation (AVR) Icon:** This icon will appear when the unit is automatically regulating low or high AC input line voltage conditions, without resulting to the use of battery power. This is a normal, automatic operation of your UPS, and no action is required on your part.
- 7. Silent Mode Icon:** This icon appearing indicates that the buzzer will not be beeping while in battery operating mode. During Silent mode, the unit's alarm does not sound until the battery reaches low capacity threshold.
- 8. Overload Icon:** This icon will appear followed by an alarm, indicating that an overload condition has been reached. To recover from the overload condition, start unplugging your equipment from the UPS outlets until the icon disappears and the alarm stops.
- 9. Fault Icon:** When activated indicates there is a problem with the UPS. Please refer to *FAULT WARNING DISPLAY AND ALARM* section.
- 10. BATT. CAPACITY:** BATT. CAPACITY is shown as a bar chart; each segment indicates approximately a 20% of battery capacity.
- 11. LOAD CAPACITY:** Load CAPACITY is shown as a bar chart; each segment indicates approximately a 20% of load capacity.

LCD SETUP FUNCTIONS

1. GENERAL MODE

- a. Press the Display toggle button to check the status of the UPS status:

#	Items	Unit
1	Input Voltage	V
2	Output Voltage	V
3	Output Frequency	Hz
4	Load	Kw
5	Load Capacity	%
6	Battery Capacity	%
7	Estimated Runtime	Min

- b. If the LCD backlight turns off (enters sleeping mode), press the Display toggle button to wake it up.

2. SET-UP MODE

Step 1: Press and hold the Display toggle button for 3 seconds to enter the UPS Set-Up Mode.

Step 2: By pressing the Display toggle, users can switch between setup functions.











Step 3: Press and hold the Display toggle button for 3 seconds to choose the function you want to adjust. When the icons blink, the value of each item is changed by slightly pressing the Display toggle button.

Note: If the function you select is ESC, the UPS will return to Function Menu (Step 2) without any change.

























Step 4: To save the value and return to Function Menu, press and hold the toggle for 3 seconds.

Note: If the Display button is not touched for 30 seconds, the UPS will leave Set-up Mode and return to General Mode without changing any settings.

Programmable functions are sorted as the following table:

Functions	Options	Description
 Output Quality	Low 	Low Output Quality means UPS will go to battery mode less often and tolerate more utility power fluctuations and vice versa. <i>Note:</i> It is related to the settings of High/Low Transfer Point. The LCD shows "CUST", instead of "LInE", with capacity bar when High/Low Transfer Point is modified.
	Medium 	
	High 	
	ESC 	
	Customized 	
 High Transfer Point	136V 	It is the setting of maximum output voltage. If the utility voltage is usually high and the connected equipment can work with this condition, you can set High Transfer Point higher to avoid UPS going to battery mode too often.
	139V 	
	142V 	
	ESC 	





LCD SETUP FUNCTIONS (continued)

Functions	Options	Description
 Low Transfer Point	98V 	It is the setting of minimum output voltage. If the utility voltage is usually low and the connected equipment can work with this condition, you can set Low Transfer Point lower to avoid UPS going to battery mode too often.
	100V 	
	102V 	
	ESC 	
 Sensitivity	Low 	If the connected equipment can tolerate more power events, select Low Sensitivity. The UPS will go to battery mode less often. If the connected equipment cannot tolerate power events, select High Sensitivity. The UPS will go to battery mode more often.
	Medium 	
	High 	
	ESC 	
 Self Test	Yes 	During a Self Test, UPS will switch from line mode to battery mode to simulate the power failure conditions.
	ESC 	
 Buzzer	On 	If OFF is selected, the unit will mute all alarms except for overload condition.
	Off 	
	ESC 	
 LCD Sleeping Mode	On 	Select ON, the LCD will enter sleeping mode if the display toggle is not touched for 1 minute. To illuminate the LCD, simply press the display toggle once. When OFF is chosen, the LCD will never enter sleeping mode. Note: In Battery Mode, the LCD is always on.
	Off 	
	ESC 	
 Back to Default	Yes 	Restore the UPS factory default settings.
	ESC 	
 ESC	-	Return to General Mode.

FAULT WARNING DISPLAY AND ALARM

DURING SHUTDOWN

The following table shows each corresponding warning message on LCD display and the alarm reacts during the machine shutdown (output-off):

LCD Warning Display	Alarm	Condition	Solution
	Constant tone	Overload in line mode.	Turn the UPS off, unplug at least one piece of equipment from battery outlets, wait 10 seconds, reset the circuit breaker and turn the unit on.
	Constant tone	Overload in battery mode.	Turn the UPS off, unplug at least one piece of equipment from battery outlets, wait 10 seconds, reset the circuit breaker and turn the unit on.
	Rapid Beep (30 seconds)	Battery missing in line mode.	Turn the UPS off. Check battery wiring and the presence of the battery. Press the Display toggle button to stop the alarm.
	Beep twice every 30 seconds	Utility Failure. The UPS is in battery mode.	Wait for the recovery of utility or try other AC power source. Pressing the Display toggle button for 2 seconds can enter silent mode.
	Rapid Beep (every 1/2 second)	Utility Failure. The UPS is in battery mode and will run out of power shortly.	Recharge the battery.

AFTER SHUTDOWN

The following table shows the information about the error codes on LCD display after the machine shutdown (output-off). The LCD will show the message till the UPS runs out of battery.

ERROR TYPE	ERROR CODE		POSSIBLE CAUSE
Line Mode Error	E01	Battery Overcharge	Charger broke down
System Error	E21	Output Short	UPS/connected devices short circuit
			Output voltage detector broke down
	E22	Output Overload	Too many connected devices

The Error code appears with Fault icon and a constant tone. Slightly press the Display toggle button once, the constant beep will be cancelled.

To solve the problems, please refer to *TROUBLESHOOTING* section or contact CyberPower Systems at tech@cpsww.com for further help and support.

CYBERPOWER GREENPOWER UPS™ TECHNOLOGY

Advanced Energy-Saving Patented Bypass Technology

CyberPower's patented GreenPower UPS™ with Bypass Technology are ENERGY STAR complainant ensuring lower power consumption and energy costs compared to conventional UPS models. Even when utility power is normal, conventional UPS models constantly pass power through a transformer. By contrast, under normal conditions the advanced circuitry of a GreenPower UPS™ bypasses the transformer. As a result, the power efficiency is significantly increased while decreasing waste heat, using less energy, and reducing energy costs.



When an abnormal power condition occurs, the GreenPower UPS™ automatically runs power through its transformer to regulate voltage and provide "safe" power. Since utility power is normal over 88% of the time, the GreenPower UPS™ operates primarily in its efficient bypass mode.

The GreenPower UPS™ is also manufactured in accordance with the Restriction on Hazardous Substances (RoHS) directive making it one of the most environmentally-friendly on the market today.

TECHNICAL SPECIFICATIONS

MODEL	OR1000PFCRT2U	OR1500PFCRT2U	OR2200PFCRT2U
INPUT			
Nominal Input Voltage	120Vac		
Input Voltage Range	88Vac – 139Vac		
Input Adjustable Voltage Range	86Vac – 142Vac		
Input Frequency Range	60Hz +/- 3Hz		
Input Plug Type	NEMA 5-15P		NEMA 5-20P
OUTPUT			
Output Capacity	1000VA / 700W	1500VA / 1050W	2000VA / 1540W
Output Receptacles	(8) NEMA 5-15R		(2) NEMA 5-20R, (6) NEMA 5-15R
On Battery Output Voltage	Pure Sine Wave 120Vac +/- 5%*		
On Battery Output Frequency	60Hz +/- 1%		
Transfer Time (Typical)	4ms		
Overload Protection	Internal Current Limiting		
SURGE PROTECTION AND FILTERING			
Lightning / Surge Protection	Yes		
Internet Ready (DSL / Phone / FAX / Modem Protection)	RJ11/RJ45 (One In/One Out)		
BATTERY			
Replacement Battery Pack	RB1290X2C	RB1270X4G	RB1290X4H
Sealed Maintenance Free	Yes		
Recharge Time (Typical)	10 hours from total discharge		
WARNING DIAGNOSTICS			
Indicators	Power On, LCD Display		
Audible Alarms	On Battery, Low Battery, Overload		
ENVIRONMENTAL			
Operating Temperature	32°F to 104°F (0°C to 40°C)		
Operating Relative Humidity	0 to 95% Non-Condensing		
Storage Temperature	5°F to 113°F (-15°C to 45°C)		
Storage Relative Humidity	0 to 95% Non-Condensing		
MANAGEMENT			
On-Device Features	Manual Self-Test, Auto-Charge, Auto-Restart		
Connectivity Ports	(1) USB, (1) Serial port		
SNMP/HTTP Networking	Yes, with optional RMCARD205		
Software	PowerPanel® Business Edition		
PHYSICAL			
Dimensions (in) (mm)	2U Rack, 17" x 3.5" x 15.3" / 433 x 88 x 388 mm		
Weight (lb) (kg)	37.5 lbs / 17kg	50.7 lbs / 23kg	57.3 lbs / 26kg
SAFETY			
Conformance Approvals	UL1778, cUL, FCC/Doc Class A		

*For fully charged batteries.

TROUBLE SHOOTING

Problem	Possible Cause	Solution
Outlet does not provide power to equipment.	Circuit breaker has tripped due to an overload.	Turn the UPS off and unplug at least one piece of equipment. Wait 10 seconds, reset the circuit breaker and then turn the UPS on.
	Batteries are discharged.	Recharge the unit for at least 8 hours.
	Unit has been damaged by a surge or spike.	Contact CyberPower Systems for repair.
	Uncritical outlets have turned off automatically due to an overload.	Push the toggle button to make the uncritical outlets turn on.
The UPS does not perform expected runtime.	Batteries are not fully charged.	Recharge the batteries by leaving the UPS plugged in.
	Batteries are degraded.	Contact CyberPower Systems about replacement batteries at www.cyberpowersystems.com .
The UPS will not turn on.	The on/off switch is designed to prevent damage by rapidly turning it off and on.	Turn the UPS off. Wait 10 seconds and then turn the UPS on.
	The unit is not connected to an AC outlet.	The unit must be connected to a 110/120V 60Hz outlet.
	The batteries have degraded.	Contact CyberPower Systems about replacement batteries at www.cyberpowersystems.com .
	Mechanical problem.	Contact CyberPower Systems for repair.
PowerPanel® Business Edition is inactive.	The serial cable or USB cable is not connected.	Connect the cable to the UPS unit. Use the cable that came with the unit.
	The cable is connected to the wrong port.	Try another port of your computer.
	The unit is not providing power of batteries.	Shutdown your computer and turn the UPS off. Wait 10 seconds and turn the UPS back on. This should reset the unit.

Additional troubleshooting information can be found at www.cyberpowersystems.com/support.

LIMITED WARRANTY AND CONNECTED EQUIPMENT GUARANTEE

Read the following terms and conditions carefully before using the CyberPower OR1000PFCRT2U/OR1500PFCRT2U/OR2200PFCRT2U (the "Product"). By using the Product you consent to be bound by and become a party to the terms and conditions of this Limited Warranty and Connected Equipment Guarantee (together referred to as this "Warranty"). If you do not agree to the terms and conditions of this Warranty, you should return the Product for a full refund prior to using it.

Who is Providing this Warranty?

CyberPower Systems (USA), Inc. ("CyberPower") provides this Limited Warranty.

What Does This Warranty Cover?

This warranty covers defects in materials and workmanship in the Product under normal use and conditions. It also covers equipment that was connected to the Product and damaged because of the failure of the Product.

What is the Period of Coverage?

This warranty covers the Product for three years and connected equipment for as long as you own the Product.

Who Is Covered?

This warranty only covers the original purchaser. Coverage ends if you sell or otherwise transfer the Product.

How Do You Get Warranty Service?

1. Before contacting CyberPower, identify your Product model number, the Purchase Date, and each item of Connected Equipment (E.G. Computer tower, Computer Monitor, Cable Modem, etc).
2. Visit our web site at <https://www.cyberpowersystems.com/support> or Call us at (877) 297-6937.
3. If your product requires warranty service you must provide a copy of your dated purchase receipt or invoice.

How Do You Open A Connected Equipment Claim?

1. Call us at (877) 297-6937 or write to us at Cyber Power Systems (USA), Inc., 4241 12th Ave. E., STE 400, Shakopee, MN 55379, or send us an e-mail message at claims@cpsww.com for instructions, within 10 days of the occurrence.
2. When you contact CyberPower, identify the Product, the Purchase Date, and the item(s) of Connected Equipment. Have information on all applicable insurance or other resources of recovery/payment that are available to the Initial Customer and Request a Claim Number.
3. You must provide a dated purchase receipt (or other proof of the original purchase) and provide a description of the damage to your connected equipment.
4. Pack and ship the product to CyberPower and, if requested, the item(s) of Connected Equipment, a repair cost estimate for the damage to the Connected Equipment, and all claim forms that CyberPower provides to you. Show the Claim Number on the shipping label or include it with the product. You must prepay all shipping costs, you are responsible for packaging and shipment, and you must pay the cost of the repair estimate.

How Long Do I Have To Make A Claim?

All claims must be made within ten days of the occurrence.

LIMITED WARRANTY AND CONNECTED EQUIPMENT GUARANTEE

What Will We Do To Correct Problems?

CyberPower will inspect and examine the Product.

If the Product is defective in material or workmanship, CyberPower will repair or replace it at CyberPower's expense, or, if CyberPower is unable to or decides not to repair or replace the Product (if defective) within a reasonable time, CyberPower will refund to you the full purchase price you paid for the Product (purchase receipt showing price paid is required).

If it appears that our Product failed to protect any equipment plugged into it, we will also send you forms for making your claim for the connected equipment. We will repair or replace the equipment that was damaged because of the failure of our Product or pay you the fair market value (NOT REPLACEMENT COST) of the equipment at the time of the damage. We will use Orion Blue Book, or another a third-party valuation guide, or eBay, craigslist, or other source to establish that amount. Our maximum liability is limited to \$300,000 for the OR1000PFCRT2U, OR1500PFCRT2U and OR2200PFCRT2U.

Who Pays For Shipping?

We pay when we send items to you; you pay when you send items to us.

What isn't covered by the warranty?

1. This Warranty does not cover any software that was damaged or needs to be replaced due to the failure of the Product or any data that is lost as a result of the failure or the restoration of data or records, or the reinstallation of software.
2. This Warranty does not cover or apply to: misuse, modification, operation or storage outside environmental limits of the Product or the equipment connected to it, nor for damage while in transit or in storage, nor if there has been improper operation or maintenance, or use with items not designed or intended for use with the Product, such as laser printers, appliances, aquariums, medical or life support devices, etc.

What are the Limitations?

The sole and exclusive remedies of the Initial Customer are those provided by this Warranty.

1. This Warranty does not apply unless the Product and the equipment that was connected to it were connected to properly wired and grounded outlets (including compliance with electrical and safety codes of the most current electrical code), without the use of any adapters or other connectors.
2. The Product must have been plugged directly into the power source and the equipment connected to the Product must be directly connected to the Product and not "daisy-chained" together in serial fashion with any extension cords, another Product or device similar to the Product, surge suppressor, or power tap. Any such installation voids the Limited Warranty.
3. The Product and equipment connected to it must have been used properly in a suitable and proper environment and in conformance with any license, instruction manual, or warnings provided with the Product and the equipment connected to it.
4. The Product must have been used at all times within the limitations on the Product's VA capacity.

The Product was designed to eliminate disrupting and damaging effects of momentary (less than 1ms) voltage spikes or impulses from lightning or other power transients. If it can be shown that a voltage spike lasting longer than 1ms has occurred, the occurrence will be deemed outside the rated capabilities of the Product and the Limited Warranty is void. CyberPower Does Not Cover or Undertake Any Liability in Any Event for Any of the Following:

1. Loss of or damage to data, records, or software or the restoration of data or records, or the reinstallation of software.

LIMITED WARRANTY AND CONNECTED EQUIPMENT GUARANTEE

2. Damage from causes other than AC Power Line Transients, spikes, or surges on properly installed, grounded and code-compliant 120 volt power lines in the United States and Canada; transients, surges or spikes on standard telephone land lines, PBX telephone equipment lines or Base 10T Ethernet lines, when properly installed and connected. (This exclusion applies, for example, to fluctuations in data transmission or reception, by CATV or RF transmission or fluctuations, or by transients in such transmission.)
3. Damage from any circumstance described as excluded above with respect to the Product.
4. Damages from fire, flood, wind, rain, rising water, leakage or breakage of plumbing, abuse, misuse or alteration of either the product or the Connected Equipment.
5. CyberPower excludes any liability for personal injury under the Limited Warranty and Connected Equipment Guarantee. CyberPower excludes any liability for direct, indirect, special, incidental or consequential damages, whether for damage to or loss of property [EXCEPT FOR (AND ONLY FOR) the specific limited agreement of CyberPower to provide certain warranty benefits regarding "Connected Equipment" under this Warranty], loss of profits, business interruption, or loss of information or data. NOTE: Some States or Provinces do not allow the exclusion or limitation of incidental or consequential damages, so the above limitation may not apply to you.
6. The Product is not for use in high-risk activities or with aquariums. The Product is not designed or intended for use in hazardous environments requiring fail-safe performance, or for use in any circumstance in which the failure of the Product could lead directly to death, personal injury, or severe physical or property damage, or that would affect operation or safety of any medical or life support device (collectively, "High Risk Activities"). CyberPower expressly disclaims any express or implied warranty of fitness for High Risk Activities or with aquariums. CyberPower does not authorize use of any Product in any High Risk Activities or with Aquariums. **ANY SUCH USE IS IMPROPER AND IS A MISUSE OF THE PRODUCT.**

Where Can I Get More Information?

The application of the United Nations Convention of Contracts for the International Sale of Goods is expressly excluded. CyberPower is the warrantor under this Limited Warranty.

For further information please feel free to contact CyberPower at CyberPower Systems (USA), Inc. 4241 12th Ave E., STE 400, Shakopee, MN 55379; call us at (877) 297-6937; or send us an e-mail message at claims@cpsww.com.

All rights reserved. Reproduction without permission is prohibited.

SAFETY COMPLIANCE STATEMENT

FCC COMPLIANCE STATEMENT

This device complies with part 15 of the FCC rules. Operation is subject to the following two conditions: (1) this device may not cause harmful interference, and (2) this device must accept any interference received, including interference that may cause undesired operation.

Note: This equipment has been tested and found to comply with the limits for a Class A digital device, pursuant to part 15 of the FCC Rules. These limits are designed to provide reasonable protection against harmful interference when the equipment is operated in a commercial environment. This equipment generates, uses, and can radiate radio frequency energy and, if not installed and used in accordance with the instruction manual, may cause harmful interference to radio communications. Operation of this equipment in a residential area is likely to cause harmful interference in which case the user will be required to correct the interference at his own expense.

Important: Changes or modifications not expressly approved by the party responsible for compliance could void the user's authority to operate the equipment.

CAN ICES-3 (A)/NMB-3(A)

CyberPower[®]

For more information, contact us at

CyberPower Systems, Inc.
Website: www.cyberpower.com

ENTIRE CONTENTS COPYRIGHT © 2016 CYBERPOWER SYSTEMS, INC.
ALL RIGHTS RESERVED. REPRODUCTION IN WHOLE OR IN PART WITHOUT
PERMISSION IS PROHIBITED.