



Online User's Guide

MFC-L8610CDW

MFC-L8900CDW

Table of Contents

Before You Use Your Brother Machine	1
Definitions of Notes	2
Notice - Disclaimer of Warranties (USA and Canada)	3
Trademarks	4
Important Note	5
Introduction to Your Brother Machine.....	6
Before Using Your Machine	7
Control Panel Overview	8
Touchscreen LCD Overview.....	9
How to Navigate the Touchscreen LCD	16
Settings Screen Overview.....	19
Setting the Main Home Screen	20
Customization of Your Machine	21
Access Brother Utilities (Windows®)	22
Uninstall the Brother Software and Drivers (Windows®)	24
Paper Handling.....	25
Load Paper.....	26
Load and Print Using the Paper Tray	27
Load and Print Using the Multi-purpose Tray (MP Tray)	31
Paper Settings.....	40
Change the Paper Size and Paper Type.....	41
Select the Tray to Be Used For Printing	42
Change the Check Paper Size Setting.....	43
Recommended Print Media	44
Load Documents	45
Load Documents in the Automatic Document Feeder (ADF)	46
Load Documents on the Scanner Glass.....	48
Unscannable and Unprintable Areas	49
Using Special Paper.....	50
Print.....	51
Print from Your Computer (Windows®)	52
Print a Document (Windows®).....	53
Print Settings (Windows®).....	55
Secure Print (Windows®).....	59
Change the Default Print Settings (Windows®).....	60
Print a Document Using the BR-Script3 Printer Driver (PostScript® 3™ Language Emulation) (Windows®)	62
Monitor the Status of the Machine from Your Computer (Windows®)	63
Print from Your Computer (Macintosh).....	64
Print a Document (Macintosh).....	65
Print Options (Macintosh).....	66
Secure Print (Macintosh).....	72
Print a Document Using the BR-Script3 Printer Driver (PostScript® 3™ language emulation) (Macintosh).....	73

Monitor the Status of the Machine from Your Computer (Macintosh).....	74
Cancel a Print Job.....	76
Test Print.....	77
Scan.....	78
Scan Using the Scan Button on Your Brother Machine.....	79
Scan Photos and Graphics.....	80
Save Scanned Data to a Folder as a PDF File.....	82
Save Scanned Data to a USB Flash Drive.....	84
Scan to an Editable Text File (OCR).....	86
Scan to Email Attachment.....	88
Send Scanned Data to an Email Server.....	90
Scan to FTP.....	92
Scan to SSH FTP (SFTP).....	97
Scan to Network (Windows®).....	105
Scan to SharePoint®.....	111
Web Services for Scanning on Your Network (Windows® 7, Windows® 8 and Windows® 10).....	116
Change Scan Button Settings from ControlCenter4 (Windows®).....	120
Change Scan Button Settings from ControlCenter2 (Macintosh).....	124
Configure Certificate for Signed PDF.....	128
Disable Scanning from Your Computer.....	129
Scan from Your Computer (Windows®).....	130
Scan Using ControlCenter4 Home Mode (Windows®).....	131
Scan Using ControlCenter4 Advanced Mode (Windows®).....	148
Scan Using Nuance™ PaperPort™ 14SE or Other Windows® Applications.....	164
Scan Using Windows® Photo Gallery or Windows® Fax and Scan.....	169
Scan from Your Computer (Macintosh).....	172
Scan Using ControlCenter2 (Macintosh).....	173
Scan Using TWAIN-Compliant Applications (Macintosh).....	188
TWAIN Driver Settings (Macintosh).....	189
Configure Scan Settings Using Web Based Management.....	191
Set the Scan File Name Using Web Based Management.....	192
Set the Scan Job Email Report Using Web Based Management.....	193
Copy.....	194
Copy a Document.....	195
Enlarge or Reduce Copied Images.....	197
Make N in 1 Copies Using the Page Layout Feature.....	198
Sort Copies.....	200
Copy an ID Card.....	201
Copy on Both Sides of the Paper (2-sided Copy).....	202
Copy Options.....	204
Fax.....	206
Send a Fax.....	207
Send a Fax.....	208
Send a 2-sided Fax from the ADF.....	210
Send a Fax Manually.....	211
Send a Fax at the End of a Conversation.....	212

Send the Same Fax to More than One Recipient (Broadcasting)	213
Send a Fax in Real Time	215
Send a Fax at a Specified Time (Delayed Fax).....	216
Add a Cover Page to Your Fax.....	217
Cancel a Fax in Progress	220
Check and Cancel a Pending Fax	221
Fax Options	222
Receive a Fax	223
Receive Mode Settings	224
Memory Receive (Remote Fax) Options	234
Remote Fax Retrieval.....	242
Voice Operations and Fax Numbers	247
Voice Operations	248
Store Fax Numbers	256
Set up Groups for Broadcasting.....	260
Dial Access Codes and Credit Card Numbers	264
Telephone Services and External Devices.....	265
Voice Mail	266
Distinctive Ring.....	267
External TAD (Telephone Answering Device).....	271
External and Extension Telephones	274
Multi-line Connections (PBX)	280
Fax Reports.....	281
Print a Transmission Verification Report	282
Print a Fax Journal	283
PC-FAX	284
PC-FAX for Windows®	285
PC-FAX for Macintosh	308
Print Data Directly from a USB Flash Drive	311
Compatible USB Flash Drives.....	312
Print Data Directly from a USB Flash Drive or Digital Camera Supporting Mass Storage.....	313
Create a PRN File for Direct Printing (Windows®).....	315
Network	316
Supported Basic Network Features	317
Network Management Software and Utilities	318
Learn about Network Management Software and Utilities	319
Additional Methods of Configuring Your Brother Machine for a Wireless Network	320
Before Configuring Your Brother Machine for a Wireless Network.....	321
Configure Your Machine for a Wireless Network.....	322
Configure Your Machine for a Wireless Network Using the One Push Method of Wi-Fi Protected Setup™ (WPS).....	323
Configure Your Machine for a Wireless Network Using the PIN Method of Wi-Fi Protected Setup™ (WPS).....	324
Configure Your Machine for a Wireless Network Using the Machine's Control Panel Setup Wizard.....	327
Configure Your Machine for a Wireless Network When the SSID Is Not Broadcast	329
Configure Your Machine for an Enterprise Wireless Network	331
Use Wi-Fi Direct®	334

Advanced Network Features.....	343
Print the Network Configuration Report.....	344
Configure Your Mail Server Settings Using Web Based Management.....	345
Configure the Brother Machine for Email or Internet Fax (I-Fax).....	348
I-Fax Options.....	363
Use the Send Fax to Server Feature.....	368
Print the WLAN Report.....	372
Configure and Operate LDAP Search.....	375
Synchronize Time with the SNTP Server Using Web Based Management.....	378
Technical Information for Advanced Users.....	382
Gigabit Ethernet (Wired Network Only).....	383
Reset the Network Settings to the Factory Settings.....	385
Security.....	386
Lock the Machine Settings.....	387
Setting Lock Overview.....	388
Network Security Features.....	393
Before Using Network Security Features.....	394
Secure Function Lock 3.0.....	395
Use Active Directory® Authentication.....	402
Use LDAP Authentication.....	407
Manage Your Network Machine Securely Using SSL/TLS.....	411
Manage Your Network Machine Securely Using IPsec.....	444
Send or Receive an Email Securely.....	462
Use IEEE 802.1x Authentication for a Wired or a Wireless Network.....	468
Store Print Log to Network.....	473
Mobile/Web Connect.....	479
Brother Web Connect.....	480
Brother Web Connect Overview.....	481
Online Services Used with Brother Web Connect.....	482
Conditions for Using Brother Web Connect.....	484
Set Up Brother Web Connect.....	488
Scan and Upload Documents Using Brother Web Connect.....	497
Download and Print Documents Using Brother Web Connect.....	498
FaxForward to Cloud or E-mail.....	501
Outline, Scan, and Copy or Cut Parts of Your Documents Using Brother Web Connect.....	504
NotePrint and NoteScan.....	509
Google Cloud Print.....	514
Google Cloud Print Overview.....	515
Before Using Google Cloud Print.....	516
Print from Google Chrome™ or Chrome OS™.....	520
Print from Google Drive™ for Mobile.....	521
Print from Gmail™ Webmail Service for Mobile.....	522
AirPrint.....	523
AirPrint Overview.....	524
Before Using AirPrint.....	525
Print Using AirPrint.....	528
Scan Using AirPrint.....	532

Send a Fax Using AirPrint (For MFC Models).....	535
Mobile Printing for Windows®	538
Mopria® Print Service.....	539
Brother iPrint&Scan.....	540
Near-Field Communication (NFC).....	541
Register an External IC Card Reader.....	542
ControlCenter	543
ControlCenter4 (Windows®).....	544
Change the Operation Mode in ControlCenter4 (Windows®)	545
Scan Using ControlCenter4 Home Mode (Windows®).....	547
Scan Using ControlCenter4 Advanced Mode (Windows®).....	548
Set Up the Brother Machine Using ControlCenter4 (Windows®)	549
Create a Custom Tab Using ControlCenter4 Advanced Mode (Windows®).....	551
ControlCenter2 (Macintosh).....	553
Scan Using ControlCenter2 (Macintosh).....	554
Set Up the Brother Machine Using ControlCenter2 (Macintosh).....	555
Troubleshooting	557
Error and Maintenance Messages	558
Transfer Your Faxes or Fax Journal Report	565
Error Messages When Using the Brother Web Connect Feature	569
Document Jams	571
Document is Jammed in the Top of the ADF Unit	572
Document is Jammed under the Document Cover	573
Remove Small Scraps of Paper Jammed in the ADF	574
Paper Jams	575
Paper is Jammed in the MP tray	576
Paper is Jammed in the Paper Tray	577
Paper is Jammed in the Back of the Machine	579
Paper is Jammed Inside the Machine	581
Paper is Jammed underneath the Paper Tray.....	584
Printing Problems.....	586
Improve the Print Quality.....	589
Telephone and Fax Problems	595
Set Dial Tone Detection.....	599
Set Telephone Line Compatibility for Interference and VoIP Systems	600
Network Problems.....	601
Error Messages.....	602
Use the Network Connection Repair Tool (Windows®)	604
Where Can I Find My Brother Machine's Network Settings?	605
I Cannot Complete the Wireless Network Setup Configuration.....	606
My Brother Machine Cannot Print, Scan, or PC-FAX Receive over the Network.....	608
I Want to Check that My Network Devices are Working Correctly	610
Google Cloud Print Problems.....	611
AirPrint Problems	612
Other Problems	613
Check the Machine Information	615







Reset Your Brother Machine	616
Reset Functions Overview	617
Routine Maintenance	618
Replace Supplies	619
Replace the Toner Cartridge	621
Replace the Drum Unit	624
Replace the Belt Unit.....	628
Replace the Waste Toner Box	631
Reset the Drum Counter	635
Reset the Belt Unit Counter.....	636
Clean the Machine	637
Clean the Scanner.....	639
Clean the Laser Scanner Windows	640
Clean the Touchscreen LCD	643
Clean the Corona Wires	644
Clean the Drum Unit.....	646
Clean the Paper Pick-up Rollers	651
Calibrate Color Output	652
Reset the Machine's Calibration Settings.....	653
Correct Color Print Alignment (Color Registration)	654
Check the Remaining Part Life	655
Pack and Ship Your Brother Machine	656
Replace Periodic Maintenance Parts	658
Machine Settings.....	659
Change Machine Settings from the Control Panel.....	660
In the Event of Power Failure (Memory Storage)	661
General Settings.....	662
Save Your Favorite Settings as a Shortcut.....	679
Print Reports	683
Settings and Features Tables.....	686
Change Machine Settings from Your Computer.....	723
Change Machine Settings Using Web Based Management	724
Change the Machine Settings Using Remote Setup.....	728
Appendix.....	739
Specifications	740
How to Enter Text on Your Brother Machine	747
Supplies	748
Important Information About Toner Cartridge Life	750
Accessories.....	751
Brother Numbers.....	752

Before You Use Your Brother Machine

- [Definitions of Notes](#)
- [Notice - Disclaimer of Warranties \(USA and Canada\)](#)
- [Trademarks](#)
- [Important Note](#)

Definitions of Notes

We use the following symbols and conventions throughout this User's Guide:

 WARNING	WARNING indicates a potentially hazardous situation which, if not avoided, could result in death or serious injuries.
 CAUTION	CAUTION indicates a potentially hazardous situation which, if not avoided, may result in minor or moderate injuries.
IMPORTANT	IMPORTANT indicates a potentially hazardous situation which, if not avoided, may result in damage to property or loss of product functionality.
NOTE	NOTE specifies the operating environment, conditions for installation, or special conditions of use.
	Tips icons indicate helpful hints and supplementary information.
	Electrical Hazard icons alert you to possible electrical shock.
	Fire Hazard icons alert you to the possibility of a fire.
	Hot Surface icons warn you not to touch hot machine parts.
	Prohibition icons indicate actions you must not perform.
Bold	Bold style identifies buttons on the machine's control panel or computer screen.
<i>Italics</i>	Italicized style emphasizes an important point or refers you to a related topic.
Courier New	Courier New font identifies messages shown on the machine's LCD.

Related Information

- [Before You Use Your Brother Machine](#)

Notice - Disclaimer of Warranties (USA and Canada)

BROTHER'S LICENSOR(S), AND THEIR DIRECTORS, OFFICERS, EMPLOYEES OR AGENTS (COLLECTIVELY BROTHER'S LICENSOR) MAKE NO WARRANTIES, EXPRESS OR IMPLIED, INCLUDING WITHOUT LIMITATION THE IMPLIED WARRANTIES OF MERCHANTABILITY AND FITNESS FOR A PARTICULAR PURPOSE, REGARDING THE SOFTWARE. BROTHER'S LICENSOR(S) DOES NOT WARRANT, GUARANTEE OR MAKE ANY REPRESENTATIONS REGARDING THE USE OR THE RESULTS OF THE USE OF THE SOFTWARE IN TERMS OF ITS CORRECTNESS, ACCURACY, RELIABILITY, CURRENTNESS OR OTHERWISE. THE ENTIRE RISK AS TO THE RESULTS AND PERFORMANCE OF THE SOFTWARE IS ASSUMED BY YOU. THE EXCLUSION OF IMPLIED WARRANTIES IS NOT PERMITTED BY SOME STATES IN THE USA AND SOME PROVINCES IN CANADA. THE ABOVE EXCLUSION MAY NOT APPLY TO YOU.

IN NO EVENT WILL BROTHER'S LICENSOR(S) BE LIABLE TO YOU FOR ANY CONSEQUENTIAL, INCIDENTAL OR INDIRECT DAMAGES (INCLUDING DAMAGES FOR LOSS OF BUSINESS PROFITS, BUSINESS INTERRUPTION, LOSS OF BUSINESS INFORMATION, AND THE LIKE) ARISING OUT OF THE USE OR INABILITY TO USE THE SOFTWARE EVEN IF BROTHER'S LICENSOR HAS BEEN ADVISED OF THE POSSIBILITY OF SUCH DAMAGES. BECAUSE SOME STATES IN THE USA AND SOME PROVINCES IN CANADA DO NOT ALLOW THE EXCLUSION OR LIMITATION OF LIABILITY FOR CONSEQUENTIAL OR INCIDENTAL DAMAGES, THE ABOVE LIMITATIONS MAY NOT APPLY TO YOU. IN ANY EVENT BROTHER'S LICENSOR'S LIABILITY TO YOU FOR ACTUAL DAMAGES FROM ANY CAUSE WHATSOEVER, AND REGARDLESS OF THE FORM OF THE ACTION (WHETHER IN CONTRACT, TORT (INCLUDING NEGLIGENCE), PRODUCT LIABILITY OR OTHERWISE), WILL BE LIMITED TO \$50.



Related Information

- [Before You Use Your Brother Machine](#)

Trademarks

BROTHER is either a trademark or a registered trademark of Brother Industries, Ltd.

Microsoft, Windows, Windows Server, SharePoint, Internet Explorer, Outlook, PowerPoint, Excel, Active Directory, OneNote and OneDrive are either registered trademarks or trademarks of Microsoft Corporation in the United States and/or other countries.

Apple, Macintosh, Safari, iPad, iPhone and iPod touch are trademarks of Apple Inc., registered in the United States and other countries.

AirPrint and macOS are trademarks of Apple Inc.

Nuance and PaperPort are trademarks or registered trademarks of Nuance Communications, Inc. or its affiliates in the United States and/or other countries.

PostScript and PostScript 3 are either registered trademarks or trademarks of Adobe Systems Incorporated in the United States and/or other countries.

Wi-Fi, Wi-Fi Alliance and Wi-Fi Direct are registered trademarks of Wi-Fi Alliance®.

WPA, WPA2, Wi-Fi CERTIFIED, Wi-Fi Protected Setup and Wi-Fi Protected Setup logo are trademarks of Wi-Fi Alliance®.

Flickr is a registered trademark of Yahoo! Inc.

Android, Gmail, Google Cloud Print, Google Drive, Google Chrome, Chrome OS and Google Play are trademarks of Google Inc. Use of these trademarks is subject to Google Permissions.

Mopria® is a registered trademark and a service mark of Mopria Alliance, Inc. in the United States and other countries. Unauthorized use is strictly prohibited.

Mozilla and Firefox are registered trademarks of the Mozilla Foundation.

Intel is a trademark of Intel Corporation in the U.S. and/or other countries.

Evernote is a trademark of Evernote Corporation and used under a license.

The Bluetooth word mark is owned by the Bluetooth SIG, Inc. and any use of such marks by Brother Industries, Ltd. is under license.

WordPerfect is a registered trademark of Corel Corporation and/or its subsidiaries in Canada, the United States and/or other countries.

PictBridge is a trademark.

Each company whose software title is mentioned in this manual has a Software License Agreement specific to its proprietary programs.

Any trade names and product names of companies appearing on Brother products, related documents and any other materials are all trademarks or registered trademarks of those respective companies.



Related Information

- [Before You Use Your Brother Machine](#)

Important Note

- Do not use this product outside the country of purchase as it may violate the wireless telecommunication and power regulations of that country.
- Not all models are available in all countries.
- Windows® 10 in this document represents Windows® 10 Home, Windows® 10 Pro, Windows® 10 Education and Windows® 10 Enterprise.
- Windows Server® 2008 in this document represents Windows Server® 2008 and Windows Server® 2008 R2.
- The screens in this User's Guide are for illustration purposes only and may differ from the actual screens.
- Unless otherwise specified, the screens in this manual are from Windows® 7 and macOS v10.10.5 Screens on your computer may vary depending on your operating system.
- The contents of this guide and the specifications of this product are subject to change without notice.
- Not all features are available in countries subject to applicable export restrictions.



Related Information

- [Before You Use Your Brother Machine](#)
-

Introduction to Your Brother Machine

- [Before Using Your Machine](#)
- [Control Panel Overview](#)
- [Touchscreen LCD Overview](#)
- [How to Navigate the Touchscreen LCD](#)
- [Settings Screen Overview](#)
- [Setting the Main Home Screen](#)
- [Customization of Your Machine](#)
- [Access Brother Utilities \(Windows®\)](#)

Before Using Your Machine

Before attempting any printing operation, confirm the following:

- Make sure you have installed the Brother software and drivers.
- For USB or network cable users: Make sure the interface cable is physically secure.

Simultaneous printing, scanning and faxing

Your machine can print from your computer while sending or receiving a fax into memory or while scanning a document into the computer. Fax sending will not be stopped during printing from your computer. However, when the machine is copying or receiving a fax on paper, it pauses the printing operation, and then continues printing when copying or fax receiving has finished.

Firewall (Windows®)

If your computer is protected by a firewall and you are unable to network print, network scan, or PC-FAX, you may need to configure the firewall settings. If you are using the Windows® Firewall and you installed the drivers using the steps in the installer, the necessary firewall settings have been already set. If you are using any other personal firewall software, see the User's Guide for your software or contact the software manufacturer.



Related Information

- [Introduction to Your Brother Machine](#)

Control Panel Overview

The control panel may vary depending on your model.

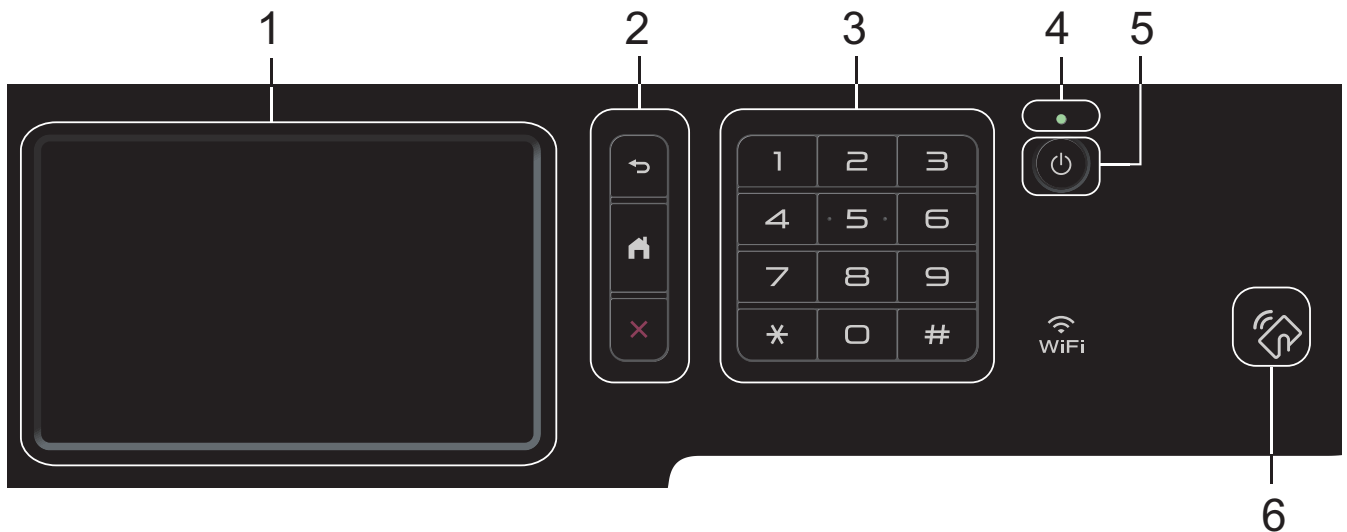

1. Touchscreen Liquid Crystal Display (LCD)

Access menus and options by pressing them on the Touchscreen.

2. Menu Buttons



(Back)

Press to go back to the previous menu.



(Home)

Press to return to the Main Home screen.



(Cancel)

Press to cancel an operation.

3. Dial Pad (Numerical buttons)

Press the Numerical buttons to dial telephone or fax numbers and to enter the number of copies.

4. LED Power Indicator

The LED lights up depending on the machine's power status.

5. Power On/Off

- Turn on the machine by pressing .
- Turn off the machine by pressing and holding down . The LCD displays [Shutting Down] for a few seconds before going off. If you have an external telephone or TAD connected, it is always available.

6. Near Field Communication (NFC) Reader (MFC-L8900CDW)

You can use card authentication by touching the IC card to the NFC Reader on the control panel.

If your Android™ device supports the NFC feature, you can print from your device or scan documents to your device in the same way.

✓ Related Information

- [Introduction to Your Brother Machine](#)

Touchscreen LCD Overview

MFC-L8610CDW

You can select from two types of screens to set as the Main Home screen: Home screens and Shortcuts screens. When a Home screen is displayed, swipe left or right or press ◀ or ▶ to display the other Home screens.

The Main Home screen displays the machine's status when the machine is idle. When displayed, this screen indicates that your machine is ready for the next command.

If Active Directory® Authentication or LDAP Authentication is enabled, the machine's control panel is locked.

The available features vary depending on your model.

Home screen: Screen 1

The Home screens provide access to features, such as Fax, Copy and Scan.

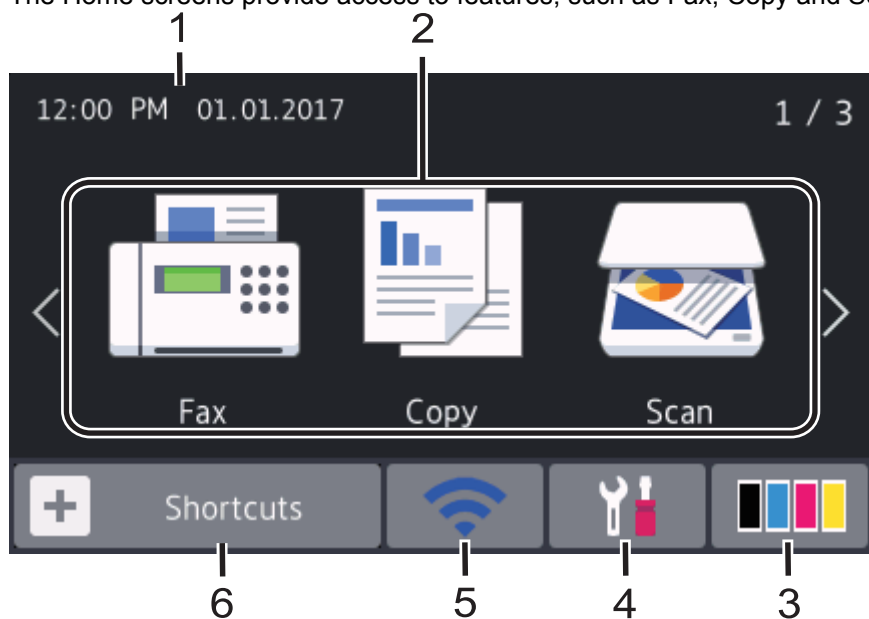

Home screen: Screen 2

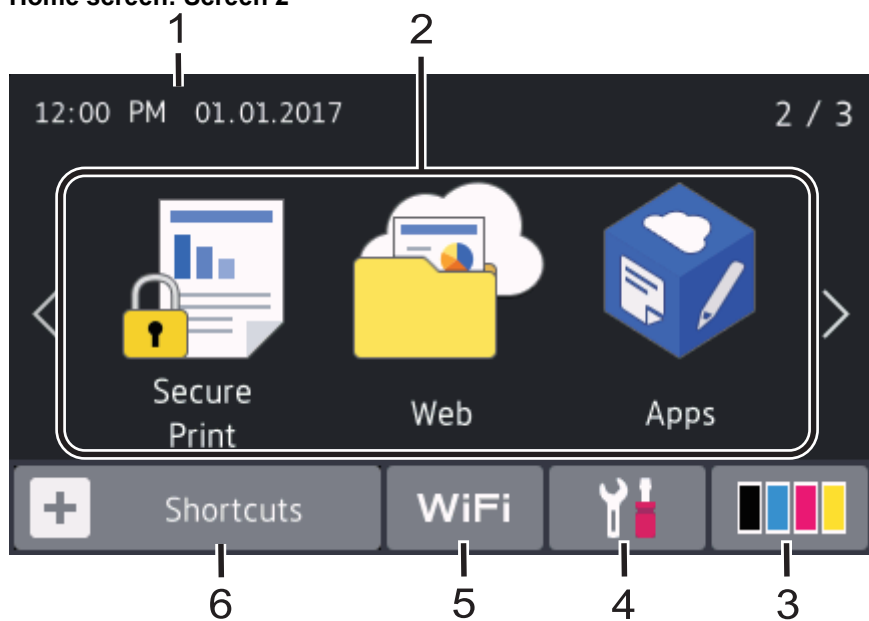

Home screen: Screen 3

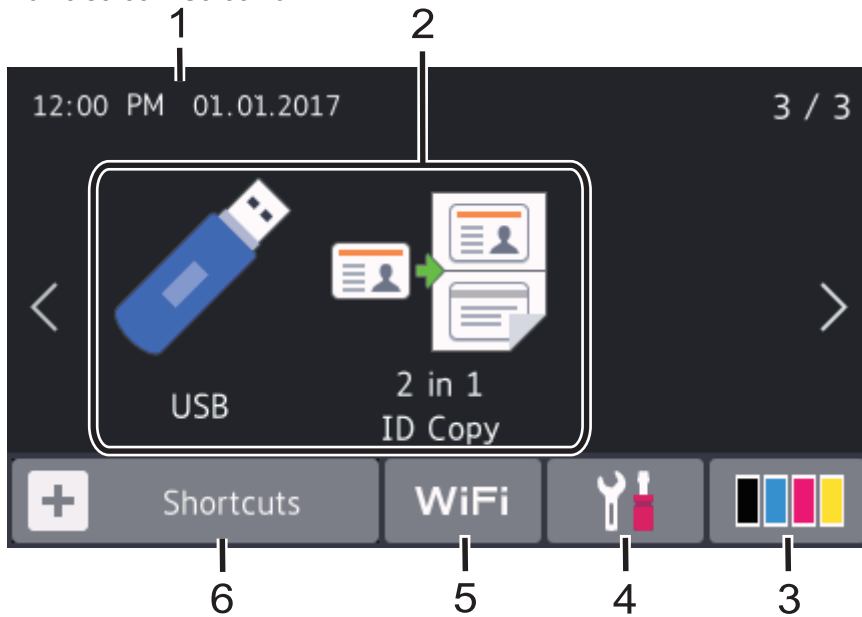

Shortcuts screen

Create Shortcuts for frequently-used operations, such as sending a fax, copying, scanning and using Web Connect.





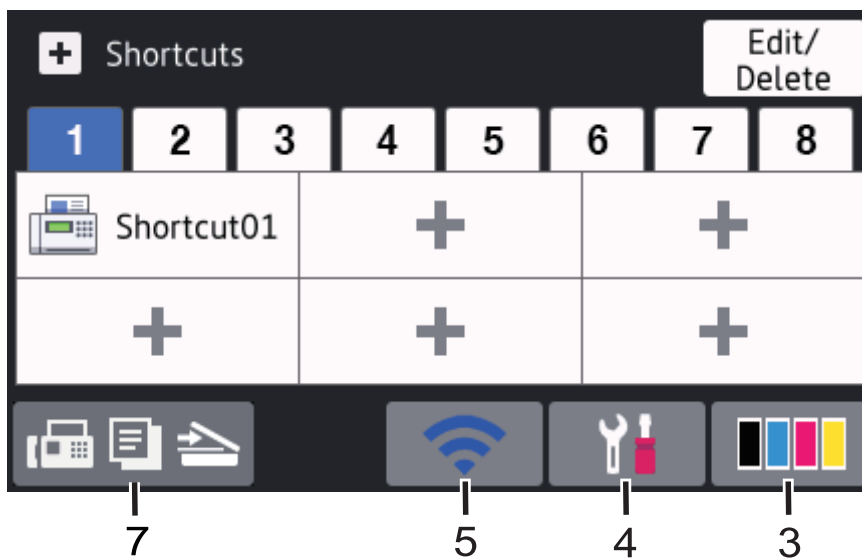

Eight Shortcuts tabs are available with six Shortcuts on each Shortcuts tab. A total of 48 Shortcuts are available.







1. Date & Time

Displays the date and time set on the machine.

2. Modes

-  [Fax]
Press to access Fax mode.
-  [Copy]
Press to access Copy mode.
-  [Scan]
Press to access Scan mode.
-  [Secure Print]
Press to access the [Secure Print] option.

-  [Web]
Press to connect the Brother machine to an Internet service.
-  [Apps]
Press to connect the Brother machine to the Brother Apps service.
-  [USB]
Press to access the USB menu and select [Scan to USB] or [Direct Print] options.
-  [2 in 1 ID Copy]
Press to access the 2 in 1 ID Copy option.

3.  (Toner)

Displays the remaining toner life. Press to access the [Toner] menu.

4.  (Settings)

Press to access the [Settings] menu.

If Setting Lock has been turned on, a lock  icon appears on the LCD. You must unlock the machine to change settings.

5.  or  (Wireless Status)

Press to configure wireless settings.

If you are using a wireless connection, a four-level indicator displays the current wireless signal strength.



6.  [Shortcuts]

Press to access the [Shortcuts] screen.

7.  (Home screen)

Press to access the Home screens.

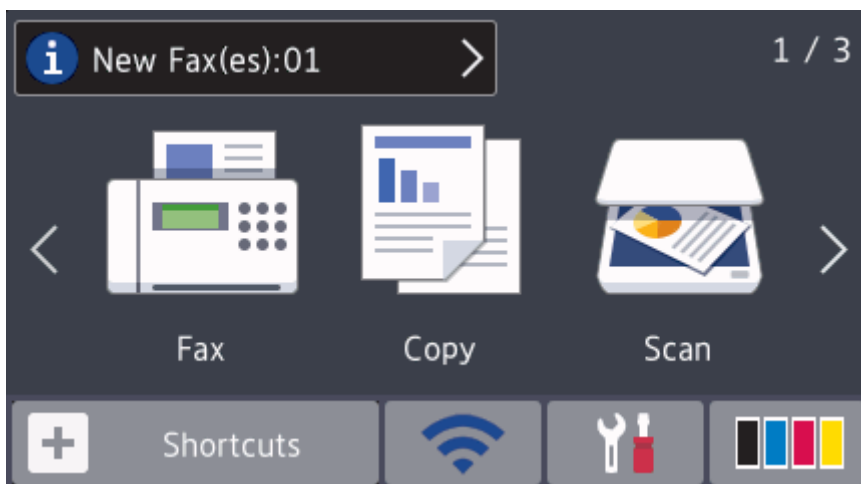

New Fax

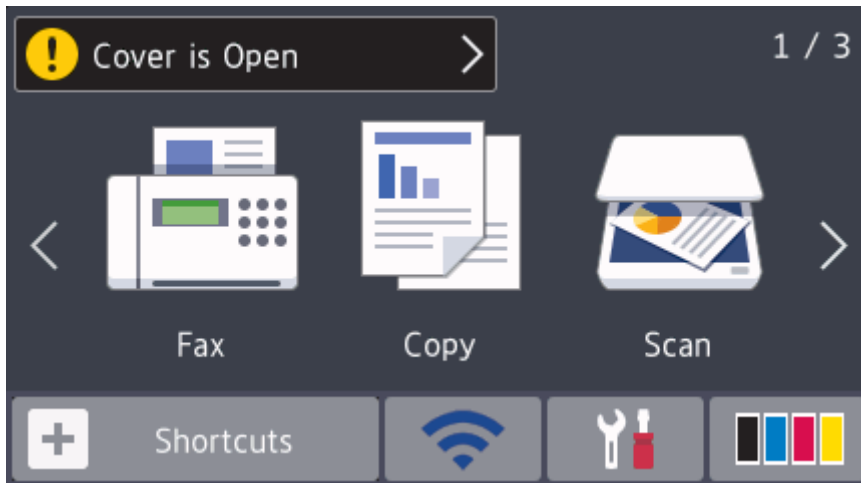

When [Fax Preview] is set to [On], the number of new faxes you received into the memory appears at the top of the screen.

Warning icon



The warning icon  appears when there is an error or maintenance message. Press the message area to view it, and then press  to return to the Main Home screen.

NOTE

This product adopts the font of ARPHIC TECHNOLOGY CO.,LTD.

MFC-L8900CDW

Your machine has eight tabbed screens (referred to as Home screens). Each Home screen can hold up to eight icons which can be used for functions, machine settings and shortcuts. A total of 64 icons can be placed on the Home screens as needed.

The Main Home screen can be selected from the Home screens.

Use the [Admin Settings] menu to names on the tabs and rearrange the icons.

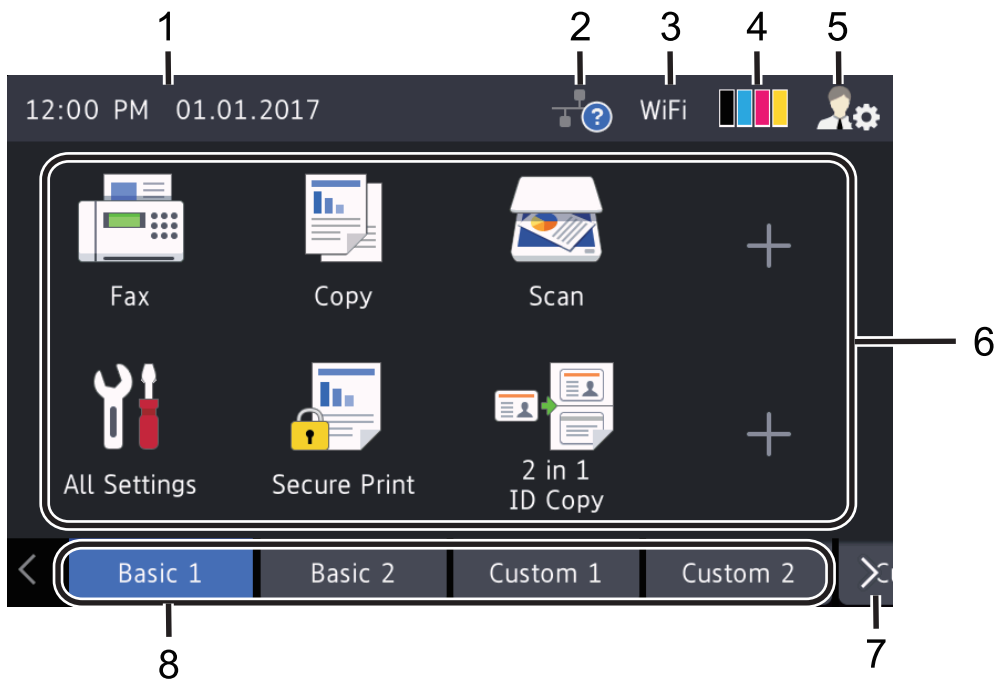

1. Date & Time

Displays the date and time set on the machine.

This area is also used to display error or maintenance messages.

2.  **(Wired LAN Status)**

Press to configure the Wired LAN settings.

The icon displays the current wired network status.



Wired LAN Disabled
(Gray)



Wired LAN Enabled
(White)



No cable connection or Wireless LAN connected

3.  or  **(Wireless Status)**

Press to configure wireless settings.

If you are using a wireless connection, a four-level indicator displays the current wireless signal strength.



0



Max



Wireless LAN Disabled

4.  **(Toner)**

Displays the remaining toner life. Press to access the [Toner] menu.

5.  **(Admin Settings)**

Press to access the [Admin Settings] menu.

6. **Function Icons, Setting Icons and Shortcut Icons**

The following descriptions explain basic icons and features. The available features vary depending on your model.

•  **[All Settings]**

Press to access the machine's settings menu.

•  **[Fax]**

Press to access Fax mode.

•  **[Copy]**

Press to access Copy mode.

•  **[Scan]**

Press to access Scan mode.

•  **[Secure Print]**

Press to access the [Secure Print] option.

•  **[USB]**

Press to access the USB menu and select [Scan to USB] or [Direct Print] options.

•  **[Web]**

Press to connect the Brother machine to an Internet service.

•  **[Apps]**

Press to connect the Brother machine to the Brother Apps service.

-  [2 in 1 ID Copy]

Press to access the 2 in 1 ID Copy option.

-  (Shortcuts)

Press to access the created Shortcuts for frequently-used operations, such as sending a fax, copying, scanning and using Web Connect.

7. Tabs Scroll Buttons

Press to display and access all the tabs.

8. Home Tabs

Press to display the screen for the Home.

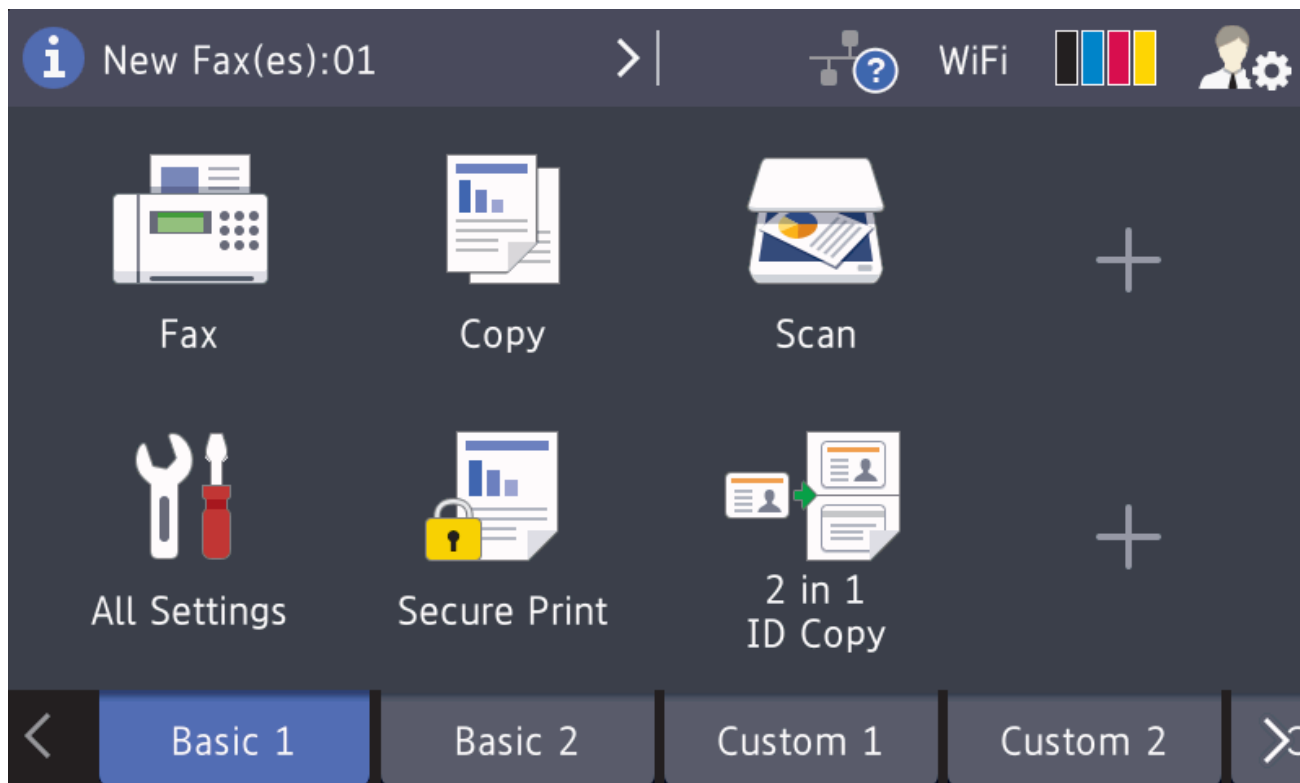

New Fax

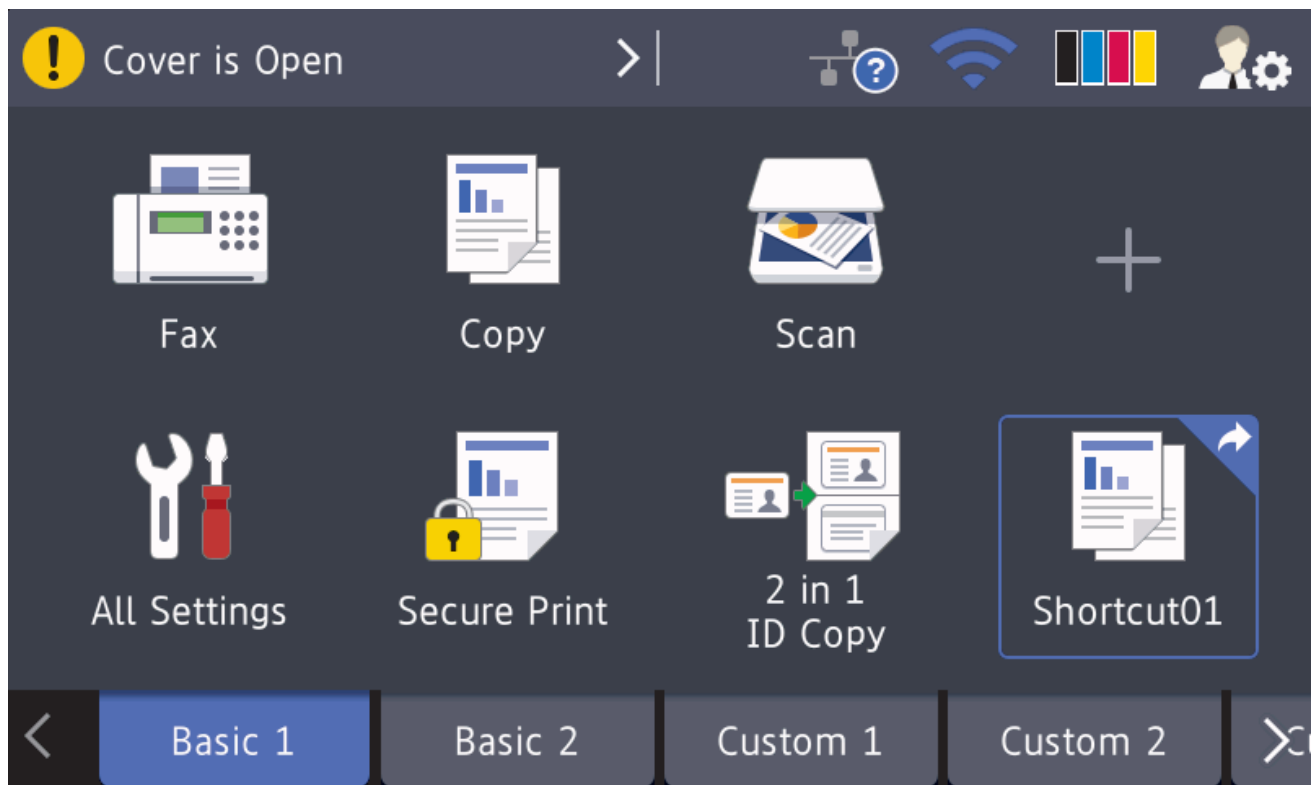

When [Fax Preview] is set to [On], the number of new faxes you received into the memory appears at the top of the screen.

Warning icon



The warning icon  appears when there is an error or maintenance message. Press the message area to view it, and then press  to return to the Main Home screen.

NOTE

This product adopts the font of ARPHIC TECHNOLOGY CO.,LTD.

Related Information

- [Introduction to Your Brother Machine](#)
- [Customization of Your Machine](#)

How to Navigate the Touchscreen LCD

Press your finger on the LCD to operate it. To display and access all the options, swipe left, right, up, down or press ◀▶ or ▲▼ on the LCD to scroll through them.

The following steps explain how to change a machine setting. In this example, the LCD Backlight setting is changed from [Light] to [Med].

IMPORTANT

DO NOT press the LCD with a sharp object, such as a pen or stylus. It may damage the machine.

NOTE

DO NOT touch the LCD immediately after plugging in the power cord or turning on the machine. Doing this may cause an error.

1. Press  [Settings].



If your machine displays the [All Settings] menu on the Home screen, skip this step.

2. Press [All Settings].
3. Swipe up or down or press ▲ or ▼ to display the [General Setup] option, and then press [General Setup].

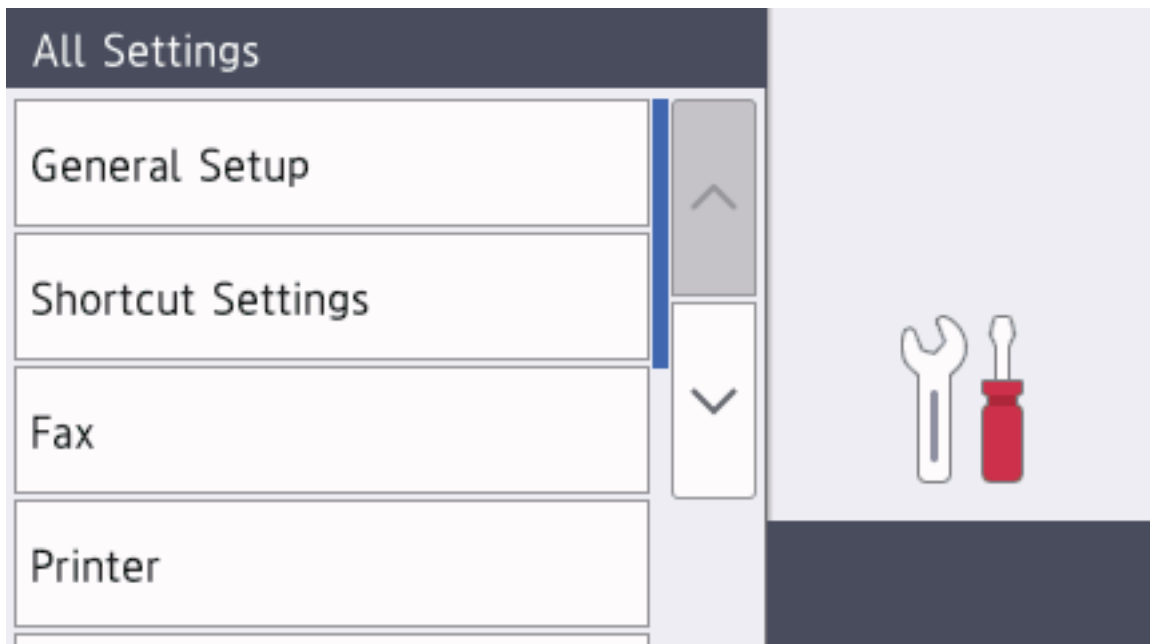

4. Swipe up or down or press ▲ or ▼ to display the [LCD Settings] option, and then press [LCD Settings].

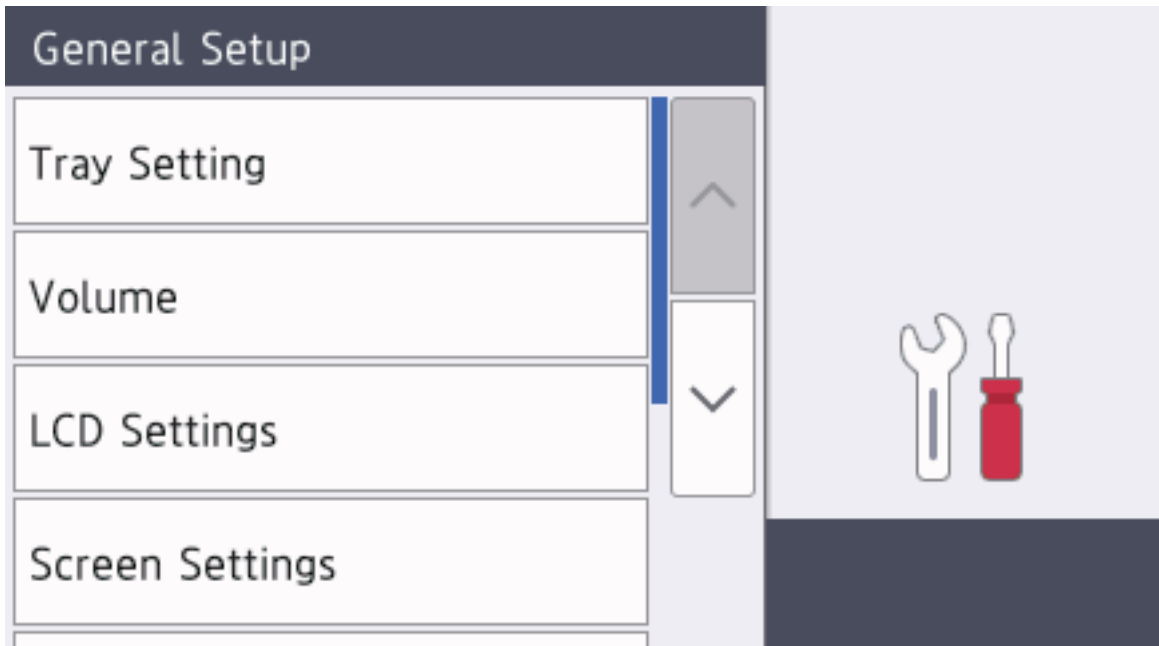

5. Press [Backlight].

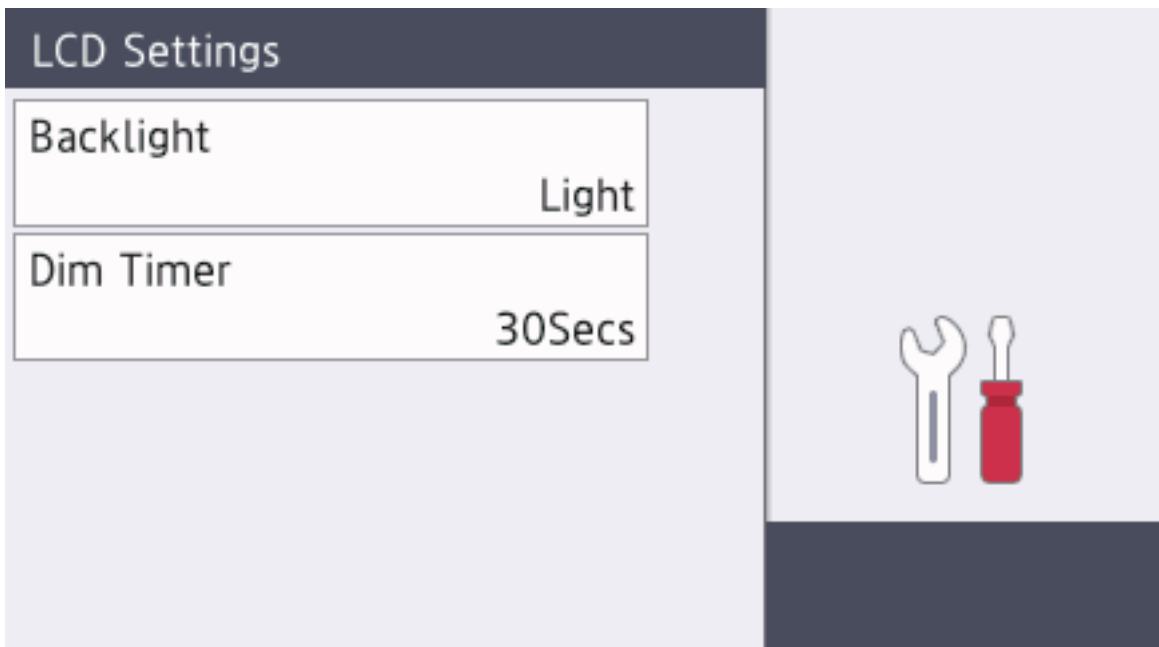

6. Press [Med].



7. Press .

Related Information

- [Introduction to Your Brother Machine](#)

Settings Screen Overview

Related Models: MFC-L8610CDW

Press  to view the current machine status on the LCD.

Use the Settings menu to access all of your Brother machine's settings.

The available features vary depending on your model.

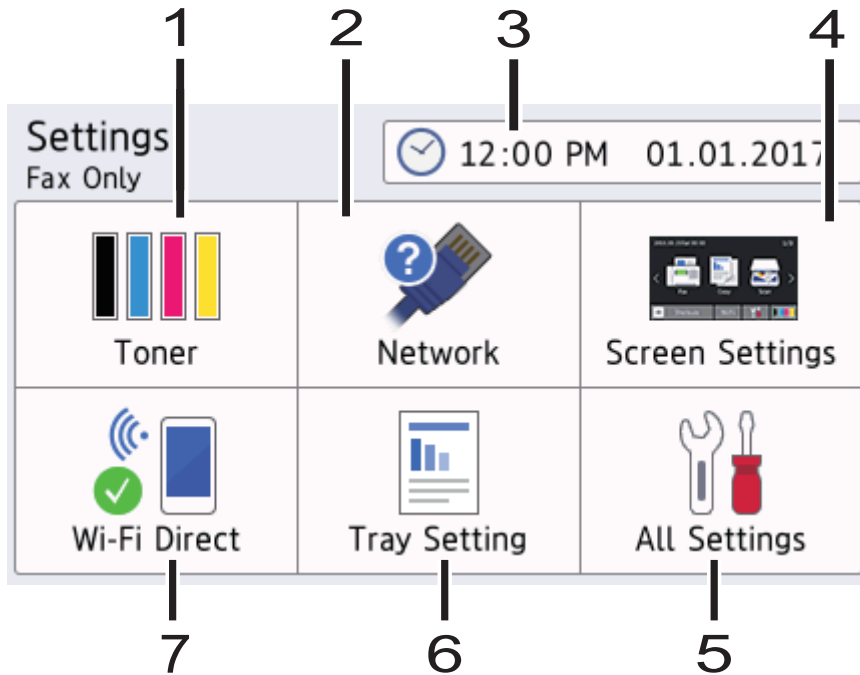

1. Toner

- Displays the remaining toner life.
- Press to access the [Toner] menu.

2. Network

- Press to set up a network connection.
- A four level indicator on the screen displays the current wireless signal strength if you are using a wireless connection.

3. Date & Time

Displays the date and time set on the machine.

Press to access the [Date & Time] menu.

4. Screen Settings

Press to access the [Screen Settings] menu.

5. All Settings

Press to access a menu of all machine settings.

6. Tray Setting

Press to access the [Tray Setting] menu.

7. Wi-Fi Direct

Press to set up a Wi-Fi Direct network connection.



Related Information



- [Introduction to Your Brother Machine](#)

Setting the Main Home Screen

Related Models: MFC-L8610CDW

Set the Main Home screen to either [Home Screen 1], [Home Screen 2], [Home Screen 3], [Shortcuts 1], [Shortcuts 2], [Shortcuts 3], [Shortcuts 4], [Shortcuts 5], [Shortcuts 6], [Shortcuts 7] or [Shortcuts 8].

When the machine is idle or you press , the Touchscreen will return to the screen you set.

1. Press  [Settings] > [Screen Settings] > [Main Home Screen].
2. Swipe up or down or press ▲ or ▼ to display the screen settings, and then press the setting you want.
3. Press .

The machine will go to your chosen screen.

Related Information

- [Introduction to Your Brother Machine](#)

Customization of Your Machine

Related Models: MFC-L8900CDW

When you press , the machine displays the [Admin Settings] menu. To restrict access to this menu, you can set an administrator password to protect it.



This password is the same as the administrator password for Web Based Management.

The [Admin Settings] menu allows you to customize Home screen names and the arrangement of icons on the screens.

The [Home Screen Settings] menu and the [Other Screen Settings] menu provide the following functions:

- Renaming Home screen tabs
- Adding, removing and repositioning icons on Home screens
- Setting your Main Home screen
- Selecting screen background color
- Changing the default functions for the Copy screen and the Scan screen

The [Admin Settings] menu allows you to manage permissions and restrictions.

The [Restriction Management] menu provides the following functions:

- User Restriction
 - Secure Function Lock
 - Active Directory Authentication
 - LDAP Authentication
- Setting Lock (detailed settings are available.)

For more information, see *Related Information. Network Security Features and Lock the Machine Settings.*



Related Information

- [Introduction to Your Brother Machine](#)
- [Touchscreen LCD Overview](#)
- [Network Security Features](#)
- [Lock the Machine Settings](#)

Access Brother Utilities (Windows®)

Brother Utilities is an application launcher that offers convenient access to all Brother applications installed on your computer.

1. Do one of the following:

- (Windows® 7)

Click  (**Start**) > **All Programs** > **Brother** > **Brother Utilities**.

- (Windows® 8)

Tap or click  (**Brother Utilities**) either on the **Start** screen or the desktop.

- (Windows® 8.1)

Move your mouse to the lower left corner of the **Start** screen and click  (if you are using a touch-based device, swipe up from the bottom of the **Start** screen to bring up the **Apps** screen).

When the **Apps** screen appears, tap or click  (**Brother Utilities**).

- (Windows® 10)

Click  **Brother** > **Brother Utilities**.

2. Select your machine (where XXXX is the name of your model).

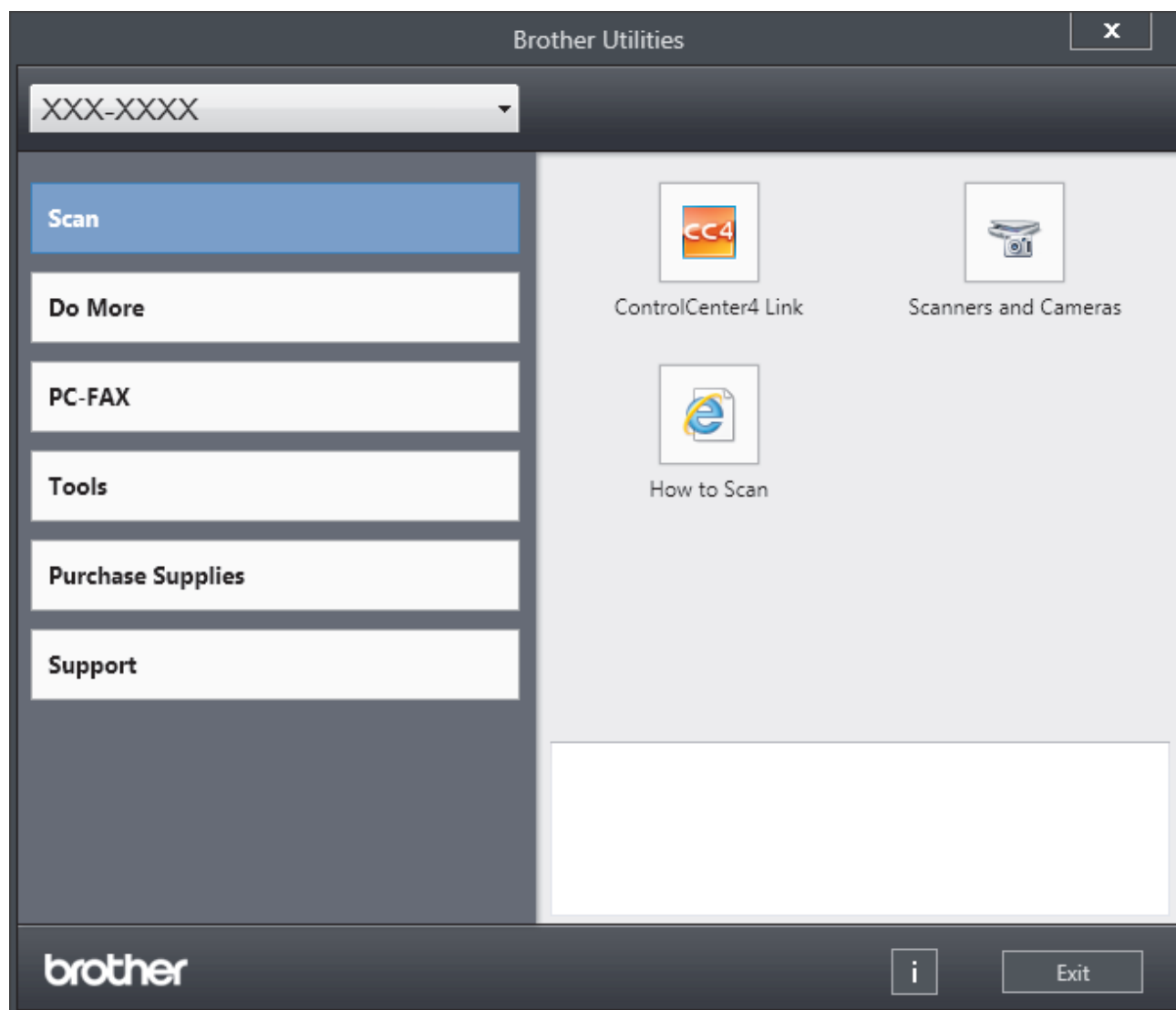

3. Choose the operation you want to use.



Related Information

- [Introduction to Your Brother Machine](#)
 - [Uninstall the Brother Software and Drivers \(Windows®\)](#)
-

Uninstall the Brother Software and Drivers (Windows®)

1. Do one of the following:

- (Windows® 7)

Click  (**Start**) > **All Programs** > **Brother** > **Brother Utilities**.

- (Windows® 8)

Tap or click  (**Brother Utilities**) either on the **Start** screen or the desktop.

- (Windows® 8.1)

Move your mouse to the lower left corner of the **Start** screen and click  (if you are using a touch-based device, swipe up from the bottom of the **Start** screen to bring up the **Apps** screen).

When the **Apps** screen appears, tap or click  (**Brother Utilities**).

- (Windows® 10)

Click  **Brother** > **Brother Utilities**.

2. Click the drop-down list, and then select your model name (if not already selected). Click **Tools** in the left navigation bar, and then click **Uninstall**.

Follow the instructions in the dialog box to uninstall the software and drivers.



Related Information

- [Access Brother Utilities \(Windows®\)](#)

Paper Handling

- [Load Paper](#)
- [Paper Settings](#)
- [Recommended Print Media](#)
- [Load Documents](#)
- [Unscannable and Unprintable Areas](#)
- [Using Special Paper](#)

Load Paper

- Load and Print Using the Paper Tray
- Load and Print Using the Multi-purpose Tray (MP Tray)

Load and Print Using the Paper Tray

- [Load Paper in the Paper Tray](#)
- [Printing Problems](#)
- [Error and Maintenance Messages](#)

Load Paper in the Paper Tray

- If the Check Size setting is set to On and you pull the paper tray out of the machine, a message appears on the LCD asking if you want to change the paper size and paper type. Change the paper size and paper type settings if needed, following the LCD instructions.
- When you load a different size and type of paper in the tray, you must also change the Paper Size and Paper Type settings in the machine, or on your computer.

1. Pull the paper tray completely out of the machine.

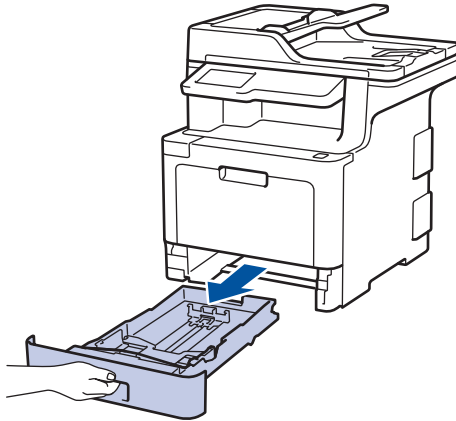

2. Press and slide the paper guides to fit the paper.
Press the green release levers to slide the paper guides.

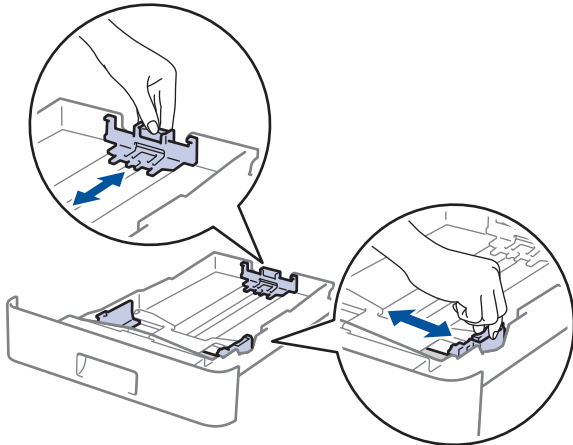

3. Fan the stack of paper well.
4. Load paper in the paper tray with the printing surface *face down*.



When you use letterhead or preprinted paper, load the paper in the correct orientation. See *Related Information: Change Machine Settings to Print on Letterhead or Preprinted Paper Using the Paper Tray*.

-
5. Make sure the paper is below the maximum paper mark (▼▼▼).
Overfilling the paper tray will cause paper jams.

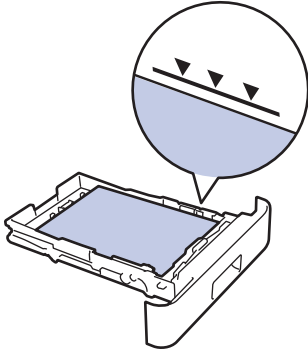

6. Slowly push the paper tray completely into the machine.
7. Lift the support flap to prevent paper from sliding off the output tray.

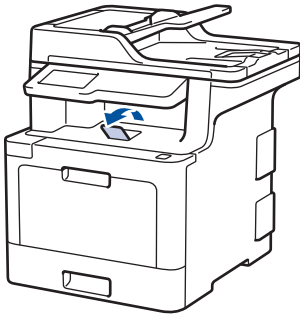

Related Information

- [Load and Print Using the Paper Tray](#)
 - [Change Machine Settings to Print on Letterhead or Preprinted Paper Using the Paper Tray](#)
-

Change Machine Settings to Print on Letterhead or Preprinted Paper Using the Paper Tray

When you use letterhead or preprinted paper for 2-sided printing, change the machine's settings.



DO NOT load different sizes and types of paper in the paper tray at the same time. Doing this may cause the paper to jam or misfeed.

Orientation

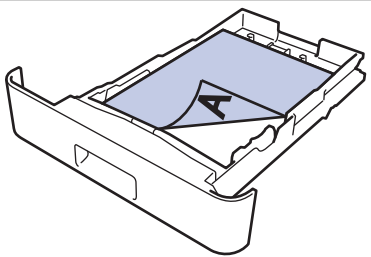
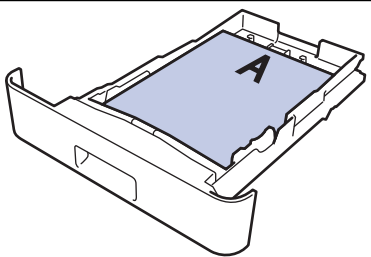
	<p>For 1-sided printing</p> <ul style="list-style-type: none">• face down• top edge toward the front of the paper tray
	<p>For automatic 2-sided printing (long edge binding)</p> <ul style="list-style-type: none">• face up• bottom edge toward the front of the paper tray

1. Press  [Settings] > [All Settings] > [Printer] > [2-sided] > [Single Image] > [2-sided Feed].



If your machine displays the [All Settings] menu on the Home screen, skip the [Settings] menu.

2. Press .



Related Information

- [Load Paper in the Paper Tray](#)

Load and Print Using the Multi-purpose Tray (MP Tray)

You can load letterhead, colored paper, thin paper, thick paper, recycled paper, bond paper, labels, glossy paper, up to 50 sheets of plain paper, or up to ten envelopes in the MP tray.

- [Load Paper in the Multi-purpose Tray \(MP Tray\)](#)
- [Load and Print Labels Using the MP Tray](#)
- [Load and Print Envelopes Using the MP Tray](#)
- [Printing Problems](#)
- [Error and Maintenance Messages](#)

Load Paper in the Multi-purpose Tray (MP Tray)

When you load a different size and type of paper in the tray, you must also change the Paper Size and Paper Type settings in the machine, or on your computer.

- Plain Paper
 - Letterhead
 - Colored Paper
 - Thin Paper
 - Thick Paper
 - Recycled Paper
 - Bond
 - Glossy Paper
1. Lift the support flap to prevent paper from sliding off the face down output tray.

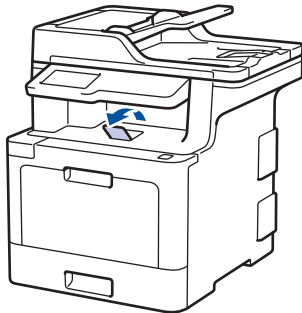

2. Open the MP tray and lower it gently.

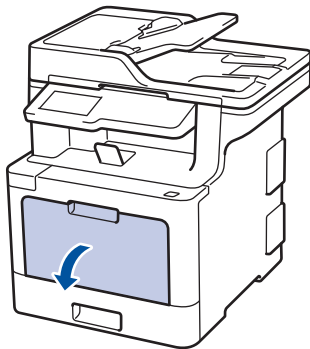

3. Pull out the MP tray support (1) and unfold the flap (2).

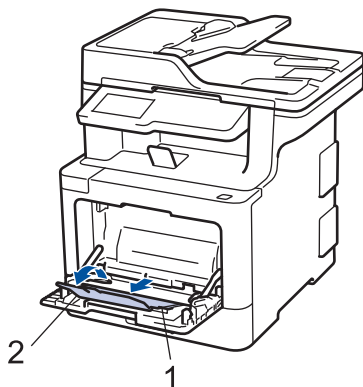

4. Slide the MP tray paper guides to fit the width of the paper you are using.

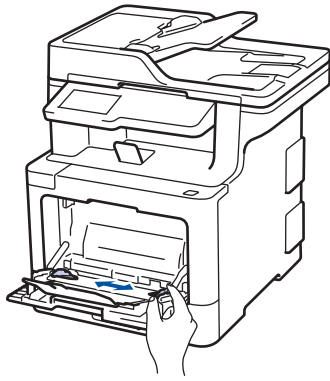

5. Load paper with the printing surface *face up* in the MP tray.



- Make sure the paper is below the maximum paper mark (1).
- Place the paper's leading edge (top of paper) between the ▲ and ▼ arrows (2).
- When using glossy paper, load only one sheet at a time in the MP tray to avoid a paper jam.
- When you use letterhead or preprinted paper, load the paper in the correct orientation. See *Related Information: Change Machine Settings to Print on Letterhead or Preprinted Paper Using the MP Tray*.

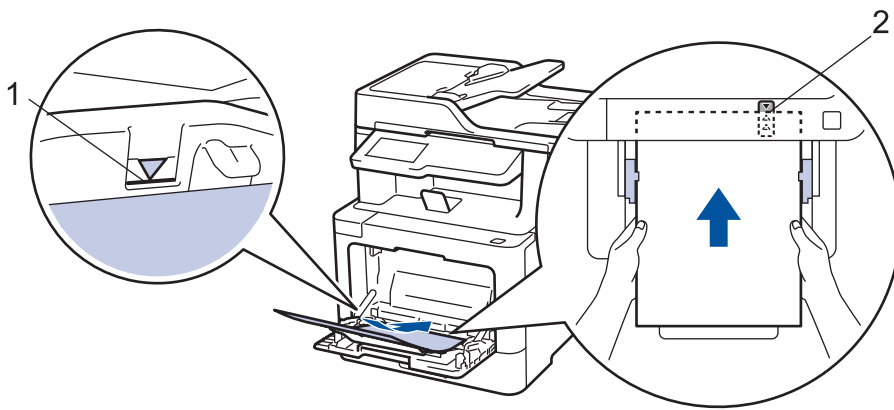

Related Information

- [Load and Print Using the Multi-purpose Tray \(MP Tray\)](#)
- [Change Machine Settings to Print on Letterhead or Preprinted Paper Using the MP Tray](#)

Change Machine Settings to Print on Letterhead or Preprinted Paper Using the MP Tray

When you use letterhead or preprinted paper for 2-sided printing, change the machine's settings.



DO NOT load different sizes and types of paper in the paper tray at the same time. Doing this may cause the paper to jam or misfeed.

Orientation

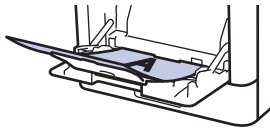
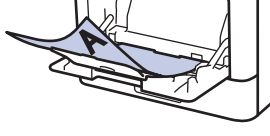
	For 1-sided printing <ul style="list-style-type: none">• face up• top edge first
	For automatic 2-sided printing (long edge binding) <ul style="list-style-type: none">• face down• bottom edge first

1. Press  [Settings] > [All Settings] > [Printer] > [2-sided] > [Single Image] > [2-sided Feed].



If your machine displays the [All Settings] menu on the Home screen, skip the [Settings] menu.

2. Press .



Related Information

- [Load Paper in the Multi-purpose Tray \(MP Tray\)](#)

Load and Print Labels Using the MP Tray

When the back cover (face up output tray) is pulled down, the machine has a straight paper path from the MP tray through to the back of the machine. Use this paper feed and output method when you print on labels.

When you load a different size and type of paper in the tray, you must also change the Paper Size and Paper Type settings in the machine, or on your computer.

1. Open the machine's back cover (the face up output tray).

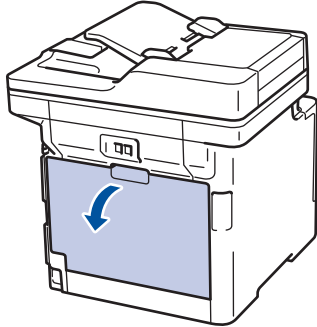

2. On the front of the machine, open the MP tray and lower it gently.

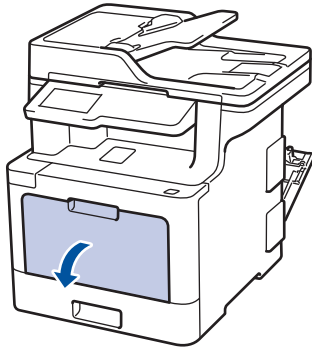

3. Pull out the MP tray support (1) and unfold the flap (2).

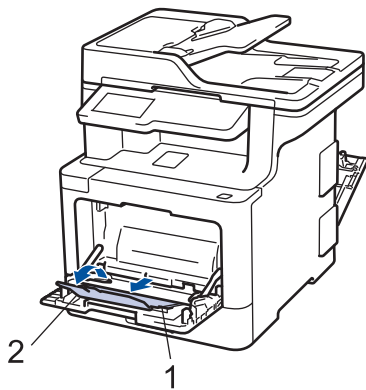

4. Slide the MP tray paper guides to fit the width of the paper you are using.
5. Load paper with the printing surface *face up* in the MP tray.

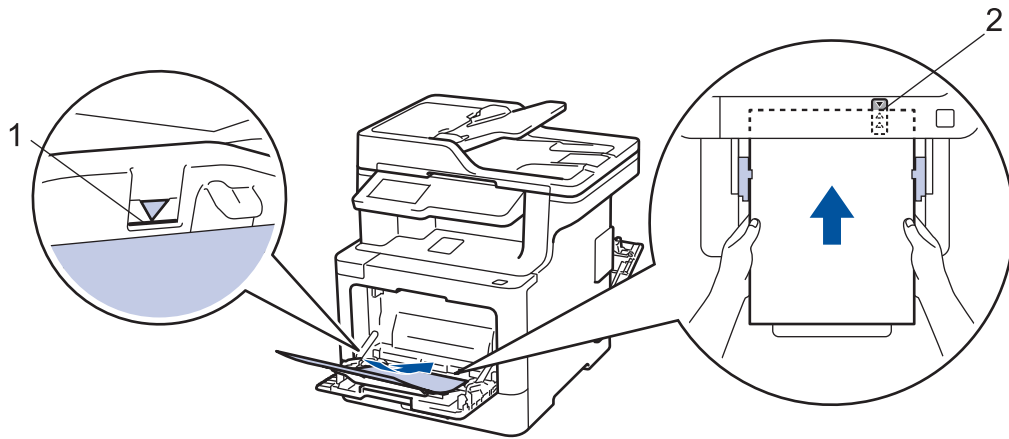

- Make sure the paper is below the maximum paper mark (1).
- Place the paper's leading edge (top of paper) between the ▲ and ▼ arrows (2).

6. Change your print preferences in the Print screen before sending the print job from your computer.
7. Send your print job to the machine.
8. Close the back cover (the face up output tray) until it locks in the closed position.



Related Information

- [Load and Print Using the Multi-purpose Tray \(MP Tray\)](#)

Load and Print Envelopes Using the MP Tray

You can load up to ten envelopes in the MP tray.

Before loading, press the corners and sides of the envelopes to make them as flat as possible.

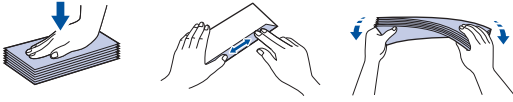

When you load a different size and type of paper in the tray, you must also change the Paper Size and Paper Type settings in the machine, or on your computer.

1. Open the machine's back cover (the face up output tray).

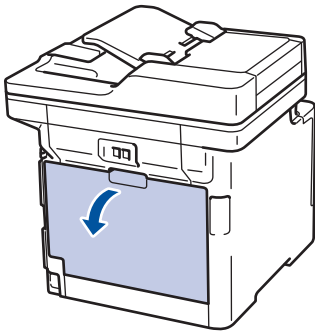

2. Pull down the two gray levers, one on the left side and one on the right side, as shown in the illustration.

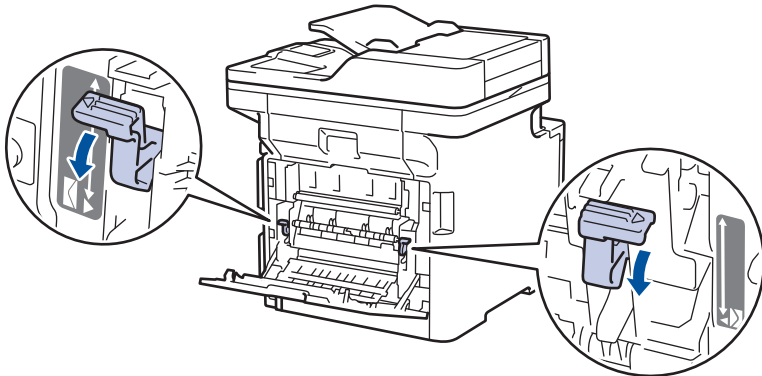

3. On the front of the machine, open the MP tray and lower it gently.

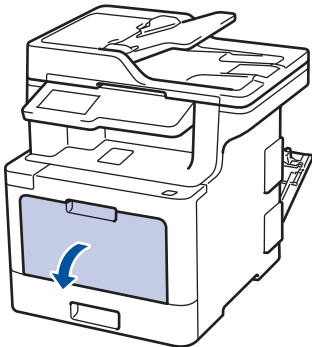

4. Pull out the MP tray support (1) and unfold the flap (2).

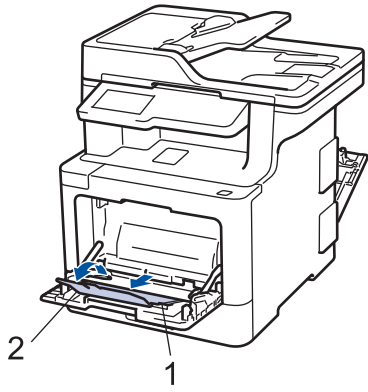

5. Slide the MP tray paper guides to fit the width of the envelopes that you are using.

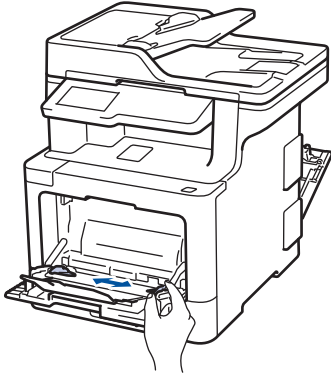

6. Load paper with the printing surface *face up* in the MP tray.

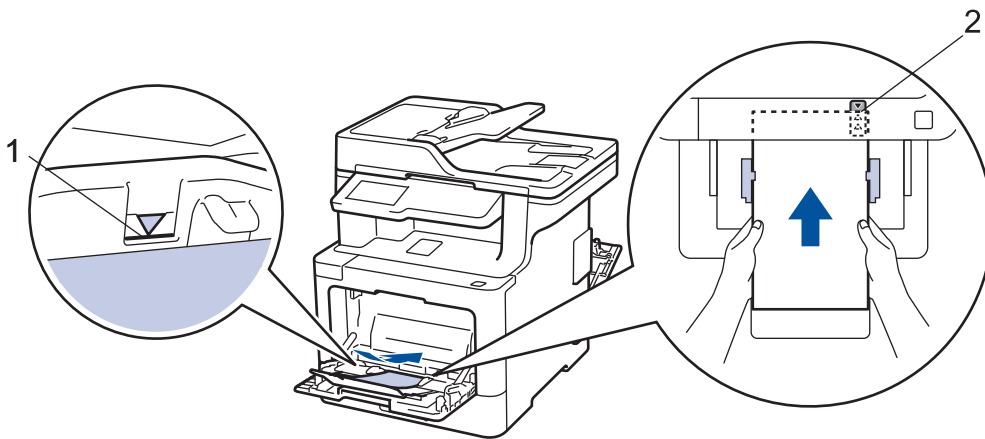

- Load up to 10 envelopes in the MP tray with the printing surface face up. Make sure the envelopes are below the maximum paper mark (1). Loading more than 10 envelopes may cause paper jams.
- Place the paper's leading edge (top of paper) between the ▲ and ▼ arrows (2).

7. Change your print preferences in the Print dialog box before sending the print job from your computer.

Settings	Options for Envelopes
Paper Size	Com-10 DL C5 Monarch
Media Type	Envelopes Env. Thick Env. Thin

8. Send your print job to the machine.

-
9. When you have finished printing, return the two gray levers you adjusted in the earlier step back to their original positions.
 10. Close the back cover (the face up output tray) until it locks in the closed position.



Related Information

- [Load and Print Using the Multi-purpose Tray \(MP Tray\)](#)
-

Paper Settings

- [Change the Paper Size and Paper Type](#)
- [Select the Tray to Be Used For Printing](#)
- [Change the Check Paper Size Setting](#)



Change the Paper Size and Paper Type

When you change the size and type of the paper you load in the tray, you must change the Paper Size and Paper Type settings on the LCD at the same time.

1. Press  [Settings] > [All Settings] > [General Setup] > [Tray Setting] > [Paper Type].



If your machine displays the [All Settings] menu on the Home screen, skip the [Settings] menu.

2. Press the option you want.
3. Swipe up or down or press ▲ or ▼ to display the paper type options, and then press the option you want.
4. Press .
5. Press [Paper Size].
6. Press the option you want.
7. Swipe up or down or press ▲ or ▼ to display the paper size options, and then press the option you want.
8. Press .



Related Information

- [Paper Settings](#)

Select the Tray to Be Used For Printing

Change the default tray the machine will use for printing copies, received faxes, and print jobs from your computer.

1. Press  [Settings] > [All Settings] > [General Setup] > [Tray Setting].



If your machine displays the [All Settings] menu on the Home screen, skip the [Settings] menu.

2. Swipe up or down or press ▲ or ▼ to display the [Tray Use: Copy], [Tray Use: Fax], or [Tray Use: Print] option, and then press the option you want.
3. Swipe up or down or press ▲ or ▼ to display the option you want, and then press it. For example, when you select the [MP>T1] option, the machine pulls paper from the MP tray until it is empty, and then from Tray 1.
4. Press .



- When you make a copy using the ADF and give priority to multiple trays, the machine looks for the tray with the most suitable paper and pulls paper from that tray.
- When you make a copy using the scanner glass, your document is copied from the higher priority tray even if more suitable paper is in another paper tray.
- (MFC models) Use the following sizes of paper for printing faxes: Letter, A4, Legal, Folio or Mexico Legal. When an appropriate size is not in any of the trays, the machine stores received faxes and [Size Mismatch] appears on the Touchscreen.
- (MFC models) If the tray is out of paper and received faxes are in the machine's memory, [No Paper] appears on the Touchscreen. Load paper in the empty tray.



Related Information

- [Paper Settings](#)

Change the Check Paper Size Setting

When you turn on your machine's Check Size setting, the machine displays a message when you remove a paper tray or load paper using the MP tray, asking if you changed the paper size and paper type.

The default setting is On.

1. Press  [Settings] > [All Settings] > [General Setup] > [Tray Setting] > [Check Size].



If your machine displays the [All Settings] menu on the Home screen, skip the [Settings] menu.

2. Press [On] or [Off].
3. Press .



Related Information

- [Paper Settings](#)

Recommended Print Media

To get the best print quality, we recommend using the paper listed in the table.

Paper Type	Item
Plain Paper	Xerox Vitality Multipurpose Printer Paper, 20 lb (20 lb = 75 g/m ²)
	Hammermill Laser Print (24 lb = 90 g/m ²)
Recycled Paper	No specific brand recommended
Labels	Avery laser labels white #5160
Envelopes	No specific brand recommended
Glossy Paper	NewPage Futura Laser Gloss 80 lb Text (80 lb = 118 g/m ²)



Related Information

- [Paper Handling](#)
- [Improve the Print Quality](#)

Load Documents

You can send a fax, make copies and scan from the Automatic Document Feeder (ADF) and from the scanner glass.

- [Load Documents in the Automatic Document Feeder \(ADF\)](#)
- [Load Documents on the Scanner Glass](#)

Load Documents in the Automatic Document Feeder (ADF)

Use the ADF when copying or scanning multiple-page, standard-sized documents.

- The ADF can hold the following pages and feed each sheet individually:
 - (MFC-L8610CDW)
Up to 50 sheets
 - (MFC-L8900CDW)
Up to 70 sheets
- Use standard 20 lb (80 g/m²) paper.
- Make sure documents with correction fluid or written in ink are completely dry.

IMPORTANT

- DO NOT leave thick documents on the scanner glass. If you do this, the ADF may jam.
- DO NOT use paper that is curled, wrinkled, folded, ripped, stapled, paper-clipped, pasted, or taped.
- DO NOT use cardboard, newspaper, or fabric.
- To avoid damaging your machine while using the ADF, DO NOT pull on the document while it is feeding.

Document Sizes Supported

Length:	5.8 to 14.0 in. (147.3 to 355.6 mm)
Width:	4.1 to 8.5 in. (105 to 215.9 mm)
Weight:	17 to 24 lb (64 to 90 g/m ²)

1. Unfold the ADF document output support flap.

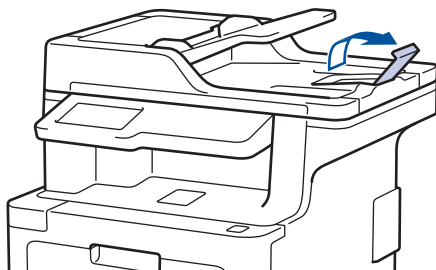

2. Fan the pages well.
3. Stagger the pages of your document and load it *face up* and *top edge first*, into the ADF as shown in the illustration.

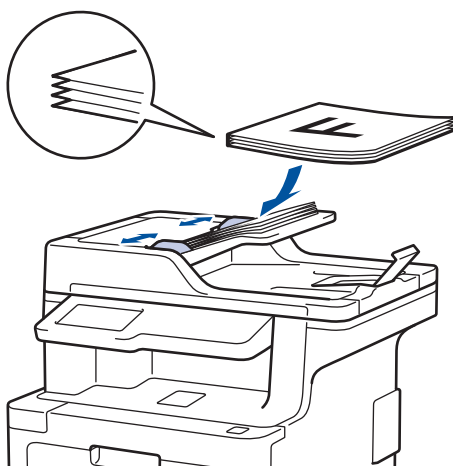

4. Adjust the paper guides to fit the width of your document.



Related Information

- [Load Documents](#)
-

Load Documents on the Scanner Glass

Use the scanner glass to fax, copy, or scan one page at a time.

Document Sizes Supported

Length:	<ul style="list-style-type: none">• (MFC-L8610CDW) Up to 11.8 in. (300 mm)• (MFC-L8900CDW) Up to 14 in. (355.6 mm)
Width:	Up to 8.5 in. (215.9 mm)
Weight:	Up to 4.4 lb (2 kg)



To use the scanner glass, the ADF must be empty.

1. Lift the document cover.
2. Place the document on the scanner glass *face down*.

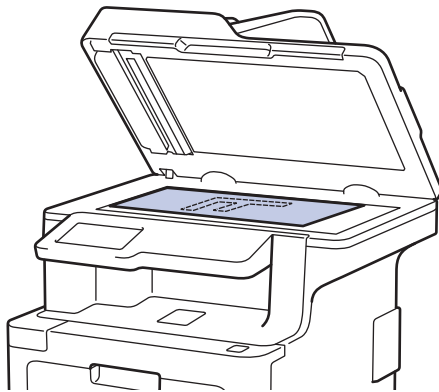

3. Place the corner of the page in the upper left corner of the scanner glass.

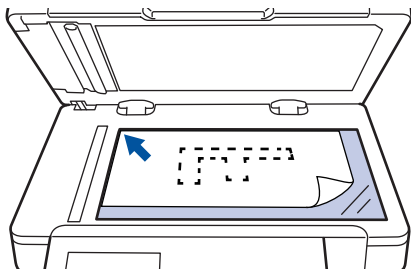

4. Close the document cover.
If the document is a book or is thick, gently press on the document cover.



Related Information

- [Load Documents](#)

Unscannable and Unprintable Areas

The measurements in the table below show maximum unscannable and unprintable areas from the edges of the most commonly-used paper sizes. These measurements may vary depending on the paper size or settings in the application you are using.

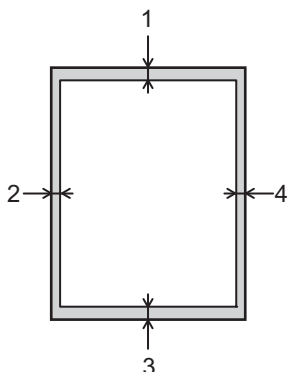

Do not attempt to scan, copy, or print into these areas; your output will not reflect anything in these areas.

Usage	Document Size	Top (1) Bottom (3)	Left (2) Right (4)
Fax (Sending)	Letter, Legal	0.12 in. (3 mm)	0.16 in. (4 mm)
	A4	0.12 in. (3 mm)	(ADF) 0.04 in. (1 mm) (Scanner Glass) 0.12 in. (3 mm)
Copy ¹	Letter, Legal	0.16 in. (4 mm)	0.16 in. (4 mm)
	A4	0.16 in. (4 mm)	0.12 in. (3 mm)
Scan	Letter	0.12 in. (3 mm)	0.12 in. (3 mm)
	A4	0.12 in. (3 mm)	0.12 in. (3 mm)
	Legal	0.12 in. (3 mm)	0.12 in. (3 mm)
Print	Letter, Legal	0.16 in. (4.2 mm)	0.16 in. (4.2 mm)
	A4	0.16 in. (4.2 mm)	0.16 in. (4.2 mm)



Related Information

- [Paper Handling](#)

¹ a 1 in 1 copy and 100% document size copy

Using Special Paper

Always test paper samples before purchasing them to ensure desirable performance.

- DO NOT use inkjet paper; it may cause a paper jam or damage your machine.
- If you use bond paper, paper with a rough surface, or paper that is wrinkled or creased, the paper may exhibit degraded performance.

Store paper in its original packaging and keep it sealed. Keep the paper flat and away from moisture, direct sunlight and heat.

IMPORTANT

Some types of paper may not perform well or may cause damage to your machine.

DO NOT use paper:

- that is highly textured
- that is extremely smooth or shiny
- that is curled or warped
- that is coated or has a chemical finish
- that is damaged, creased or folded
- that exceeds the recommended weight specification in this guide
- with tabs and staples
- with letterheads using low temperature dyes or thermography
- that is multipart or carbonless
- that is designed for inkjet printing

If you use any of the types of paper listed above, they may damage your machine. This damage is not covered under any Brother warranty or service agreement.



Related Information

- [Paper Handling](#)

Print

- [Print from Your Computer \(Windows®\)](#)
- [Print from Your Computer \(Macintosh\)](#)
- [Cancel a Print Job](#)
- [Test Print](#)

Print from Your Computer (Windows®)

- [Print a Document \(Windows®\)](#)
- [Print Settings \(Windows®\)](#)
- [Secure Print \(Windows®\)](#)
- [Change the Default Print Settings \(Windows®\)](#)
- [Print a Document Using the BR-Script3 Printer Driver \(PostScript® 3™ Language Emulation\) \(Windows®\)](#)
- [Monitor the Status of the Machine from Your Computer \(Windows®\)](#)

Print a Document (Windows®)

1. Select the print command in your application.
2. Select **Brother XXX-XXXX** (where XXXX is the name of your model), and then click the printing properties or preferences button.

The printer driver window appears.

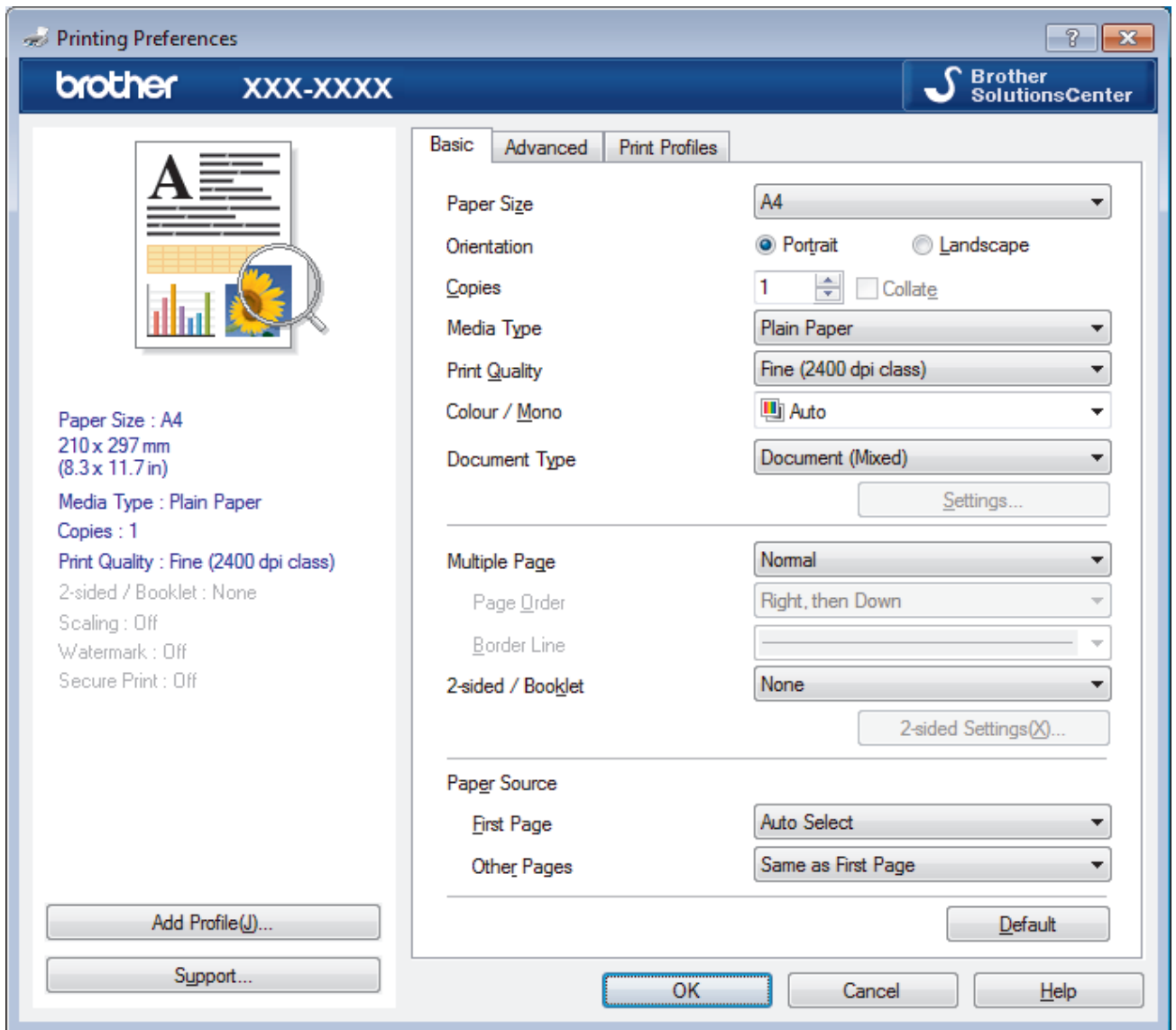

3. Make sure you have loaded the correct size paper in the paper tray.
4. Click the **Paper Size** drop-down list, and then select your paper size.
5. In the **Orientation** field, select the **Portrait** or **Landscape** option to set the orientation of your printout.



If your application contains a similar setting, we recommend that you set the orientation using the application.

6. Type the number of copies (1-999) you want in the **Copies** field.
7. Click the **Media Type** drop-down list, and then select the type of paper you are using.
8. To print multiple pages on a single sheet of paper or print one page of your document on multiple sheets, click the **Multiple Page** drop-down list, and then select your options.
9. Change other printer settings if needed.
10. Click **OK**.
11. Complete your print operation.



Related Information

- [Print from Your Computer \(Windows®\)](#)
- [Print Settings \(Windows®\)](#)

Print Settings (Windows®)

Basic Tab

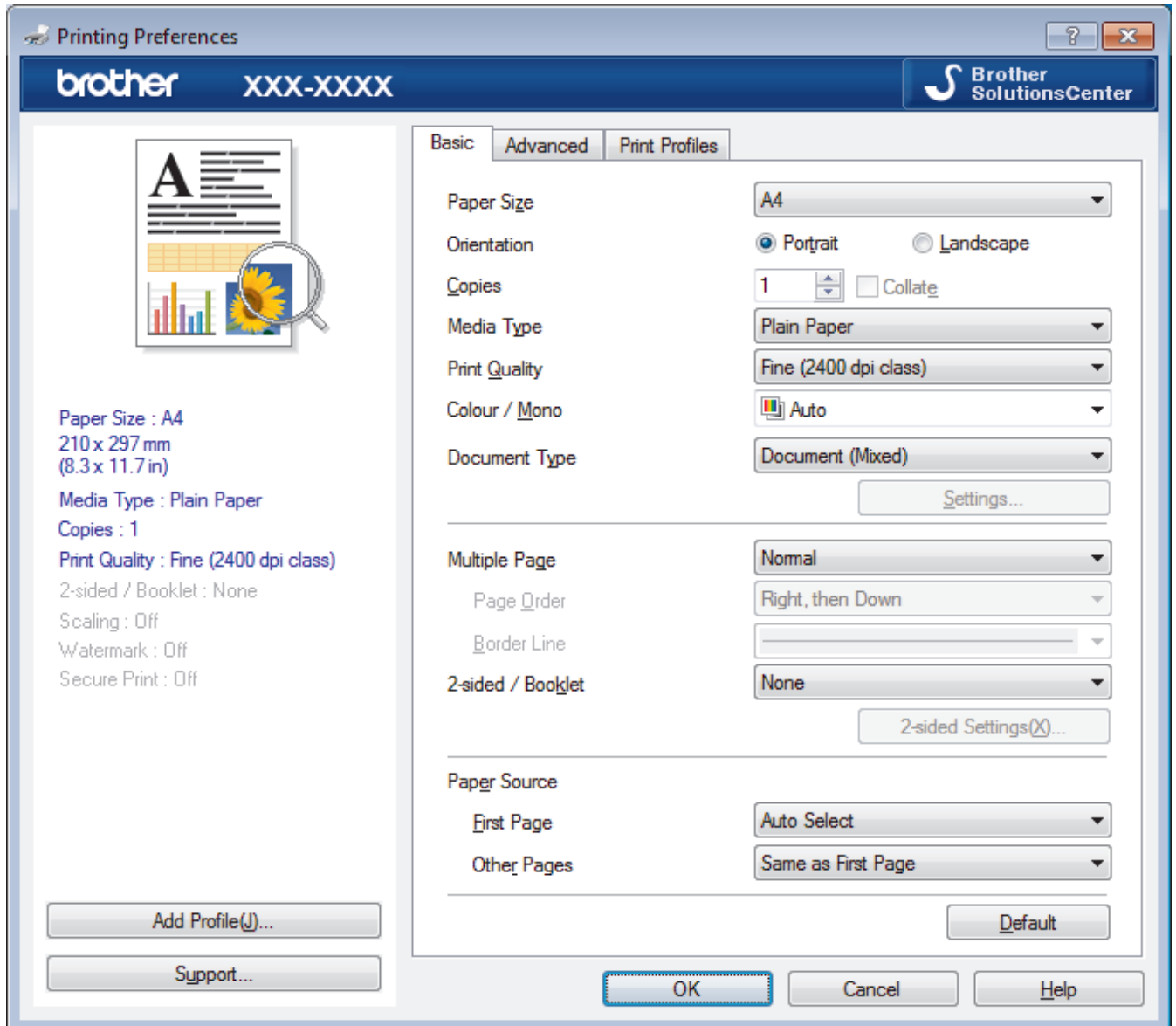

1. Paper Size

Select the size of the paper you want to use. You can either choose from standard paper sizes or create a custom paper size.

2. Orientation

Select the orientation (portrait or landscape) of your printout.

If your application contains a similar setting, we recommend that you set the orientation using the application.

3. Copies

Type the number of copies (1-999) that you want to print in this field.

Collate

Select this option to print sets of multi-page documents in the original page order. When this option is selected, one complete copy of your document will print, and then reprint according to the number of copies you choose. If this option is not selected, then each page will print according to the number of copies chosen before the next page of the document is printed.

4. Media Type

Select the type of media you want to use. To achieve the best print results, the machine automatically adjusts its print settings according to the selected media type.

5. Print Quality

Select the print resolution you want. Because print quality and speed are related, the higher the quality, the longer it will take to print the document.

6. Color / Mono

Select the Color/Mono settings to use.

NOTE

- The machine's color sensor is very sensitive and may perceive faded black text or an off-white background as color. If you know that your document is black and white and you want to conserve color toner, select **Mono** mode.
- If either the Cyan, Magenta or Yellow toner reaches the end of its life while printing a color document, the print job cannot be completed. Cancel your print job and select to start the print job again in **Mono** mode, as long as Black toner is available.

7. Document Type

Select the type of document you want to print.

Settings button

Specify advanced settings, such as color mode and other settings.

Color Mode

Select the color mode to suit your preference.

Import

To adjust the print configuration of a particular image, click **Settings**. When you have finished adjusting the image parameters, such as brightness and contrast, import those settings as a print configuration file. Use the **Export** option to create a print configuration file from the current settings.

Export

To adjust the print configuration of a particular image, click **Settings**. When you have finished adjusting the image parameters, such as brightness and contrast, export those settings as a print configuration file. Use the **Import** option to load a previously exported configuration file.

Improve Gray Color

Select this option to improve the image quality of shaded areas.

Enhance Black Printing

If a black graphic does not print correctly, select this setting.

Improve Pattern Printing

Select this option to improve the pattern printing if printed fills and patterns are different from the fills and patterns you see on your computer screen.

8. Multiple Page

Select this option to print multiple pages on a single sheet of paper or print one page of your document on multiple sheets.

Page Order

Select the page order when printing multiple pages on a single sheet of paper.

Border Line

Select the type of border to use when printing multiple pages on a single sheet of paper.

9. 2-sided / Booklet

Select this option to print on both sides of the paper or print a document in booklet format using 2-sided printing.

2-sided Settings button

Click this button to select the type of 2-sided binding. Four types of 2-sided bindings are available for each orientation.

10. Paper Source

Select the paper source setting according to your print conditions or purpose.

First Page

Select the paper source to use for printing the first page.

Other Pages

Select the paper source to use for printing the second and subsequent pages.

Advanced Tab

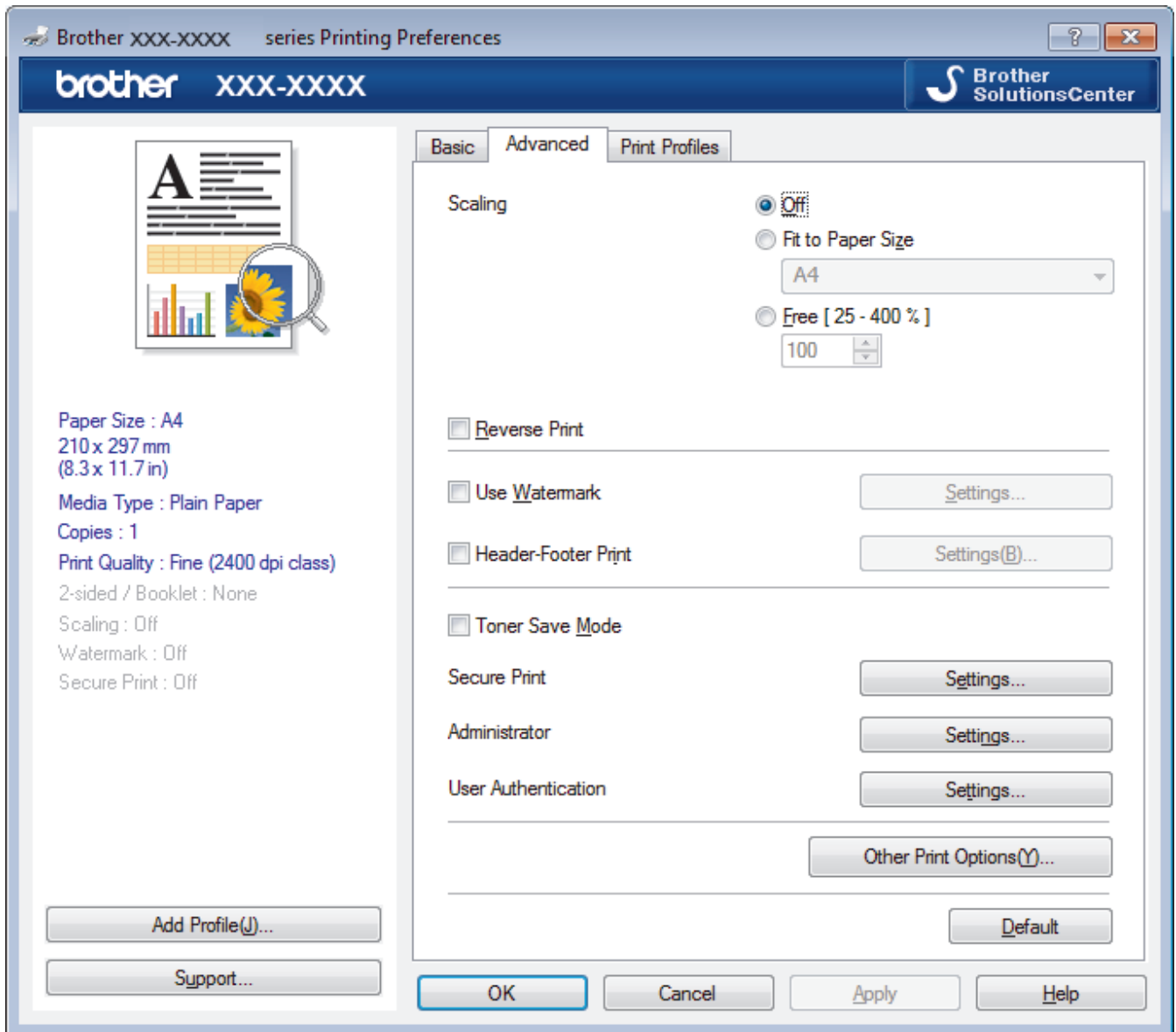

1. Scaling

Select these options to enlarge or reduce the size of the pages in your document.

Fit to Paper Size

Select this option to enlarge or reduce the document pages to fit a specified paper size. When you select this option, select the paper size you want from the drop-down list.

Free

Select this option to enlarge or reduce the document pages manually. When you select this option, type a value into the field.

2. Reverse Print

Select this option to rotate the printed image 180 degrees.

3. Use Watermark

Select this option to print a logo or text on your document as a watermark. Select one of the preset watermarks, add a new watermark, or use an image file you have created.

4. Header-Footer Print

Select this option to print the date, time and PC login user name on the document.

5. Toner Save Mode

Select this feature to conserve toner by using less toner to print documents; printouts appear lighter, but are still legible.

6. Secure Print

This feature ensures that confidential or sensitive documents do not print until you enter a password on the machine's control panel.

7. Administrator

This feature allows you to change the administrator password and restrict various printing functions.

8. User Authentication

This feature allows you to confirm the restrictions for each user.

9. Other Print Options button

Improve Print Output

Select this option to reduce the amount of paper curling and improve the toner fixing.

TrueType Mode

Mode

Select how the fonts are processed for printing.

Use Printer TrueType Fonts(Available only for certain models)

Select whether to use built-in fonts for the font processing.

Eco settings

Select this option to reduce printing noise.



Related Information

- [Print from Your Computer \(Windows®\)](#)
- [Print a Document \(Windows®\)](#)

Secure Print (Windows®)

Use Secure Print to ensure that confidential or sensitive documents do not print until you enter a password on the machine's control panel.

- The secure data is deleted from the machine when you turn off the machine.

1. Select the print command in your application.
2. Select **Brother XXX-XXXX** (where XXXX is the name of your model), and then click the printing properties or preferences button.
The printer driver window appears.
3. Click the **Advanced** tab.
4. Click the **Settings** button in the **Secure Print** field.
5. Select the **Secure Print** check box.
6. Type your four-digit password in the **Password** field.



You must set a separate password for each document.

7. Type the **User Name** and **Job Name** in the text field, if needed.
8. Click **OK**, to close the **Secure Print Settings** window.
9. Click **OK**.
10. Complete your print operation.
11. On the machine's control panel, swipe left or right or press ◀ or ▶ to display the [Secure Print] option, and then press [Secure Print].
12. Swipe up or down or press ▲ or ▼ to display user names, and then press your user name.
The LCD displays the list of secured jobs for your name.
13. Swipe up or down or press ▲ or ▼ to display the print job, and then press it.
14. Enter your four-digit password, and then press [OK].
15. Enter the number of copies you want.
16. Press [Start].
The machine prints the data.

After you have printed the secured data, it will be cleared from the machine's memory.



Related Information

- [Print from Your Computer \(Windows®\)](#)

Change the Default Print Settings (Windows®)

When you change an application's print settings, the changes only apply to documents printed with that application. To change print settings for all Windows® applications, you must configure the printer driver properties.

1. Do one of the following:

- For Windows Server® 2008

Click  (**Start**) > **Control Panel** > **Hardware and Sound** > **Printers**.

- For Windows® 7 and Windows Server® 2008 R2

Click  (**Start**) > **Devices and Printers**.

- For Windows® 8

Move your mouse to the lower right corner of your desktop. When the menu bar appears, click **Settings**, and then click **Control Panel**. In the **Hardware and Sound** group, click **View devices and printers**.

- For Windows® 10 and Windows Server® 2016

Click  > **Windows System** > **Control Panel**. In the **Hardware and Sound** group, click **View devices and printers**.

- For Windows Server® 2012

Move your mouse to the lower right corner of your desktop. When the menu bar appears, click **Settings**, and then click **Control Panel**. In the **Hardware** group, click **View devices and printers**.

- For Windows Server® 2012 R2

Click **Control Panel** on the **Start** screen. In the **Hardware** group, click **View devices and printers**.

2. Right-click the **Brother XXX-XXXX** icon (where XXXX is your model name), and then select **Printer properties**. If printer driver options appear, select your printer driver.

3. Click the **General** tab, and then click the **Printing Preferences...** or **Preferences...** button.

The printer driver dialog box appears.



- To configure the tray settings, click the **Device Settings** tab.
- To change the printer port, click the **Ports** tab.

4. Select the print settings you want to use as defaults for all of your Windows® programs.

5. Click **OK**.

6. Close the printer properties dialog box.





Related Information

- [Print from Your Computer \(Windows®\)](#)
- [Configure the Optional Tray Settings \(Windows®\)](#)

Configure the Optional Tray Settings (Windows®)

Access your machine's Properties to auto-detect your machine's Optional Tray and serial number.

The printer driver automatically detects the Optional Tray during the driver installation. If you added the Optional Tray after the driver installation, follow these steps:

1. Do one of the following:
 - For Windows Server® 2008
Click  (**Start**) > **Control Panel** > **Hardware and Sound** > **Printers**.
 - For Windows® 7 and Windows Server® 2008 R2
Click  (**Start**) > **Devices and Printers**.
 - For Windows® 8
Move your mouse to the lower right corner of your desktop. When the menu bar appears, click **Settings**, and then click **Control Panel**. In the **Hardware and Sound** group, click **View devices and printers**.
 - For Windows® 10 and Windows Server® 2016
Click  > **Windows System** > **Control Panel**. In the **Hardware and Sound** group, click **View devices and printers**.
 - For Windows Server® 2012
Move your mouse to the lower right corner of your desktop. When the menu bar appears, click **Settings**, and then click **Control Panel**. In the **Hardware** group, click **View devices and printers**.
 - For Windows Server® 2012 R2
Click **Control Panel** on the **Start** screen. In the **Hardware** group, click **View devices and printers**.
2. Right-click the **Brother XXX-XXXX** icon (where XXXX is your model name), and then select **Printer properties**. If printer driver options appear, select your printer driver.
3. Click the **Device Settings** tab.
4. Click the **Auto Detect** button.
The Optional Tray and the machine's serial number are automatically detected.
5. Click the **Apply** button.
6. Close the printer properties dialog box.

The **Auto Detect** function is not available under the following machine conditions:

- The machine power switch is off.
- The machine is in a network shared environment.
- The cable is not connected to the machine correctly.



Related Information

- [Change the Default Print Settings \(Windows®\)](#)

Print a Document Using the BR-Script3 Printer Driver (PostScript® 3™ Language Emulation) (Windows®)

The BR-Script3 printer driver lets you print PostScript® data more clearly.

To install the PS driver (BR-Script3 printer driver), launch the Brother installation disc, select **Custom** in the Select Machine section, and then select the **PS Driver** check box.

1. Select the print command in your application.
2. Select **Brother XXX-XXXX BR-Script3** (where XXXX is the name of your model), and then click the printing properties or preferences button.

The printer driver window appears.

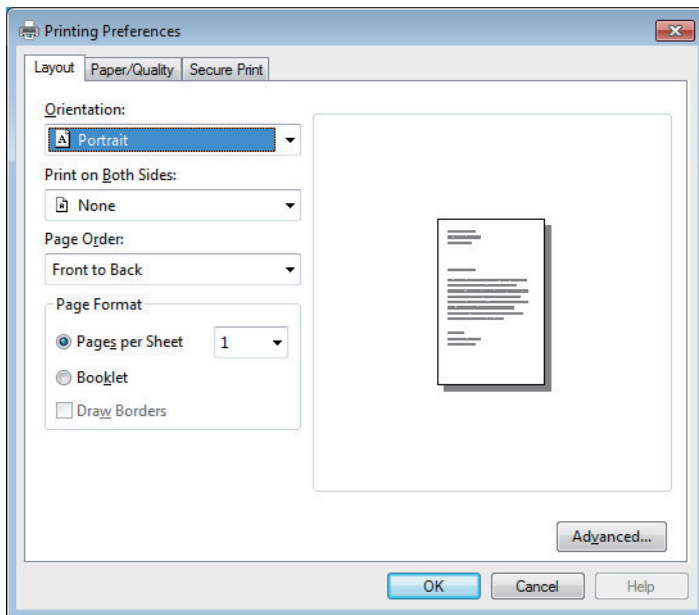

3. Click the **Layout**, **Paper/Quality**, or **Secure Print** tab to change basic print settings.
Click the **Layout** or **Paper/Quality** tab, and then click the **Advanced...** button to change advanced print settings.
4. Click **OK**.
5. Complete your print operation.

✓ Related Information

- [Print from Your Computer \(Windows®\)](#)

Monitor the Status of the Machine from Your Computer (Windows®)

The Status Monitor utility is a configurable software tool for monitoring the status of one or more devices, allowing you to get immediate notification of errors.

- Do one of the following:

- Double-click the  icon in the task tray.

- (Windows® 7)



Click  (**Start**) > **All Programs** > **Brother** > **Brother Utilities**.

Click the drop-down list and select your model name (if not already selected). Click **Tools** in the left navigation bar, and then click **Status Monitor**.

- (Windows® 8)

Click  (**Brother Utilities**), and then click the drop-down list and select your model name (if not already selected). Click **Tools** in the left navigation bar, and then click **Status Monitor**.

- (Windows® 8.1)

Move your mouse to the lower left corner of the **Start** screen and click  (if you are using a touch-based device, swipe up from bottom of the **Start** screen to bring up the **Apps** screen). When the **Apps** screen appears, tap or click  (**Brother Utilities**), and then click the drop-down list and select your model name (if not already selected). Click **Tools** in the left navigation bar, and then click **Status Monitor**.

- (Windows® 10)

Click  **Brother** > **Brother Utilities**.

Click the drop-down list and select your model name (if not already selected). Click **Tools** in the left navigation bar, and then click **Status Monitor**.

Troubleshooting

Click the **Troubleshooting** button to access the troubleshooting website.

Visit the Genuine Supplies website

Click the **Visit the Genuine Supplies website** button for more information on Brother genuine supplies.



Related Information

- [Print from Your Computer \(Windows®\)](#)
- [Printing Problems](#)
- [Calibrate Color Output](#)

Print from Your Computer (Macintosh)

- [Print a Document \(Macintosh\)](#)
- [Print Options \(Macintosh\)](#)
- [Secure Print \(Macintosh\)](#)
- [Print a Document Using the BR-Script3 Printer Driver \(PostScript® 3™ language emulation\) \(Macintosh\)](#)
- [Monitor the Status of the Machine from Your Computer \(Macintosh\)](#)

Print a Document (Macintosh)

1. Make sure you have loaded the correct size paper in the paper tray.
2. From an application, such as Apple TextEdit, click the **File** menu, and then select **Print**.
3. Select **Brother XXX-XXXX** (where XXXX is your model name).
4. Type the number of copies you want in the **Copies** field.
5. Click the **Paper Size** pop-up menu, and then select your paper size.
6. Select the **Orientation** option that matches the way you want the document to print.
7. Click the application pop-up menu, and then select **Print Settings**.

The **Print Settings** options appear.

8. Click the **Media Type** pop-up menu, and then select the type of paper you are using.
9. Change other printer settings, if needed.
10. Click **Print**.



Related Information

- [Print from Your Computer \(Macintosh\)](#)
 - [Print Options \(Macintosh\)](#)
-

Print Options (Macintosh)

Page Setup

Settings: **Page Attributes**

Format For: **XXX-XXXX**
Brother XXX-XXXX CUPS

Paper Size: **A4**
210 by 297 mm

Orientation: Portrait Landscape

Scale: **100** %

? Cancel OK

1. Paper Size

Select the size of the paper you want to use. You can either choose from standard paper sizes or create a custom paper size.

2. Orientation

Select the orientation (portrait or landscape) of your printout.

If your application contains a similar setting, we recommend that you set the orientation using the application.

3. Scale

Type a value into the field to enlarge or reduce the pages in your document to fit the selected paper size.

Layout

Printer: XXX-XXXX

Presets: Default Settings

Copies: 1 Two-Sided

Pages: All
 From: 1 to: 1

Paper Size: A4 210 by 297 mm

Orientation:

Layout

Pages per Sheet: 1

Layout Direction:

Border: None

Two-Sided: Off

Reverse page orientation
 Flip horizontally

? PDF Hide Details Cancel Print

1. Pages per Sheet

Select the number of pages to print on a single sheet of paper.

2. Layout Direction

Select the page order when printing multiple pages on a single sheet of paper.

3. Border

Select the type of border to use when printing multiple pages on a single sheet of paper.

4. Two-Sided

Select whether to print on both sides of the paper.

5. Reverse page orientation

Select this option to rotate the printed image 180 degrees.

6. Flip horizontally

Select this option to reverse the printed image on the page horizontally from left to right.

Paper Handling

Printer: XXX-XXXX

Presets: Default Settings

Copies: 1 Two-Sided

Pages: All
 From: 1 to: 1

Paper Size: A4 210 by 297 mm

Orientation:

Paper Handling

Collate pages

Pages to Print: All pages

Page Order: Automatic

Scale to fit paper size

Destination Paper Size: Suggested Paper: A4

Scale down only

1 of 1

PDF Hide Details Cancel Print

1. Collate pages

Select this option to print sets of multi-page documents in the original page order. When this option is selected, one complete copy of your document will print, and then reprint according to the number of copies you choose. If this option is not selected, then each page will print according to the number of copies chosen before the next page of the document is printed.

2. Pages to Print

Select which pages you want to print (even pages or odd pages).

3. Page Order

Select the page order.

4. Scale to fit paper size

Select this option to enlarge or reduce the pages in your document to fit the selected paper size.

5. Destination Paper Size

Select the paper size to print on.

6. Scale down only

Select this option if you want to reduce the pages in your document when they are too large for the selected paper size. If this option is selected and the document is formatted for a paper size that is smaller than the paper size you are using, the document will be printed at its original size.

Print Settings

Printer: XXX-XXXX

Presets: Default Settings

Copies: 1 Two-Sided

Pages: All
 From: 1 to: 1

Paper Size: A4 210 by 297 mm

Orientation: Portrait Landscape

Print Settings

Media Type: Plain Paper

Print Quality: Fine

Color / Mono: Auto

Paper Source: Auto Select

▶ Advanced

? PDF Hide Details Cancel Print

1. Media Type

Select the type of media you want to use. To achieve the best print results, the machine automatically adjusts its print settings according to the selected media type.

2. Print Quality

Select the print resolution you want. Because print quality and speed are related, the higher the quality, the longer it will take to print the document.

3. Color / Mono

Select the Color/Mono settings to use.

NOTE

- The machine's color sensor is very sensitive and may perceive faded black text or an off-white background as color. If you know that your document is black and white and you want to conserve color toner, select **Mono** mode.
- If either the Cyan, Magenta or Yellow toner reaches the end of its life while printing a color document, the print job cannot be completed. Cancel your print job and select to start the print job again in **Mono** mode, as long as Black toner is available.

4. Paper Source

Select the paper source setting according to your print conditions or purpose.

5. Advanced

Toner Save Mode

Select this feature to conserve toner by using less toner to print documents; printouts appear lighter, but are still legible.

Improve Print Output

Select this option to reduce the amount of paper curling and improve the toner fixing.

Quiet Mode

Select this option to reduce printing noise.

Other Print Options

Skip Blank Page

Select this option to allow the printer driver to automatically detect blank pages and exclude them from printing.

Color Settings

Printer: XXX-XXXX

Presets: Default Settings

Copies: 1 Two-Sided

Pages: All
 From: 1 to: 1

Paper Size: A4 210 by 297 mm

Orientation: Portrait Landscape

Color Settings

Color Mode: Normal
 Vivid
 None

▼ Advanced Color Settings

Brightness	0	<input type="range"/>
Contrast	0	<input type="range"/>
Red	0	<input type="range"/>
Green	0	<input type="range"/>
Blue	0	<input type="range"/>
Saturation	0	<input type="range"/>

Improve Gray Color
 Enhance Black Printing

? PDF Hide Details Cancel Print

1. Color Mode

Select the color mode to suit your preference.

2. Advanced Color Settings

Click the disclosure triangle to select the Color Enhancement feature. This feature analyzes your image to improve its sharpness, white balance and color density. This process may take several minutes depending on the size of the image and the specifications of your computer.

Secure Print

Printer: XXX-XXXX

Presets: Default Settings

Copies: 1 Two-Sided

Pages: All
 From: 1 to: 1

Paper Size: A4 210 by 297 mm

Orientation:

Secure Print

Secure Print

User Name :

Job Name :

Password :

? PDF Hide Details Cancel Print

1. Secure Print

This feature ensures that confidential or sensitive documents do not print until you enter a password on the machine's control panel.

Related Information

- [Print from Your Computer \(Macintosh\)](#)
- [Print a Document \(Macintosh\)](#)

Secure Print (Macintosh)

Use Secure Print to ensure that confidential or sensitive documents do not print until you enter a password on the machine's control panel.

- The secure data is deleted from the machine when you turn off the machine.

1. From an application, such as Apple TextEdit, click the **File** menu, and then select **Print**.
2. Select **Brother XXX-XXXX** (where XXXX is your model name).
3. Click the application pop-up menu, and then select the **Secure Print** option. The **Secure Print** options appear.
4. Select the **Secure Print** check box.
5. Type your user name, job name and a four-digit password.
6. Click **Print**.
7. On the machine's control panel, swipe left or right or press ◀ or ▶ to display the [Secure Print] option, and then press [Secure Print].
8. Swipe up or down or press ▲ or ▼ to display user names, and then press your user name.
The LCD displays the list of secured jobs for your name.
9. Swipe up or down or press ▲ or ▼ to display the print job, and then press it.
10. Enter your four-digit password, and then press [OK].
11. Enter the number of copies you want.
12. Press [Start].

After you have printed the secured data, it will be cleared from the machine's memory.



Related Information

- [Print from Your Computer \(Macintosh\)](#)

Print a Document Using the BR-Script3 Printer Driver (PostScript® 3™ language emulation) (Macintosh)

The BR-Script3 printer driver lets you print PostScript® data more clearly.

- Go to your model's **Downloads** page on the Brother Solutions Center at support.brother.com to download the PS driver (BR-Script3 printer driver).
- Make sure you have added the BR-Script3 printer driver from **Print & Scan** or **Printers & Scanners** in the **System Preferences** list on your Macintosh.

1. Make sure you have loaded the correct size paper in the paper tray.
2. From an application, such as Apple TextEdit, click the **File** menu, and then select **Print**.
3. Select your machine.
4. Type the number of copies you want in the **Copies** field.
5. Click the **Paper Size** pop-up menu, and then select your paper size.
6. Select the **Orientation** option that matches the way you want the document to print.
7. Click the print options pop-up menu, and then click **Printer Features**.
The **Printer Features** options appear.
8. Click the **Print Quality** pop-up menu, and then select the print quality.
9. Click the **Media Type** pop-up menu, and then select the type of paper you are using.
10. Select the **Auto**, **Color**, or **Mono** option for the **Color / Mono** print setting.
11. Change other printer settings, if needed.
12. Click **Print**.



Related Information

- [Print from Your Computer \(Macintosh\)](#)

Monitor the Status of the Machine from Your Computer (Macintosh)

The Status Monitor utility is a configurable software tool for monitoring the status of a device, allowing you to get immediate notification of error messages, such as paper empty or paper jam, at preset update intervals. You can also access Web Based Management.

1. Click the **System Preferences** menu, select **Print & Scan** or **Printers & Scanners**, and then select your machine.
2. Click the **Options & Supplies** button.
3. Click the **Utility** tab, and then click the **Open Printer Utility** button.

Status Monitor starts.

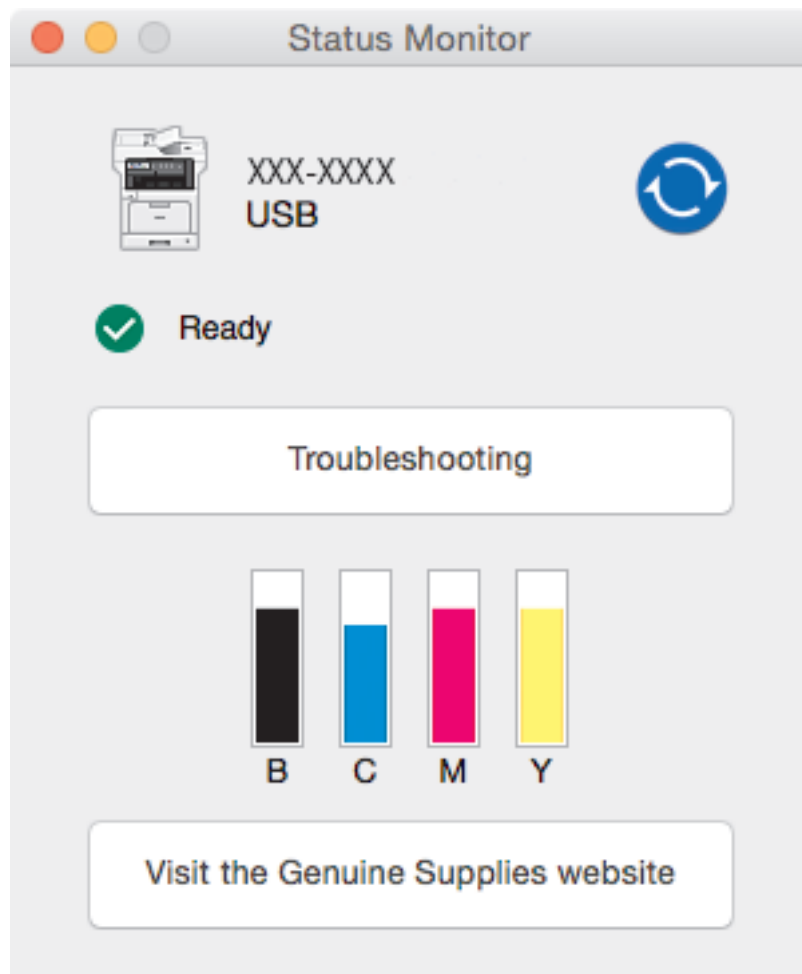

Troubleshooting

Click the **Troubleshooting** button to access the troubleshooting website.

Visit the Genuine Supplies website

Click the **Visit the Genuine Supplies website** button for more information on Brother genuine supplies.

Updating the machine's status

To view the latest machine status while the **Status Monitor** window is open, click the  icon. You can set the interval at which the software updates machine status information. Click **Brother Status Monitor** in the menu bar, and then select **Preferences**.

Web Based Management (Network Connection Only)

Access the Web Based Management System by clicking the machine icon on the **Status Monitor** screen. You can use a standard Web Browser to manage your machine using HTTP (Hyper Text Transfer Protocol).



Related Information

- [Print from Your Computer \(Macintosh\)](#)
 - [Printing Problems](#)
 - [Calibrate Color Output](#)
-

Cancel a Print Job

1. Press .



To cancel multiple print jobs, press and hold  for about four seconds.



Related Information

- [Print](#)
- [Printing Problems](#)

Test Print

If there are problems with print quality, follow these instructions to do a test print:

1. Press  [Settings] > [All Settings] > [Printer] > [Print Options] > [Test Print].



If your machine displays the [All Settings] menu on the Home screen, skip the [Settings] menu.

2. Press [Yes].
3. Press .



Related Information

- [Print](#)
- [Improve the Print Quality](#)

Scan

- [Scan Using the Scan Button on Your Brother Machine](#)
- [Scan from Your Computer \(Windows®\)](#)
- [Scan from Your Computer \(Macintosh\)](#)
- [Configure Scan Settings Using Web Based Management](#)

Scan Using the Scan Button on Your Brother Machine

- [Scan Photos and Graphics](#)
- [Save Scanned Data to a Folder as a PDF File](#)
- [Save Scanned Data to a USB Flash Drive](#)
- [Scan to an Editable Text File \(OCR\)](#)
- [Scan to Email Attachment](#)
- [Send Scanned Data to an Email Server](#)
- [Scan to FTP](#)
- [Scan to SSH FTP \(SFTP\)](#)
- [Scan to Network \(Windows®\)](#)
- [Scan to SharePoint®](#)
- [Web Services for Scanning on Your Network \(Windows® 7, Windows® 8 and Windows® 10\)](#)
- [Change Scan Button Settings from ControlCenter4 \(Windows®\)](#)
- [Change Scan Button Settings from ControlCenter2 \(Macintosh\)](#)
- [Configure Certificate for Signed PDF](#)
- [Disable Scanning from Your Computer](#)

Scan Photos and Graphics

Send scanned photos or graphics directly to your computer.

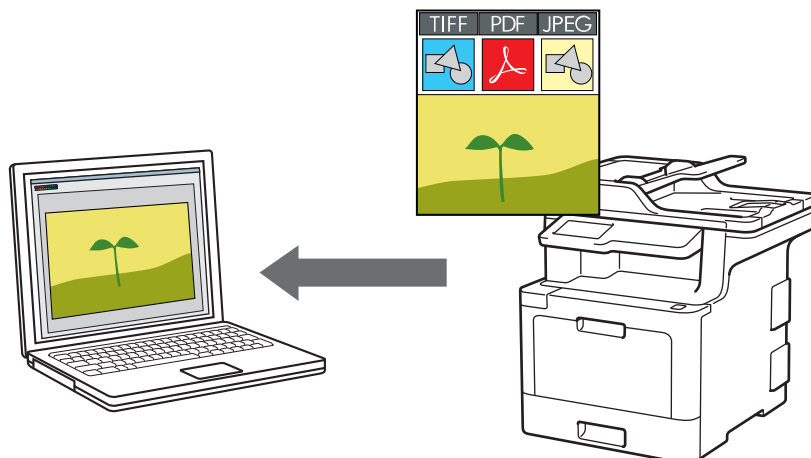

Use the Scan button on the machine to make temporary changes to the scan settings. To make permanent changes, use Brother's ControlCenter software.

1. Load your document.
2. Press [Scan] > [to PC] > [to Image] .
3. If the machine is connected over the network, select the computer name you want to send data.



If the LCD prompts you to enter a PIN for the computer, enter the four-digit PIN on the LCD, and then press [OK].

4. Do one of the following:
 - To change the scan settings, press [Options], and then go to the next step.
 - To use the default scan settings, press [Start].The machine starts scanning. If using the machine's scanner glass, follow the Touchscreen instructions to complete the scanning job.



To change scan settings, a computer with Brother's ControlCenter software installed must be connected to the machine.

5. To scan both sides of the document (MFC-L8900CDW):
 - Press [2-sided Scan], and then select the document type.

Option	Description
2-sided Scan: Long Edge	

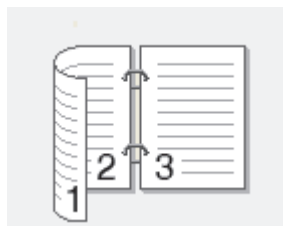

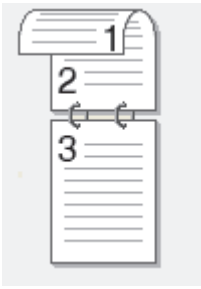
Option	Description
2-sided Scan: Short Edge	

6. Select the scan settings you want to change:

- [Resolution]
 - [File Type]
 - [Scan Type]
 - [Document Size]
 - [Scan Settings]
 - [Brightness]
 - [Contrast]
- (available only for the [Color] and [Gray] options)
- [ADF Auto Des skew]
 - [Skip Blank Page]
 - [Remove Background Color]
- (available only for the [Color] and [Gray] options)



- If your machine displays the [OK] button, press [OK].
- To save the settings as a shortcut, press [Save as Shortcut].

7. Press [Start].

The machine starts scanning. If using the machine's scanner glass, follow the Touchscreen instructions to complete the scanning job.



Related Information

- [Scan Using the Scan Button on Your Brother Machine](#)
- [Change Scan Button Settings from ControlCenter4 \(Windows®\)](#)
- [Change Scan Button Settings from ControlCenter2 \(Macintosh\)](#)

Save Scanned Data to a Folder as a PDF File

Scan documents and save them to a folder on your computer as PDF files.

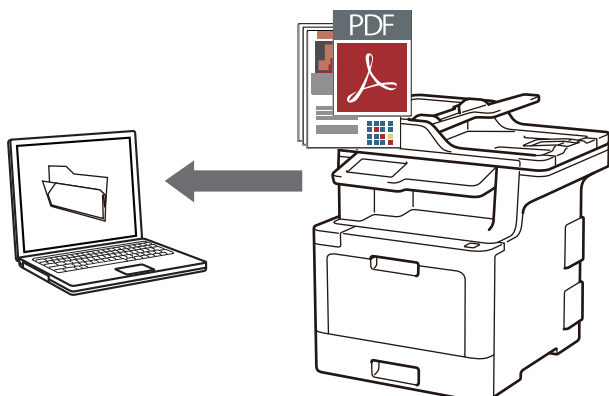

Use the Scan button on the machine to make temporary changes to the scan settings. To make permanent changes, use Brother's ControlCenter software.

1. Load your document.
2. Press [Scan] > [to PC] > [to File] .
3. If the machine is connected over the network, select the computer name you want to send data.



If the LCD prompts you to enter a PIN for the computer, enter the four-digit PIN on the LCD, and then press [OK].

4. Do one of the following:
 - To change the scan settings, press [Options], and then go to the next step.
 - To use the default scan settings, press [Start].The machine starts scanning. If using the machine's scanner glass, follow the Touchscreen instructions to complete the scanning job.



To change scan settings, a computer with Brother's ControlCenter software installed must be connected to the machine.

5. To scan both sides of the document (MFC-L8900CDW):
 - Press [2-sided Scan], and then select the document type.

Option	Description
2-sided Scan: Long Edge	

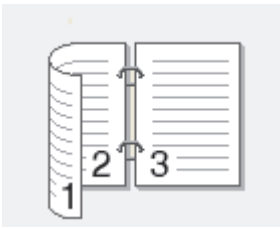

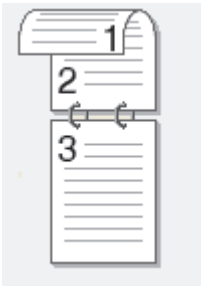
Option	Description
2-sided Scan: Short Edge	

6. Select the scan settings you want to change:

- [Resolution]
 - [File Type]
 - [Scan Type]
 - [Document Size]
 - [Scan Settings]
 - [Brightness]
 - [Contrast]
- (available only for the [Color] and [Gray] options)
- [ADF Auto Des skew]
 - [Skip Blank Page]
 - [Remove Background Color]
- (available only for the [Color] and [Gray] options)



- If your machine displays the [OK] button, press [OK].
- To save the settings as a shortcut, press [Save as Shortcut].

7. Press [Start].

The machine starts scanning. If using the machine's scanner glass, follow the Touchscreen instructions to complete the scanning job.



Related Information

- [Scan Using the Scan Button on Your Brother Machine](#)
- [Change Scan Button Settings from ControlCenter4 \(Windows®\)](#)
- [Change Scan Button Settings from ControlCenter2 \(Macintosh\)](#)

Save Scanned Data to a USB Flash Drive

Scan documents directly to a USB flash drive.

1. Load your document.
2. Insert a USB flash drive into your machine.
The LCD automatically changes.
3. Press [Scan to USB].
4. Do one of the following:
 - To change the settings, press [Options], and then select the button you want to change. Follow the machine's instructions.



- To set your own default settings: after making changes to settings, press the [Set New Default] option, and then press [Yes].
- To restore the factory settings: press [Factory Reset], and then press [Yes].

5. To scan both sides of the document (MFC-L8900CDW):
 - Press [2-sided Scan], and then select the document type.

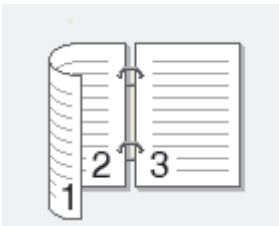
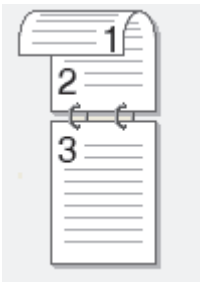
Option	Description
2-sided Scan: Long Edge	
2-sided Scan: Short Edge	

6. Select the scan settings you want to change:
 - [Resolution]
 - [File Type]
 - [Scan Type]
 - [Document Size]
 - [Brightness]
 - [Contrast]
 - (available only for the [Color] and [Gray] options)
 - [File Name]
 - [File Name Style]
 - [File Size]
 - [ADF Auto Des skew]

-
- [Skip Blank Page]
 - [Skip Blank Page Sensitivity]
 - [Remove Background Color]
(available only for the [Color] and [Gray] options)



-
- If your machine displays the [OK] button, press [OK].
 - To save the settings as a shortcut, press [Save as Shortcut].
-

7. Press [Start].

The machine starts scanning. If using the machine's scanner glass, follow the Touchscreen instructions to complete the scanning job.

IMPORTANT

The LCD displays a message while reading the data. DO NOT unplug the power cord or remove the USB flash drive from the machine while it is reading the data. You could lose your data or damage the USB flash drive.



Related Information

- [Scan Using the Scan Button on Your Brother Machine](#)
-

Scan to an Editable Text File (OCR)

Your machine can convert characters in a scanned document to text using optical character recognition (OCR) technology. You can edit this text using your preferred text-editing application.

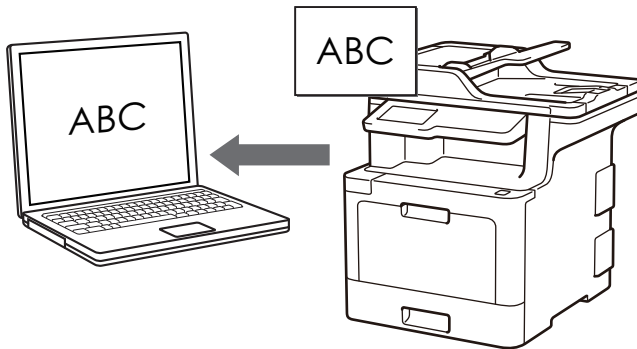

- The Scan to OCR feature is available for certain languages.
- Use the Scan button on the machine to make temporary changes to the scan settings. To make permanent changes, use Brother's ControlCenter software.

1. Load your document.
2. Press [Scan] > [to PC] > [to OCR].
3. If the machine is connected over the network, select the computer name you want to send data.



If the LCD prompts you to enter a PIN for the computer, enter the four-digit PIN on the LCD, and then press [OK].

4. Do one of the following:
 - To change the scan settings, press [Options], and then go to the next step.
 - To use the default scan settings, press [Start].The machine starts scanning. If using the machine's scanner glass, follow the Touchscreen instructions to complete the scanning job.



To change scan settings, a computer with Brother's ControlCenter software installed must be connected to the machine.

5. To scan both sides of the document (MFC-L8900CDW):
 - Press [2-sided Scan], and then select the document type.

Option	Description
2-sided Scan: Long Edge	

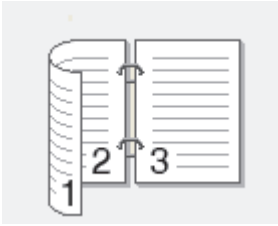

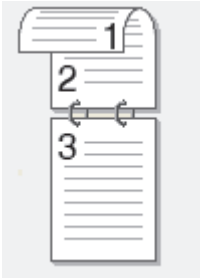
Option	Description
2-sided Scan: Short Edge	

6. Select the scan settings you want to change:

- [Resolution]
 - [File Type]
 - [Scan Type]
 - [Document Size]
 - [Scan Settings]
 - [Brightness]
 - [Contrast]
- (available only for the [Color] and [Gray] options)
- [ADF Auto Des skew]
 - [Skip Blank Page]
 - [Remove Background Color]
- (available only for the [Color] and [Gray] options)



- If your machine displays the [OK] button, press [OK].
- To save the settings as a shortcut, press [Save as Shortcut].

7. Press [Start].

The machine starts scanning. If using the machine's scanner glass, follow the Touchscreen instructions to complete the scanning job.



Related Information

- [Scan Using the Scan Button on Your Brother Machine](#)
- [Change Scan Button Settings from ControlCenter4 \(Windows®\)](#)
- [Change Scan Button Settings from ControlCenter2 \(Macintosh\)](#)

Scan to Email Attachment

Send a scanned document as an email attachment.

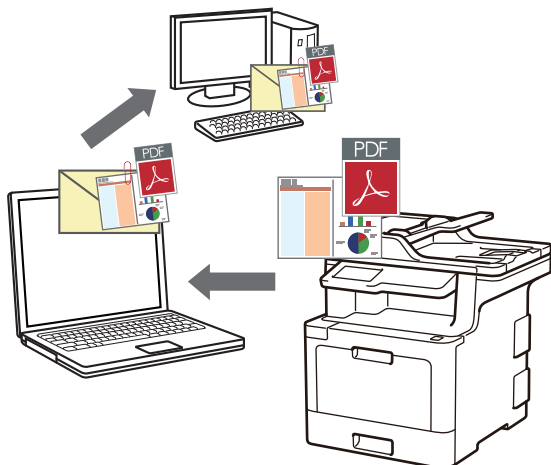

- Use the Scan button on the machine to make temporary changes to the scan settings. To make permanent changes, use Brother's ControlCenter software.
- The Scan to Email feature does not support Webmail services. Use the Scan to Image or Scan to File feature to scan a document or a picture, and then attach the scanned file to an email message.



The machine scans to your default email client.

1. Load your document.
2. Press [Scan] > [to PC] > [to E-mail] .
3. If the machine is connected over the network, select the computer name you want to send data.



If the LCD prompts you to enter a PIN for the computer, enter the four-digit PIN on the LCD, and then press [OK].

4. Do one of the following:
 - To change the scan settings, press [Options], and then go to the next step.
 - To use the default scan settings, press [Start].

The machine starts scanning. If using the machine's scanner glass, follow the Touchscreen instructions to complete the scanning job.



To change scan settings, a computer with Brother's ControlCenter software installed must be connected to the machine.

5. To scan both sides of the document (MFC-L8900CDW):
 - Press [2-sided Scan], and then select the document type.

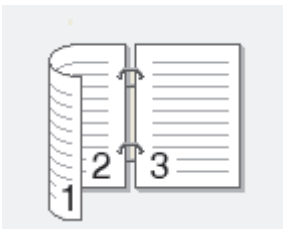
Option	Description
2-sided Scan: Long Edge	

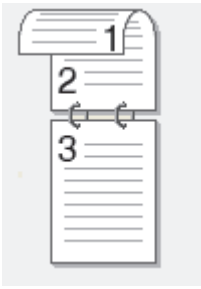
Option	Description
2-sided Scan: Short Edge	

6. Select the scan settings you want to change:

- [Resolution]
- [File Type]
- [Scan Type]
- [Document Size]
- [Scan Settings]
- [Brightness]
- [Contrast]
(available only for the [Color] and [Gray] options)
- [ADF Auto Deskew]
- [Skip Blank Page]
- [Remove Background Color]
(available only for the [Color] and [Gray] options)



- If your machine displays the [OK] button, press [OK].
- To save the settings as a shortcut, press [Save as Shortcut].

7. Press [Start].

The machine starts scanning. If using the machine's scanner glass, follow the Touchscreen instructions to complete the scanning job.



Related Information

- [Scan Using the Scan Button on Your Brother Machine](#)
- [Change Scan Button Settings from ControlCenter4 \(Windows®\)](#)
- [Change Scan Button Settings from ControlCenter2 \(Macintosh\)](#)

Send Scanned Data to an Email Server

Send scanned data from your Brother machine directly to your email server, for delivery to an email recipient without using a computer.

- (MFC-L8610CDW)
To use this function, go to your model's **Downloads** page on the Brother Solutions Center at support.brother.com to update your machine's firmware or the program in your machine.
- To send scanned data to an email server, you must configure your machine to communicate with your network and mail server. You can configure these items from the machine's control panel, Web Based Management, Remote Setup, or BRAdmin Professional 3.

1. Load your document.
2. Press [Scan] > [to E-mail Server] .



- If you registered your email address with your user ID, the [to My E-mail] option appears when you log on to the machine using Secure Function Lock, Active Directory® Authentication, or LDAP Authentication.
- To send scanned data to your email address, press [to My E-mail]. When your email address appears on the LCD, press [OK].
- To enable this feature in Web Based Management, click the **Scan** tab, and then click the **Scan to E-mail Server** menu in the left navigation bar. In the **Send to My E-mail** field, select **On**.

3. Do one of the following to enter the destination email address:
 - To enter the email address manually, press [Manual], and then enter the email address using the keyboard on the LCD. When finished, press [OK].
 - If the email address is stored in the machine's address book, press [Address Book], and then select the email address.
Press [OK].
4. Confirm the email address, and then press [Next].
5. Do one of the following:
 - To change the settings, press [Options], and then select the button you want to change. Follow the machine's instructions.



- To set your own default settings: after making changes to settings, press the [Set New Default] option, and then press [Yes].
- To restore the factory settings: press [Factory Reset], and then press [Yes].

6. To scan both sides of the document (MFC-L8900CDW):
 - Press [2-sided Scan], and then select the document type.

Option	Description
2-sided Scan: Long Edge	

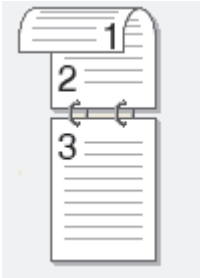
Option	Description
2-sided Scan: Short Edge	

7. Select the scan settings you want to change:

- [Resolution]
- [File Type]
- [Scan Type]
- [Document Size]
- [Brightness]
- [Contrast]
- (available only for the [Color] and [Gray] options)
- [File Name]
- [File Name Style]
- [File Size]
- [ADF Auto Des skew]
- [Skip Blank Page]
- [Skip Blank Page Sensitivity]
- [Remove Background Color]
- (available only for the [Color] and [Gray] options)



- If your machine displays the [OK] button, press [OK].
 - To save the settings as a shortcut, press [Save as Shortcut].
- (This function may not be available depending on your machine conditions.)

8. Press [Start].

The machine starts scanning. If using the machine's scanner glass, follow the Touchscreen instructions to complete the scanning job.



Related Information

- [Scan Using the Scan Button on Your Brother Machine](#)

Scan to FTP

Scan documents directly to an FTP server when you need to share the scanned information. For added convenience, configure different profiles to save your favorite Scan to FTP destinations.

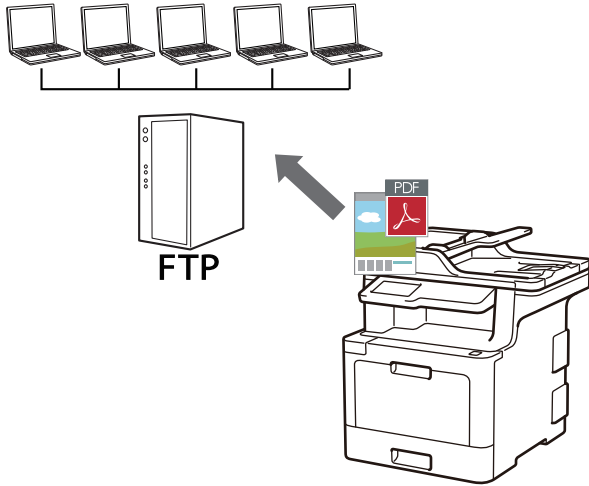

- [Set up a Scan to FTP Profile](#)
- [Upload Scanned Data to an FTP Server](#)

Set up a Scan to FTP Profile

Set up a Scan to FTP Profile to scan and upload the scanned data directly to an FTP location.

We recommend Microsoft® Internet Explorer® 11 for Windows® and Safari 9 for Macintosh. Make sure that JavaScript and Cookies are always enabled in whichever browser you use.

1. Start your web browser.

Type "http://machine's IP address" in your browser's address bar (where "machine's IP address" is the IP address of the machine or the print server name). For example: http://192.168.1.2

No password is required by default. If you have previously set a password, type it, and then click .

2. Click the **Scan** tab.
3. Click the **Scan to FTP/SFTP/Network/SharePoint** menu in the left navigation bar.
4. Select the **FTP** option, and then click **Submit**.

Scan to FTP/SFTP/Network/SharePoint

Profile 1	<input checked="" type="radio"/> FTP <input type="radio"/> SFTP <input type="radio"/> Network <input type="radio"/> SharePoint
Profile 2	<input checked="" type="radio"/> FTP <input type="radio"/> SFTP <input type="radio"/> Network <input type="radio"/> SharePoint
Profile 3	<input checked="" type="radio"/> FTP <input type="radio"/> SFTP <input type="radio"/> Network <input type="radio"/> SharePoint
Profile 4	<input checked="" type="radio"/> FTP <input type="radio"/> SFTP <input type="radio"/> Network <input type="radio"/> SharePoint
Profile 5	<input checked="" type="radio"/> FTP <input type="radio"/> SFTP <input type="radio"/> Network <input type="radio"/> SharePoint
Profile 6	<input checked="" type="radio"/> FTP <input type="radio"/> SFTP <input type="radio"/> Network <input type="radio"/> SharePoint
Profile 7	<input checked="" type="radio"/> FTP <input type="radio"/> SFTP <input type="radio"/> Network <input type="radio"/> SharePoint
Profile 8	<input checked="" type="radio"/> FTP <input type="radio"/> SFTP <input type="radio"/> Network <input type="radio"/> SharePoint
Profile 9	<input checked="" type="radio"/> FTP <input type="radio"/> SFTP <input type="radio"/> Network <input type="radio"/> SharePoint
Profile 10	<input checked="" type="radio"/> FTP <input type="radio"/> SFTP <input type="radio"/> Network <input type="radio"/> SharePoint
Profile 11	<input checked="" type="radio"/> FTP <input type="radio"/> SFTP <input type="radio"/> Network <input type="radio"/> SharePoint
Profile 12	<input checked="" type="radio"/> FTP <input type="radio"/> SFTP <input type="radio"/> Network <input type="radio"/> SharePoint
Profile 13	<input checked="" type="radio"/> FTP <input type="radio"/> SFTP <input type="radio"/> Network <input type="radio"/> SharePoint
Profile 14	<input checked="" type="radio"/> FTP <input type="radio"/> SFTP <input type="radio"/> Network <input type="radio"/> SharePoint
Profile 15	<input checked="" type="radio"/> FTP <input type="radio"/> SFTP <input type="radio"/> Network <input type="radio"/> SharePoint
Profile 16	<input checked="" type="radio"/> FTP <input type="radio"/> SFTP <input type="radio"/> Network <input type="radio"/> SharePoint
Profile 17	<input checked="" type="radio"/> FTP <input type="radio"/> SFTP <input type="radio"/> Network <input type="radio"/> SharePoint
Profile 18	<input checked="" type="radio"/> FTP <input type="radio"/> SFTP <input type="radio"/> Network <input type="radio"/> SharePoint
Profile 19	<input checked="" type="radio"/> FTP <input type="radio"/> SFTP <input type="radio"/> Network <input type="radio"/> SharePoint
Profile 20	<input checked="" type="radio"/> FTP <input type="radio"/> SFTP <input type="radio"/> Network <input type="radio"/> SharePoint
Profile 21	<input checked="" type="radio"/> FTP <input type="radio"/> SFTP <input type="radio"/> Network <input type="radio"/> SharePoint
Profile 22	<input checked="" type="radio"/> FTP <input type="radio"/> SFTP <input type="radio"/> Network <input type="radio"/> SharePoint
Profile 23	<input checked="" type="radio"/> FTP <input type="radio"/> SFTP <input type="radio"/> Network <input type="radio"/> SharePoint
Profile 24	<input checked="" type="radio"/> FTP <input type="radio"/> SFTP <input type="radio"/> Network <input type="radio"/> SharePoint
Profile 25	<input checked="" type="radio"/> FTP <input type="radio"/> SFTP <input type="radio"/> Network <input type="radio"/> SharePoint

Send to My Folder

Off On

This function can be enabled when Active Directory Authentication or LDAP Authentication is active.

Cancel Submit

5. Click the **Scan to FTP/SFTP/Network/SharePoint Profile** menu in the left navigation bar.
6. Select the profile you want to set up or change.
7. In the **Profile Name** field, type a name for this server profile (up to 15 alphanumeric characters). The machine will display this name on the LCD.
8. In the **Host Address** field, type the Host Address (for example: ftp.example.com; up to 64 characters) or the IP address (for example: 192.23.56.189).
9. Change the **Port Number** setting used to access the FTP server. The default for this setting is port 21. In most cases this setting does not need to be changed.
10. In the **Username** field, type a user name (up to 32 characters) that has permission to write data to the FTP server.
11. In the **Password** field, type the password (up to 32 characters) associated with the user name you entered in the **Username** field. Type the password again in the **Retype password** field.

-
- To scan securely using SSL/TLS communication, set the **SSL/TLS** option. Change the **CA Certificate** setting, if needed.
 - In the **Store Directory** field, type the path to the folder on the FTP server where you want to send your scanned data. Do not type a slash mark at the beginning of the path (see example).

Store Directory

- Click the **File Name** drop-down list, and then select a file name prefix from the preset names provided, or from user-defined names. The file name used for the scanned document will be the file name prefix you select, followed by the last six digits of the flatbed/ADF scanner counter and the file extension (for example: "Estimate_098765.pdf").
- Click the **Quality** drop-down list, and then select a quality setting. If you choose the **User Select** option, the machine will prompt users to select a setting each time they use the scan profile.
- Click the **File Type** drop-down list, and then select the file type you want to use for the scanned document. If you choose the **User Select** option, the machine will prompt users to select a setting each time they use the scan profile.
- Click the **Document Size** drop-down list, and then select your document size from the list. This is necessary to make sure the scanned file is the correct size.
- Click the **File Size** drop-down list, and then select your file size from the list.
- Click the **Remove Background Color** drop-down list, and then select the level from the list. You can use this feature to remove the background color of documents to make the scanned data more legible.
- Set the **Passive Mode** option to off or on depending on your FTP server and network firewall configuration. The default setting is on. In most cases this setting does not need to be changed.
- Click **Submit**.



Using the following characters: ?, /, \, ", :, <, >, | or * may cause a sending error.



Related Information

- [Scan to FTP](#)

Upload Scanned Data to an FTP Server

Share scanned information by saving it to your FTP server.

1. Load your document.
2. Press [Scan] > [to FTP/SFTP] .
3. The server profiles you have set up using Web Based Management are listed. Select the profile you want. If the profile is not complete (for example, if the logon account name and password are missing, or if the quality or file type is not specified), you will be prompted to enter any missing information.
4. Press [Start].

The machine starts scanning. If using the machine's scanner glass, follow the Touchscreen instructions to complete the scanning job.



Related Information

- [Scan to FTP](#)

Scan to SSH FTP (SFTP)

Scan documents directly to an SFTP server, a secure version of an FTP server. For added convenience, configure different profiles to save your favorite Scan to SFTP destinations.

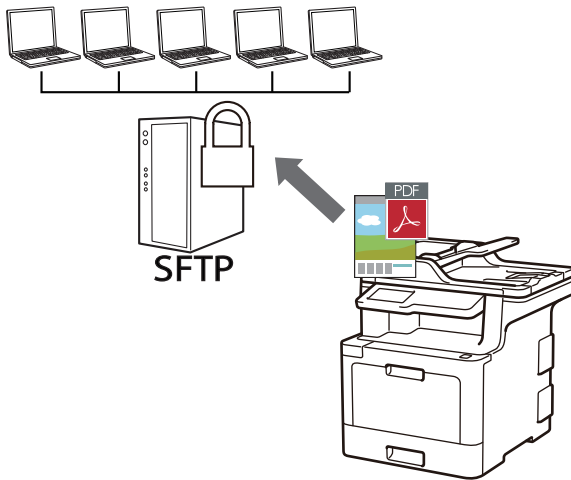

- [Set up a Scan to SFTP Profile](#)
- [Create a Client Key Pair Using Web Based Management](#)
- [Export a Client Key Pair Using Web Based Management](#)
- [Import a Server Public Key Using Web Based Management](#)
- [Upload Scanned Data to an SFTP Server](#)

Set up a Scan to SFTP Profile

Set up a Scan to SFTP Profile to scan and upload scanned data directly to an SFTP location.

We recommend Microsoft® Internet Explorer® 11 for Windows® and Safari 9 for Macintosh. Make sure that JavaScript and Cookies are always enabled in whichever browser you use.

1. Start your web browser.

Type "http://machine's IP address" in your browser's address bar (where "machine's IP address" is the IP address of the machine or the print server name). For example: http://192.168.1.2

No password is required by default. If you have previously set a password, type it, and then click .

2. Click the **Scan** tab.
3. Click the **Scan to FTP/SFTP/Network/SharePoint** menu in the left navigation bar.
4. Select the **SFTP** option, and then click **Submit**.

Scan to FTP/SFTP/Network/SharePoint

Profile 1	<input type="radio"/> FTP <input checked="" type="radio"/> SFTP <input type="radio"/> Network <input type="radio"/> SharePoint
Profile 2	<input type="radio"/> FTP <input checked="" type="radio"/> SFTP <input type="radio"/> Network <input type="radio"/> SharePoint
Profile 3	<input type="radio"/> FTP <input checked="" type="radio"/> SFTP <input type="radio"/> Network <input type="radio"/> SharePoint
Profile 4	<input type="radio"/> FTP <input checked="" type="radio"/> SFTP <input type="radio"/> Network <input type="radio"/> SharePoint
Profile 5	<input type="radio"/> FTP <input checked="" type="radio"/> SFTP <input type="radio"/> Network <input type="radio"/> SharePoint
Profile 6	<input type="radio"/> FTP <input checked="" type="radio"/> SFTP <input type="radio"/> Network <input type="radio"/> SharePoint
Profile 7	<input type="radio"/> FTP <input checked="" type="radio"/> SFTP <input type="radio"/> Network <input type="radio"/> SharePoint
Profile 8	<input type="radio"/> FTP <input checked="" type="radio"/> SFTP <input type="radio"/> Network <input type="radio"/> SharePoint
Profile 9	<input type="radio"/> FTP <input checked="" type="radio"/> SFTP <input type="radio"/> Network <input type="radio"/> SharePoint
Profile 10	<input type="radio"/> FTP <input checked="" type="radio"/> SFTP <input type="radio"/> Network <input type="radio"/> SharePoint
Profile 11	<input type="radio"/> FTP <input checked="" type="radio"/> SFTP <input type="radio"/> Network <input type="radio"/> SharePoint
Profile 12	<input type="radio"/> FTP <input checked="" type="radio"/> SFTP <input type="radio"/> Network <input type="radio"/> SharePoint
Profile 13	<input type="radio"/> FTP <input checked="" type="radio"/> SFTP <input type="radio"/> Network <input type="radio"/> SharePoint
Profile 14	<input type="radio"/> FTP <input checked="" type="radio"/> SFTP <input type="radio"/> Network <input type="radio"/> SharePoint
Profile 15	<input type="radio"/> FTP <input checked="" type="radio"/> SFTP <input type="radio"/> Network <input type="radio"/> SharePoint
Profile 16	<input type="radio"/> FTP <input checked="" type="radio"/> SFTP <input type="radio"/> Network <input type="radio"/> SharePoint
Profile 17	<input type="radio"/> FTP <input checked="" type="radio"/> SFTP <input type="radio"/> Network <input type="radio"/> SharePoint
Profile 18	<input type="radio"/> FTP <input checked="" type="radio"/> SFTP <input type="radio"/> Network <input type="radio"/> SharePoint
Profile 19	<input type="radio"/> FTP <input checked="" type="radio"/> SFTP <input type="radio"/> Network <input type="radio"/> SharePoint
Profile 20	<input type="radio"/> FTP <input checked="" type="radio"/> SFTP <input type="radio"/> Network <input type="radio"/> SharePoint
Profile 21	<input type="radio"/> FTP <input checked="" type="radio"/> SFTP <input type="radio"/> Network <input type="radio"/> SharePoint
Profile 22	<input type="radio"/> FTP <input checked="" type="radio"/> SFTP <input type="radio"/> Network <input type="radio"/> SharePoint
Profile 23	<input type="radio"/> FTP <input checked="" type="radio"/> SFTP <input type="radio"/> Network <input type="radio"/> SharePoint
Profile 24	<input type="radio"/> FTP <input checked="" type="radio"/> SFTP <input type="radio"/> Network <input type="radio"/> SharePoint
Profile 25	<input type="radio"/> FTP <input checked="" type="radio"/> SFTP <input type="radio"/> Network <input type="radio"/> SharePoint

Send to My Folder

Off On

This function can be enabled when Active Directory Authentication or LDAP Authentication is active.

- Click the **Scan to FTP/SFTP/Network/SharePoint Profile** menu in the left navigation bar.
- Select the profile you want to set up or change.
- In the **Profile Name** field, type a name for this server profile (up to 15 alphanumeric characters). The machine will display this name on the LCD.
- In the **Host Address** field, type the Host Address (for example: sftp.example.com; up to 64 characters) or the IP address (for example: 192.23.56.189).
- In the **Username** field, type the user name (up to 32 characters) that has permission to write data to the SFTP server.
- In the **Auth. Method** field, select **Password** or **Public Key**.
- Do one of the following:
 - When you select **Password**, type the password (up to 32 characters) associated with the user name you typed in the **Username** field. Type the password again in the **Retype password** field.

- When you select **Public Key**, select the authentication type from the **Client Key Pair** drop-down list.
12. Select the authentication type from the **Server Public Key** drop-down list.
 13. In the **Store Directory** field, type the path to the folder on the SFTP server where you want to send your scanned data. Do not type a slash mark at the beginning of the path (see example).

Store Directory

14. Click the **File Name** drop-down list, and then select a file name prefix from the preset names provided, or from user-defined names. The file name used for the scanned document will be the file name prefix you select, followed by the last six digits of the flatbed/ADF scanner counter and the file extension (for example: "Estimate_098765.pdf").
15. Click the **Quality** drop-down list, and then select a quality setting. If you choose the **User Select** option, the machine will prompt users to select a setting each time they use the scan profile.
16. Click the **File Type** drop-down list, and then select the file type you want to use for the scanned document. If you choose the **User Select** option, the machine will prompt users to select a setting each time they use the scan profile.
17. Click the **Document Size** drop-down list, and then select your document size from the list. This is necessary to make sure the scanned file is the correct size.
18. Click the **File Size** drop-down list, and then select your file size from the list.
19. Click the **Remove Background Color** drop-down list, and then select the level from the list. You can use this feature to remove the background color of documents to make the scanned data more legible.
20. You can change the **Port Number** setting used to access the SFTP server. The default for this setting is port 22. In most cases this setting does not need to be changed.
21. Click **Submit**.



Using the following characters: ?, /, \, ", :, <, >, | or * may cause a sending error.



Related Information

- [Scan to SSH FTP \(SFTP\)](#)

Create a Client Key Pair Using Web Based Management

1. Start your web browser.
2. Type "http://machine's IP address" in your browser's address bar (where "machine's IP address" is the machine's IP address).

For example:

http://192.168.1.2



- If you are using a Domain Name System or enable a NetBIOS name, you can type another name, such as "SharedPrinter" instead of the IP address.

- For example:

http://SharedPrinter

If you enable a NetBIOS name, you can also use the node name.

- For example:

http://brnxxxxxxxxxxxx

The NetBIOS name can be found in the Network Configuration Report.

- For Macintosh, access Web Based Management by clicking the machine's icon on the **Status Monitor** screen.

3. No password is required by default. Type a password if you have set one, and then click .
4. Click the **Network** tab.
5. Click the **Security** tab.
6. Click **Client Key Pair** in the left navigation bar.
7. Click **Create New Client Key Pair**.
8. In the **Client Key Pair Name** field, type the name (up to 20 characters) you want.
9. Click the **Public Key Algorithm** drop-down list, and then select the algorithm you want.
10. Click **Submit**.

The client key pair is created and saved in your machine's memory. The client key pair name and public key algorithm will be displayed in the **Client Key Pair List**.



Related Information

- [Scan to SSH FTP \(SFTP\)](#)

Export a Client Key Pair Using Web Based Management

1. Start your web browser.
2. Type "http://machine's IP address" in your browser's address bar (where "machine's IP address" is the machine's IP address).

For example:

http://192.168.1.2



- If you are using a Domain Name System or enable a NetBIOS name, you can type another name, such as "SharedPrinter" instead of the IP address.

- For example:

http://SharedPrinter

If you enable a NetBIOS name, you can also use the node name.

- For example:

http://brnxxxxxxxxxxxx

The NetBIOS name can be found in the Network Configuration Report.

- For Macintosh, access Web Based Management by clicking the machine's icon on the **Status Monitor** screen.

3. No password is required by default. Type a password if you have set one, and then click .
4. Click the **Network** tab.
5. Click the **Security** tab.
6. Click **Client Key Pair** in the left navigation bar.
7. Click **Export Public Key** shown with **Client Key Pair List**.
8. Click **Submit**.
9. Specify the location where you want to save the file.

The client key pair is exported to your computer.



Related Information

- [Scan to SSH FTP \(SFTP\)](#)

Import a Server Public Key Using Web Based Management

1. Start your web browser.
2. Type "http://machine's IP address" in your browser's address bar (where "machine's IP address" is the machine's IP address).

For example:

http://192.168.1.2



- If you are using a Domain Name System or enable a NetBIOS name, you can type another name, such as "SharedPrinter" instead of the IP address.

- For example:

http://SharedPrinter

If you enable a NetBIOS name, you can also use the node name.

- For example:

http://brnxxxxxxxxxxxx

The NetBIOS name can be found in the Network Configuration Report.

- For Macintosh, access Web Based Management by clicking the machine's icon on the **Status Monitor** screen.

3. No password is required by default. Type a password if you have set one, and then click .
4. Click the **Network** tab.
5. Click the **Security** tab.
6. Click **Server Public Key** in the left navigation bar.
7. Click **Import Server Public Key**.
8. Specify the file that you want to import.
9. Click **Submit**.

The server public key is imported to your machine.



Related Information

- [Scan to SSH FTP \(SFTP\)](#)

Upload Scanned Data to an SFTP Server

1. Load your document.
2. Press [Scan] > [to FTP/SFTP] .
3. The server profiles you have set up using Web Based Management are listed. Select the profile you want. If the profile is not complete (for example, if the logon account name and password are missing, or if the quality or file type is not specified), you will be prompted to enter any missing information.
4. Press [Start].

The machine starts scanning. If using the machine's scanner glass, follow the Touchscreen instructions to complete the scanning job.



Related Information

- [Scan to SSH FTP \(SFTP\)](#)

Scan to Network (Windows®)

Scan documents directly to a CIFS server on your local network. For added convenience, you can configure different profiles to save your favorite Scan to Network destinations.

- [Set up a Scan to Network Profile](#)
- [Upload Scanned Data to a CIFS Server](#)

Set up a Scan to Network Profile

Set up a Scan to Network Profile to scan and upload scanned data directly to a folder on a CIFS server.

We recommend Microsoft® Internet Explorer® 11 for Windows® and Safari 9 for Macintosh. Make sure that JavaScript and Cookies are always enabled in whichever browser you use.

1. Start your web browser.

Type "http://machine's IP address" in your browser's address bar (where "machine's IP address" is the IP address of the machine or the print server name). For example: http://192.168.1.2

No password is required by default. If you have previously set a password, type it, and then click .

2. Click the **Scan** tab.
3. Click the **Scan to FTP/SFTP/Network/SharePoint** menu in the left navigation bar.
4. Select the **Network** option, and then click **Submit**.

Scan to FTP/SFTP/Network/SharePoint

Profile 1	<input type="radio"/> FTP <input type="radio"/> SFTP <input checked="" type="radio"/> Network <input type="radio"/> SharePoint
Profile 2	<input type="radio"/> FTP <input type="radio"/> SFTP <input checked="" type="radio"/> Network <input type="radio"/> SharePoint
Profile 3	<input type="radio"/> FTP <input type="radio"/> SFTP <input checked="" type="radio"/> Network <input type="radio"/> SharePoint
Profile 4	<input type="radio"/> FTP <input type="radio"/> SFTP <input checked="" type="radio"/> Network <input type="radio"/> SharePoint
Profile 5	<input type="radio"/> FTP <input type="radio"/> SFTP <input checked="" type="radio"/> Network <input type="radio"/> SharePoint
Profile 6	<input type="radio"/> FTP <input type="radio"/> SFTP <input checked="" type="radio"/> Network <input type="radio"/> SharePoint
Profile 7	<input type="radio"/> FTP <input type="radio"/> SFTP <input checked="" type="radio"/> Network <input type="radio"/> SharePoint
Profile 8	<input type="radio"/> FTP <input type="radio"/> SFTP <input checked="" type="radio"/> Network <input type="radio"/> SharePoint
Profile 9	<input type="radio"/> FTP <input type="radio"/> SFTP <input checked="" type="radio"/> Network <input type="radio"/> SharePoint
Profile 10	<input type="radio"/> FTP <input type="radio"/> SFTP <input checked="" type="radio"/> Network <input type="radio"/> SharePoint
Profile 11	<input type="radio"/> FTP <input type="radio"/> SFTP <input checked="" type="radio"/> Network <input type="radio"/> SharePoint
Profile 12	<input type="radio"/> FTP <input type="radio"/> SFTP <input checked="" type="radio"/> Network <input type="radio"/> SharePoint
Profile 13	<input type="radio"/> FTP <input type="radio"/> SFTP <input checked="" type="radio"/> Network <input type="radio"/> SharePoint
Profile 14	<input type="radio"/> FTP <input type="radio"/> SFTP <input checked="" type="radio"/> Network <input type="radio"/> SharePoint
Profile 15	<input type="radio"/> FTP <input type="radio"/> SFTP <input checked="" type="radio"/> Network <input type="radio"/> SharePoint
Profile 16	<input type="radio"/> FTP <input type="radio"/> SFTP <input checked="" type="radio"/> Network <input type="radio"/> SharePoint
Profile 17	<input type="radio"/> FTP <input type="radio"/> SFTP <input checked="" type="radio"/> Network <input type="radio"/> SharePoint
Profile 18	<input type="radio"/> FTP <input type="radio"/> SFTP <input checked="" type="radio"/> Network <input type="radio"/> SharePoint
Profile 19	<input type="radio"/> FTP <input type="radio"/> SFTP <input checked="" type="radio"/> Network <input type="radio"/> SharePoint
Profile 20	<input type="radio"/> FTP <input type="radio"/> SFTP <input checked="" type="radio"/> Network <input type="radio"/> SharePoint
Profile 21	<input type="radio"/> FTP <input type="radio"/> SFTP <input checked="" type="radio"/> Network <input type="radio"/> SharePoint
Profile 22	<input type="radio"/> FTP <input type="radio"/> SFTP <input checked="" type="radio"/> Network <input type="radio"/> SharePoint
Profile 23	<input type="radio"/> FTP <input type="radio"/> SFTP <input checked="" type="radio"/> Network <input type="radio"/> SharePoint
Profile 24	<input type="radio"/> FTP <input type="radio"/> SFTP <input checked="" type="radio"/> Network <input type="radio"/> SharePoint
Profile 25	<input type="radio"/> FTP <input type="radio"/> SFTP <input checked="" type="radio"/> Network <input type="radio"/> SharePoint

Send to My Folder

Off On

This function can be enabled when Active Directory Authentication or LDAP Authentication is active.

5. Click the **Scan to FTP/SFTP/Network/SharePoint Profile** menu in the left navigation bar.
6. Select the profile you want to set up or change.
7. To send the data to your designated folder on the CIFS server, in the **Send to My Folder** field, select **On**.
8. In the **Profile Name** field, type a name for this server profile (up to 15 alphanumeric characters). The machine will display this name on the LCD.
9. In the **Network Folder Path** field, type the path to the folder on the CIFS server where you want to send your scanned data.
10. Click the **File Name** drop-down list, and then select a file name prefix from the preset names provided, or from user-defined names. The file name used for the scanned document will be the file name prefix you select, followed by the last six digits of the flatbed/ADF scanner counter and the file extension (for example: "Estimate_098765.pdf").

-
11. Click the **Quality** drop-down list, and then select a quality setting. If you choose the **User Select** option, the machine will prompt users to select a setting each time they use the scan profile.
 12. Click the **File Type** drop-down list, and then select the file type you want to use for the scanned document. If you choose the **User Select** option, the machine will prompt users to select a setting each time they use the scan profile.
 13. Click the **Document Size** drop-down list, and then select your document size from the list. This is necessary to make sure the scanned file is the correct size.
 14. Click the **File Size** drop-down list, and then select your file size from the list.
 15. Click the **Remove Background Color** drop-down list, and then select the level from the list. You can use this feature to remove the background color of documents to make the scanned data more legible.
 16. To PIN-protect this profile, in the **Use PIN for Authentication** field, select **On**.
 17. If you selected **On** for the **Use PIN for Authentication** field, type a four-digit PIN in the **PIN Code** field.
 18. To set your authentication method, select **Auto**, **Kerberos**, or **NTLMv2** from the **Auth. Method** menu.
 19. In the **Username** field, type a user name (up to 96 characters) that has permission to write data to the folder specified in the **Network Folder Path** field. If the user name is part of a domain, enter the user name in one of the following styles:
user@domain
domain\user
 20. In the **Password** field, type the password (up to 32 characters) associated with the user name you entered in the **Username** field. Type the password again in the **Retype password** field.
 21. To set the Kerberos Server Address manually, in the **Kerberos Server Address** field, type the Kerberos Server Address (for example: kerberos.example.com; up to 64 characters).
 22. Click **Submit**.



Using the following characters: ?, /, \, ", :, <, >, | or * may cause a sending error.

23. You must configure the SNTP protocol (network time server) or you must set the date, time and time zone correctly on the control panel for all authentication methods. The time must match the time used by the Kerberos Server and CIFS Server.



Related Information

- [Scan to Network \(Windows®\)](#)
 - [Set the Date and Time Using Web Based Management](#)
-

Set the Date and Time Using Web Based Management

Make sure the date and time and the time zone settings are set correctly using Web Based Management or the control panel, so the machine's time matches the time being used by the server providing authentication.

Ignore step 1, if you already have a Web Based Management window open.

1. Start your web browser.

Type "http://machine's IP address" in your browser's address bar (where "machine's IP address" is the IP address of the machine or the print server name). For example: http://192.168.1.2

No password is required by default. If you have previously set a password, type it, and then click .

2. Click the **Administrator** tab.
3. Click the **Date&Time** menu in the left navigation bar.



Date&Time

Date xx / xx / 20xx

Clock Type 12h Clock 24h Clock

Time xx : xx AM

Time Zone UTC+09:00

Auto Daylight Off On

Synchronize with SNTP server

To synchronize the "Date&Time" with your SNTP server you must configure the SNTP server settings.

[SNTP>>](#)

Cancel Submit

4. In the **Date** fields, enter the date.
5. Select the clock type from the **Clock Type** field (available only for some countries).
6. In the **Time** fields, enter the time.
7. Select the time difference between your location and UTC from the **Time Zone** drop-down list, for example, the time zone for Eastern time in the USA and Canada is UTC-05:00.
8. In the **Auto Daylight** field, click **On** to set the machine to change automatically for Daylight Saving Time. It will reset itself forward one hour in the spring, and back one hour in the fall (available only for some countries).
9. Click **Submit**.



Related Information

- [Set up a Scan to Network Profile](#)

Upload Scanned Data to a CIFS Server

1. Load your document.
2. Press [Scan] > [to Network] .



- If you registered your user ID, the [to My Folder] option appears when you log on to the machine using Active Directory® Authentication or LDAP Authentication.
- To send scanned data to your designated folder on the CIFS server, press [to My Folder].
- To enable this feature in Web Based Management, click the **Scan** tab, and then click the **Scan to FTP/SFTP/Network/SharePoint** menu in the left navigation bar. In the **Send to My Folder** field, select **On**.

3. The server profiles you have set up using Web Based Management are listed. Select the profile you want. If the profile is not complete (for example, if the logon account name and password are missing, or if the quality or file type is not specified), you will be prompted to enter any missing information.
4. Press [Start].

The machine starts scanning. If using the machine's scanner glass, follow the Touchscreen instructions to complete the scanning job.



Related Information

- [Scan to Network \(Windows®\)](#)

Scan to SharePoint®

Scan documents directly to a SharePoint® server when you need to share the scanned information. For added convenience, configure different profiles to save your favorite Scan to SharePoint® destinations.

- [Set up a Scan to SharePoint® Profile](#)
- [Upload Scanned Data to a SharePoint® Server](#)

Set up a Scan to SharePoint® Profile

Set up a Scan to SharePoint® Profile to scan and upload the scanned data directly to a SharePoint® location.

We recommend Microsoft® Internet Explorer® 11 for Windows® and Safari 9 for Macintosh. Make sure that JavaScript and Cookies are always enabled in whichever browser you use.

1. Start your web browser.

Type "http://machine's IP address" in your browser's address bar (where "machine's IP address" is the IP address of the machine or the print server name). For example: http://192.168.1.2

No password is required by default. If you have previously set a password, type it, and then click .

2. Click the **Scan** tab.
3. Click the **Scan to FTP/SFTP/Network/SharePoint** menu in the left navigation bar.
4. Select the **SharePoint** option, and then click **Submit**.

Scan to FTP/SFTP/Network/SharePoint

Profile 1	<input type="radio"/> FTP <input type="radio"/> SFTP <input type="radio"/> Network <input checked="" type="radio"/> SharePoint
Profile 2	<input type="radio"/> FTP <input type="radio"/> SFTP <input type="radio"/> Network <input checked="" type="radio"/> SharePoint
Profile 3	<input type="radio"/> FTP <input type="radio"/> SFTP <input type="radio"/> Network <input checked="" type="radio"/> SharePoint
Profile 4	<input type="radio"/> FTP <input type="radio"/> SFTP <input type="radio"/> Network <input checked="" type="radio"/> SharePoint
Profile 5	<input type="radio"/> FTP <input type="radio"/> SFTP <input type="radio"/> Network <input checked="" type="radio"/> SharePoint
Profile 6	<input type="radio"/> FTP <input type="radio"/> SFTP <input type="radio"/> Network <input checked="" type="radio"/> SharePoint
Profile 7	<input type="radio"/> FTP <input type="radio"/> SFTP <input type="radio"/> Network <input checked="" type="radio"/> SharePoint
Profile 8	<input type="radio"/> FTP <input type="radio"/> SFTP <input type="radio"/> Network <input checked="" type="radio"/> SharePoint
Profile 9	<input type="radio"/> FTP <input type="radio"/> SFTP <input type="radio"/> Network <input checked="" type="radio"/> SharePoint
Profile 10	<input type="radio"/> FTP <input type="radio"/> SFTP <input type="radio"/> Network <input checked="" type="radio"/> SharePoint
Profile 11	<input type="radio"/> FTP <input type="radio"/> SFTP <input type="radio"/> Network <input checked="" type="radio"/> SharePoint
Profile 12	<input type="radio"/> FTP <input type="radio"/> SFTP <input type="radio"/> Network <input checked="" type="radio"/> SharePoint
Profile 13	<input type="radio"/> FTP <input type="radio"/> SFTP <input type="radio"/> Network <input checked="" type="radio"/> SharePoint
Profile 14	<input type="radio"/> FTP <input type="radio"/> SFTP <input type="radio"/> Network <input checked="" type="radio"/> SharePoint
Profile 15	<input type="radio"/> FTP <input type="radio"/> SFTP <input type="radio"/> Network <input checked="" type="radio"/> SharePoint
Profile 16	<input type="radio"/> FTP <input type="radio"/> SFTP <input type="radio"/> Network <input checked="" type="radio"/> SharePoint
Profile 17	<input type="radio"/> FTP <input type="radio"/> SFTP <input type="radio"/> Network <input checked="" type="radio"/> SharePoint
Profile 18	<input type="radio"/> FTP <input type="radio"/> SFTP <input type="radio"/> Network <input checked="" type="radio"/> SharePoint
Profile 19	<input type="radio"/> FTP <input type="radio"/> SFTP <input type="radio"/> Network <input checked="" type="radio"/> SharePoint
Profile 20	<input type="radio"/> FTP <input type="radio"/> SFTP <input type="radio"/> Network <input checked="" type="radio"/> SharePoint
Profile 21	<input type="radio"/> FTP <input type="radio"/> SFTP <input type="radio"/> Network <input checked="" type="radio"/> SharePoint
Profile 22	<input type="radio"/> FTP <input type="radio"/> SFTP <input type="radio"/> Network <input checked="" type="radio"/> SharePoint
Profile 23	<input type="radio"/> FTP <input type="radio"/> SFTP <input type="radio"/> Network <input checked="" type="radio"/> SharePoint
Profile 24	<input type="radio"/> FTP <input type="radio"/> SFTP <input type="radio"/> Network <input checked="" type="radio"/> SharePoint
Profile 25	<input type="radio"/> FTP <input type="radio"/> SFTP <input type="radio"/> Network <input checked="" type="radio"/> SharePoint

Send to My Folder

Off On

This function can be enabled when Active Directory Authentication or LDAP Authentication is active.

5. Click the **Scan to FTP/SFTP/Network/SharePoint Profile** menu in the left navigation bar.
6. Select the profile you want to set up or change.
7. In the **Profile Name** field, type a name for this server profile (up to 15 alphanumeric characters). The machine will display this name on the LCD.
8. In the **SharePoint Site Address** field, Copy and Paste the full destination address shown in the address bar of your browser (for example: `http://SharePointSiteAddress/Shared%20Documents/Forms/AllItems.aspx`) or the IP address (for example: `http://192.168.0.1/Shared%20Documents/Forms/AllItems.aspx`).
9. Click the **File Name** drop-down list, and then select a file name prefix from the preset names provided, or from user-defined names. The file name used for the scanned document will be the file name prefix you select, followed by the last six digits of the flatbed/ADF scanner counter and the file extension (for example: "Estimate_098765.pdf").

-
10. Click the **Quality** drop-down list, and then select a quality setting. If you choose the **User Select** option, the machine will prompt users to select a setting each time they use the scan profile.
 11. Click the **File Type** drop-down list, and then select the file type you want to use for the scanned document. If you choose the **User Select** option, the machine will prompt users to select a setting each time they use the scan profile.
 12. Click the **Document Size** drop-down list, and then select your document size from the list. This is necessary to make sure the scanned file is the correct size.
 13. Click the **File Size** drop-down list, and then select your file size from the list.
 14. Click the **Remove Background Color** drop-down list, and then select the level from the list. You can use this feature to remove the background color of documents to make the scanned data more legible.
 15. To PIN-protect this profile, in the **Use PIN for Authentication** field, select **On**.
 16. If you selected **On** for the **Use PIN for Authentication** field, type a four-digit PIN in the **PIN Code** field.
 17. To set your authentication method, select **Auto**, **NTLMv2**, **Kerberos**, or **Basic** from the **Auth. Method** menu. If you choose **Auto**, the authentication method will be detected automatically.
 18. In the **Username** field, type the user name (up to 96 characters) that has permission to write data to the folder specified in the **SharePoint Site Address** field. If the user name is part of a domain, enter the user name in one of the following styles:
user@domain
domain\user
 19. In the **Password** field, type the password (up to 32 characters) associated with the user name you entered in the **Username** field. Type the password again in the **Retype password** field.
 20. To set the Kerberos Server Address manually, in the **Kerberos Server Address** field, type the Kerberos Server Address (for example: kerberos.example.com; up to 64 characters).
 21. Click **Submit**.



Using the following characters: ?, /, \, ", :, <, >, | or * may cause a sending error.



Related Information

- [Scan to SharePoint®](#)
-

Upload Scanned Data to a SharePoint® Server

1. Load your document.
2. Press [Scan] > [to SharePoint].
3. The server profiles you have set up using Web Based Management are listed. Select the profile you want. If the profile is not complete (for example, if the logon account name and password are missing, or if the quality or file type is not specified), you will be prompted to enter any missing information.
4. Press [Start].
The machine starts scanning. If using the machine's scanner glass, follow the Touchscreen instructions to complete the scanning job.

Related Information

- [Scan to SharePoint®](#)
-

Web Services for Scanning on Your Network (Windows® 7, Windows® 8 and Windows® 10)

The Web Services protocol enables Windows® 7, Windows® 8 and Windows® 10 users to scan using a Brother machine on the network. You must install the driver via Web Services.

- [Use Web Services to Install Drivers Used for Scanning \(Windows® 7, Windows® 8 and Windows® 10\)](#)
- [Scan Using Web Services from the Brother Machine \(Windows® 7, Windows® 8 and Windows® 10\)](#)
- [Configure Scan Settings for Web Services](#)

Use Web Services to Install Drivers Used for Scanning (Windows® 7, Windows® 8 and Windows® 10)

Use Web Services to monitor printers on the network.

- Make sure you have installed the Brother software and drivers.
- Verify that the host computer and the Brother machine are on the same subnet, or that the router is correctly configured to pass data between the two devices.
- You must configure the IP address on your Brother machine before you configure this setting.

1. Do one of the following:

- Windows® 7

Click  (**Start**) > **Control Panel** > **Network and Internet** > **View network computers and devices**.

The machine's Web Services Name appears with the printer icon.

Right-click the machine you want to install.

- Windows® 8

Move your mouse to the lower right corner of your desktop. When the menu bar appears, click **Settings** > **Change PC settings** > **Devices** > **Add a device**.

The machine's Web Services Name appears.

- Windows® 8.1

Move your mouse to the lower right corner of your desktop. When the menu bar appears, click **Settings** > **Change PC settings** > **PC and devices** > **Devices** > **Add a device**.

The machine's Web Services Name appears.

- Windows® 10

Click  > **Windows System** > **Control Panel**. In the **Hardware and Sound** group, click **Add a device**.



- The Web Services Name for the Brother machine is your model name and the MAC Address (Ethernet Address) of your machine (for example, Brother MFC-XXXX (model name) [XXXXXXXXXXXX] (MAC Address / Ethernet Address)).

- Windows® 8/Windows® 10

Move your mouse over the machine name to display the machine's information.

2. Do one of the following:

- Windows® 7

Click **Install** in the displayed menu.

- Windows® 8/Windows® 10

Select the machine you want to install, and then follow the on-screen instructions.



To uninstall drivers, click **Uninstall** or  (**Remove device**).



Related Information

- [Web Services for Scanning on Your Network \(Windows® 7, Windows® 8 and Windows® 10\)](#)

Scan Using Web Services from the Brother Machine (Windows® 7, Windows® 8 and Windows® 10)

If you have installed the driver for scanning via Web Services, you can access the Web Services scanning menu on your Brother machine's LCD.

Certain characters in the messages displayed on the LCD may be replaced with spaces if the language settings of your OS and your Brother machine are different.

1. Load your document.
2. Press [Scan] > [WS Scan].
3. Select the type of scan.
4. Select the computer name you want to send data.
5. Press [Start].

The machine starts scanning.

If you are requested to select a scanning application, select Windows® Fax and Scan or Windows® Photo Gallery from the list.



Related Information

- [Web Services for Scanning on Your Network \(Windows® 7, Windows® 8 and Windows® 10\)](#)

Configure Scan Settings for Web Services

1. Do one of the following:

- Windows® 7

Click  (**Start**) > **Devices and Printers**.

- Windows® 8

Move your mouse to the lower right corner of your desktop. When the menu bar appears, click **Settings**, and then click **Control Panel**. In the **Hardware and Sound** group, click **View devices and printers**.

- Windows® 10

Click  > **Windows System** > **Control Panel**. In the **Hardware and Sound** group, click **View devices and printers**.

2. Right-click the machine icon, and then select **Scan profiles....** The **Scan Profiles** dialog box appears.

3. Select the scan profile you want to use.

4. Make sure the scanner selected in the **Scanner** list is a Brother machine that supports Web Services for scanning, and then click the **Set as Default** button.

5. Click **Edit...**

The **Edit Default Profile** dialog box appears.

6. Select the **Source**, **Paper size**, **Color format**, **File type**, **Resolution (DPI)**, **Brightness** and **Contrast** settings.

7. Click the **Save Profile** button.

These settings will be applied when you scan using the Web Services protocol.

If you are requested to select a scanning application, select Windows® Fax and Scan or Windows® Photo Gallery from the list.



Related Information

- [Web Services for Scanning on Your Network \(Windows® 7, Windows® 8 and Windows® 10\)](#)

Change Scan Button Settings from ControlCenter4 (Windows®)

1. Click the  (ControlCenter4) icon in the task tray, and then click **Open**.
2. Click the **Device Settings** tab.
3. Click the **Device Scan Settings** button.

The **Device Scan Settings** dialog box appears.

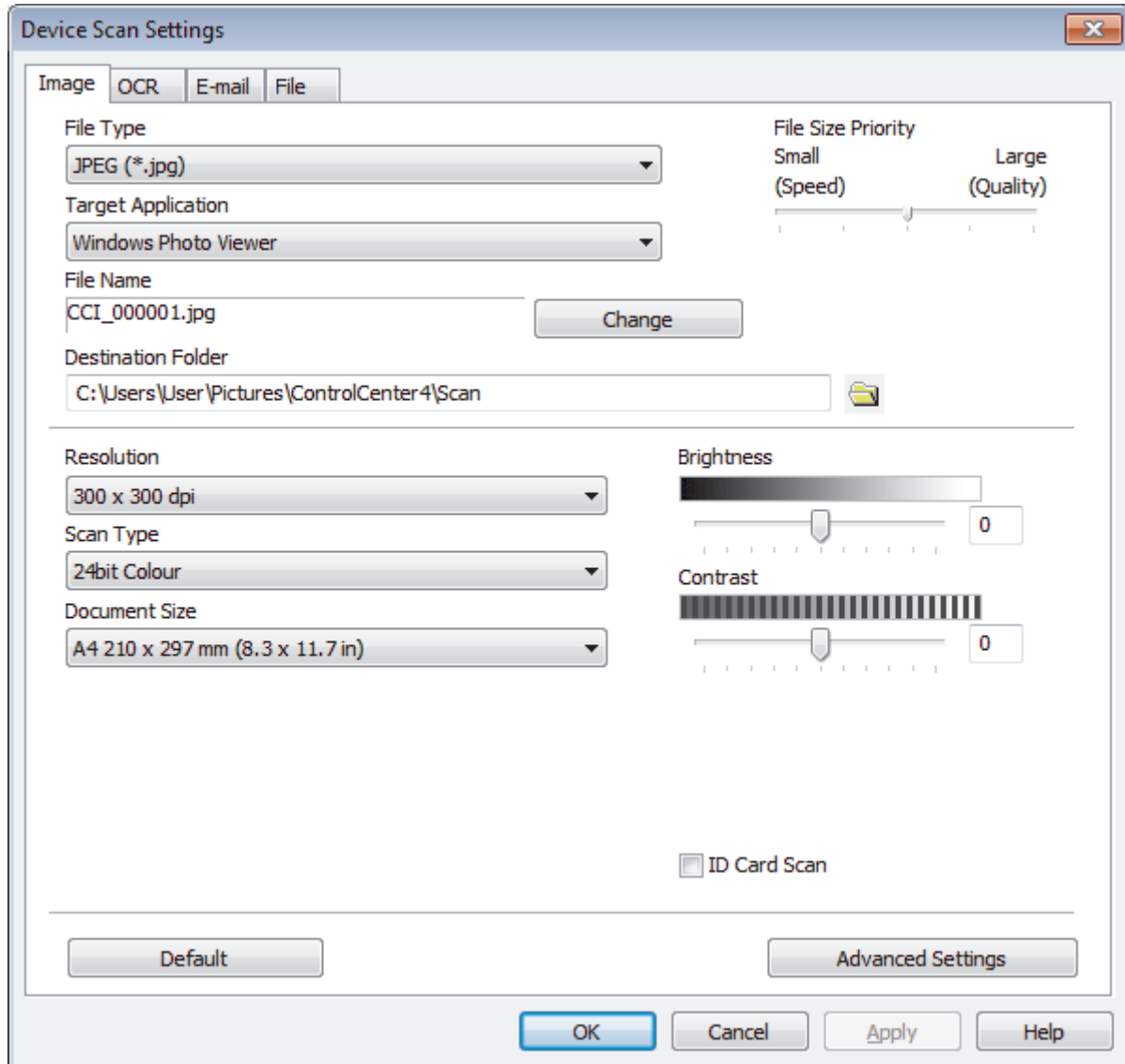

4. Click the tab for the Scan to action you want to change (**Image**, **OCR**, **E-mail**, or **File**).
5. Change the settings as needed.
6. Click **OK**.



Each tab represents one of the scanning destinations, as outlined in the table below.

Change your Scan to settings by clicking on the corresponding tab and customizing the setting you want.

Tab Name	Corresponding Feature
Image	Scan to Image
OCR	Scan to OCR
E-mail	Scan to Email
File	Scan to File

Settings	Applicable Features			
	Image	OCR	E-mail	File
File Type	Yes	Yes	Yes	Yes
Target Application	Yes	Yes	-	-
OCR Language	-	Yes	-	-
File Name	Yes	Yes	Yes	Yes
Destination Folder or Scan Location	Yes	Yes	Yes	Yes
Show Save As Window	-	-	-	Yes
Show Folder	-	-	-	Yes
File Size Priority	Yes	-	Yes	Yes
Resolution	Yes	Yes	Yes	Yes
Scan Type	Yes	Yes	Yes	Yes
Document Size	Yes	Yes	Yes	Yes
Brightness	Yes	Yes	Yes	Yes
Contrast	Yes	Yes	Yes	Yes
ID Card Scan	Yes	Yes	Yes	Yes
Advanced Settings	Yes	Yes	Yes	Yes
Default	Yes	Yes	Yes	Yes

File Type

Select the file type you want to use for the scanned data.

Target Application

Select the destination application from the drop-down list.

OCR Language

Set the OCR language to match the language of the scanned document's text.

File Name

Click **Change** to change the file name's prefix.

Destination Folder

Click the folder icon to browse and select the folder where you want to save your scanned documents.

Scan Location

Select the **Folder** or **SharePoint** radio button to specify the destination where you want to save your scanned documents.

Show Save As Window

Select this option to specify the scanned image's destination every time you scan.

Show Folder

Select this option to automatically display the destination folder after scanning.

File Size Priority

Adjust the data compression ratio of the scanned image. Change the file size by moving the **File Size Priority** slider to the right or left.

Resolution

Select a scanning resolution from the **Resolution** drop-down list. Higher resolutions take more memory and transfer time, but produce a finer scanned image.

Scan Type

Select from a range of scan color depths.

- **Auto**
Use for any type of document. This mode automatically picks an appropriate color depth for the document.
- **Black & White**
Use for text or line art images.
- **Gray (Error Diffusion)**
Use for photographic images or graphics. (Error Diffusion is a method for creating simulated gray images without using true gray dots. Black dots are put in a specific pattern to give a gray appearance.)
- **True Gray**
Use for photographic images or graphics. This mode is more accurate because it uses up to 256 shades of gray.
- **24bit Color**
Use to create an image with the most accurate color reproduction. This mode uses up to 16.8 million colors to scan the image, but it requires the most memory and has the longest transfer time.

Document Size

Select the exact size of your document from the **Document Size** drop-down list.

- If you select the **1 to 2 (A4)** option, the scanned image will be divided into two A5-size documents.

Brightness

Set the **Brightness** level by dragging the slider to the right or left to lighten or darken the image. If the scanned image is too light, set a lower brightness level and scan the document again. If the image is too dark, set a higher brightness level and scan the document again. You can also type a value into the field to set the **Brightness** level.

Contrast

Increase or decrease the **Contrast** level by moving the slider to the right or left. An increase emphasizes dark and light areas of the image, while a decrease reveals more details in gray areas. You can also type a value into the field to set the **Contrast** level.

ID Card Scan

Select this check box to scan both sides of an identification card onto one page.

Advanced Settings

Configure advanced settings by clicking the **Advanced Settings** button in the Scan Settings dialog box.

- **Remove Background Color**
Remove the base color of documents to make the scanned data more legible.
- **Rotate Image**
Rotate the scanned image.
- **Skip Blank Page**
Remove the document's blank pages from the scanning results.

- **Display Scanning Results**

Show the numbers of total pages saved and blank pages skipped on your computer screen.

- **ADF Auto Deskew**

When scanning the document from the ADF, the machine corrects skewing of the document automatically.

Default

Select this option to restore all settings to their factory setting values.



Related Information

- [Scan Using the Scan Button on Your Brother Machine](#)
 - [Scan Photos and Graphics](#)
 - [Save Scanned Data to a Folder as a PDF File](#)
 - [Scan to an Editable Text File \(OCR\)](#)
 - [Scan to Email Attachment](#)
-

Change Scan Button Settings from ControlCenter2 (Macintosh)

1. In the **Finder** menu bar, click **Go > Applications > Brother**, and then double-click the  (**ControlCenter**) icon.
The **ControlCenter2** screen appears.
2. Hold the control key on your keyboard and click the scan destination (**Image, OCR, E-mail, or File**) whose settings you want to change.
3. Click the **Device Button** tab.
The settings for the scan destination that you selected appear.
The following example shows the **Scan to Image** settings.

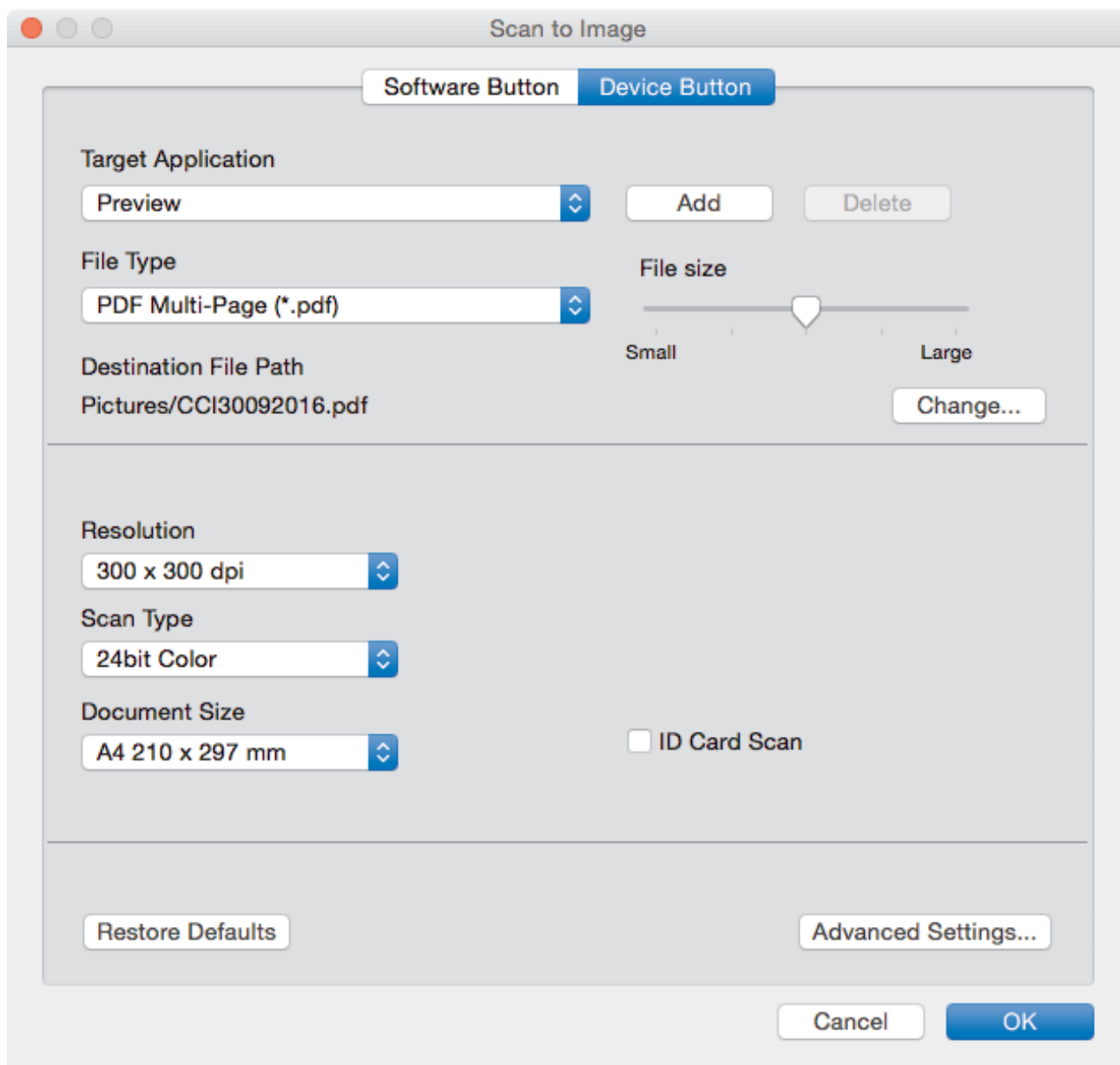



Each tab corresponds to a scan feature, as described below.

These settings can be changed.

Button Name	Corresponding Feature
Image	Scan to Image
OCR	Scan to OCR
E-mail	Scan to Email
File	Scan to File

Settings	Applicable Features			
	Image	OCR	E-mail	File
Target Application/E-mail Application	Yes	Yes	Yes	-
File Type	Yes	Yes	Yes	Yes
File size	Yes	-	Yes	Yes
OCR Language	-	Yes	-	-
Destination File Path	Yes	Yes	Yes	-
File Name	Yes	Yes	Yes	Yes
Insert Date in File Name	Yes	Yes	Yes	Yes
Destination Folder	Yes	Yes	Yes	Yes
Show Folder	-	-	-	Yes
Resolution	Yes	Yes	Yes	Yes
Scan Type	Yes	Yes	Yes	Yes
Document Size	Yes	Yes	Yes	Yes
ID Card Scan	Yes	Yes	Yes	Yes
Advanced Settings	Yes	Yes	Yes	Yes
Restore Defaults	Yes	Yes	Yes	Yes

Target Application/E-mail Application

Select which application is used to open scanned data. Only applications installed on your computer can be selected.

- **Add**

Add an application to the pop-up menu.

Type the application name in the **Application Name** field (up to 30 characters) and select your preferred application by clicking the **Browse** button. Select the **File Type** option from the pop-up menu.

- **Delete**

Delete an application you have added to the pop-up menu.

Select the application from the **Application Name** pop-up menu, and then click **Delete**.

File Type

Select the file type you want to use for the scanned data.

File size

Change the file size by moving the **File size** slider to the right or left.

OCR Language

Set the OCR language to match the language of the scanned document's text.

Destination File Path

Click the **Change** button to change the prefix of the file name and the path of the destination folder.

File Name

Type a prefix for your file name, if needed.

Insert Date in File Name

Automatically insert the date in the file name of the scanned image.

Destination Folder

Click **Browse** to select the folder where you would like to save your scanned document.

Show Folder

Select the **Show Folder** option to automatically display the destination folder after scanning.

Resolution

Select a scanning resolution from the **Resolution** pop-up menu. Higher resolutions take more memory and transfer time, but produce a finer scanned image.

Scan Type

Select from a range of scan color depths.

- **Black & White**
Use for text or line art images.
- **Gray (Error Diffusion)**
Use for photographic images or graphics. (Error Diffusion is a method for creating simulated gray images without using true gray dots. Black dots are put in a specific pattern to give a gray appearance.)
- **True Gray**
Use for photographic images or graphics. This mode is more accurate because it uses up to 256 shades of gray.
- **24bit Color**
Use to create an image with the most accurate color reproduction. This mode uses up to 16.8 million colors to scan the image, but it requires the most memory and has the longest transfer time.
- **Auto**
Use for any type of document. This mode automatically picks an appropriate color depth for the document.

Document Size

Select the exact size of your document from the **Document Size** pop-up menu.

- If you select the **1 to 2 (A4)** option, the scanned image will be divided into two A5-size documents.

ID Card Scan

Select this check box to scan both sides of an identification card onto one page.

Advanced Settings

Configure advanced settings by clicking the **Advanced Settings** button in the Scan Settings dialog box.

- **Brightness**
Set the **Brightness** level by dragging the slider to the right or left to lighten or darken the image. If the scanned image is too light, set a lower brightness level and scan the document again. If the image is too dark, set a higher brightness level and scan the document again.
- **Contrast**
Increase or decrease the **Contrast** level by moving the slider to the right or left. An increase emphasize dark and light areas of the image, while a decrease reveals more details in gray areas.
- **ADF Auto Deskew**
When scanning the document from the ADF, the machine corrects skewing of the document automatically.
- **Remove Background Color**
Remove the base color of documents to make the scanned data more recognizable. When you use this function, select from three settings: high, medium, and low.

(Available only for the **Auto**, **True Gray** and **24bit Color** options)

- **Skip Blank Page**

Remove blank pages of the document from the scanning results.

- **Display Scanning Results**

Show the numbers of total pages saved and blank pages skipped on your computer screen.

- **Rotate Image**

Rotate the scanned image.

Restore Defaults

Select this option to restore all settings to their factory setting values.



Related Information

- [Scan Using the Scan Button on Your Brother Machine](#)
 - [Scan Photos and Graphics](#)
 - [Save Scanned Data to a Folder as a PDF File](#)
 - [Scan to an Editable Text File \(OCR\)](#)
 - [Scan to Email Attachment](#)
-

Configure Certificate for Signed PDF

If you select Signed PDF for Scan to USB, Scan to Email server, Scan to FTP, Scan to SFTP, Scan to Network or Scan to SharePoint® features, you must configure a certificate on your machine using Web Based Management.

To use Signed PDF, you must install a certificate on your machine and your computer.

1. Start your web browser.

Type "http://machine's IP address" in your browser's address bar (where "machine's IP address" is the IP address of the machine or the print server name). For example: http://192.168.1.2

No password is required by default. If you have previously set a password, type it, and then click .

2. Click the **Administrator** tab.
3. Click the **Signed PDF** menu in the left navigation bar.

The Signed PDF configuration dialog box appears.

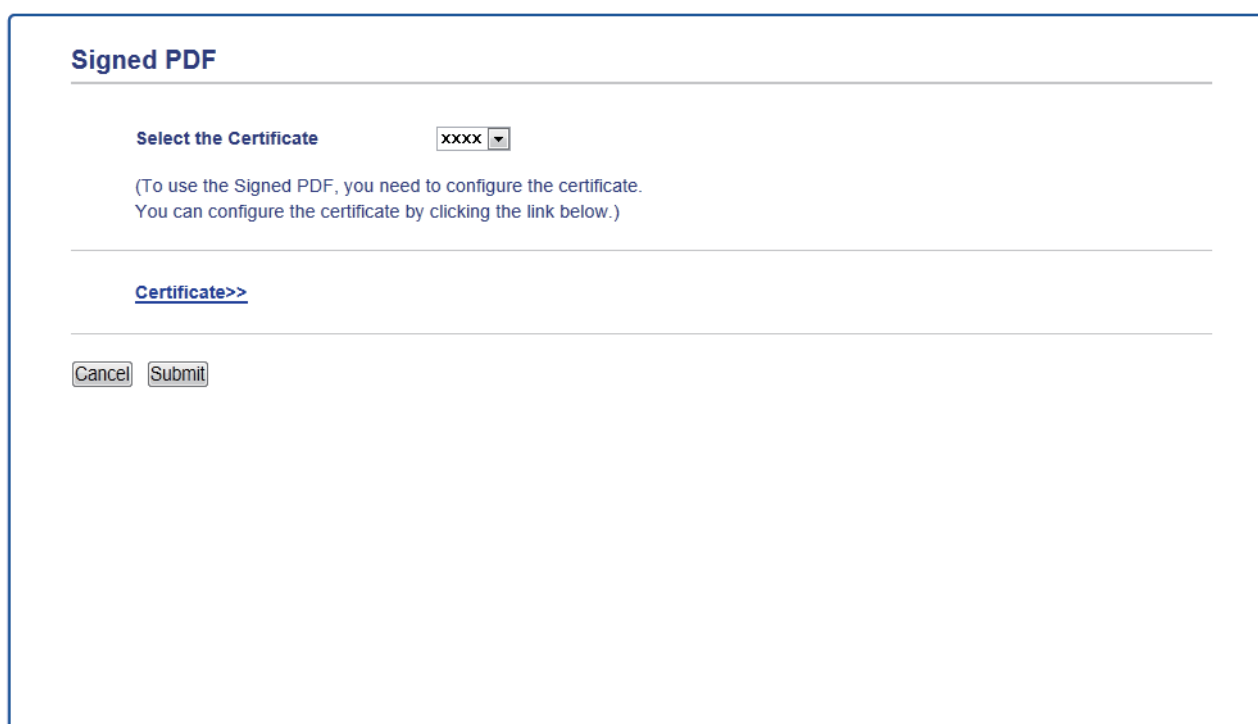

Signed PDF

Select the Certificate

(To use the Signed PDF, you need to configure the certificate.
You can configure the certificate by clicking the link below.)

[Certificate>>](#)

4. Click the **Select the Certificate** drop-down list, and then select the certificate.
5. Click **Submit**.



Related Information

- [Scan Using the Scan Button on Your Brother Machine](#)

Disable Scanning from Your Computer

You can disable the ability to scan from your computer. Set the pull scan setting using Web Based Management.

1. Start your web browser.

Type "http://machine's IP address" in your browser's address bar (where "machine's IP address" is the IP address of the machine or the print server name). For example: http://192.168.1.2

No password is required by default. If you have previously set a password, type it, and then click .

2. Click the **Scan** tab.
3. Click the **Scan from PC** menu in the left navigation bar.
4. In the **Pull Scan** field, click **Disabled**.
5. Click **Submit**.



Related Information

- [Scan Using the Scan Button on Your Brother Machine](#)
-

Scan from Your Computer (Windows®)

There are several ways you can use your computer to scan photos and documents on your Brother machine. Use the software applications provided by Brother, or use your favorite scanning application.

- [Scan Using ControlCenter4 Home Mode \(Windows®\)](#)
- [Scan Using ControlCenter4 Advanced Mode \(Windows®\)](#)
- [Scan Using Nuance™ PaperPort™ 14SE or Other Windows® Applications](#)
- [Scan Using Windows® Photo Gallery or Windows® Fax and Scan](#)

Scan Using ControlCenter4 Home Mode (Windows®)

Use ControlCenter4 Home Mode to access your machine's main features.

- [Scan Using ControlCenter4 Home Mode \(Windows®\)](#)
- [Save Scanned Data to a Folder as a PDF File Using ControlCenter4 Home Mode \(Windows®\)](#)
- [Scan Both Sides of a Document Automatically Using ControlCenter4 Home Mode \(Windows®\)](#)
- [Scan Settings for ControlCenter4 Home Mode \(Windows®\)](#)

Scan Using ControlCenter4 Home Mode (Windows®)



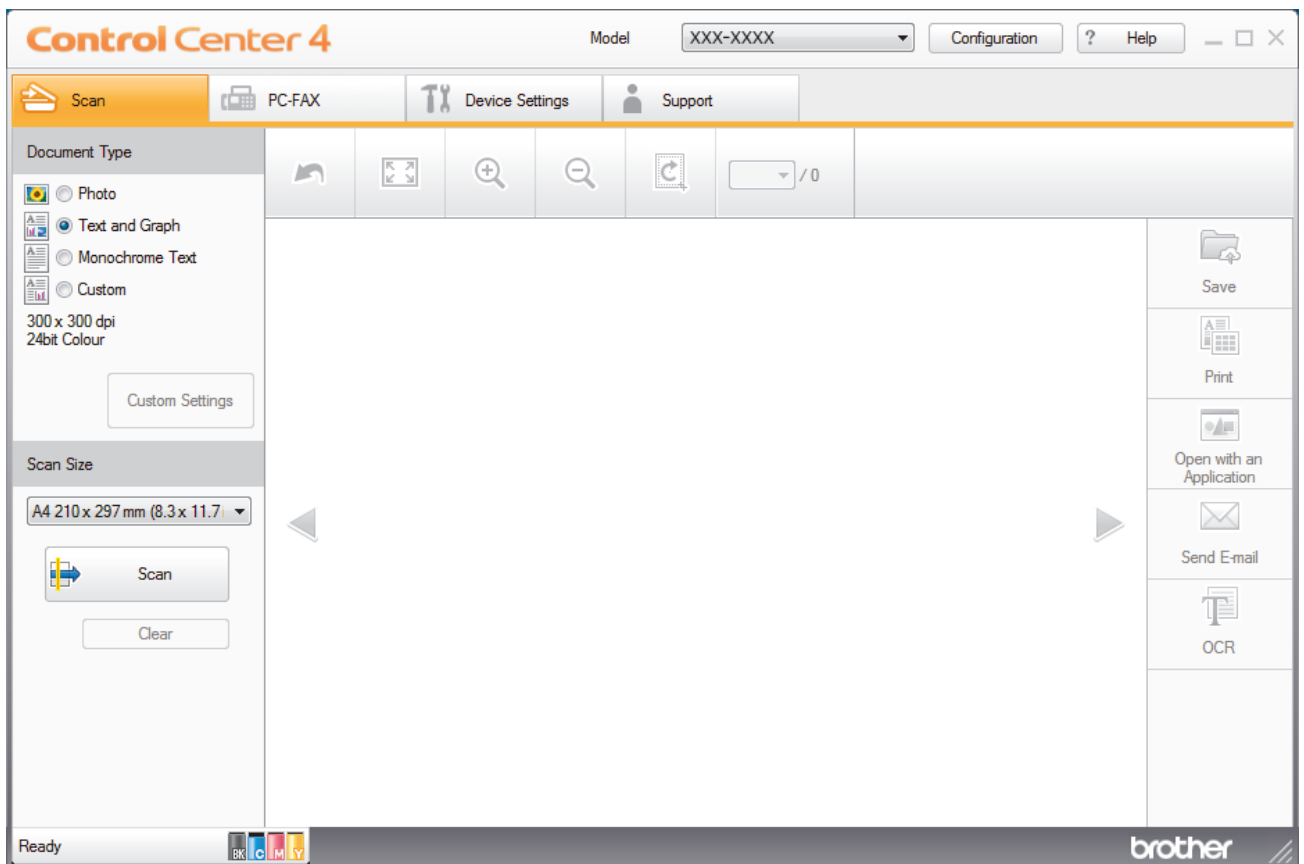

Select **Home Mode** as the mode setting for ControlCenter4.

1. Load your document.
2. Click the  (**ControlCenter4**) icon in the task tray, and then click **Open**.
3. Click the **Scan** tab.



4. Select the **Document Type**.
5. Change the document's **Scan Size**, if needed.
6. Click  (**Scan**).

The machine starts scanning, and the scanned image appears in the image viewer.

7. Click the left or right arrow buttons to preview each scanned page.
8. Crop the scanned image, if needed.
9. Do one of the following:
 - Click  (**Save**) to save scanned data.
 - Click  (**Print**) to print scanned data.
 - Click  (**Open with an Application**) to open scanned data in another application.
 - Click  (**Send E-mail**) to attach scanned data to an email.
 - Click  (**OCR**) to convert your scanned document to an editable text file. (available only for certain models)



Related Information

- [Scan Using ControlCenter4 Home Mode \(Windows®\)](#)
- [Select Document Type Using ControlCenter4 Home Mode \(Windows®\)](#)
- [Change Scan Size Using ControlCenter4 Home Mode \(Windows®\)](#)
- [Crop a Scanned Image Using ControlCenter4 Home Mode \(Windows®\)](#)
- [Print Scanned Data Using ControlCenter4 Home Mode \(Windows®\)](#)
- [Scan to an Application Using ControlCenter4 Home Mode \(Windows®\)](#)

Home > Scan > Scan from Your Computer (Windows®) > Scan Using ControlCenter4 Home Mode (Windows®) > Scan Using ControlCenter4 Home Mode (Windows®) > Select Document Type Using ControlCenter4 Home Mode (Windows®)

Select Document Type Using ControlCenter4 Home Mode (Windows®)

- Select the **Document Type** option that matches the type of original you want to scan.

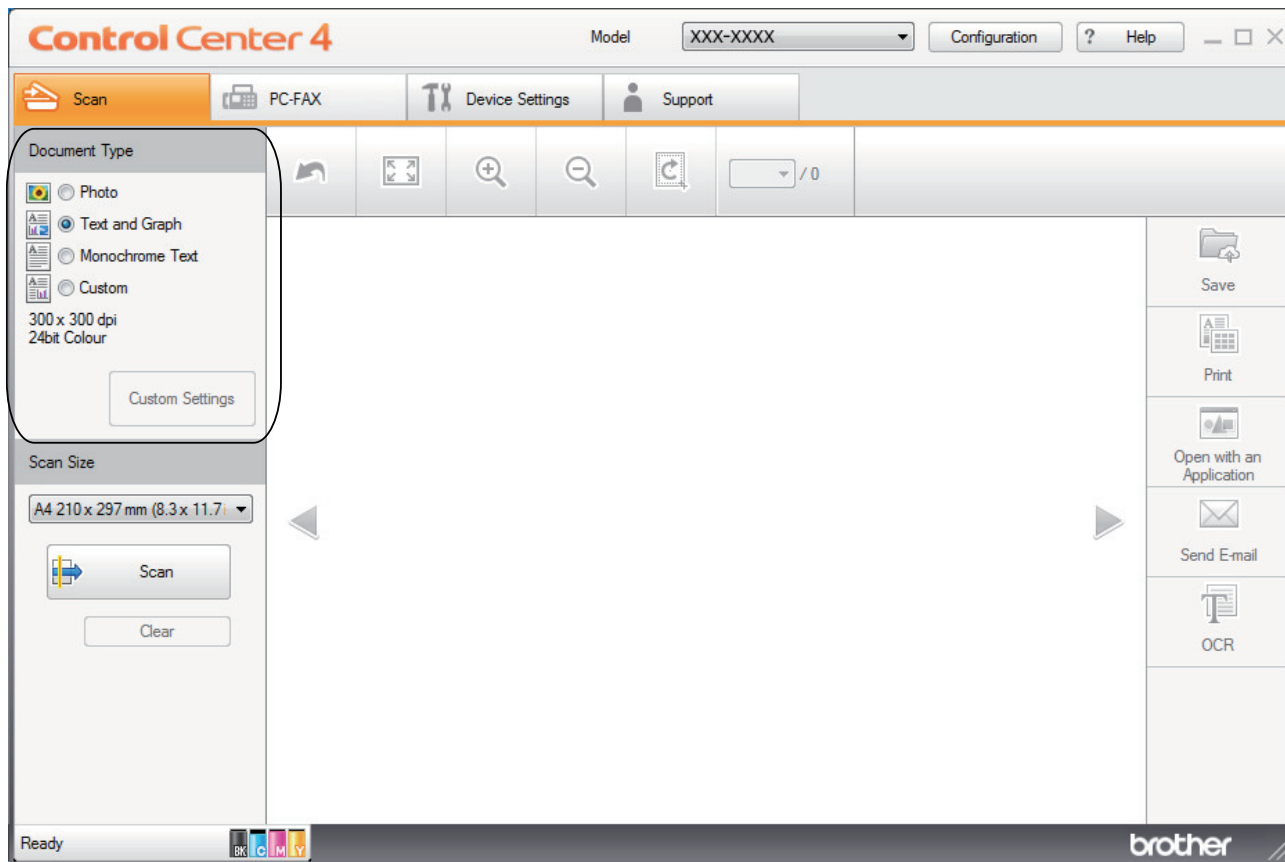

Option	Description
Photo	600 x 600 dpi 24bit Color
Text and Graph	300 x 300 dpi 24bit Color
Monochrome Text	200 x 200 dpi Black & White
Custom	300 x 300 dpi (24bit Color as default) Select the scan settings you want from the Custom Settings button.

✓ Related Information

- [Scan Using ControlCenter4 Home Mode \(Windows®\)](#)
- [Custom Scan Settings \(Windows®\)](#)

Custom Scan Settings (Windows®)

Select **Custom** in the **Document Type** list to change advanced scan settings.

- Select **Custom**, and then click the **Custom Settings** button.

The **Custom Scan Settings** dialog box appears.

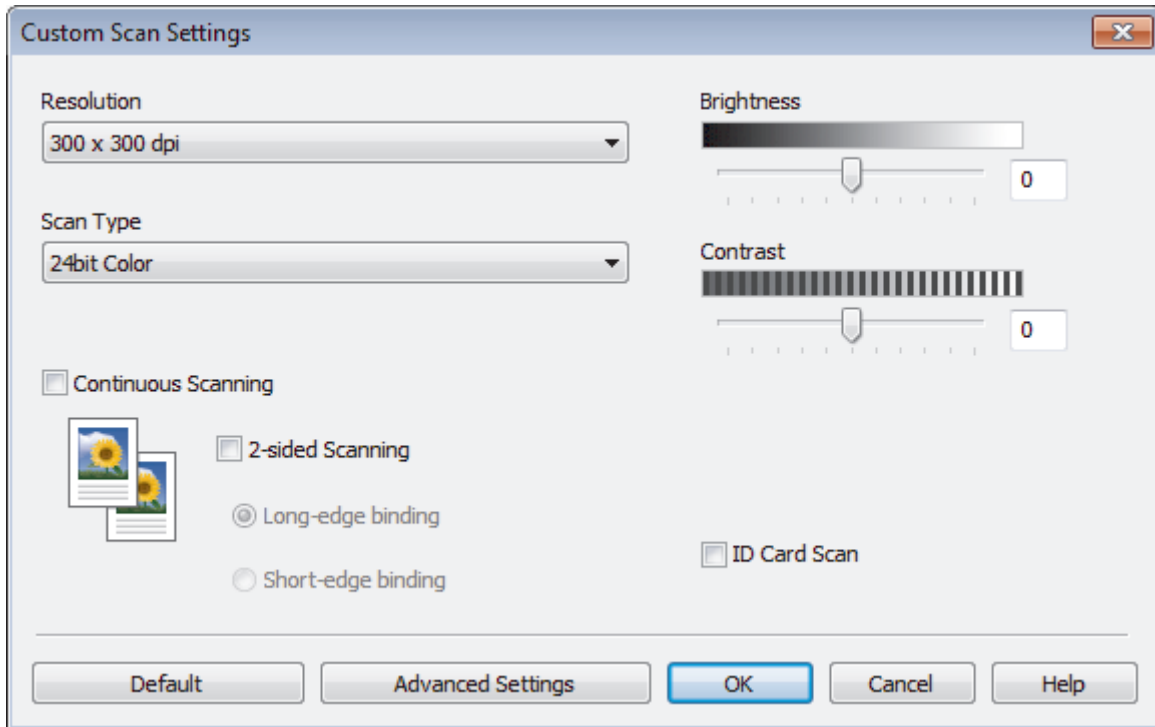

You can change the following settings:

Resolution

Select a scanning resolution from the **Resolution** drop-down list. Higher resolutions take more memory and transfer time, but produce a finer scanned image.

Scan Type

Select from a range of scan color depths.

- Auto

Use for any type of document. This mode automatically picks an appropriate color depth for the document.

- Black & White

Use for text or line art images.

- Gray (Error Diffusion)

Use for photographic images or graphics. (Error Diffusion is a method for creating simulated gray images without using true gray dots. Black dots are put in a specific pattern to give a gray appearance.)

- True Gray

Use for photographic images or graphics. This mode is more accurate because it uses up to 256 shades of gray.

- 24bit Color

Use to create an image with the most accurate color reproduction. This mode uses up to 16.8 million colors to scan the image, but it requires the most memory and has the longest transfer time.

Brightness

Set the **Brightness** level by dragging the slider to the right or left to lighten or darken the image. If the scanned image is too light, set a lower brightness level and scan the document again. If the image is too dark, set a higher brightness level and scan the document again. You can also type a value into the field to set the **Brightness** level.

Contrast

Increase or decrease the **Contrast** level by moving the slider to the right or left. An increase emphasizes dark and light areas of the image, while a decrease reveals more details in gray areas. You can also type a value into the field to set the **Contrast** level.

Continuous Scanning

Select this option to scan multiple pages. After a page is scanned, select either continue scanning or finish.

2-sided Scanning

Select this check box to scan both sides of the document. When using the Automatic 2-sided Scan feature, you must select the **Long-edge binding** or **Short-edge binding** option, depending on the layout of your original, to make sure the data file you create appears correctly.

(MFC-L8900CDW)

ID Card Scan

Select this check box to scan both sides of an identification card onto one page.

Advanced Settings

Configure advanced settings by clicking the **Advanced Settings** button in the Scan Settings dialog box.

- **Remove Bleed-through / Pattern**
 - **Remove Background Color**

Remove the base color of documents to make the scanned data more legible.
- **Rotate Image**

Rotate the scanned image.
- **Skip Blank Page**

Remove the document's blank pages from the scanning results.
- **Display Scanning Results**

Show the numbers of total pages saved and blank pages skipped on your computer screen.
- **ADF Auto Deskew**

When scanning the document from the ADF, the machine corrects skewing of the document automatically.



Related Information

- [Select Document Type Using ControlCenter4 Home Mode \(Windows®\)](#)
-

Home > Scan > Scan from Your Computer (Windows®) > Scan Using ControlCenter4 Home Mode (Windows®) > Scan Using ControlCenter4 Home Mode (Windows®) > Change Scan Size Using ControlCenter4 Home Mode (Windows®)

Change Scan Size Using ControlCenter4 Home Mode (Windows®)

For faster scan speeds, select the exact size of your document from the **Scan Size** drop-down menu.

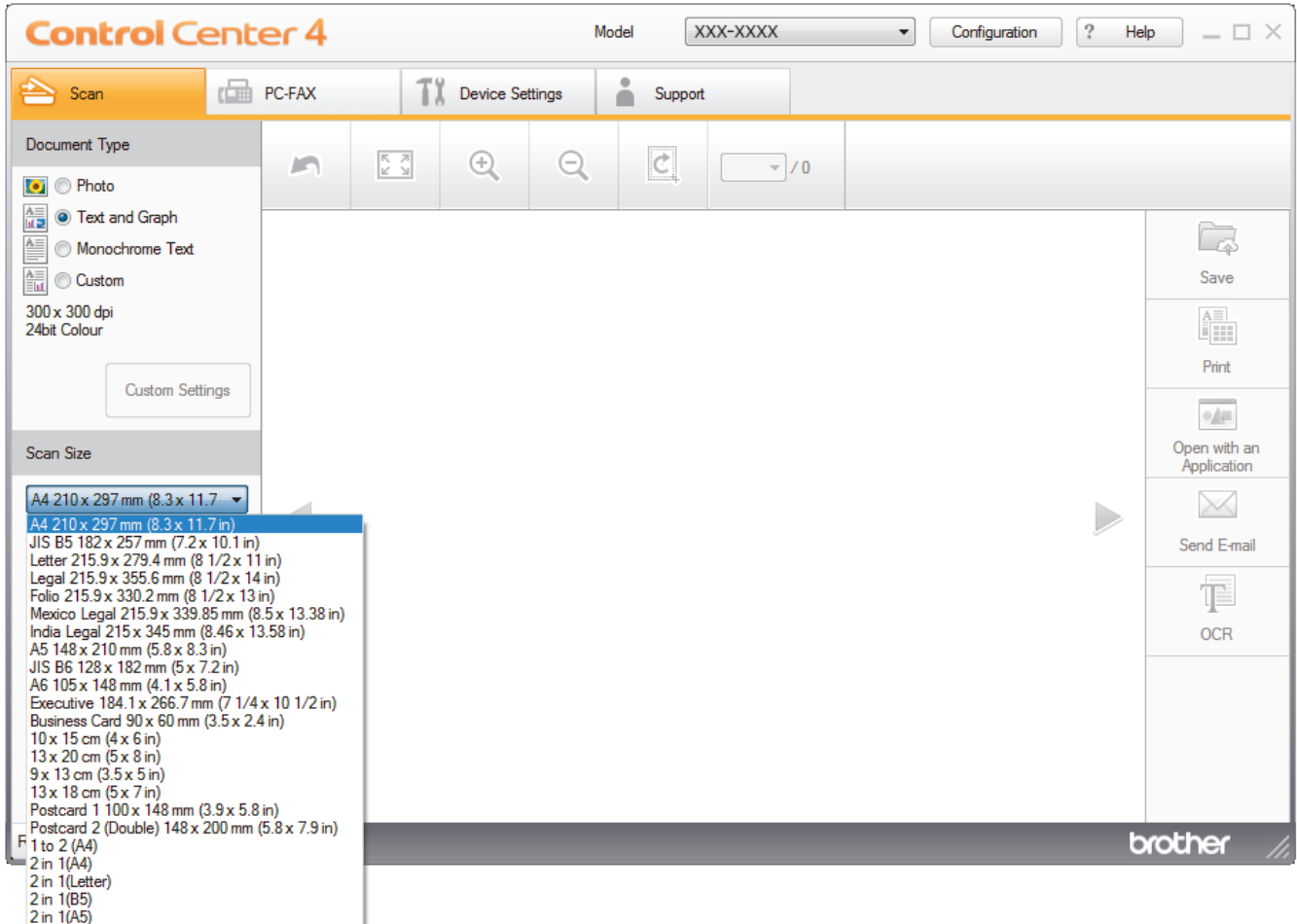

✓ Related Information

- [Scan Using ControlCenter4 Home Mode \(Windows®\)](#)

Crop a Scanned Image Using ControlCenter4 Home Mode (Windows®)

The crop tool on the Image Editing Toolbar lets you trim unwanted areas from your scanned image. Use the **Zoom In** and **Zoom Out** tools to help view the image to be cropped.

Image Editing Toolbar

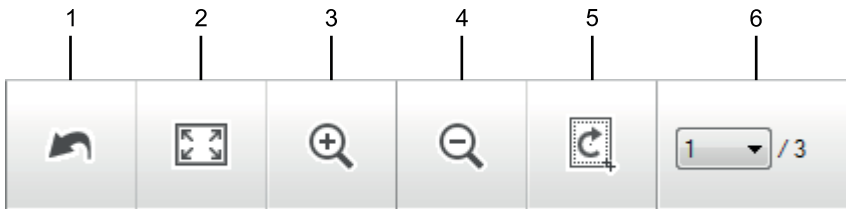

1. Restart

Cancels all the edits applied to the selected image. The edited image returns to its original state.

2. Fit to Window

Displays the scanned image so that the entire image fits in the window.

3. Zoom In

Zooms in on the scanned image.

4. Zoom Out

Zooms out of the scanned image.

5. Crop and Edit

Removes the outer parts of the image. Click the **Crop and Edit** button, and then change the frame to contain the area you want to keep after cropping.

6. Page Counter

Indicates the page number of the scanned page currently shown in the image viewer. To display a different page, select the desired page number from the drop-down page number list.



If you have scanned multiple pages, you can see the next or previous scanned page by clicking the left or right arrow buttons in the preview window.

1. Scan a document.

2. Click  (**Crop and Edit**) to edit the scanned image.

The **Crop and Edit - ControlCenter4** window appears.

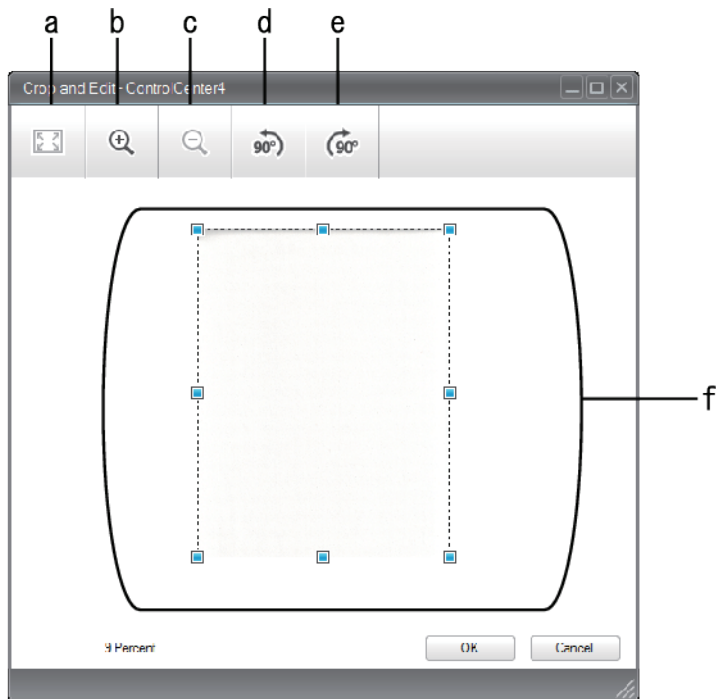

- a. Expands the scanned image so that the entire image fits in the window.
 - b. Zooms in on the image.
 - c. Zooms out of the image.
 - d. Rotates the image counter-clockwise 90 degrees.
 - e. Rotates the image clockwise 90 degrees.
 - f. Click and drag the frame to adjust the area to be cropped.
3. Click **OK**.
- The edited image appears in the image viewer.



Related Information

- [Scan Using ControlCenter4 Home Mode \(Windows®\)](#)

Home > Scan > Scan from Your Computer (Windows®) > Scan Using ControlCenter4 Home Mode (Windows®) > Scan Using ControlCenter4 Home Mode (Windows®) > Print Scanned Data Using ControlCenter4 Home Mode (Windows®)

Print Scanned Data Using ControlCenter4 Home Mode (Windows®)

Scan a document on your Brother machine, and then print copies using the printer driver features that are available in ControlCenter4.

1. Scan a document.
2. Click **Print**.

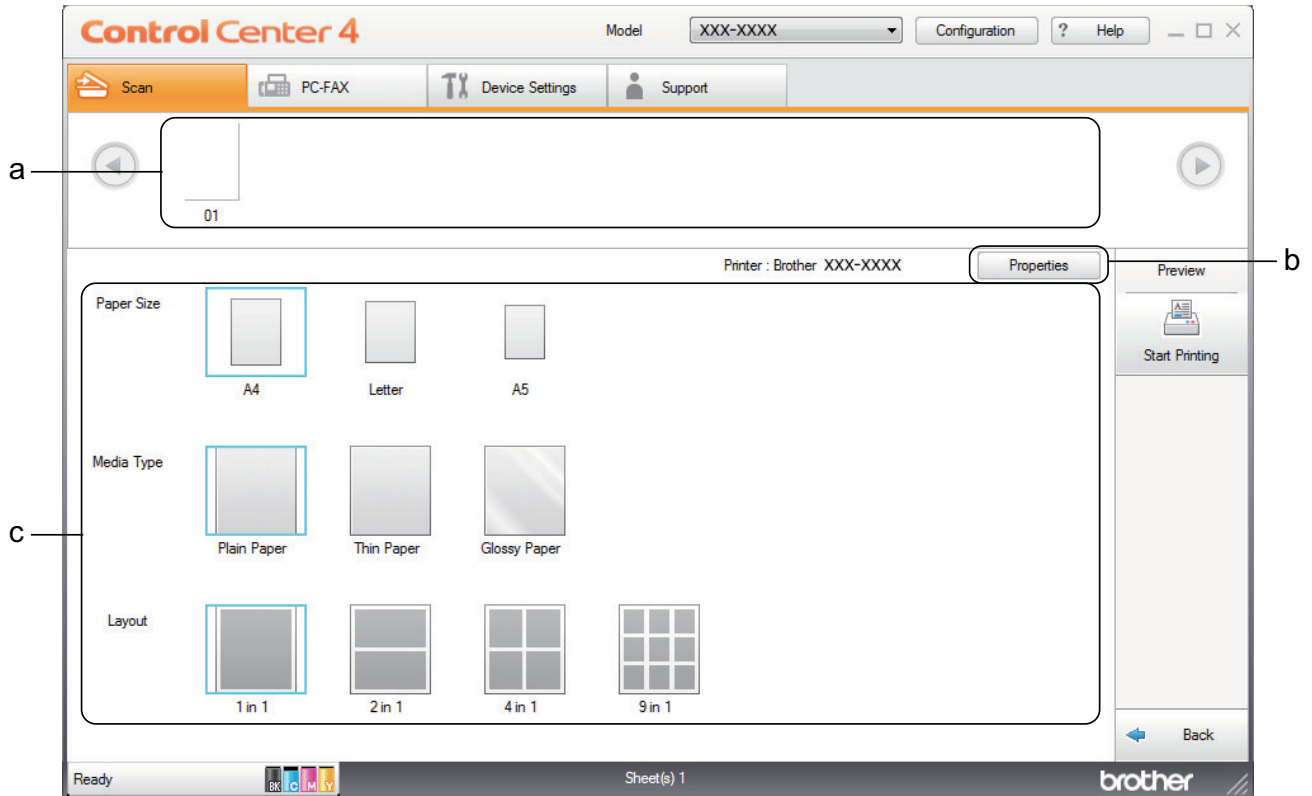

- a. Shows which images are currently selected.
 - b. Click the **Properties** button to change specific printer settings.
 - c. Select the **Paper Size**, **Media Type** and **Layout** options. The current settings are enclosed in a blue square.
3. Configure the print settings, and then click the **Start Printing** button.

✓ Related Information

- [Scan Using ControlCenter4 Home Mode \(Windows®\)](#)

Home > Scan > Scan from Your Computer (Windows®) > Scan Using ControlCenter4 Home Mode (Windows®) > Scan Using ControlCenter4 Home Mode (Windows®) > Scan to an Application Using ControlCenter4 Home Mode (Windows®)

Scan to an Application Using ControlCenter4 Home Mode (Windows®)

The **Open with an Application** button lets you scan an image directly into your graphics application for editing.

Select **Home Mode** as the mode setting for ControlCenter4.

1. Load your document.
2. Click the  (**ControlCenter4**) icon in the task tray, and then click **Open**.
3. Click the **Scan** tab.

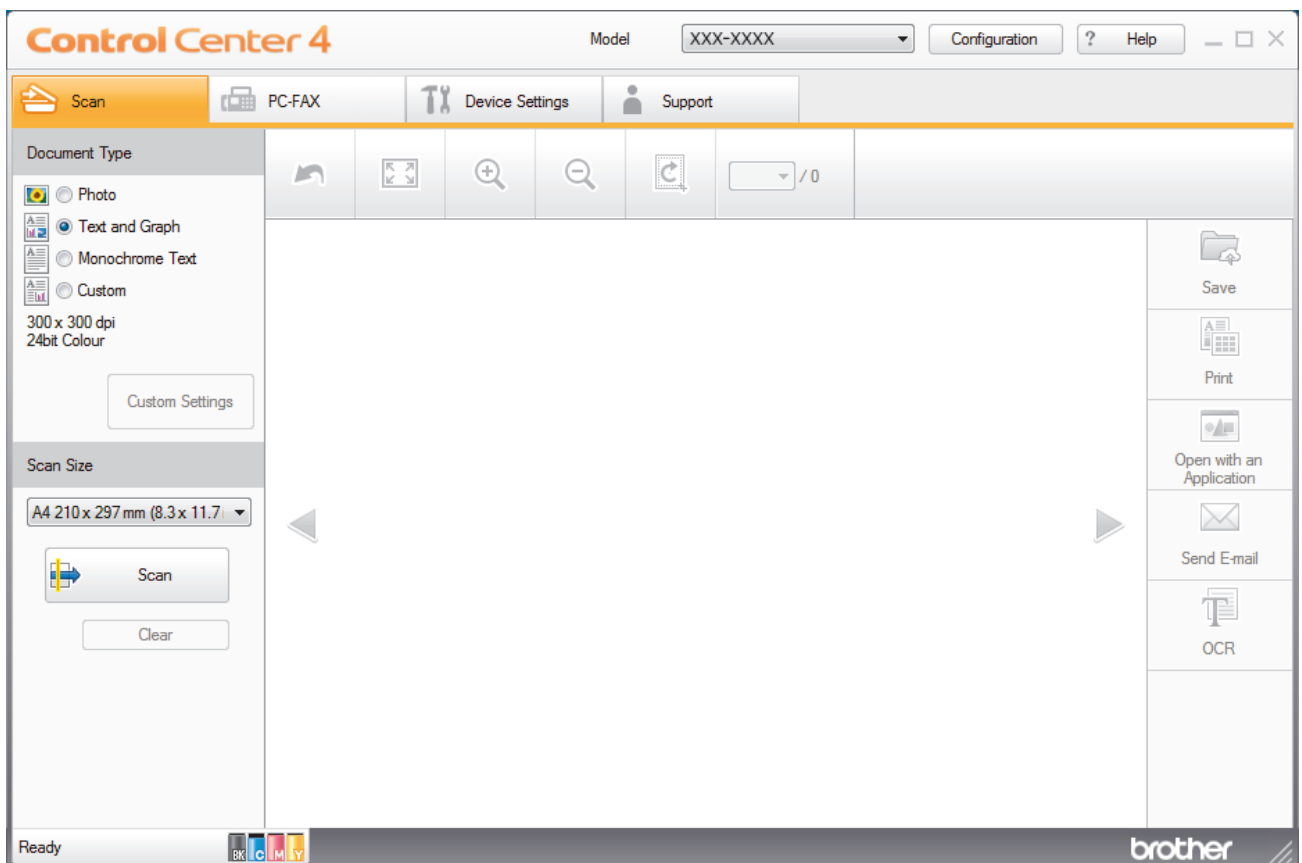

4. Select the **Document Type**.
 5. Change the size of your document, if needed.
 6. Click  (**Scan**).
- The machine starts scanning, and the scanned image appears in the image viewer.
7. Click the left or right arrow buttons to preview each scanned page.
 8. Crop the scanned image, if needed.
 9. Click the **Open with an Application** button.
 10. Select the application from the drop-down list, and then click **OK**.
- The image opens in the application you have selected.

✓ Related Information

- [Scan Using ControlCenter4 Home Mode \(Windows®\)](#)

Save Scanned Data to a Folder as a PDF File Using ControlCenter4 Home Mode (Windows®)

Select **Home Mode** as the mode setting for ControlCenter4.

1. Load your document.
2. Click the  (ControlCenter4) icon in the task tray, and then click **Open**.
3. Click the **Scan** tab.

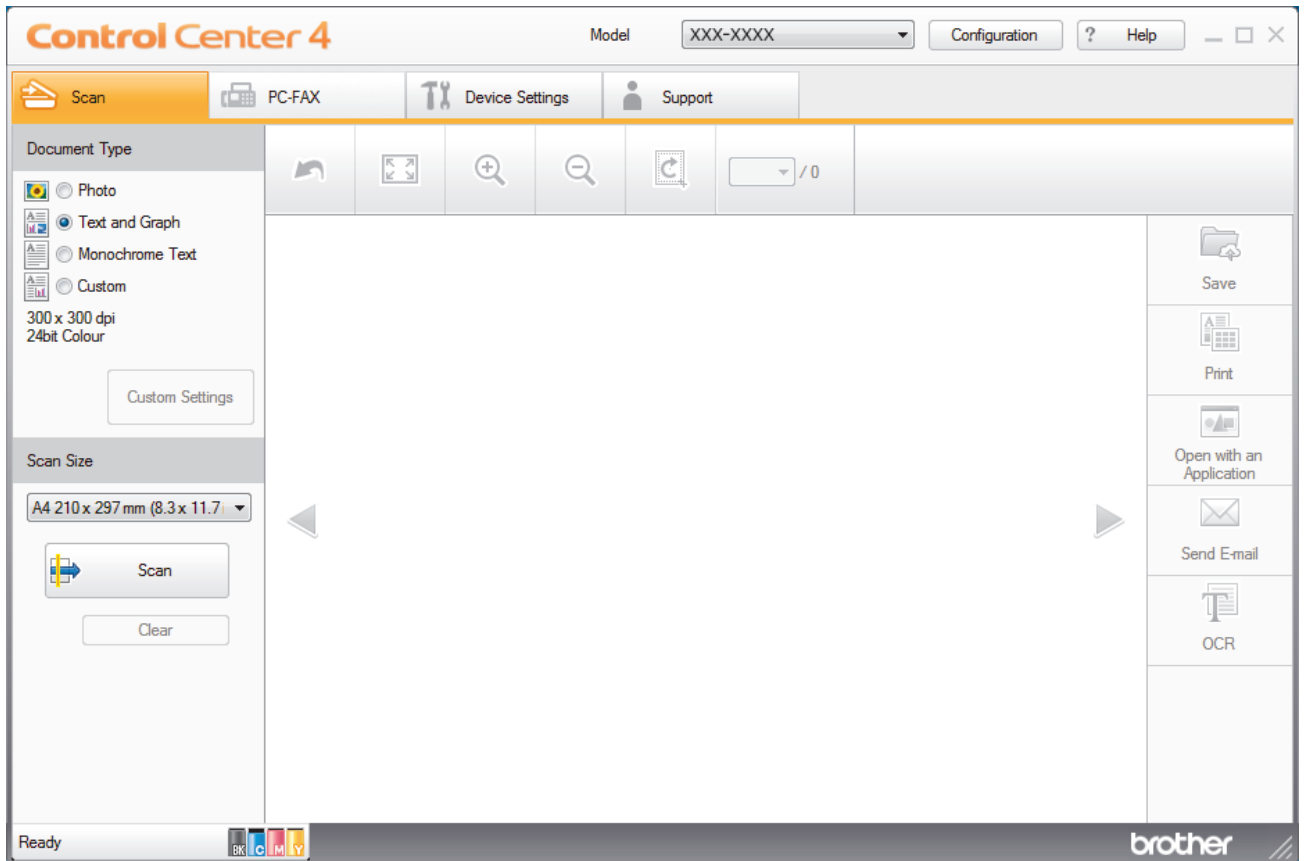

4. Select the **Document Type**.
5. Change the size of your document, if needed.
6. Click  (**Scan**).
The machine starts scanning, and the scanned image appears in the image viewer.
7. Click the left or right arrow buttons to preview each scanned page.
8. Click **Save**.
The **Save** dialog box appears.
9. Click the **File Type** drop-down list, and then select a PDF file.

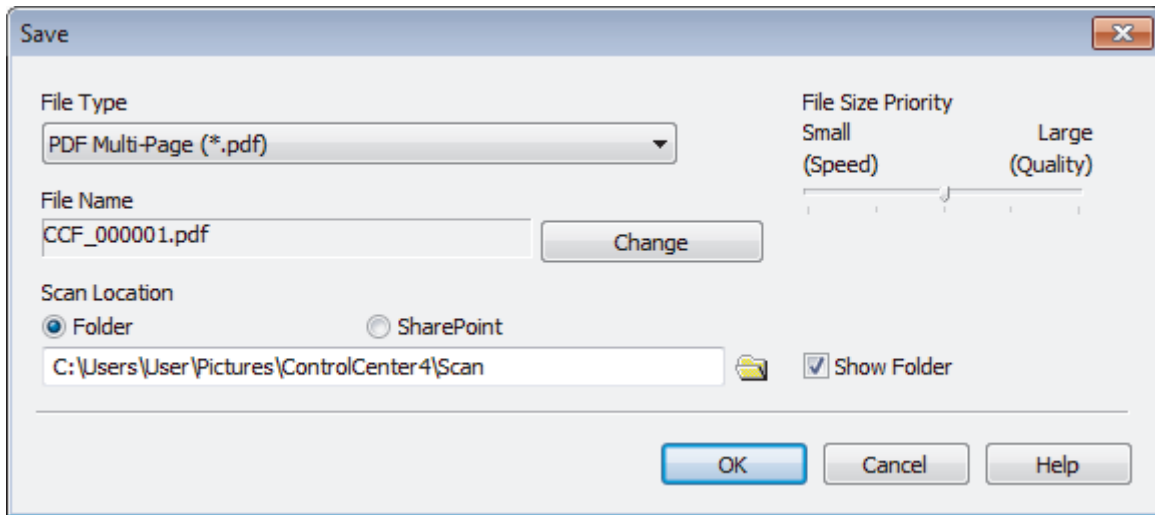

To save the document as a password-protected PDF, select **Secure PDF Single-Page (*.pdf)** or **Secure PDF Multi-Page (*.pdf)** from the **File Type** drop-down list, click , and then type the password.

10. To change the file name, click the **Change** button, if needed.
11. Click the folder icon to browse and select the folder where you want to save your scanned documents.
12. Click **OK**.

The scanned document is saved to the destination folder as a PDF.



Related Information

- [Scan Using ControlCenter4 Home Mode \(Windows®\)](#)

Scan Both Sides of a Document Automatically Using ControlCenter4 Home Mode (Windows®)

Related Models: MFC-L8900CDW

Select **Home Mode** as the mode setting for ControlCenter4.

1. Load documents in the ADF.



To scan both sides of a document automatically, you must use the ADF, not the flatbed scanner glass.

2. Click the  (**ControlCenter4**) icon in the task tray, and then click **Open**.
3. Click the **Scan** tab.

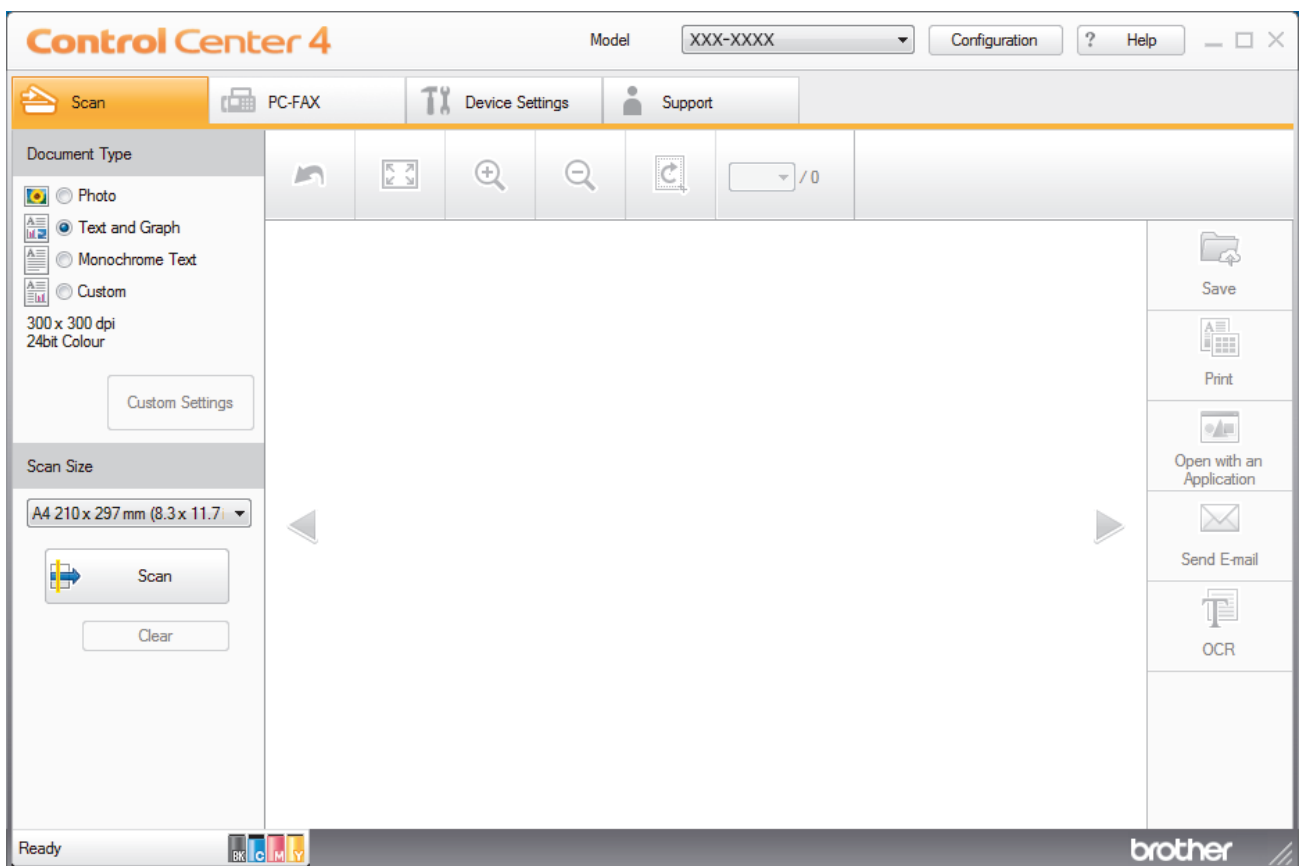





4. Under **Document Type**, select **Custom**, and then click the **Custom Settings** button.
The **Custom Scan Settings** dialog box appears.
5. Select the **2-sided Scanning** check box.
6. Select the **Long-edge binding** or **Short-edge binding** option, depending on the Original layout.
7. Configure other **Custom Scan Settings**, if needed.
8. Click **OK**.

9. Click  (**Scan**).

The machine starts scanning, and the scanned image appears in the image viewer.

10. Click the left or right arrow buttons to preview each scanned page.
11. Do one of the following:

-
- Click  (**Save**) to save scanned data.
 - Click  (**Print**) to print scanned data.
 - Click  (**Open with an Application**) to open scanned data in another application.
 - Click  (**Send E-mail**) to attach scanned data to an email.
 - Click  (**OCR**) to convert your scanned document to an editable text file. (available only for certain models)



Related Information

- [Scan Using ControlCenter4 Home Mode \(Windows®\)](#)
-

Scan Settings for ControlCenter4 Home Mode (Windows®)

Settings	Applicable Features			
	Open with an Application	OCR	Send E-mail	Save
File Type	-	Yes	Yes	Yes
Target Application	Yes	Yes	-	-
OCR Language	-	Yes	-	-
File Name	-	-	-	Yes
Scan Location	-	-	-	Yes
Show Folder	-	-	-	Yes
File Size Priority	-	-	Yes	Yes

File Type

Select the file type you want to use for the scanned data.

For Send E-mail and Save

- **Windows Bitmap (*.bmp)**
- **JPEG (*.jpg)** (recommended for most users when scanning pictures)
- **TIFF Single-Page (*.tif)**
- **TIFF Multi-Page (*.tif)**
- **Portable Network Graphics (*.png)**
- **PDF Single-Page (*.pdf)** (recommended for scanning and sharing documents)
- **PDF Multi-Page (*.pdf)** (recommended for scanning and sharing documents)
- **PDF/A Single-Page (*.pdf)** (recommended for scanning and sharing documents)
- **PDF/A Multi-Page (*.pdf)** (recommended for scanning and sharing documents)
- **High Compression PDF Single-Page (*.pdf)**
- **High Compression PDF Multi-Page (*.pdf)**
- **Secure PDF Single-Page (*.pdf)**
- **Secure PDF Multi-Page (*.pdf)**
- **Searchable PDF Single-Page (*.pdf)**
- **Searchable PDF Multi-Page (*.pdf)**
- **XML Paper Specification (*.xps)** (the XML Paper Specification is available for Windows® 7, Windows® 8 and Windows® 10, and when using applications that support XML Paper Specification files)
- **Microsoft Office Word (*.docx)** (Available only for certain models)
- **Microsoft Office PowerPoint (*.pptx)** (Available only for certain models)
- **Microsoft Office Excel (*.xlsx)**(Available only for certain models)

For OCR

- **HTML 3.2 (*.htm)**
- **HTML 4.0 (*.htm)**
- **Microsoft Excel 2003, XP (*.xls)**
- **RTF Word 2000 (*.rtf)**
- **WordPad (*.rtf)**
- **WordPerfect 9, 10 (*.wpd)**
- **Text (*.txt)**
- **Searchable PDF Single-Page (*.pdf)**

-
- **Searchable PDF Multi-Page (*.pdf)**

Target Application

Select the destination application from the drop-down list.

OCR Language

Set the optical character recognition (OCR) language to match the language of the scanned document's text.

File Name

Click **Change** to change the file name's prefix.

Scan Location

Select the **Folder** or **SharePoint** radio button to specify the destination where you want to save your scanned documents.

Show Folder

Select this option to automatically display the destination folder after scanning.

File Size Priority

Adjust the data compression ratio of the scanned image. Change the file size by moving the **File Size Priority** slider to the right or left.

Custom Settings

Select the **Custom** option, click the **Custom Settings** button, and then change settings.

Scan Size

Select the exact size of your document from the **Scan Size** drop-down menu.



Related Information

- [Scan Using ControlCenter4 Home Mode \(Windows®\)](#)
-

Scan Using ControlCenter4 Advanced Mode (Windows®)

ControlCenter4 Advanced Mode gives you more control over the details of your machine's features and allows you to customize one-button scan actions.

- [Scan Photos and Graphics Using ControlCenter4 Advanced Mode \(Windows®\)](#)
- [Save Scanned Data to a Folder as a PDF File Using ControlCenter4 Advanced Mode \(Windows®\)](#)
- [Scan Both Sides of a Document Automatically Using ControlCenter4 Advanced Mode \(Windows®\)](#)
- [Scan Both Sides of an ID Card Using ControlCenter4 Advanced Mode \(Windows®\)](#)
- [Scan to Email Attachment Using ControlCenter4 Advanced Mode \(Windows®\)](#)
- [Scan to an Editable Text File \(OCR\) Using ControlCenter4 Advanced Mode \(Windows®\)](#)
- [Scan Settings for ControlCenter4 Advanced Mode \(Windows®\)](#)

Scan Photos and Graphics Using ControlCenter4 Advanced Mode (Windows®)

Send scanned photos or graphics directly to your computer.

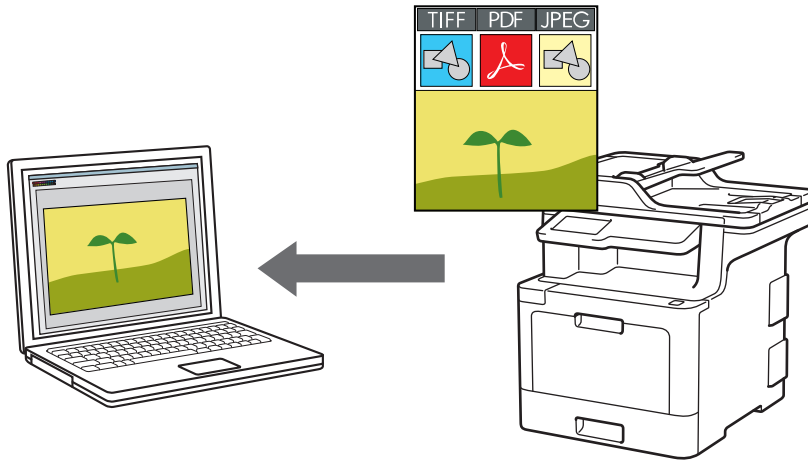

Select **Advanced Mode** as the mode setting for ControlCenter4.

1. Load your document.
2. Click the  (ControlCenter4) icon in the task tray, and then click **Open**.
3. Click the **Scan** tab.

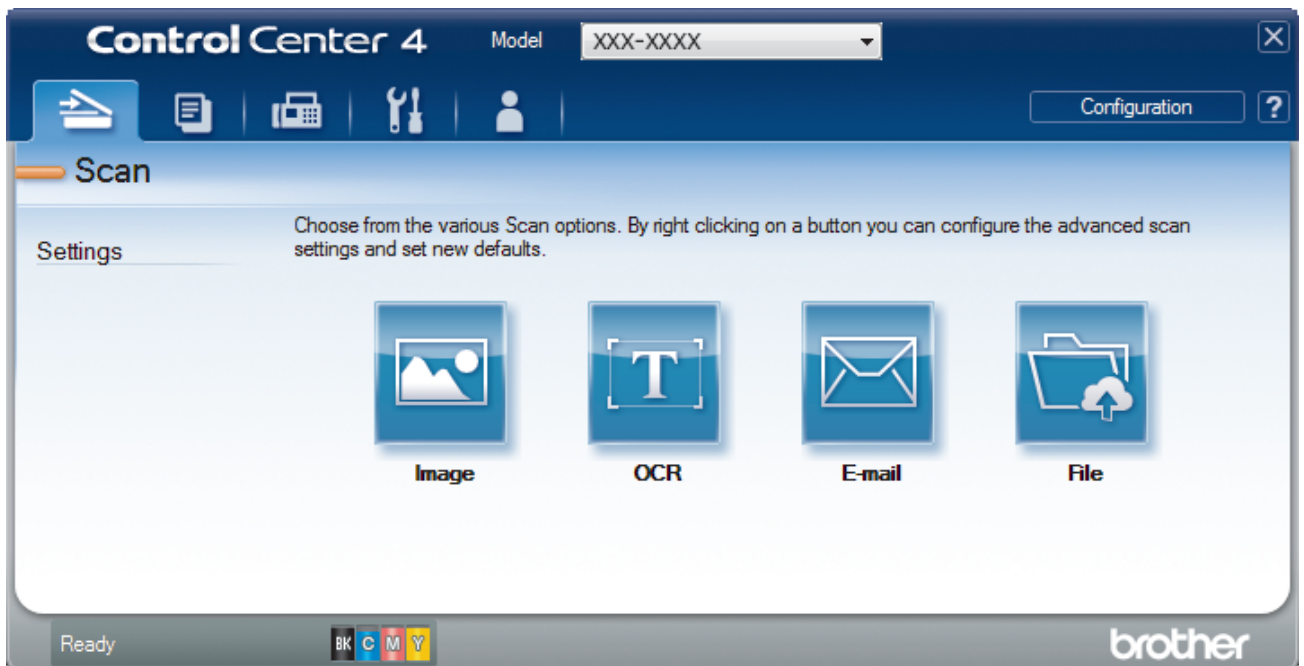

4. Click the **Image** button.
The scan settings dialog box appears.

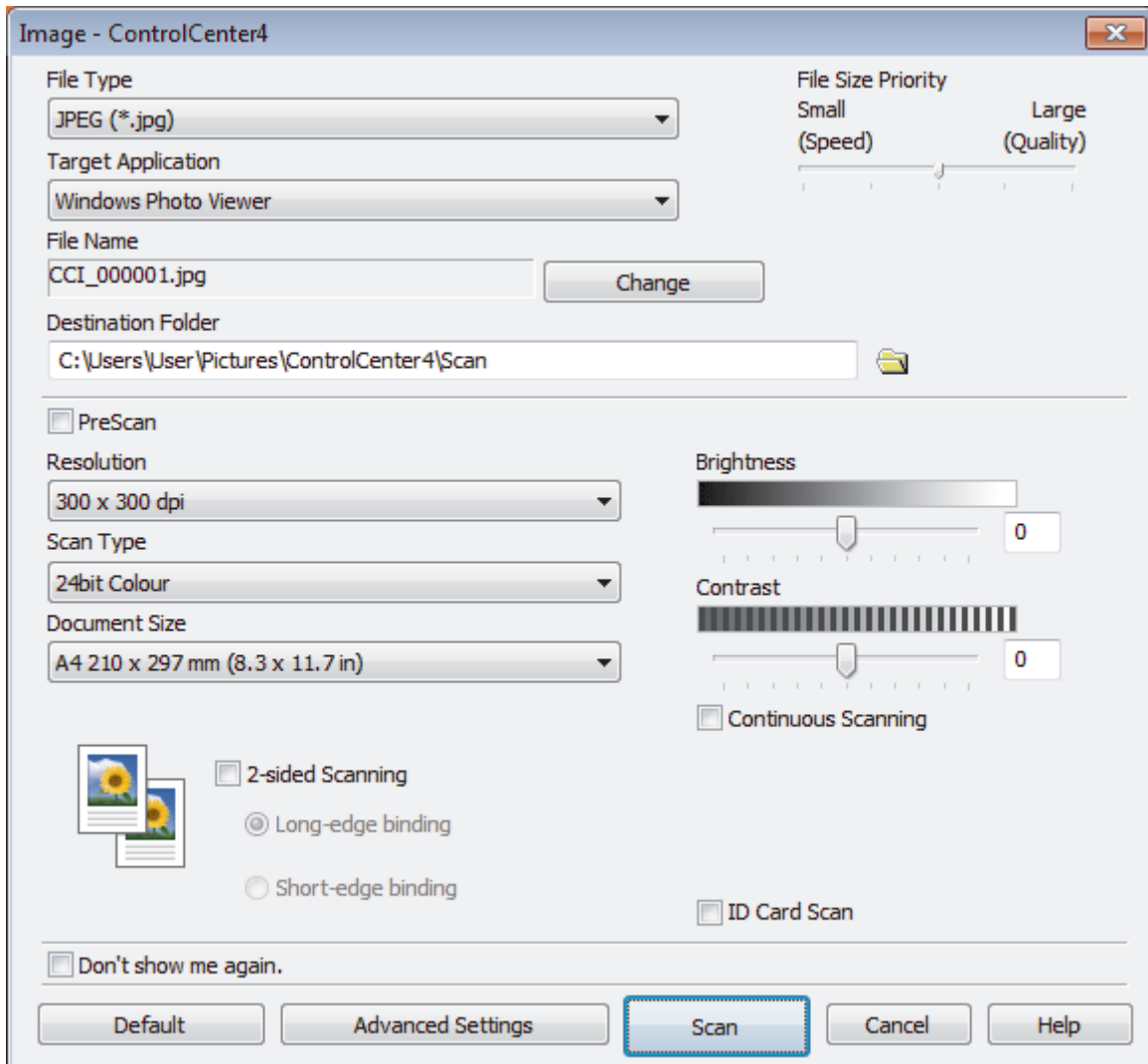

5. Change the scan settings, such as file format, file name, destination folder, resolution and color, if needed.



- To change the file name, click **Change**.
- To change **Destination Folder**, click the folder icon.
- To preview and configure the scanned image, select the **PreScan** check box.

6. Click **Scan**.

The machine starts scanning. The image opens in the application you have selected.



Related Information

- [Scan Using ControlCenter4 Advanced Mode \(Windows®\)](#)

Home > Scan > Scan from Your Computer (Windows®) > Scan Using ControlCenter4 Advanced Mode (Windows®) > Save Scanned Data to a Folder as a PDF File Using ControlCenter4 Advanced Mode (Windows®)

Save Scanned Data to a Folder as a PDF File Using ControlCenter4 Advanced Mode (Windows®)

Scan documents and save them to a folder on your computer as PDF files.

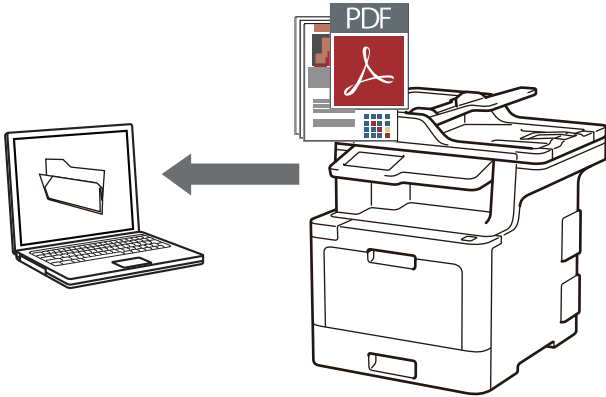

Select **Advanced Mode** as the mode setting for ControlCenter4.

1. Load your document.
2. Click the  (ControlCenter4) icon in the task tray, and then click **Open**.
3. Click the **Scan** tab.



- Click the **File** button.

The scan settings dialog box appears.

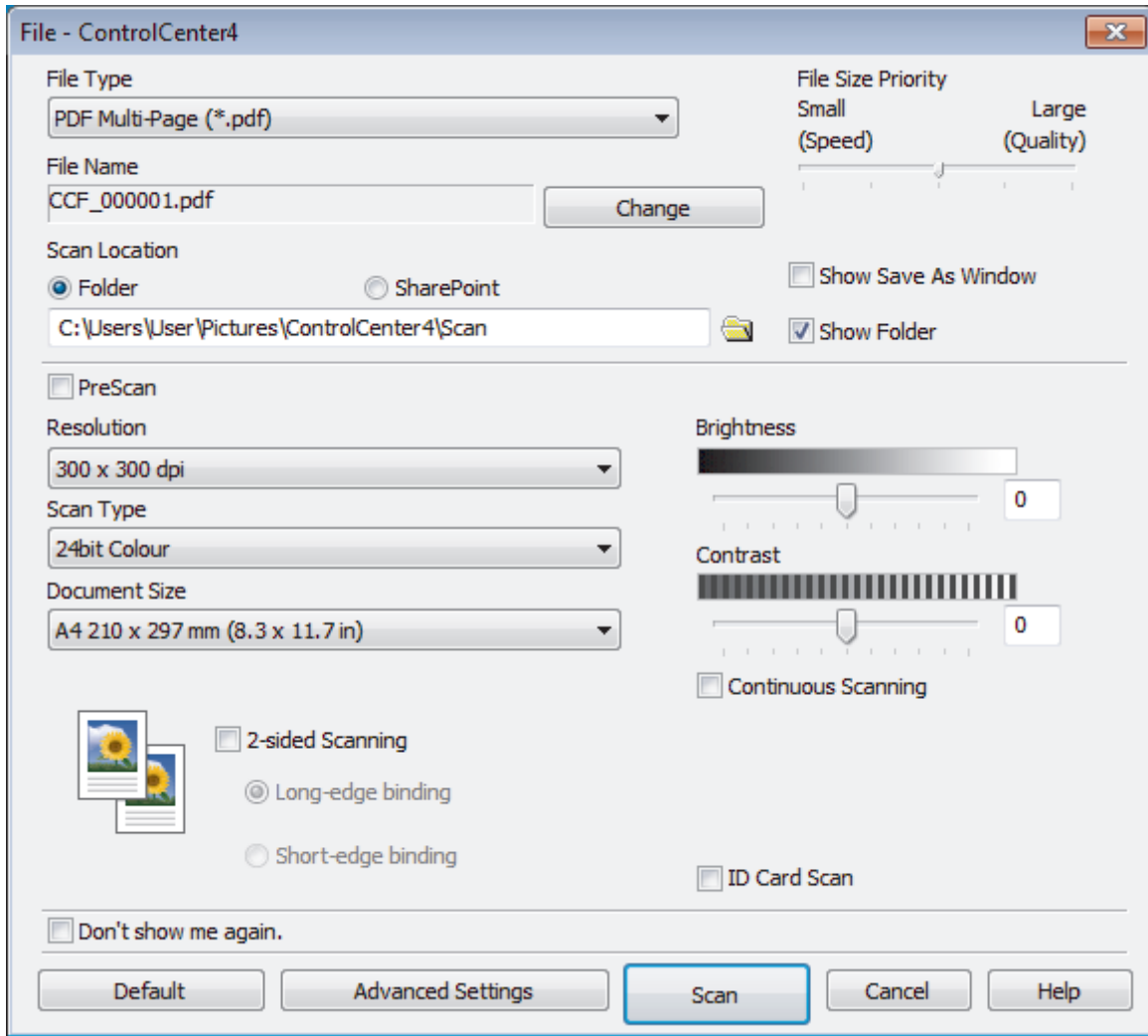

- Click the **File Type** drop-down list, and then select a PDF file.



To save the document as a password-protected PDF, select **Secure PDF Single-Page (*.pdf)** or **Secure PDF Multi-Page (*.pdf)** from the **File Type** drop-down list, click , and then type the password.

- Click the folder icon to browse and select the folder where you want to save your scanned documents.
- Change the scan settings, such as file format, file name, resolution and color, if needed.



To preview and configure the scanned image, select the **PreScan** check box.

- Click **Scan**.

The machine starts scanning. The file is saved in the folder you selected.



Related Information

- [Scan Using ControlCenter4 Advanced Mode \(Windows®\)](#)

Scan Both Sides of a Document Automatically Using ControlCenter4 Advanced Mode (Windows®)

Related Models: MFC-L8900CDW

Select **Advanced Mode** as the mode setting for ControlCenter4.

1. Load documents in the ADF.



To scan both sides of a document automatically, you must use the ADF, not the flatbed scanner glass.

2. Click the  (**ControlCenter4**) icon in the task tray, and then click **Open**.
3. Click the **Scan** tab.



4. Click the button for the setting you want to change (**Image**, **OCR**, **E-mail**, or **File**).
The scan settings dialog box appears.
5. Select the **2-sided Scanning** check box.
6. Select the **Long-edge binding** or **Short-edge binding** option, depending on the Original layout.
7. Change the scan settings, such as file format, file name, destination folder, resolution and color, if needed.



- To change the file name, click **Change**.
- To change **Destination Folder**, click the folder icon.

8. Click **Scan**.
The machine starts scanning.

You have now changed the default settings for your selected Scan to action. These settings will be used the next time one of the scan options (**Image**, **OCR**, **E-mail**, or **File**) is selected for this action.

✓ Related Information

- [Scan Using ControlCenter4 Advanced Mode \(Windows®\)](#)

Scan Both Sides of an ID Card Using ControlCenter4 Advanced Mode (Windows®)

Select **Advanced Mode** as the mode setting for ControlCenter4.

1. Place an ID card on the scanner glass.
2. Click the  (ControlCenter4) icon in the task tray, and then click **Open**.
3. Click the **Scan** tab.

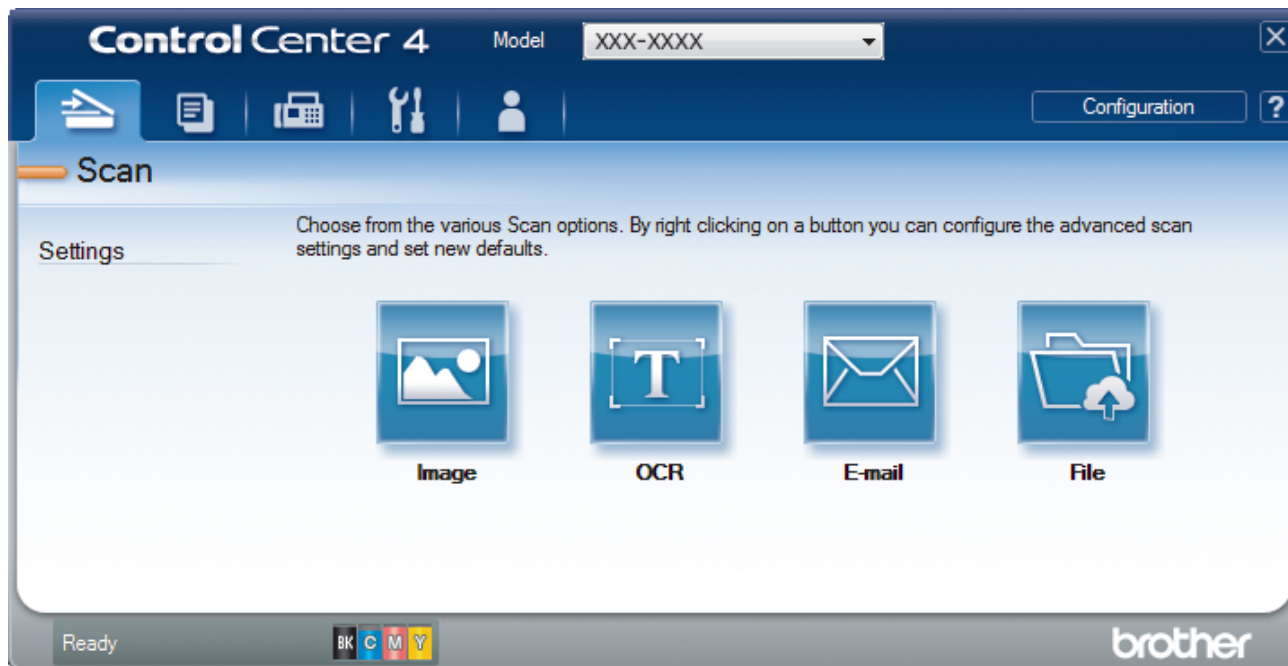

4. Click the **File** button.

The scan settings dialog box appears.

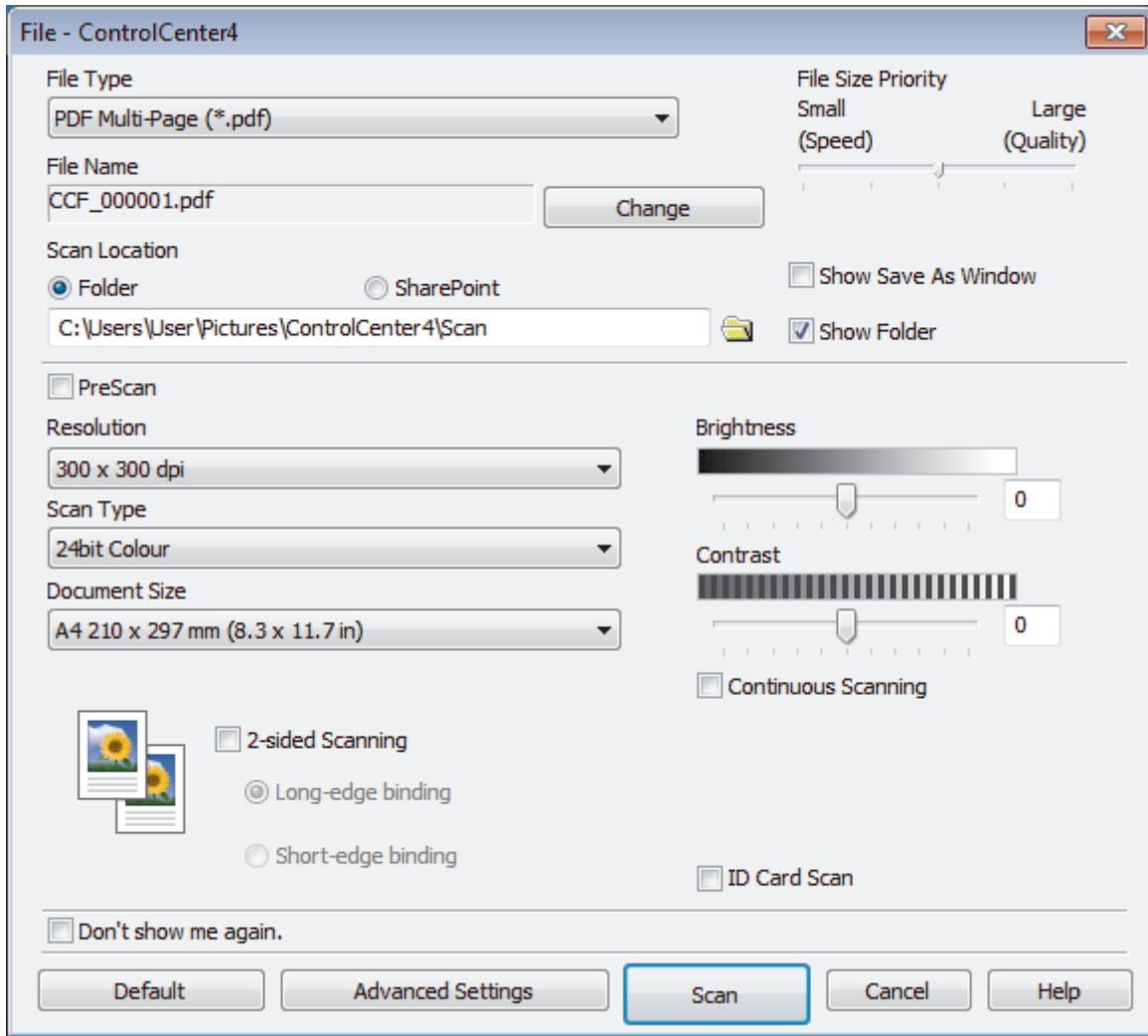

5. Select the **ID Card Scan** check box.

The instruction dialog box appears.

6. Read the instructions on the screen, and then click **OK**.
7. Change the scan settings, such as file format, file name, scan location, resolution and color, if needed.
8. Click **Scan**.

The machine starts scanning one side of the identification card.

9. After the machine has scanned one side, turn over the identification card, and then click **Continue** to scan the other side.
10. Click **Finish**.



Related Information

- [Scan Using ControlCenter4 Advanced Mode \(Windows®\)](#)

Scan to Email Attachment Using ControlCenter4 Advanced Mode (Windows®)

Send a scanned document as an email attachment.

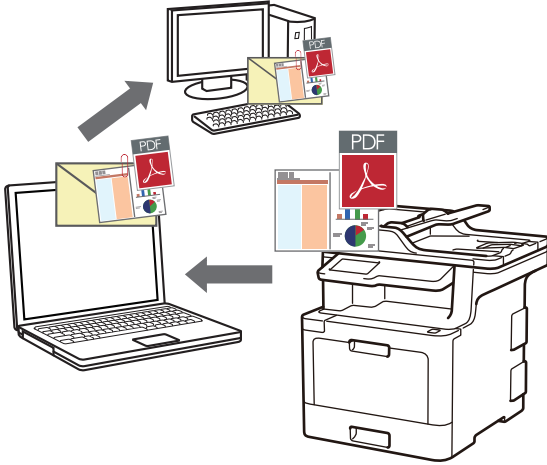

- Select **Advanced Mode** as the mode setting for ControlCenter4.
- The Scan to Email feature does not support Webmail services. Use the Scan to Image or Scan to File feature to scan a document or a picture, and then attach the scanned file to an email message.



The machine scans to your default email client.

1. Load your document.
2. Click the  (ControlCenter4) icon in the task tray, and then click **Open**.
3. Click the **Scan** tab.

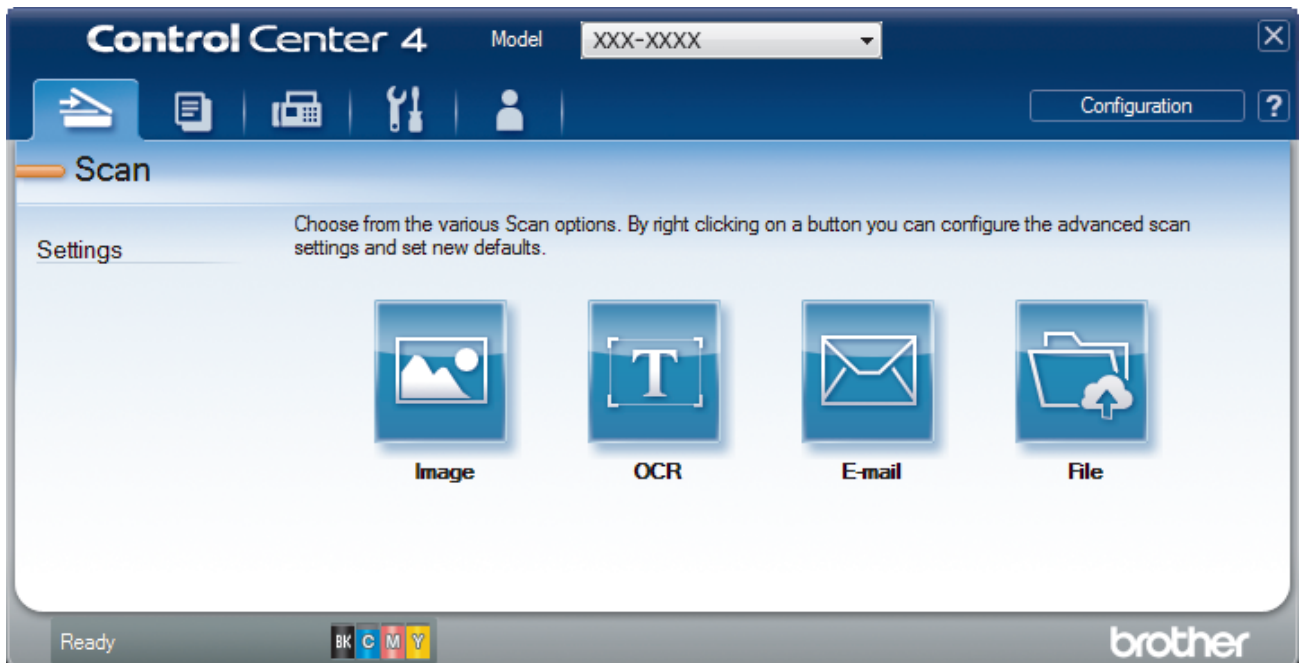

4. Click the **E-mail** button.
The scan settings dialog box appears.

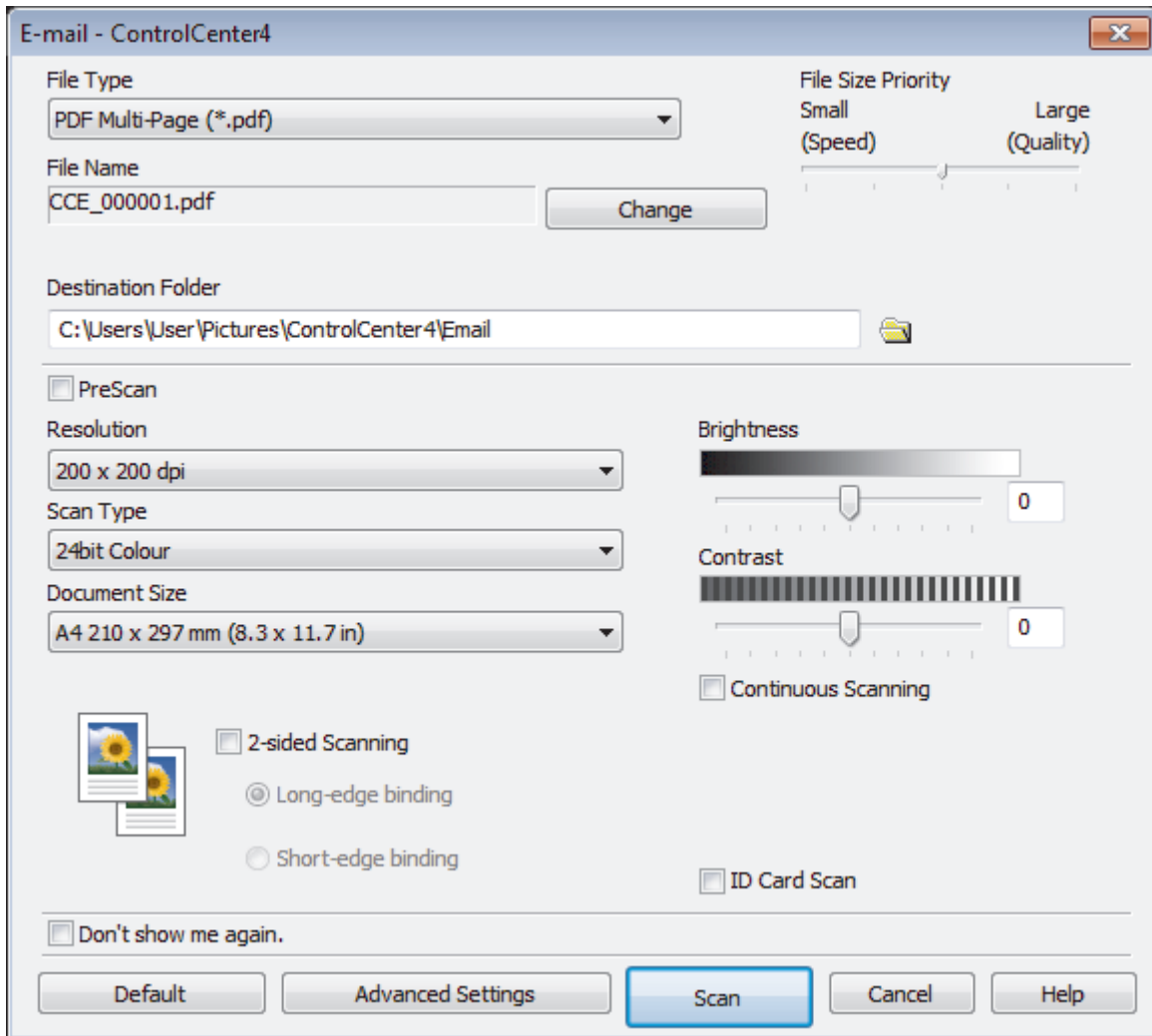

5. Change the scan settings, such as file format, file name, destination folder, resolution and color, if needed.



- To change the file name, click **Change**.
- To change **Destination Folder**, click the folder icon.
- To preview and configure the scanned image, select the **PreScan** check box.

6. Click **Scan**.

The machine starts scanning. Your default email application opens and the scanned image is attached to a new, blank email message.



Related Information

- [Scan Using ControlCenter4 Advanced Mode \(Windows®\)](#)

Scan to an Editable Text File (OCR) Using ControlCenter4 Advanced Mode (Windows®)

Your machine can convert characters in a scanned document to text using optical character recognition (OCR) technology. You can edit this text using your preferred text-editing application.

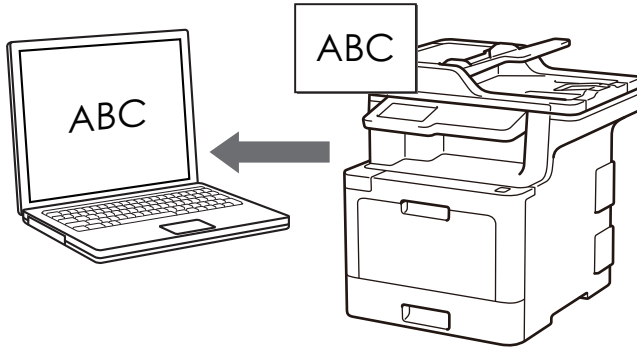

- Select **Advanced Mode** as the mode setting for ControlCenter4.

1. Load your document.
2. Click the  (ControlCenter4) icon in the task tray, and then click **Open**.
3. Click the **Scan** tab.

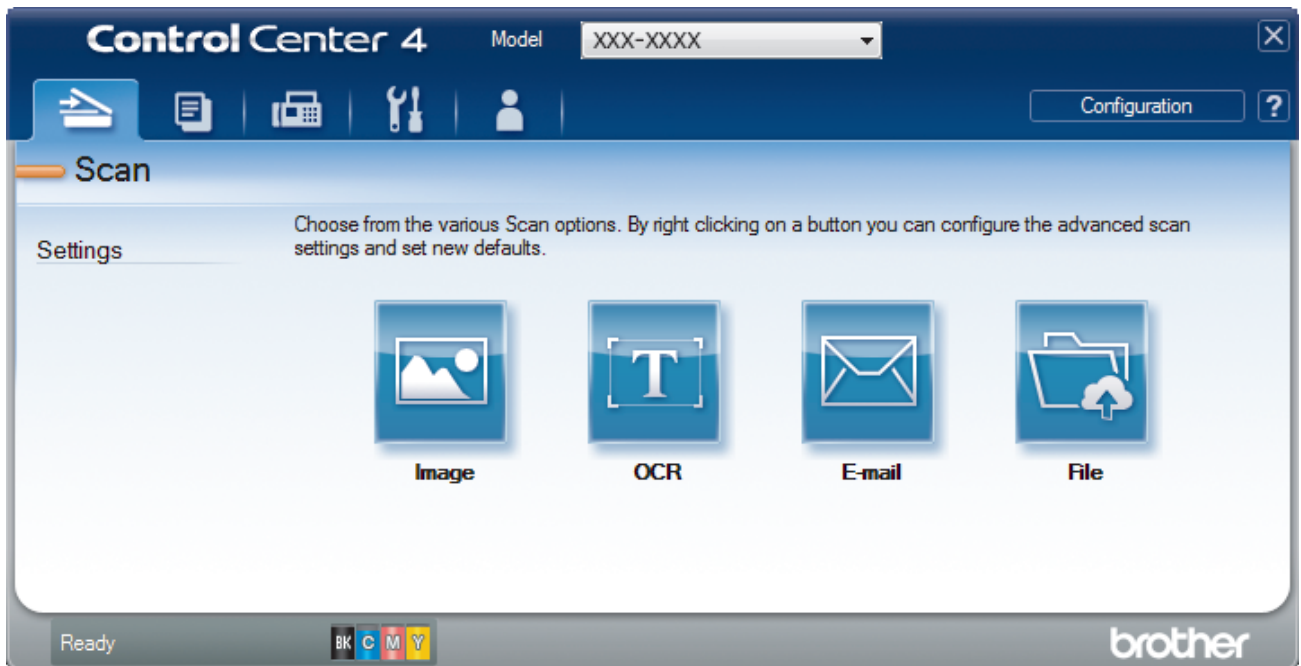

4. Click the **OCR** button.
The scan settings dialog box appears.

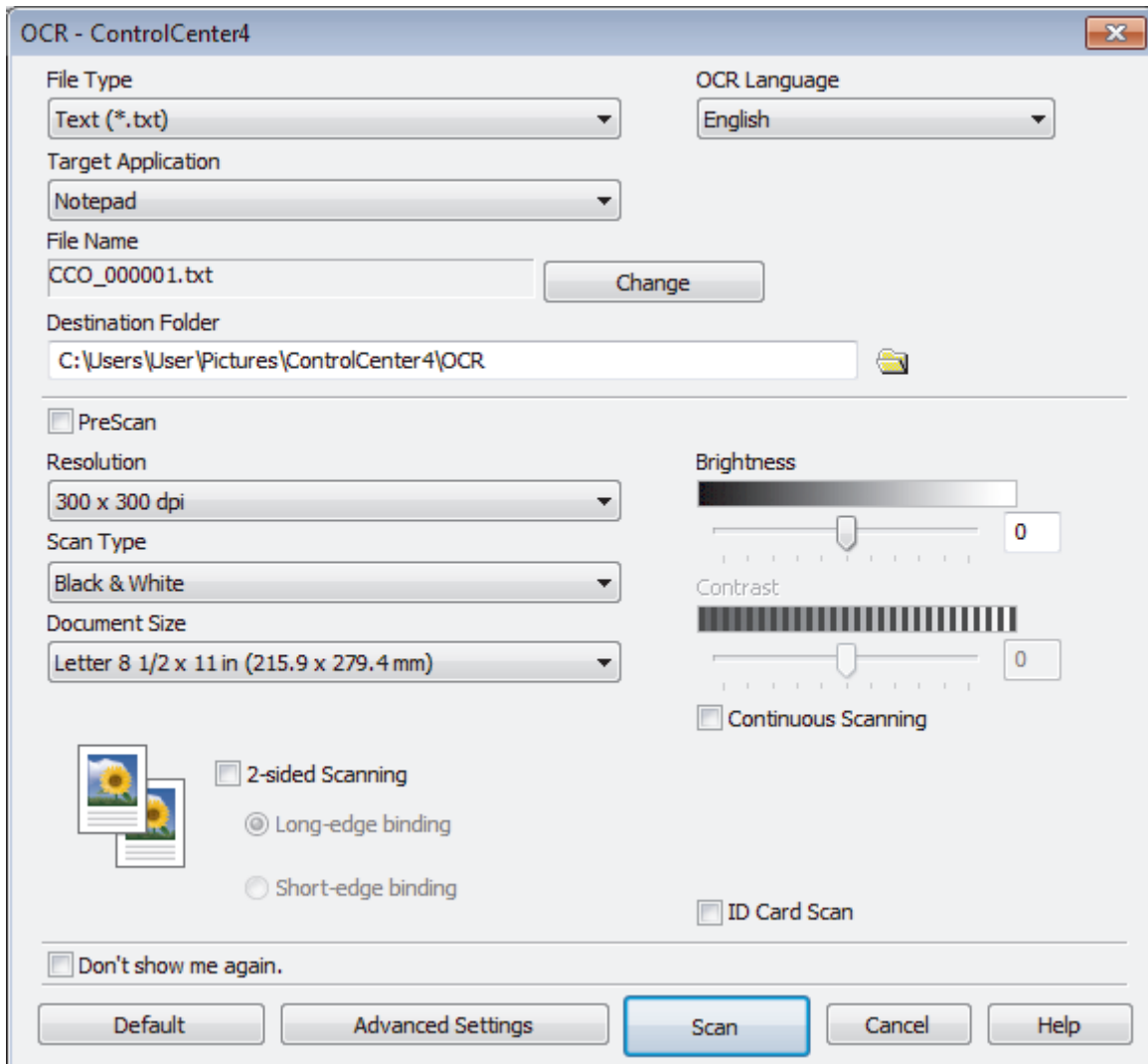

5. Change the scan settings, such as file format, file name, destination folder, resolution and color, if needed.



- To change the file name, click **Change**.
- To change **Destination Folder**, click the folder icon.
- To preview and configure the scanned image, select the **PreScan** check box.

6. Click **Scan**.

The machine scans the document, converts it to editable text, and then sends it to your default word processing application.



Related Information

- [Scan Using ControlCenter4 Advanced Mode \(Windows®\)](#)

Scan Settings for ControlCenter4 Advanced Mode (Windows®)

Settings	Applicable Features			
	Image	OCR	E-mail	File
File Type	Yes	Yes	Yes	Yes
Target Application	Yes	Yes	-	-
OCR Language	-	Yes	-	-
File Name	Yes	Yes	Yes	Yes
Scan Location or Destination Folder	Yes	Yes	Yes	Yes
Show Folder	-	-	-	Yes
Show Save As Window	-	-	-	Yes
File Size Priority	Yes	-	Yes	Yes
PreScan	Yes	Yes	Yes	Yes
Resolution	Yes	Yes	Yes	Yes
Scan Type	Yes	Yes	Yes	Yes
Document Size	Yes	Yes	Yes	Yes
Brightness	Yes	Yes	Yes	Yes
Contrast	Yes	Yes	Yes	Yes
Continuous Scanning	Yes	Yes	Yes	Yes
2-sided Scanning	Yes	Yes	Yes	Yes
ID Card Scan	Yes	Yes	Yes	Yes
Advanced Settings	Yes	Yes	Yes	Yes
Default	Yes	Yes	Yes	Yes

File Type

Select the file type you want to use for the scanned data.

For Image, Email and File

- **Windows Bitmap (*.bmp)**
- **JPEG (*.jpg)** (recommended for most users when scanning pictures)
- **TIFF Single-Page (*.tif)**
- **TIFF Multi-Page (*.tif)**
- **Portable Network Graphics (*.png)**
- **PDF Single-Page (*.pdf)** (recommended for scanning and sharing documents)
- **PDF Multi-Page (*.pdf)** (recommended for scanning and sharing documents)
- **PDF/A Single-Page (*.pdf)** (recommended for scanning and sharing documents)
- **PDF/A Multi-Page (*.pdf)** (recommended for scanning and sharing documents)
- **High Compression PDF Single-Page (*.pdf)**
- **High Compression PDF Multi-Page (*.pdf)**
- **Secure PDF Single-Page (*.pdf)**
- **Secure PDF Multi-Page (*.pdf)**
- **Searchable PDF Single-Page (*.pdf)**
- **Searchable PDF Multi-Page (*.pdf)**

-
- **XML Paper Specification (*.xps)** (the XML Paper Specification is available for Windows® 7, Windows® 8 and Windows® 10, and when using applications that support XML Paper Specification files)

For Email and File

- **Microsoft Office Word (*.docx)** (Available only for certain models)
- **Microsoft Office PowerPoint (*.pptx)** (Available only for certain models)
- **Microsoft Office Excel (*.xlsx)**(Available only for certain models)

For OCR

- **HTML 3.2 (*.htm)**
- **HTML 4.0 (*.htm)**
- **Microsoft Excel 2003, XP (*.xls)**
- **RTF Word 2000 (*.rtf)**
- **WordPad (*.rtf)**
- **WordPerfect 9, 10 (*.wpd)**
- **Text (*.txt)**
- **Searchable PDF Single-Page (*.pdf)**
- **Searchable PDF Multi-Page (*.pdf)**

Target Application

Select the destination application from the drop-down list.

OCR Language

Set the OCR language to match the language of the scanned document's text.

File Name

Click **Change** to change the file name's prefix.

Scan Location

Select the **Folder** or **SharePoint** radio button to specify the destination where you want to save your scanned documents.

Destination Folder

Click the folder icon to browse and select the folder where you want to save your scanned documents.

Show Folder

Select this option to automatically display the destination folder after scanning.

Show Save As Window

Select this option to specify the scanned image's destination every time you scan.

File Size Priority

Adjust the data compression ratio of the scanned image. Change the file size by moving the **File Size Priority** slider to the right or left.

PreScan

Select **PreScan** to preview your image and crop unwanted portions before scanning.

Resolution

Select a scanning resolution from the **Resolution** drop-down list. Higher resolutions take more memory and transfer time, but produce a finer scanned image.

Scan Type

Select from a range of scan color depths.

- **Auto**

Use for any type of document. This mode automatically picks an appropriate color depth for the document.

-
- **Black & White**
Use for text or line art images.
 - **Gray (Error Diffusion)**
Use for photographic images or graphics. (Error Diffusion is a method for creating simulated gray images without using true gray dots. Black dots are put in a specific pattern to give a gray appearance.)
 - **True Gray**
Use for photographic images or graphics. This mode is more accurate because it uses up to 256 shades of gray.
 - **24bit Color**
Use to create an image with the most accurate color reproduction. This mode uses up to 16.8 million colors to scan the image, but it requires the most memory and has the longest transfer time.

Document Size

Select the exact size of your document from the **Document Size** drop-down list.

- If you select the **1 to 2 (A4)** option, the scanned image will be divided into two A5-size documents.

Brightness

Set the **Brightness** level by dragging the slider to the right or left to lighten or darken the image. If the scanned image is too light, set a lower brightness level and scan the document again. If the image is too dark, set a higher brightness level and scan the document again. You can also type a value into the field to set the **Brightness** level.

Contrast

Increase or decrease the **Contrast** level by moving the slider to the right or left. An increase emphasizes dark and light areas of the image, while a decrease reveals more details in gray areas. You can also type a value into the field to set the **Contrast** level.

Continuous Scanning

Select this option to scan multiple pages. After a page is scanned, select either continue scanning or finish.

2-sided Scanning

Select this check box to scan both sides of the document. When using the Automatic 2-sided Scan feature, you must select the **Long-edge binding** or **Short-edge binding** option, depending on the layout of your original, to make sure the data file you create appears correctly.

(MFC-L8900CDW)

ID Card Scan

Select this check box to scan both sides of an identification card onto one page.

Advanced Settings

Configure advanced settings by clicking the **Advanced Settings** button in the Scan Settings dialog box.

- **Remove Bleed-through / Pattern**
 - **Remove Background Color**
Remove the base color of documents to make the scanned data more legible.
- **Rotate Image**
Rotate the scanned image.
- **Skip Blank Page**
Remove the document's blank pages from the scanning results.
- **Display Scanning Results**
Show the numbers of total pages saved and blank pages skipped on your computer screen.
- **ADF Auto Deskew**
When scanning the document from the ADF, the machine corrects skewing of the document automatically.

Default

Select this option to restore all settings to their factory setting values.

**Related Information**

- [Scan Using ControlCenter4 Advanced Mode \(Windows®\)](#)
-



Scan Using Nuance™ PaperPort™ 14SE or Other Windows® Applications

You can use the Nuance™ PaperPort™ 14SE application for scanning.

- To download the Nuance™ PaperPort™ 14SE application, click  (**Brother Utilities**), select **Do More** in the left navigation bar, and then click **PaperPort**.
- Nuance™ PaperPort™ 14SE supports Windows® 7, Windows® 8, Windows® 8.1 and Windows® 10.
- For detailed instructions on using each application, click the application's **Help** menu, and then click **Getting Started Guide** in the **Help** ribbon.



The instructions for scanning in these steps are for PaperPort™ 14SE. For other Windows® applications, the steps will be similar. PaperPort™ 14SE supports both TWAIN and WIA drivers; the TWAIN driver (recommended) is used in these steps.

1. Load your document.
2. Start PaperPort™ 14SE.
Do one of the following:
 - Windows® 7
Using your computer, click  (**Start**) > **All Programs** > **Nuance PaperPort 14** > **PaperPort**.
 - Windows® 8
Click  (**PaperPort**).
 - Windows® 10
Click  **Nuance PaperPort 14** > **PaperPort**.
3. Click the **Desktop** menu, and then click **Scan Settings** in the **Desktop** ribbon.
The **Scan or Get Photo** panel appears on the left side of the screen.
4. From the available Scanners list, select **TWAIN: TW-Brother XXX-XXXX** or **TWAIN: TW-Brother XXX-XXXX LAN** (where MFC-XXXX is the model name of your machine). To use the WIA driver, select the Brother driver that has "WIA" as the prefix.
5. Select the **Display scanner dialog box** check box in the **Scan or Get Photo** panel.
6. Click **Scan**.
The Scanner Setup dialog box appears.

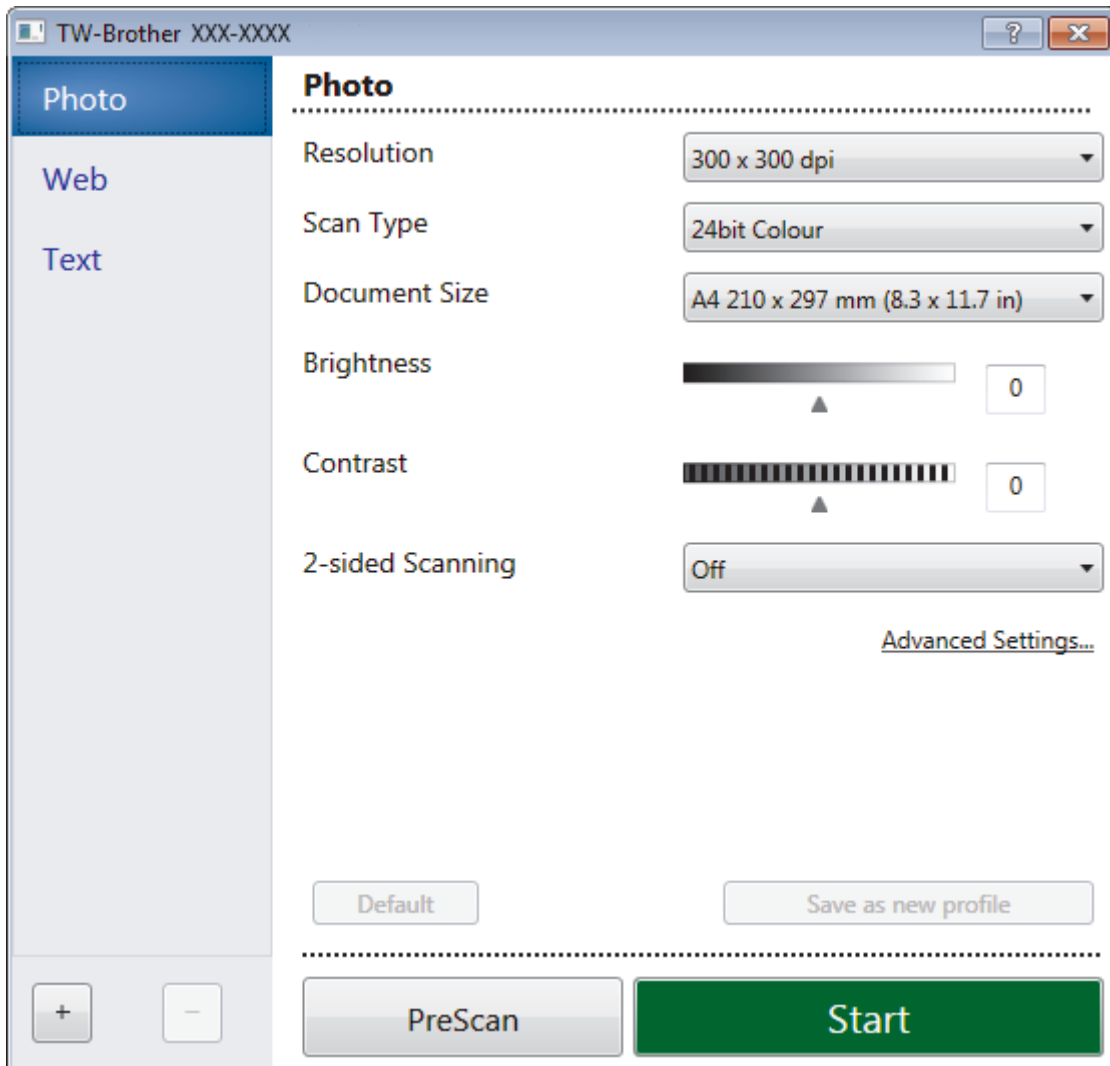

7. Adjust the settings in the Scanner Setup dialog box, if needed.
8. Click the **Document Size** drop-down list, and then select your document size.



To scan both sides of the document (MFC-L8900CDW):
Automatic 2-sided scan is available only when using the ADF.
You cannot use PreScan to preview an image.

9. Click **PreScan** if you want to preview your image and crop unwanted portions before scanning.
10. Click **Start**.
The machine starts scanning.



Related Information

- [Scan from Your Computer \(Windows®\)](#)
- [TWAIN Driver Settings \(Windows®\)](#)

TWAIN Driver Settings (Windows®)

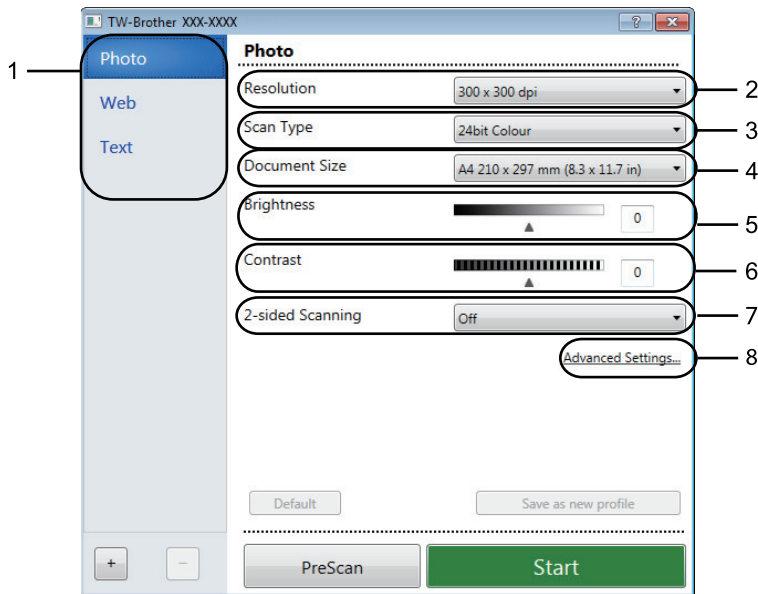

- Note that the item names and assignable values will vary depending on the machine.
- The **Contrast** option is available only when selecting the **Gray (Error Diffusion)**, **True Gray**, or **24bit Color** options from the **Scan Type** settings.

1. Scan

Select the **Photo**, **Web**, or **Text** option depending on the type of document you want to scan.

Scan (Image Type)		Resolution	Scan Type
Photo	Use for scanning photo images.	300 x 300 dpi	24bit Color
Web	Use for attaching the scanned image to web pages.	100 x 100 dpi	24bit Color
Text	Use for scanning text documents.	200 x 200 dpi	Black & White

2. Resolution

Select a scanning resolution from the **Resolution** drop-down list. Higher resolutions take more memory and transfer time, but produce a finer scanned image.

3. Scan Type

Select from a range of scan color depths.

- **Black & White**
Use for text or line art images.
- **Gray (Error Diffusion)**
Use for photographic images or graphics. (Error Diffusion is a method for creating simulated gray images without using true gray dots. Black dots are put in a specific pattern to give a gray appearance.)
- **True Gray**
Use for photographic images or graphics. This mode is more accurate because it uses up to 256 shades of gray.
- **24bit Color**
Use to create an image with the most accurate color reproduction. This mode uses up to 16.8 million colors to scan the image, but it requires the most memory and has the longest transfer time.

4. Document Size

Select the exact size of your document from a selection of preset scan sizes.

If you select **Custom**, the **Custom Document Size** dialog box appears and you can specify the document size.

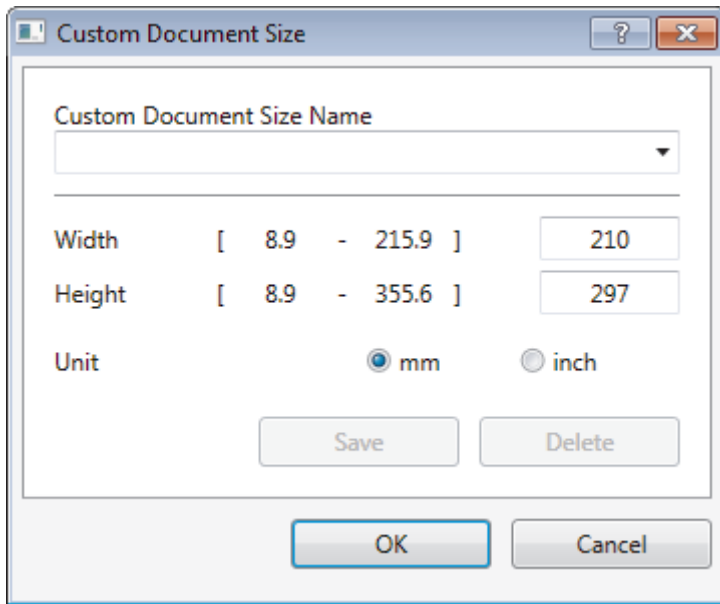

5. Brightness

Set the **Brightness** level by dragging the slider to the right or left to lighten or darken the image. If the scanned image is too light, set a lower brightness level and scan the document again. If the image is too dark, set a higher brightness level and scan the document again. You can also type a value in the field to set the brightness level.

6. Contrast

Increase or decrease the **Contrast** level by moving the slider to the right or left. An increase emphasizes dark and light areas of the image, while a decrease reveals more details in gray areas. You can also type a value in the field to set the contrast level.

7. 2-sided Scanning

Scan both sides of the document. When using the Automatic 2-sided Scan feature, you must select the **Long-edge binding** or **Short-edge binding** option from the **2-sided Scanning** drop-down list, so when you turn the pages, they are facing the way you want.

(MFC-L8900CDW)

8. Advanced Settings

Configure advanced settings by clicking the **Advanced Settings** button in the Scan Settings dialog box.

- **Paper Detection**

- **Auto Deskew**

Set the machine to correct document skewing automatically as the pages are scanned from the ADF.

- **Rotate Image**

Rotate the scanned image.

- **Image Quality**

- **Background Processing**

- **Remove Bleed-through / Pattern**

Prevent bleed-through.

- **Remove Background Color**

Remove the base color of documents to make the scanned data more legible.

- **Color Drop**

Select a color to remove from the scanned image.

- **Boldface Formatting**

Emphasize the characters of the original by making them bold.

- **Blurred Character Correction**

Correct the broken or incomplete characters of the original to make them easier to read.

- **Edge Emphasis**

Make the characters of the original sharper.

- **Reduce Noise**

Improve and enhance the quality of your scanned images with this selection. The **Reduce Noise** option is available when selecting the **24bit Color** option and the **300 x 300 dpi**, **400 x 400 dpi**, or **600 x 600 dpi** scan resolution.

- **Page Control**

- **Edge Fill**

Fill in the edges on four sides of the scanned image using the selected color and range.

- **Skip Blank Page**

Remove the document's blank pages from the scanning results.

- **Continuous Scan**

Select this option to scan multiple pages. After a page is scanned, select either continue scanning or finish.



Related Information

- [Scan Using Nuance™ PaperPort™ 14SE or Other Windows® Applications](#)

Scan Using Windows® Photo Gallery or Windows® Fax and Scan

Windows® Photo Gallery or Windows® Fax and Scan applications are other options that you can use for scanning.

- These applications use the WIA scanner driver.
- If you want to crop a portion of a page after pre-scanning the document, you must scan using the scanner glass (also called the flatbed).

1. Load your document.
2. Launch your scanning application. Do one of the following:
 - (Windows® Photo Gallery)
Click **File > Import from Camera or Scanner**.
 - (Windows® Fax and Scan)
Click **File > New > Scan**.
3. Select the scanner you want to use.
4. Click **Import** or **OK**.

The **New Scan** dialog box appears.

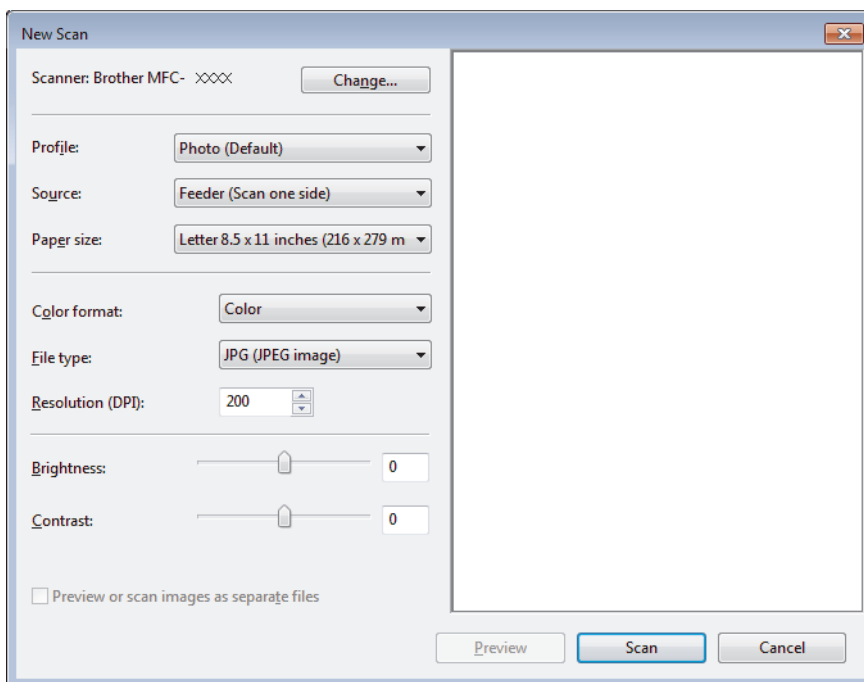

5. Adjust the settings in the Scanner Setup dialog box, if needed.

The scanner resolution can be set to a maximum of 1200 dpi. If you want to scan at higher resolutions, use the **Scanner Utility** software of **Brother Utilities**.

If your machine supports 2-sided Scan and you want to scan both sides of your document, select **Feeder (Scan both sides)** as **Source**.
6. Click **Scan**.

The machine starts scanning the document.

✓ Related Information

- [Scan from Your Computer \(Windows®\)](#)
- [WIA Driver Settings \(Windows®\)](#)

WIA Driver Settings (Windows®)

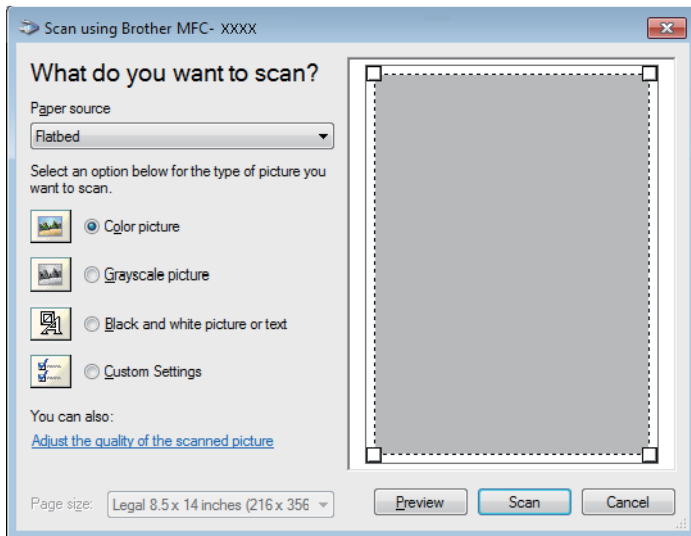

Paper source

Select the **Document Feeder** or **Flatbed** option from the drop-down list.

Picture Type (Image Type)

Select **Color picture**, **Grayscale picture**, **Black and white picture or text**, or **Custom Settings** for the type of document you want to scan.

To change advanced settings, click the **Adjust the quality of the scanned picture** link.

Page size

The **Page size** option is available if you select the **Document Feeder** as the **Paper source** option.

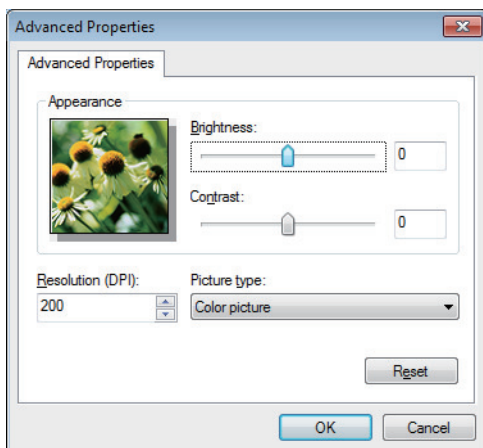

Brightness

Set the **Brightness** level by dragging the slider to the right or left to lighten or darken the image. If the scanned image is too light, set a lower brightness level and scan the document again. If the image is too dark, set a higher brightness level and scan the document again.

Contrast

Increase or decrease the **Contrast** level by moving the slider to the right or left. An increase emphasizes dark and light areas of the image, while a decrease reveals more details in gray areas. You can also type a value in the field to set the contrast level.

Resolution (DPI)

Select a scanning resolution from the **Resolution (DPI)** list. Higher resolutions take more memory and transfer time, but produce a finer scanned image.



Related Information

- Scan Using Windows® Photo Gallery or Windows® Fax and Scan

Scan from Your Computer (Macintosh)

There are several ways you can use your Macintosh to scan photos and documents on your Brother machine. Use the software applications provided by Brother or your favorite scanning application.

- [Scan Using ControlCenter2 \(Macintosh\)](#)
- [Scan Using TWAIN-Compliant Applications \(Macintosh\)](#)
- [TWAIN Driver Settings \(Macintosh\)](#)

Scan Using ControlCenter2 (Macintosh)

Use Brother's ControlCenter software to scan photos and save them as JPEGs, PDFs, or other file formats.

- [Scan Using ControlCenter2 \(Macintosh\)](#)
- [Save Scanned Data to a Folder as a PDF File Using ControlCenter2 \(Macintosh\)](#)
- [Scan Both Sides of a Document Automatically Using ControlCenter2 \(Macintosh\)](#)
- [Scan Both Sides of an ID Card Using ControlCenter2 \(Macintosh\)](#)
- [Scan to Email Attachment Using ControlCenter2 \(Macintosh\)](#)
- [Scan to an Editable Text File \(OCR\) Using ControlCenter2 \(Macintosh\)](#)
- [Scan Settings for ControlCenter2 \(Macintosh\)](#)

Scan Using ControlCenter2 (Macintosh)

Send scanned photos or graphics directly to your computer.

1. Load your document.
2. In the **Finder** menu bar, click **Go > Applications > Brother**, and then double-click the  (**ControlCenter**) icon.
The **ControlCenter2** screen appears.
3. Click the **SCAN** tab.

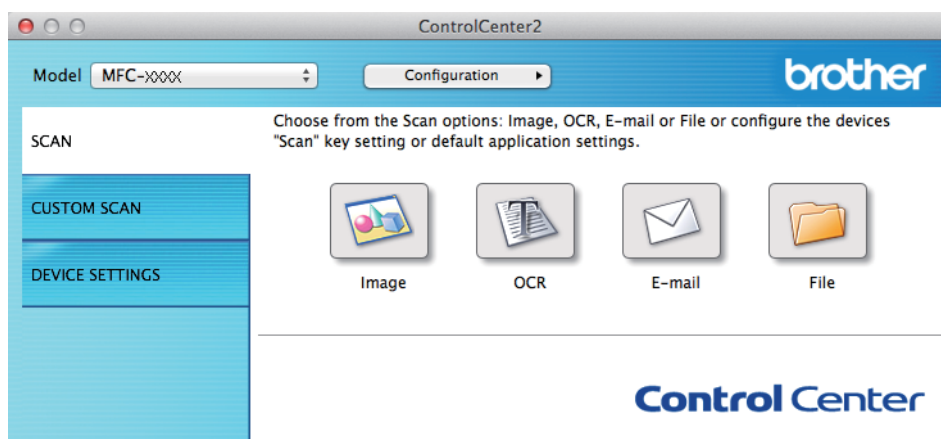

4. Click the **Image** button.
The scan settings dialog box appears.

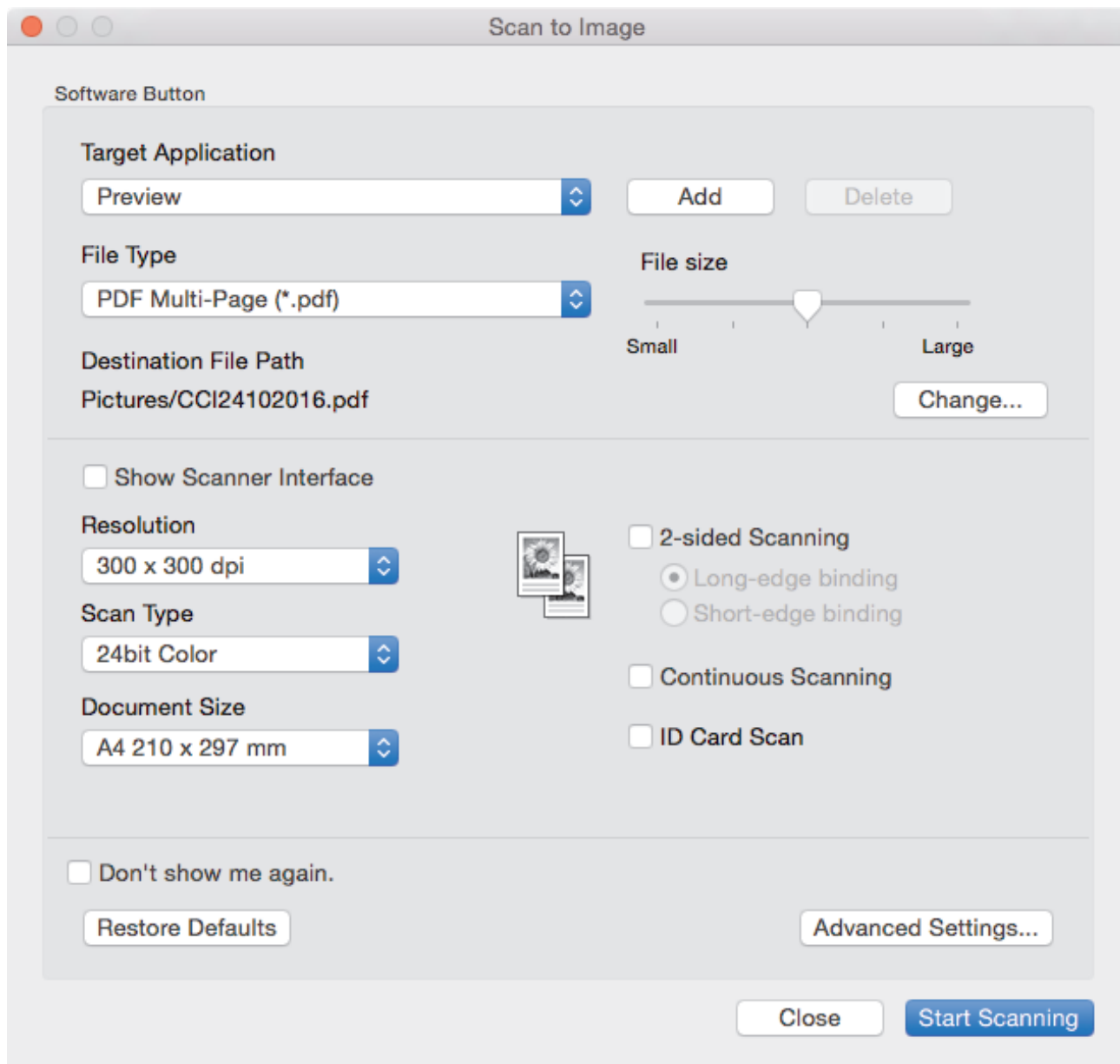

5. Change the scan settings, such as file format, file name, destination file path, resolution and color, if needed.



To change the file name or destination file path, click **Change**.

6. Click the **Start Scanning** button.
The machine starts scanning. The scanned image opens in the application you have selected.



Related Information

- [Scan Using ControlCenter2 \(Macintosh\)](#)

Save Scanned Data to a Folder as a PDF File Using ControlCenter2 (Macintosh)

1. Load your document.
2. In the **Finder** menu bar, click **Go > Applications > Brother**, and then double-click the  (**ControlCenter**) icon.
The **ControlCenter2** screen appears.
3. Click the **SCAN** tab.

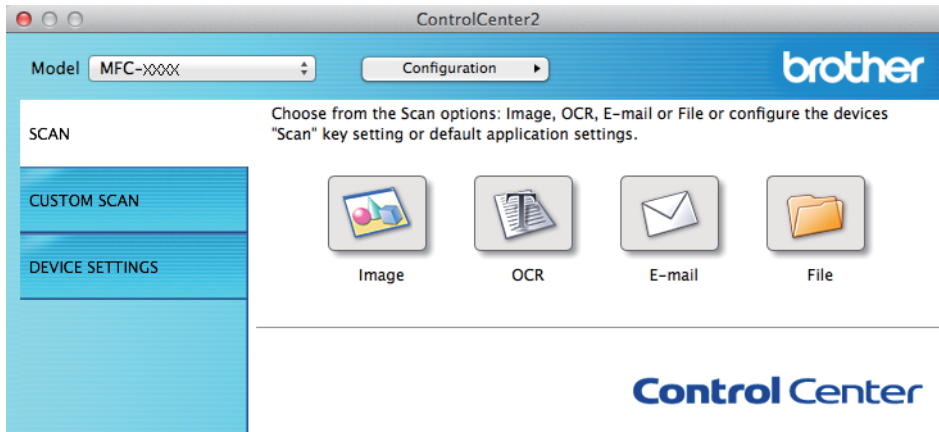

4. Click the **File** button.
The scan settings dialog box appears.

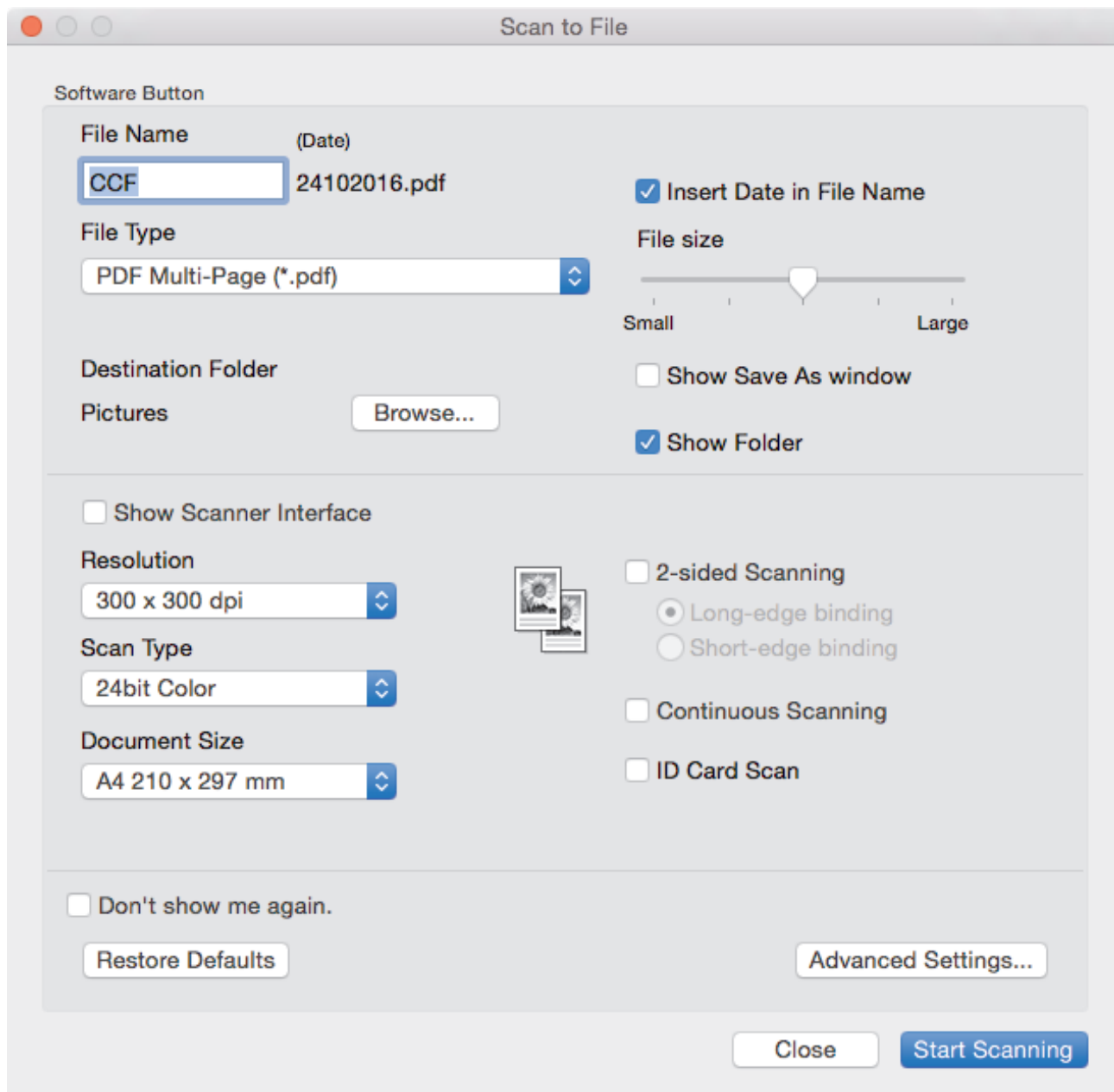

5. Click the **File Type** pop-up menu, and then select a PDF file.



To save the document as a password-protected PDF, select **Secure PDF (*.pdf)** from the **File Type** pop-up menu, type your password in the **Password** and **Re-type Password** fields, and then click **OK**.

6. Change the scan settings, such as file name, destination folder, resolution and color, if needed.
7. Click the **Start Scanning** button.

The machine starts scanning. The file will be saved in the folder you selected.



Related Information

- [Scan Using ControlCenter2 \(Macintosh\)](#)

Scan Both Sides of a Document Automatically Using ControlCenter2 (Macintosh)

Related Models: MFC-L8900CDW

1. Load documents in the ADF.



To scan both sides of a document automatically, you must use the ADF, not the flatbed scanner glass.

2. In the **Finder** menu bar, click **Go > Applications > Brother**, and then double-click the  (**ControlCenter**) icon.

The **ControlCenter2** screen appears.

3. Click the **SCAN** tab.

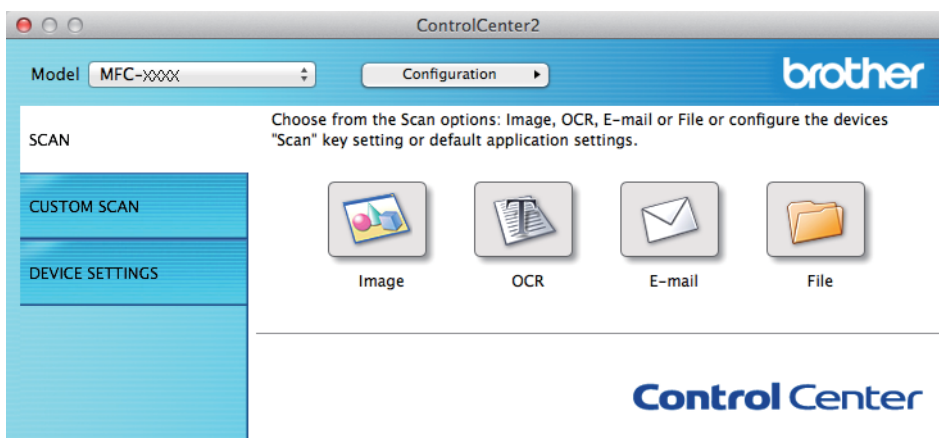

4. Click the scan type button (**Image**, **OCR**, **E-mail**, or **File**) you want to use.
The scan settings dialog box appears.
5. Select the **2-sided Scanning** check box.
6. Select the **Long-edge binding** or **Short-edge binding** option, depending on the Original layout.
7. Configure other settings, if needed.
8. Click the **Start Scanning** button.
The machine starts scanning.

You have now changed the default settings for your selected Scan to action. These settings will be used the next time this scan type (**Image**, **OCR**, **E-mail**, or **File**) is clicked for this action.



Related Information

- [Scan Using ControlCenter2 \(Macintosh\)](#)

Scan Both Sides of an ID Card Using ControlCenter2 (Macintosh)

1. Place an ID card on the scanner glass.
2. In the **Finder** menu bar, click **Go > Applications > Brother**, and then double-click the  (**ControlCenter**) icon.

The **ControlCenter2** screen appears.

3. Click the **SCAN** tab.

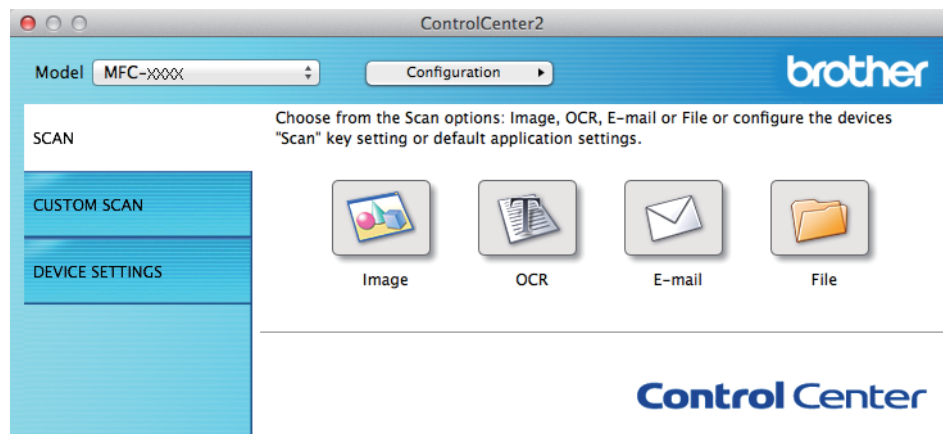

4. Click the **File** button.

The scan settings dialog box appears.

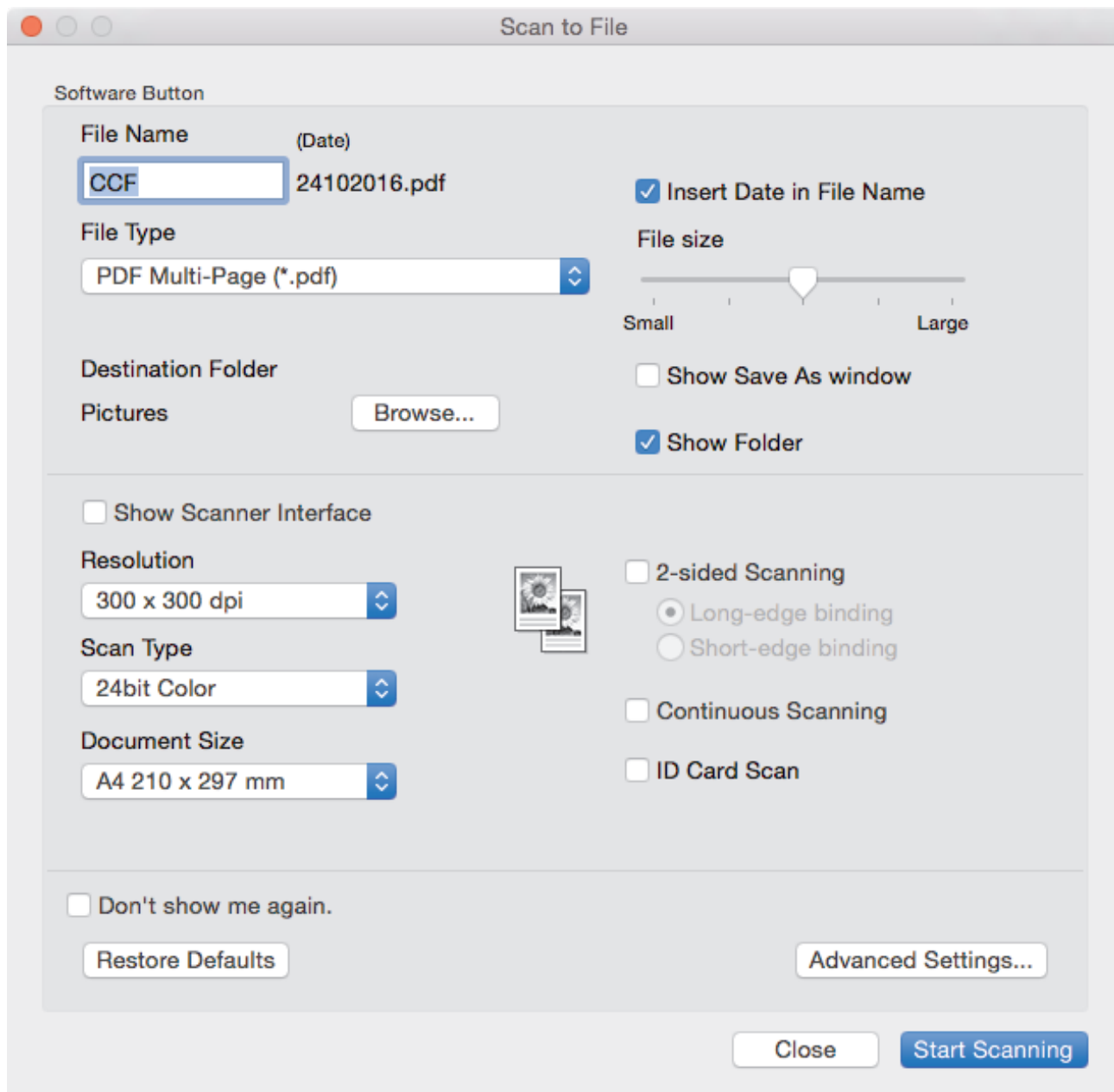

5. Select the **ID Card Scan** check box.
The instruction dialog box appears.
6. Read the instructions on the screen, and then click **OK**.
7. Configure other settings, if needed.
8. Click the **Start Scanning** button.
The machine starts scanning one side of the identification card.
9. After the machine has scanned one side, turn over the identification card, and then click **Continue** to scan the other side.
10. Click **Finish**.

Related Information

- [Scan Using ControlCenter2 \(Macintosh\)](#)

Scan to Email Attachment Using ControlCenter2 (Macintosh)

Send a scanned document as an email attachment.

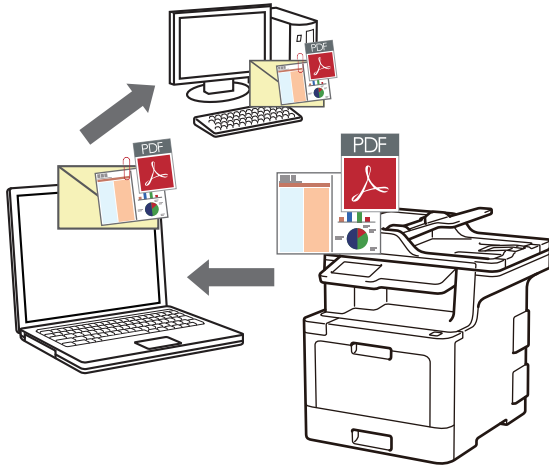

The Scan to Email feature does not support Webmail services. Use the Scan to Image or Scan to File feature to scan a document or a picture, and then attach the scanned file to an email message.

1. Load your document.
2. In the **Finder** menu bar, click **Go > Applications > Brother**, and then double-click the  (**ControlCenter**) icon.
The **ControlCenter2** screen appears.
3. Click the **SCAN** tab.

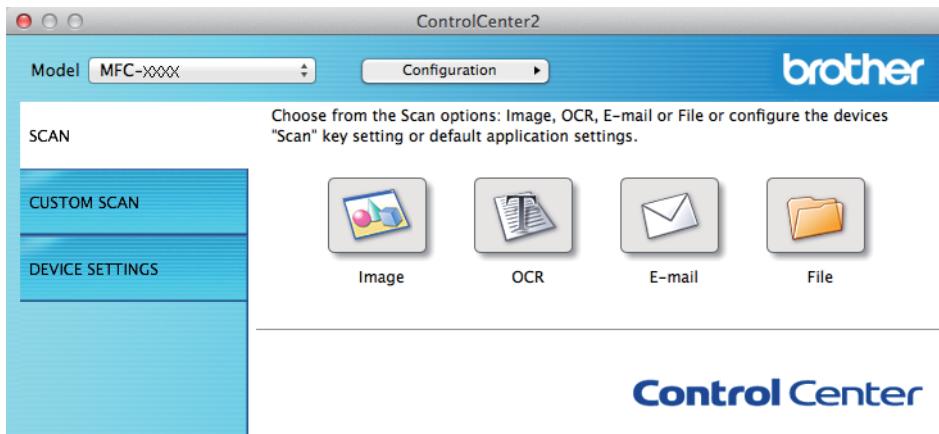

4. Click the **E-mail** button.
The scan settings dialog box appears.

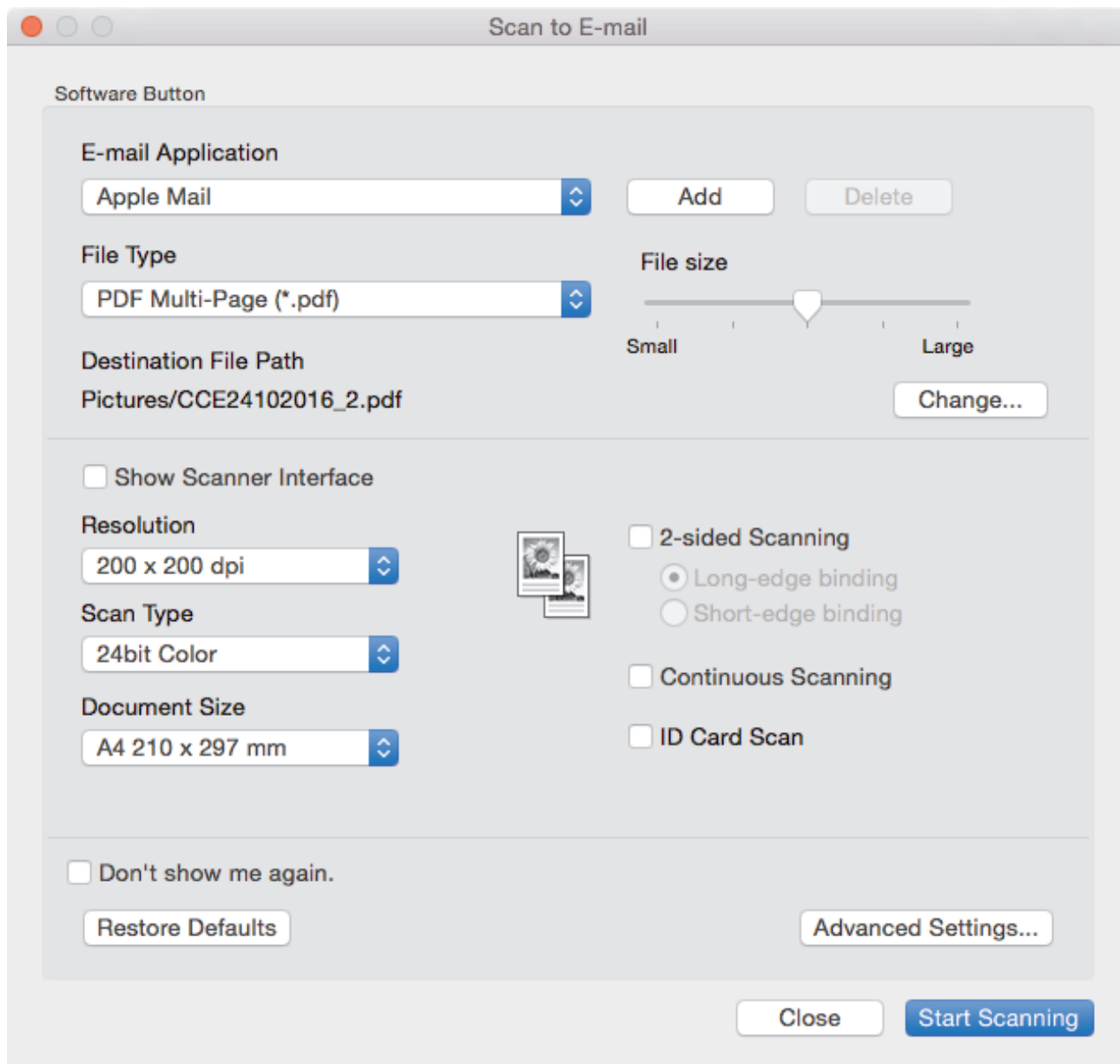

5. Change the scan settings, such as file format, file name, destination file path, resolution and color, if needed.



To change the file name or destination file path, click **Change**.

6. Click the **Start Scanning** button.

The machine starts scanning. Your default email application opens and the scanned image is attached to a new, blank email.



Related Information

- [Scan Using ControlCenter2 \(Macintosh\)](#)

Scan to an Editable Text File (OCR) Using ControlCenter2 (Macintosh)

Your machine can convert characters in a scanned document to text using optical character recognition (OCR) technology. You can edit this text using your preferred text-editing application.

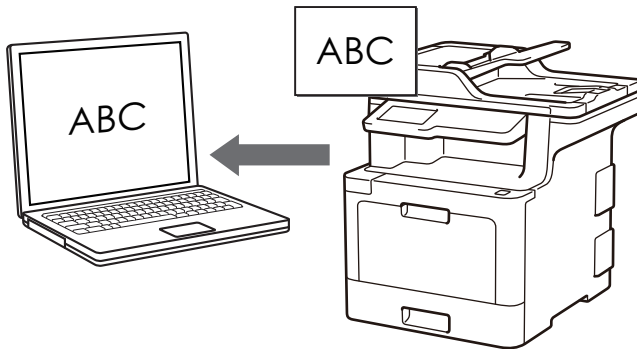

The Scan to OCR feature is available for certain languages.

1. Load your document.
2. In the **Finder** menu bar, click **Go > Applications > Brother**, and then double-click the  (**ControlCenter**) icon.
The **ControlCenter2** screen appears.
3. Click the **SCAN** tab.

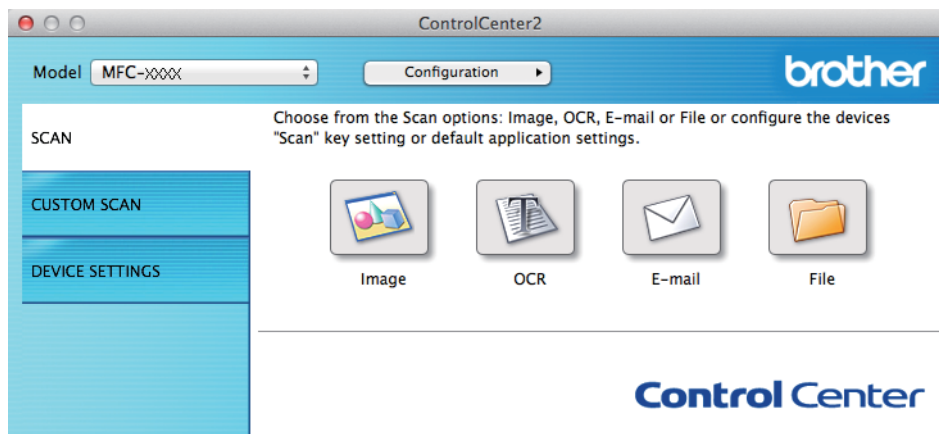

4. Click the **OCR** button.
The scan settings dialog box appears.

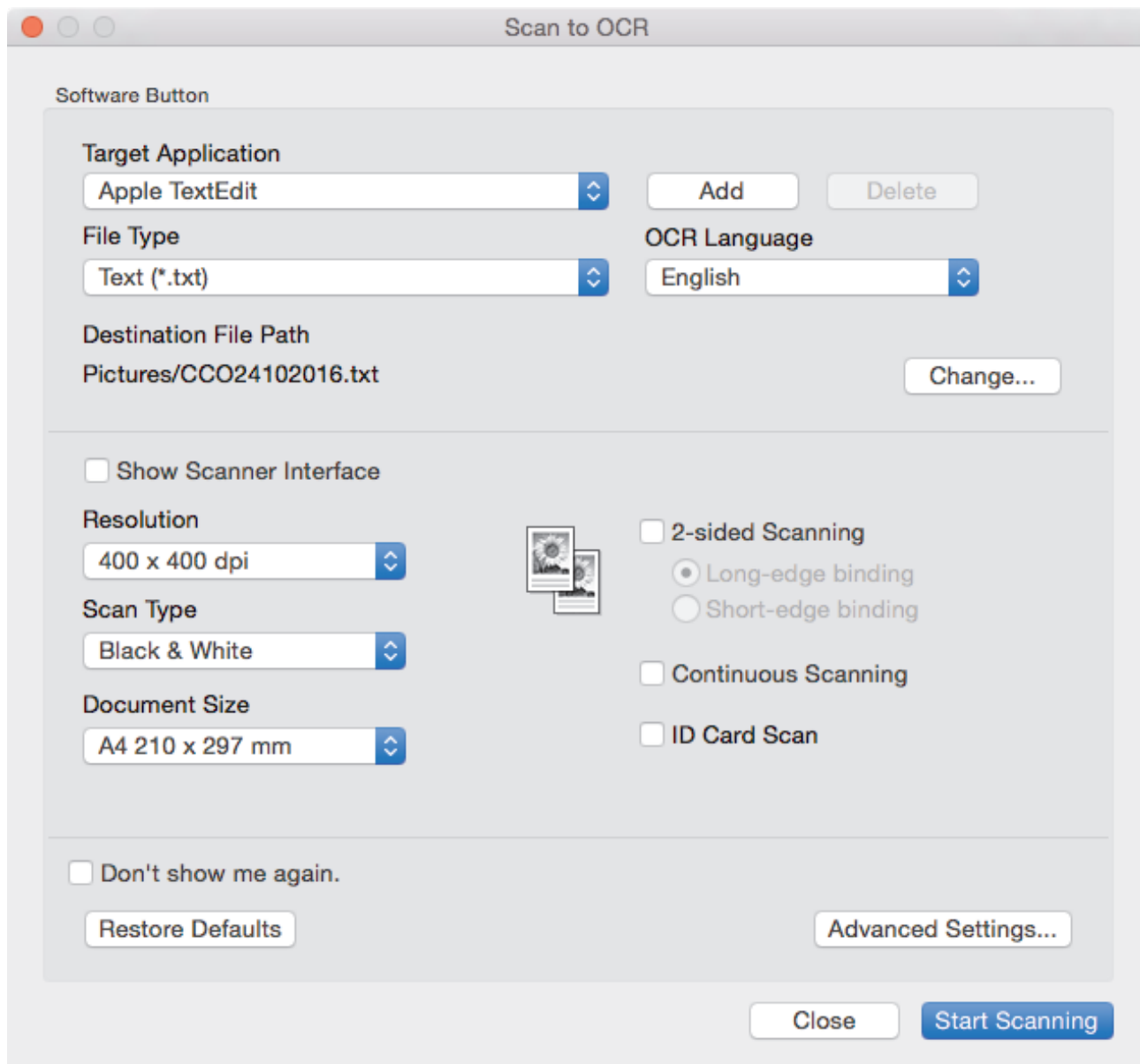

5. Change the scan settings, such as file format, file name, destination file path, resolution and color, if needed.



To change the file name or destination file path, click **Change**.

6. Click the **Start Scanning** button.

The machine scans the document, converts it to editable text, and then sends it to your default word processing application.



Related Information

- [Scan Using ControlCenter2 \(Macintosh\)](#)

Scan Settings for ControlCenter2 (Macintosh)

Settings	Applicable Features			
	Image	OCR	E-mail	File
Target Application/E-mail Application	Yes	Yes	Yes	-
File Type	Yes	Yes	Yes	Yes
File size	Yes	-	Yes	Yes
OCR Language	-	Yes	-	-
Destination File Path	Yes	Yes	Yes	-
File Name	Yes	Yes	Yes	Yes
Insert Date in File Name	Yes	Yes	Yes	Yes
Show Save As window	-	-	-	Yes
Destination Folder	Yes	Yes	Yes	Yes
Show Folder	-	-	-	Yes
Resolution	Yes	Yes	Yes	Yes
Scan Type	Yes	Yes	Yes	Yes
Document Size	Yes	Yes	Yes	Yes
Continuous Scanning	Yes	Yes	Yes	Yes
2-sided Scanning	Yes	Yes	Yes	Yes
ID Card Scan	Yes	Yes	Yes	Yes
Show Scanner Interface	Yes	Yes	Yes	Yes
Advanced Settings	Yes	Yes	Yes	Yes
Restore Defaults	Yes	Yes	Yes	Yes

Target Application/E-mail Application

Select which application is used to open scanned data. Only applications installed on your computer can be selected.

- **Add**

Add an application to the pop-up menu.

Type the application name in the **Application Name** field (up to 30 characters) and select your preferred application by clicking the **Browse** button. Select the **File Type** option from the pop-up menu.

- **Delete**

Delete an application you have added to the pop-up menu.

Select the application from the **Application Name** pop-up menu, and then click **Delete**.

File Type

Select the file type you want to use for the scanned data.

File size

Change the file size by moving the **File size** slider to the right or left.

OCR Language

Set the OCR language to match the language of the scanned document's text.

Destination File Path

Click the **Change** button to change the prefix of the file name and the path of the destination folder.

File Name

Type a prefix for your file name, if needed.

Insert Date in File Name

Automatically insert the date in the file name of the scanned image.

Show Save As window

Select this option to specify the scanned image's destination every time you scan.

Destination Folder

Click **Browse** to select the folder where you would like to save your scanned document.

Show Folder

Select the **Show Folder** option to automatically display the destination folder after scanning.

Resolution

Select a scanning resolution from the **Resolution** pop-up menu. Higher resolutions take more memory and transfer time, but produce a finer scanned image.

Scan Type

Select from a range of scan color depths.

- **Black & White**
Use for text or line art images.
- **Gray (Error Diffusion)**
Use for photographic images or graphics. (Error Diffusion is a method for creating simulated gray images without using true gray dots. Black dots are put in a specific pattern to give a gray appearance.)
- **True Gray**
Use for photographic images or graphics. This mode is more accurate because it uses up to 256 shades of gray.
- **24bit Color**
Use to create an image with the most accurate color reproduction. This mode uses up to 16.8 million colors to scan the image, but it requires the most memory and has the longest transfer time.
- **Auto**
Use for any type of document. This mode automatically picks an appropriate color depth for the document.

Document Size

Select the exact size of your document from the **Document Size** pop-up menu.

- If you select the **1 to 2 (A4)** option, the scanned image will be divided into two A5-size documents.

Continuous Scanning

Select this option to scan multiple pages. After a page is scanned, select either continue scanning or finish.

2-sided Scanning

Select this check box to scan both sides of the document. When using the Automatic 2-sided Scan feature, you must select the **Long-edge binding** or **Short-edge binding** option, depending on the layout of your original, to make sure the created data file appears correctly.

(MFC-L8900CDW)

ID Card Scan

Select this check box to scan both sides of an identification card onto one page.

Show Scanner Interface

Select this check box to crop a portion of a scanned page after pre-scanning the document.

Advanced Settings

Configure advanced settings by clicking the **Advanced Settings** button in the Scan Settings dialog box.

- **Brightness**

Set the **Brightness** level by dragging the slider to the right or left to lighten or darken the image. If the scanned image is too light, set a lower brightness level and scan the document again. If the image is too dark, set a higher brightness level and scan the document again.

- **Contrast**

Increase or decrease the **Contrast** level by moving the slider to the right or left. An increase emphasize dark and light areas of the image, while a decrease reveals more details in gray areas.

- **Remove Background Color**

Remove the base color of documents to make the scanned data more recognizable. When you use this function, select from three settings: high, medium, and low.

(Available only for the **Auto**, **True Gray** and **24bit Color** options)

- **Rotate Image**

Rotate the scanned image.

- **ADF Auto Deskew**

When scanning the document from the ADF, the machine corrects skewing of the document automatically.

- **Skip Blank Page**

Remove blank pages of the document from the scanning results.

- **Display Scanning Results**

Show the numbers of total pages saved and blank pages skipped on your computer screen.

Restore Defaults

Select this option to restore all settings to their factory setting values.



Related Information

- [Scan Using ControlCenter2 \(Macintosh\)](#)
-

Scan Using TWAIN-Compliant Applications (Macintosh)

You can also scan using TWAIN-compliant applications. For more information about the scanning procedure, see the manual for your application.

1. Start your graphics application, and then select the scan operation.

The scanner setup dialog box appears.

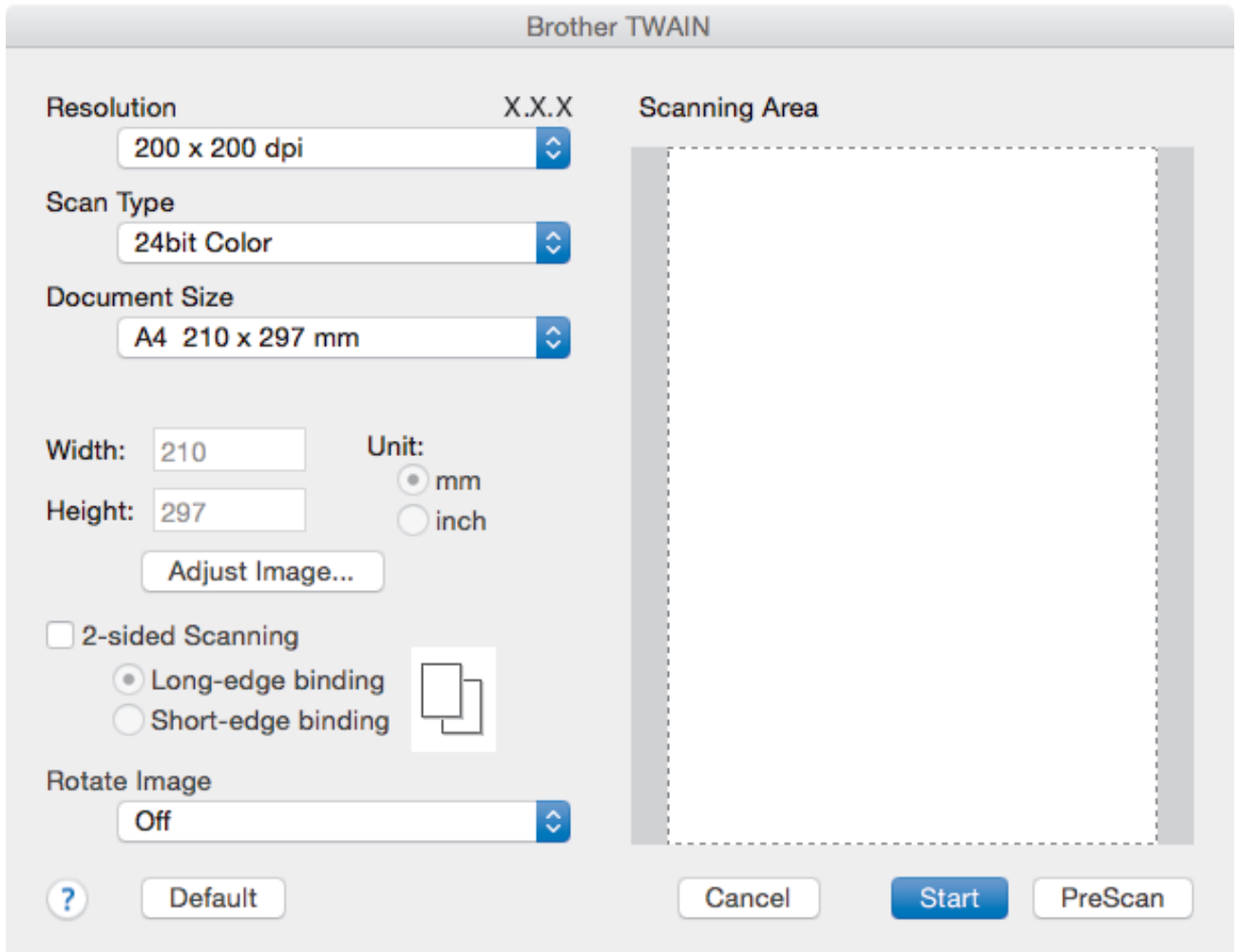

2. Change the scan settings, such as **Resolution**, **Scan Type**, or **Adjust Image**, if needed.
3. Click the **Document Size** pop-up menu, and then select your document size.
4. Click the **PreScan** option to preview your image and crop unwanted portions before scanning.



- After you select a document size, adjust the scanning area by holding down the mouse button and dragging your mouse pointer over the portion you want to scan.
- To scan both sides of the document (MFC-L8900CDW):
Automatic 2-sided scan is available only when using the ADF.
You cannot adjust the scanning area.
You cannot use PreScan to preview an image.

5. Click **Start**.
The machine starts scanning.

✓ Related Information

- [Scan from Your Computer \(Macintosh\)](#)

TWAIN Driver Settings (Macintosh)

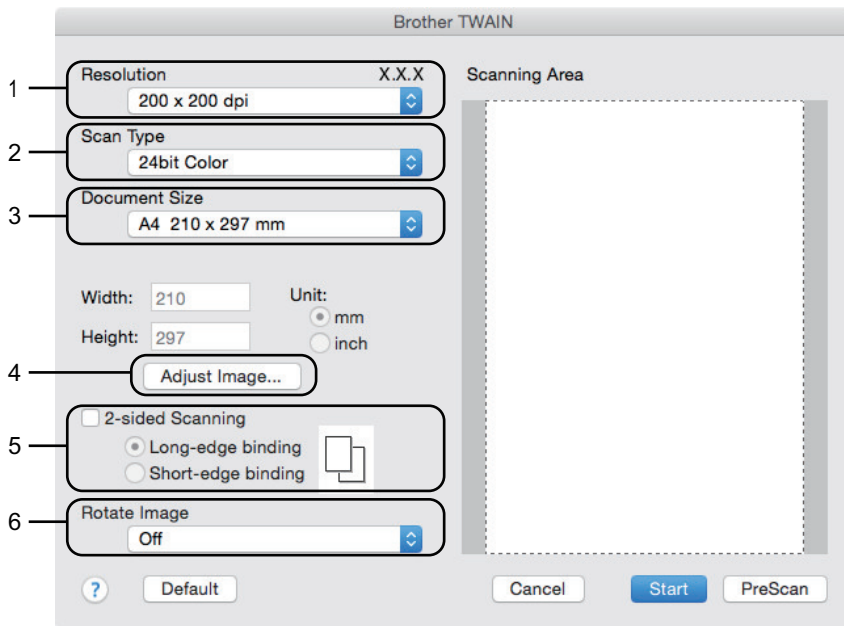

- Item names and assignable values will vary depending on the machine.
- The **Contrast** setting is available only when selecting **Gray (Error Diffusion)**, **True Gray**, or **24bit Color** from the **Scan Type** options.

1. Resolution

Select a scanning resolution from the **Resolution** pop-up menu. Higher resolutions take more memory and transfer time, but produce a finer scanned image.

2. Scan Type

Select from a range of scan color depths.

- **Black & White**

Use for text or line art images.

- **Gray (Error Diffusion)**

Use for photographic images or graphics. (Error Diffusion is a method for creating simulated gray images without using true gray dots. Black dots are put in a specific pattern to give a gray appearance.)

- **True Gray**

Use for photographic images or graphics. This mode is more accurate because it uses up to 256 shades of gray.

- **24bit Color**

Use to create an image with the most accurate color reproduction. This mode uses up to 16.8 million colors to scan the image, but it requires the most memory and has the longest transfer time.

3. Document Size

Select the exact size of your document from a selection of preset scan sizes.

- If you select **Custom**, you can specify the document size.

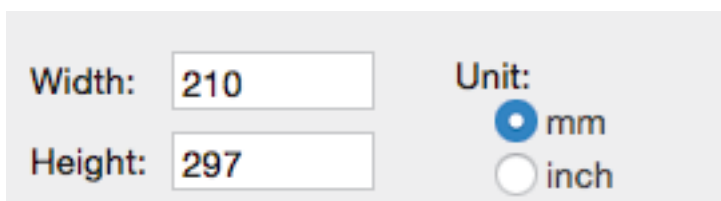

4. Adjust Image

Click the **Adjust Image** button to adjust other image qualities.

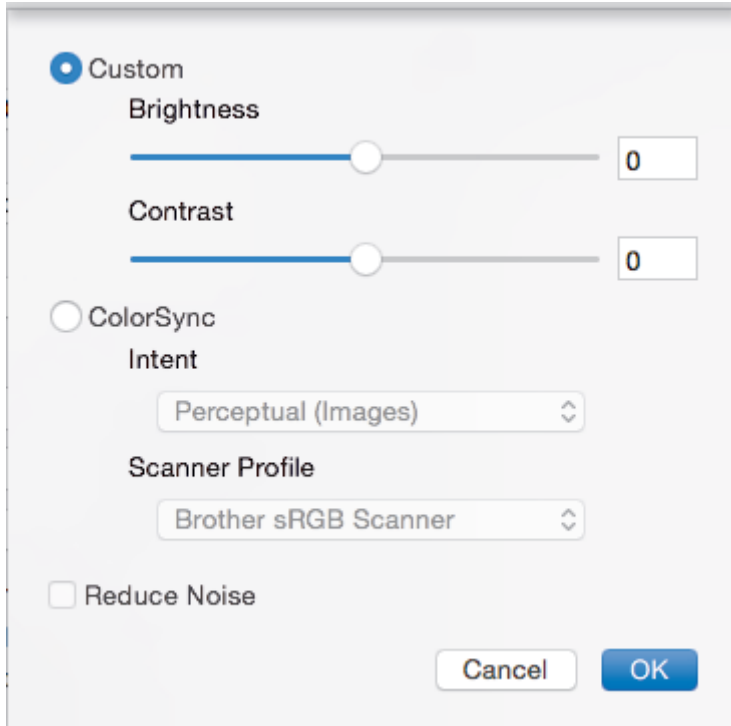

Brightness

Set the **Brightness** level by dragging the slider to the right or left to lighten or darken the image. If the scanned image is too light, set a lower brightness level and scan the document again. If the image is too dark, set a higher brightness level and scan the document again. You can also type a value in the box to set the brightness.

Contrast

Increase or decrease the **Contrast** level by moving the slider to the right or left. An increase emphasizes dark and light areas of the image, while a decrease reveals more details in gray areas. You can also type a value in the box to set the contrast.

Reduce Noise

Improve and enhance the quality of your scanned images with this selection. The **Reduce Noise** option is available when selecting the **24bit Color** option and the **300 x 300 dpi**, **400 x 400 dpi**, or **600 x 600 dpi** scan resolutions.

5. 2-sided Scanning

If you select this check box, the machine scans both sides of the document. When using the Automatic 2-sided Scan feature, you must select the **Long-edge binding** or **Short-edge binding** option, depending on the layout of your original, to make sure the created data file appears correctly.

(Available only for certain models)

6. Rotate Image

Rotate the scanned image.



Related Information

- [Scan from Your Computer \(Macintosh\)](#)

Configure Scan Settings Using Web Based Management

- [Set the Scan File Name Using Web Based Management](#)
- [Set the Scan Job Email Report Using Web Based Management](#)

Set the Scan File Name Using Web Based Management

Set up a file name for scanned data using Web Based Management.

1. Start your web browser.

Type "http://machine's IP address" in your browser's address bar (where "machine's IP address" is the IP address of the machine or the print server name). For example: http://192.168.1.2

No password is required by default. If you have previously set a password, type it, and then click .

2. Click the **Scan** tab.
3. Click the **Scan File Name** menu in the left navigation bar.
4. Select the **File Name Style** from the drop-down list.
5. If you selected the option to include the date in **File Name Style** field, select the **Date** format from the drop-down list.
6. In the **Time** fields, select **On** to include the time information in the file name.
7. In the **Counter** field, select **Continuous** or **Reset after each job**.



When you select **Reset after each job**, duplication of file names may occur.

8. If you want to create a user-defined file name prefix, type a file name in the user-defined fields of each scan function.



Using the following characters: ?, /, \, or * may cause a sending error.

9. Click **Submit**.



Related Information

- [Configure Scan Settings Using Web Based Management](#)

Set the Scan Job Email Report Using Web Based Management

When you scan a document, the machine will send a scan job email report automatically to the registered email address.

1. Start your web browser.

Type "http://machine's IP address" in your browser's address bar (where "machine's IP address" is the IP address of the machine or the print server name). For example: http://192.168.1.2

No password is required by default. If you have previously set a password, type it, and then click .

2. Click the **Scan** tab.
3. Click the **Scan Job e-mail report** menu in the left navigation bar.
4. In the **Administrator Address** field, type the email address.
5. For the scan functions you want, select **On** to send a scan job email report.
6. Click **Submit**.

Related Information

- [Configure Scan Settings Using Web Based Management](#)

Copy

- [Copy a Document](#)
- [Enlarge or Reduce Copied Images](#)
- [Make N in 1 Copies Using the Page Layout Feature](#)
- [Sort Copies](#)
- [Copy an ID Card](#)
- [Copy on Both Sides of the Paper \(2-sided Copy\)](#)
- [Copy Options](#)

Copy a Document

1. Make sure you have loaded the correct size paper in the paper tray.
2. Do one of the following:
 - Place the document *face up* in the ADF.
(If you are copying multiple pages, we recommend using the ADF.)

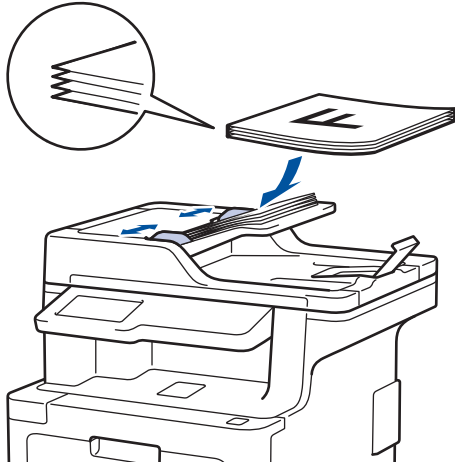

- Place the document *face down* on the scanner glass.

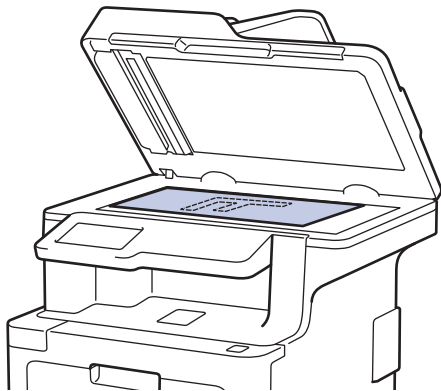

3. Press  [Copy].

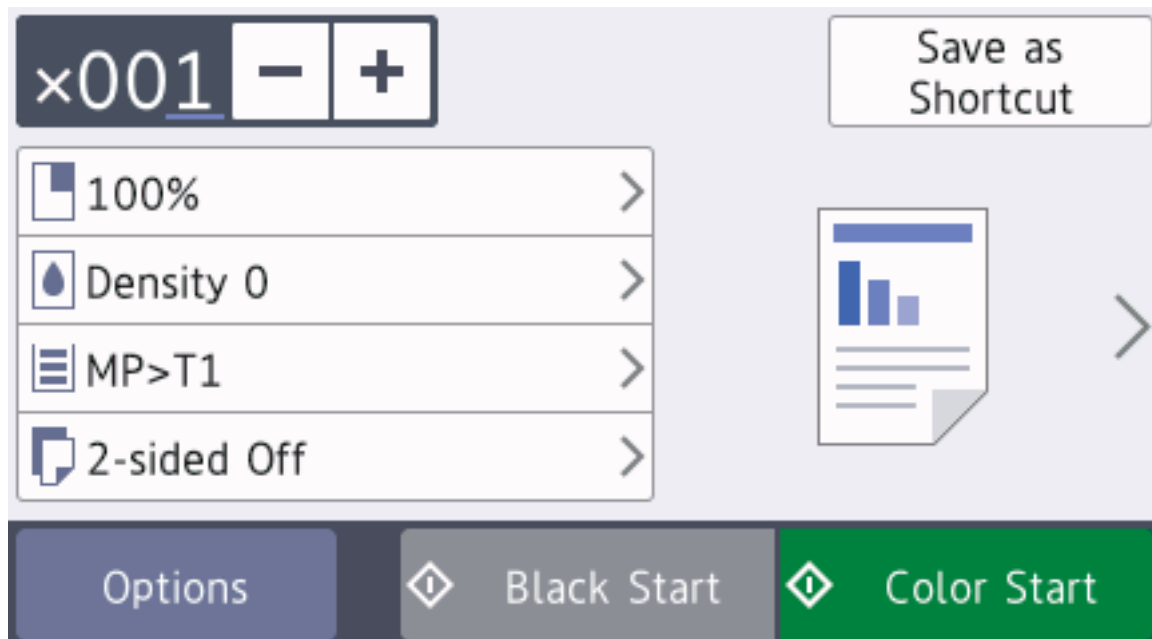

The LCD displays:



4. Change the copy settings, if needed.

- **001** (Number of copies)

Enter the number of copies in one of the following ways:

- Press  or  on the LCD.
- Press the numbers on the control panel.

- [Options]

Press  to change the copy settings for the next copy only.





- When finished, press [OK]. (If the [OK] button is displayed.)
- After you have finished choosing new options, you can save them by pressing the [Save as Shortcut] button.

- [Quick Copy]

Press > to access the preset copy settings.

- Current setting indications

Press the following icons or display area to change these settings for the next copy only.

-  [Enlarge/Reduce]
-  [Density]
-  [Tray Use]
-  [2-sided Copy]

5. Press [Color Start] or [Black Start].



To stop copying, press .



 **Related Information**

- [Copy](#)
-

Enlarge or Reduce Copied Images

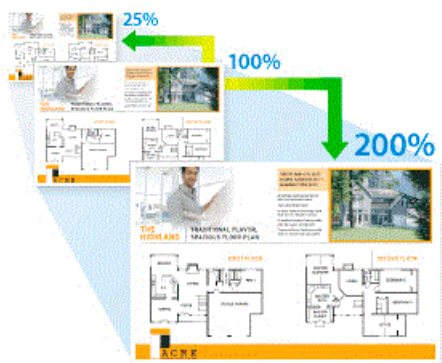
Select an enlargement or reduction ratio to resize your copied data.



1. Load your document.
2. Press  [Copy].
3. Enter the number of copies.
4. Press [Options] > [Enlarge/Reduce].
5. Swipe up or down or press ▲ or ▼ to display the available options, and then press the option you want.
6. Do one of the following:
 - If you select [Enlarge] or [Reduce], press the enlargement or reduction ratio you want to use.
 - If you select [Custom (25–400%)], press  (backspace) to erase the displayed percentage, or press ◀ to move the cursor, and then enter an enlargement or reduction ratio from [25] to [400]. Press [OK].
 - If you selected [100%], go to the next step.
7. When finished, press [OK]. (If the [OK] button is displayed.)
8. Press [Color Start] or [Black Start].

Related Information



- [Copy](#)

Make N in 1 Copies Using the Page Layout Feature

The N in 1 copy feature saves paper by copying two or four pages of your document onto one page of the copy.

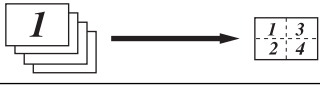
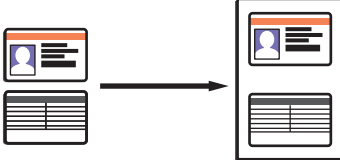

1. Load your document.
2. Press  [Copy].
3. Enter the number of copies.
4. Press [Options] > [Page Layout].
5. Swipe up or down or press ▲ or ▼ to display the options, and then press the option you want.

Option	Description
2in1 (Portrait)	
2in1 (Landscape)	
4in1 (Portrait)	
4in1 (Landscape)	
2in1 (ID)	

Use the scanner glass.

6. When finished, press [OK]. (If the [OK] button is displayed.)
7. Press [Color Start] or [Black Start].
If you placed the document in the ADF, the machine scans the pages and starts printing.
8. **If you are using the scanner glass, repeat the following steps for each page of the document:**
 - Place the next page on the scanner glass, and then press [Continue] to scan the page.
 - After scanning all the pages, press [Finish].



Related Information

- [Copy](#)
-

Sort Copies

Sort multiple copies. Pages will be stacked in the order they are fed, that is: 1, 2, 3, and so on.

1. Load your document.
2. Press  [Copy].
3. Enter the number of copies.
4. Press [Options] > [Stack/Sort] > [Sort].
5. When finished, press [OK]. (If the [OK] button is displayed.)
6. Press [Color Start] or [Black Start].

If you placed the document in the ADF, the machine scans the pages and starts printing.

7. **If you are using the scanner glass, repeat the following steps for each page of the document:**
 - Place the next page on the scanner glass, and then press [Continue] to scan the page.
 - After scanning all the pages, press [Finish].



Related Information

- [Copy](#)

Copy an ID Card

Use the [2 in 1 ID Copy] feature to copy both sides of an identification card onto one page, keeping the original card size.



- You may copy an identification card only to the extent permitted under applicable laws. For more information, see the *Product Safety Guide*.

- Place your identification card *face down* near the upper left corner of the scanner glass.

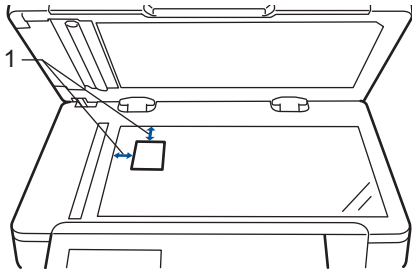

1: Distance 0.16 in. (4.0 mm) or greater (top, left)

- Press  [Copy].
- Press [Options] > [Page Layout] > [2in1 (ID)].
- When finished, press [OK]. (If the [OK] button is displayed.)
- Enter the number of copies.
- Press [Color Start] or [Black Start].
The machine scans one side of the identification card.
- After the machine has scanned the first side, turn over the identification card.

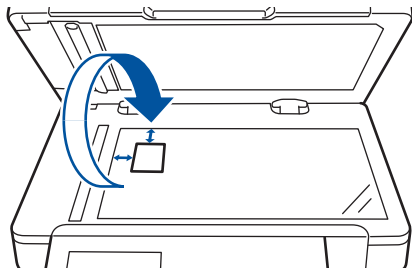

- Press [Continue] to scan the other side.

Related Information

- [Copy](#)

Copy on Both Sides of the Paper (2-sided Copy)

Reduce the amount of paper you use by copying onto both sides of the paper.

- You must choose a 2-sided copy layout from the following options before you can start 2-sided copying.
- The layout of your original document determines which 2-sided copy layout you should choose.
- To use the automatic 2-sided copy feature, you must load your document in the ADF.
- When you manually make 2 sided copies from a 2-sided document, use the scanner glass.
- Select Letter, Legal, Mexico Legal or Folio sized paper when using the 2-sided copy option.

Portrait

2-sided to 2-sided

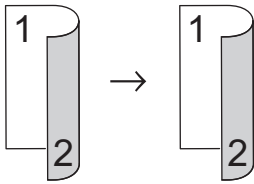

1-sided to 2-sided (Long Edge Flip)

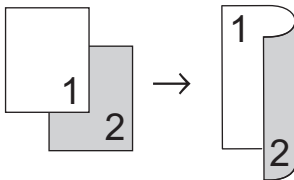

1-sided to 2-sided (Short Edge Flip)

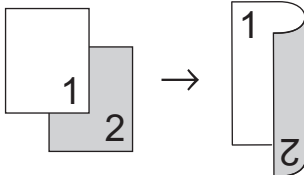

Landscape

2-sided to 2-sided

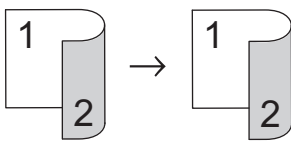

1-sided to 2-sided (Long Edge Flip)

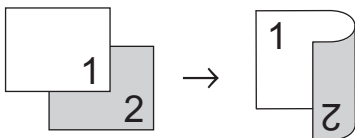

1-sided to 2-sided (Short Edge Flip)

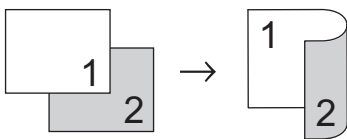

1. Load your document.

NOTE

- For 2-sided scan models: Load your 2-sided document in the ADF. If you use the scanner glass for your 2-sided document, select the [1-sided⇒2-sided] option.
- For 1-sided scan models: Load your 2-sided document to the scanner glass.

2. Press  [Copy].
3. Enter the number of copies.
4. Press [Options] > [2-sided Copy].
5. Do one of the following:
 - To make 2-sided copies of a 2-sided document, press [2-sided⇒2-sided].
 - To make 2-sided copies from a 1-sided document, follow these steps:
 - a. To change the layout options, press [Layout], and then press [Long Edge Flip] or [Short Edge Flip].
 - b. Press [1-sided⇒2-sided].
6. When finished, press [OK]. (If the [OK] button is displayed.)
7. Press [Color Start] or [Black Start].

If you placed the document in the ADF, the machine scans the pages and starts printing.

8. **If you are using the scanner glass, repeat the following steps for each page of the document:**



- For a 2-sided document, turn the sheet over along the long edge to scan the other side.
- Place the next page on the scanner glass, and then press [Continue] to scan the page.
- After scanning all the pages, press [Finish].



Related Information

- [Copy](#)

Copy Options

To change the Copy settings, press [Options].

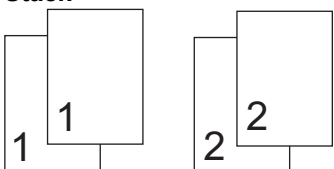
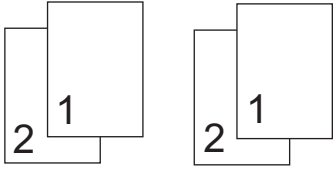
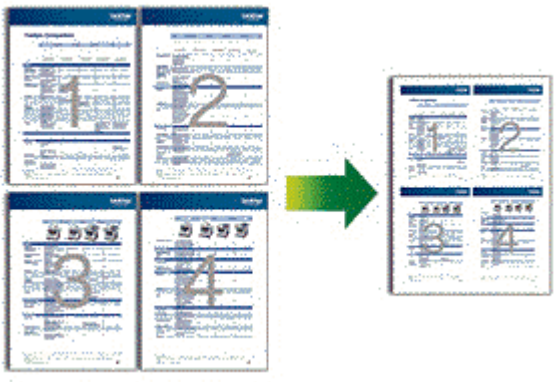
Menu selections	Options	
Quality	Select the copy quality for your type of document.	
Enlarge/Reduce	100%	-
	Enlarge	Select an enlargement ratio for the next copy.
	Reduce	Select a reduction ratio for the next copy.
	Custom (25-400%)	Enter an enlargement or reduction ratio.
Density	Increase the density to make the text darker. Decrease the density to make the text lighter.	
Contrast	Increase the contrast to make an image clearer. Decrease the contrast to make an image more subdued.	
Stack/Sort	Select to stack or sort multiple copies. Stack  Sort 	
Page Layout	Make N in 1 or 2 in 1 ID copies. 4 in 1 	

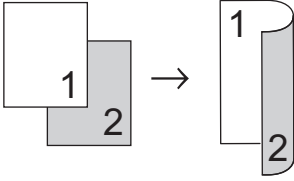
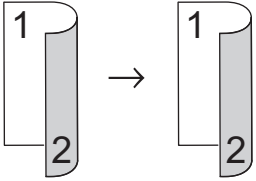
Menu selections	Options
2-sided Copy	<p>Select to copy on both sides of the paper.</p> <p>1-sided → 2-sided</p>  <p>2-sided → 2-sided</p>  <p>The available options will vary depending on your model.</p>
2-sided Copy Page Layout (available for certain settings)	Select long edge binding or short edge binding.
Color Adjust	Change the default setting for color saturation.
Remove Background Color	Select to remove the background color of the document when copying.
Tray Use	Select a paper tray for the next copy.
Save as Shortcut	Add the current settings as a shortcut.



Related Information

- [Copy](#)

Fax

- [Send a Fax](#)
- [Receive a Fax](#)
- [Voice Operations and Fax Numbers](#)
- [Telephone Services and External Devices](#)
- [Fax Reports](#)
- [PC-FAX](#)

Send a Fax

- [Send a Fax](#)
- [Send a 2-sided Fax from the ADF](#)
- [Send a Fax Manually](#)
- [Send a Fax at the End of a Conversation](#)
- [Send the Same Fax to More than One Recipient \(Broadcasting\)](#)
- [Send a Fax in Real Time](#)
- [Send a Fax at a Specified Time \(Delayed Fax\)](#)
- [Add a Cover Page to Your Fax](#)
- [Cancel a Fax in Progress](#)
- [Check and Cancel a Pending Fax](#)
- [Fax Options](#)

Send a Fax

1. Do one of the following:

- Place the document *face up* in the ADF.
(If you are faxing multiple pages, we recommend using the ADF.)

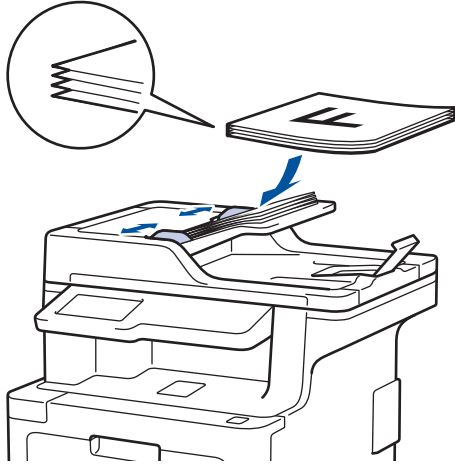

- Place the document *face down* on the scanner glass.

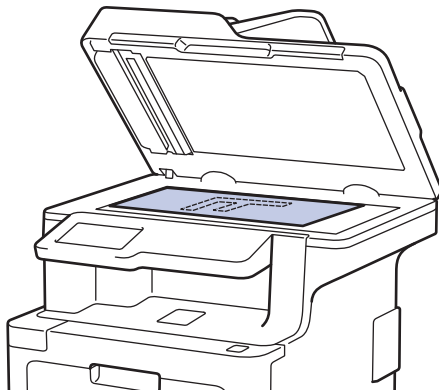

2. Press  [Fax].

3. Enter the fax number.

- Using the dial pad**

Press the digits to enter the fax number.

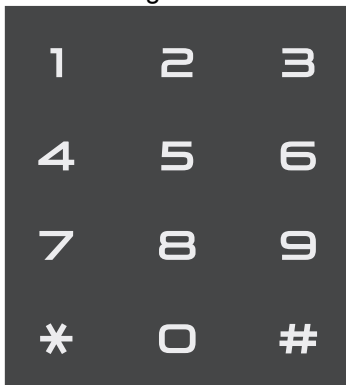

- Using the Address Book**

Press  [Address Book], and then do one of the following:

- Swipe up or down or press ▲ or ▼ to display the number you want, and then press it.
- Press  [Search], and then enter the name and press [OK]. Press the name you want to dial.

When finished, press [Apply].

- **Using the call history**

Press  [Call History], and then press the [Outgoing Call] option.

Swipe up or down or press ▲ or ▼ to display the fax number you want, and then press it.

To send a fax, press [Apply].

4. Press [Fax Start].

The machine scans and sends the document.

If you placed the document on the scanner glass, follow the instructions in the table.

Option	Description
Yes	To scan the next page, press the Yes option, and then place the next page on the scanner glass. Press OK to scan the page.
No	After you have scanned the last page, press the No option. The machine sends the document.

To stop faxing, press , and then press .



Related Information

- [Send a Fax](#)
-

Send a 2-sided Fax from the ADF

Related Models: MFC-L8900CDW

You must select a 2-sided scanning format before sending a 2-sided fax. Select either Long Edge or Short Edge, depending on the layout of your document.

1. Load your document.
2. Press  [Fax] > [Options] > [2-sided Fax].
3. Do one of the following:
 - If your document is flipped on the Long edge, press the [2-sided Scan: Long Edge] option.
 - If your document is flipped on the Short edge, press the [2-sided Scan: Short Edge] option.
4. Press [OK]. (If the [OK] button is displayed.)
5. Enter the fax number.
6. Press [Fax Start].



Related Information

- [Send a Fax](#)

Send a Fax Manually

Manual fax transmission lets you hear the dialing, ringing and fax-receiving tones while sending a fax.

1. Load your document.
2. Press  [Fax].
3. Press [Hook] and listen for a dial tone.
4. Dial the fax number you want to call.
5. When you hear the fax tone, press [Fax Start].
 - If you are using the scanner glass, press [Send].



Related Information

- [Send a Fax](#)
-

Send a Fax at the End of a Conversation

At the end of a conversation, you can send a fax to the other party before you both hang up.

1. Ask the other party to wait for fax tones (beeps) and then to press the Start key before hanging up.
2. Load your document.
3. Press [Fax Start].
 - If you are using the scanner glass, press [Send].
4. Replace the handset of an external telephone.



Related Information

- [Send a Fax](#)
-

Send the Same Fax to More than One Recipient (Broadcasting)

Use the Broadcasting feature to send the same fax to multiple fax numbers at the same time.

- The same broadcast can include Groups, Address Book numbers (One Touch Dial numbers and Speed Dial numbers in some models) and up to 50 manually dialed numbers.
- Touchscreen LCD models
If you did not use any of the Address Book numbers for Groups, you can broadcast faxes to as many as 350 different numbers.
- Address Book numbers (One Touch Dial numbers and Speed Dial numbers in some models) must be stored in the machine's memory before they can be used in a broadcast.
- Group numbers must also be stored in the machine's memory before they can be used in a broadcast. Group numbers include many stored Address Book numbers (One Touch Dial numbers and Speed Dial numbers in some models) for easier dialing.

1. Load your document.
2. Press  [Fax] > [Options] > [Broadcasting].
3. Press [Add Number].

You can add numbers to the broadcast in the following ways:

- Press [Add Number] and enter a number using the LCD.
Press [OK].



If you want to broadcast using an email address, press , enter the email address, and press [OK].

(On certain models, you must download Internet Fax to use the Internet Fax feature and the Scan to Email server feature.)

- Press [Add from Address book]. Swipe up or down or press ▲ or ▼ to display the number you want to add to the broadcast. Select the check boxes of the broadcast. After you select all the numbers you want, press [OK].
 - Press [Search in Address book]. Press the name and press [OK]. Press the name, and then press the number you want to add.
4. When finished, press [OK].



If your machine displays , press .

5. Press [Fax Start]. After the broadcast is finished, the machine will print a broadcast report to let you know the results.



- The machine's available memory will vary depending on the types of jobs in the memory and the numbers used for broadcasting. If you broadcast to the maximum number available, you will not be able to use dual access and delayed fax.
- If the [Out of Memory] message appears, press  to stop the job. If more than one page has been scanned, press [Send Now] to send the portion that is in the machine's memory.





Related Information

- [Send a Fax](#)
- [Cancel a Broadcast in Progress](#)

Cancel a Broadcast in Progress

While broadcasting you can cancel the fax currently being sent or the whole broadcast job.

1. Press .
2. Press .
3. Do one of the following:
 - To cancel the entire broadcast, press [Entire Broadcast].
 - To cancel the current job, press the name or number being dialed on the LCD.
 - To exit without canceling, press .



Related Information

- [Send the Same Fax to More than One Recipient \(Broadcasting\)](#)

Send a Fax in Real Time

When sending a fax, the machine scans the document into the memory before sending it. As soon as the telephone line is free, the machine starts dialing and sending. If you want to send an important document immediately without waiting for the machine to retrieve the scan from its memory, turn on [Real Time TX].

- If the memory is full and you are sending a fax from the ADF, the machine sends the document in real time (even if [Real Time TX] is set to [Off]). If the memory is full, faxes from the scanner glass cannot be sent until you clear some of the memory.
- In Real Time Transmission, the automatic redial feature does not work when using the scanner glass.
- If [Real Time TX] is set to on, the option to scan 2-sided documents is not available.



1. Load your document.
2. Press  [Fax] > [Options] > [Real Time TX].
3. Press [On] or [Off].
4. Press [OK]. (If the [OK] button is displayed.)
5. Enter the fax number.
6. Press [Fax Start].

Related Information

- [Send a Fax](#)

Send a Fax at a Specified Time (Delayed Fax)

You can store up to 50 faxes in the machine's memory to be sent within the next twenty-four hour period.

1. Load your document.
2. Press  [Fax] > [Options] > [Delayed Fax] > [Delayed Fax].
3. Press [On].
4. Press [Set Time].
5. To enter the time you want the fax to be sent, do one of the following:
 - If you set [12h Clock] in the [Clock Type] setting, enter the time in 12-hour format.
Press the  button to select [AM] or [PM], and then press [OK].
 - If you set [24h Clock] in the [Clock Type] setting, enter the time in 24-hour format and then press [OK].
(For example, enter 19:45 for 7:45 PM.)
6. Press [OK].



If the [OK] button is not displayed after setting the time, press  to return the fax sending screen.

7. Enter the fax number.
8. Press [Fax Start].
9. Press .



Related Information

- [Send a Fax](#)

Add a Cover Page to Your Fax

You can add a cover page to the next fax or every outgoing fax.

- This feature will not work unless you have programmed your Station ID.
- Your cover page includes your Station ID, a comment, and the name stored in the Address Book, One Touch Dial, or Speed Dial (in some models).

1. Load your document.
2. Press  [Fax] > [Options] > [Coverpage Setup] > [Coverpage Setup].
3. Press [On].
4. Press [Coverpage Message].
5. Swipe up or down or press ▲ or ▼ to choose the comment you want to use, and then press the comment.
Press .
6. Press [OK]. (If the [OK] button is displayed.)
7. Enter the fax number.
8. Press [Fax Start].

The cover page will be added to the next fax. If you want to add the cover page to every outgoing fax, set the settings as the new default.



Related Information

- [Send a Fax](#)
- [Compose Your Own Comments](#)
- [Use a Printed Cover Page](#)

Compose Your Own Comments

You can set up two comments of your own.

1. Press  [Settings] > [All Settings] > [Fax] > [Setup Send] > [Coverpage Setting] > [Coverpage Message].



If your machine displays the [All Settings] menu on the Home screen, skip the [Settings] menu.

2. Press [5.] or [6.] to store your own comment.
3. Enter your own comment using the LCD. Press [OK].

Press  to choose numbers, letters or special characters.



If your machine displays , press .

4. Press .



Related Information

- [Add a Cover Page to Your Fax](#)

Use a Printed Cover Page

If you want a printed cover page you can write on, print the sample page and attach it to your fax.

1. Press  [Settings] > [All Settings] > [Fax] > [Setup Send] > [Coverpage Setting] > [Print Sample].



If your machine displays the [All Settings] menu on the Home screen, skip the [Settings] menu.



2. Press [Yes].
The machine prints the sample cover page.
3. Press .



Related Information

- [Add a Cover Page to Your Fax](#)

Cancel a Fax in Progress

1. Press .
2. Press  while the machine is dialing or sending a fax.
The LCD will display [Cancel Job?].
3. Press an option in the table to cancel or continue the fax job in progress.

Option	Description
Yes	The machine cancels sending the fax job.
No	The machine exits from the process without canceling the fax job.

Related Information

- [Send a Fax](#)

Check and Cancel a Pending Fax

You can cancel a fax job before it is sent, by canceling the fax job while it is stored and waiting in the memory.

1. Press  [Settings] > [All Settings] > [Fax] > [Remaining Jobs].



If your machine displays the [All Settings] menu on the Home screen, skip the [Settings] menu.

2. Swipe up or down or press ▲ or ▼ to scroll through the waiting jobs, and then press the job you want to cancel.
3. Press [Cancel].
4. Press [Yes] to confirm or press [No] to exit without canceling.
5. When finished canceling jobs, press .



Related Information

- [Send a Fax](#)

Fax Options

To change fax-sending settings, press the [Options] button.

Option	Description
Fax Resolution	Set the resolution for outgoing faxes. The fax quality often can be improved by changing the Fax Resolution.
2-sided Fax (For automatic 2-sided scanning models)	Set the 2-sided scanning format.
Contrast	Adjust the contrast. If your document is very light or very dark, changing the contrast may improve the fax quality.
Broadcasting	Send the same fax message to more than one fax number at the same time.
Delayed Fax	Set the time of day the delayed faxes will be sent.
Real Time TX	Send a fax immediately without waiting for the machine to retrieve the scan from its memory.
Coverpage Setup	Set the machine to automatically send a cover page that you have pre-programmed.
Overseas Mode	Set to On if you have difficulty sending faxes overseas.
Glass Scan Size	Adjust the scan area of the scanner glass to the size of the document.
Set New Default	Save your settings as the default.
Factory Reset	Restore all settings back to the factory settings.



You can save the current settings by pressing [Save as Shortcut].



Related Information

- [Send a Fax](#)

Receive a Fax

- [Receive Mode Settings](#)
- [Memory Receive \(Remote Fax\) Options](#)
- [Remote Fax Retrieval](#)

Receive Mode Settings

- [Receive Modes Overview](#)
- [Choose the Correct Receive Mode](#)
- [Set the Number of Rings Before the Machine Answers \(Ring Delay\)](#)
- [Set the F/T Ring Time \(Pseudo/Double-ring\)](#)
- [Set Easy Receive](#)
- [Shrink Page Size of an Oversized Incoming Fax](#)
- [Set the 2-sided Printing for Received Faxes](#)
- [Set the Fax Receive Stamp](#)
- [Receive a Fax at the End of a Telephone Conversation](#)

Receive Modes Overview

Some receive modes answer automatically (Fax Only Mode and Fax/Tel Mode). You may want to change the Ring Delay before using these modes.

Fax Only Mode

([Fax Only] in the machine's menu)

Fax Only Mode automatically answers every call as a fax.

Fax/Tel Mode

([Fax/Tel] in the machine's menu)

Fax/Tel Mode helps you manage incoming calls, by recognizing whether they are fax or voice calls and handling them in the following ways:

- Faxes will be received automatically.
- Voice calls will start the F/T ring to tell you to pick up the call. The F/T ring is a fast pseudo/double-ring made by your machine.

Manual Mode

([Manual] in the machine's menu)

Manual Mode turns off all automatic answering operations unless you are using the Distinctive Ring Receive feature.

To receive a fax in Manual Mode, lift the handset of the external telephone connected to the machine or press the button in the table.

Applicable Models	Alternate way to lift the handset
MFC-L8610CDW/MFC-L8900CDW	 Fax and then Hook

When you hear fax tones (short repeating beeps), press the buttons in the table to receive a fax. Use the Easy Receive feature to receive faxes when you have lifted a handset on the same line as the machine.

Applicable Models	To receive the fax
All MFC models	Fax Start and then Receive

External TAD Mode

([External TAD] in the machine's menu)

External TAD Mode lets an external answering device manage your incoming calls.

Incoming calls will be handled in the following ways:

- Faxes will be received automatically.
- Voice callers can record a message on the external TAD.



Related Information

- [Receive Mode Settings](#)

Choose the Correct Receive Mode

The correct Receive Mode for you is determined by the external devices and telephone subscriber services (Voice Mail, Distinctive Ring and so on) you will be using on the same line as the Brother machine.

Will you be using a Distinctive Ring number for receiving faxes?

Brother uses the term "Distinctive Ring" but different telephone companies may have other names for this service, such as Custom Ringing, Personalized Ring, Teen Ring, Ident-A-Ring, Ident-A-Call, Data Ident-A-Call, Smart Ring and SimpleBiz Fax & Alternate Number Ringing.

Will you be using Voice Mail on the same telephone line as your Brother machine?

If you have Voice Mail on the same telephone line as your Brother machine, there is a strong possibility that Voice Mail and the Brother machine will conflict with each other when receiving incoming calls.

Will you be using a Telephone Answering Device on the same telephone line as your Brother machine?

Your external telephone answering device (TAD) will answer every call automatically. Voice messages are stored on the external TAD and fax messages are printed. Select [External TAD] as your receive mode.

Will you be using your Brother machine on a dedicated fax line?

Your machine automatically answers every call as a fax. Select [Fax Only] as your receive mode.

Will you be using your Brother machine on the same line as your telephone?

• Do you want to receive voice calls and faxes automatically?

The Fax/Tel Mode is used when sharing the Brother machine and your telephone on the same line. Select [Fax/Tel] as your receive mode.

Important Note: You cannot receive voice messages on either Voice Mail or an answering machine if you selected the Fax/Tel Mode.

• Do you expect to receive very few faxes?

Choose [Manual] as your receive mode. You control the telephone line and must answer every call yourself.

1. Press  [Settings] > [All Settings] > [Fax] > [Setup Receive] > [Receive Mode].



- If your machine displays the [All Settings] menu on the Home screen, skip the [Settings] menu.
- If you cannot change the [Receive Mode] option, make sure the Distinctive Ring feature is set to [Off].

2. Press [Fax Only], [Fax/Tel], [External TAD], or [Manual].

3. Press .



Related Information

- [Receive Mode Settings](#)
- [Telephone and Fax Problems](#)

Set the Number of Rings Before the Machine Answers (Ring Delay)

When somebody calls your machine, you will hear the normal telephone ring sound. The number of rings is set in the Ring Delay option.

- The Ring Delay setting sets the number of times the machine rings before it answers in the Fax Only and Fax/Tel Modes.
- If you have external or extension telephones on the same line as the machine, keep the Ring Delay setting of 4.

1. Press  [Settings] > [All Settings] > [Fax] > [Setup Receive] > [Ring Delay].

 If your machine displays the [All Settings] menu on the Home screen, skip the [Settings] menu.

2. Press the number of rings you want.

 If you select [0], the machine will answer immediately and the line will not ring at all (available only for some countries).

3. Press .

Related Information

- [Receive Mode Settings](#)
- [Telephone and Fax Problems](#)

Set the F/T Ring Time (Pseudo/Double-ring)

When you set the Receive Mode to Fax/Tel Mode, if the call is a fax, your machine will automatically receive it. However, if it is a voice call, the machine will sound the F/T ring (pseudo/double-ring) for the time you set in the F/T Ring Time option. When you hear the F/T ring, it means that a voice caller is on the line.

- The F/T Ring Time feature works when you set Fax/Tel Mode as the Receive Mode.

Because the F/T ring is made by the machine, extension and external telephones will not ring; however, you can still answer the call on any telephone.

1. Press  [Settings] > [All Settings] > [Fax] > [Setup Receive] > [F/T Ring Time].



If your machine displays the [All Settings] menu on the Home screen, skip the [Settings] menu.

2. Press how long you want the machine to ring to alert you that you have a voice call.
3. Press .



Even if the caller hangs up during the pseudo/double-ringing, the machine will continue to ring for the set time.



Related Information

- [Receive Mode Settings](#)

Set Easy Receive

If Easy Receive is On: The machine can receive a fax automatically, even if you answer the call. When you see [Receiving] on the LCD or hear a click on the phone line through the handset you are using, just replace the handset. Your machine will do the rest.

If Easy Receive is Off: If you are at the machine and answer a fax call first by lifting the external handset, press the buttons in the following table to receive the fax. If you answered at an extension telephone, press *51.

Applicable Models	To receive the fax
MFC-L8610CDW/MFC-L8900CDW	Fax Start and then Receive



- If this feature is set to [On], but your machine does not connect a fax call when you lift an extension or external telephone handset, press the fax receive code *51.
- If you send faxes from a computer on the same telephone line and the machine intercepts them, set Easy Receive to [Off].

1. Press  [Settings] > [All Settings] > [Fax] > [Setup Receive] > [Easy Receive].



If your machine displays the [All Settings] menu on the Home screen, skip the [Settings] menu.

2. Press [On] or [Off].

3. Press .



Related Information

- [Receive Mode Settings](#)

Shrink Page Size of an Oversized Incoming Fax

If you enable the auto reduction function, the machine reduces each page of an incoming fax to fit on your paper. The machine calculates the reduction ratio by using the page size of the fax and your Paper Size setting.

1. Press  [Settings] > [All Settings] > [Fax] > [Setup Receive] > [Auto Reduction].



If your machine displays the [All Settings] menu on the Home screen, skip the [Settings] menu.

2. Press [On] or [Off].
3. Press .



Related Information

- [Receive Mode Settings](#)

Set the 2-sided Printing for Received Faxes

Your machine prints received faxes on both sides of the paper when [2-sided] is set to [On].

- Use Letter, Legal, Folio (8.5 in. × 13 in.) or Mexico Legal size paper for this function [16 to 28 lb (60 to 105 g/m²)].
- When 2-sided printing is enabled, incoming faxes are automatically reduced to fit the paper in the paper tray.

1. Press  [Settings] > [All Settings] > [Fax] > [Setup Receive] > [2-sided].



If your machine displays the [All Settings] menu on the Home screen, skip the [Settings] menu.

2. Press [On] or [Off].

3. Press .



Related Information

- [Receive Mode Settings](#)

Set the Fax Receive Stamp

You can set the machine to print the received date and time at the top center of each received fax page.

- Make sure you have set the current date and time on the machine.
- The received time and date will not appear when using Internet Fax.

1. Press  [Settings] > [All Settings] > [Fax] > [Setup Receive] > [Fax Rx Stamp].



If your machine displays the [All Settings] menu on the Home screen, skip the [Settings] menu.

2. Press [On] or [Off].

3. Press .



Related Information

- [Receive Mode Settings](#)

Receive a Fax at the End of a Telephone Conversation

If you are speaking on the telephone connected to your Brother machine and the other party is also speaking on a telephone connected to his fax machine, at the end of the conversation, the other party can send you a fax before you both hang up.

Your machine's ADF must be empty.

1. Ask the other party to place the document in their machine and to press the Start or Send key.
2. When you hear the CNG tones (slowly repeating beeps), press [Fax Start].



If the machine is in Automatic Redial, wait until it is finished and try again.

3. Press [Receive] to receive a fax.
4. Replace the external handset.



Related Information

- [Receive Mode Settings](#)

Memory Receive (Remote Fax) Options

Use Memory Receive (Remote Fax) options to direct incoming faxes while you are away from the machine. You can use only one Memory Receive option at a time.

Memory Receive (Remote Fax) can be set to:

- Fax Forwarding
- Paging
- Fax Storage
- PC-Fax Receive
- Forward to Cloud
 - The machine forwards your received faxes to online services.
- Off
 - [Forward Incoming Faxes to Another Machine](#)
 - [Set the Machine to Dial a Cell Phone or Pager Number When Receiving Faxes](#)
 - [Store Incoming Faxes in the Machine's Memory](#)
 - [Change Memory Receive Options](#)
 - [Turn Off Memory Receive](#)
 - [Print a Fax Stored in the Machine's Memory](#)
 - [Use PC-Fax Receive to Transfer Received Faxes to Your Computer \(Windows® only\)](#)

Forward Incoming Faxes to Another Machine

Use the Fax Forwarding feature to automatically forward your incoming faxes to another machine.

1. Press  [Settings] > [All Settings] > [Fax] > [Setup Receive] > [Memory Receive].



If your machine displays the [All Settings] menu on the Home screen, skip the [Settings] menu.

2. Press [Fax Forward].
3. Do one of the following:
 - Press [Manual] to enter the forwarding fax number (up to 20 characters) using the LCD.
Press [OK].



To forward a fax using an email address, press , enter the email address, and press [OK].

(On certain models, you must download Internet Fax to use the Internet Fax feature and the Scan to Email server feature.)

- Swipe up or down or press ▲ or ▼ to scroll until you find the fax number or email address where you want your faxes to be forwarded.
Press the fax number or email address you want.

NOTE

- Press [Backup Print: On] or [Backup Print: Off]. If you select [Backup Print: On], the machine also prints a copy of received faxes at your machine.

4. Press .



Related Information

- [Memory Receive \(Remote Fax\) Options](#)

Set the Machine to Dial a Cell Phone or Pager Number When Receiving Faxes

Use the Paging option if you want your machine to dial a pre-programmed cell phone or pager number. This feature activates your cell phone or pager so you will know there is a fax message in the machine's memory.

If you turn on Paging, a backup copy will automatically print at the machine. You cannot change a pager number, cell phone number or PIN remotely.

1. Press  [Settings] > [All Settings] > [Fax] > [Setup Receive] > [Memory Receive].



If your machine displays the [All Settings] menu on the Home screen, skip the [Settings] menu.

2. Swipe up or down or press ▲ or ▼ to display the [Paging] option, and then press [Paging].
3. Enter your cell phone or pager number followed by ## (up to 20 digits) using the LCD. Press [OK]. Do not include the area code if it is the same as that of your machine. For example: press 18005551234##.
4. Do one of the following:
 - If you are programming a cell phone number, press [OK].
 - If your pager needs a PIN, enter the PIN, press #, press [Pause], and enter your fax number followed by ##. Press [OK]. (For example: press 12345 # [Pause] 18005556789 ##)
 - If you do not need a PIN, press [OK].
5. Press .



Related Information

- [Memory Receive \(Remote Fax\) Options](#)

Store Incoming Faxes in the Machine's Memory

Use the Fax Storage feature to store incoming faxes in the machine's memory. Retrieve your stored fax messages from your fax machine when you are at another location using the Remote Retrieval commands. Your machine will print a backup copy of each stored fax.

1. Press  [Settings] > [All Settings] > [Fax] > [Setup Receive] > [Memory Receive].



If your machine displays the [All Settings] menu on the Home screen, skip the [Settings] menu.

2. Swipe up or down or press ▲ or ▼ to display the [Fax Storage] option, and then press [Fax Storage].
3. Press .



Related Information

- [Memory Receive \(Remote Fax\) Options](#)

Change Memory Receive Options

If received faxes are in your machine's memory when you change the Remote Fax operations, the LCD will ask you one of the following questions:

If received faxes have been printed automatically, the LCD displays [Erase all faxes?]

- Do one of the following:
 - If you press [Yes], faxes in the memory will be erased before the setting changes.
 - If you press [No], faxes in the memory will not be erased and the setting will be unchanged.

If unprinted faxes are in the machine's memory, the LCD displays [Print all faxes?]

- Do one of the following:
 - If you press [Yes], faxes in the memory will be printed before the setting changes.
 - If you press [No], faxes in the memory will not be printed and the setting will be unchanged.

If received faxes are left in the machine's memory when you change to [PC Fax Receive] from another option ([Fax Forward], [Paging], or [Fax Storage]).

- Press [<USB>] or the name of the computer if you are on a network, and then press [OK].

The LCD displays:

[Send Fax to PC?]

- If you press [Yes], faxes in the memory will be sent to your computer before the setting changes. You will be asked if you want to turn on Backup Print.
- If you press [No], faxes in the memory will not be erased and the setting will be unchanged.



Related Information

- [Memory Receive \(Remote Fax\) Options](#)

Turn Off Memory Receive

Turn off Memory Receive if you do not want the machine to save or transfer incoming faxes.

1. Press  [Settings] > [All Settings] > [Fax] > [Setup Receive] > [Memory Receive].



If your machine displays the [All Settings] menu on the Home screen, skip the [Settings] menu.

2. Press [Off].



The LCD displays options if there are received faxes still in your machine's memory.

3. Press .



Related Information

- [Memory Receive \(Remote Fax\) Options](#)

Print a Fax Stored in the Machine's Memory

If you select [Paging] or [Fax Storage], you can still print a fax from the memory when you are at your machine.

1. Press  [Settings] > [All Settings] > [Fax] > [Print Fax].



If your machine displays the [All Settings] menu on the Home screen, skip the [Settings] menu.

2. Press [Yes].



Related Information

- [Memory Receive \(Remote Fax\) Options](#)
- [Error and Maintenance Messages](#)

Use PC-Fax Receive to Transfer Received Faxes to Your Computer (Windows® only)

Turn on the PC-Fax Receive feature, automatically store incoming faxes to your machine's memory, and then send them to your computer. Use your computer to view and store these faxes.

To transfer the received faxes to your computer you must have the PC-FAX Receiving software running on your computer.

Even if you have turned off your computer (at night or on the weekend, for example), your machine will receive and store your faxes in its memory.

When you start your computer and the PC-FAX Receiving software runs, your machine transfers your faxes to your computer automatically.

If you selected [Backup Print: On], the machine will also print the fax.

1. Press  [Settings] > [All Settings] > [Fax] > [Setup Receive] > [PC Fax Receive].



If your machine displays the [All Settings] menu on the Home screen, skip the [Settings] menu.

2. Press [OK], and then following the LCD instruction.



- Before you can set up PC-Fax Receive, you must install the MFL-Pro Suite software on your computer. Make sure your computer is connected and turned on.
- PC-Fax Receive is not available for the Macintosh operating systems.
- If you get an error message and the machine cannot print the faxes in the memory, you can use this setting to transfer your faxes to your computer.

3. Press [<USB>] or the name of the computer you want to receive faxes if you are on a network, and then press [OK].
4. Press [Backup Print: On] or [Backup Print: Off].
5. Press .



Related Information

- [Memory Receive \(Remote Fax\) Options](#)

Remote Fax Retrieval

Use Remote Retrieval to call your machine from any touch-tone telephone or fax machine, and use a remote access code and remote commands to retrieve fax messages.

- [Set a Remote Access Code](#)
- [Use Your Remote Access Code](#)
- [Forward Faxes Remotely](#)
- [Change the Fax Forwarding Number](#)

Set a Remote Access Code

Set a Remote Access Code to access and control your Brother machine even when you are away from it.

Before you can use the remote access and retrieval features, you must set up your own code. The factory default code is the inactive code (---*).

1. Press  [Settings] > [All Settings] > [Fax] > [Remote Access].



If your machine displays the [All Settings] menu on the Home screen, skip the [Settings] menu.

2. Enter a three-digit code using the numbers [0] to [9], [*] or [#] using the LCD (the preset "*" cannot be changed), and then press [OK].



- DO NOT use the same code used for your Fax Receive Code (*51) or Telephone Answer Code (#51).
- To make your code inactive, press and hold  to restore the inactive setting (---*), and then press [OK].

3. Press .



Related Information

- [Remote Fax Retrieval](#)

Use Your Remote Access Code

1. Dial your fax number from a telephone or another fax machine using touch tone.
2. When your machine answers, immediately enter your Remote Access Code (three digits followed by *).
3. The machine signals if it has received messages:
 - One long beep -- Fax messages
 - No beeps -- No messages
4. When the machine gives two short beeps, enter a command.
 - The machine will hang up if you wait longer than 30 seconds to enter a command.
 - The machine will beep three times if you enter an invalid command.
5. Press 9 0 to reset the machine when you are finished.
6. Hang up.
 - If your machine is set to Manual mode and you want to use the remote retrieval features, wait for about 100 seconds after it starts ringing, and then enter the remote access code within 30 seconds.
 - This function may not be available in some countries or supported by your local telephone company.



Related Information

- [Remote Fax Retrieval](#)

Forward Faxes Remotely

Call your Brother machine from any touch-tone telephone or fax machine to forward incoming faxes to another machine.

You must turn on Fax Storage to use this feature.

1. Dial your fax number.
2. When your machine answers, enter your Remote Access Code (three digits followed by *). If you hear one long beep, you have messages.
3. When you hear two short beeps, press 9 6 2.
4. Wait for the long beep, and then use the dial pad to enter the number of the remote fax machine where you want your fax messages sent, followed by # # (up to 20 digits).



You cannot use * and # as dial numbers. However, press # if you want to create a pause.

5. Hang up after you hear your machine beep. Your machine will call the other fax machine, which will then print your fax messages.



Related Information

- [Remote Fax Retrieval](#)

Change the Fax Forwarding Number

You can change your fax forwarding number from another touch-tone telephone or fax machine.

1. Dial your fax number.
2. When your machine answers, enter your Remote Access Code (three digits followed by *). If you hear one long beep, you have messages.
3. When you hear two short beeps, press 9 5 4.
4. Wait for the long beep, enter the new number (up to 20 digits) of the remote fax machine you want your fax messages forwarded to using the dial pad, then enter # #.

You will hear one long beep.



You cannot use * and # as dial numbers. However, press # if you want to create a pause.

5. When you hear two short beeps, press 9 0 to stop Remote Access when you have finished.
6. Hang up after you hear your machine beep.



Related Information

- [Remote Fax Retrieval](#)

Voice Operations and Fax Numbers

- [Voice Operations](#)
- [Store Fax Numbers](#)
- [Set up Groups for Broadcasting](#)
- [Dial Access Codes and Credit Card Numbers](#)

Voice Operations

- [Send Tone Signals \(For Canada\)](#)
- [Pick up a Voice Call in Fax/Tel Receive Mode](#)
- [Special Line Considerations](#)

Send Tone Signals (For Canada)

If you have a Pulse dialing service, but must send Tone signals (for example, for telephone banking), follow these steps. If you have a Touch Tone service, you will not need this feature to send tone signals.

1. Press  [Fax].
2. Press [Hook].
3. Press # on the machine's LCD.

Any digits dialed after this will send tone signals.

When you are finished with the call, the machine will return to the Pulse dialing service.



Related Information

- [Voice Operations](#)

Pick up a Voice Call in Fax/Tel Receive Mode

When the machine is in Fax/Tel mode, it will use the F/T Ring (pseudo/double-ring) to alert you to pick up a voice call.

If you are at the machine, lift the external telephone's handset, and then press the button in the following table to answer:

Applicable Models	To pick up voice call
MFC-L8610CDW/MFC-L8900CDW	Pickup

If you are at an extension telephone, lift the handset during the F/T Ring and then press #51 between the pseudo/double rings. If no one is on the line, or if someone wants to send you a fax, send the call back to the machine by pressing *51.



Related Information

- [Voice Operations](#)

Special Line Considerations

- [Rollover Telephone Lines](#)
- [Two-Line Telephone System](#)
- [Convert Telephone Wall Outlets](#)
- [Install Your Brother Machine, an External Two-Line TAD and Two-Line Telephone](#)

Rollover Telephone Lines

A rollover telephone system is a group of two or more separate telephone lines that pass incoming calls to each other if they are busy.

This feature is available only in the USA and Canada.

The calls are usually passed down or 'rolled over' to the next available telephone line in a preset order.

Your machine can work in a rollover system only if it is the last number in the sequence, so the call cannot roll away. Do not place the machine on any of the other numbers; when the other lines are busy and a second fax call is received, the fax call would be transferred to a line that does not have a fax machine. **Your machine will work best on a dedicated line.**



Related Information

- [Special Line Considerations](#)
-

Two-Line Telephone System

A two-line telephone system is nothing more than two separate telephone numbers on the same wall outlet.

This feature is available only in the USA and Canada.

The two telephone numbers can be on separate jacks (RJ11) or combined into one jack (RJ14). Your machine must be plugged into an RJ11 jack. RJ11 and RJ14 jacks may be equal in size and appearance and both may contain four wires (black, red, green, yellow). To test the type of jack, plug in a two-line telephone and see if it can access both lines. If it can, you must separate the line for your machine.



Related Information

- [Special Line Considerations](#)

Convert Telephone Wall Outlets

This feature is available only in the USA and Canada.

There are three ways to convert to an RJ11 jack. The first two ways may require assistance from the telephone company. You can change the wall outlets from one RJ14 jack to two RJ11 jacks. Or, you can have an RJ11 wall outlet installed and slave or jump one of the telephone numbers to it.

The third way is the easiest: Buy a triplex adapter. You can plug a triplex adapter into an RJ14 outlet. It separates the wires into two separate RJ11 jacks (Line 1, Line 2) and a third RJ14 jack (Lines 1 and 2). If your machine is on Line 1, plug the machine into L1 of the triplex adapter. If your machine is on Line 2, plug it into L2 of the triplex adapter.

Triplex adapter

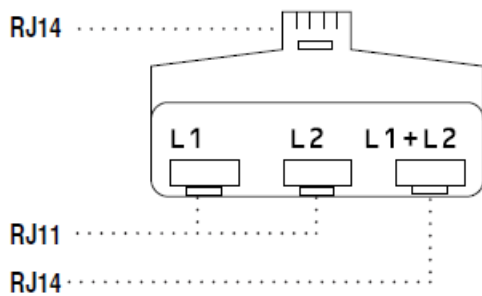

Related Information

- [Special Line Considerations](#)

Install Your Brother Machine, an External Two-Line TAD and Two-Line Telephone

When you are installing an external two-line telephone answering device (TAD) and a two-line telephone, your machine must be isolated on one line at both the wall jack and at the TAD.

- This feature is available only in the USA and Canada.
- The most common connection is to place the machine on Line 2, which is explained in the following steps. The back of the two-line TAD must have two telephone jacks: one labeled L1 or L1/L2, and the other labeled L2. You will need at least three telephone line cords, the one that came with your machine and two for your external two-line TAD. You will need a fourth line cord if you add a two-line telephone.

1. Place the two-line TAD and the two-line telephone next to your machine.
2. Plug one end of the telephone line cord for your machine into the L2 jack of the triplex adapter. Plug the other end into the LINE jack of the machine.
3. Plug one end of the first telephone line cord for your TAD into the L1 jack of the triplex adapter. Plug the other end into the L1 or L1/L2 jack of the two-line TAD.
4. Plug one end of the second telephone line cord for your TAD into the L2 jack of the two-line TAD. Plug the other end into the EXT. jack of the machine.

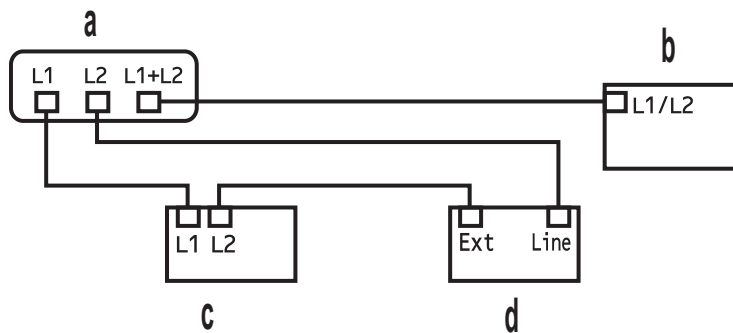

- a. Triplex Adapter
- b. Two Line Telephone
- c. External Two Line TAD
- d. Machine

You can keep two-line telephones on other wall outlets as always. There are ways to add a two-line telephone to the machine's wall outlet. You can plug the telephone line cord from the two-line telephone into the L1+L2 jack of the triplex adapter. Or, you can plug the two-line telephone into the TEL jack of the two-line TAD.

✓ Related Information

- [Special Line Considerations](#)

Store Fax Numbers

- [Store Address Book Numbers](#)
- [Change or Delete Address Book Names or Numbers](#)

Store Address Book Numbers

1. Press  [Fax] > [Address Book].
2. Do the following steps:
 - a. Press [Edit].
 - b. Press [Add New Address].
 - c. Press [Name].
 - d. Enter the name using the LCD (up to 16 characters), and then press [OK].
 - e. Press [Address].
 - f. Enter the fax or telephone number using the LCD (up to 20 digits), and then press [OK].



- To store an email address to use with Internet Fax or Scan to Email server, press  and enter the email address and press [OK].
(On certain models, you must download Internet Fax to use the Internet Fax feature and the Scan to Email server feature.)

- g. Press [OK].

To store another Address Book number, repeat these steps.

3. Press .



Related Information

- [Store Fax Numbers](#)
- [Store Address Book Numbers from Outgoing Calls](#)

Store Address Book Numbers from Outgoing Calls

You can store Address Book numbers from the Outgoing Call history.

1. Press  [Fax] > [Call History] > [Outgoing Call].
2. Swipe up or down or press ▲ or ▼ to display the number you want, and then press it.
3. Press [Edit] > [Add to Address Book] > [Name].



To delete the number, press [Edit] > [Delete]. Press [Yes] to confirm.

4. Enter the name using the LCD (up to 16 characters).
5. Press [OK].
6. Press [OK] to confirm the fax or telephone number you want to store.
7. Press .



Related Information

- [Store Address Book Numbers](#)

Change or Delete Address Book Names or Numbers

1. Press  [Fax] > [Address Book] > [Edit].
2. Do one of the following:
 - Press [Change] to edit the names or fax or telephone numbers.
Swipe up or down or press ▲ or ▼ to display the number you want to change, and then press it.
 - To change the name, press [Name]. Enter the new name (up to 16 characters) using the LCD, and then press [OK].
 - To change the fax or telephone number, press [Address]. Enter the new fax or telephone number (up to 20 digits) using the LCD, and then press [OK].

Press [OK] to finish.



How to enter text:

To change a character, press ◀ or ▶ to position the cursor to highlight the incorrect character, and then press .

Enter the new character.

- To delete numbers, press [Delete].
 - Select the fax or telephone numbers you want to delete by pressing them to display a red check mark, and then press [OK].
3. Press .



Related Information



- [Store Fax Numbers](#)

Set up Groups for Broadcasting

A Group, which can be stored in the Address Book (One Touch Dial or Speed Dial in some models) allows you to send the same fax message to many fax numbers.

First, you must store each fax number in the Address Book. Then you can include them as numbers in the Group. Each Group uses up an Address Book (a One Touch Dial, or a Speed Dial in some models) number.

Applicable Models	Maximum number of Group	Maximum numbers in a large Group
MFC-L8610CDW/MFC-L8900CDW	20 groups	299 numbers

1. Press  [Fax] > [Address Book].
2. Do the following steps:
 - a. Press [Edit] > [Setup Groups] > [Name].
 - b. Enter the Group name (up to 16 characters) using the LCD, and then press [OK].
 - c. Press [Add/Delete].
 - d. Add Address Book numbers to the Group by pressing them to display a red checkmark, and then press [OK].
 - e. Read and confirm the displayed list of names and numbers you have chosen, and then press [OK] to save your Group.To store another Group for broadcasting, repeat these steps.
3. Press .

Related Information

- [Voice Operations and Fax Numbers](#)
- [Change a Broadcasting Group Name](#)
- [Delete a Broadcasting Group](#)
- [Add or Delete a Broadcasting Group Member](#)

Change a Broadcasting Group Name

1. Press  [Fax] > [Address Book] > [Edit] > [Change].
2. Swipe up or down or press ▲ or ▼ to display the Group you want, and then press the Group name.
3. Press [Name].
4. Enter the new Group name (up to 16 characters) using the LCD, and then press [OK].



How to change the stored name:

To change a character, press ◀ or ▶ to position the cursor to highlight the incorrect character, and then press .

Enter the new character.



5. Press [OK].
6. Press .



Related Information

- [Set up Groups for Broadcasting](#)

Delete a Broadcasting Group



1. Press  [Fax] > [Address Book] > [Edit] > [Delete].
2. Swipe up or down or press ▲ or ▼ to display the Group you want, and then press the Group name.
3. Press [OK].
4. Press .



Related Information

- [Set up Groups for Broadcasting](#)

Add or Delete a Broadcasting Group Member

1. Press  [Fax] > [Address Book] > [Edit] > [Change].
2. Swipe up or down or press ▲ or ▼ to display the Group you want, and then press the Group name.
3. Swipe up or down or press ▲ or ▼ to display the [Add/Delete] option, and then press [Add/Delete].
4. Swipe up or down or press ▲ or ▼ to display the number you want to add or delete.
5. Do the following for each number you want to change:
 - To add a number to the Group, press the check box of the number to add a check mark.
 - To delete a number from the Group, press the check box of the number to remove the check mark.
6. Press [OK].
7. Press [OK].
8. Press .



Related Information

- [Set up Groups for Broadcasting](#)

Dial Access Codes and Credit Card Numbers

Sometimes you may want to choose from several long-distance carriers when you send a fax. Rates may vary depending on the time and destination. To take advantage of low rates, you can store the access codes of long-distance carriers and credit card numbers as Address Book numbers.

You can store these long dialing sequences by dividing them and setting them up as separate Address Book numbers in any combination. You can even include manual dialing using the dial pad.

For example: You might have stored '555' and '7000' in your machine as shown in the following table.

Applicable Models	'555' stored in	'7000' stored in
MFC-L8610CDW/MFC-L8900CDW	Address Book: Brother 1	Address Book: Brother 2

You can use them both to dial '555-7000' by using the following procedure.

1. Press  [Fax] > [Address Book].
2. Swipe up or down or press ▲ or ▼ to display the number of Brother 1.
3. Press the number.
4. Press [Apply].
5. Press [Address Book].
6. Press [OK].
7. Swipe up or down or press ▲ or ▼ to display the number of Brother 2.
8. Press the number.
9. Press [Apply].
10. Press [Fax Start].

The machine will dial '555-7000'.

To temporarily change a number, you can substitute part of the number by pressing it using the LCD. For example, to change the number to '555-7001', you could enter the number (Brother 1: 555) using Address Book, press [Apply], and then press 7001 using the LCD.



If you must wait for another dial tone or signal at any point in the dialing sequence, create a pause in the number by pressing [Pause].



Related Information

- [Voice Operations and Fax Numbers](#)

Telephone Services and External Devices

- [Voice Mail](#)
- [Distinctive Ring](#)
- [External TAD \(Telephone Answering Device\)](#)
- [External and Extension Telephones](#)
- [Multi-line Connections \(PBX\)](#)

Voice Mail

This feature is available only in the USA and Canada.

If you have Voice Mail on the same telephone line as your Brother machine, Voice Mail and the Brother machine will conflict with each other when receiving incoming calls.

For example, if your Voice Mail is set to answer after four rings and your Brother machine is set to answer after two rings, then your Brother machine will answer first. This will prevent callers from being able to leave a message in your Voice Mail.

Similarly, if your Brother machine is set to answer after four rings and your Voice Mail is set to answer after two rings, then your Voice Mail will answer first. This will prevent your Brother machine from being able to receive an incoming fax, since Voice Mail cannot transfer the incoming fax back to the Brother machine.

To avoid conflicts between your Brother machine and your Voice Mail service, do one of the following:

- Get the Distinctive Ring service from your telephone company. Distinctive Ring is a feature of your Brother machine that allows a person with one line to receive fax and voice calls through two different telephone numbers on that one line.

Brother uses the term 'Distinctive Ring,' but telephone companies market the service under a variety of names, such as Custom Ringing, Personalized Ring, Smart Ring, Ident-A-Ring, Ident-A-Call, Data Ident-A-Call, Teen Ring, and SimpleBiz Fax & Alternate Number Ringing. This service establishes a second telephone number on the same line as your existing telephone number, and each number has its own ring pattern. Typically, the original number rings with the standard ring pattern and is used for receiving voice calls, and the second number rings with a different ring pattern and is used for receiving faxes.

- Set your Brother machine's Receive Mode to "Manual". Manual Mode requires you answer every incoming call if you want to be able to receive a fax. If the incoming call is a telephone call, then complete the call as you normally would. If you hear fax sending tones you must transfer the call to the Brother machine.

Unanswered fax and voice calls will go to your Voice Mail.



Related Information

- [Telephone Services and External Devices](#)
- [Telephone and Fax Problems](#)

Distinctive Ring

This feature is available only in the USA and Canada.

Distinctive Ring is a function of your Brother machine that allows a person with one line to receive fax and voice calls through two different phone numbers on that one line. Brother uses the term "Distinctive Ring," but telephone companies market the service under a variety of names, such as Custom Ringing, Personalized Ring, Smart Ring, Ident-A-Ring, Ident-A-Call, Data Ident-A-Call, Teen Ring, and SimpleBiz Fax & Alternate Number Ringing. This service establishes a second telephone number on the same line as your existing telephone number, and each number has its own ring pattern. Typically, the original number rings with the standard ring pattern and is used for receiving voice calls, and the second number rings with a different ring pattern and is used for receiving faxes.



- You must pay for your telephone company's Distinctive Ring service before you program the machine to work with it.
- Contact your telephone company for availability and rates.

What does your telephone company's 'Distinctive Ring' do?

Your telephone company's Distinctive Ring service allows you to have more than one number on the same telephone line. **If you need more than one telephone number, it is cheaper than paying for an extra line.** Each telephone number has its own distinctive ring pattern, so you will know which telephone number is ringing. This is one way to have a separate telephone number for your machine.



Contact your telephone company for availability and rates.

What does Brother's 'Distinctive Ring' do?

The Brother machine has a Distinctive Ring feature that allows you to use your machine to take full advantage of the telephone company's Distinctive Ring service. The new telephone number on your line can only receive faxes.



You must pay for your telephone company's Distinctive Ring service before you program the machine to work with it.

Do you have Voice Mail?

If you have Voice Mail on the telephone line where you will install your new machine, there is a strong possibility that Voice Mail and the machine will conflict with each other while receiving incoming calls. **However, the Distinctive Ring feature allows you to use more than one number on your line, so both Voice Mail and the machine can work together without any problems.** If each one has a separate telephone number, neither will interfere with the other's operations.



If you decide to get the Distinctive Ring service from the telephone company, you must register the new Distinctive Ring pattern they give you. This is so your machine can recognize its incoming calls.





You can change or cancel the Distinctive Ring pattern at any time. You can switch it off temporarily, and turn it back on later. When you get a new fax number, make sure you reset this feature.

Before you choose the ring pattern to register

You can register only one Distinctive Ring pattern with the machine. Some ring patterns cannot be registered. The ring patterns below are supported by your Brother machine. Register the one your telephone company gives you.

Ring Pattern	Rings	
1	short-short or long-long	
2	short-long-short	

Ring Pattern	Rings	
3	short-short-long	
4	very long (normal pattern)	



- Ring Pattern #1 is often called Short-Short and is the most commonly used.
- If the ring pattern you received is not on this chart, **contact your telephone company and ask for one that is shown.**

- The machine will answer only calls to its registered number.
- The first two rings are silent on the machine. This is because the fax must <<listen>> to the ring pattern (to compare it to the pattern that was 'registered'). (Other telephones on the same line will ring.)
- If you program the machine correctly, it will recognize the registered ring pattern of the 'fax number' within two ring patterns and then answer with a fax tone. When the 'voice number' is called, the machine will not answer.



Related Information

- [Telephone Services and External Devices](#)
- [Register the Distinctive Ring Pattern](#)
- [Turn Off Distinctive Ring](#)
- [Telephone and Fax Problems](#)

Register the Distinctive Ring Pattern

This feature is available only in the USA and Canada.

After you set the Distinctive Ring feature to [On], your Distinctive Ring number will receive faxes automatically. The receive mode is automatically set to [Manual] and you cannot change it to another receive mode while Distinctive Ring is set to [On]. This ensures the Brother machine will only answer the Distinctive Ring number and not interfere when your main telephone number is called.

When Distinctive Ring is on, the LCD displays [D/R] as the Receive Mode.

1. Press  [Settings] > [All Settings] > [Fax] > [Miscellaneous] > [Distinctive].



If your machine displays the [All Settings] menu on the Home screen, skip the [Settings] menu.

2. Do one of the following:
 - If you have not registered the Distinctive Ring pattern, press [Distinctive], and then press [On].
 - If you have already registered the Distinctive Ring pattern, and want to change the pattern, proceed to Ring Pattern setting.
3. Press [Ring Pattern].
4. Press the stored ring pattern you want, and then press [OK].

You will hear each pattern as you press the four buttons. Make sure you select the pattern that the telephone company gave you.

5. Press .

Distinctive Ring is now set to [On].



If you do not want to receive faxes on your Distinctive Ring number, you can turn off Distinctive Ring. The machine will stay in [Manual] receive mode so you must set the Receive Mode again.



Related Information

- [Distinctive Ring](#)

Turn Off Distinctive Ring

This feature is available only in the USA and Canada.

1. Press  [Settings] > [All Settings] > [Fax] > [Miscellaneous] > [Distinctive] > [Distinctive].



If your machine displays the [All Settings] menu on the Home screen, skip the [Settings] menu.

2. Press [Off].
3. Press .

If you turn off Distinctive Ring, the machine will stay in Manual Mode. You must set the Receive Mode again.



Related Information

- [Distinctive Ring](#)

External TAD (Telephone Answering Device)

You can connect an external Telephone Answering Device (TAD) to the same line as your machine. When the TAD answers a call, your machine will “listen” for the CNG (fax calling) tones sent by a sending fax machine. If it hears them it will take over the call and receive the fax. If it does not hear them, it will let your TAD take a voice message and the LCD will show [Telephone].

The external TAD must answer within four rings (we recommend setting it to two rings). This is because your machine cannot hear the CNG tones until the external TAD has picked up the call. The sending machine will send CNG tones for only eight to ten seconds longer. We do not recommend using the toll saver feature on your external TAD if it needs more than four rings to activate it.

Unless you are using Distinctive Ring, the TAD must be connected to the EXT. jack of the machine.

- **If you subscribe to your telephone company’s Distinctive Ring service:**

You may connect an external TAD to a separate wall jack only if you subscribe to your telephone company’s Distinctive Ring service, have registered the distinctive ring pattern on your machine, and use that number as a fax number. The recommended setting is at least four rings on the external TAD when you have the telephone company’s Distinctive Ring service. You cannot use the Toll Saver setting.

- **If You Do Not Subscribe to the Distinctive Ring Service:**

You must plug your TAD into the EXT. jack of your machine. If your TAD is plugged into a wall jack, both your machine and the TAD will try to control the telephone line. (See the illustration.)

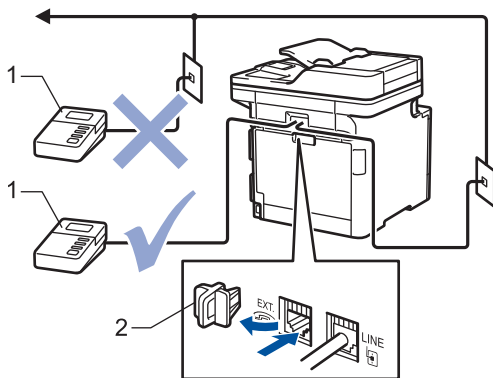

- 1 TAD
- 2 Protective Cap

IMPORTANT

DO NOT connect a TAD elsewhere on the same telephone line.



If you have problems receiving faxes, reduce the Ring Delay setting on your external TAD.



Related Information

- [Telephone Services and External Devices](#)
- [Connect an External TAD](#)
- [Record an Outgoing Message \(OGM\) on the External TAD](#)

Connect an External TAD

The external TAD must be plugged into the back of the machine, into the jack labeled EXT. Your machine cannot work correctly if you plug the TAD into a wall jack (unless you are using Distinctive Ring).

1. Plug the telephone line cord from the telephone wall jack into the back of the machine, in the jack labeled LINE.
2. Plug the telephone line cord from your external TAD into the back of the machine, in the jack labeled EXT. (Make sure this cord is connected to the TAD at the TAD's telephone line jack, and not its handset jack.)
3. Set your external TAD to four rings or less. (The machine's Ring Delay setting does not apply.)
4. Record an outgoing message on your external TAD.
5. Set the TAD to answer calls.
6. Set the Receive Mode on your machine to [External TAD].



Related Information

- [External TAD \(Telephone Answering Device\)](#)

Record an Outgoing Message (OGM) on the External TAD

1. Record 5 seconds of silence at the beginning of your message. This allows your machine time to listen for fax tones.
2. Limit your speaking to 20 seconds.
3. End your 20-second message by giving your Fax Receive Code for people sending manual faxes. For example: "After the beep, leave a message or press *51 and Start to send a fax."

NOTE

We recommend beginning your OGM with an initial 5 second silence because the machine cannot hear fax tones over a loud voice. You may try leaving out this pause, but if your machine has trouble receiving faxes, then you should re-record the OGM to include it.



Related Information

- [External TAD \(Telephone Answering Device\)](#)

External and Extension Telephones

- [Connect an External or Extension Telephone](#)
- [Operation from External and Extension Telephones](#)
- [If You Use a Non-Brother Cordless External Handset](#)
- [Use the Remote Codes](#)

Connect an External or Extension Telephone

You can connect a separate telephone to your machine as shown in the diagram below.

Connect the telephone line cord to the jack labeled EXT.

Before you connect an external telephone, remove the protective cap (3) from the EXT. jack on the machine.

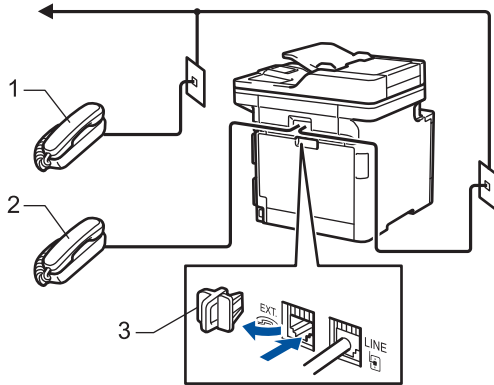

- 1 Extension telephone
- 2 External telephone
- 3 Protective Cap

✓ Related Information

- [External and Extension Telephones](#)

Operation from External and Extension Telephones

Use extension telephones

If you answer a fax call at an extension telephone, you can make your machine receive the fax by pressing the Fax Receive Code ***51**.

If the machine answers a voice call and pseudo/double-rings for you to take over, you can take the call at an extension telephone by pressing the Telephone Answer Code **#51**.

Use an external telephone (Connected to the EXT. jack of the machine)

If you answer a fax call at the external telephone connected to the EXT. jack of the machine, you can make the machine receive the fax by pressing [Fax Start] or **Start**, and selecting [Receive] or **2**.

If the machine answers a voice call and pseudo/double-rings for you to take over, you can take the call at the external telephone by pressing [Pickup] or **Hook**.

If you answer a call and no one is on the line:

You should assume that you're receiving a manual fax.

Press ***51** and wait for the chirp or until the LCD displays [Receiving], and then hang up.



You can also use the Easy Receive feature to make your machine automatically take the call.



Related Information

- [External and Extension Telephones](#)

If You Use a Non-Brother Cordless External Handset

If your non-Brother cordless telephone is connected to the EXT. jack of the machine and you typically carry the cordless handset elsewhere, it is easier to answer calls during the Ring Delay.

If you let the machine answer first, you must go to the machine so you can press [Pickup] or **Hook** to transfer the call to the cordless handset.



Related Information

- [External and Extension Telephones](#)

Use the Remote Codes

Fax Receive Code

If you answer a fax call on an extension telephone, you can tell your machine to receive it by pressing the Fax Receive Code ***51**. Wait for the chirping sounds, and then replace the handset.

If you answer a fax call at the external telephone, you can make the machine receive it by pressing the buttons in the following table:

Applicable Models	To make the machine receive the fax
MFC-L8610CDW/MFC-L8900CDW	Fax Start and then Receive

Telephone Answer Code

If you receive a voice call and the machine is in F/T mode, it will start to sound the F/T ring (pseudo/double-ring) after the initial ring delay. If you pick up the call on an extension telephone you can turn the F/T ring off by pressing **#51** (make sure you press this between the rings).

If the machine answers a voice call and pseudo/double-rings for you to take over, you can take the call at the external telephone by pressing the button in the following table:

Applicable Models	To pick up voice call
MFC-L8610CDW/MFC-L8900CDW	Pickup



Related Information

- [External and Extension Telephones](#)
- [Change the Remote Codes](#)

Change the Remote Codes

The preset Fax Receive Code is *51. The preset Telephone Answer Code is #51. If you are always disconnected when accessing your External TAD remotely, try changing the three-digit remote codes, for example to ### and 999.

1. Press  [Settings] > [All Settings] > [Fax] > [Setup Receive] > [Remote Codes].



If your machine displays the [All Settings] menu on the Home screen, skip the [Settings] menu.

2. Do one of the following:
 - To change the Fax Receive Code, press [Fax Receive Code]. Enter the new code, and then press [OK].
 - To change the Telephone Answer Code, press [Tel Answer]. Enter the new code, and then press [OK].
 - If you do not want to change the Codes, go to the next step.
 - To turn off (or turn on) the Remote Codes, press [Remote Codes], and then press [Off] (or [On]).
3. Press .



Related Information

- [Use the Remote Codes](#)

Multi-line Connections (PBX)

We suggest you ask the company that installed your PBX to connect your machine. If you have a multi line system we suggest you ask the installer to connect the unit to the last line on the system. This prevents the machine being activated each time the system receives telephone calls. If all incoming calls will be answered by a switchboard operator we recommend setting the Receive Mode to `[Manual]`.

We cannot guarantee that your machine will operate correctly under all circumstances when connected to a PBX. Any difficulties with sending or receiving faxes should be reported first to the company that handles your PBX.



Related Information

- [Telephone Services and External Devices](#)
-

Fax Reports

The Transmission Verification Report and the Fax Journal are available to confirm the results of fax transmission.

- [Print a Transmission Verification Report](#)
- [Print a Fax Journal](#)

Print a Transmission Verification Report

You can use the Transmission Verification Report as proof that you sent a fax. This report lists the receiving party's name or fax number, the time and date of transmission, duration of transmission, number of pages sent, and whether or not the transmission was successful.

There are several settings available for the Transmission Verification Report:

On	Prints a report after every fax you send.
On (+Image)	Prints a report after every fax you send. A portion of the fax's first page appears on the report.
Error only	Prints a report if your fax is unsuccessful due to a transmission error. Error only is the factory setting.
Error only (+Image)	Prints a report if your fax is unsuccessful due to a transmission error. A portion of the fax's first page appears on the report.
Off	Your Brother machine does not print any reports after sending faxes.

1. Press  [Settings] > [All Settings] > [Fax] > [Report Setting] > [Transmission].



If your machine displays the [All Settings] menu on the Home screen, skip the [Settings] menu.

2. Press the option you want.
If you select [On (+Image)] or [Error only (+Image)], the image will not appear on the Transmission Verification Report if Real Time Transmission is set to [On].
 3. Press .
- If the transmission is successful, OK appears next to RESULT on the Transmission Verification Report. If the transmission is not successful, NG appears next to RESULT.



Related Information

- [Fax Reports](#)

Print a Fax Journal

You can set the machine to print a Fax Journal at specific intervals (every 50 faxes, 6, 12 or 24 hours, 2 or 7 days).

1. Press  [Settings] > [All Settings] > [Fax] > [Report Setting] > [Journal Period] > [Journal Period].



If your machine displays the [All Settings] menu on the Home screen, skip the [Settings] menu.

2. Swipe up or down or press ▲ or ▼ to select an interval, and then press it.
 - Every 6, 12, 24 hours, 2 or 7 days
The machine will print the report at the selected time and then erase all reception and transmission log data from its memory. If the machine's memory becomes full with 200 log data before the time you selected has passed, the machine will print the Journal early and then erase all jobs from the memory. If you want an extra report before it is due to print, you can print it without erasing the log data from the memory.
 - Every 50 Faxes
The machine will print the Journal when the machine has stored 50 reception and transmission log data.
3. If you selected every 6, 12, 24 hours, 2 or 7 days, do one of the following to enter the time to start printing:
 - If you set [12h Clock] as the format in the [Clock Type] setting, press [Time]. Enter the time (in 12-hour format) using the LCD, and then press [AM] or [PM].
Press [OK].
 - If you set [24h Clock] in the [Clock Type] setting, press [Time], and then enter the time (in 24-hour format) using the LCD.
Press [OK].
(For example: enter 19:45 for 7:45 PM.)
4. If you selected [Every 7 Days], press [Day].
5. Swipe up or down or press ▲ or ▼ to display the [Every Monday], [Every Tuesday], [Every Wednesday], [Every Thursday], [Every Friday], [Every Saturday] or [Every Sunday] option, and then press the first day of the 7-day countdown.
6. Press .



Related Information

- [Fax Reports](#)

PC-FAX

- [PC-FAX for Windows®](#)
- [PC-FAX for Macintosh](#)

PC-FAX for Windows®

- [PC-FAX Overview \(Windows®\)](#)
- [Send a Fax Using PC-FAX \(Windows®\)](#)
- [Receive Faxes on Your Computer \(Windows®\)](#)

PC-FAX Overview (Windows®)

Reduce paper consumption and save time by using Brother's PC-FAX software to send faxes directly from your machine.

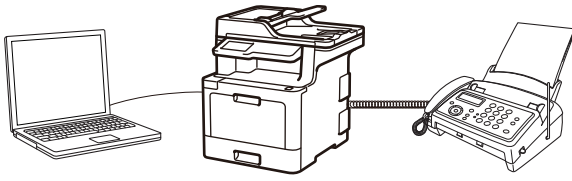

- [Configure PC-FAX \(Windows®\)](#)
- [Configure your PC-Fax Address Book \(Windows®\)](#)

Configure PC-FAX (Windows®)

Before sending faxes using PC-FAX, personalize the send options in each tab of the **PC-FAX Setup** dialog box.

1. Do one of the following:

- Windows® 7

Click  (**Start**) > **All Programs** > **Brother** > **Brother Utilities**.

Click the drop-down list and select your model name (if not already selected). Click **PC-FAX** in the left navigation bar, and then click **Setup Sending**.

- Windows® 8 and Windows® 10

Launch  (**Brother Utilities**), and then click the drop-down list and select your model name (if not already selected). Click **PC-FAX** in the left navigation bar, and then click **Setup Sending**.

The **PC-FAX Setup** dialog box appears.

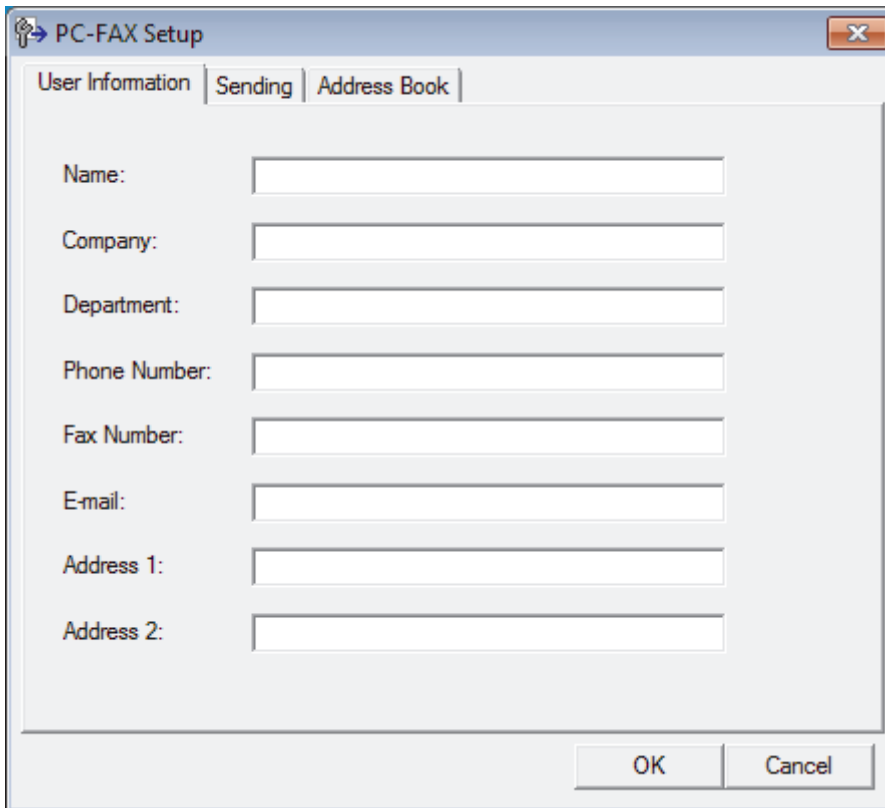

2. Do one of the following:

- Click the **User Information** tab, and then type your user information in the fields.



Each Microsoft® account can have its own customized **User Information** screen for custom fax headers and cover pages.

- Click the **Sending** tab, and then type the number needed to access an outside line (if needed) in the **Outside line access** field. Select the **Include header** check box to include the header information.
- Click the **Address Book** tab, and then select the address book you want to use for PC-FAX from the **Select Address Book** drop-down list.

3. Click **OK**.



Related Information

- [PC-FAX Overview \(Windows®\)](#)

Configure your PC-Fax Address Book (Windows®)

Add, edit and delete members and groups to personalize your Brother **Address Book**.

- [Add a Member to your PC-FAX Address Book \(Windows®\)](#)
- [Create a Group in your PC-FAX Address Book \(Windows®\)](#)
- [Edit Member or Group Information in your PC-FAX Address Book \(Windows®\)](#)
- [Delete a Member or Group in your PC-FAX Address Book \(Windows®\)](#)
- [Export your PC-FAX Address Book \(Windows®\)](#)
- [Import Information to your PC-FAX Address Book \(Windows®\)](#)

Add a Member to your PC-FAX Address Book (Windows®)

Add new people and their fax information to the PC-Fax Address Book if you want to send a fax using Brother PC-Fax software.

1. Do one of the following:

- Windows® 7

Click  (**Start**) > **All Programs** > **Brother** > **Brother Utilities**.

Click the drop-down list and select your model name (if not already selected). Click **PC-FAX** in the left navigation bar, and then click **Address Book (Send)**.

- Windows® 8 and Windows® 10

Launch  (**Brother Utilities**), and then click the drop-down list and select your model name (if not already selected). Click **PC-FAX** in the left navigation bar, and then click **Address Book (Send)**.

The **Address Book** dialog box appears.

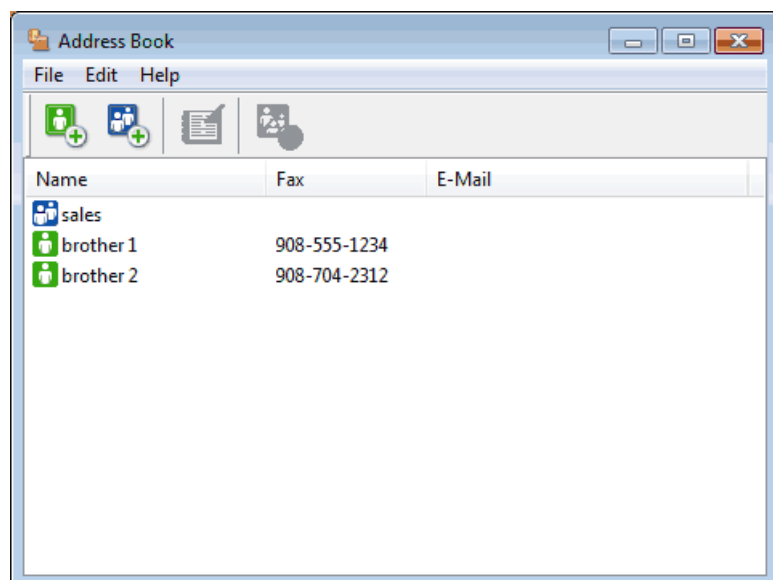

2. Click .

The **Address Book Member Setup** dialog box appears.

Address Book Member Setup

Name: Title:

Company:

Department: Job Title:

Street Address:

City: State/Province:

Zip Code/Post Code: Country/Region:

Business Phone: Home Phone:

Fax: Mobile Phone:

E-Mail:

OK Cancel

3. Type the member's information in the corresponding fields. Only the **Name** field is required.
4. Click **OK**.



Related Information

- [Configure your PC-Fax Address Book \(Windows®\)](#)

Create a Group in your PC-FAX Address Book (Windows®)

Create a group to broadcast the same PC-FAX to several recipients at one time.

1. Do one of the following:

- Windows® 7

Click  (**Start**) > **All Programs** > **Brother** > **Brother Utilities**.

Click the drop-down list and select your model name (if not already selected). Click **PC-FAX** in the left navigation bar, and then click **Address Book (Send)**.

- Windows® 8 and Windows® 10

Launch  (**Brother Utilities**), and then click the drop-down list and select your model name (if not already selected). Click **PC-FAX** in the left navigation bar, and then click **Address Book (Send)**.

The **Address Book** dialog box appears.

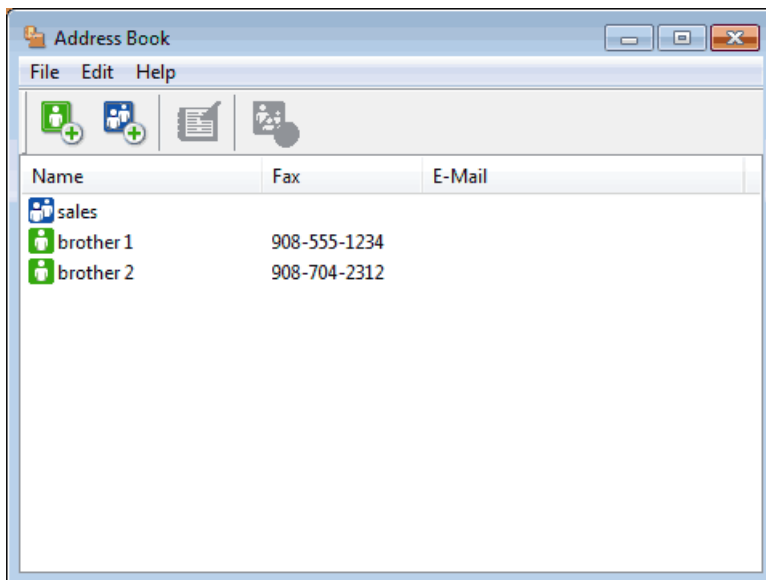

2. Click .

The **Address Book Group Setup** dialog box appears.

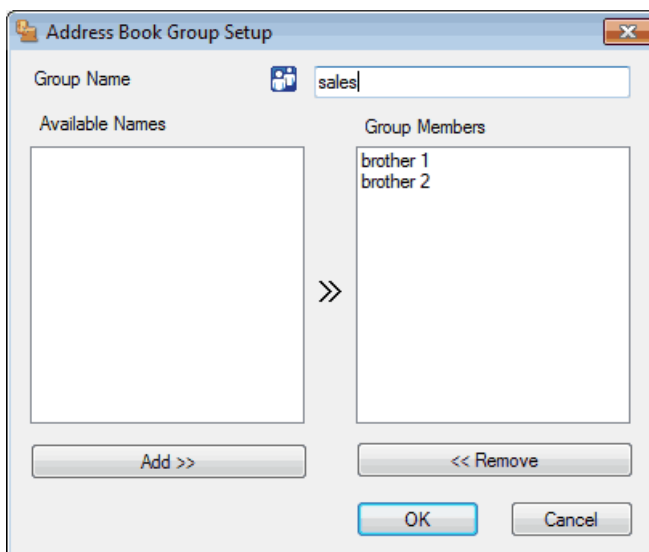

3. Type the name of the new group in the **Group Name** field.

4. In the **Available Names** field, select each name you want to include in the group, and then click **Add >>**.

Members added to the group appear in the **Group Members** box.

5. When finished, click **OK**.



Each group can contain up to 50 members.



Related Information

- [Configure your PC-Fax Address Book \(Windows®\)](#)
-

Edit Member or Group Information in your PC-FAX Address Book (Windows®)

1. Do one of the following:

- Windows® 7

Click  (**Start**) > **All Programs** > **Brother** > **Brother Utilities**.

Click the drop-down list and select your model name (if not already selected). Click **PC-FAX** in the left navigation bar, and then click **Address Book (Send)**.

- Windows® 8 and Windows® 10

Launch  (**Brother Utilities**), and then click the drop-down list and select your model name (if not already selected). Click **PC-FAX** in the left navigation bar, and then click **Address Book (Send)**.

The **Address Book** dialog box appears.

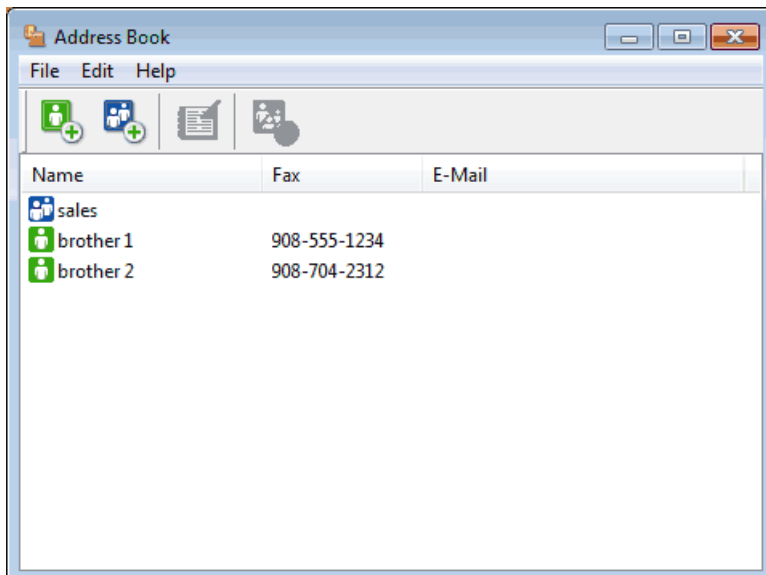

2. Select the member or group you want to edit.
3. Click  (**Properties**).
4. Change the member or group information.
5. Click **OK**.

Related Information

- [Configure your PC-Fax Address Book \(Windows®\)](#)

Delete a Member or Group in your PC-FAX Address Book (Windows®)

1. Do one of the following:

- Windows® 7

Click  (**Start**) > **All Programs** > **Brother** > **Brother Utilities**.

Click the drop-down list and select your model name (if not already selected). Click **PC-FAX** in the left navigation bar, and then click **Address Book (Send)**.

- Windows® 8 and Windows® 10

Launch  (**Brother Utilities**), and then click the drop-down list and select your model name (if not already selected). Click **PC-FAX** in the left navigation bar, and then click **Address Book (Send)**.

The **Address Book** dialog box appears.

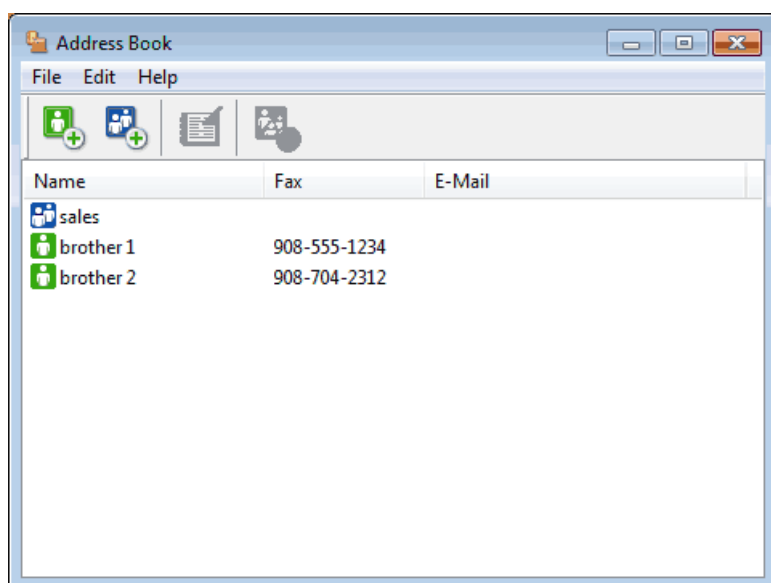

2. Select the member or group you want to delete.

3. Click  (**Delete**).

4. When the confirmation dialog box appears, click **OK**.



Related Information

- [Configure your PC-Fax Address Book \(Windows®\)](#)

Export your PC-FAX Address Book (Windows®)

You can export the Address Book as an ASCII text file (*.csv), a vCard (an electronic business card), or **Remote Setup Dial Data** and save it on your computer.

- You cannot export the group settings when you export the **Address Book** data.

1. Do one of the following:

- Windows® 7

Click  (**Start**) > **All Programs** > **Brother** > **Brother Utilities**.

Click the drop-down list and select your model name (if not already selected). Click **PC-FAX** in the left navigation bar, and then click **Address Book (Send)**.

- Windows® 8 and Windows® 10

Launch  (**Brother Utilities**), and then click the drop-down list and select your model name (if not already selected). Click **PC-FAX** in the left navigation bar, and then click **Address Book (Send)**.

The **Address Book** dialog box appears.

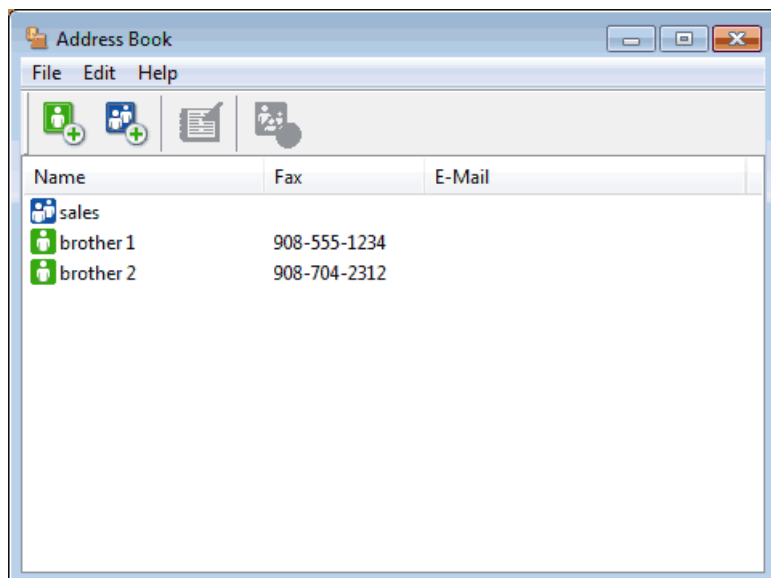

2. Click the **File** menu, and then select **Export**.

3. Select one of the following:

- Text**

The **Select Items** dialog box appears. Go to step 4.

- vCard**

You must select the member you want to export from your address book before selecting this option.

Browse to the folder where you want to save the vCard, type the vCard name in the **File name** field, and then click **Save**.

- Remote Setup Dial Data**

Browse to the folder where you want to save the data, type the file name in the **File name** field, and then click **Save**.

4. In the **Available Items** field, select the data you want to export, and then click **Add >>**.

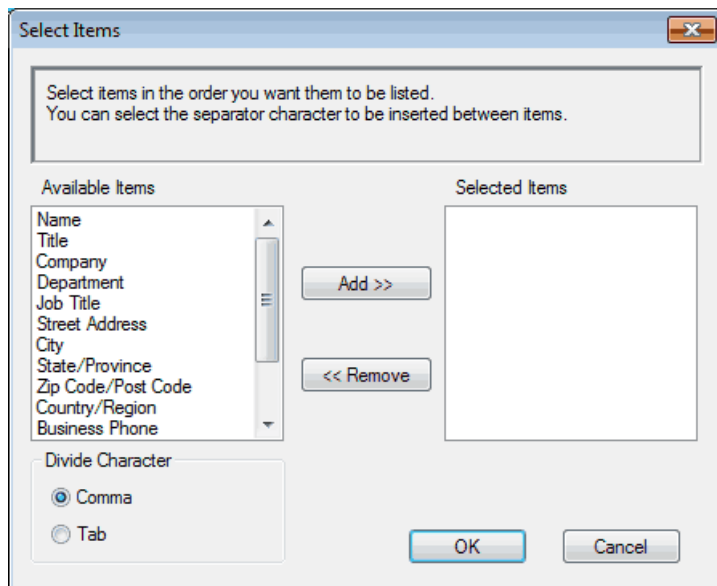

Select and add the items in the order you want them listed.

5. If you are exporting to an ASCII file, under the **Divide Character** section, select the **Tab** or **Comma** option to separate the data fields.
6. Click **OK**.
7. Browse to the folder on your computer where you want to save the data, type the file name, and then click **Save**.



Related Information

- [Configure your PC-Fax Address Book \(Windows®\)](#)

Import Information to your PC-FAX Address Book (Windows®)

You can import ASCII text files (*.csv), vCards (electronic business cards), or **Remote Setup Dial Data** into your Address Book.

1. Do one of the following:

- Windows® 7

Click  (**Start**) > **All Programs** > **Brother** > **Brother Utilities**.

Click the drop-down list and select your model name (if not already selected). Click **PC-FAX** in the left navigation bar, and then click **Address Book (Send)**.

- Windows® 8 and Windows® 10

Launch  (**Brother Utilities**), and then click the drop-down list and select your model name (if not already selected). Click **PC-FAX** in the left navigation bar, and then click **Address Book (Send)**.

The **Address Book** dialog box appears.

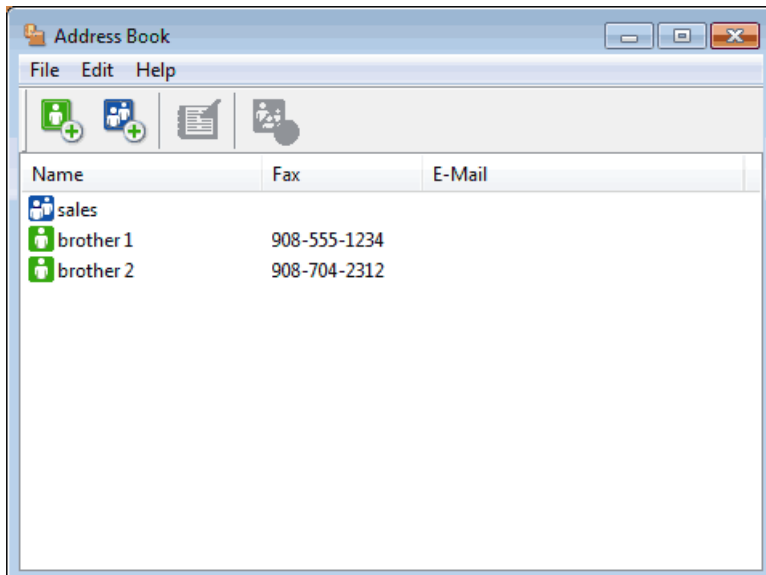

2. Click the **File** menu, and then select **Import**.

3. Select one of the following:

- Text**

The **Select Items** dialog box appears. Go to step 4.

- vCard**

Go to step 7.

- Remote Setup Dial Data**

Go to step 7.

4. In the **Available Items** field, select the data you want to import, and then click **Add >>**.

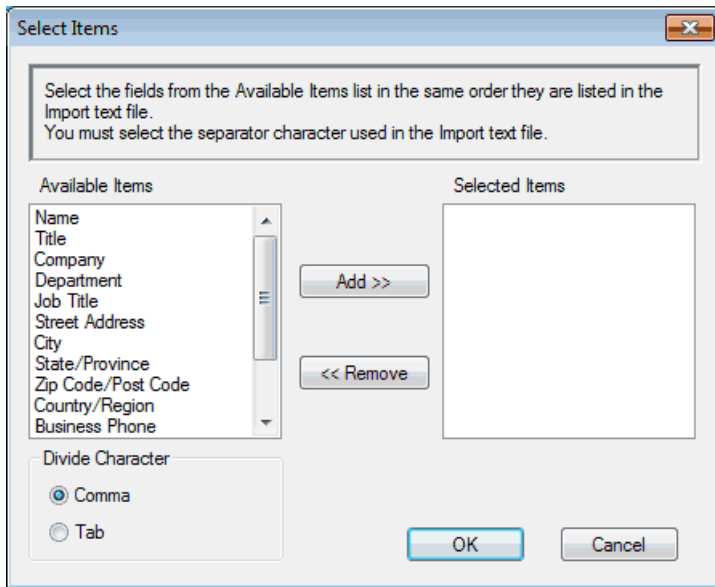

You must select and add fields from the **Available Items** list in the same order they are listed in the import text file.

5. If you are importing an ASCII file, under the **Divide Character** section, select the **Tab** or **Comma** option to separate the data fields.
6. Click **OK**.
7. Browse to the folder where you want to import the data, type the file name, and then click **Open**.

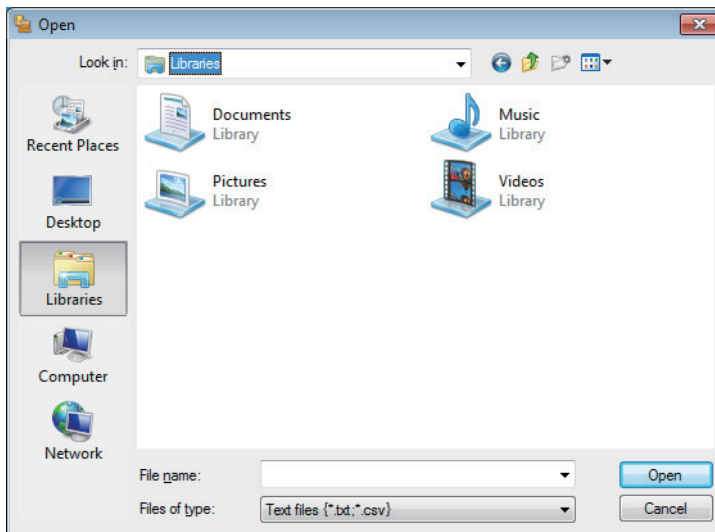

Related Information

- [Configure your PC-Fax Address Book \(Windows®\)](#)

Send a Fax Using PC-FAX (Windows®)

PC-FAX supports only black and white faxes. A black and white fax will be sent even if the original data is color and the receiving fax machine supports color faxes.

1. Create a file in any application on your computer.
2. Select the print command in your application.
3. Select **Brother PC-FAX** as your printer, and then complete your print operation.

The **BrotherPC-FAX** dialog box appears.

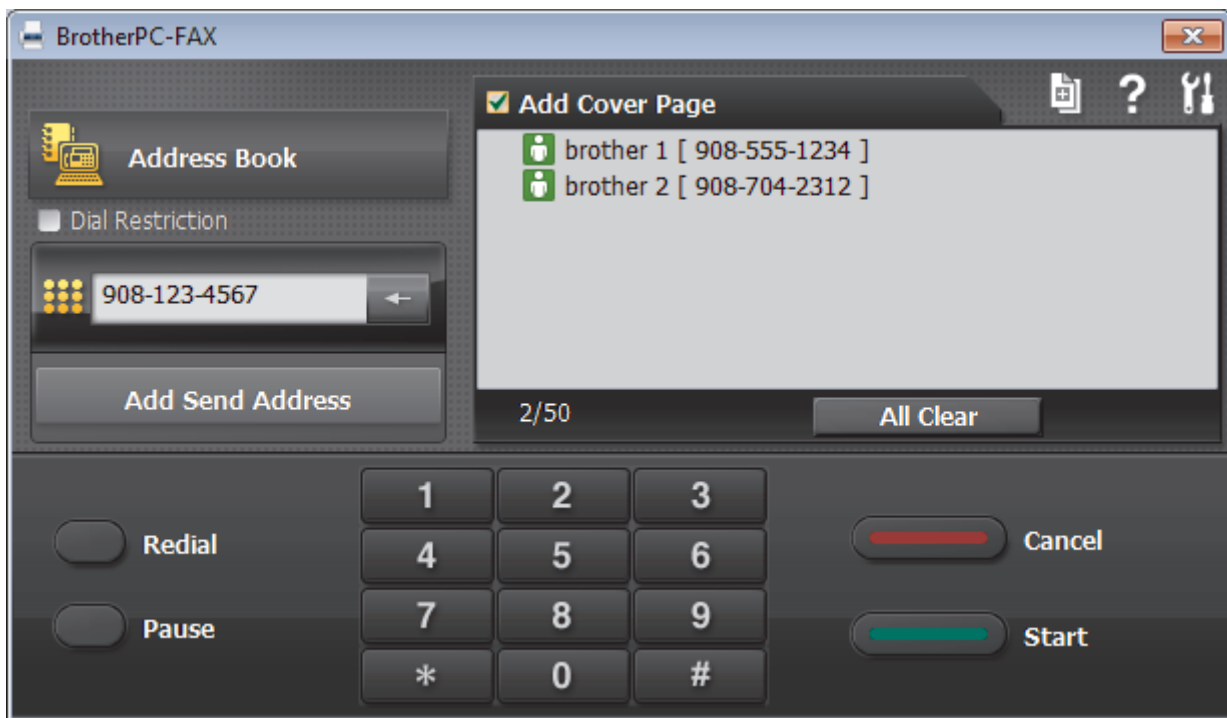



4. Type a fax number using one of the following methods:
 - Click the numbers on the dial pad to type the number, and then click **Add Send Address**.

 If you select the **Dial Restriction** check box, a confirmation dialog box will appear for you to re-type the fax number using the keyboard. This feature helps to prevent transmissions to the wrong destination.

- Click the **Address Book** button, and then select a member or group from the Address Book.

 If you make a mistake, click **All Clear** to delete all entries.

5. To include a cover page, select the **Add Cover Page** check box. You can also click  to create or edit a cover page.
6. Click **Start** to send the fax.

 To cancel the fax, click **Cancel**.

- To redial a number, click **Redial** to show the last five fax numbers, select a number, and then click **Start**.

Related Information

- [PC-FAX for Windows®](#)

Receive Faxes on Your Computer (Windows®)

Use Brother's PC-FAX software to receive faxes on your computer, screen them and print only those faxes you want.

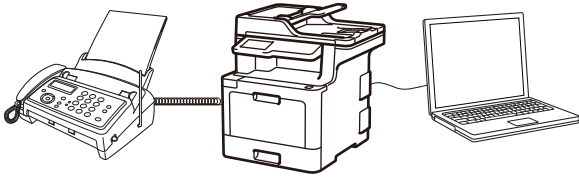

- [Receive Faxes Using PC-FAX Receive \(Windows®\)](#)

Receive Faxes Using PC-FAX Receive (Windows®)

Brother's PC-FAX Receive software lets you view and store faxes on your computer. It is automatically installed when you install the Brother software and drivers and works on locally- or network-connected machines.

- PC-FAX Receive supports only black and white faxes.

When you turn off your computer, your machine will continue to receive and store faxes in your Brother machine's memory. The machine's LCD will display the number of stored faxes received. When you start this application, the software will transfer all received faxes to your computer at once. You can enable the Backup Print option if you want the machine to print a copy of the fax before the fax is sent to your computer, or before the computer is switched off. You can configure the Backup Print settings from your Brother machine.

✓ Related Information

- [Receive Faxes on Your Computer \(Windows®\)](#)
- [Run Brother's PC-FAX Receive on Your Computer \(Windows®\)](#)
- [View Received PC-FAX Messages \(Windows®\)](#)

Home > Fax > PC-FAX > PC-FAX for Windows® > Receive Faxes on Your Computer (Windows®)
> Receive Faxes Using PC-FAX Receive (Windows®) > Run Brother's PC-FAX Receive on Your Computer (Windows®)

Run Brother's PC-FAX Receive on Your Computer (Windows®)



We recommend selecting the **Start PC-FAX Receive on computer startup** check box so that the software runs automatically and can transfer any faxes upon computer startup.

1. Do one of the following:

- Windows® 7

Click  (**Start**) > **All Programs** > **Brother** > **Brother Utilities**.

Click the drop-down list and select your model name (if not already selected). Click **PC-FAX** in the left navigation bar, and then click **Receive**.

- Windows® 8 and Windows® 10

Launch  (**Brother Utilities**), and then click the drop-down list and select your model name (if not already selected). Click **PC-FAX** in the left navigation bar, and then click **Receive**.

2. Confirm the message and click **Yes**.

The **PC-FAX Receive** window appears. The  (**PC-Fax Receive (Ready)**) icon also appears in your computer task tray.



Related Information

- [Receive Faxes Using PC-FAX Receive \(Windows®\)](#)
- [Set Up Your Computer for PC-FAX Receiving \(Windows®\)](#)
- [Add Your Brother Machine to PC-FAX Receiving \(Windows®\)](#)

Set Up Your Computer for PC-FAX Receiving (Windows®)

1. Double-click the  (PC-Fax Receive (Ready)) icon in your computer task tray.

The **PC-FAX Receive** window appears.

2. Click **Settings**.
3. Configure these options as needed:

Preferences

Configure to start PC-FAX Receive automatically when you start Windows®.

Save

Configure the path to save PC-FAX files and select the received document format.

Upload to

Configure the path to the SharePoint® server and select the option to upload automatically or manually (available only for Administrators).

Device

Select the Brother machine that you want to receive PC-FAX.

Lock (available only for Administrators)

Restrict users who do not have administrator privileges from configuring the settings options shown above.

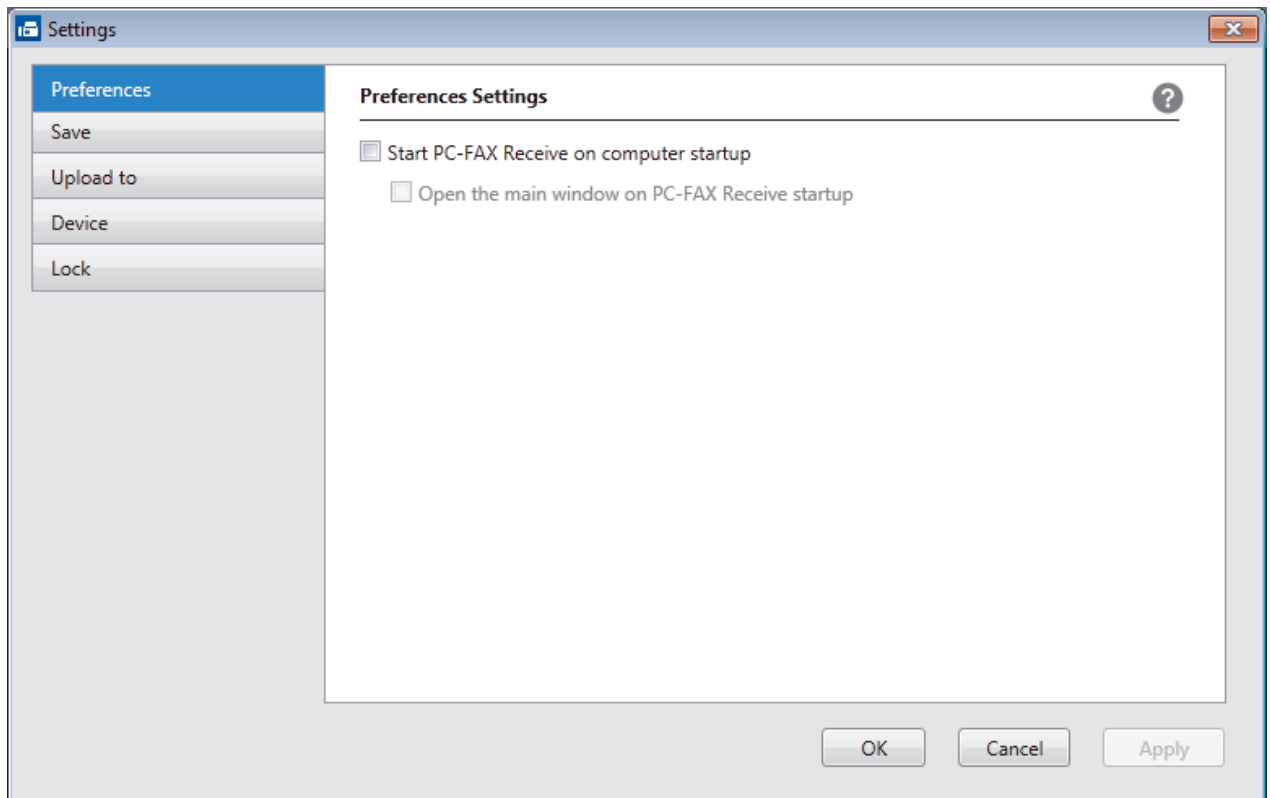

4. Click **OK**.

Related Information

- [Run Brother's PC-FAX Receive on Your Computer \(Windows®\)](#)

Add Your Brother Machine to PC-FAX Receiving (Windows®)

- If you installed the machine following the instructions for a network user, then the machine should already be configured for your network.

- Double-click the  (**PC-Fax Receive (Ready)**) icon in your computer task tray.
The **PC-FAX Receive** window appears.
- Click **Settings**.
- Click **Device > Add**.

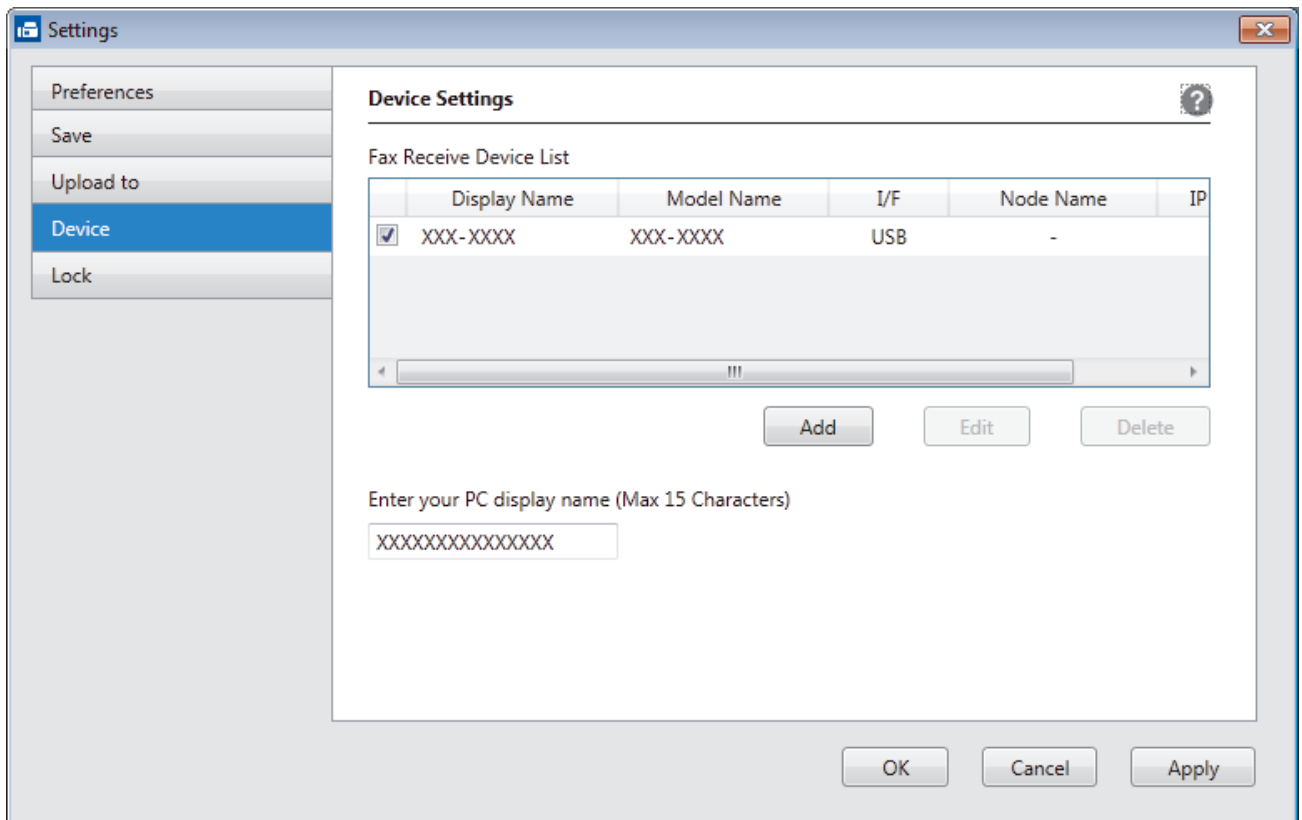

- Select the appropriate connection method.

Select your machine from the automatic search results below.

Connected Brother machines will be displayed. Select a device from the list. Click **OK**.

Specify your machine by IP address

Type the machine's IP address in the **IP Address** field, and then click **OK**.

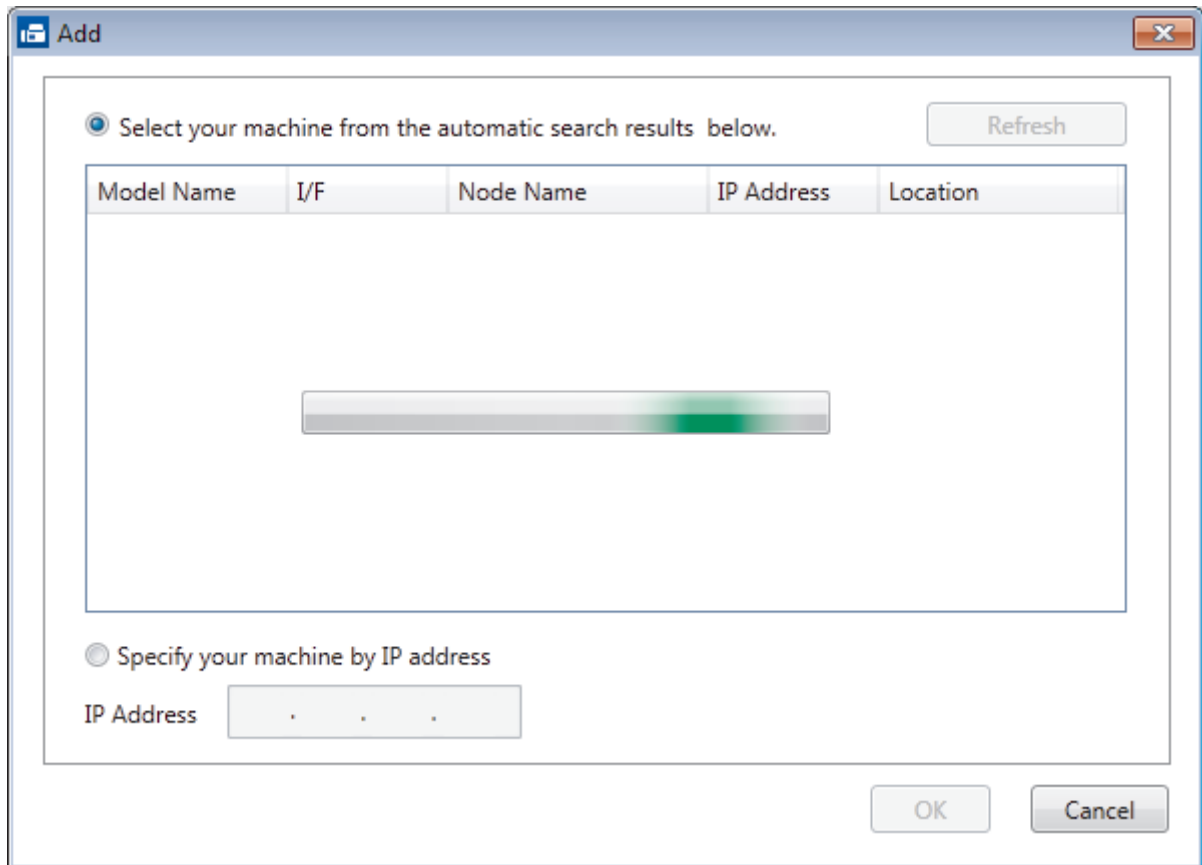



5. To change the computer name that will appear on the machine's LCD, type the new name in the **Enter your PC display name (Max 15 Characters)** field.
6. Click **OK**.

✓ Related Information

- [Run Brother's PC-FAX Receive on Your Computer \(Windows®\)](#)

View Received PC-FAX Messages (Windows®)

Receiving Status

Icon	Indicated Status
	Standby mode No unread messages
	Receiving messages
	Messages received Unread messages

1. Double-click the  (**PC-Fax Receive (Ready)**) icon in your computer task tray.

The **PC-FAX Receive** window appears.

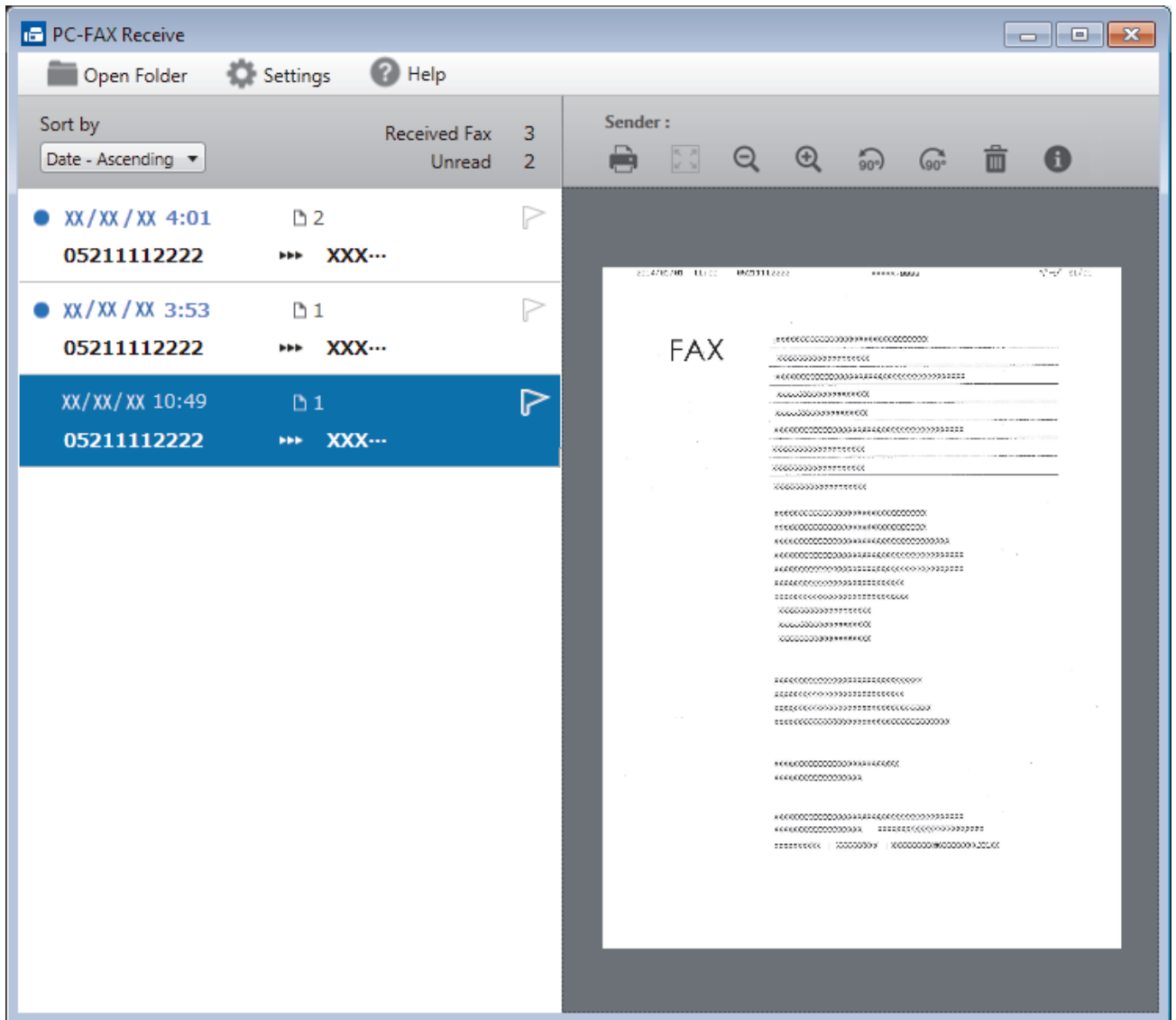

2. Click any faxes in the list to view them.
3. When finished, click  in the right top corner of the window to close it.



Even after closing the window, PC-FAX Receive is active and the  (PC-Fax Receive (Ready)) icon will remain in your computer task tray. To close PC-FAX Receive, click the icon in the computer task tray and click **Close**.



Related Information

- [Receive Faxes Using PC-FAX Receive \(Windows®\)](#)
-

PC-FAX for Macintosh

Use Brother's PC-FAX software to send faxes directly from your Macintosh without printing them. This feature helps reduce your paper consumption and save time.

- [Send Faxes from Your Application \(Macintosh\)](#)

Send Faxes from Your Application (Macintosh)

PC-FAX supports only black and white faxes. A black and white fax will be sent even if the original data is color and the receiving fax machine supports color faxes.

1. Create a document in a Macintosh application.
2. From an application, such as Apple TextEdit, click the **File** menu, and then select **Print**.
3. Click the application pop-up menu, and then select the **Send Fax** option.

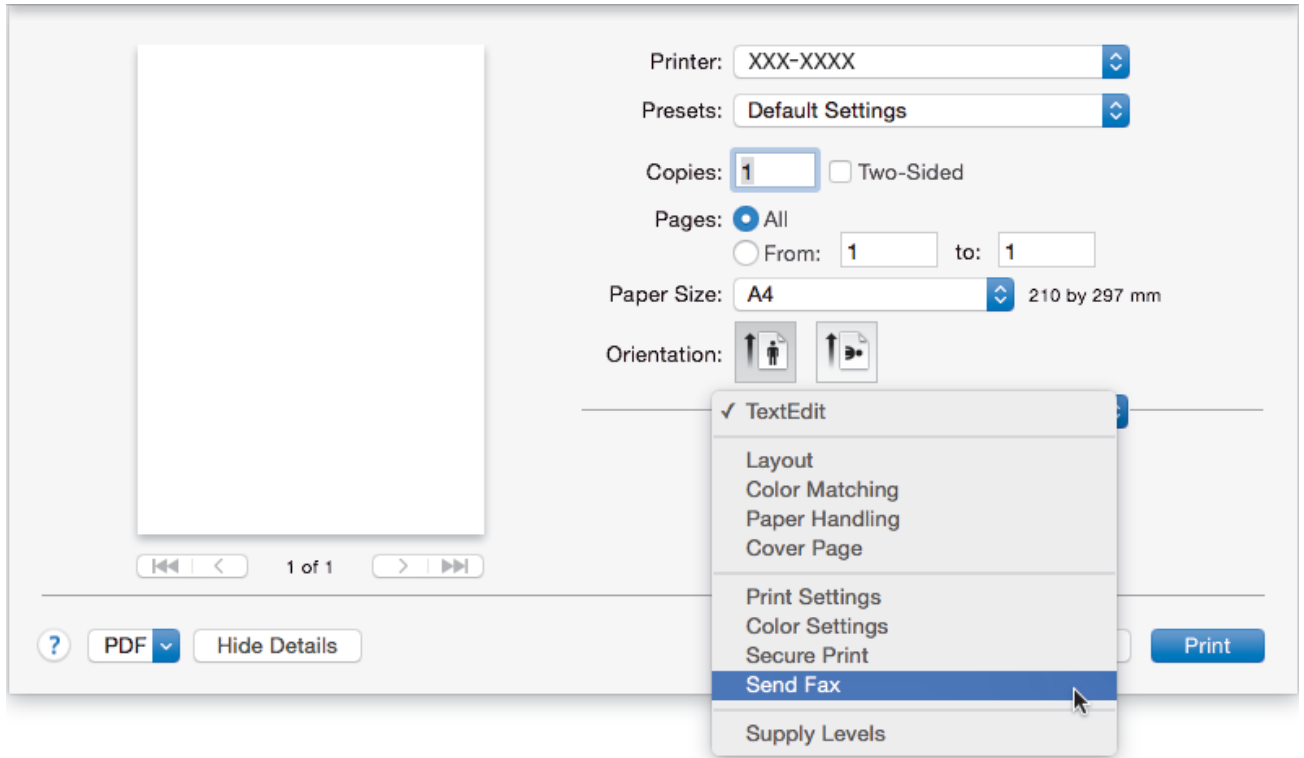

4. Click the **Output** pop-up menu, and then select the **Facsimile** option.

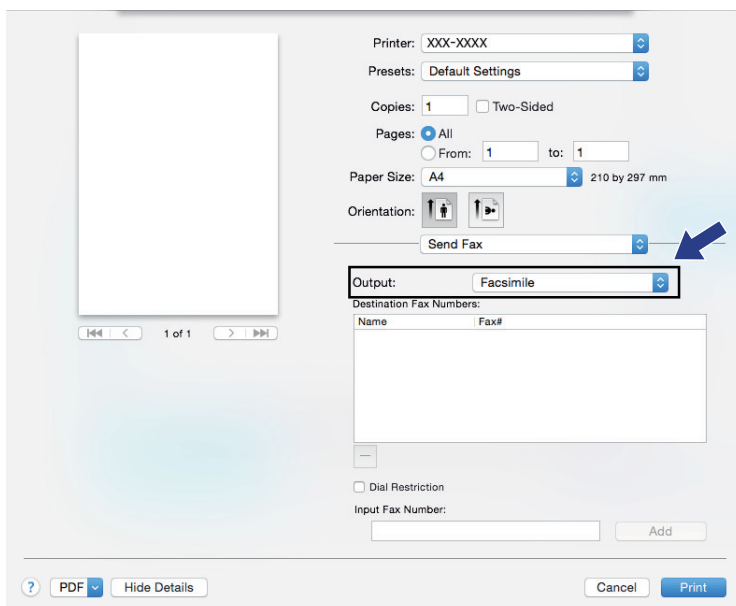

5. Type a fax number in the **Input Fax Number** field, and then click **Add**.
The fax number is displayed in the **Destination Fax Numbers** field.



To send a fax to more than one number, click the **Add** button after entering the first fax number and type the next fax number. The destination fax numbers will be listed in the **Destination Fax Numbers** field.

The screenshot shows a fax software interface with the following elements:

- Printer:** XXX-XXXX
- Presets:** Default Settings
- Copies:** 1, with a checkbox for Two-Sided.
- Pages:** All (selected), From: 1 to: 1
- Paper Size:** A4, 210 by 297 mm
- Orientation:** Portrait (selected)
- Send Fax:** Send Fax (selected)
- Output:** Facsimile
- Destination Fax Numbers:** A table with two columns: Name and Fax#. One entry is visible: Name (blank), Fax# 222-111-3333.
- Input Fax Number:** A text field with an **Add** button next to it. A blue arrow points to the **Add** button.
- Buttons:** ? PDF Hide Details Cancel Print

6. Click **Print** to send the fax.



Related Information

- [PC-FAX for Macintosh](#)

Print Data Directly from a USB Flash Drive

You can print photos directly from digital camera media or a USB flash drive.

Supported file types are PDF, JPEG, TIFF, XPS, and PRN.

- [Compatible USB Flash Drives](#)
- [Print Data Directly from a USB Flash Drive or Digital Camera Supporting Mass Storage](#)
- [Create a PRN File for Direct Printing \(Windows®\)](#)

Compatible USB Flash Drives

IMPORTANT

The USB direct interface supports only USB flash drives and digital cameras that use the USB mass storage standard. Other USB devices are not supported.

Compatible USB Flash Drives	
USB Class	USB Mass Storage Class
USB Mass Storage Sub Class	SCSI or SFF-8070i
Transfer protocol	Bulk transfer Only
Format ¹	FAT12/FAT16/FAT32/exFAT
Sector size	Max. 4096 Byte
Encryption	Encrypted devices are not supported.



Related Information

- [Print Data Directly from a USB Flash Drive](#)

¹ NTFS format is not supported.

Print Data Directly from a USB Flash Drive or Digital Camera Supporting Mass Storage

- Make sure your digital camera is turned on.
- Your digital camera must be switched from PictBridge mode to mass storage mode.

IMPORTANT

To prevent damage to your machine, DO NOT connect any device other than a digital camera or USB flash drive to the USB direct interface.

USB port location (Front View)

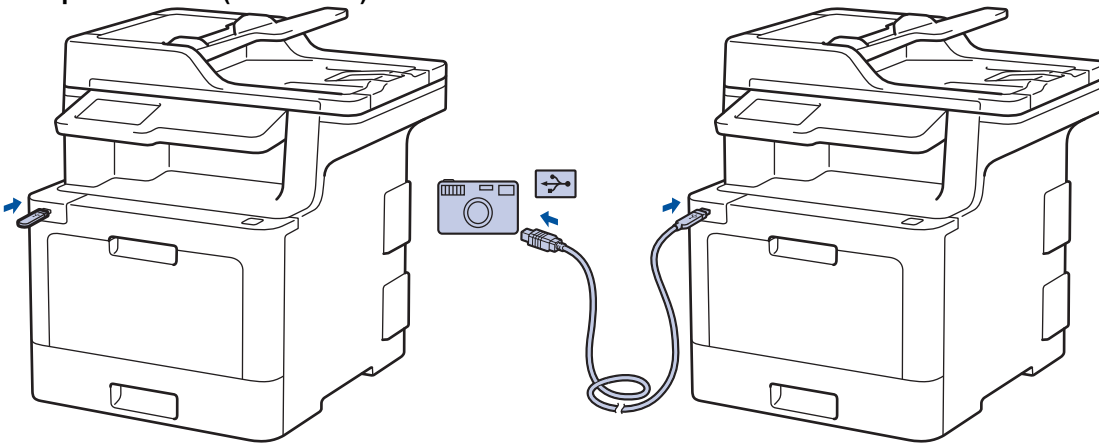

1. Connect your USB flash drive or digital camera to the USB direct interface. The Touchscreen will automatically display the USB menu to confirm the USB flash drive or digital camera is correctly connected.



- If an error occurs, the USB menu will not appear on the Touchscreen.
- When the machine is in Deep Sleep mode, the Touchscreen does not display any information even if you connect a USB flash drive to the USB direct interface. Press the Touchscreen to wake up the machine.
- If your machine has been set to Secure Function Lock On, you may not be able to access Direct Print.

2. Press [Direct Print].
3. Swipe up or down, or press ▲ or ▼ to display the file you want to print, and then select the file.



To print an index of the files, press [Index Print] on the Touchscreen. Press [Black Start] or [Color Start] to print the data.

4. Do one of the following:
 - To change the settings, press [Print Settings]. Go to the next step.
 - If you want to use the default settings, enter the number of copies, and then press [Black Start] or [Color Start].
5. Select the print settings you want to change:
 - [Paper Type]
 - [Paper Size]
 - [Multiple Page]
 - [Orientation]
 - [2-sided]

-
- [Collate]
 - [Tray Use]
 - [Print Quality]
 - [PDF Option]



Depending on the file type, some of these settings may not appear.

6. Press [OK].
7. Enter the number of copies you want.
8. Press [Black Start] or [Color Start] to print the data.
9. Press .

IMPORTANT

DO NOT remove the USB flash drive or digital camera from the USB direct interface until the machine has finished printing.



Related Information

- [Print Data Directly from a USB Flash Drive](#)
-

Create a PRN File for Direct Printing (Windows®)

These instructions may vary depending on your print application and operating system.

1. Select the print command in your application.
2. Select your model, and then select the print to file option.
3. Complete your print operation.
4. Enter the required information to save the file.



If the computer prompts you to enter a file name only, you can also specify the folder where you want to save the file by typing the directory name (for example: C:\Temp\FileName.prn).

If a USB flash drive is connected to your computer, you can save the file directly to the USB flash drive.



Related Information

- [Print Data Directly from a USB Flash Drive](#)

Network

- [Supported Basic Network Features](#)
- [Network Management Software and Utilities](#)
- [Additional Methods of Configuring Your Brother Machine for a Wireless Network](#)
- [Advanced Network Features](#)
- [Technical Information for Advanced Users](#)

Supported Basic Network Features

The print server supports various features depending on the operating system. Use this table to see which network features and connections are supported by each operating system.

Operating Systems	Windows® 7 Windows® 8 Windows® 10	Windows Server® 2008/2012/2012 R2/2016	macOS v10.10.5 macOS v10.11.x macOS v10.12
Printing	Yes	Yes	Yes
Scanning	Yes		Yes
PC Fax Send (Available only for certain models)	Yes		Yes
PC Fax Receive (Available only for certain models)	Yes		
BRAdmin Light	Yes	Yes	
BRAdmin Professional 3	Yes	Yes	
Web Based Management	Yes	Yes	Yes
Remote Setup (Available only for certain models)	Yes		Yes
Status Monitor	Yes		Yes
Driver Deployment Wizard	Yes	Yes	
Vertical Pairing (Available only for certain models)	Yes		



- Go to your model's **Downloads** page on the Brother Solutions Center at support.brother.com to download the latest version of Brother's BRAdmin Light.
- Go to your model's **Downloads** page on the Brother Solutions Center at support.brother.com to download the latest version of Brother's BRAdmin Professional 3 utility.



Related Information

- [Network](#)

Network Management Software and Utilities

Configure and change your Brother machine's network settings using a management utility.

- [Learn about Network Management Software and Utilities](#)
- [Change Machine Settings from Your Computer](#)
- [Change Machine Settings Using Web Based Management](#)

Learn about Network Management Software and Utilities

Web Based Management

Web Based Management is a utility that uses a standard web browser to manage your machine using the Hyper Text Transfer Protocol (HTTP) or Hyper Text Transfer Protocol over Secure Socket Layer (HTTPS). Type your machine's IP address into your web browser to access and change your print server settings.

BRAdmin Light (Windows®)

BRAdmin Light is a utility for the initial setup of Brother network-connected devices. This utility can search for Brother products on your network, view the status and configure the basic network settings, such as IP address.

Go to your model's **Downloads** page on the Brother Solutions Center at support.brother.com to download BRAdmin Light.



- If using Windows® Firewall, or the firewall function of an anti-spyware or antivirus application, temporarily disable them. When you are sure you can print, configure the software settings following the instructions.

BRAdmin Professional 3 (Windows®)

BRAdmin Professional 3 is a utility for more advanced management of network-connected Brother devices. This utility can search for Brother products on your network and view the device status from an easy-to-read Windows® Explorer-style screen that changes color to identify the status of each device. You can configure network and device settings, and update device firmware from a Windows® computer on your LAN. BRAdmin Professional 3 can also log activity of Brother devices on your network and export the log data. For users who want to monitor locally-connected machines, install the Print Auditor Client software on the client computer. This utility allows you to use BRAdmin Professional 3 to monitor machines that are connected to a client computer via the USB interface.



- Go to your model's **Downloads** page on the Brother Solutions Center at support.brother.com to download the latest version of Brother's BRAdmin Professional 3 utility.
- Node name: The node name appears in the current BRAdmin Professional 3 window. The default node name is "BRNxxxxxxxxxxxx" for a wired network or "BRWxxxxxxxxxxxx" for a wireless network (where "xxxxxxxxxxxx" is your machine's MAC Address / Ethernet address).
- If using Windows® Firewall, or the firewall function of an anti-spyware or antivirus application, temporarily disable them. When you are sure you can print, configure the software settings following the instructions.

Remote Setup (Windows® and Macintosh) (Available only for certain models)

Remote Setup is a program for configuring many machine and network settings from either a Windows® or a Macintosh application. When you start this application, the settings on your machine are automatically downloaded to your computer and displayed on your computer screen. If you change the settings, you can upload them directly to the machine.



This utility can be used with either a USB or a network connection.



Related Information

- [Network Management Software and Utilities](#)

Additional Methods of Configuring Your Brother Machine for a Wireless Network

To connect your machine to your wireless network, we recommend using the Brother installation disc.

- [Before Configuring Your Brother Machine for a Wireless Network](#)
- [Configure Your Machine for a Wireless Network](#)
- [Configure Your Machine for a Wireless Network Using the One Push Method of Wi-Fi Protected Setup™ \(WPS\)](#)
- [Configure Your Machine for a Wireless Network Using the PIN Method of Wi-Fi Protected Setup™ \(WPS\)](#)
- [Configure Your Machine for a Wireless Network Using the Machine's Control Panel Setup Wizard](#)
- [Configure Your Machine for a Wireless Network When the SSID Is Not Broadcast](#)
- [Configure Your Machine for an Enterprise Wireless Network](#)
- [Use Wi-Fi Direct®](#)

Before Configuring Your Brother Machine for a Wireless Network

Before attempting to configure a wireless network, confirm the following:

- If you are using an enterprise wireless network, you must know the User ID and Password.
- To achieve optimum results with normal everyday document printing, place the Brother machine as close to the wireless LAN access point/router as possible with minimal obstructions. Large objects and walls between the two devices and interference from other electronic devices can affect the data transfer speed of your documents.

Due to these factors, wireless may not be the best method of connection for all types of documents and applications. If you are printing large files, such as multi-page documents with mixed text and large graphics, you may want to consider selecting wired Ethernet for faster data transfer (supported models only), or USB for the fastest throughput speed.

- Although the Brother machine can be used in both a wired and wireless network (supported models only), only one connection method can be used at a time. However, a wireless network connection and Wi-Fi Direct connection, or a wired network connection (supported models only) and Wi-Fi Direct connection can be used at the same time.



If you do not know the security information, please consult the router manufacturer, your system administrator, or your Internet provider.



Related Information

- [Additional Methods of Configuring Your Brother Machine for a Wireless Network](#)

Configure Your Machine for a Wireless Network

1. Turn on your computer and insert the Brother installation disc into your computer.
 - For Windows®, follow these instructions:
 - For Macintosh, click **Driver Download** to go to the Brother Solutions Center. Follow the on-screen instructions to install printer drivers.
2. The opening screen appears automatically.
Choose your language, and then follow the on-screen instructions.



If the Brother screen does not appear, do the following:

- (Windows® 7)
Go to **Computer**. Double-click the CD/DVD icon, and then double-click **start.exe**.
- (Windows® 8 and Windows® 10)
Click the  (**File Explorer**) icon on the taskbar, and then go to **Computer (This PC)**. Double-click the CD/DVD icon, and then double-click **start.exe**.
- If the **User Account Control** screen appears, click **Yes**.

3. Choose **Wireless Network Connection (Wi-Fi)**, and then click **Next**.
4. Follow the on-screen instructions.

After you have completed the wireless setup, the installer program walks you through installing the drivers and software necessary for operating your device. Click **Next** in the installation dialog box and follow the on-screen instructions.



Related Information

- [Additional Methods of Configuring Your Brother Machine for a Wireless Network](#)

Configure Your Machine for a Wireless Network Using the One Push Method of Wi-Fi Protected Setup™ (WPS)

If your wireless access point/router supports WPS (PBC: Push Button Configuration), you can use WPS from your machine's control panel menu to configure your wireless network settings.



Routers or access points that support WPS are marked with this symbol:



1. Press  [Settings] > [All Settings] > [Network] > [WLAN] > [WPS].



If your machine displays the [All Settings] menu on the Home screen, skip the [Settings] menu.

2. When [Enable WLAN?] appears, press [Yes].
This will start the wireless setup wizard. To cancel, press [No].
3. When the Touchscreen displays [Start WPS on your wireless access point/router, then press [OK].], press the WPS button on your wireless access point/router. Then press [OK] on your machine. Your machine will automatically detect your wireless access point/router and try to connect to your wireless network.

If your wireless device is connected successfully, the machine's LCD displays [Connected].

You have completed the wireless network setup. To install drivers and software necessary for operating your device, insert the Brother installation disc into your computer or go to your model's **Downloads** page on the Brother Solutions Center at support.brother.com.



Related Information

- [Additional Methods of Configuring Your Brother Machine for a Wireless Network](#)
- [Wireless LAN Report Error Codes](#)

Configure Your Machine for a Wireless Network Using the PIN Method of Wi-Fi Protected Setup™ (WPS)

If your wireless LAN access point/router supports WPS, you can use the Personal Identification Number (PIN) Method to configure your wireless network settings.

The PIN Method is one of the connection methods developed by the Wi-Fi Alliance®. By submitting a PIN created by an Enrollee (your machine) to the Registrar (a device that manages the wireless LAN), you can set up the wireless network and security settings. For more information on how to access WPS mode, see the instructions provided with your wireless access point/router.

Type A

Connection when the wireless LAN access point/router (1) doubles as the Registrar:

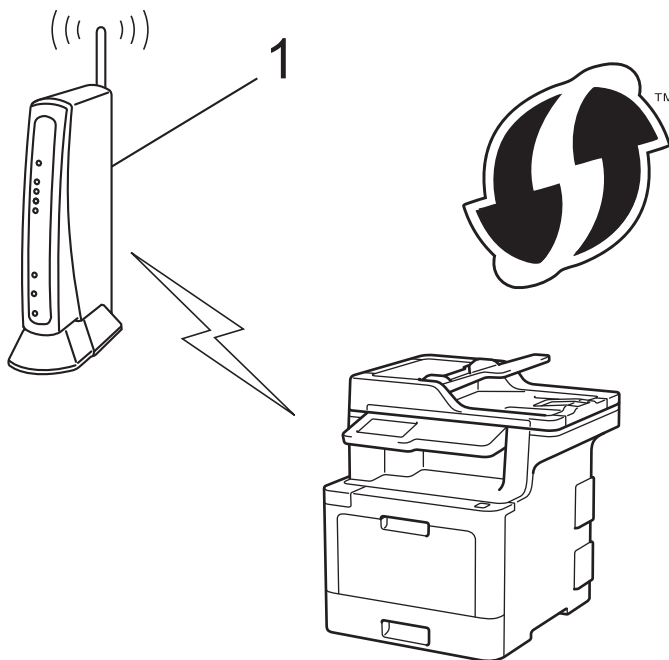

Type B

Connection when another device (2), such as a computer, is used as the Registrar:

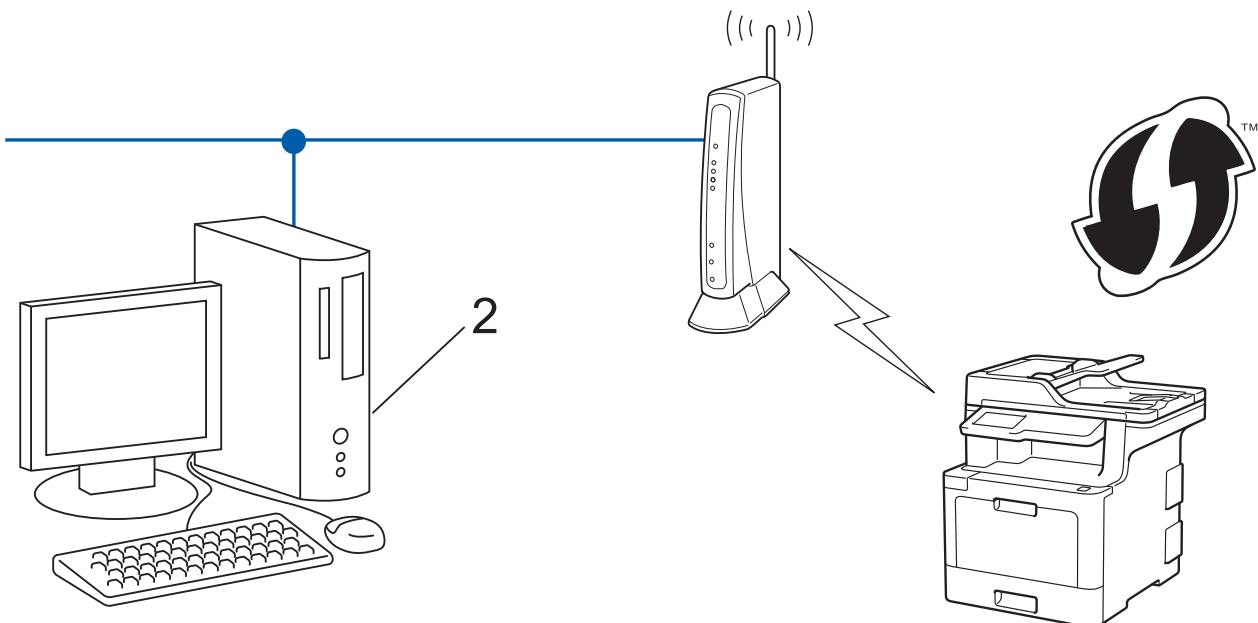

 Routers or access points that support WPS are marked with this symbol:



1. Press  [Settings] > [All Settings] > [Network] > [WLAN] > [WPS w/ PIN Code].

 If your machine displays the [All Settings] menu on the Home screen, skip the [Settings] menu.

2. When [Enable WLAN?] appears, press [Yes].
This will start the wireless setup wizard. To cancel, press [No].
3. The LCD displays an eight-digit PIN and the machine starts searching for a wireless LAN access point/router.
4. Using a computer connected to the network, in your browser's address bar, type the IP address of the device you are using as the Registrar. (For example: <http://192.168.1.2>)
5. Go to the WPS settings page and type the PIN, and then follow the on-screen instructions.

- 
- The Registrar is usually the wireless LAN access point/router.
 - The settings page will differ depending on the brand of wireless LAN access point/router. For more information, see the instructions supplied with your wireless LAN access point/router.

If you are using a Windows® 7, Windows® 8, or Windows® 10 computer as a Registrar, complete the following steps:

6. Do one of the following:
 - Windows® 7
Click  (Start) > **Devices and Printers** > **Add a device.**
 - Windows® 8
Move your mouse to the lower right corner of your desktop. When the menu bar appears, click **Settings** > **Control Panel** > **Hardware and Sound** > **Devices and Printers** > **Add a device.**

-
- Windows® 10

Click  > **Windows System** > **Control Panel**. In the **Hardware and Sound** group, click **Add a device**.



- To use a Windows® 7, Windows® 8, or Windows® 10 computer as a Registrar, you must register it to your network in advance. For more information, see the instructions supplied with your wireless LAN access point/router.
- If you use Windows® 7, Windows® 8, or Windows® 10 as a Registrar, you can install the printer driver after the wireless configuration by following the on-screen instructions. To install the full driver and software package, use the Brother installation disc.

-
7. Select your machine and click **Next**.
 8. Type the PIN displayed on the machine's LCD, and then click **Next**.
 9. (Windows® 7) Select your network, and then click **Next**.
 10. Click **Close**.

If your wireless device is connected successfully, the machine's LCD displays [Connected].

You have completed the wireless network setup. To install drivers and software necessary for operating your device, insert the Brother installation disc into your computer or go to your model's **Downloads** page on the Brother Solutions Center at support.brother.com.



Related Information

- [Additional Methods of Configuring Your Brother Machine for a Wireless Network](#)
 - [Wireless LAN Report Error Codes](#)
-

Configure Your Machine for a Wireless Network Using the Machine's Control Panel Setup Wizard

Before configuring your machine, we recommend writing down your wireless network settings. You will need this information before you continue with the configuration.

1. Check and record the current wireless network settings of the computer to which you are connecting.

Network Name (SSID)

Network Key

For example:

Network Name (SSID)
HELLO

Network Key
12345



- Your access point/router may support the use of multiple WEP keys, however your Brother machine supports the use of the first WEP key only.
- If you need assistance during setup and want to contact Brother Customer Service, make sure you have your SSID (Network Name) and Network Key ready. We cannot assist you in locating this information.
- If you do not know this information (SSID and Network Key), you cannot continue the wireless setup.

How can I find this information?

- a. Check the documentation provided with your wireless access point/router.
- b. The initial SSID could be the manufacturer's name or the model name.
- c. If you do not know the security information, please consult the router manufacturer, your system administrator, or your Internet provider.

2. Press  [Settings] > [All Settings] > [Network] > [WLAN] > [Setup Wizard].



If your machine displays the [All Settings] menu on the Home screen, skip the [Settings] menu.

3. When [Enable WLAN?] appears, press [Yes].
This will start the wireless setup wizard. To cancel, press [No].
4. The machine will search for your network and display a list of available SSIDs.
If a list of SSIDs is displayed, swipe up or down or press ▲ or ▼ to display the SSID to which you want to connect, and then press the SSID.
5. Press [OK].
6. Do one of the following:
 - If you are using an authentication and encryption method that requires a Network Key, enter the Network Key you wrote down in the first step.
When you have entered all the characters, press [OK].
 - If your authentication method is Open System and your encryption mode is None, go to the next step.

7. The machine attempts to connect to the wireless device you have selected.

If your wireless device is connected successfully, the machine's LCD displays [Connected].

You have completed the wireless network setup. To install drivers and software necessary for operating your device, insert the Brother installation disc into your computer or go to your model's **Downloads** page on the Brother Solutions Center at support.brother.com.



Related Information

- [Additional Methods of Configuring Your Brother Machine for a Wireless Network](#)
 - [How to Enter Text on Your Brother Machine](#)
 - [Wireless LAN Report Error Codes](#)
-

Configure Your Machine for a Wireless Network When the SSID Is Not Broadcast

Before configuring your machine, we recommend writing down your wireless network settings. You will need this information before you continue with the configuration.

1. Check and write down the current wireless network settings.

Network Name (SSID)				
Communication Mode	Authentication Method	Encryption Mode	Network Key	
Infrastructure	Open System	NONE	-	
		WEP		
	Shared Key	WEP		
		WPA/WPA2-PSK	AES	
			TKIP	

For example:

Network Name (SSID)			
HELLO			
Communication Mode	Authentication Method	Encryption Mode	Network Key
Infrastructure	WPA2-PSK	AES	12345678

 If your router uses WEP encryption, enter the key used as the first WEP key. Your Brother machine supports the use of the first WEP key only.

2. Press  [Settings] > [All Settings] > [Network] > [WLAN] > [Setup Wizard].

 If your machine displays the [All Settings] menu on the Home screen, skip the [Settings] menu.

3. When [Enable WLAN?] appears, press [Yes].
This will start the wireless setup wizard. To cancel, press [No].
4. The machine will search for your network and display a list of available SSIDs. Swipe up or down or press ▲ or ▼ to display [<New SSID>]. Press [<New SSID>], and then press [OK].
5. Enter the SSID name, and then press [OK].
6. Press [Infrastructure] when instructed.
7. Select the Authentication Method.
8. Do one of the following:
 - If you selected the [Open System] option, press the Encryption type [None] or [WEP].
If you selected the [WEP] option for Encryption type, select and enter the WEP key, and then press [OK].
 - If you selected the [Shared Key] option, select and enter the WEP key, and then press [OK].
 - If you selected the [WPA/WPA2-PSK] option, press the Encryption type [TKIP+AES] or [AES].
Enter the WPA key, and then press [OK].

 Your Brother machine supports the use of the first WEP key only.

9. The machine attempts to connect to the wireless device you have selected.

If your wireless device is connected successfully, the machine's LCD displays [Connected].

You have completed the wireless network setup. To install drivers and software necessary for operating your device, insert the Brother installation disc into your computer or go to your model's **Downloads** page on the Brother Solutions Center at support.brother.com.



Related Information

- [Additional Methods of Configuring Your Brother Machine for a Wireless Network](#)
 - [I Cannot Complete the Wireless Network Setup Configuration](#)
 - [How to Enter Text on Your Brother Machine](#)
 - [Wireless LAN Report Error Codes](#)
-

Configure Your Machine for an Enterprise Wireless Network

Before configuring your machine, we recommend writing down your wireless network settings. You will need this information before you continue with the configuration.

1. Check and record the current wireless network settings.

Network Name (SSID)

Communication Mode	Authentication Method	Encryption Mode	User ID	Password
Infrastructure	LEAP	CKIP		
		AES		
	EAP-FAST/NONE	TKIP		
		AES		
	EAP-FAST/MS-CHAPv2	TKIP		
		AES		
	EAP-FAST/GTC	TKIP		
		AES		
	PEAP/MS-CHAPv2	TKIP		
		AES		
	PEAP/GTC	TKIP		
		AES		
	EAP-TTLS/CHAP	TKIP		
		AES		
	EAP-TTLS/MS-CHAP	TKIP		
		AES		
	EAP-TTLS/MS-CHAPv2	TKIP		
		AES		
EAP-TTLS/PAP	TKIP			
	AES			
EAP-TLS	TKIP			-
	AES			-

For example:

Network Name (SSID)
HELLO

Communication Mode	Authentication Method	Encryption Mode	User ID	Password
Infrastructure	EAP-FAST/MS-CHAPv2	AES	Brother	12345678



- If you configure your machine using EAP-TLS authentication, you must install the client certificate issued by a CA before you start configuration. Contact your network administrator about the client certificate. If you have installed more than one certificate, we recommend writing down the certificate name you want to use.
- If you verify your machine using the common name of the server certificate, we recommend writing down the common name before you start configuration. Contact your network administrator about the common name of the server certificate.

2. Press  [Settings] > [All Settings] > [Network] > [WLAN] > [Setup Wizard].



If your machine displays the [All Settings] menu on the Home screen, skip the [Settings] menu.

3. When [Enable WLAN?] appears, press [Yes].

This will start the wireless setup wizard. To cancel, press [No].

4. The machine will search for your network and display a list of available SSIDs. Swipe up or down or press ▲ or ▼ to display [<New SSID>]. Press [<New SSID>], and then press [OK].

5. Enter the SSID name, and then press [OK].

6. Press [Infrastructure] when instructed.

7. Select the Authentication Method.

8. Do one of the following:

- If you selected the [LEAP] option, enter the user ID, and then press [OK]. Enter the Password, and then press [OK].
- If you selected the [EAP-FAST], [PEAP] or [EAP-TTLS] option, select the Inner Authentication method [NONE], [CHAP], [MS-CHAP], [MS-CHAPv2], [GTC] or [PAP].



Depending on your Authentication method, the Inner Authentication method selections differ.

Select the encryption type [TKIP+AES] or [AES].

Select the verification method [No Verification], [CA] or [CA + Server ID].

- If you selected the [CA + Server ID] option, enter the server ID, user ID and password (if required), and then press [OK] for each option.
- For other selections, enter the user ID and Password, and then press [OK] for each option.



If you have not imported a CA certificate into your machine, the machine displays [No Verification].

- If you selected the [EAP-TLS] option, select the encryption type [TKIP+AES] or [AES].

The machine will display a list of available Client Certificates, and then select the certificate.

Select the verification method [No Verification], [CA] or [CA + Server ID].

- If you selected the [CA + Server ID] option, enter the server ID and user ID, and then press [OK] for each option.
- For other selections, enter the user ID, and then press [OK].



If you have not imported a CA certificate into your machine, the machine displays [No Verification].

9. The machine attempts to connect to the wireless device you have selected.

If your wireless device is connected successfully, the machine's LCD displays [Connected].

You have completed the wireless network setup. To install drivers and software necessary for operating your device, insert the Brother installation disc into your computer or go to your model's **Downloads** page on the Brother Solutions Center at support.brother.com.



Related Information

- [Additional Methods of Configuring Your Brother Machine for a Wireless Network](#)

Use Wi-Fi Direct®

- [Print or Scan from Your Mobile Device Using Wi-Fi Direct](#)
- [Configure Your Wi-Fi Direct Network](#)
- [I Cannot Complete the Wireless Network Setup Configuration](#)

Print or Scan from Your Mobile Device Using Wi-Fi Direct

Wi-Fi Direct is one of the wireless configuration methods developed by the Wi-Fi Alliance®. It allows you to configure a secured wireless network between your Brother machine and a mobile device, such as an Android™ device, Windows® device, iPhone, iPod touch, or iPad, without using an access point. Wi-Fi Direct supports wireless network configuration using the one-push or PIN Method of Wi-Fi Protected Setup™ (WPS). You can also configure a wireless network by manually setting an SSID and password. Your Brother machine's Wi-Fi Direct feature supports WPA2™ security with AES encryption.

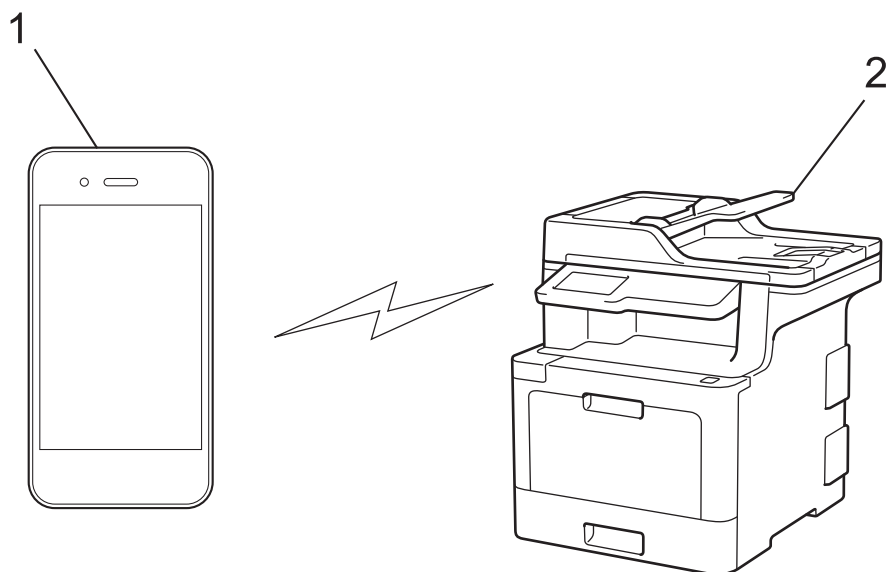

1. Mobile device
2. Your Brother machine



- Although the Brother machine can be used in both a wired and wireless network, only one connection method can be used at a time. However, a wireless network connection and Wi-Fi Direct connection, or a wired network connection (supported models only) and Wi-Fi Direct connection can be used at the same time.
- The Wi-Fi Direct-supported device can become a Group Owner (G/O). When configuring the Wi-Fi Direct network, the G/O serves as an access point.



Related Information

- [Use Wi-Fi Direct®](#)

Configure Your Wi-Fi Direct Network

Configure your Wi-Fi Direct network settings from your machine's control panel.

- [Wi-Fi Direct Network Configuration Overview](#)
- [Configure Your Wi-Fi Direct Network Using the One-Push Method](#)
- [Configure Your Wi-Fi Direct Network Using the One-Push Method of Wi-Fi Protected Setup™ \(WPS\)](#)
- [Configure Your Wi-Fi Direct Network Using the PIN Method](#)
- [Configure Your Wi-Fi Direct Network Using the PIN Method of Wi-Fi Protected Setup™ \(WPS\)](#)
- [Configure Your Wi-Fi Direct Network Manually](#)

Wi-Fi Direct Network Configuration Overview

The following instructions offer five methods for configuring your Brother machine in a wireless network environment. Select the method you prefer for your environment:

Check your mobile device for configuration.

1. Does your mobile device support Wi-Fi Direct?

Option	Description
Yes	Go to Step 2
No	Go to Step 3

2. Does your mobile device support one-push configuration for Wi-Fi Direct?

Option	Description
Yes	See <i>Related Information</i> : Configure Your Wi-Fi Direct Network Using the One-Push Method.
No	See <i>Related Information</i> : Configure Your Wi-Fi Direct Network Using the PIN Method.

3. Does your mobile device support Wi-Fi Protected Setup™ (WPS)?

Option	Description
Yes	Go to Step 4
No	See <i>Related Information</i> : Configure Your Wi-Fi Direct Network Manually.

4. Does your mobile device support one-push configuration for Wi-Fi Protected Setup™ (WPS)?

Option	Description
Yes	See <i>Related Information</i> : Configure Your Wi-Fi Direct Network Using the One-Push Method of Wi-Fi Protected Setup™ (WPS).
No	See <i>Related Information</i> : Configure Your Wi-Fi Direct Network Using the PIN Method of Wi-Fi Protected Setup™ (WPS).

To use Brother iPrint&Scan functionality in a Wi-Fi Direct network configured by one-push configuration using Wi-Fi Direct or by PIN Method configuration using Wi-Fi Direct, the device you use to configure Wi-Fi Direct must be running Android™ 4.0 or greater.

✓ Related Information

- [Configure Your Wi-Fi Direct Network](#)
- [Configure Your Wi-Fi Direct Network Using the One-Push Method](#)
- [Configure Your Wi-Fi Direct Network Using the One-Push Method of Wi-Fi Protected Setup™ \(WPS\)](#)
- [Configure Your Wi-Fi Direct Network Using the PIN Method](#)
- [Configure Your Wi-Fi Direct Network Using the PIN Method of Wi-Fi Protected Setup™ \(WPS\)](#)
- [Configure Your Wi-Fi Direct Network Manually](#)

Configure Your Wi-Fi Direct Network Using the One-Push Method

If your mobile device supports Wi-Fi Direct, follow these steps to configure a Wi-Fi Direct network:



When the machine receives the Wi-Fi Direct request from your mobile device, the message [Wi-Fi Direct connection request received. Press [OK] to connect.] will appear on the LCD. Press [OK] to connect.

1. Press  [Settings] > [All Settings] > [Network] > [Wi-Fi Direct] > [Push Button].



If your machine displays the [All Settings] menu on the Home screen, skip the [Settings] menu.

2. Activate Wi-Fi Direct on your mobile device (see your mobile device's user's guide for instructions) when [Activate Wi-Fi Direct on other device. Then Press [OK].] appears on the machine's LCD. Press [OK] on your machine.

This will start the Wi-Fi Direct setup. To cancel, press .

3. Do one of the following:
 - When your Brother machine is the Group Owner (G/O), connect your mobile device to the machine directly.
 - When your Brother machine is not the G/O, it displays available device names with which to configure a Wi-Fi Direct network. Select the mobile device you want to connect to. Search for available devices again by pressing [Rescan].
4. If your mobile device connects successfully, the machine's LCD displays [Connected]. You have completed the Wi-Fi Direct network setup. The Mobile Print/Scan Guide for Brother iPrint&Scan contains information on printing from or scanning to your mobile device. Go to your model's **Manuals** page on the Brother Solutions Center at support.brother.com to see the guide.



Related Information

- [Configure Your Wi-Fi Direct Network](#)
- [Wi-Fi Direct Network Configuration Overview](#)

Configure Your Wi-Fi Direct Network Using the One-Push Method of Wi-Fi Protected Setup™ (WPS)

If your mobile device supports WPS (PBC: Push Button Configuration), follow these steps to configure a Wi-Fi Direct network:



When the machine receives the Wi-Fi Direct request from your mobile device, the message [Wi-Fi Direct connection request received. Press [OK] to connect.] will appear on the LCD. Press [OK] to connect.

1. Press  [Settings] > [All Settings] > [Network] > [Wi-Fi Direct] > [Group Owner].



If your machine displays the [All Settings] menu on the Home screen, skip the [Settings] menu.

2. Press [On].
3. Swipe up or down or press ▲ or ▼ to select the [Push Button] option. Press [Push Button].
4. Activate your mobile device's WPS one-push configuration method (see your mobile device's user's guide for instructions) when [Activate Wi-Fi Direct on other device. Then Press [OK].] appears on the machine's LCD. Press [OK] on your Brother machine.

This will start the Wi-Fi Direct setup. To cancel, press .

5. If your mobile device connects successfully, the machine's LCD displays [Connected]. You have completed the Wi-Fi Direct network setup. The Mobile Print/Scan Guide for Brother iPrint&Scan contains information on printing from or scanning to your mobile device. Go to your model's **Manuals** page on the Brother Solutions Center at support.brother.com to see the guide.



Related Information

- [Configure Your Wi-Fi Direct Network](#)
- [Wi-Fi Direct Network Configuration Overview](#)

Configure Your Wi-Fi Direct Network Using the PIN Method

If your mobile device supports the PIN Method of Wi-Fi Direct, follow these steps to configure a Wi-Fi Direct network:



When the machine receives the Wi-Fi Direct request from your mobile device, the message [Wi-Fi Direct connection request received. Press [OK] to connect.] will appear on the LCD. Press [OK] to connect.

1. Press  [Settings] > [All Settings] > [Network] > [Wi-Fi Direct] > [PIN Code].



If your machine displays the [All Settings] menu on the Home screen, skip the [Settings] menu.

2. Activate Wi-Fi Direct on your mobile device (see your mobile device's user's guide for instructions) when [Activate Wi-Fi Direct on other device. Then Press [OK].] appears on the machine's LCD. Press [OK] on your machine.

This will start the Wi-Fi Direct setup. To cancel, press .

3. Do one of the following:
 - When your Brother machine is the Group Owner (G/O), it will wait for a connection request from your mobile device. When [PIN Code] appears, enter the PIN displayed on your mobile device in the machine. Press [OK] to complete the setup.
If the PIN is displayed on your Brother machine, enter the PIN in your mobile device.
 - When your Brother machine is not the G/O, it displays available device names with which to configure a Wi-Fi Direct network. Select the mobile device you want to connect to. Search for available devices again by pressing [Rescan].
4. Do one of the following:
 - Press [Display PIN Code] to display the PIN on your machine and enter the PIN in your mobile device. Go to the next step.
 - Press [Input PIN Code] to enter the PIN displayed on your mobile device in the machine, and then press [OK]. Go to the next step.
If your mobile device does not display a PIN, press  on your Brother machine. Go back to the first step and try again.
5. If your mobile device connects successfully, the machine's LCD displays [Connected]. You have completed the Wi-Fi Direct network setup. The Mobile Print/Scan Guide for Brother iPrint&Scan contains information on printing from or scanning to your mobile device. Go to your model's **Manuals** page on the Brother Solutions Center at support.brother.com to see the guide.



Related Information

- [Configure Your Wi-Fi Direct Network](#)
- [Wi-Fi Direct Network Configuration Overview](#)

Configure Your Wi-Fi Direct Network Using the PIN Method of Wi-Fi Protected Setup™ (WPS)

If your mobile device supports the PIN Method of Wi-Fi Protected Setup™ (WPS), follow these steps to configure a Wi-Fi Direct network:



When the machine receives the Wi-Fi Direct request from your mobile device, the message [Wi-Fi Direct connection request received. Press [OK] to connect.] will appear on the LCD. Press [OK] to connect.

1. Press  [Settings] > [All Settings] > [Network] > [Wi-Fi Direct] > [Group Owner].



If your machine displays the [All Settings] menu on the Home screen, skip the [Settings] menu.

2. Press [On].
3. Swipe up or down or press ▲ or ▼ to select the [PIN Code] option. Press [PIN Code].
4. When [Activate Wi-Fi Direct on other device. Then Press [OK].] appears, activate your mobile device's WPS PIN configuration method (see your mobile device's user's guide for instructions) and then press [OK] on your Brother machine.

This will start the Wi-Fi Direct setup. To cancel, press .

5. The machine will wait for a connection request from your mobile device. When [PIN Code] appears, enter the PIN displayed on your mobile device into the machine. Press [OK].
6. If your mobile device connects successfully, the machine's LCD displays [Connected]. You have completed the Wi-Fi Direct network setup. The Mobile Print/Scan Guide for Brother iPrint&Scan contains information on printing from or scanning to your mobile device. Go to your model's **Manuals** page on the Brother Solutions Center at support.brother.com to see the guide.



Related Information

- [Configure Your Wi-Fi Direct Network](#)
- [Wi-Fi Direct Network Configuration Overview](#)

Configure Your Wi-Fi Direct Network Manually

If your mobile device does not support Wi-Fi Direct or WPS, you must configure a Wi-Fi Direct network manually.



When the machine receives the Wi-Fi Direct request from your mobile device, the message [Wi-Fi Direct connection request received. Press [OK] to connect.] will appear on the LCD. Press [OK] to connect.

1. Press  [Settings] > [All Settings] > [Network] > [Wi-Fi Direct] > [Manual].



If your machine displays the [All Settings] menu on the Home screen, skip the [Settings] menu.

2. The machine will display the SSID name and Password for two minutes. Go to your mobile device's wireless network settings screen, select the SSID name, and then enter the password.
3. If your mobile device connects successfully, the machine's LCD displays [Connected]. You have completed the Wi-Fi Direct network setup. The Mobile Print/Scan Guide for Brother iPrint&Scan contains information on printing from or scanning to your mobile device. Go to your model's **Manuals** page on the Brother Solutions Center at support.brother.com to see the guide.



Related Information

- [Configure Your Wi-Fi Direct Network](#)
- [Wi-Fi Direct Network Configuration Overview](#)

Advanced Network Features

- [Print the Network Configuration Report](#)
- [Configure Your Mail Server Settings Using Web Based Management](#)
- [Configure the Brother Machine for Email or Internet Fax \(I-Fax\)](#)
- [I-Fax Options](#)
- [Use the Send Fax to Server Feature](#)
- [Print the WLAN Report](#)
- [Configure and Operate LDAP Search](#)
- [Synchronize Time with the SNTP Server Using Web Based Management](#)

Print the Network Configuration Report

The Network Configuration Report lists the network configuration, including the network print server settings.



- **Node Name:** The Node Name appears on the current Network Configuration Report. The default Node Name is "BRNxxxxxxxxxxx" for a wired network or "BRWxxxxxxxxxxx" for a wireless network (where "xxxxxxxxxxx" is your machine's MAC Address / Ethernet Address.)
- If the [IP Address] on the Network Configuration Report shows 0.0.0.0, wait for one minute and try printing it again.
- You can find your machine's settings, such as the IP address, subnet mask, node name, and MAC Address on the report, for example:
 - IP address: 192.168.0.5
 - Subnet mask: 255.255.255.0
 - Node name: BRN000ca0000499
 - MAC Address: 00-0c-a0-00-04-99

1. Press  [Settings] > [All Settings] > [Print Reports] > [Network Configuration].



If your machine displays the [All Settings] menu on the Home screen, skip the [Settings] menu.

2. Press [Yes].
3. Press .



Related Information

- [Advanced Network Features](#)
- [Where Can I Find My Brother Machine's Network Settings?](#)
- [Use the Network Connection Repair Tool \(Windows®\)](#)
- [I Want to Check that My Network Devices are Working Correctly](#)
- [Access Web Based Management](#)
- [Configure the Gigabit Ethernet Settings Using Web Based Management](#)

Configure Your Mail Server Settings Using Web Based Management

Use Web Based Management to configure your Brother machine to connect with your mail server.

1. Start your web browser.
2. Type "http://machine's IP address" in your browser's address bar (where "machine's IP address" is the machine's IP address).

For example:

http://192.168.1.2

3. No password is required by default. Type a password if you have set one, and then click .
4. Click the **Network** tab.
5. Click the **Protocol** menu in the left navigation bar.
6. In the **POP3/IMAP4/SMTP** field, click **Advanced Settings** and make sure the **Status** is **Enabled**.

POP3/IMAP4/SMTP



Status Enabled

Send E-mail Settings(SMTP)

Server Address	<input type="text" value="0.0.0.0"/>
Port	<input type="text" value="25"/>
Server Authentication Method	<input checked="" type="radio"/> None <input type="radio"/> SMTP-AUTH
SMTP-AUTH Account Name	<input type="text"/>
SMTP-AUTH Account Password	<input type="text"/>
Enter password	<input type="text"/>
Retype password	<input type="text"/>
SSL/TLS	<input checked="" type="radio"/> None <input type="radio"/> SSL <input type="radio"/> TLS <input type="checkbox"/> Verify Server Certificate
Device E-mail Address	<input type="text" value="bmxxxxxxxxxxx@example.com"/>

Receive E-mail Settings(POP3/IMAP4)

Protocol	<input checked="" type="radio"/> POP3 <input type="radio"/> IMAP4
Server Address	<input type="text" value="0.0.0.0"/>
Port	<input type="text" value="110"/>
Mailbox Name	<input type="text"/>
Mailbox Password	<input type="text"/>
Enter password	<input type="text"/>
Retype password	<input type="text"/>
	<input type="checkbox"/> Use APOP (POP3 Only)
Select Mail Folder Name(IMAP4 Only)	<input checked="" type="radio"/> Default(Inbox) <input type="radio"/> Specified : <input type="text"/>
SSL/TLS	<input checked="" type="radio"/> None <input type="radio"/> SSL <input type="radio"/> TLS <input type="checkbox"/> Verify Server Certificate
Segmented Message Timeout	<input type="text" value="120"/> minute(s)

[I-Fax>>](#)

[CA Certificate>>](#)

[E-mail report>>](#)

[Notification>>](#)

-
7. Select the mail server you want to configure.
 8. Enter the necessary settings for the mail server.



If you select the **IMAP4** option, you must enter the full path of the mail folder using single byte characters only, and then enter "Inbox" for the root mail folder.

9. When finished, click **Submit**.
The **Test Send/Receive E-mail Configuration** dialog box appears.
10. Follow the instructions in the dialog box to test the current settings.



Related Information

- [Advanced Network Features](#)
-

Configure the Brother Machine for Email or Internet Fax (I-Fax)

Before using I-Fax, configure your Brother machine to communicate with your network and mail server. You can configure these items using the machine's control panel, Web Based Management, Remote setup, or BRAdmin Professional 3. Make sure the following items are configured on your machine:

- IP address (If you are already using your machine on your network, the machine's IP address has been configured correctly.)
- Email address
- SMTP, POP3, IMAP4 server address/port/Authentication method/Encryption method/Server Certificate Verification
- Mailbox name and password

If you are unsure of any of these items, contact your system administrator.



Related Information

- [Advanced Network Features](#)
- [Fax Using the Internet \(I-Fax\)](#)
- [Initial Setup for Email or Internet Fax \(I-Fax\)](#)
- [Send an Internet Fax \(I-Fax\)](#)
- [How Your Brother Machine Receives an Internet Fax \(I-Fax\)](#)
- [Poll the Server Manually](#)
- [How Your Computer Receives an I-Fax](#)
- [Forward Received Email and Fax Messages](#)
- [Relay Broadcast](#)
- [I-Fax Options](#)

Fax Using the Internet (I-Fax)

With Internet Fax (I-Fax), you can send and receive fax documents using the Internet as the transport mechanism. Documents are transmitted in email messages as attached TIFF-F files. Your computer can send and receive documents as long as it has an application that can generate and view TIFF-F files. You can use any TIFF-F viewer application. Documents sent via the machine will be converted into a TIFF-F format automatically. If you want to send and receive messages to and from your machine, your computer's email application must support Multipurpose Internet Mail Extensions (MIME).

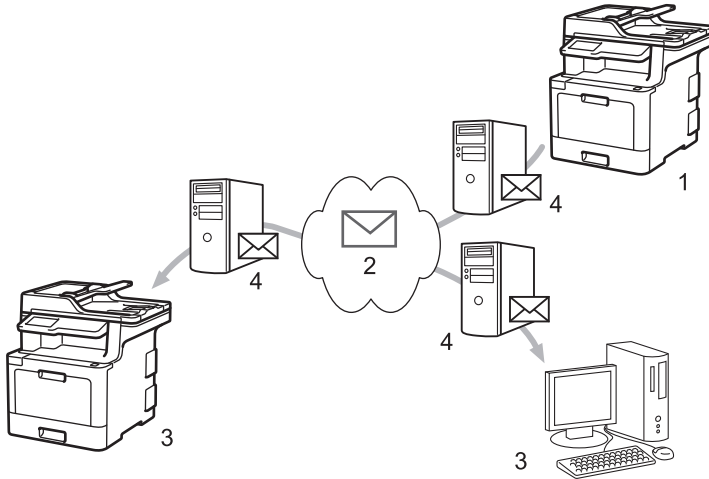

1. Sender
2. Internet
3. Receiver
4. Email server



- I-Fax supports sending and receiving documents in Letter or A4 format and in black and white only.
- (MFC-L8610CDW)

To use this function, go to your model's **Downloads** page on the Brother Solutions Center at support.brother.com to update your machine's firmware or the program in your machine.



Related Information

- [Configure the Brother Machine for Email or Internet Fax \(I-Fax\)](#)
- [Important Information about Internet Fax \(I-Fax\)](#)
- [Forward Received Email and Fax Messages](#)

Important Information about Internet Fax (I-Fax)

I-Fax communication on a LAN is very similar to communication via email; however, it is different from fax communication using standard phone lines. The following is important information for using I-Fax:

- Factors such as the receiver's location, structure of the LAN and how busy the circuit (such as the Internet) is may cause the system to take a longer time than usual to send an error mail.
- When sending confidential documents, we recommend using standard phone lines instead of the Internet (due to its low level of security).
- If the receiver's mail system is not MIME-compatible, you cannot use I-Fax to send documents. If possible, find out in advance, and note that some servers will not send an error reply.
- If a document is too large to send via I-Fax, it may not reach the receiver.
- You cannot change the font or size of the text in any Internet mail you receive.



Related Information

- [Fax Using the Internet \(I-Fax\)](#)

Initial Setup for Email or Internet Fax (I-Fax)

Before sending your I-Fax, use the control panel, Web Based Management, or Remote Setup to configure the following optional items:

- **E-mail Subject**
- **E-mail Message**
- **Size Limit**
- **Request Delivery Notification (Send)**

E-mail Send

E-mail Subject	<input type="text" value="Internet Fax Job"/>
E-mail Message	<input type="text"/>
Size Limit	<input checked="" type="radio"/> Off <input type="radio"/> On
Maximum Size	<input type="text" value="0"/> MB
Request Delivery Notification (Send)	<input checked="" type="radio"/> Off <input type="radio"/> On

[POP3/IMAP4/SMTP>>](#)

If you are unsure of any of these items, contact your system administrator.

✓ Related Information

- [Configure the Brother Machine for Email or Internet Fax \(I-Fax\)](#)
- [Forward Received Email and Fax Messages](#)



Send an Internet Fax (I-Fax)

Sending an I-Fax is like sending a normal fax. Make sure that your recipient's information is saved in your email address book, and load the document you want to I-Fax into your Brother machine.



- If the computer to which you want to send a document is not running Windows Server® 2008/2012/2012 R2/2016, Windows® 7, Windows® 8, or Windows® 10, ask the computer's owner to install software that can view TIFF files.
- To send multiple pages, use the ADF.

1. Load your document.
2. Do one of the following:
 - If Fax Preview is set to [Off], press [Fax].
 - If Fax Preview is set to [On], press [Fax], and then press [Sending Fax(es)].
3. To change the fax-sending settings, press [Options].
4. Swipe up or down or press ▲ or ▼ to scroll through the fax settings. When the setting you want appears, press it and select your preference. When you have finished changing settings, press [OK]. (If the [OK] button is displayed.)
5. Do one of the following:
 - Press , and then enter the email address using the Touchscreen.
 - Press [Address Book], select the email address of your recipient, and then press [Apply].
6. Press [Fax Start].

The machine starts scanning. After the document is scanned, it is transmitted to the recipient via your SMTP server. You can cancel the send operation by pressing  during scanning.
7. Press .



Related Information

- [Configure the Brother Machine for Email or Internet Fax \(I-Fax\)](#)

How Your Brother Machine Receives an Internet Fax (I-Fax)

When your Brother machine receives an incoming I-Fax, it will print the I-Fax automatically. To receive an I-Fax, we recommend using the control panel or Web Based Management to configure the following optional items:

- **Auto Polling**
- **Polling Frequency**
- **Print Mail Header**
- **Delete/Read Receive Error Mail**
- **Send Delivery Notification (Receive)**

E-mail Receive

Auto Polling	<input type="radio"/> Off <input checked="" type="radio"/> On
Polling Frequency	<input type="text" value="10"/> minute(s)
Print Mail Header	<input type="text" value="None"/>
Delete/Read Receive Error Mail	<input type="radio"/> Off <input checked="" type="radio"/> On
Send Delivery Notification (Receive)	<input type="text" value="Off"/>

[POP3/IMAP4/SMTP>>](#)

There are two ways you can receive email messages:

- POP3/IMAP4 receiving at regular intervals
- POP3/IMAP4 receiving, manually initiated

When using POP3/IMAP4 receiving, the machine polls your email server to receive data. Polling can occur at set intervals (for example, you can configure the machine to poll the email server every ten minutes) or you can manually poll the server.



- If your machine starts to receive email data, the LCD displays [Receiving]. The email will be printed automatically.
- If your machine is out of paper when receiving data, the received data will be held in the machine's memory. This data will be printed automatically after paper is reloaded in the paper tray.
- When the machine's Temporary Fax Backup Function is turned on, received data will be stored for a certain period of time.
- If the received mail is not in a plain text format, or an attached file is not in the TIFF-F format, the error message "**ATTACHED FILE FORMAT NOT SUPPORTED**" will be printed.
- If the received mail is too large, the error message "**E-MAIL FILE TOO LARGE**" will be printed.
- If **Delete/Read Receive Error Mail** is **On** (default), then the error mail will be deleted from the email server automatically.



Related Information

- [Configure the Brother Machine for Email or Internet Fax \(I-Fax\)](#)
 - [How Your Computer Receives an I-Fax](#)
 - [Forward Received Email and Fax Messages](#)
-

Poll the Server Manually

1. Press  [Settings] > [All Settings] > [Network] > [E-mail/IFAX] > [Manual Receive].



If your machine displays the [All Settings] menu on the Home screen, skip the [Settings] menu.

2. Press [Yes] to confirm.
3. The LCD displays [Receiving] and your machine will print the data from the email server.



Related Information

- [Configure the Brother Machine for Email or Internet Fax \(I-Fax\)](#)

How Your Computer Receives an I-Fax

When your computer receives an I-Fax, you will receive an email in your email application. The incoming I-Fax is attached to an email message that notifies you in its **Subject** line that your email server has received an I-Fax. You can either wait for your Brother machine to poll the email server, or you can manually poll the email server to receive the incoming data.



Related Information

- [Configure the Brother Machine for Email or Internet Fax \(I-Fax\)](#)
 - [How Your Brother Machine Receives an Internet Fax \(I-Fax\)](#)
-

Forward Received Email and Fax Messages

Use Brother's I-Fax feature to forward email or standard fax messages to another computer, to a fax machine, or to another I-Fax machine. Enable the Forwarding feature using your machine's control panel.

To enable forwarding using your machine's control panel :

1. Press  [Settings] > [All Settings] > [Fax] > [Setup Receive] > [Memory Receive] > [Fax Forward].



If your machine displays the [All Settings] menu on the Home screen, skip the [Settings] menu.

2. Enter the recipient's fax number or email address using the Touchscreen.
3. Do one of the following:
 - Press [Manual] to enter the forwarding fax number (up to 20 characters) using the LCD.
Press [OK].
 - Press [Address Book].
Swipe up or down or press ▲ or ▼ to scroll until you find the fax number or email address where you want your faxes to be forwarded.
Press the fax number or email address you want.
4. Select the file type you want.



Press [Backup Print: On] to print received faxes at your machine so you will have a copy.

5. Press .



Related Information

- [Configure the Brother Machine for Email or Internet Fax \(I-Fax\)](#)
- [Fax Using the Internet \(I-Fax\)](#)
- [Initial Setup for Email or Internet Fax \(I-Fax\)](#)
- [How Your Brother Machine Receives an Internet Fax \(I-Fax\)](#)

Relay Broadcast

A Relay Broadcast is when your Brother machine receives a message over the Internet and then relays it to another fax machine using conventional telephone lines. If you must fax a document over a long distance or abroad, use the Relay Broadcast Function to save the communication fee.

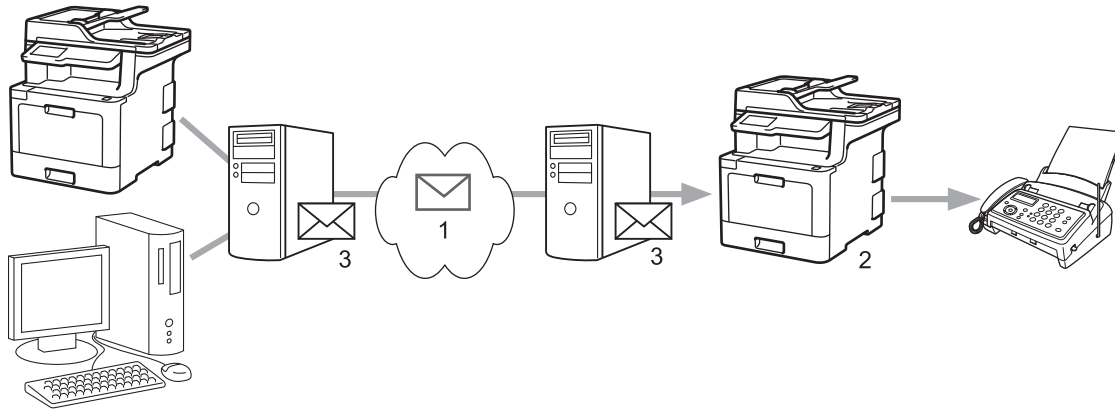

1. The Internet
2. Telephone line
3. Email server

Use the Brother machine's control panel or Web Based Management to configure the following items:

- **Relay Broadcast Function**

Set the **Relay Broadcast Function** to **On**.

- **Relay Domain**

Configure your machine's domain name on the machine that will broadcast the document to the conventional fax machine. If you wish to use your machine as a relay broadcast device, you must specify the trusted domain name (the portion of the name after the "@" sign) at the machine. Use care in selecting a trusted domain: any user on a trusted domain will be able to send a relay broadcast. You can register up to ten domain names.

- **Relay Broadcast Report**

Specify whether or not you want a report to print after the machine completes the relay broadcast.

Relay Function

Relay Broadcast Function Off On

Relay Domain

Relay Broadcast Report Off On



Related Information

- [Configure the Brother Machine for Email or Internet Fax \(I-Fax\)](#)
 - [Relay Broadcast from Your Brother Machine](#)
 - [Relay Broadcast from Your Computer](#)
-

Relay Broadcast from Your Brother Machine

Use the Relay Broadcast Function to send email from your machine to a conventional fax machine.

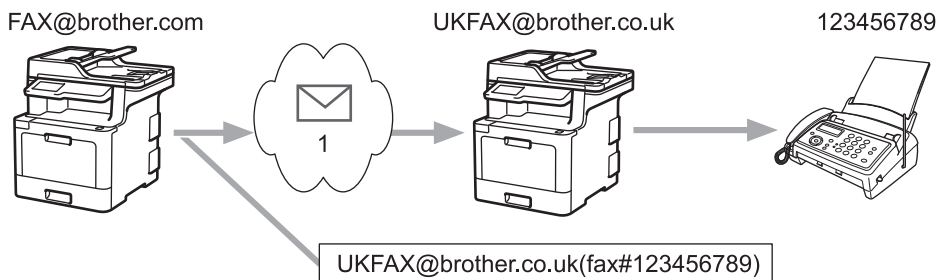

1. The Internet

In this example, your machine's email address is FAX@brother.com and you want to send a document from your machine to a standard fax machine in England with the email address UKFAX@brother.co.uk, and you want your machine to send the document using a conventional telephone line.

1. Load your document.
2. Do one of the following:
 - If Fax Preview is set to [Off], press [Fax].
 - If Fax Preview is set to [On], press [Fax], and then press [Sending Fax(es)].
3. Press [Options].
4. Swipe up or down or press ▲ or ▼ to display the [Broadcasting] option.
5. Press [Broadcasting].
6. Press [Add Number].
7. You can add email addresses to the broadcast in the following ways:
 - Press [Add Number] and press , enter the email address and press [OK].
 - Press [Add from Address book]. Press the check box of the email address you want to add to the broadcast. After you have selected all the email addresses you want, press [OK].
 - Press [Search in Address book]. Enter the name and press [OK]. The search results will be displayed. Press the name and then press the email address you want to add to the broadcast.

The following is an example of how to enter the email address and phone number:

UKFAX@brother.co.uk(fax#123456789)

E-mail address Fax Phone Number

The word "fax#" must be included with the phone number inside the parenthesis.

After you have entered all of the fax numbers, press [OK].



If your machine displays , press .

8. Press [Fax Start].



Related Information

- [Relay Broadcast](#)
-

Relay Broadcast from Your Computer

Use the Relay Broadcast Function to send email from your computer to a conventional fax machine.

Some email applications do not support sending an email to multiple fax numbers. If your email application cannot support multiple fax numbers, you can relay to only one fax machine at a time.

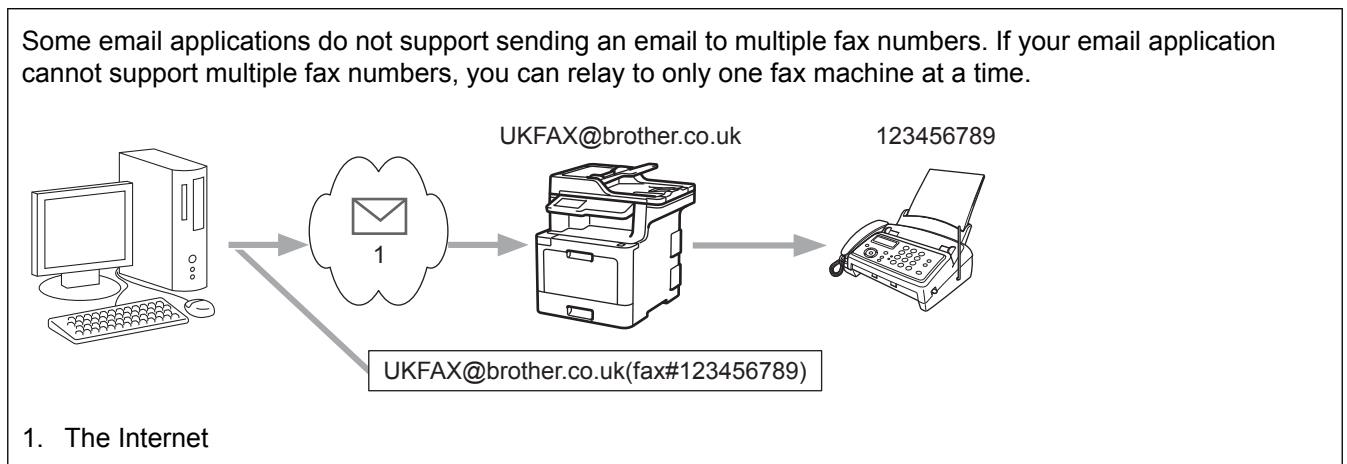

If you are sending an email to a conventional fax machine, the method of entering the fax machine's fax number will vary, depending on the mail application you are using.

1. In your email application, create a new mail message and type the email address of the relay machine and fax number of the first fax machine in the "TO" box.

The following is an example of how to enter the email address and fax number:

UKFAX@brother.co.uk(fax#123456789)

E-mail address Fax Phone Number

The word "fax#" must be included with the phone number inside the parenthesis.



For Microsoft® Outlook®, the address information must be entered into the address book as follows:

Name: fax#123456789

Email address: UKFAX@brother.co.uk

2. Type the email address of the relay machine and fax number of the second fax machine in the "TO" box.
3. Send the email.

✓ Related Information

- [Relay Broadcast](#)

I-Fax Options

- [Internet Fax \(I-Fax\) Verification Mail](#)
- [I-Fax Error Mail](#)
- [Configure the Brother Machine for Email or Internet Fax \(I-Fax\)](#)

Internet Fax (I-Fax) Verification Mail

- Verification Mail for sending allows you to request notification from the receiving station where your I-Fax or email was received and processed.
- Verification Mail for receiving allows you to transmit a default report back to the sending station after successfully receiving and processing an I-Fax or email.

To use this feature, set the [Notification] options in the [Setup Mail RX] and [Setup Mail TX] options of your Brother machine's control panel menu.



Related Information

- [I-Fax Options](#)
- [Enable Send Notifications for TX Verification Mail](#)
- [Enable Receive Notification for TX Verification Mail](#)

Enable Send Notifications for TX Verification Mail

1. Press  [Settings] > [All Settings] > [Network] > [E-mail/IFAX] > [Setup Mail TX] > [Notification].



If your machine displays the [All Settings] menu on the Home screen, skip the [Settings] menu.

2. Select [On] or [Off] to enable or disable the Send Notification feature.

When Send Notification is On, the fax includes an additional field, named Message Disposition Notification (MDN), that contains message delivery information. By default, Send Notification is set to Off.



Your fax recipient's machine must support the MDN field in order to send a notification report.

3. Press .



Related Information

- [Internet Fax \(I-Fax\) Verification Mail](#)

Enable Receive Notification for TX Verification Mail

1. Press  [Settings] > [All Settings] > [Network] > [E-mail/IFAX] > [Setup Mail RX] > [Notification].



If your machine displays the [All Settings] menu on the Home screen, skip the [Settings] menu.

2. Press one of the three possible settings:

Option	Description
Receive Notification On	When Receive Notification is On, a template is sent back to the sender to indicate successful reception and processing of the message. These templates depend on the operation requested by the sender. Example: SUCCESS: Received From <Mail Address>
Receive Notification MDN	When Receive Notification is MDN, a report to indicate successful reception and processing is sent back to the sender if the originating station sent a request confirmation to the MDN (Message Disposition Notification) field.
Receive Notification Off	When Receive Notification is Off, all forms of receive notification are disabled and no message is sent back to the sender regardless of the request.



- To send TX Verification Mail, the Sender must configure these settings:
 - Switch [Notification] in [Setup Mail TX] to [On].
 - Switch [Header] in [Setup Mail RX] to [All] or [Subject+From+To].
- To receive TX Verification Mail, the Receiver must configure these settings:
 - Switch [Notification] in [Setup Mail RX] to [On].

3. Press .



Related Information

- [Internet Fax \(I-Fax\) Verification Mail](#)

I-Fax Error Mail

If there is a delivery error while sending an I-Fax, the mail server will send an error message back to the Brother machine and the error message will be printed.

If there is an error while receiving an I-Fax, an error message will be printed, for example, "The message being sent to the machine was not in a TIFF format."

To receive the error mail and have it print on your machine, in [Setup Mail RX], switch the [Header] option to [All] or to [Subject+From+To].



Related Information

- [I-Fax Options](#)

Use the Send Fax to Server Feature

MFC-L8900CDW: standard, MFC-L8610CDW: available as a download

The Fax to Server feature allows the machine to scan a document and send it over the network to a separate fax server. The document will then be sent from the server as fax data to the destination fax number over standard phone lines. When the Fax to Server feature is set to On, all automatic fax transmissions from the machine will be sent to the fax server for fax transmission.

You can send a fax directly from the machine using the manual fax feature when the Send to Server feature is on.

(MFC-L8610CDW)

To use this function, go to your model's **Downloads** page on the Brother Solutions Center at support.brother.com to update your machine's firmware or the program in your machine.



Related Information

- [Advanced Network Features](#)
- [Before Sending a Fax to the Fax Server](#)
- [Enable Fax to Server](#)
- [Operate Fax to Server](#)

Before Sending a Fax to the Fax Server

MFC-L8900CDW: standard, MFC-L8610CDW: available as a download

To send a document to the fax server, the correct syntax for that server must be used. The destination fax number must be sent with a prefix and a suffix that match the parameters used by the fax server. In most cases, the syntax for the prefix is "fax=" and the syntax for the suffix would be the domain name of the fax server email gateway. The suffix must also include the "@" symbol at the beginning of the suffix. The prefix and the suffix information must be stored in the machine before you can use the Fax to server function. Destination fax numbers can be saved in the address book or entered using the dial pad (up to 40-digit numbers). For example: if you wanted to send a document to a destination fax number of 123-555-0001, use the following syntax:

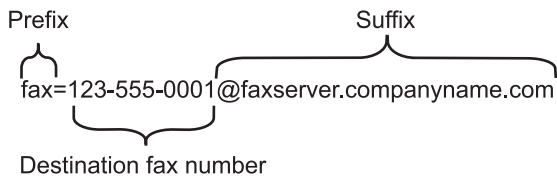

Your fax server application must support an email gateway.



Related Information

- [Use the Send Fax to Server Feature](#)

Enable Fax to Server

MFC-L8900CDW:standard, MFC-L8610CDW: available as a download

- Store the prefix/suffix address for the fax server in your Brother machine.

1. Press  [Settings] > [All Settings] > [Network] > [Fax to Server].



If your machine displays the [All Settings] menu on the Home screen, skip the [Settings] menu.

2. Press [Fax to Server].
3. Press [On].
4. Press [Prefix].
5. Enter the prefix using the Touchscreen, and then press [OK].
6. Press [Suffix].
7. Enter the suffix using the Touchscreen, and then press [OK].
8. Press .



Related Information

- [Use the Send Fax to Server Feature](#)

Operate Fax to Server

1. Place the document in the ADF or on the scanner glass.
2. Enter the fax number.
3. Press [Fax Start].

The machine will send the message over a TCP/IP network to the fax server.



Related Information

- [Use the Send Fax to Server Feature](#)
-

Print the WLAN Report

The WLAN Report reflects your machine's wireless status. If the wireless connection fails, check the error code on the printed report.

1. Press  [Settings] > [All Settings] > [Print Reports] > [WLAN Report].



If your machine displays the [All Settings] menu on the Home screen, skip the [Settings] menu.

2. Press [Yes].
The machine will print the WLAN Report.
3. Press .

If the WLAN Report does not print, check your machine for errors. If there are no visible errors, wait for one minute and then try to print the report again.



Related Information

- [Advanced Network Features](#)
- [Wireless LAN Report Error Codes](#)
- [My Brother Machine Cannot Print, Scan, or PC-FAX Receive over the Network](#)
- [I Want to Check that My Network Devices are Working Correctly](#)

Wireless LAN Report Error Codes

If the Wireless LAN Report shows that the connection failed, check the error code on the printed report and see the corresponding instructions in the table:

Error Code	Problem and Recommended Solutions
TS-01	<p>The wireless setting is not activated, change the wireless setting to ON.</p> <p>If a network cable is connected to your machine, disconnect it and change the wireless setting of your machine to ON.</p>
TS-02	<p>The wireless access point/router cannot be detected.</p> <ol style="list-style-type: none"> Check the following two points: <ul style="list-style-type: none"> Unplug the power to your wireless access point/router, wait for 10 seconds, and then plug it back in. If your WLAN access point/router is using MAC address filtering, confirm that the MAC address of the Brother machine is allowed in the filter. If you manually entered the SSID and security information (SSID/authentication method/encryption method/Network Key), the information may be incorrect. Reconfirm the SSID and security information and re-enter the correct information as necessary. <p>This device does not support a 5 GHz SSID/ESSID and you must select a 2.4 GHz SSID/ESSID. Make sure the access point/router is set to 2.4 GHz or 2.4 GHz/5 GHz mixed mode.</p>
TS-03	<p>The wireless network and security setting you entered may be incorrect. Reconfirm the wireless network settings.</p> <p>If you do not know this information, ask your network administrator.</p>
TS-04	<p>The Authentication/Encryption methods used by the selected wireless access point/router are not supported by your machine.</p> <p>Change the authentication and encryption method of the wireless access point/router. Your machine supports the following authentication methods:</p> <ul style="list-style-type: none"> WPA-Personal TKIP or AES WPA2-Personal TKIP or AES Open WEP or None (without encryption) Shared key WEP <p>If your problem is not solved, the SSID or network settings you entered may be incorrect. Confirm the wireless network settings.</p>
TS-05	<p>The security information (SSID/Network Key) is incorrect.</p> <p>Confirm the wireless security information (Authentication method/Encryption method/Network Key).</p>
TS-06	<p>The machine cannot detect a WLAN access point/router that has WPS enabled.</p> <p>Confirm the wireless security information (Authentication method/Encryption method/Network Key).</p>
TS-07	<p>The machine cannot detect a WLAN access point/router that has WPS enabled.</p> <p>If you want to connect with WPS, you must operate both your machine and the WLAN access point/router. Confirm the connection method for WPS on WLAN access point/router and try starting again.</p> <p>If you do not know how to operate your WLAN access point/router using WPS, see the documentation provided with your WLAN access point/router, ask the manufacturer of your WLAN access point/router or ask your network administrator.</p>

Error Code	Problem and Recommended Solutions
TS-08	Two or more WLAN access points that have WPS enabled are detected. <ul style="list-style-type: none">• Confirm that only one WLAN access point/router within range has the WPS method active and try again.• Try starting again after few minutes in order to avoid effects from other access points.



Related Information

- [Print the WLAN Report](#)
 - [My Brother Machine Cannot Print, Scan, or PC-FAX Receive over the Network](#)
 - [I Want to Check that My Network Devices are Working Correctly](#)
 - [Configure Your Machine for a Wireless Network Using the One Push Method of Wi-Fi Protected Setup™ \(WPS\)](#)
 - [Configure Your Machine for a Wireless Network Using the PIN Method of Wi-Fi Protected Setup™ \(WPS\)](#)
 - [Configure Your Machine for a Wireless Network Using the Machine's Control Panel Setup Wizard](#)
 - [Configure Your Machine for a Wireless Network When the SSID Is Not Broadcast](#)
 - [Configure Your Machine for an Enterprise Wireless Network](#)
-

Configure and Operate LDAP Search

MFC-L8900CDW: standard, MFC-L8610CDW: available as a download

The LDAP feature allows you to search for information, such as fax numbers and email addresses, on your server. When you use the Fax, I-Fax, or Scan to Email server feature, you can use the LDAP search to find fax numbers or email addresses.



- The LDAP feature does not support simplified Chinese, traditional Chinese, or Korean.
- The LDAP feature supports LDAPv3.
- The LDAP feature does not support SSL/TLS.
- (MFC-L8610CDW)

To use this function, go to your model's **Downloads** page on the Brother Solutions Center at support.brother.com to update your machine's firmware or the program in your machine.



Related Information

- [Advanced Network Features](#)
- [Change LDAP Configuration Using Web Based Management](#)
- [Perform an LDAP Search Using Your Machine's Control Panel](#)

Change LDAP Configuration Using Web Based Management

Use Web Based Management to configure your LDAP settings in a web browser.

1. Start your web browser.
2. Type "http://machine's IP address" in your browser's address bar (where "machine's IP address" is the machine's IP address).
For example:
http://192.168.1.2
3. No password is required by default. Type a password if you have set one, and then click .
4. Click the **Network** tab.
5. Click the **Protocol** menu in the left navigation bar.
6. Select the **LDAP** check box, and then click **Submit**.
7. Restart your Brother machine to activate the configuration.
8. On your computer, in Web Based Management's **Address Book** tab, select **LDAP** in the left navigation bar.
 - **LDAP Search**
 - **LDAP Server Address**
 - **Port** (The default port number is 389.)
 - **Search Root**
 - **Authentication**
 - **Username**
This selection will be available depending on the authentication method used.
 - **Password**
This selection will be available depending on the authentication method used.



- If the LDAP server supports Kerberos authentication, we recommend selecting Kerberos for the Authentication settings. It provides strong authentication between the LDAP server and your machine.
- You must configure the SNTP protocol (network time server), or you must set the date, time and time zone correctly on the control panel for Kerberos authentication.

- **Kerberos Server Address**
This selection will be available depending on the authentication method used.
 - **Timeout for LDAP**
 - **Attribute of Name (Search Key)**
 - **Attribute of E-mail**
 - **Attribute of Fax Number**
9. When finished, click **Submit**. Make sure the **Status** field reads **OK**.



Related Information

- [Configure and Operate LDAP Search](#)
- [Synchronize Time with the SNTP Server Using Web Based Management](#)

Perform an LDAP Search Using Your Machine's Control Panel

After you configure LDAP settings, you can use the LDAP search feature to find fax numbers or email addresses to use for:

- Sending a Fax
- Sending an Internet Fax (I-Fax)
- Scanning to Email Server



- The LDAP feature supports LDAPv3.
- The LDAP feature does not support SSL/TLS.
- You may need to use Kerberos Authentication or Simple Authentication to connect to your LDAP server, depending on the security policy set by your network administrator.
- You must configure the SNTP protocol (network time server), or you must set the date, time and time zone correctly on the control panel for Kerberos authentication.

1. Press  to search.
2. Enter the initial characters for your search using the LCD.
3. Press [OK].

The LDAP search result will be shown on the LCD; the  icon appears before the fax number (local) or the email (local) address book search results.

- If there is no match on the server or the email (local) address book, the LCD displays [Results cannot be found.] for about 60 seconds.
4. Swipe up or down or press ▲ or ▼ to display the name you want.
 5. Press the name.
To view the details of the name, press [Detail].
 6. If the result includes more than one fax number or email address, the machine will prompt you to select just one. Press [Apply]. Do one of the following:
 - If you are sending a fax or an I-Fax, press [Fax Start].
 - If you are scanning to the Email Server, load your document, press [Next], and then press [Start].



Related Information

- [Configure and Operate LDAP Search](#)
- [Synchronize Time with the SNTP Server Using Web Based Management](#)

Synchronize Time with the SNTP Server Using Web Based Management

The Simple Network Time Protocol (SNTP) is used to synchronize the time used by the machine for authentication with the SNTP time server. (This is not the time displayed on the machine's LCD.) You can automatically or manually synchronize the machine's time with the Coordinated Universal Time (UTC) provided by the SNTP time server.

- [Configure Date and Time Using Web Based Management](#)
- [Configure the SNTP Protocol Using Web Based Management](#)
- [Change LDAP Configuration Using Web Based Management](#)
- [Perform an LDAP Search Using Your Machine's Control Panel](#)

Configure Date and Time Using Web Based Management

Configure date and time to synchronize the time used by the machine with the SNTP time server.

This feature is not available in some countries.

1. Start your web browser.
2. Type "http://machine's IP address" in your browser's address bar (where "machine's IP address" is the machine's IP address).

For example:

http://192.168.1.2

3. No password is required by default. Type a password if you have set one, and then click .
4. Click the **Administrator** tab.
5. Click **Date&Time** in the left navigation bar.

Date&Time

Date / /

Clock Type 12h Clock 24h Clock

Time :

Time Zone

Auto Daylight Off On

Synchronize with SNTP server

To synchronize the "Date&Time" with your SNTP server you must configure the SNTP server settings.

[SNTP>>](#)



Select the time difference between your location and UTC from the **Time Zone** drop-down list. For example, the time zone for Eastern Time in the USA and Canada is UTC-05:00.

6. Verify the **Time Zone** settings.
7. Select the **Synchronize with SNTP server** check box.
8. Click **Submit**.



Related Information

- [Synchronize Time with the SNTP Server Using Web Based Management](#)

Configure the SNTP Protocol Using Web Based Management

Configure the SNTP protocol to synchronize the time the machine uses for authentication with the time kept by the SNTP time server.

1. Start your web browser.
2. Type "http://machine's IP address" in your browser's address bar (where "machine's IP address" is the machine's IP address).

For example:

http://192.168.1.2

3. No password is required by default. Type a password if you have set one, and then click .
4. Click the **Network** tab.
5. Click the **Protocol** menu in the left navigation bar.
6. Select the **SNTP** check box to activate the settings.
7. Click **Submit**.
8. Restart your Brother machine to activate the configuration.
9. Next to the SNTP check box, click **Advanced Settings** and follow the instructions below:

SNTP

Status Enabled

Synchronization Status Succeeded

SNTP Server Method

Primary SNTP Server Address

Primary SNTP Server Port

Secondary SNTP Server Address

Secondary SNTP Server Port

Synchronization Interval hour(s)

[Date&Time>>](#)

Option	Description
Status	Displays whether the SNTP protocol is enabled or disabled.
Synchronization Status	Confirm the latest synchronization status.
SNTP Server Method	Select AUTO or STATIC . <ul style="list-style-type: none">• AUTO If you have a DHCP server in your network, the SNTP server will obtain the address from that server automatically.• STATIC Type the address you want to use.

Option	Description
Primary SNTP Server Address	Type the server address (up to 64 characters).
Secondary SNTP Server Address	The secondary SNTP server address is used as a backup to the primary SNTP server address. If the primary server is unavailable, the machine will contact the secondary SNTP server.
Primary SNTP Server Port	Type the port number (1-65535).
Secondary SNTP Server Port	The secondary SNTP server port is used as a backup to the primary SNTP server port. If the primary port is unavailable, the machine will contact the secondary SNTP port.
Synchronization Interval	Type the number of hours between server synchronization attempts (1-168 hours).

10. Click **Submit**.



Related Information

- [Synchronize Time with the SNTP Server Using Web Based Management](#)
-

Technical Information for Advanced Users

- [Gigabit Ethernet \(Wired Network Only\)](#)
- [Reset the Network Settings to the Factory Settings](#)

Gigabit Ethernet (Wired Network Only)

Your machine supports 1000BASE-T Gigabit Ethernet. To connect to a 1000BASE-T Gigabit Ethernet Network, you must set the machine's Ethernet link mode to Auto from the machine's control panel or Web Based Management (web browser).



- Use a straight-through Category 5e (or greater) twisted-pair cable. When you connect the machine to a Gigabit Ethernet Network, use the network devices complying with 1000BASE-T.



Related Information

- [Technical Information for Advanced Users](#)
- [Configure the Gigabit Ethernet Settings Using Web Based Management](#)

Configure the Gigabit Ethernet Settings Using Web Based Management

1. Start your web browser.
2. Type "http://machine's IP address" in your browser's address bar (where "machine's IP address" is the machine's IP address).
For example:
http://192.168.1.2
3. No password is required by default. Type a password if you have set one, and then click .
4. Click the **Network** tab.
5. Click **Wired**.
6. Click **Ethernet** in the left navigation bar.
7. Select **Auto** from the **Ethernet Mode** drop-down list.
8. Click **Submit**.
9. To enable the settings, restart your machine.

You can confirm your settings by printing the Network Configuration Report.



Related Information

- [Gigabit Ethernet \(Wired Network Only\)](#)
- [Print the Network Configuration Report](#)

Reset the Network Settings to the Factory Settings

You can use your machine's control panel to reset the print server to its default factory settings. This resets all information, such as the password and IP address.



- This feature restores all wired (supported models only) and wireless network settings to the factory settings.
- You can also reset the print server to its factory settings using BRAdmin Light, BRAdmin Professional 3, or Web Based Management.

1. Press  [Settings] > [All Settings] > [Network] > [Network Reset].



If your machine displays the [All Settings] menu on the Home screen, skip the [Settings] menu.

2. [Machine will reboot after resetting. Press [OK] for 2 seconds to confirm.] appears. Press [OK] for two seconds to confirm.

The machine will restart.



Related Information

- [Technical Information for Advanced Users](#)

Security

- [Lock the Machine Settings](#)
- [Network Security Features](#)

Lock the Machine Settings

Before turning on the machine's Access Lock, make a careful note of your password. If you forget the password, you must reset all passwords stored in the machine by contacting your administrator or Brother Customer Service.

- [Setting Lock Overview](#)
- [Customization of Your Machine](#)

Setting Lock Overview

Use the Setting Lock feature to block unauthorized access to machine settings.

When Setting Lock is set to On, you cannot access the machine settings without entering the password.

- [Set the Setting Lock Password](#)
- [Change the Setting Lock Password](#)
- [Turn On Setting Lock](#)
- [Restrict Specific Machine Settings](#)

Set the Setting Lock Password

>> [MFC-L8610CDW](#)

>> [MFC-L8900CDW](#)

MFC-L8610CDW

1. Press  [Settings] > [All Settings] > [General Setup] > [Setting Lock].



If your machine displays the [All Settings] menu on the Home screen, skip the [Settings] menu.

2. Enter a four-digit number for the password.
3. Press [OK].
4. When the LCD displays [Verify], re-enter the password.
5. Press [OK].
6. Press .

MFC-L8900CDW

1. Press [Admin Settings] > [Password].



This password is also valid for other [Admin Settings] features and Web Based Management login.

2. Type the password you want to use. (8 to 32 characters), and then press [OK].
3. When the LCD displays [Verify], retype the password, and then press [OK].
4. When the machine prompts you to select next step, choose your selection.
5. Press .



Related Information

- [Setting Lock Overview](#)

Change the Setting Lock Password

>> [MFC-L8610CDW](#)

>> [MFC-L8900CDW](#)

MFC-L8610CDW

1. Press  [Settings] > [All Settings] > [General Setup] > [Setting Lock] > [Set Password].



If your machine displays the [All Settings] menu on the Home screen, skip the [Settings] menu.

2. Enter the current four-digit password.
3. Press [OK].
4. Enter a new four-digit password.
5. Press [OK].
6. When the LCD displays [Verify], re-enter the password.
7. Press [OK].
8. Press .

MFC-L8900CDW

1. Press [Admin Settings].
2. Type the current password, and then press [OK].
3. Press [Password].
4. Type the current password again, and then press [OK].
5. Type a new password you want to use (8 to 32 characters), and then press [OK].
6. When the LCD displays [Verify], retype the password, and then press [OK].
7. Press .



Related Information

- [Setting Lock Overview](#)

Turn On Setting Lock

>> [MFC-L8610CDW](#)

>> [MFC-L8900CDW](#)

MFC-L8610CDW

1. Press  [Settings] > [All Settings] > [General Setup] > [Setting Lock] > [Lock Off⇒On].



If your machine displays the [All Settings] menu on the Home screen, skip the [Settings] menu.

2. Enter the current four-digit password.
3. Press [OK].



To turn off Setting Lock, press  on the LCD, enter the current four-digit password, and then press [OK].

MFC-L8900CDW

1. Press [Admin Settings].
2. Type the current password, and then press [OK].
3. Press [Restriction Management] > [Setting Lock] > [On].
4. When the machine prompts you to select the next step, choose your selection.



To turn off Setting Lock, repeat the step 1 and 2, and then press [Restriction Management] > [Setting Lock] > [Off].



Related Information

- [Setting Lock Overview](#)

Restrict Specific Machine Settings

Related Models: MFC-L8900CDW

1. Press [Admin Settings].
2. Enter the current Administrator password, and then press [OK].
3. Press [Restriction Management] > [Setting Lock Details].
4. Choose the machine settings you want to restrict, and then press [OK].
5. Press .



Related Information

- [Setting Lock Overview](#)

Network Security Features

- [Before Using Network Security Features](#)
- [Secure Function Lock 3.0](#)
- [Use Active Directory® Authentication](#)
- [Use LDAP Authentication](#)
- [Manage Your Network Machine Securely Using SSL/TLS](#)
- [Manage Your Network Machine Securely Using IPsec](#)
- [Send or Receive an Email Securely](#)
- [Use IEEE 802.1x Authentication for a Wired or a Wireless Network](#)
- [Store Print Log to Network](#)
- [Customization of Your Machine](#)

Before Using Network Security Features

Your Brother machine employs some of the latest network security and encryption protocols available today. These network features can be integrated into your overall network security plan to help protect your data and prevent unauthorized access to the machine.



We recommend disabling the Telnet, FTP server and TFTP protocols. Accessing the machine using these protocols is not secure.



Related Information

- [Network Security Features](#)
-

Secure Function Lock 3.0

Brother's Secure Function Lock 3.0 increases security by restricting the functions available on your Brother machine.

- [Before Using Secure Function Lock 3.0](#)
- [Configure Secure Function Lock 3.0 Using Web Based Management](#)
- [Scan Using Secure Function Lock 3.0](#)
- [Configure Public Mode for Secure Function Lock 3.0](#)
- [Additional Secure Function Lock 3.0 Features](#)
- [Register a new ID Card Using the Machine's Control Panel](#)

Before Using Secure Function Lock 3.0

Use Secure Function Lock to configure passwords, set specific user page limits, and grant access to some or all of the functions listed here.

You can configure and change the following Secure Function Lock 3.0 settings using Web Based Management or BRAdmin Professional 3 (Windows®):

- **Print**

Print includes print jobs sent via AirPrint, Google Cloud Print™ and Brother iPrint&Scan.

If you register users' login names in advance, the users do not need to enter their passwords when they use the print function.

- **Color Print**

- **Copy**

- **Scan**

Scan includes scan jobs sent via Brother iPrint&Scan.

- **Send** (supported models only)

- **Receive** (supported models only)

- **USB Direct Print**

- **Scan to USB** (supported models only)

- **Web Connect** (supported models only)

- **Apps** (supported models only)

- **Page Limits**

- **Page Counters**

- **Card ID (NFC ID)** (supported models only)

If you register users' Card IDs in advance, registered users can activate the machine by touching their registered cards to the machines' NFC symbol.



Related Information

- [Secure Function Lock 3.0](#)

Configure Secure Function Lock 3.0 Using Web Based Management

1. Start your web browser.
2. Type "http://machine's IP address" in your browser's address bar (where "machine's IP address" is the machine's IP address).
For example:
http://192.168.1.2
3. No password is required by default. Type a password if you have set one, and then click .
4. Click the **Administrator** tab.
5. Click the **User Restriction Function** menu in the left navigation bar.
6. Select **Secure Function Lock**.
7. Click **Submit**.
8. Click the **Restricted Functions** menu in the left navigation bar.
9. In the **User List / Restricted Functions** field, type a group name or user name.
10. In the **Print** and the other columns, select a check box to allow or clear a check box to restrict the function listed.
11. To configure the maximum page count, select the **On** check box in the **Page Limits** column, and then type the maximum number in the **Max. Pages** field.
12. Click **Submit**.
13. Click the **User List** menu in the left navigation bar.
14. In the **User List** field, type the user name.
15. In the **PIN Number** field, type a four-digit password.
16. In the **E-mail Address** field, type the user's email address (Available only for certain models).
17. To register the user's Card ID, type the card number in the **Card ID (NFC ID)** field (Available only for certain models) .
18. Select **User List / Restricted Functions** from the drop-down list for each user.
19. Click **Submit**.



Related Information

- [Secure Function Lock 3.0](#)

Scan Using Secure Function Lock 3.0

Setting Scan restrictions (for administrators)

Secure Function Lock 3.0 allows an administrator to restrict which users are allowed to scan. When the Scan feature is set to Off for the public user setting, only users who have the **Scan** check box selected will be able to scan.

Using the Scan feature (for restricted users)

- To scan using the machine's control panel:
Restricted users must enter their PINs on the machine's control panel to access Scan mode.
- To scan from a computer:
Restricted users must enter their PINs on the machine's control panel before scanning from their computers. If the PIN is not entered on the machine's control panel, an error message will appear on the user's computer.



Related Information

- [Secure Function Lock 3.0](#)

Configure Public Mode for Secure Function Lock 3.0

Use the Secure Function Lock screen to set up Public Mode, which limits the functions available to public users. Public users will not need to enter a password to access the features made available through Public Mode settings.



Public Mode includes print jobs sent via AirPrint, Google Cloud Print™ and Brother iPrint&Scan.

1. Start your web browser.
2. Type "http://machine's IP address" in your browser's address bar (where "machine's IP address" is the machine's IP address).
For example:
http://192.168.1.2
3. No password is required by default. Type a password if you have set one, and then click .
4. Click the **Administrator** tab.
5. Click the **User Restriction Function** menu in the left navigation bar.
6. Select **Secure Function Lock**.
7. Click **Submit**.
8. Click the **Restricted Functions** menu.
9. In the **Public Mode** row, select a check box to allow or clear a check box to restrict the function listed.
10. Click **Submit**.



Related Information

- [Secure Function Lock 3.0](#)
- [Register Your Machine with Google Cloud Print Using Web Based Management](#)

Additional Secure Function Lock 3.0 Features

Configure the following features in the Secure Function Lock screen:

All Counter Reset

Click **All Counter Reset**, in the **Page Counters** column, to reset the page counter.

Export to CSV file

Click **Export to CSV file**, to export the current page counter including **User List / Restricted Functions** information as a CSV file.

Card ID (NFC ID) (supported models only)

Click the **User List** menu, and then type a users' Card ID in the **Card ID (NFC ID)** field. You can use your ID card for authentication.

Last Counter Record

Click **Last Counter Record** if you want the machine to retain the page count after the counter has been reset.

Counter Auto Reset

Click **Counter Auto Reset** to configure the time interval you want between page counter reset. Choose a daily, weekly, or monthly interval.



Related Information

- [Secure Function Lock 3.0](#)

Register a new ID Card Using the Machine's Control Panel

Related Models: MFC-L8900CDW

1. Touch the NFC symbol on the machine's control panel with a registered ID Card.
2. Touch your user ID on the machine's control panel.
3. Press [Register Card].
4. Touch a new ID Card to the NFC symbol.
The new ID Card's number is registered to the machine.



For the supported ID Card types, go to the Brother Solutions Center at support.brother.com to see the **FAQs & Troubleshooting** page.

5. Press [OK].



Related Information

- [Secure Function Lock 3.0](#)
-

Use Active Directory® Authentication

- [Introduction to Active Directory® Authentication](#)
- [Configure Active Directory® Authentication Using Web Based Management](#)
- [Log On to Change the Machine Settings Using the Machine's Control Panel \(Active Directory® Authentication\)](#)

Introduction to Active Directory® Authentication

Active Directory® Authentication restricts the use of your Brother machine. If Active Directory® Authentication is enabled, the machine's control panel will be locked. You cannot change the machine's settings until you enter a User ID and password.

Active Directory® Authentication offers the following features:

- Stores incoming print data
- Stores incoming fax data
- Obtains the email address from the Active Directory® server based on your User ID, when sending scanned data to an email server.

To use this feature, select the **On** option for the **Get Mail Address** setting and **LDAP + kerberos** authentication method. Your email address will be set as the sender when the machine sends scanned data to an email server, or as the recipient if you want to send the scanned data to your email address.

When Active Directory® Authentication is enabled, your machine stores all incoming fax data. After you log on, the machine prints the stored fax data.

You can change the Active Directory® Authentication settings using Web Based Management or BRAdmin Professional 3 (Windows®).



Related Information

- [Use Active Directory® Authentication](#)

Configure Active Directory® Authentication Using Web Based Management

Active Directory® authentication supports Kerberos authentication and NTLMv2 authentication. You must configure the SNTP protocol (network time server) and DNS server configuration for authentication.

1. Start your web browser.
2. Type "http://machine's IP address" in your browser's address bar (where "machine's IP address" is the machine's IP address).
For example:
http://192.168.1.2
3. No password is required by default. Type a password if you have set one, and then click .
4. Click the **Administrator** tab.
5. Click the **User Restriction Function** menu in the left navigation bar.
6. Select **Active Directory Authentication**.
7. Click **Submit**.
8. Select **Active Directory Authentication** in the left navigation bar.
9. Configure the following settings:

Option	Description
Storage PC Print Data	Select this option to store incoming print data. After you log on to the machine, your PC print jobs will be printed automatically. This feature is available only for print data created by a Brother native printer driver.
Storage Fax RX Data	Select this option to store incoming fax data. You can print all incoming fax data after you log on to the machine.
Remember User ID	Select this option to save your User ID.
Active Directory Server Address	Type the IP address or the server name (for example: ad.example.com) of the Active Directory® Server.
Active Directory Domain Name	Type the Active Directory® domain name.
Protocol & Authentication Method	Select the protocol and authentication method.
Get Mail Address	Select this option to obtain logged on user's email address from the Active Directory® server.(available only for LDAP + kerberos authentication method)
Get User's Home Directory	Select this option to obtain your home directory as the Scan to Network destination. (available only for LDAP + kerberos authentication method)
LDAP Server Port	Type the port number to connect the Active Directory® server via LDAP (available only for LDAP + kerberos authentication method).
LDAP Search Root	Type the LDAP search root (available only for LDAP + kerberos authentication method).

10. Click **Submit**.



Related Information

- [Use Active Directory® Authentication](#)
-

Log On to Change the Machine Settings Using the Machine's Control Panel (Active Directory® Authentication)

When Active Directory® Authentication is enabled, the machine's control panel will be locked until you enter your User ID and password on the machine's control panel.

1. On the machine's control panel, use the Touchscreen to enter your User ID and Password.
2. Press [OK].
3. When authentication is successful, the machine's control panel will be unlocked.



Related Information

- [Use Active Directory® Authentication](#)

Use LDAP Authentication

- [Introduction to LDAP Authentication](#)
- [Configure LDAP Authentication Using Web Based Management](#)
- [Log On to Change the Machine Settings Using the Machine's Control Panel \(LDAP Authentication\)](#)

Introduction to LDAP Authentication

LDAP Authentication restricts the use of your Brother machine. If LDAP Authentication is enabled, the machine's control panel will be locked. You cannot change the machine's settings until you enter a User ID and password.

LDAP Authentication offers the following features:

- Stores incoming print data
- Stores incoming fax data
- Obtains the email address from the LDAP server based on your User ID, when sending scanned data to an email server.

To use this feature, select the **On** option for the **Get Mail Address** setting. Your email address will be set as the sender when the machine sends scanned data to an email server, or as the recipient if you want to send the scanned data to your email address.

When LDAP Authentication is enabled, your machine stores all incoming fax data. After you log on, the machine prints the stored fax data.

You can change the LDAP Authentication settings using Web Based Management or BRAdmin Professional 3 (Windows®).



Related Information

- [Use LDAP Authentication](#)

Configure LDAP Authentication Using Web Based Management

1. Start your web browser.
2. Type "http://machine's IP address" in your browser's address bar (where "machine's IP address" is the machine's IP address).

For example:

http://192.168.1.2

3. No password is required by default. Type a password if you have set one, and then click .
4. Click the **Administrator** tab.
5. Click the **User Restriction Function** menu in the left navigation bar.
6. Select **LDAP Authentication**.
7. Click **Submit**.
8. Click **LDAP Authentication** in the left navigation bar.
9. Configure the following settings:

Option	Description
Storage PC Print Data	Select this option to store incoming print data. After you log on to the machine, your PC print jobs will be printed automatically. This feature is available only for print data created by a Brother native printer driver.
Storage Fax RX Data	Select this option to store incoming fax data. You can print all incoming fax data after you log on to the machine.
Remember User ID	Select this option to save your User ID.
LDAP Server Address	Type the IP address or the server name (for example: ldap.example.com) of the LDAP server.
Get Mail Address ¹	Select this option to obtain logged on user's email address from the LDAP server.
Get User's Home Directory ¹	Select this option to obtain your home directory as the Scan to Network destination.
LDAP Server Port	Type the LDAP server port number.
LDAP Search Root	Type the LDAP search root directory.
Attribute of Name (Search Key)	Type the attribute you want to use as a search key.

¹ If this option is not available, update your machine's firmware. Go to your model's **Downloads** page on the Brother Solutions Center at support.brother.com.

10. Click **Submit**.



Related Information

- [Use LDAP Authentication](#)

Log On to Change the Machine Settings Using the Machine's Control Panel (LDAP Authentication)

When LDAP Authentication is enabled, the machine's control panel will be locked until you enter your User ID and password on the machine's control panel.

1. On the machine's control panel, use the Touchscreen to enter your User ID and Password.
2. Press [OK].
3. When authentication is successful, the machine's control panel will be unlocked.



Related Information

- [Use LDAP Authentication](#)

Manage Your Network Machine Securely Using SSL/TLS

- [Introduction to SSL/TLS](#)
- [Certificates and Web Based Management](#)
- [Manage Your Network Machine Securely Using Web Based Management](#)
- [Manage Your Network Machine Securely Using BRAdmin Professional 3 \(Windows®\)](#)
- [Print Documents Securely Using SSL/TLS](#)

Introduction to SSL/TLS

Secure Socket Layer (SSL) or Transport Layer Security (TLS) is an effective method of protecting data sent over a local or wide area network (LAN or WAN). It works by encrypting data, such as a print job, sent over a network, so anyone trying to capture it will not be able to read it.

SSL/TLS can be configured on both wired and wireless networks and will work with other forms of security such as WPA keys and firewalls.



Related Information

- [Manage Your Network Machine Securely Using SSL/TLS](#)
 - [Brief History of SSL/TLS](#)
 - [Benefits of Using SSL/TLS](#)
-

Brief History of SSL/TLS

SSL/TLS was originally created to secure web traffic information, particularly data sent between web browsers and servers. For example, when you use Internet Explorer® for Internet Banking and you see https:// and the little padlock icon in the web browser, you are using SSL. SSL grew to work with additional applications, such as Telnet, printer, and FTP software, in order to become a universal solution for online security. Its original design intentions are still being used today by many online retailers and banks to secure sensitive data, such as credit card numbers, customer records, etc.

SSL/TLS uses extremely high levels of encryption and is trusted by banks all over the world.



Related Information

- [Introduction to SSL/TLS](#)
-

Benefits of Using SSL/TLS

The primary benefit of using SSL/TLS on Brother machines is to guarantee secure printing over an IP network by restricting unauthorized users from reading data sent to the machine. SSL's key selling point is that it can be used to print confidential data securely. For example, an HR department in a large company may be printing wage slips on a regular basis. Without encryption, the data contained on these wages slips can be read by other network users. However, with SSL/TLS, anyone trying to capture the data will see a confusing page of code and not the actual wage slip.



Related Information

- [Introduction to SSL/TLS](#)
-

Certificates and Web Based Management

You must configure a certificate to manage your networked Brother machine securely using SSL/TLS. You must use Web Based Management to configure a certificate.

- [Supported Security Certificate Features](#)
- [Create and Install a Certificate](#)
- [Manage Multiple Certificates](#)

Supported Security Certificate Features

Your Brother machine supports the use of multiple security certificates, which allows secure management, authentication, and communication with the machine. The following security certificate features can be used with the machine:

- SSL/TLS communication
- SSL communication for SMTP/POP3/IMAP4 (only available for certain models)
- IEEE 802.1x authentication
- IPsec

The Brother machine supports the following:

- Pre-installed certificate

Your machine has a pre-installed self-signed certificate. This certificate enables you to use SSL/TLS communication without creating or installing a different certificate.



The pre-installed self-signed certificate cannot protect your communication from being compromised. We recommend using a certificate that is issued by a trusted organization for better security.

- Self-signed certificate

This print server issues its own certificate. Using this certificate, you can easily use the SSL/TLS communication without creating or installing a different certificate from a CA.

- Certificate from a Certificate Authority (CA)

There are two methods for installing a certificate from a CA. If you already have a certificate from a CA or if you want to use a certificate from an external trusted CA:

- When using a Certificate Signing Request (CSR) from this print server.
- When importing a certificate and a private key.

- Certificate Authority (CA) Certificate

To use a CA certificate that identifies the CA and owns its private key, you must import that CA certificate from the CA before configuring the security features of the Network.



- If you are going to use SSL/TLS communication, we recommend contacting your system administrator first.
- When you reset the print server back to its default factory settings, the certificate and the private key that are installed will be deleted. If you want to keep the same certificate and the private key after resetting the print server, export them before resetting, and then reinstall them.



Related Information

- [Certificates and Web Based Management](#)

Create and Install a Certificate

- [Step by Step Guide for Creating and Installing a Certificate](#)
- [Create and Install a Self-signed Certificate](#)
- [Create and Install a Certificate from a Certificate Authority \(CA\)](#)
- [Import and Export a CA Certificate](#)

Step by Step Guide for Creating and Installing a Certificate

There are two options when choosing a security certificate: use a self-signed certificate or use a certificate from a Certificate Authority (CA).

These are a brief summary of the actions required, based on the option you choose.

Option 1

Self-Signed Certificate

1. Create a self-signed certificate using Web Based Management.
2. Install the self-signed certificate on your computer.

Option 2

Certificate from a CA

1. Create a Certificate Signing Request (CSR) using Web Based Management.
2. Install the certificate issued by the CA on your Brother machine using Web Based Management.
3. Install the certificate on your computer.



Related Information

- [Create and Install a Certificate](#)

Create and Install a Self-signed Certificate

- [Create a Self-signed Certificate](#)
- [Install the Self-signed Certificate for Windows® users with Administrator Rights](#)
- [Import and Export the Self-signed Certificate on your Brother Machine](#)

Create a Self-signed Certificate

1. Start your web browser.
2. Type "http://machine's IP address" in your browser's address bar (where "machine's IP address" is the machine's IP address).

For example:

http://192.168.1.2



- If you are using a Domain Name System or enable a NetBIOS name, you can type another name, such as "SharedPrinter" instead of the IP address.

- For example:

http://SharedPrinter

If you enable a NetBIOS name, you can also use the node name.

- For example:

http://brnxxxxxxxxxxxx

The NetBIOS name can be found in the Network Configuration Report.

- For Macintosh, access Web Based Management by clicking the machine's icon on the **Status Monitor** screen.

3. No password is required by default. Type a password if you have set one, and then click .
4. Click the **Network** tab.
5. Click the **Security** tab.
6. Click **Certificate**.
7. Click **Create Self-Signed Certificate**.
8. Enter a **Common Name** and a **Valid Date**.
 - The length of the **Common Name** is less than 64 bytes. Enter an identifier, such as an IP address, node name, or domain name to use when accessing this machine through SSL/TLS communication. The node name is displayed by default.
 - A warning will appear if you use the IPPS or HTTPS protocol and enter a different name in the URL than the **Common Name** that was used for the self-signed certificate.
9. Select your setting from the **Public Key Algorithm** drop-down list. The default setting is **RSA(2048bit)**.
10. Select your setting from the **Digest Algorithm** drop-down list. The default setting is **SHA256**.
11. Click **Submit**.
12. Click **Network**.
13. Click **Protocol**.
14. Click **HTTP Server Settings**.
15. Select the certificate you want to configure from the **Select the Certificate** drop-down list.
16. Click **Submit**.

The following screen appears.

HTTP Server Settings

The setting for high security in communication was done.

To activate your new settings, this Device needs to restart.

Note: Any jobs in progress will be aborted.

To activate other protocols that have secure settings after restarting, check the box below.

Activate other protocols that have secure settings.

Would you like to restart immediately?

Yes

No

17. Click **Yes** to restart your print server.

The self-signed certificate is created and saved in your machine's memory.

To use SSL/TLS communication, the self-signed certificate must be installed on your computer.







Related Information

- [Create and Install a Self-signed Certificate](#)

Install the Self-signed Certificate for Windows® users with Administrator Rights

The following steps are for Microsoft® Internet Explorer®. If you use another web browser, consult the documentation for your web browser to get help with installing certificates.

1. Do one of the following:
 - (Windows® 7 and Windows Server® 2008)
Click  (**Start**) > **All Programs**.
 - (Windows® 8)
Right-click the  (**Internet Explorer**) icon on the taskbar.
 - (Windows® 10 and Windows Server® 2016)
Click  **Windows Accessories**.
 - (Windows Server® 2012 and Windows Server® 2012 R2)
Click  (**Internet Explorer**), and then right-click the  (**Internet Explorer**) icon that appears on the taskbar.
2. Right-click **Internet Explorer**, and then click **Run as administrator**.



If the **More** option appears, click **More**.

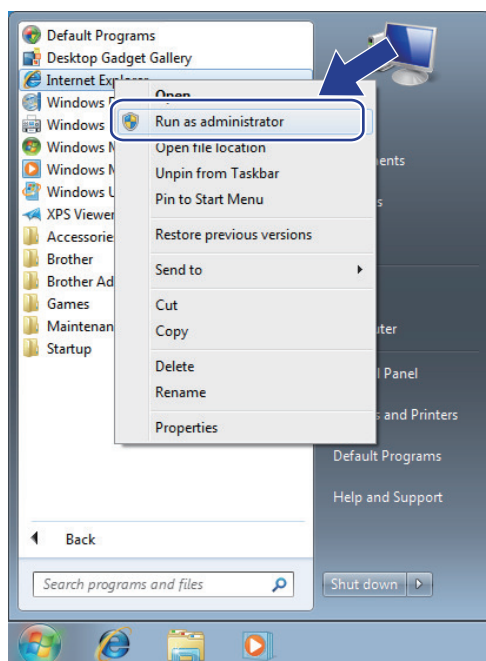

If the **User Account Control** screen appears, click **Yes**.

3. Type "https://machine's IP address" in your browser's address bar to access your machine (where "machine's IP address" is the machine's IP address or the node name that you assigned for the certificate).

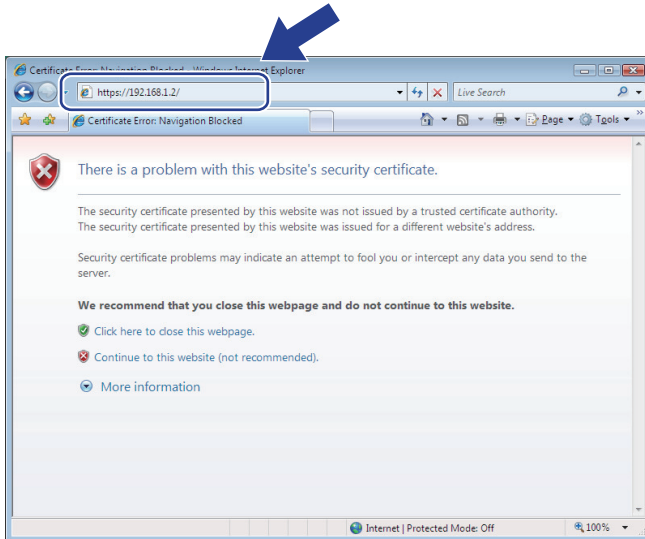

4. Click **Continue to this website (not recommended)**.

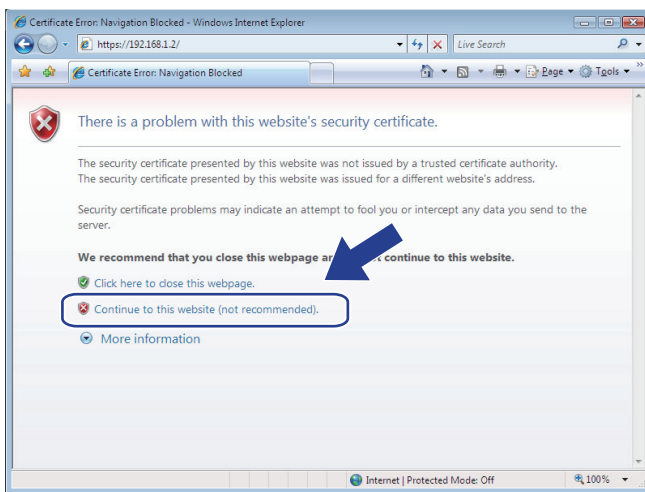

5. Click **Certificate error**, and then click **View certificates**.

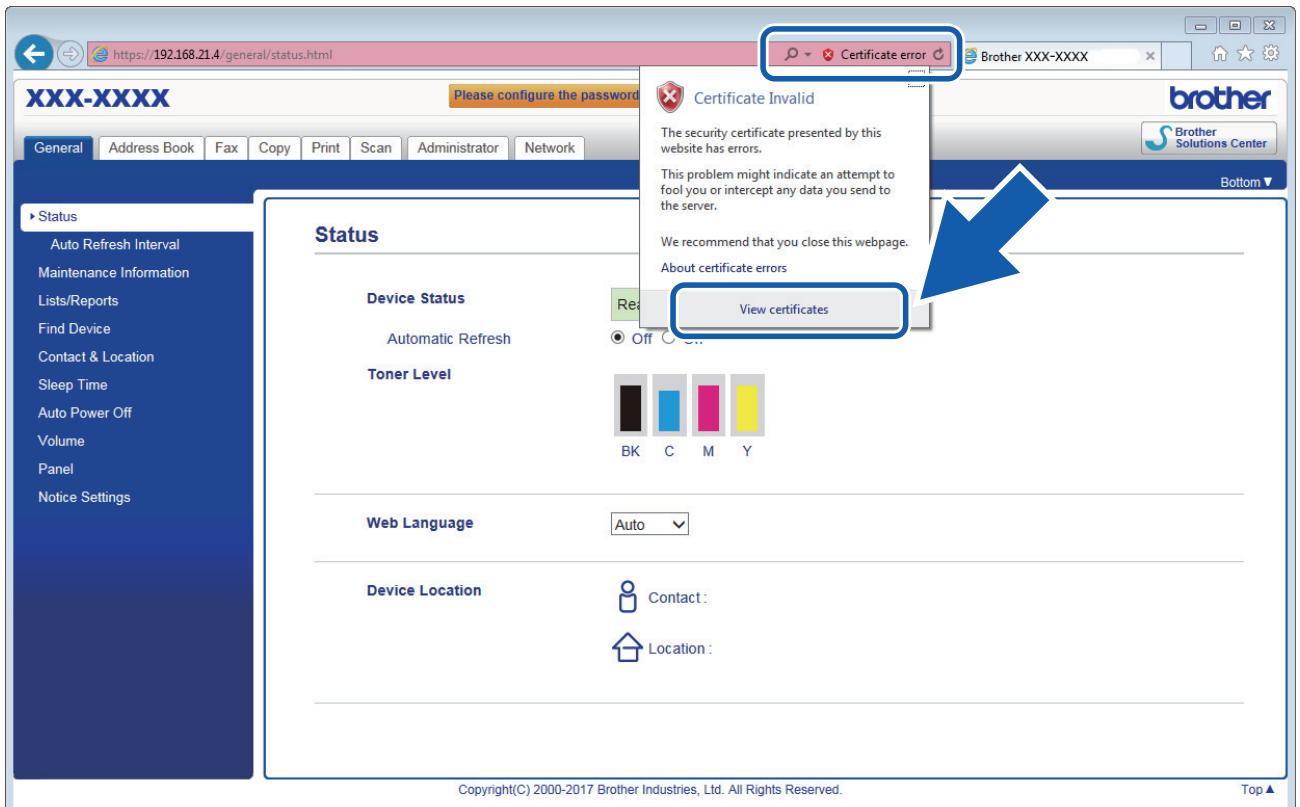

6. Click **Install Certificate...**

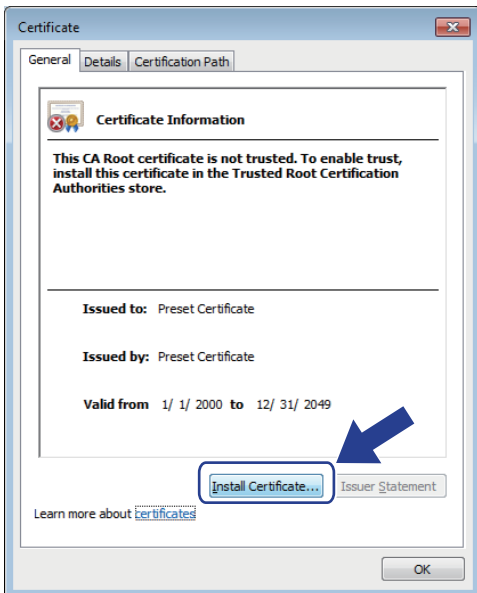

7. When the **Certificate Import Wizard** appears, click **Next**.
8. Select **Place all certificates in the following store**, and then click **Browse....**

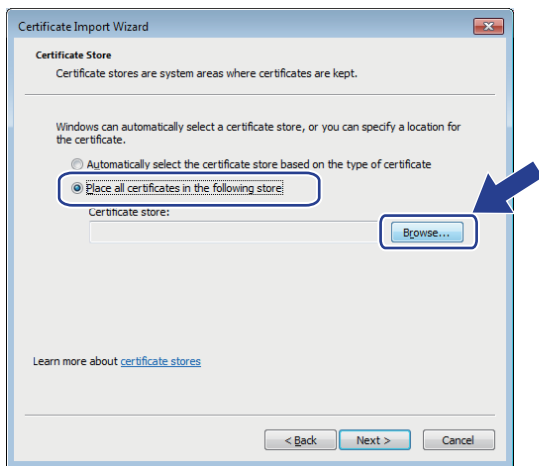

9. Select **Trusted Root Certification Authorities**, and then click **OK**.



10. Click **Next**.

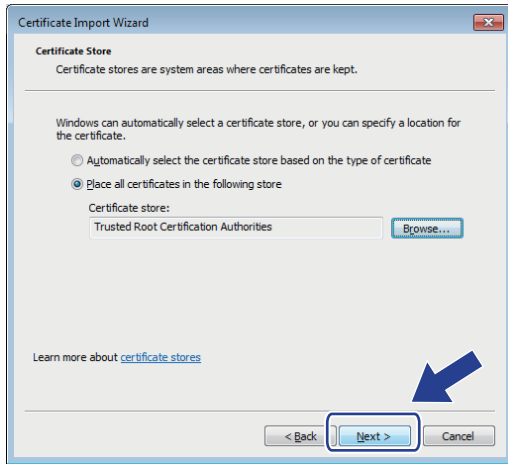

11. Click **Finish**.

12. Click **Yes**, if the fingerprint (thumbprint) is correct.

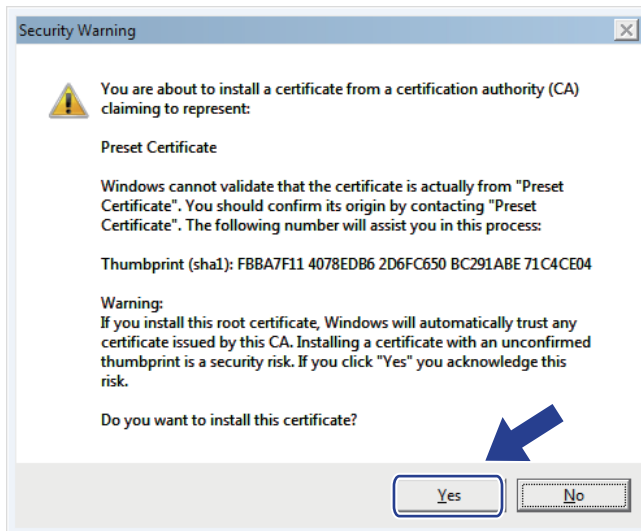

The fingerprint (thumbprint) is printed on the Network Configuration Report.

13. Click **OK**.

The self-signed certificate is now installed on your computer, and SSL/TLS communication is available.



Related Information

- [Create and Install a Self-signed Certificate](#)

Import and Export the Self-signed Certificate on your Brother Machine

You can store the self-signed certificates on your Brother machine and manage them by importing and exporting.

- [Import the Self-signed Certificate](#)
- [Export the Self-signed Certificate](#)

Import the Self-signed Certificate

1. Start your web browser.
2. Type "http://machine's IP address" in your browser's address bar (where "machine's IP address" is the machine's IP address).

For example:

http://192.168.1.2



- If you are using a Domain Name System or enable a NetBIOS name, you can type another name, such as "SharedPrinter" instead of the IP address.

- For example:

http://SharedPrinter

If you enable a NetBIOS name, you can also use the node name.

- For example:

http://brnxxxxxxxxxxxx

The NetBIOS name can be found in the Network Configuration Report.

- For Macintosh, access Web Based Management by clicking the machine's icon on the **Status Monitor** screen.

3. No password is required by default. Type a password if you have set one, and then click .
4. Click the **Network** tab.
5. Click the **Security** tab.
6. Click **Certificate**.
7. Click **Import Certificate and Private Key**.
8. Browse to the file you want to import.
9. Type the password if the file is encrypted, and then click **Submit**.

The self-signed certificate is imported to your machine.

To use SSL/TLS communication, the self-signed certificate must also be installed on your computer. Contact your network administrator.



Related Information

- [Import and Export the Self-signed Certificate on your Brother Machine](#)

Export the Self-signed Certificate

1. Start your web browser.
2. Type "http://machine's IP address" in your browser's address bar (where "machine's IP address" is the machine's IP address).

For example:

http://192.168.1.2



- If you are using a Domain Name System or enable a NetBIOS name, you can type another name, such as "SharedPrinter" instead of the IP address.

- For example:

http://SharedPrinter

If you enable a NetBIOS name, you can also use the node name.

- For example:

http://brnxxxxxxxxxxxx

The NetBIOS name can be found in the Network Configuration Report.

- For Macintosh, access Web Based Management by clicking the machine's icon on the **Status Monitor** screen.

3. No password is required by default. Type a password if you have set one, and then click .
4. Click the **Network** tab.
5. Click the **Security** tab.
6. Click **Certificate**.
7. Click **Export** shown with **Certificate List**.
8. If you want to encrypt the file, type a password in the **Enter password** field.
If the **Enter password** field is blank, your output file will not be encrypted.
9. Type the password again in the **Retype password** field, and then click **Submit**.
10. Click **Save**.
11. Specify the location where you want to save the file.

The self-signed certificate is exported to your computer.

You can also import the self-signed certificate to your computer.



Related Information

- [Import and Export the Self-signed Certificate on your Brother Machine](#)

Create and Install a Certificate from a Certificate Authority (CA)

If you already have a certificate from an external trusted CA, you can store the certificate and private key on the machine and manage them by importing and exporting. If you do not have a certificate from an external trusted CA, create a Certificate Signing Request (CSR), send it to a CA for authentication, and install the returned certificate on your machine.

- [Create a Certificate Signing Request \(CSR\)](#)
- [Install a Certificate on Your Brother Machine](#)
- [Import and Export the Certificate and Private Key](#)

Create a Certificate Signing Request (CSR)

A Certificate Signing Request (CSR) is a request sent to a Certificate Authority (CA) to authenticate the credentials contained within the certificate.

We recommend installing a Root Certificate from the CA on your computer before creating the CSR.

1. Start your web browser.
2. Type "http://machine's IP address" in your browser's address bar (where "machine's IP address" is the machine's IP address).

For example:

http://192.168.1.2



- If you are using a Domain Name System or enable a NetBIOS name, you can type another name, such as "SharedPrinter" instead of the IP address.

- For example:

http://SharedPrinter

If you enable a NetBIOS name, you can also use the node name.

- For example:

http://brnxxxxxxxxxxxx

The NetBIOS name can be found in the Network Configuration Report.

- For Macintosh, access Web Based Management by clicking the machine's icon on the **Status Monitor** screen.

3. No password is required by default. Type a password if you have set one, and then click .
4. Click the **Network** tab.
5. Click the **Security** tab.
6. Click **Certificate**.
7. Click **Create CSR**.
8. Type a **Common Name** (required) and add other information about your **Organization** (optional).



- Your company details are required so that a CA can confirm your identity and verify it to the outside world.
- The length of the **Common Name** must be less than 64 bytes. Enter an identifier, such as an IP address, node name, or domain name to use when accessing this printer through SSL/TLS communication. The node name is displayed by default. The **Common Name** is required.
- A warning will appear if you type a different name in the URL than the Common Name that was used for the certificate.
- The length of the **Organization**, the **Organization Unit**, the **City/Locality** and the **State/Province** must be less than 64 bytes.
- The **Country/Region** should be a two character ISO 3166 country code.
- If you are configuring an X.509v3 certificate extension, select the **Configure extended partition** check box, and then select **Auto (Register IPv4)** or **Manual**.

9. Select your setting from the **Public Key Algorithm** drop-down list. The default setting is **RSA(2048bit)**.
10. Select your setting from the **Digest Algorithm** drop-down list. The default setting is **SHA256**.
11. Click **Submit**.

The CSR appears on your screen. Save the CSR as a file or copy and paste it into an online CSR form offered by a Certificate Authority.

12. Click **Save**.



- Follow your CA's policy regarding the method to send a CSR to your CA.
 - If you are using the Enterprise root CA of Windows Server® 2008/2012/2012 R2/2016, we recommend using the Web Server for the certificate template to securely create the Client Certificate. If you are creating a Client Certificate for an IEEE 802.1x environment with EAP-TLS authentication, we recommend using User for the certificate template. For more information, go to your model's page on the Brother Solutions Center at support.brother.com.
-



Related Information

- [Create and Install a Certificate from a Certificate Authority \(CA\)](#)
-

Install a Certificate on Your Brother Machine

When you receive a certificate from a CA, follow the steps below to install it into the print server:

Only a certificate issued with your machine's CSR can be installed onto the machine. When you want to create another CSR, make sure that the certificate is installed before creating another CSR. Create another CSR only after installing the certificate on the machine. If you do not, the CSR you create before installing will be invalid.

1. Start your web browser.
2. Type "http://machine's IP address" in your browser's address bar (where "machine's IP address" is the machine's IP address).

For example:

http://192.168.1.2



- If you are using a Domain Name System or enable a NetBIOS name, you can type another name, such as "SharedPrinter" instead of the IP address.

- For example:

http://SharedPrinter

If you enable a NetBIOS name, you can also use the node name.

- For example:

http://brnxxxxxxxxxxxx

The NetBIOS name can be found in the Network Configuration Report.

- For Macintosh, access Web Based Management by clicking the machine's icon on the **Status Monitor** screen.

3. No password is required by default. Type a password if you have set one, and then click .
4. Click the **Network** tab.
5. Click the **Security** tab.
6. Click **Certificate**.
7. Click **Install Certificate**.
8. Browse to the file that contains the certificate issued by the CA, and then click **Submit**.

The certificate has been created successfully and saved in your machine's memory successfully.

To use SSL/TLS communication, the Root Certificate from the CA must be installed on your computer. Contact your network administrator.



Related Information

- [Create and Install a Certificate from a Certificate Authority \(CA\)](#)

Import and Export the Certificate and Private Key

Store the certificate and private key on your machine and manage them by importing and exporting them.

- [Import a Certificate and Private Key](#)
- [Export the Certificate and Private Key](#)

Import a Certificate and Private Key

1. Start your web browser.
2. Type "http://machine's IP address" in your browser's address bar (where "machine's IP address" is the machine's IP address).

For example:

http://192.168.1.2



- If you are using a Domain Name System or enable a NetBIOS name, you can type another name, such as "SharedPrinter" instead of the IP address.

- For example:

http://SharedPrinter

If you enable a NetBIOS name, you can also use the node name.

- For example:

http://brnxxxxxxxxxxxx

The NetBIOS name can be found in the Network Configuration Report.

- For Macintosh, access Web Based Management by clicking the machine's icon on the **Status Monitor** screen.

3. No password is required by default. Type a password if you have set one, and then click .
4. Click the **Network** tab.
5. Click the **Security** tab.
6. Click **Certificate**.
7. Click **Import Certificate and Private Key**.
8. Browse to the file you want to import.
9. Type the password if the file is encrypted, and then click **Submit**.

The certificate and private key are imported to your machine.

To use SSL/TLS communication, the Root Certificate from the CA must also be installed on your computer. Contact your network administrator.



Related Information

- [Import and Export the Certificate and Private Key](#)

Export the Certificate and Private Key

1. Start your web browser.
2. Type "http://machine's IP address" in your browser's address bar (where "machine's IP address" is the machine's IP address).

For example:

http://192.168.1.2



- If you are using a Domain Name System or enable a NetBIOS name, you can type another name, such as "SharedPrinter" instead of the IP address.

- For example:

http://SharedPrinter

If you enable a NetBIOS name, you can also use the node name.

- For example:

http://brnxxxxxxxxxxxx

The NetBIOS name can be found in the Network Configuration Report.

- For Macintosh, access Web Based Management by clicking the machine's icon on the **Status Monitor** screen.

3. No password is required by default. Type a password if you have set one, and then click .
4. Click the **Network** tab.
5. Click the **Security** tab.
6. Click **Certificate**.
7. Click **Export** shown with **Certificate List**.
8. Enter the password if you want to encrypt the file.
If a blank password is used, the output is not encrypted.
9. Enter the password again for confirmation, and then click **Submit**.
10. Click **Save**.
11. Specify the location where you want to save the file.

The certificate and private key are exported to your computer.

You can also import the certificate to your computer.



Related Information

- [Import and Export the Certificate and Private Key](#)

Import and Export a CA Certificate

You can import, export and store CA certificates on your Brother machine.

- [Import a CA Certificate](#)
- [Export a CA Certificate](#)

Import a CA Certificate

1. Start your web browser.
2. Type "http://machine's IP address" in your browser's address bar (where "machine's IP address" is the machine's IP address).

For example:

http://192.168.1.2



- If you are using a Domain Name System or enable a NetBIOS name, you can type another name, such as "SharedPrinter" instead of the IP address.

- For example:

http://SharedPrinter

If you enable a NetBIOS name, you can also use the node name.

- For example:

http://brnxxxxxxxxxxxx

The NetBIOS name can be found in the Network Configuration Report.

- For Macintosh, access Web Based Management by clicking the machine's icon on the **Status Monitor** screen.

3. No password is required by default. Type a password if you have set one, and then click .
4. Click the **Network** tab.
5. Click the **Security** tab.
6. Click **CA Certificate**.
7. Click **Import CA Certificate**.
8. Browse to the file you want to import.
9. Click **Submit**.



Related Information

- [Import and Export a CA Certificate](#)

Export a CA Certificate

1. Start your web browser.
2. Type "http://machine's IP address" in your browser's address bar (where "machine's IP address" is the machine's IP address).

For example:

http://192.168.1.2



- If you are using a Domain Name System or enable a NetBIOS name, you can type another name, such as "SharedPrinter" instead of the IP address.

- For example:

http://SharedPrinter

If you enable a NetBIOS name, you can also use the node name.

- For example:

http://brnxxxxxxxxxxxx

The NetBIOS name can be found in the Network Configuration Report.

- For Macintosh, access Web Based Management by clicking the machine's icon on the **Status Monitor** screen.

3. No password is required by default. Type a password if you have set one, and then click .
4. Click the **Network** tab.
5. Click the **Security** tab.
6. Click **CA Certificate**.
7. Select the certificate you want to export and click **Export**.
8. Click **Submit**.
9. Click **Save**.
10. Specify where on your computer you want to save the exported certificate, and save it.



Related Information

- [Import and Export a CA Certificate](#)

Manage Multiple Certificates

The multiple certificate feature allows you to use Web Based Management to manage each certificate installed on your machine. In Web Based Management, navigate to the **Certificate** or **CA Certificate** screen to view certificate content, delete, or export your certificates.

	Maximum Number of Certificates Stored UP on Brother Machine
Self-signed Certificate or Certificate Issued by a CA	6
CA Certificate	10

We recommend storing one less certificate than allowed, reserving an empty spot in case of certificate expiration. When a certificate expires, import a new certificate into the reserved spot, and then delete the expired certificate. This ensures that you avoid configuration failure.



- When you use HTTPS/IPPS, IEEE 802.1x, or Signed PDF, you must select which certificate you are using.
- When you use SSL for SMTP/POP3/IMAP4 communications (only available for certain models), you do not have to choose the certificate. The necessary certificate will be chosen automatically.



Related Information

- [Certificates and Web Based Management](#)

Manage Your Network Machine Securely Using Web Based Management

To manage your network machine securely, you must use management utilities with security protocols.

We recommend using the HTTPS protocol for secure management. To use this protocol, HTTPS must be enabled on your machine.



- The HTTPS protocol is enabled by default.
- You can change the HTTPS protocol settings using the Web Based Management screen.

1. Start your web browser.
2. Type "https://Common Name" in your browser's address bar (where "Common Name" is the Common Name that you assigned to the certificate; this could be your IP address, node name, or domain name).
3. No password is required by default. Type a password if you have set one, and then click .
4. You can now access the machine using HTTPS.



- If you use the SNMPv3 protocol, follow the steps below.
- You can also change the SNMP settings by using BRAdmin Professional 3.

5. Click the **Network** tab.
6. Click **Protocol**.
7. Make sure the **SNMP** setting is enabled, and then click **Advanced Settings**.
8. Configure the SNMP settings.

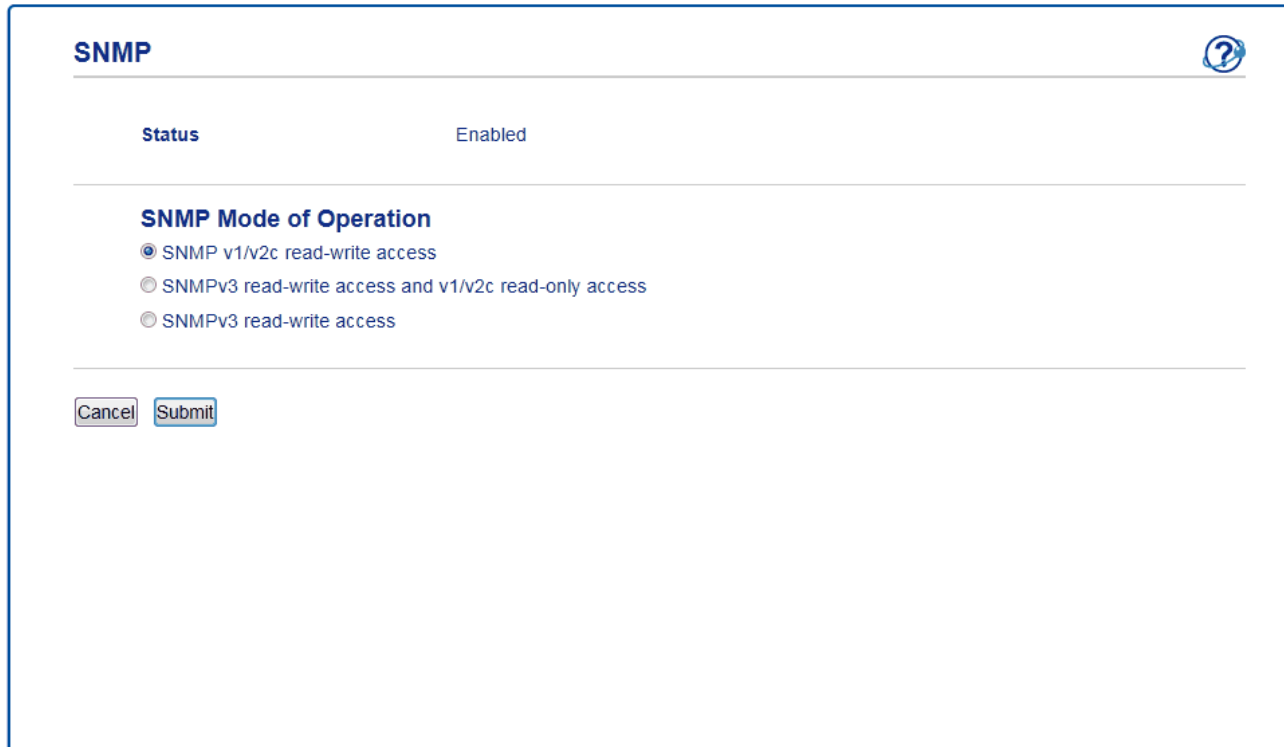

SNMP 

Status Enabled

SNMP Mode of Operation

SNMP v1/v2c read-write access

SNMPv3 read-write access and v1/v2c read-only access

SNMPv3 read-write access

There are three options for **SNMP Mode of Operation**.

- **SNMP v1/v2c read-write access**
In this mode, the print server uses version 1 and version 2c of the SNMP protocol. You can use all Brother applications in this mode. However, it is not secure since it will not authenticate the user, and data will not be encrypted.
- **SNMPv3 read-write access and v1/v2c read-only access**

In this mode, the print server uses the read-write access of version 3 and the read-only access of version 1 and version 2c of the SNMP protocol.



When you use **SNMPv3 read-write access and v1/v2c read-only access** mode, some Brother applications (such as BRAdmin Light) that access the print server do not work correctly since they authorize the read-only access of version 1 and version 2c. If you want to use all applications, we recommend using **SNMP v1/v2c read-write access** mode.

- **SNMPv3 read-write access**

In this mode, the print server uses version 3 of the SNMP protocol. If you want to manage the print server securely, use this mode.



When you use **SNMPv3 read-write access** mode, note the following:

- You can use only BRAdmin Professional 3 or Web Based Management to manage the print server.
- Except for BRAdmin Professional 3, all applications that use SNMPv1/v2c will be restricted. To allow the use of SNMPv1/v2c applications, use **SNMPv3 read-write access and v1/v2c read-only access** or **SNMP v1/v2c read-write access** mode.

9. Click **Submit**.



Related Information

- [Manage Your Network Machine Securely Using SSL/TLS](#)

Manage Your Network Machine Securely Using BRAdmin Professional 3 (Windows®)

To use BRAdmin Professional 3 utility, you must:

- Use the latest version of BRAdmin Professional 3. Go to your model's **Downloads** page on the Brother Solutions Center at support.brother.com.
- Use Web Based Management with the HTTPS protocol if you use BRAdmin Professional 3 and Web Based Management together.
- Use a different password in each group if you are managing a mixed group of older and newer print servers with BRAdmin Professional 3. This will ensure security is maintained on the newer print servers.



- "Older versions of BRAdmin" refer to BRAdmin Professional older than Ver. 2.80 and BRAdmin Light for Macintosh older than Ver.1.10.
- "Older print servers" refer to NC-2000 series, NC-2100p, NC-3100h, NC-3100s, NC-4100h, NC-5100h, NC-5200h, NC-6100h, NC-6200h, NC-6300h, NC-6400h, NC-8000, NC-100h, NC-110h, NC-120w, NC-130h, NC-140w, NC-8100h, NC-9100h, NC-7100w, NC-7200w and NC-2200w.



Related Information

- [Manage Your Network Machine Securely Using SSL/TLS](#)

Print Documents Securely Using SSL/TLS

To print documents securely with IPP protocol, use the IPPS protocol.

1. Start your web browser.
2. Type "http://machine's IP address" in your browser's address bar (where "machine's IP address" is the machine's IP address).

For example:

http://192.168.1.2



- If you are using a Domain Name System or enable a NetBIOS name, you can type another name, such as "SharedPrinter" instead of the IP address.

- For example:

http://SharedPrinter

If you enable a NetBIOS name, you can also use the node name.

- For example:

http://brnxxxxxxxxxxxx

The NetBIOS name can be found in the Network Configuration Report.

- For Macintosh, access Web Based Management by clicking the machine's icon on the **Status Monitor** screen.

3. No password is required by default. Type a password if you have set one, and then click .
4. Click the **Network** tab.
5. Click **Protocol**. Make sure the **IPP** check box is selected.



- If the **IPP** check box is not selected, select the **IPP** check box, and then click **Submit**.

Restart your machine to activate the configuration.

After the machine restarts, return to the machine's web page, click the **Network** tab, and then click **Protocol**.

6. Click **HTTP Server Settings**.
7. Select the **HTTPS(Port443)** check box in the **IPP**, and then click **Submit**.
8. Restart your machine to activate the configuration.

Communication using IPPS cannot prevent unauthorized access to the print server.



Related Information

- [Manage Your Network Machine Securely Using SSL/TLS](#)

Manage Your Network Machine Securely Using IPsec

- [Introduction to IPsec](#)
- [Configure IPsec Using Web Based Management](#)
- [Configure an IPsec Address Template Using Web Based Management](#)
- [Configure an IPsec Template Using Web Based Management](#)

Introduction to IPsec

IPsec (Internet Protocol Security) is a security protocol that uses an optional Internet Protocol function to prevent manipulation and ensure the confidentiality of data transmitted as IP packets. IPsec encrypts data carried over the network, such as print data sent from computers to a printer. Because the data is encrypted at the network layer, applications that employ a higher-level protocol use IPsec even if the user is not aware of its use.

IPsec supports the following functions:

- IPsec transmissions

According to the IPsec setting conditions, the network-connected computer sends data to and receives data from the specified device using IPsec. When the devices start communicating using IPsec, keys are exchanged using Internet Key Exchange (IKE) first, and then the encrypted data is transmitted using the keys.

In addition, IPsec has two operation modes: the Transport mode and Tunnel mode. The Transport mode is used mainly for communication between devices and the Tunnel mode is used in environments such as a Virtual Private Network (VPN).



For IPsec transmissions, the following conditions are necessary:

- A computer that can communicate using IPsec is connected to the network.
 - Your Brother machine is configured for IPsec communication.
 - The computer connected to your Brother machine is configured for IPsec connections.
-

- IPsec settings

The settings that are necessary for connections using IPsec. These settings can be configured using Web Based Management.



To configure the IPsec settings, you must use the browser on a computer that is connected to the network.



Related Information

- [Manage Your Network Machine Securely Using IPsec](#)
-

Configure IPsec Using Web Based Management

The IPsec connection conditions are comprised of two **Template** types: **Address** and **IPsec**. You can configure up to 10 connection conditions.

1. Start your web browser.
2. Type "http://machine's IP address" in your browser's address bar (where "machine's IP address" is the machine's IP address).

For example:

http://192.168.1.2

3. No password is required by default. Type a password if you have set one, and then click .
4. Click the **Network** tab.
5. Click the **Security** tab.
6. Click the **IPsec** menu in the left navigation bar.

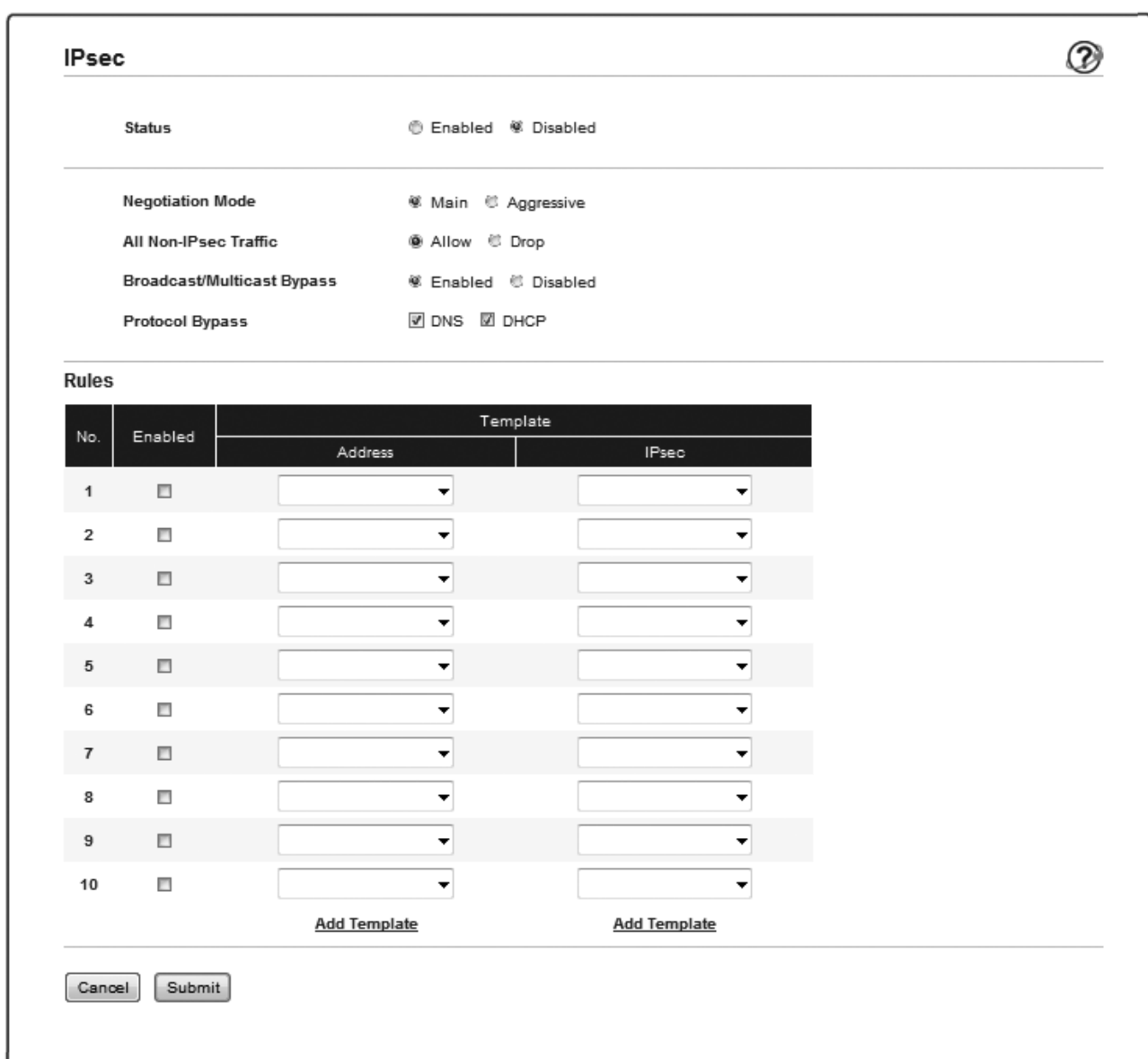

IPsec 

Status Enabled Disabled

Negotiation Mode Main Aggressive

All Non-IPsec Traffic Allow Drop

Broadcast/Multicast Bypass Enabled Disabled

Protocol Bypass DNS DHCP

Rules

No.	Enabled	Template	
		Address	IPsec
1	<input type="checkbox"/>	<input type="text"/>	<input type="text"/>
2	<input type="checkbox"/>	<input type="text"/>	<input type="text"/>
3	<input type="checkbox"/>	<input type="text"/>	<input type="text"/>
4	<input type="checkbox"/>	<input type="text"/>	<input type="text"/>
5	<input type="checkbox"/>	<input type="text"/>	<input type="text"/>
6	<input type="checkbox"/>	<input type="text"/>	<input type="text"/>
7	<input type="checkbox"/>	<input type="text"/>	<input type="text"/>
8	<input type="checkbox"/>	<input type="text"/>	<input type="text"/>
9	<input type="checkbox"/>	<input type="text"/>	<input type="text"/>
10	<input type="checkbox"/>	<input type="text"/>	<input type="text"/>

[Add Template](#) [Add Template](#)

7. In the **Status** field, enable or disable IPsec.
8. Select **Negotiation Mode** for IKE Phase 1.

IKE is a protocol that is used to exchange encryption keys in order to carry out encrypted communication using IPsec.

In **Main** mode, the processing speed is slow, but the security is high. In **Aggressive** mode, the processing speed is faster than **Main** mode, but the security is lower.

9. In the **All Non-IPsec Traffic** field, select the action to be taken for non-IPsec packets.

When using Web Services, you must select **Allow** for **All Non-IPsec Traffic**. If you select **Drop**, Web Services cannot be used.

10. In the **Broadcast/Multicast Bypass** field, select **Enabled** or **Disabled**.

11. In the **Protocol Bypass** field, select the check box for the option or options you want.

12. In the **Rules** table, select the **Enabled** check box to activate the template.

When you select multiple check boxes, the lower numbered check boxes have priority if the settings for the selected check boxes conflict.

13. Click on the corresponding drop-down list to select the **Address Template** that is used for the IPsec connection conditions.

To add an **Address Template**, click **Add Template**.

14. Click on the corresponding drop-down list to select the **IPsec Template** that is used for the IPsec connection conditions.

To add an **IPsec Template**, click **Add Template**.

15. Click **Submit**.

If the machine must be restarted to register the new settings, the restart confirmation screen will appear.

If there is a blank item in the template you enabled in the **Rules** table, an error message appears. Confirm your choices and click **Submit** again.



Related Information

- [Manage Your Network Machine Securely Using IPsec](#)
-

Configure an IPsec Address Template Using Web Based Management

1. Start your web browser.
2. Type "http://machine's IP address" in your browser's address bar (where "machine's IP address" is the machine's IP address).

For example:

http://192.168.1.2

3. No password is required by default. Type a password if you have set one, and then click .
4. Click the **Network** tab.
5. Click the **Security** tab.
6. Click the **IPsec Address Template** menu in the left navigation bar.

The Template List appears, displaying 10 Address Templates.

Click the **Delete** button to delete an **Address Template**. When an **Address Template** is in use, it cannot be deleted.

7. Click the **Address Template** that you want to create. The **IPsec Address Template** appears.

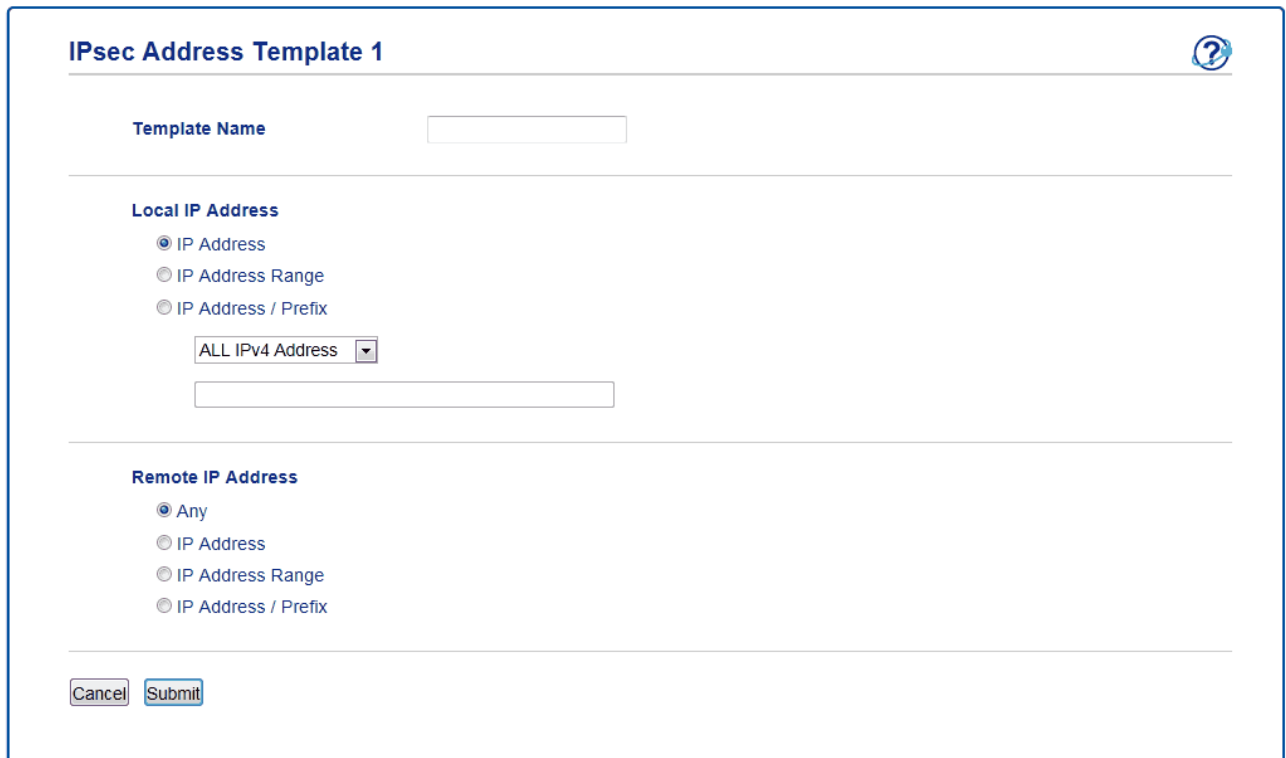

The screenshot shows a web form titled "IPsec Address Template 1" with a help icon in the top right. The form is divided into sections: "Template Name" with a text input field; "Local IP Address" with three radio button options: "IP Address" (selected), "IP Address Range", and "IP Address / Prefix". Below these is a dropdown menu currently set to "ALL IPv4 Address" and a text input field. The "Remote IP Address" section has four radio button options: "Any" (selected), "IP Address", "IP Address Range", and "IP Address / Prefix". At the bottom left are "Cancel" and "Submit" buttons.

8. In the **Template Name** field, type a name for the template (up to 16 characters).
9. Select a **Local IP Address** option to specify the IP address conditions for the sender:
 - **IP Address**
Specify the IP address. Select **ALL IPv4 Address**, **ALL IPv6 Address**, **ALL Link Local IPv6**, or **Custom** from the drop-down list.
If you select **Custom** from the drop-down list, type the IP address (IPv4 or IPv6) in the text box.
 - **IP Address Range**
Type the starting and ending IP addresses for the IP address range in the text boxes. If the starting and ending IP addresses are not standardized to IPv4 or IPv6, or the ending IP address is smaller than the starting address, an error will occur.
 - **IP Address / Prefix**
Specify the IP address using CIDR notation.

For example: 192.168.1.1/24

Because the prefix is specified in the form of a 24-bit subnet mask (255.255.255.0) for 192.168.1.1, the addresses 192.168.1.xxx are valid.

10. Select a **Remote IP Address** option to specify the IP address conditions for the recipient:

- **Any**

If you select **Any**, all IP addresses are enabled.

- **IP Address**

Type the specified IP address (IPv4 or IPv6) in the text box.

- **IP Address Range**

Type the starting and ending IP addresses for the IP address range. If the starting and ending IP addresses are not standardized to IPv4 or IPv6, or the ending IP address is smaller than the starting address, an error will occur.

- **IP Address / Prefix**

Specify the IP address using CIDR notation.

For example: 192.168.1.1/24

Because the prefix is specified in the form of a 24-bit subnet mask (255.255.255.0) for 192.168.1.1, the addresses 192.168.1.xxx are valid.

11. Click **Submit**.



When you change the settings for the template currently in use, restart your machine to active the configuration.



Related Information

- [Manage Your Network Machine Securely Using IPsec](#)
-

Configure an IPsec Template Using Web Based Management

1. Start your web browser.
2. Type "http://machine's IP address" in your browser's address bar (where "machine's IP address" is the machine's IP address).
For example:
http://192.168.1.2
3. No password is required by default. Type a password if you have set one, and then click .
4. Click the **Network** tab.
5. Click the **Security** tab.
6. Click **IPsec Template** in the left navigation bar.
The Template List appears, displaying 10 IPsec Templates.
Click the **Delete** button to delete an **IPsec Template**. When an **IPsec Template** is in use, it cannot be deleted.
7. Click **IPsec Template** that you want to create. The **IPsec Template** screen appears. The configuration fields differ based on the **Use Prefixed Template** and **Internet Key Exchange (IKE)** you select.
8. In the **Template Name** field, type a name for the template (up to 16 characters).
9. If you selected **Custom** in the **Use Prefixed Template** drop-down list, select the **Internet Key Exchange (IKE)** options, and then change the settings if needed.
10. Click **Submit**.

IPsec Template 1



Template Name
Use Prefixed Template

Internet Key Exchange (IKE) IKEv1

Authentication Type

Diffie-Hellman Group
Group14
Encryption
AES-CBC 256
Hash
SHA256
SHA512
SA Lifetime
(240 – 63072000)

(10 – 2097152)

Encapsulating Security

Protocol
Encryption
AES-CBC 256
Hash
SHA256
SHA512
SA Lifetime
(240 – 63072000)

(10 – 2097152)
Encapsulation Mode Transport Tunnel
Remote Router IP-Address

Perfect Forward Secrecy (PFS) Enabled Disabled

Authentication Method Pre-Shared Key
 Certificates

Pre-Shared Key

Local

ID Type
ID

Remote

ID Type
ID

[Certificate>>](#)



Related Information

- [Manage Your Network Machine Securely Using IPsec](#)
- [IKEv1 Settings for an IPsec Template](#)
- [IKEv2 Settings for an IPsec Template](#)
- [Manual Settings for an IPsec Template](#)

IKEv1 Settings for an IPsec Template

IPsec Template 1 ?

Template Name

Use Prefixed Template

Internet Key Exchange (IKE) IKEv1 IKEv2 Manual

Authentication Type

Diffie-Hellman Group

Encryption

Hash

SA Lifetime second(s)
(240 – 63072000)

KByte
(10 – 2097152)

Encapsulating Security

Protocol ESP AH AH+ESP

Encryption

Hash

SA Lifetime second(s)
(120 – 4233600)

KByte
(10 – 4194304)

Encapsulation Mode Transport Tunnel

Remote Router IP-Address

Perfect Forward Secrecy (PFS) Enabled Disabled

Authentication Method Pre-Shared Key Certificates

Pre-Shared Key

Local

ID Type

ID

Remote

ID Type

ID

[Certificate>>](#)

Template Name

Type a name for the template (up to 16 characters).

Use Prefixed Template

Select **Custom**, **IKEv1 High Security** or **IKEv1 Medium Security**. The setting items are different depending on the selected template.



The default template differs depending on whether you chose **Main** or **Aggressive** for **Negotiation Mode** on the **IPsec** configuration screen.

Internet Key Exchange (IKE)

IKE is a communication protocol that is used to exchange encryption keys in order to carry out encrypted communication using IPsec. To carry out encrypted communication for that time only, the encryption algorithm that is necessary for IPsec is determined and the encryption keys are shared. For IKE, the encryption keys are exchanged using the Diffie-Hellman key exchange method, and encrypted communication that is limited to IKE is carried out.

If you selected **Custom** in **Use Prefixed Template**, select **IKEv1**.

Authentication Type

Configure the IKE authentication and encryption.

- **Diffie-Hellman Group**

This key exchange method allows secret keys to be securely exchanged over an unprotected network. The Diffie-Hellman key exchange method uses a discrete logarithm problem, not the secret key, to send and receive open information that was generated using a random number and the secret key.

Select **Group1**, **Group2**, **Group5**, or **Group14**.

- **Encryption**

Select **DES**, **3DES**, **AES-CBC 128**, or **AES-CBC 256**.

- **Hash**

Select **MD5**, **SHA1**, **SHA256**, **SHA384** or **SHA512**.

- **SA Lifetime**

Specify the IKE SA lifetime.

Type the time (seconds) and number of kilobytes (KByte).

Encapsulating Security

- **Protocol**

Select **ESP**, **AH** or **AH+ESP**.



- ESP is a protocol for carrying out encrypted communication using IPsec. ESP encrypts the payload (communicated contents) and adds additional information. The IP packet is comprised of the header and the encrypted payload, which follows the header. In addition to the encrypted data, the IP packet also includes information regarding the encryption method and encryption key, the authentication data, and so on.

- AH is part of the IPsec protocol that authenticates the sender and prevents manipulation (ensures the completeness) of the data. In the IP packet, the data is inserted immediately after the header. In addition, the packets include hash values, which are calculated using an equation from the communicated contents, secret key, and so on, in order to prevent the falsification of the sender and manipulation of the data. Unlike ESP, the communicated contents are not encrypted, and the data is sent and received as plain text.

- **Encryption**

Select **DES**, **3DES**, **AES-CBC 128**, or **AES-CBC 256**.

- **Hash**

Select **None**, **MD5**, **SHA1**, **SHA256**, **SHA384**, or **SHA512**.

When **AH+ESP** is selected in **Protocol**, select each protocol for **Hash(ESP)** and **Hash(AH)**.

- **SA Lifetime**

Specify the IPsec SA lifetime.

Type the time (seconds) and number of kilobytes (KByte) before the IPsec SA will expire.

- **Encapsulation Mode**

Select **Transport** or **Tunnel**.

- **Remote Router IP-Address**

Type the IP address (IPv4 or IPv6) of the remote router. Enter this information only when the **Tunnel** mode is selected.



SA (Security Association) is an encrypted communication method using IPsec or IPv6 that exchanges and shares information, such as the encryption method and encryption key, in order to establish a secure communication channel before communication begins. SA may also refer to a virtual encrypted communication channel that has been established. The SA used for IPsec establishes the encryption method, exchanges the keys, and carries out mutual authentication according to the IKE (Internet Key Exchange) standard procedure. In addition, the SA is updated periodically.

Perfect Forward Secrecy (PFS)

PFS does not derive keys from previous keys that were used to encrypt messages. In addition, if a key that is used to encrypt a message was derived from a parent key, that parent key is not used to derive other keys. Therefore, even if a key is compromised, the damage will be limited only to the messages that were encrypted using that key.

Select **Enabled** or **Disabled**.

Authentication Method

Select the authentication method. Select **Pre-Shared Key** or **Certificates**.

Pre-Shared Key

When encrypting communication, the encryption key is exchanged and shared beforehand using another channel.

If you selected **Pre-Shared Key** for the **Authentication Method**, type the **Pre-Shared Key** (up to 32 characters).

- **Local/ID Type/ID**

Select the sender's ID type, and then type the ID.

Select **IPv4 Address**, **IPv6 Address**, **FQDN**, **E-mail Address**, or **Certificate** for the type.

If you select **Certificate**, type the common name of the certificate in the **ID** field.

- **Remote/ID Type/ID**

Select the recipient's ID type, and then type the ID.

Select **IPv4 Address**, **IPv6 Address**, **FQDN**, **E-mail Address**, or **Certificate** for the type.

If you select **Certificate**, type the common name of the certificate in the **ID** field.

Certificate

If you selected **Certificates** for **Authentication Method**, select the certificate.



You can select only the certificates that were created using the **Certificate** page of Web Based Management's Security configuration screen.



Related Information

- [Configure an IPsec Template Using Web Based Management](#)
-

IKEv2 Settings for an IPsec Template

IPsec Template 1 ?

Template Name

Use Prefixed Template

Internet Key Exchange (IKE) IKEv1 IKEv2 Manual

Authentication Type

Diffie-Hellman Group Group1 Group2 Group5 Group14

Encryption DES 3DES AES-CBC 128
 AES-CBC 256

Hash MD5 SHA1 SHA256 SHA384
 SHA512

SA Lifetime second(s)
(240 – 83072000)

KByte
(10 – 2097152)

Encapsulating Security

Protocol ESP

Encryption DES 3DES AES-CBC 128
 AES-CBC 256

Hash MD5 SHA1 SHA256 SHA384
 SHA512

SA Lifetime second(s)
(120 – 4233600)

KByte
(10 – 4194304)

Encapsulation Mode Transport Tunnel

Remote Router IP-Address

Perfect Forward Secrecy (PFS) Enabled Disabled

Authentication Method Pre-Shared Key
 Certificates
 EAP - MD5
 EAP - MS-CHAPv2

Pre-Shared Key

Local

ID Type

ID

Remote

ID Type

ID

[Certificate>>](#)

Template Name

Type a name for the template (up to 16 characters).

Use Prefixed Template

Select **Custom**, **IKEv2 High Security**, or **IKEv2 Medium Security**. The setting items are different depending on the selected template.

Internet Key Exchange (IKE)

IKE is a communication protocol that is used to exchange encryption keys in order to carry out encrypted communication using IPsec. To carry out encrypted communication for that time only, the encryption algorithm that is necessary for IPsec is determined and the encryption keys are shared. For IKE, the encryption keys are exchanged using the Diffie-Hellman key exchange method, and encrypted communication that is limited to IKE is carried out.

If you selected **Custom** in **Use Prefixed Template**, select **IKEv2**.

Authentication Type

Configure the IKE authentication and encryption.

- **Diffie-Hellman Group**

This key exchange method allows secret keys to be securely exchanged over an unprotected network. The Diffie-Hellman key exchange method uses a discrete logarithm problem, not the secret key, to send and receive open information that was generated using a random number and the secret key.

Select **Group1**, **Group2**, **Group5**, or **Group14**.

- **Encryption**

Select **DES**, **3DES**, **AES-CBC 128**, or **AES-CBC 256**.

- **Hash**

Select **MD5**, **SHA1**, **SHA256**, **SHA384** or **SHA512**.

- **SA Lifetime**

Specify the IKE SA lifetime.

Type the time (seconds) and number of kilobytes (KByte).

Encapsulating Security

- **Protocol**

Select **ESP**.



ESP is a protocol for carrying out encrypted communication using IPsec. ESP encrypts the payload (communicated contents) and adds additional information. The IP packet is comprised of the header and the encrypted payload, which follows the header. In addition to the encrypted data, the IP packet also includes information regarding the encryption method and encryption key, the authentication data, and so on.

- **Encryption**

Select **DES**, **3DES**, **AES-CBC 128**, or **AES-CBC 256**.

- **Hash**

Select **MD5**, **SHA1**, **SHA256**, **SHA384**, or **SHA512**.

- **SA Lifetime**

Specify the IPsec SA lifetime.

Type the time (seconds) and number of kilobytes (KByte) before the IPsec SA will expire.

- **Encapsulation Mode**

Select **Transport** or **Tunnel**.

- **Remote Router IP-Address**

Type the IP address (IPv4 or IPv6) of the remote router. Enter this information only when the **Tunnel** mode is selected.



SA (Security Association) is an encrypted communication method using IPsec or IPv6 that exchanges and shares information, such as the encryption method and encryption key, in order to establish a secure communication channel before communication begins. SA may also refer to a virtual encrypted communication channel that has been established. The SA used for IPsec establishes the encryption method, exchanges the keys, and carries out mutual authentication according to the IKE (Internet Key Exchange) standard procedure. In addition, the SA is updated periodically.

Perfect Forward Secrecy (PFS)

PFS does not derive keys from previous keys that were used to encrypt messages. In addition, if a key that is used to encrypt a message was derived from a parent key, that parent key is not used to derive other keys. Therefore, even if a key is compromised, the damage will be limited only to the messages that were encrypted using that key.

Select **Enabled** or **Disabled**.

Authentication Method

Select the authentication method. Select **Pre-Shared Key**, **Certificates**, **EAP - MD5**, or **EAP - MS-CHAPv2**.

Pre-Shared Key

When encrypting communication, the encryption key is exchanged and shared beforehand using another channel.

If you selected **Pre-Shared Key** for the **Authentication Method**, type the **Pre-Shared Key** (up to 32 characters).

- **Local/ID Type/ID**

Select the sender's ID type, and then type the ID.

Select **IPv4 Address**, **IPv6 Address**, **FQDN**, **E-mail Address**, or **Certificate** for the type.

If you select **Certificate**, type the common name of the certificate in the **ID** field.

- **Remote/ID Type/ID**

Select the recipient's ID type, and then type the ID.

Select **IPv4 Address**, **IPv6 Address**, **FQDN**, **E-mail Address**, or **Certificate** for the type.

If you select **Certificate**, type the common name of the certificate in the **ID** field.

Certificate

If you selected **Certificates** for **Authentication Method**, select the certificate.



You can select only the certificates that were created using the **Certificate** page of Web Based Management's Security configuration screen.

EAP

EAP is an authentication protocol that is an extension of PPP. By using EAP with IEEE802.1x, a different key is used for user authentication during each session.

The following settings are necessary only when **EAP - MD5** or **EAP - MS-CHAPv2** is selected in **Authentication Method**:

- **Mode**

Select **Server-Mode** or **Client-Mode**.

- **Certificate**

Select the certificate.

- **User Name**

Type the user name (up to 32 characters).

- **Password**

Type the password (up to 32 characters). The password must be entered two times for confirmation.



Related Information

- [Configure an IPsec Template Using Web Based Management](#)
-

Manual Settings for an IPsec Template

IPsec Template 1

Template Name

Use Prefixed Template

Internet Key Exchange (IKE) IKEv1 IKEv2 Manual

Authentication Key (ESP, AH)

In

Out

Code key (ESP)

In

Out

SPI

In

Out

Encapsulating Security

Protocol ESP AH

Encryption

Hash

SA Lifetime second(s)
(120 - 4233600)

KByte
(10 - 4194304)

Encapsulation Mode Transport Tunnel

Remote Router IP-Address

[Certificate](#)

Template Name

Type a name for the template (up to 16 characters).

Use Prefixed Template

Select **Custom**.

Internet Key Exchange (IKE)

IKE is a communication protocol that is used to exchange encryption keys in order to carry out encrypted communication using IPsec. To carry out encrypted communication for that time only, the encryption algorithm that is necessary for IPsec is determined and the encryption keys are shared. For IKE, the encryption keys are exchanged using the Diffie-Hellman key exchange method, and encrypted communication that is limited to IKE is carried out.

Select **Manual**.

Authentication Key (ESP,AH)

Specify the key to use for authentication. Type the **In/Out** values.

These settings are necessary when **Custom** is selected for **Use Prefixed Template**, **Manual** is selected for **Internet Key Exchange (IKE)**, and a setting other than **None** is selected for **Hash** for **Encapsulating Security** section.



The number of characters you can set differs depending on the setting you chose for **Hash** in the **Encapsulating Security** section.

If the length of the specified authentication key is different than the selected hash algorithm, an error will occur.

- **MD5**: 128 bits (16 bytes)
- **SHA1**: 160 bits (20 bytes)
- **SHA256**: 256 bits (32 bytes)
- **SHA384**: 384 bits (48 bytes)
- **SHA512**: 512 bits (64 bytes)

When you specify the key in ASCII Code, enclose the characters in double quotation marks ("").

Code key (ESP)

Specify the key to use for encryption. Type the **In/Out** values.

These settings are necessary when **Custom** is selected in **Use Prefixed Template**, **Manual** is selected in **Internet Key Exchange (IKE)**, and **ESP** is selected in **Protocol** in **Encapsulating Security**.



The number of characters you can set differs depending on the setting you chose for **Encryption** in the **Encapsulating Security** section.

If the length of the specified code key is different than the selected encryption algorithm, an error will occur.

- **DES**: 64 bits (8 bytes)
- **3DES**: 192 bits (24 bytes)
- **AES-CBC 128**: 128 bits (16 bytes)
- **AES-CBC 256**: 256 bits (32 bytes)

When you specify the key in ASCII Code, enclose the characters in double quotation marks ("").

SPI

These parameters are used to identify security information. Generally, a host has multiple Security Associations (SAs) for several types of IPsec communication. Therefore, it is necessary to identify the applicable SA when an IPsec packet is received. The SPI parameter, which identifies the SA, is included in the Authentication Header (AH) and Encapsulating Security Payload (ESP) header.

These settings are necessary when **Custom** is selected for **Use Prefixed Template**, and **Manual** is selected for **Internet Key Exchange (IKE)**.

Enter the **In/Out** values. (3-10 characters)

Encapsulating Security

- **Protocol**
Select **ESP** or **AH**.



- ESP is a protocol for carrying out encrypted communication using IPsec. ESP encrypts the payload (communicated contents) and adds additional information. The IP packet is comprised of the header and the encrypted payload, which follows the header. In addition to the encrypted data, the IP packet also includes information regarding the encryption method and encryption key, the authentication data, and so on.
- AH is part of the IPsec protocol that authenticates the sender and prevents manipulation of the data (ensures the completeness of the data). In the IP packet, the data is inserted immediately after the header. In addition, the packets include hash values, which are calculated using an equation from the communicated contents, secret key, and so on, in order to prevent the falsification of the sender and manipulation of the data. Unlike ESP, the communicated contents are not encrypted, and the data is sent and received as plain text.

- **Encryption**

Select **DES**, **3DES**, **AES-CBC 128**, or **AES-CBC 256**.

- **Hash**

Select **None**, **MD5**, **SHA1**, **SHA256**, **SHA384**, or **SHA512**. **None** can be selected only when **ESP** is selected in **Protocol**.

- **SA Lifetime**

Specify the IKE SA lifetime.

Type the time (seconds) and number of kilobytes (KByte) before the IPsec SA will expire.

- **Encapsulation Mode**

Select **Transport** or **Tunnel**.

- **Remote Router IP-Address**

Specify the IP address (IPv4 or IPv6) of the connection destination. Enter this information only when the **Tunnel** mode is selected.



SA (Security Association) is an encrypted communication method using IPsec or IPv6 that exchanges and shares information, such as the encryption method and encryption key, in order to establish a secure communication channel before communication begins. SA may also refer to a virtual encrypted communication channel that has been established. The SA used for IPsec establishes the encryption method, exchanges the keys, and carries out mutual authentication according to the IKE (Internet Key Exchange) standard procedure. In addition, the SA is updated periodically.



Related Information

- [Configure an IPsec Template Using Web Based Management](#)

Send or Receive an Email Securely

- [Configure Email Sending or Receiving Using Web Based Management](#)
- [Send an Email with User Authentication](#)
- [Send or Receive an Email Securely Using SSL/TLS](#)

Configure Email Sending or Receiving Using Web Based Management

We recommend using Web Based Management to configure secured email sending with user authentication, or email sending and receiving using SSL/TLS.

1. Start your web browser.
2. Type "http://machine's IP address" in your browser's address bar (where "machine's IP address" is the machine's IP address).
For example:
http://192.168.1.2
3. No password is required by default. Type a password if you have set one, and then click .
4. Click the **Network** tab.
5. Click the **Protocol** menu in the left navigation bar.
6. In the **POP3/IMAP4/SMTP** field, click **Advanced Settings** and make sure the status of **POP3/IMAP4/SMTP** is **Enabled**.
7. Configure the **POP3/IMAP4/SMTP** settings.
 - Confirm that the email settings are correct after configuration by sending a test email.
 - If you do not know the POP3/IMAP4/SMTP server settings, contact your network administrator or Internet Service Provider (ISP).
8. When finished, click **Submit**.
The **Test Send/Receive E-mail Configuration** dialog box appears.
9. Follow the instructions in the dialog box to test the current settings.



Related Information

- [Send or Receive an Email Securely](#)

Send an Email with User Authentication

Your Brother machine supports the SMTP-AUTH method to send email via an email server that requires user authentication. This method prevents unauthorized users from accessing the email server.

You can use SMTP-AUTH for email notification, email reports and I-Fax.



We recommend using Web Based Management to configure the SMTP authentication.

Email Server Settings

You must configure your machine's SMTP authentication method to match the method used by your email server. For details about your email server settings, contact your network administrator or Internet Service Provider (ISP).



To enable SMTP server authentication: in the Web Based Management **POP3/IMAP4/SMTP** screen, under **Server Authentication Method**, you must select **SMTP-AUTH**.



Related Information

- [Send or Receive an Email Securely](#)
-

Send or Receive an Email Securely Using SSL/TLS

Your Brother machine supports SSL/TLS methods to send or receive an email via an email server that requires secure SSL/TLS communication. To send or receive email via an email server that is using SSL/TLS communication, you must configure SMTP over SSL/TLS, POP3 over SSL/TLS, or IMAP4 over SSL/TLS.



We recommend using Web Based Management to configure SSL/TLS.

Verify Server Certificate

Under **SSL/TLS**, if you choose **SSL** or **TLS**, the **Verify Server Certificate** check box will be selected automatically.

POP3/IMAP4/SMTP



[Cancel](#) [Submit](#)

Status Enabled

Send E-mail Settings(SMTP)

Server Address	<input type="text" value="0.0.0.0"/>
Port	<input type="text" value="25"/>
Server Authentication Method	<input checked="" type="radio"/> None <input type="radio"/> SMTP-AUTH
SMTP-AUTH Account Name	<input type="text"/>
SMTP-AUTH Account Password	<input type="text"/>
	Enter password
	Retype password
SSL/TLS	<input checked="" type="radio"/> None <input type="radio"/> SSL <input type="radio"/> TLS <input type="checkbox"/> Verify Server Certificate
Device E-mail Address	<input type="text" value="bmxxxxxxxxxxxx@example.com"/>

Receive E-mail Settings(POP3/IMAP4)

Protocol	<input checked="" type="radio"/> POP3 <input type="radio"/> IMAP4
Server Address	<input type="text" value="0.0.0.0"/>
Port	<input type="text" value="110"/>
Mailbox Name	<input type="text"/>
Mailbox Password	<input type="text"/>
	Enter password
	Retype password
	<input type="checkbox"/> Use APOP (POP3 Only)
Select Mail Folder Name(IMAP4 Only)	<input checked="" type="radio"/> Default(Inbox) <input type="radio"/> Specified : <input type="text"/>
SSL/TLS	<input checked="" type="radio"/> None <input type="radio"/> SSL <input type="radio"/> TLS <input type="checkbox"/> Verify Server Certificate
Segmented Message Timeout	<input type="text" value="120"/> minute(s)

[I-Fax>>](#)

[CA Certificate>>](#)

[E-mail report>>](#)

[Notification>>](#)

[Cancel](#) [Submit](#)



- Before you verify the server certificate, you must import the CA certificate issued by the CA that signed the server certificate. Contact your network administrator or your Internet Service Provider (ISP) to confirm if importing a CA certificate is necessary.
- If you do not need to verify the server certificate, clear the **Verify Server Certificate** check box.

Port Number

If you select **SSL** or **TLS** for SMTP, POP3, or IMAP4, the **Port** value will be changed to match the protocol. To change the port number manually, type the port number after you choose **SSL** or **TLS** for the **SSL/TLS** settings.

You must configure your machine's POP3/IMAP4/SMTP communication method to match the method used by your email server. For details about your email server settings, contact your network administrator or your ISP.

In most cases, the secured webmail services require the following settings:

SMTP	Port	25
	Server Authentication Method	SMTP-AUTH
	SSL/TLS	TLS
POP3	Port	995
	SSL/TLS	SSL
IMAP4	Port	993
	SSL/TLS	SSL



Related Information

- [Send or Receive an Email Securely](#)

Use IEEE 802.1x Authentication for a Wired or a Wireless Network

- [What Is IEEE 802.1x Authentication?](#)
- [Configure IEEE 802.1x Authentication for a Wired or a Wireless Network Using Web Based Management \(Web Browser\)](#)
- [IEEE 802.1x Authentication Methods](#)

What Is IEEE 802.1x Authentication?

IEEE 802.1x is an IEEE standard for wired and wireless networks that limits access from unauthorized network devices. Your Brother machine (supplicant) sends an authentication request to a RADIUS server (Authentication server) through your access point or HUB. After your request has been verified by the RADIUS server, your machine can access the network.



Related Information

- [Use IEEE 802.1x Authentication for a Wired or a Wireless Network](#)
-

Configure IEEE 802.1x Authentication for a Wired or a Wireless Network Using Web Based Management (Web Browser)

- If you configure your machine using EAP-TLS authentication, you must install the client certificate issued by a CA before you start configuration. Contact your network administrator about the client certificate. If you have installed more than one certificate, we recommend writing down the certificate name you want to use.
- Before you verify the server certificate, you must import the CA certificate that has been issued by the CA that signed the server certificate. Contact your network administrator or your Internet Service Provider (ISP) to confirm whether a CA certificate import is necessary.



You can also configure IEEE 802.1x authentication using:

- BRAdmin Professional 3 (Wired and wireless network)
- Wireless setup wizard from the control panel (Wireless network)
- Wireless setup wizard on the installation disc (Wireless network)

1. Start your web browser.
2. Type "http://machine's IP address" in your browser's address bar (where "machine's IP address" is the machine's IP address).

For example:

http://192.168.1.2



- If you are using a Domain Name System or enable a NetBIOS name, you can type another name, such as "SharedPrinter" instead of the IP address.

- For example:

http://SharedPrinter

If you enable a NetBIOS name, you can also use the node name.

- For example:

http://brnxxxxxxxxxxxx

The NetBIOS name can be found in the Network Configuration Report.

- For Macintosh, access Web Based Management by clicking the machine's icon on the **Status Monitor** screen.

3. No password is required by default. Type a password if you have set one, and then click .
4. Click the **Network** tab.
5. Do one of the following:

Option	Description
Wired network	Click the Wired tab, and then select Wired 802.1x Authentication in the left navigation bar.
Wireless network	Click the Wireless tab, and then select Wireless (Enterprise) in the left navigation bar.

6. Configure the IEEE 802.1x authentication settings.



- To enable IEEE 802.1x authentication for wired networks, select **Enabled** for **Wired 802.1x status** on the **Wired 802.1x Authentication** page.
- If you are using **EAP-TLS** authentication, you must select the client certificate that has been installed (shown with certificate name) for verification from the **Client Certificate** drop-down list.
- If you select **EAP-FAST**, **PEAP**, **EAP-TTLS**, or **EAP-TLS** authentication, select the verification method from the **Server Certificate Verification** drop-down list. Verify the server certificate using the CA certificate, imported to the machine in advance, that has been issued by the CA that signed the server certificate.

Select one of the following verification methods from the **Server Certificate Verification** drop-down list:

Option	Description
No Verification	The server certificate can always be trusted. The verification is not performed.
CA Cert.	The verification method to check the CA reliability of the server certificate, using the CA certificate that has been issued by the CA that signed the server certificate.
CA Cert. + ServerID	The verification method to check the common name ¹ value of the server certificate, in addition to the CA reliability of the server certificate.

7. When finished with configuration, click **Submit**.

For wired networks: After configuring, connect your machine to the IEEE 802.1x supported network. After a few minutes, print the Network Configuration Report to check the **<Wired IEEE 802.1x>** Status.

Option	Description
Success	The wired IEEE 802.1x function is enabled and the authentication was successful.
Failed	The wired IEEE 802.1x function is enabled; however, the authentication failed.
Off	The wired IEEE 802.1x function is not available.



Related Information

- [Use IEEE 802.1x Authentication for a Wired or a Wireless Network](#)

¹ The common name verification compares the common name of the server certificate to the character string configured for the **Server ID**. Before you use this method, contact your system administrator about the server certificate's common name and then configure **Server ID**.

IEEE 802.1x Authentication Methods

LEAP (Wireless network)

Lightweight Extensible Authentication Protocol (LEAP) is a proprietary EAP method developed by Cisco Systems, Inc., which uses a user ID and password for authentication.

EAP-FAST

Extensible Authentication Protocol-Flexible Authentication via Secured Tunneling (EAP-FAST) has been developed by Cisco Systems, Inc., which uses a user ID and password for authentication, and symmetric key algorithms to achieve a tunneled authentication process.

The Brother machine supports the following inner authentication methods:

- EAP-FAST/NONE
- EAP-FAST/MS-CHAPv2
- EAP-FAST/GTC

EAP-MD5 (Wired network)

Extensible Authentication Protocol-Message Digest Algorithm 5 (EAP-MD5) uses a user ID and password for challenge-response authentication.

PEAP

Protected Extensible Authentication Protocol (PEAP) is a version of EAP method developed by Cisco Systems, Inc., Microsoft® Corporation and RSA Security. PEAP creates an encrypted Secure Sockets Layer (SSL)/Transport Layer Security (TLS) tunnel between a client and an authentication server, for sending a user ID and password. PEAP provides mutual authentication between the server and the client.

The Brother machine supports the following inner authentications:

- PEAP/MS-CHAPv2
- PEAP/GTC

EAP-TTLS

Extensible Authentication Protocol-Tunneled Transport Layer Security (EAP-TTLS) has been developed by Funk Software and Certicom. EAP-TTLS creates a similar encrypted SSL tunnel to PEAP, between a client and an authentication server, for sending a user ID and password. EAP-TTLS provides mutual authentication between the server and the client.

The Brother machine supports the following inner authentications:

- EAP-TTLS/CHAP
- EAP-TTLS/MS-CHAP
- EAP-TTLS/MS-CHAPv2
- EAP-TTLS/PAP

EAP-TLS

Extensible Authentication Protocol-Transport Layer Security (EAP-TLS) requires digital certificate authentication both at a client and an authentication server.



Related Information

- [Use IEEE 802.1x Authentication for a Wired or a Wireless Network](#)

Store Print Log to Network

- [Store Log to Network Overview](#)
- [Configure the Store Print Log to Network Settings Using Web Based Management](#)
- [Use the Store Print Log to Network's Error Detection Setting](#)
- [Use Store Print Log to Network with Secure Function Lock 3.0](#)

Store Log to Network Overview

The Store Print Log to Network feature allows you to save the print log file from your Brother machine to a network server using the Common Internet File System (CIFS) protocol. You can record the ID, type of print job, job name, user name, date, time and the number of printed pages for every print job. CIFS is a protocol that runs over TCP/IP, allowing computers on a network to share files over an intranet or the Internet.

The following print functions are recorded in the print log:

- Print jobs from your computer
- USB Direct Print
- Copy
- Received Fax (supported models only)
- Web Connect Print (supported models only)



- The Store Print Log to Network feature supports Kerberos authentication and NTLMv2 authentication. You must configure the SNTP protocol (network time server), or you must set the date, time and time zone correctly on the control panel for authentication.
- You can set the file type to TXT or CSV when storing a file to the server.





Related Information

- [Store Print Log to Network](#)

Configure the Store Print Log to Network Settings Using Web Based Management

1. Start your web browser.
2. Type "http://machine's IP address" in your browser's address bar (where "machine's IP address" is the machine's IP address).
For example:
http://192.168.1.2
3. No password is required by default. Type a password if you have set one, and then click .
4. Click the **Administrator** tab.
5. Click the **Store Print Log to Network** menu.
6. In the **Print Log** field, click **On**.
7. Configure the following settings:

Option	Description
Network Folder Path	Type the destination folder where your log will be stored on the CIFS server (i.e., \ComputerName\SharedFolder).
File Name	Type the file name you want to use for the print log (up to 32 characters).
File Type	Select the TXT or CSV option for the Print Log file type.
Auth. Method	<p>Select the authentication method required for access to the CIFS server: Auto, Kerberos, or NTLMv2. Kerberos is an authentication protocol which allows devices or individuals to securely prove their identity to network servers using a single sign-on. NTLMv2 is the authentication method used by Windows® to log into servers.</p> <ul style="list-style-type: none">• Auto: If you select Auto, NTLMv2 will be used to the authentication method.• Kerberos: Select the Kerberos option to use Kerberos authentication only.• NTLMv2: Select the NTLMv2 option to use NTLMv2 authentication only. <p> For the Kerberos and NTLMv2 authentication, you must also configure the Date&Time settings or the SNTP protocol (network time server) and DNS server.</p> <p> You can also configure the Date & Time settings from the machine's control panel.</p>
Username	Type the user name for the authentication (up to 96 characters).  If the user name is part of a domain, enter the user name in one of the following styles: user@domain or domain\user.
Password	Type the password for the authentication (up to 32 characters).
Kerberos Server Address (if needed)	Type the KDC host address (for example: kerberos.example.com; up to 64 characters) or the IP address (for example: 192.168.56.189).
Error Detection Setting	Choose what action should be taken when the Print Log cannot be stored to the server due to a network error.

8. In the **Connection Status** field, confirm the last log status.



You can also confirm the error status on the LCD of your machine.

9. Click **Submit** to display the **Test Print Log to Network** page.
To test your settings, click **Yes** and then go to the next step.
To skip the test, click **No**. Your settings will be submitted automatically.
10. The machine will test your settings.
11. If your settings are accepted, **Test OK** appears on the screen.
If **Test Error** appears, check all settings, and then click **Submit** to display the Test page again.



Related Information

- [Store Print Log to Network](#)
-

Use the Store Print Log to Network's Error Detection Setting

Use Error Detection Settings to determine the action that is taken when the print log cannot be stored to the server due to a network error.

1. Start your web browser.
2. Type "http://machine's IP address" in your browser's address bar (where "machine's IP address" is the machine's IP address).

For example:

http://192.168.1.2

3. No password is required by default. Type a password if you have set one, and then click .
4. Click the **Administrator** tab.
5. Click the **Store Print Log to Network** menu in the left navigation bar.
6. In the **Error Detection Setting** section, select the **Cancel Print** or **Ignore Log & Print** option.

Option	Description
Cancel Print	If you select the Cancel Print option, the print jobs are canceled when the print log cannot be stored to the server.  Even if you select the Cancel Print option, your machine will print a received fax.

Ignore Log & Print If you select the **Ignore Log & Print** option, the machine prints the documentation even if the print log cannot be stored to the server.

When the store print log function has recovered, the print log is recorded as follows:

```
Id, Type, Job Name, User Name, Date, Time, Print Pages, Color Pages
1, Print (xxxxxxx), "Document01.doc", "user01", 03/03/20xx, 14:01:32, 52, 21
2, Print (xxxxxxx), "Document02.doc", "user01", 03/03/20xx, 14:45:30, ?, ?
3, <Error>, ?, ?, ?, ?, ?, ?
4, Print (xxxxxxx), "Report01.xls", "user02", 03/03/20xx, 19:30:40, 4, 4
```

- a. If the log cannot be stored at the end of printing, the print log except the number of printed pages will be recorded.
- b. If the print log cannot be stored at the beginning and the end of printing, the print log of the job will not be recorded. When the function has recovered, the error is reflected in the log.

7. Click **Submit** to display the **Test Print Log to Network** page.
To test your settings, click **Yes** and then go to the next step.
To skip the test, click **No**. Your settings will be submitted automatically.
8. The machine will test your settings.
9. If your settings are accepted, **Test OK** appears on the screen.
If **Test Error** appears, check all settings, and then click **Submit** to display the Test page again.

Related Information

- [Store Print Log to Network](#)

Use Store Print Log to Network with Secure Function Lock 3.0

When Secure Function Lock 3.0 is active, the names of the registered users for copy, Fax RX, Web Connect Print and USB Direct Print (if available) are recorded in the Store Print Log to Network report. When the Active Directory® Authentication is enabled, logged on user name will be recorded in the Store Print Log to Network report:

```
Id, Type, Job Name, User Name, Date, Time, Print Pages, Color Pages
1, Copy, -, -, 04/04/20xx, 09:05:12, 3, 3
2, Fax, -, -, 04/04/20xx, 09:45:30, 5, 0
3, Copy, -, "BOB", 04/04/20xx, 10:20:30, 4, 0
4, Fax, -, "BOB", 04/04/20xx, 10:35:12, 3, 0
5, USB Direct, -, "JOHN", 04/04/20xx, 11:15:43, 6, 6
```



Related Information

- [Store Print Log to Network](#)

Mobile/Web Connect

- [Brother Web Connect](#)
- [Google Cloud Print](#)
- [AirPrint](#)
- [Mobile Printing for Windows®](#)
- [Mopria® Print Service](#)
- [Brother iPrint&Scan](#)
- [Near-Field Communication \(NFC\)](#)

Brother Web Connect

- [Brother Web Connect Overview](#)
- [Online Services Used with Brother Web Connect](#)
- [Conditions for Using Brother Web Connect](#)
- [Set Up Brother Web Connect](#)
- [Scan and Upload Documents Using Brother Web Connect](#)
- [Download and Print Documents Using Brother Web Connect](#)
- [FaxForward to Cloud or E-mail](#)
- [Outline, Scan, and Copy or Cut Parts of Your Documents Using Brother Web Connect](#)
- [NotePrint and NoteScan](#)

Brother Web Connect Overview

Certain websites provide services that allow users to upload and view images and files on the websites. Your Brother machine can scan images and upload them to these services, and also download and print images that are already uploaded to these services.

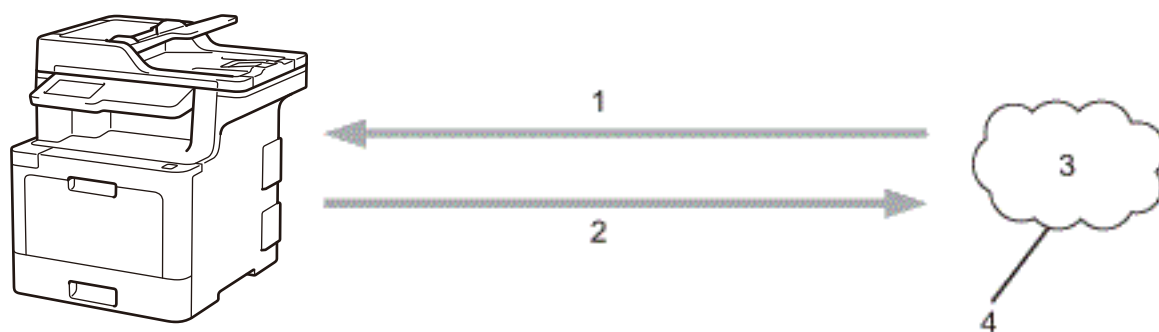

1. Printing
2. Scanning
3. Photos, images, documents and other files
4. Web Service

To use Brother Web Connect, your Brother machine must be connected to a network that has access to the Internet, through either a wired or wireless connection.

For network setups that use a proxy server, the machine must also be configured to use a proxy server. If you are unsure of your network configuration, check with your network administrator.



A proxy server is a computer that serves as an intermediary between computers without a direct Internet connection, and the Internet.



Related Information

- [Brother Web Connect](#)

Online Services Used with Brother Web Connect

Use Brother Web Connect to access services from your Brother machine:

To use Brother Web Connect, you must have an account with the online service you want to use. If you do not already have an account, use a computer to access the service's website and create an account.

You do not need to create an account to use Brother CreativeCenter.

Google Drive™

An online document storage, editing, sharing and file synchronization service.

URL: drive.google.com

Flickr®

An online photo sharing service. Images can be uploaded, organized into albums, and shared with other users.

URL: www.flickr.com

Facebook

A social networking service that also allows images to be uploaded and shared with other users.

URL: www.facebook.com

Evernote®

An online file storage and management service.

URL: www.evernote.com

Dropbox

An online file storage, sharing and synchronization service.

URL: www.dropbox.com

OneDrive®

An online file storage, sharing and managing service.

URL: onedrive.live.com

Box

An online document editing and sharing service.

URL: www.box.com

OneNote®

An online document editing and sharing service.

URL: www.onenote.com

Brother CreativeCenter

A website that offers various templates, such as greeting cards, brochures and calendars that you can print on your Brother machine (available only for certain countries).

www.brother.com/creativecenter

For more information about any of these services, refer to the respective service's website.

The following table describes which file types can be used with each Brother Web Connect feature:

Accessible Services	Flickr® Facebook	Google Drive™ Evernote® Dropbox OneDrive® Box OneNote®	Brother CreativeCenter
Download and print images	JPEG	JPEG PDF DOCX XLSX PPTX ¹	(Print only)
Upload scanned images	JPEG	JPEG PDF ² DOCX XLSX PPTX TIFF XPS	-
FaxForward to the online services (available only for certain models)	JPEG	JPEG PDF TIFF	-

¹ DOC/XLS/PPT formats are also available for downloading and printing images.

² For upload scanned images, PDF includes Searchable PDF, Signed PDF, Secure PDF, PDF/A and High Compression PDF.



(For Hong Kong, Taiwan and Korea)

Brother Web Connect supports only file names written in English. Files named in the local language will not be downloaded.



Related Information

- [Brother Web Connect](#)

Conditions for Using Brother Web Connect

- [Brother Software Installation for Using Brother Web Connect](#)
- [Configure the Proxy Server Settings Using Your Brother Machine's Control Panel](#)
- [Configure the Proxy Server Settings Using Web Based Management](#)

Brother Software Installation for Using Brother Web Connect

The initial installation of Brother Web Connect requires a computer that has access to the Internet and has the Brother machine's software installed.

For Windows®:

To install the Brother Software and configure the machine to be able to print over your wired or wireless network, see the *Quick Setup Guide* included with your Brother machine.

For Macintosh:

To install the Brother Software, go to your model's **Downloads** page on the Brother Solutions Center at support.brother.com.



Related Information

- [Conditions for Using Brother Web Connect](#)

Configure the Proxy Server Settings Using Your Brother Machine's Control Panel

If your network uses a proxy server, the following proxy server information must be configured on the machine:

- Proxy server address
- Port number
- User Name
- Password

1. Press  [Settings] > [All Settings] > [Network] > [Web Connect Settings] > [Proxy Settings] > [Proxy Connection] > [On].



If your machine displays the [All Settings] menu on the Home screen, skip the [Settings] menu.

2. Press the option that you want to set, and then enter the proxy server information.
3. Press .



Related Information

- [Conditions for Using Brother Web Connect](#)

Configure the Proxy Server Settings Using Web Based Management

If your network uses a proxy server, the following proxy server information must be configured using Web Based Management:

- Proxy server address
- Port number
- User Name
- Password



We recommend Microsoft® Internet Explorer® 11 for Windows® and Safari 9 for Macintosh. Make sure that JavaScript and Cookies are always enabled in whichever browser you use.

1. Start your web browser.
2. Type "http://machine's IP address" in your browser's address bar (where "machine's IP address" is the machine's IP address).
For example:
http://192.168.1.2
3. No password is required by default. Type a password if you have set one, and then click .
4. Click the **Network** tab.
5. Click the **Protocol** menu in the left navigation bar.
6. Make sure the **Proxy** check box is selected, and then click **Submit**.
7. In the **Proxy** field, click **Advanced Settings**.
8. Enter the proxy server information.
9. Click **Submit**.



Related Information

- [Conditions for Using Brother Web Connect](#)

Set Up Brother Web Connect

- [Brother Web Connect Setup Overview](#)
- [Create an Account for Each Online Service Before Using Brother Web Connect](#)
- [Apply for Brother Web Connect Access](#)
- [Register an Account on Your Brother Machine for Brother Web Connect](#)
- [Set Up Brother Web Connect for Brother CreativeCenter](#)

Brother Web Connect Setup Overview

Configure the Brother Web Connect settings using the following procedure (when using Brother CreativeCenter, this procedure is not necessary):

Step 1: Create an account with the service you want to use.

Access the service's website using a computer and create an account. (If you already have an account, there is no need to create an additional account.)

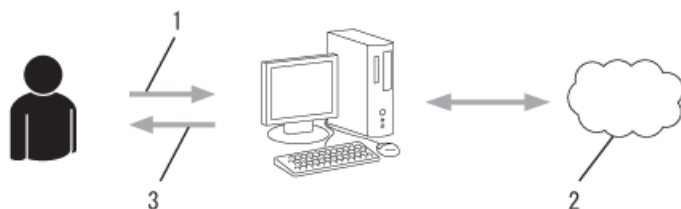

1. User registration
2. Web Service
3. Obtain account

Step 2: Apply for Brother Web Connect access.

Start Brother Web Connect access using a computer and obtain a temporary ID.

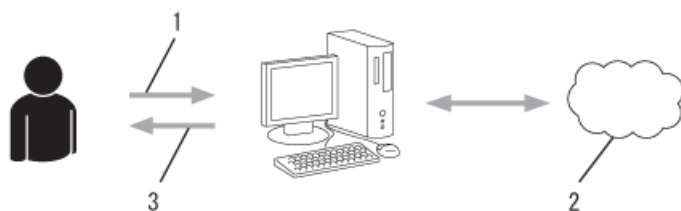

1. Enter account information
2. Brother Web Connect application page
3. Obtain temporary ID

Step 3: Register your account information on your machine so you can access the service you want to use.

Enter the temporary ID to enable the service on your machine. Specify the account name as you would like it to be displayed on the machine, and enter a PIN if you would like to use one.

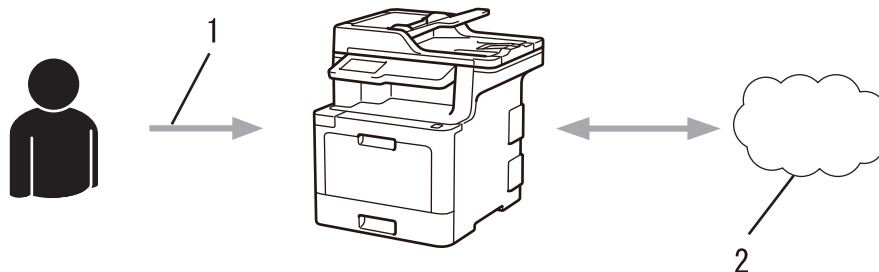

1. Enter temporary ID
2. Web Service

Your Brother machine can now use the service.



Related Information

- [Set Up Brother Web Connect](#)

Create an Account for Each Online Service Before Using Brother Web Connect

To use Brother Web Connect to access an online service, you must have an account with that online service. If you do not already have an account, use a computer to access the service's website and create an account. After creating an account, log on and use the account once with a computer before using the Brother Web Connect feature. Otherwise, you may not be able to access the service using Brother Web Connect.

If you already have an account, there is no need to create an additional account.

After you finish creating an account with the online service you want to use, apply for Brother Web Connect access.



You do not need to create an account if you use the service as a guest. You can use only certain services as a guest. If the service you want to use does not have a guest-user option, you must create an account.







Related Information

- [Set Up Brother Web Connect](#)

Apply for Brother Web Connect Access

To use Brother Web Connect to access online services, you must first apply for Brother Web Connect access using a computer that has the Brother Software installed.

1. Access the Brother Web Connect application website:

Option	Description
Windows® 7	Click  (Start) > All Programs > Brother > Brother Utilities , and then click the drop-down list and select your model name (if not already selected). Click Do More in the left navigation bar, and then click Brother Web Connect .
Windows® 8 Windows® 10	Launch  (Brother Utilities), and then click the drop-down list and select your model name (if not already selected). Click Do More in the left navigation bar, and then click Brother Web Connect .
Windows® 8.1	Move your mouse to the lower left corner of the Start screen and click  (if you are using a touch-based device, swipe up from the bottom of the Start screen to bring up the Apps screen). Click  (Brother Utilities), and then click the drop-down list and select your model name (if not already selected). Click Do More in the left navigation bar, and then click Brother Web Connect .
Macintosh	Click Go in the Finder bar, Applications > Brother > Utilities > Brother Web Connect .



You can also access the website directly:

Type bwc.brother.com into your web browser's address bar.

The Brother Web Connect page launches.











The first time you launch Brother Web Connect, you must select your country, language, and model name, and then click **Next** to move to the next step, selecting the service you want.

2. Select the service you want to use.

Get connected with Web Connect

Click on one of the following services to be used on your machine to obtain a temporary ID. Business versions of the web services are also supported including: OneDrive for business, Dropbox for business, Google apps for work, Evernote business and Box for business.

 OneNote	 OneDrive	 Box
 Connect to Google Drive™	 EVERNOTE	 Dropbox
 Facebook	 flickr® from YAHOO!	FLICKR®

The services available for your machine may vary depending on the model and firmware version of your machine. If any of the web services on this page are missing from your machine or you experience any other problem with Brother Web Connect please make sure you have the latest firmware installed.

[For more information, please go to our support site.](#)

[Online User's Guide Download Page](#)



[Terms of Use](#)

The actual screen may differ from the screen shown above.

3. Follow the on-screen instructions and apply for access.

When finished, your temporary ID will appear.

Get connected with Brother Web Connect

Finished the registration.

Please enter the following temporary ID on the LCD screen of your machine.

Temporary ID (11 digits)

XXX XXXX XXXX

NOTE : The temporary ID will expire in 24 hours.

[TOP](#)

4. Make a note of your temporary ID, as you will need it to register accounts to the machine. The temporary ID is valid for 24 hours.
5. Close the web browser.

Now that you have a Brother Web Connect access ID, you must register this ID on your machine, and then use your machine to access the web service you want to use.



Related Information

- [Set Up Brother Web Connect](#)
- [Register an Account on Your Brother Machine for Brother Web Connect](#)

Register an Account on Your Brother Machine for Brother Web Connect

You must enter your Brother Web Connect account information and configure your machine so that it can use Brother Web Connect to access the service you want.

- You must apply for Brother Web Connect access to register an account on your machine.
- Before you register an account, confirm that the correct date and time are set on the machine.

1. Swipe to display the [Web] option.
2. Press [Web].



- If information regarding the Internet connection appears on the machine's LCD, read the information and press [OK]. If you want to display this information again, press [Yes].
- Occasionally, updates or announcements about Brother Web Connect's features will appear on the LCD. Read the information, and then press [OK].

3. If the information regarding license agreement appears, make your selection and follow the on-screen instructions.
4. Select the service with which you want to register.
5. Press the service name.
6. If information regarding Brother Web Connect appears, press [OK].
7. Press [Register/Delete Account].
8. Press [Register Account].
The machine will prompt you to enter the temporary ID you received when you applied for Brother Web Connect access.
9. Press [OK].
10. Enter the temporary ID using the LCD.
11. Press [OK].



An error message will appear on the LCD if the information you entered does not match the temporary ID you received when you applied for access, or if the temporary ID has expired. Enter the temporary ID correctly, or apply for access again to receive a new temporary ID.

The machine will prompt you to enter the account name that you want to be displayed on the LCD.

12. Press [OK].
13. Enter the name using the LCD.
14. Press [OK].
15. Do one of the following:
 - To set a PIN for the account, press [Yes]. (A PIN prevents unauthorized access to the account.) Enter a four-digit number, and then press [OK].
 - If you do not want to set a PIN, press [No].
16. When the account information you entered appears, confirm that it is correct.
17. Press [Yes] to register your information as entered.
18. Press [OK].
19. Press .

Registration is complete and your machine can now access the service.



Related Information

- [Set Up Brother Web Connect](#)
- [Apply for Brother Web Connect Access](#)

Set Up Brother Web Connect for Brother CreativeCenter

Brother Web Connect is set up to work with Brother CreativeCenter automatically. No configuration is needed to create the calendars, business cards, posters and greeting cards available at www.brother.com/creativecenter.



Brother CreativeCenter is not available in all countries.



Related Information

- [Set Up Brother Web Connect](#)

Scan and Upload Documents Using Brother Web Connect

Upload your scanned photos and documents directly to a web service without using a computer.

- When scanning and uploading JPEG files, black and white scanning is not available.
- When scanning and uploading Searchable PDF or Microsoft® Office files, black and white and gray scanning is not available.
- When scanning and uploading JPEG files, each page is uploaded as a separate file.
- Uploaded documents are saved in an album named **From_BrotherDevice**.

For information regarding restrictions, such as the size or number of documents that can be uploaded, refer to the respective service's website.

If you are a restricted Web Connect user due to the Secure Function Lock feature (available for certain models), you cannot upload the scanned data.

1. Load your document.
2. Swipe to display the [Web] option.
3. Press [Web].



- You can also press [Scan] > [to Web].
- If information regarding the Internet connection appears on the machine's LCD, read the information and press [OK]. If you want to display this information again, press [Yes].
- Occasionally, updates or announcements about Brother Web Connect's features will appear on the LCD. Read the information, and then press [OK].

4. Select the service that hosts the account to which you want to upload.
5. Select your account name.
6. Follow the on-screen instructions to complete this operation.



Related Information

- [Brother Web Connect](#)

Download and Print Documents Using Brother Web Connect

Documents that have been uploaded to your account can be downloaded directly to your machine and printed. Documents that other users have uploaded to their own accounts for sharing can also be downloaded to your machine and printed, as long as you have viewing privileges for those documents. Certain services allow guest users to view documents that are public. When accessing a service or an account as a guest user, you can view documents that the owner has made public, that is, documents with no viewing restrictions.

To download other users' documents, you must have access privileges to view the corresponding albums or documents.

If you are a restricted user for Web Connect due to the Secure Function Lock feature (available for certain models), you cannot download the data.

The Secure Function Lock Page Limit feature applies to the print job using Web Connect.



For Hong Kong, Taiwan and Korea

Brother Web Connect supports only file names written in English. Files named in the local language will not be downloaded.



Related Information

- [Brother Web Connect](#)
 - [Download and Print Using Web Services](#)
 - [Download and Print Brother CreativeCenter Templates](#)
-

Download and Print Using Web Services

For information on Brother CreativeCenter Templates, see *Related Information*.

1. Swipe to display the [Web] option.
2. Press [Web].



- If information regarding the Internet connection appears on the machine's LCD, read the information and press [OK]. If you want to display this information again, press [Yes].
- Occasionally, updates or announcements about Brother Web Connect's features will appear on the LCD. Read the information, and then press [OK].

3. Select the service that hosts the document you want to download and print.
4. Select your account name. If the PIN entry screen appears, enter the four-digit PIN and press [OK].



- To access the service as a guest user, select [Use Service as a Guest User]. When the information regarding access as a guest user appears, press [OK]. Type the account name of the user whose documents you want to download, and then press [OK].
- Depending on the service, you may have to select the account name from a list.

5. Press [Download to Print].
6. Select the album you want. Some services do not require documents to be saved in albums. For documents not saved in albums, select [Show Unsorted Photos] or [Show Unsorted Files] to select documents. Other users' documents cannot be downloaded if they are not saved in an album.



- To download from Flickr® and Facebook, choose the album you want to download.
- An album is a collection of images. The actual term may differ depending on the service you use. When using Evernote®, you must select the notebook, and then select the note.

7. Select the thumbnail of the document you want to print. Confirm the document on the LCD and then press [OK]. Select additional documents to print (you can select up to 10 documents).
8. When finished, press [OK].
9. Follow the on-screen instructions to complete this operation.



Related Information

- [Download and Print Documents Using Brother Web Connect](#)
- [Download and Print Brother CreativeCenter Templates](#)

Download and Print Brother CreativeCenter Templates

Brother CreativeCenter is not available in all countries.

1. Swipe to display the [Apps] option.
2. Press [Apps].



- If information regarding the Internet connection appears on the machine's LCD, read the information and press [OK]. If you want to display this information again, press [Yes].
- Occasionally, updates or announcements about Brother Web Connect's features will appear on the LCD. Read the information, and then press [OK].

3. Press [Print "CreativeCenter" Templates].
4. Select the category you want.
5. Select the category you want again.
6. Select the file you want. Enter the number of copies you want to print and then press [OK]. Repeat this step until you have chosen all the files that you want to print.
7. After you have selected all of the files you want to print, press [OK].



If information regarding the recommended print settings appears on the machine's LCD, read the information and press [OK]. If you want to display this information again, press [Yes].

8. Follow the on-screen instructions to complete this operation.



Related Information

- [Download and Print Documents Using Brother Web Connect](#)
- [Download and Print Using Web Services](#)

FaxForward to Cloud or E-mail

- Use the FaxForward to Cloud feature to automatically forward incoming faxes to your accounts with the available online services.

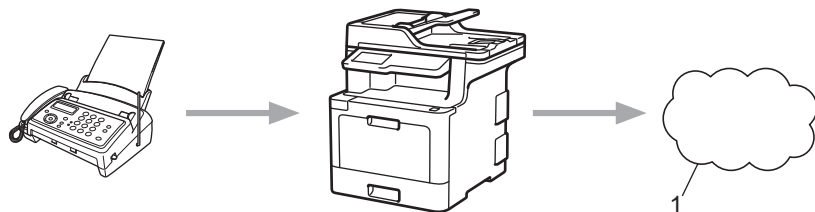

1. Web Service

- Use the FaxForward to E-mail feature to automatically forward incoming faxes to an inbox as email attachments.

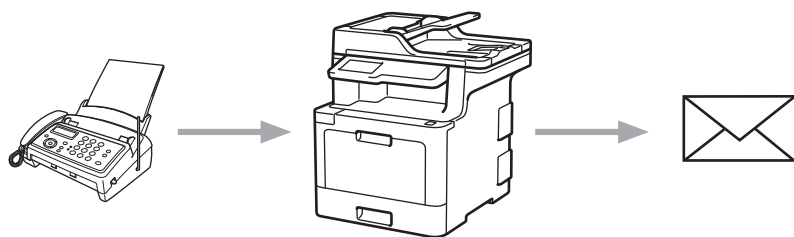

✓ Related Information

- [Brother Web Connect](#)
- [Turn On FaxForward to Cloud or E-mail](#)
- [Turn Off FaxForward to Cloud or E-mail](#)

Turn On FaxForward to Cloud or E-mail

Turn on the FaxForward feature to automatically forward incoming faxes to either an online service or an inbox as email attachments.

- If you are a restricted Web Connect user due to the Secure Function Lock feature (available for certain models), you cannot upload the incoming faxes.
- This feature is available only for black and white faxes.
- If you turn on the FaxForward to Cloud feature, you cannot use the following features:
 - [Fax Forward]
 - [Paging] (available only for certain countries)
 - [Fax Storage]
 - [PC Fax Receive]

1. Swipe to display the [Apps] option.
2. Press [Apps].



- If information regarding the Internet connection appears on the machine's LCD, read the information and press [OK]. If you want to display this information again, press [Yes].
- Occasionally, updates or announcements about Brother Web Connect's features will appear on the LCD. Read the information, and then press [OK].

3. Select [FaxForward to Cloud/E-mail].



If information regarding [FaxForward to Cloud/E-mail] appears, read it, and then press [OK].

4. Press [On].
5. Press [Forward to Cloud] or [Forward to E-mail].
 - If you selected [Forward to Cloud], choose the online service you want to receive the faxes, and then specify your account name.
 - If you selected [Forward to E-mail], enter the email address you want to receive the faxes as email attachments.
6. Follow the on-screen instructions to complete this operation.



Related Information

- [FaxForward to Cloud or E-mail](#)

Turn Off FaxForward to Cloud or E-mail

Turn off FaxForward when you want to stop incoming faxes from automatically going to either an online service or an inbox as email attachments.

If there are received faxes still in your machine's memory, you cannot turn off the FaxForward to Cloud feature.

1. Swipe to display the [Apps] option.
2. Press [Apps].



- If information regarding the Internet connection appears on the machine's LCD, read the information and press [OK]. If you want to display this information again, press [Yes].
- Occasionally, updates or announcements about Brother Web Connect's features will appear on the LCD. Read the information, and then press [OK].

3. Select [FaxForward to Cloud/E-mail].



If information regarding [FaxForward to Cloud/E-mail] appears, read it, and then press [OK].

4. Press [Off].
5. Press [OK].



Related Information

- [FaxForward to Cloud or E-mail](#)

Outline, Scan, and Copy or Cut Parts of Your Documents Using Brother Web Connect

When you outline specific areas of a document using a red pen and then scan the document, the outlined areas will be captured and can be processed in various ways.

Outline and Scan

When you use a red pen to outline sections of a document and then scan the document, the outlined areas are extracted and saved to a cloud service as separate JPEG files.



1. Web Service

Copy Outlined Area (available only for some models)

When you use a red pen to outline sections of a document and then scan the document, the outlined areas are extracted, rearranged and printed together.

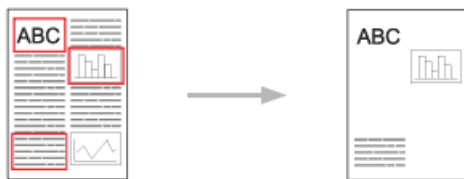

Cut Outlined Area (available only for some models)

When you use a red pen to outline sections of a document and then scan the document, the outlined areas are deleted and the remaining information is printed.

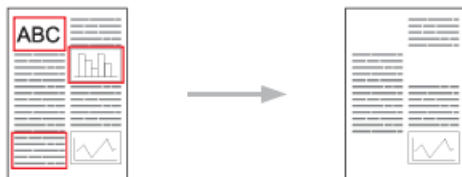

Outlining

Correct outline style	Incorrect outline style

- Use a red pen or marker with a tip width of 0.04 in.-0.39 in. (1.0 mm-10.0 mm), that is, from an extra-fine tip up to an extra-thick marker tip.

-
- Outlined areas with thick red lines are easier to recognize. However, do not use a pen or marker with a tip wider than indicated above.
 - The red outline must not be broken and the line must not cross more than once.
 - The outlined area must have a length and width of at least 0.4 in. (1 cm).
 - If the paper has a dark background color, the outlined area may be difficult to recognize.



Related Information

- [Brother Web Connect](#)
 - [Outline and Scan a Document to the Cloud](#)
 - [Copy an Outlined Section Using Brother Web Connect](#)
 - [Cut an Outlined Section Using Brother Web Connect](#)
-

Outline and Scan a Document to the Cloud

The areas outlined using a red pen are extracted and saved to a cloud service as separate JPEG files.

1. Using a thick red pen or marker, outline the areas of the document that you want to scan.
2. Load your document.
3. Swipe to display the [Apps] option.
4. Press [Apps].



- If information regarding the Internet connection appears on the machine's LCD, read the information and press [OK]. If you want to display this information again, press [Yes].
- Occasionally, updates or announcements about Brother Web Connect's features will appear on the LCD. Read the information, and then press [OK].

5. Select [Outline&Scan].



- If information regarding [Outline&Scan] appears, read the information and press [OK]. If you want to display this information again, press [Yes].

6. Select the service you want.
7. Select your account name.
 - If the PIN entry screen appears, enter the four-digit PIN and press [OK].
 - If the LCD prompts you to specify scan size, select the scan size of the document you are scanning.
8. Press [OK].

The machine scans the document and starts uploading. If you are using the machine's scanner glass, follow the LCD instructions to complete the scanning job.

9. When the machine finished uploading the image, press [OK].
10. Press .



Related Information

- [Outline, Scan, and Copy or Cut Parts of Your Documents Using Brother Web Connect](#)

Copy an Outlined Section Using Brother Web Connect

Outline areas of your document with a red line and use Outline and Copy to display only those areas in your final scanned document.

1. Using a thick red pen or marker, outline the areas of the document that you want to copy.
2. Load your document.
3. Swipe to display the [Apps] option.
4. Press [Apps].



- If information regarding the Internet connection appears on the machine's LCD, read the information and press [OK]. If you want to display this information again, press [Yes].
- Occasionally, updates or announcements about Brother Web Connect's features will appear on the LCD. Read the information, and then press [OK].

5. Select [Outline&Copy].
6. Press [Copy outlined area].
7. If information regarding [Copy outlined area] appears, read the information and press [OK]. If you want to display this information again, press [Yes].
8. The Copy Settings screen will appear. Change your setting, if needed. Press [OK].
9. Press [OK].
The machine starts scanning. If you are using the machine's scanner glass, follow the LCD instructions to complete the printing job.
10. When the machine finished printing, press [OK].
11. Press .



Related Information

- [Outline, Scan, and Copy or Cut Parts of Your Documents Using Brother Web Connect](#)

Cut an Outlined Section Using Brother Web Connect

Outline areas of your document with a red line and use Outline and Cut to remove those areas from your final scanned document.

1. Using a thick red pen or marker, outline the areas of the document that you want to cut.
2. Load your document.
3. Swipe to display the [Apps] option.
4. Press [Apps].



- If information regarding the Internet connection appears on the machine's LCD, read the information and press [OK]. If you want to display this information again, press [Yes].
- Occasionally, updates or announcements about Brother Web Connect's features will appear on the LCD. Read the information, and then press [OK].

5. Select [Outline&Copy].
6. Press [Cut outlined area].
7. If information regarding [Cut outlined area] appears, read the information and press [OK]. If you want to display this information again, press [Yes].
8. The Copy Settings screen will appear. Change your setting, if needed. Press [OK].
9. Press [OK].
The machine starts scanning. If you are using the machine's scanner glass, follow the LCD instructions to complete the printing job.
10. When the machine finished printing, press [OK].
11. Press .



Related Information

- [Outline, Scan, and Copy or Cut Parts of Your Documents Using Brother Web Connect](#)

NotePrint and NoteScan

- [NotePrint and NoteScan Overview](#)
- [Print Note Sheet and Folder Templates](#)
- [Scan a Note Sheet to the Cloud](#)

NotePrint and NoteScan Overview

Use this function to print note sheets and the folders designed to hold them, and to scan note sheets so that each page of notes is saved as a JPEG file.

The printed note sheets can be folded in half or quarters, used, and stored in the folders. After writing on the note sheets pre-printed with lines or a grid, scan the sheets and save your notes to a cloud service.

NotePrint

Select a specific style of note sheet or note folder to print.

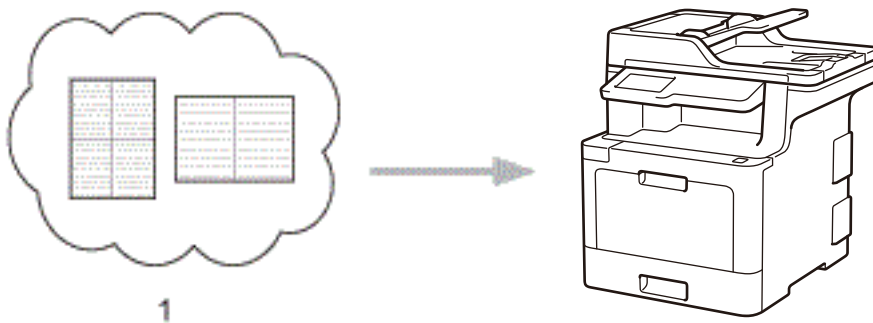

1. Brother Cloud

NoteScan

After writing on your note sheet, scan it to save each section of notes as a JPEG file. If you use our 2-, 4-, or 8-in-1 style, each page of notes is saved as a separate JPEG file.

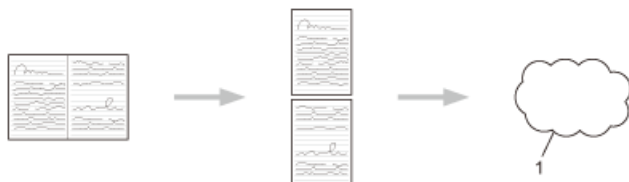

1. Web Service



You must use Brother note sheet templates to successfully use the NoteScan feature.

Note Sheet templates:

1 in 1, Note style	2 in 1, Dot graph style	4 in 1, Note style	8 in 1, Grid style

Note Folder templates:



How to use note sheets and note folders

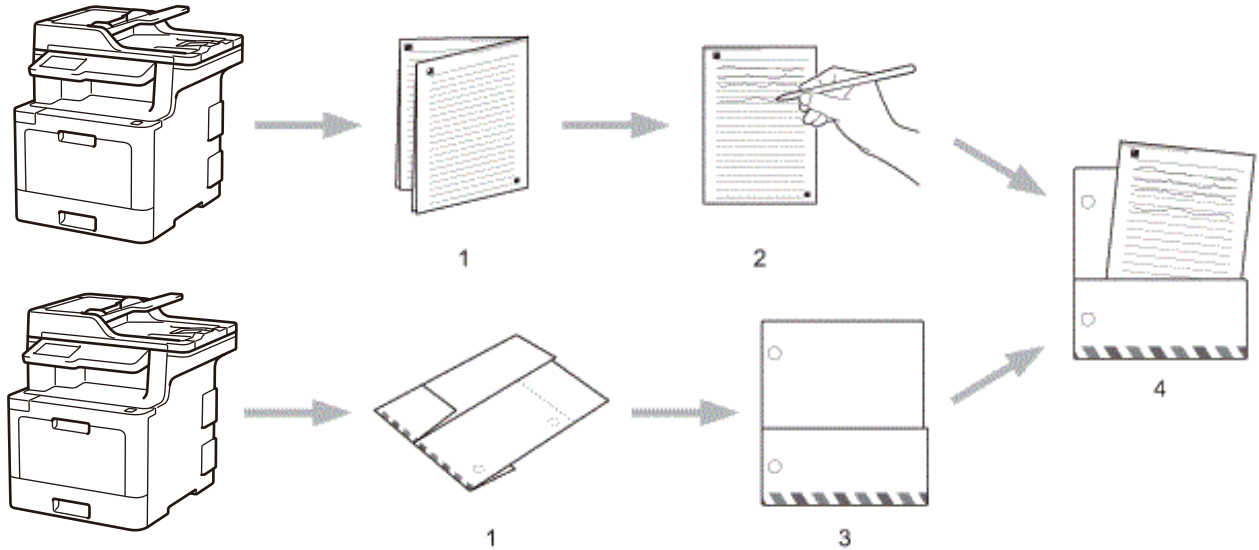

1. Print template and fold on dotted lines.
2. Write your notes.
3. Tape sides and punch binder holes in folder, if needed.
4. Store notes in the custom folder for later use.

✓ Related Information

- [NotePrint and NoteScan](#)

Print Note Sheet and Folder Templates

1. Swipe to display the [Apps] option.

2. Press [Apps].



- If information regarding the Internet connection appears on the machine's LCD, read the information and press [OK]. If you want to display this information again, press [Yes].
- Occasionally, updates or announcements about Brother Web Connect's features will appear on the LCD. Read the information, and then press [OK].

3. Select [NoteScan].

4. Press [Print Note & Folder template].



- If information regarding [Print Note&Folder] appears, read the information and press [OK]. If you want to display this information again in the future, press [Yes].

5. Press [Note Format] or [Note Folder].

6. Select the category and file you want.

7. Enter the number of copies you want to print, and then press [OK].



- After the folder is printed, fold the paper along the dotted lines and secure the folded areas with tape or other adhesive. You can use a three-hole punch to make the folder suitable for use in a binder.

8. Press [OK].

9. Press [OK].

The machine starts printing.

10. Press [OK] when it is finished.

11. Press .



Related Information

- [NotePrint and NoteScan](#)

Scan a Note Sheet to the Cloud

Each page of your Note Sheet is saved as a separate JPEG file.

1. Load your document.
2. Swipe to display the [Apps] option.
3. Press [Apps].



- If information regarding the Internet connection appears on the machine's LCD, read the information and press [OK]. If you want to display this information again, press [Yes].
- Occasionally, updates or announcements about Brother Web Connect's features will appear on the LCD. Read the information, and then press [OK].

4. Select [NoteScan].
5. Press [Scan Notes].
6. If information regarding [Scan Notes] appears, read the information and press [OK]. If you want to display this information again, press [Yes].
7. Select the service you want.
8. Select your account name.
9. Follow the on-screen instructions to complete this operation.



Related Information

- [NotePrint and NoteScan](#)

Google Cloud Print

- [Google Cloud Print Overview](#)
- [Before Using Google Cloud Print](#)
- [Print from Google Chrome™ or Chrome OS™](#)
- [Print from Google Drive™ for Mobile](#)
- [Print from Gmail™ Webmail Service for Mobile](#)

Google Cloud Print Overview

Google Cloud Print™ is a Google service that allows you to print to a printer registered to your Google account using a network-compatible device (such as a mobile phone or computer) without installing the printer driver on the device.

Printing from Android™ applications requires installing the Google Cloud Print™ application from the Google Play™ Store app.

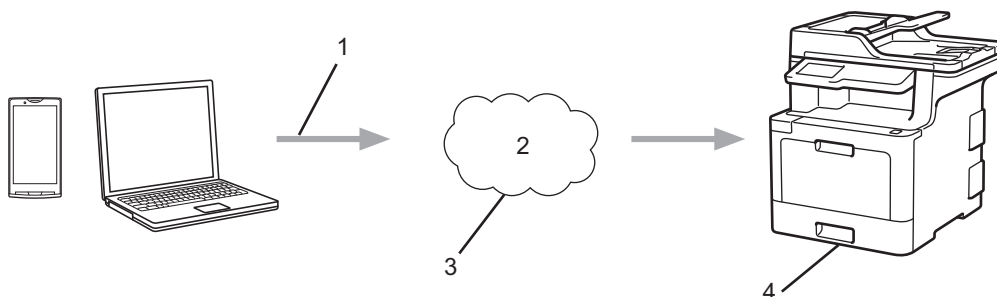

1. Print request
2. Internet
3. Google Cloud Print™
4. Printing

✓ Related Information

- [Google Cloud Print](#)

Before Using Google Cloud Print

- [Network Settings for Using Google Cloud Print](#)
- [Register Your Machine with Google Cloud Print Using Google Chrome™](#)
- [Register Your Machine with Google Cloud Print Using Web Based Management](#)

Network Settings for Using Google Cloud Print

In order to use Google Cloud Print™, your Brother machine must be connected to a network that has access to the Internet, either through a wired or wireless connection. To connect and configure your machine correctly, see the *Quick Setup Guide* or related topics in this guide.



Related Information

- [Before Using Google Cloud Print](#)
 - [Google Cloud Print Problems](#)
-

Register Your Machine with Google Cloud Print Using Google Chrome™

Make sure you have already created a Google Account. If you do not have an account, use a computer or mobile device to access the Google website (<https://accounts.google.com/signup>) and create an account. Make sure your Brother machine is idle before starting the registration process.



The steps in this section are examples for Windows users.

Screens on your computer may vary depending on your operating system and environment.

1. Open Google Chrome™ on your computer.
2. Sign in to your Google Account.
3. Click the Google Chrome™ menu icon, and then **Settings > Show advanced settings....**
4. In the **Google Cloud Print** section, click **Manage**.
5. Follow the on-screen instructions to register your machine.
6. When a confirmation message appears on your machine, press the OK button.



If the confirmation message does not appear on your machine's LCD, repeat these steps.

7. When your Brother machine is successfully registered, it will appear in the **My devices** field.



Related Information

- [Before Using Google Cloud Print](#)

Register Your Machine with Google Cloud Print Using Web Based Management

Make sure you have already created a Google Account. If you do not have an account, use a computer or mobile device to access the Google website (<https://accounts.google.com/signup>) and create an account.

Make sure your Brother machine is idle before starting the registration process.

Before you begin to register your machine, confirm that the correct date and time are set on the machine.

1. Confirm that your Brother machine is connected to the same network as your computer or mobile device.
2. Start your web browser.
3. Type "http://machine's IP address" in your browser's address bar (where "machine's IP address" is the machine's IP address).
For example:
http://192.168.1.2
4. No password is required by default. Type a password if you have set one, and then click .
5. Click the **Network** tab.
6. Click the **Protocol** menu in the left navigation bar.
7. Make sure that **Google Cloud Print** is selected, and then click **Advanced Settings**.
8. Make sure that **Status** is set to **Enabled**. Click **Register**.
9. Follow the on-screen instructions to register your machine.
10. When a confirmation message appears on your machine, press the OK button.



If the confirmation message does not appear on your machine's LCD, repeat these steps.

11. Click **Google**.
12. The sign-in screen for Google Cloud Print™ appears. Sign in with your Google Account and follow the on-screen instructions to register your machine.
13. When you have finished registering your machine, return to the Web Based Management screen and make sure that **Registration Status** is set to **Registered**.



If your machine supports the Secure Function Lock feature, printing via Google Cloud Print™ is possible even if PC print for each user is restricted. To restrict printing via Google Cloud Print™, disable Google Cloud Print™ using Web Based Management or set the Secure Function Lock feature to Public Mode, and then restrict print for public users. See *Related Information*.



Related Information

- [Before Using Google Cloud Print](#)
- [Configure Public Mode for Secure Function Lock 3.0](#)

Print from Google Chrome™ or Chrome OS™

1. Make sure your Brother machine is turned on.
2. Open the web page that you want to print.
3. Click the Google Chrome™ menu icon.
4. Click **Print**.
5. Select your machine from the printer list.
6. Change print options, if needed.
7. Click **Print**.



Related Information

- [Google Cloud Print](#)
-

Print from Google Drive™ for Mobile

1. Make sure your Brother machine is turned on.
2. Access Google Drive™ from your Android™ or Apple device's web browser.
3. Open the document that you want to print.
4. Tap the menu icon.
5. Tap **Print**.
6. Select your machine from the printer list.
7. Change print options, if needed.
8. Tap  or **Print**.



Related Information

- [Google Cloud Print](#)

Print from Gmail™ Webmail Service for Mobile

1. Make sure your Brother machine is turned on.
2. Access the Gmail™ webmail service from your Android™ or Apple device's web browser.
3. Open the email that you want to print.
4. Tap the menu icon.



If **Print** appears beside the attachment name, you can also print the attachment. Tap **Print**, and then follow the instructions on your mobile device.

5. Tap **Print**.
6. Select your machine from the printer list.
7. Change print options, if needed.
8. Tap  or **Print**.



Related Information

- [Google Cloud Print](#)

AirPrint

- [AirPrint Overview](#)
- [Before Using AirPrint](#)
- [Print Using AirPrint](#)
- [Scan Using AirPrint](#)
- [Send a Fax Using AirPrint \(For MFC Models\)](#)

AirPrint Overview

Use Brother AirPrint to wirelessly print photos, emails, web pages, and documents from your iPad, iPhone and iPod touch without installing a printer driver on the device.

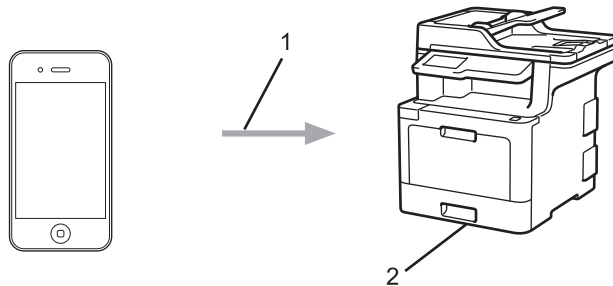

1. Print request
 2. Printed photos, emails, web pages, and documents
- AirPrint also lets you send faxes directly from your Macintosh computer without printing them.

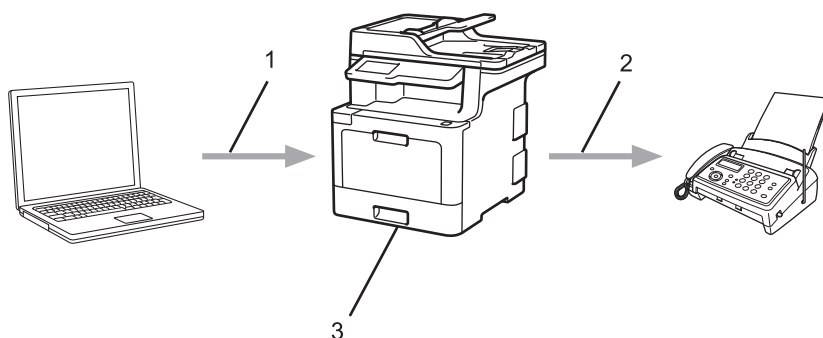

1. Wired or wireless network
 2. Telephone line
 3. Your Brother machine
- AirPrint also lets you scan documents to your Macintosh computer without installing a driver on the device.

✓ Related Information

- [AirPrint](#)
- [AirPrint Problems](#)

Before Using AirPrint

- [Network Settings for Using AirPrint](#)
- [Disable and Enable AirPrint Using Web Based Management \(Web Browser\)](#)

Network Settings for Using AirPrint

In order to use AirPrint, your mobile device must connect to the wireless network to which your Brother machine is connected. AirPrint supports wireless connections that use infrastructure mode or Wi-Fi Direct®.

To configure your mobile device for a wireless network, refer to your mobile device's user's guide. A link to your mobile device's user's guide on Apple's website can be found by tapping  in Safari.

To configure your Brother machine for a wireless network, see the *Quick Setup Guide* or related topics in this guide. If your Brother machine supports a wired network, you can use a network cable to connect to the wireless access point/router.

If your Brother machine supports Wi-Fi Direct® and you want to configure your Brother machine for a Wi-Fi Direct® network, see related topics in this Online Guide.



Related Information

- [Before Using AirPrint](#)

Disable and Enable AirPrint Using Web Based Management (Web Browser)

Confirm that your Brother machine is connected to the same network as your computer.

1. Start your web browser.
2. Type "http://machine's IP address" in your browser's address bar (where "machine's IP address" is the machine's IP address).

For example:

http://192.168.1.2

3. No password is required by default. Type a password if you have set one, and then click .
4. Click the **Network** tab.
5. Click the **Protocol** menu in the left navigation bar.
6. To disable AirPrint, clear the **AirPrint** check box. To enable AirPrint, select the **AirPrint** check box.



By default, AirPrint is enabled.

7. Click **Submit**.
8. Restart your machine to activate the configuration.



Related Information



- [Before Using AirPrint](#)

Print Using AirPrint

- [Print from iPad, iPhone, or iPod Touch](#)
- [Before Printing Using AirPrint \(macOS\)](#)
- [Print Using AirPrint \(macOS\)](#)

Print from iPad, iPhone, or iPod Touch

The procedure used to print may vary by application. Safari is used in the example below.

1. Make sure your Brother machine is turned on.
2. Use Safari to open the page that you want to print.
3. Tap  or .
4. Tap **Print**.
5. Make sure your Brother machine is selected.
6. If a different machine (or no printer) is selected, tap **Printer**.
A list of available machines appears.
7. Tap your machine's name in the list.
8. Select the desired options, such as the number of pages to print and 2-sided printing (if supported by your machine).
9. Tap **Print**.



Related Information

- [Print Using AirPrint](#)

Before Printing Using AirPrint (macOS)

Before printing using macOS, add your Brother machine to the printer list on your Macintosh computer.

1. Select **System Preferences** from the Apple Menu.
2. Click **Printers & Scanners**.
3. Click the + icon below the Printers pane on the left.
4. Click **Add Printer or Scanner....** The **Add** screen appears.
5. Select your Brother machine, and then select **AirPrint** from the **Use** pop-up menu.
6. Click **Add**.



Related Information

- [Print Using AirPrint](#)

Print Using AirPrint (macOS)

The procedure used to print may vary by application. Safari is used in the example below. Before printing, make sure your Brother machine is in the printer list on your Macintosh computer.

1. Make sure your Brother machine is turned on.
2. On your Macintosh computer, use Safari to open the page that you want to print.
3. Click the **File** menu, and then select **Print**.
4. Make sure your Brother machine is selected. If a different machine (or no printer) is selected, click the **Printer** pop-up menu, and then select your Brother machine.
5. Select the desired options, such as the number of pages to print and 2-sided printing (if supported by your machine).
6. Click **Print**.



Related Information

- [Print Using AirPrint](#)

Scan Using AirPrint

- [Before Scanning Using AirPrint \(macOS\)](#)
- [Scan Using AirPrint \(macOS\)](#)

Before Scanning Using AirPrint (macOS)

Before scanning using macOS, add your Brother machine to the scanner list on your Macintosh computer.

1. Select **System Preferences** from the Apple Menu.
2. Click **Printers & Scanners**.
3. Click the + icon below the Scanners pane on the left.
4. Click **Add Printer or Scanner....**
The **Add** screen appears.
5. Select your Brother machine, and then select **AirPrint** from the **Use** pop-up menu.
6. Click **Add**.



Related Information

- [Scan Using AirPrint](#)

Scan Using AirPrint (macOS)

Before scanning, make sure your Brother machine is in the scanner list on your Macintosh computer.

1. Load your document.
2. Select **System Preferences** from the Apple Menu.
3. Click **Printers & Scanners**.
4. Select your Brother machine from the scanner list.
5. Click the **Scan** tab, and then click the **Open Scanner...** button.
The Scanner screen appears.
6. If you place the document in the ADF, select **Use Document Feeder** check box, and then select the size of your document from the scan size setting pop-up menu.
7. Select the destination folder or destination application from the destination setting pop-up menu.
8. Click **Show Details** to change the scanning settings if needed.
You can crop the image manually by dragging the mouse pointer over the portion you want to scan when scanning from the scanner glass.
9. Click **Scan**.



Related Information

- [Scan Using AirPrint](#)

Send a Fax Using AirPrint (For MFC Models)

- [Before Sending a Fax Using AirPrint \(macOS\)](#)
- [Send a Fax Using AirPrint \(macOS\)](#)

Before Sending a Fax Using AirPrint (macOS)

Before sending a fax, add your Brother machine to the printer list on your Macintosh computer. Make sure your Brother machine is connected to the telephone line and works correctly.

1. Select **System Preferences** from the Apple Menu.
2. Click **Printers & Scanners**.
3. Click the + icon below the Printers pane on the left.
4. Click **Add Printer or Scanner....** The **Add** screen appears.
5. Select your Brother machine, and then select **AirPrint** from the **Use** pop-up menu.
6. Click **Add**.

Related Information

- [Send a Fax Using AirPrint \(For MFC Models\)](#)

Send a Fax Using AirPrint (macOS)

Make sure your Brother machine is in the printer list on your Macintosh computer. Apple TextEdit is used in the example below.



- AirPrint supports only black and white fax documents.

1. Make sure your Brother machine is turned on.
2. On your Macintosh computer, open the file that you want to send as a fax.
3. Click the **File** menu, and then select **Print**.
4. Click the **Printer** pop-up menu, and then select **Brother MFC-XXXX - Fax** (where XXXX is your model name).
5. Type the fax recipient information.
6. Click **Fax**.



Related Information

- [Send a Fax Using AirPrint \(For MFC Models\)](#)

Mobile Printing for Windows®

Mobile printing for Windows® is a function to print wirelessly from your Windows® mobile device. You can connect to the same network that your Brother machine is connected to and print without installing the printer driver on the device. Many Windows® apps support this function.

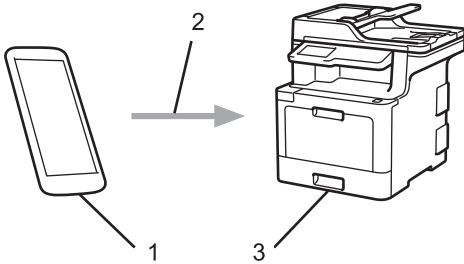

1. Windows® mobile device (Windows® 10 Mobile or later)
2. Wi-Fi® connection
3. Your Brother machine



Related Information

- [Mobile/Web Connect](#)

Mopria® Print Service

Mopria® Print Service is a print feature on Android™ mobile devices (Android™ version 4.4 or later) developed by the Mopria® Alliance. With this service, you can connect to the same network as your machine and print without additional setup. Many native Android™ apps support printing.

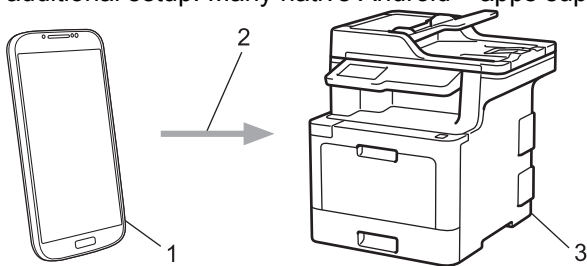

1. Android™ 4.4 or later
2. Wi-Fi® Connection
3. Your Brother machine

You must download the Mopria® Print Service from the Google Play™ Store and install it on your Android™ device. Before using this service, you must turn it on.



Related Information

- [Mobile/Web Connect](#)

Brother iPrint&Scan

Use Brother iPrint&Scan to print and scan from various mobile devices.

- For Android™ Devices

Brother iPrint&Scan allows you to use features of your Brother machine directly from your Android™ device, without using a computer.

Download and install Brother iPrint&Scan from the Google Play™ Store app.

- For Apple Devices

Brother iPrint&Scan allows you to use features of your Brother machine directly from your Apple device.

Download and install Brother iPrint&Scan from the App Store.

- For Windows® Devices

Brother iPrint&Scan allows you to use features of your Brother machine directly from your Windows® device, without using a computer.

Download and install Brother iPrint&Scan from the Microsoft® Store.

For more information, see the *Mobile Print/Scan Guide for Brother iPrint&Scan*. Go to your model's **Manuals** page on the Brother Solutions Center at support.brother.com.



Related Information

- [Mobile/Web Connect](#)

Near-Field Communication (NFC)

Related Models: MFC-L8900CDW

Near-Field Communication (NFC) allows for simple transactions, data exchange, and wireless connections between two devices that are in close range of each other.

If your Android™ device is NFC-enabled, you can print data (photos, PDF files, text files, web pages and email messages) from the device or scan photos and documents to the device by touching it to the NFC symbol on the machine's control panel.

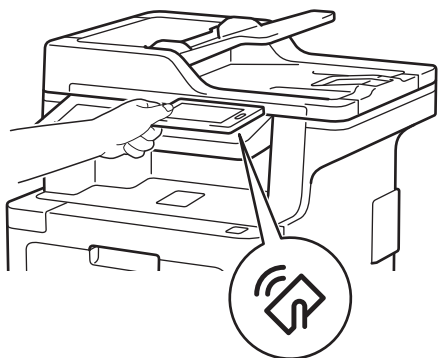

You must download and install Brother iPrint&Scan on your Android™ device to use this feature. For more information, see the *Mobile Print/Scan Guide for Brother iPrint&Scan*. Go to your model's **Manuals** page on the Brother Solutions Center at support.brother.com.

✓ Related Information

- [Mobile/Web Connect](#)
- [Register an External IC Card Reader](#)

Register an External IC Card Reader

When you connect an external IC card reader, use Web Based Management to register the card reader. Your machine supports HID class driver supported external IC card readers.

1. Start your web browser.
2. Type "http://machine's IP address" in your browser's address bar (where "machine's IP address" is the machine's IP address).

For example:

http://192.168.1.2

3. No password is required by default. Type a password if you have set one, and then click .
4. Click the **Administrator** tab.
5. Click the **External Card Reader** menu, and then enter the necessary information.
6. Click **Submit**.
7. Restart your Brother machine to activate the configuration.



Related Information

- [Near-Field Communication \(NFC\)](#)

ControlCenter

Use Brother's ControlCenter software utility to quickly access your frequently-used applications. Using ControlCenter gives you direct access to specific applications.

- [ControlCenter4 \(Windows®\)](#)
- [ControlCenter2 \(Macintosh\)](#)

ControlCenter4 (Windows®)

- [Change the Operation Mode in ControlCenter4 \(Windows®\)](#)
- [Scan Using ControlCenter4 Home Mode \(Windows®\)](#)
- [Scan Using ControlCenter4 Advanced Mode \(Windows®\)](#)
- [Set Up the Brother Machine Using ControlCenter4 \(Windows®\)](#)
- [Create a Custom Tab Using ControlCenter4 Advanced Mode \(Windows®\)](#)

Change the Operation Mode in ControlCenter4 (Windows®)

ControlCenter4 has two operation modes: **Home Mode** and **Advanced Mode**. You can change modes at any time.

Home Mode

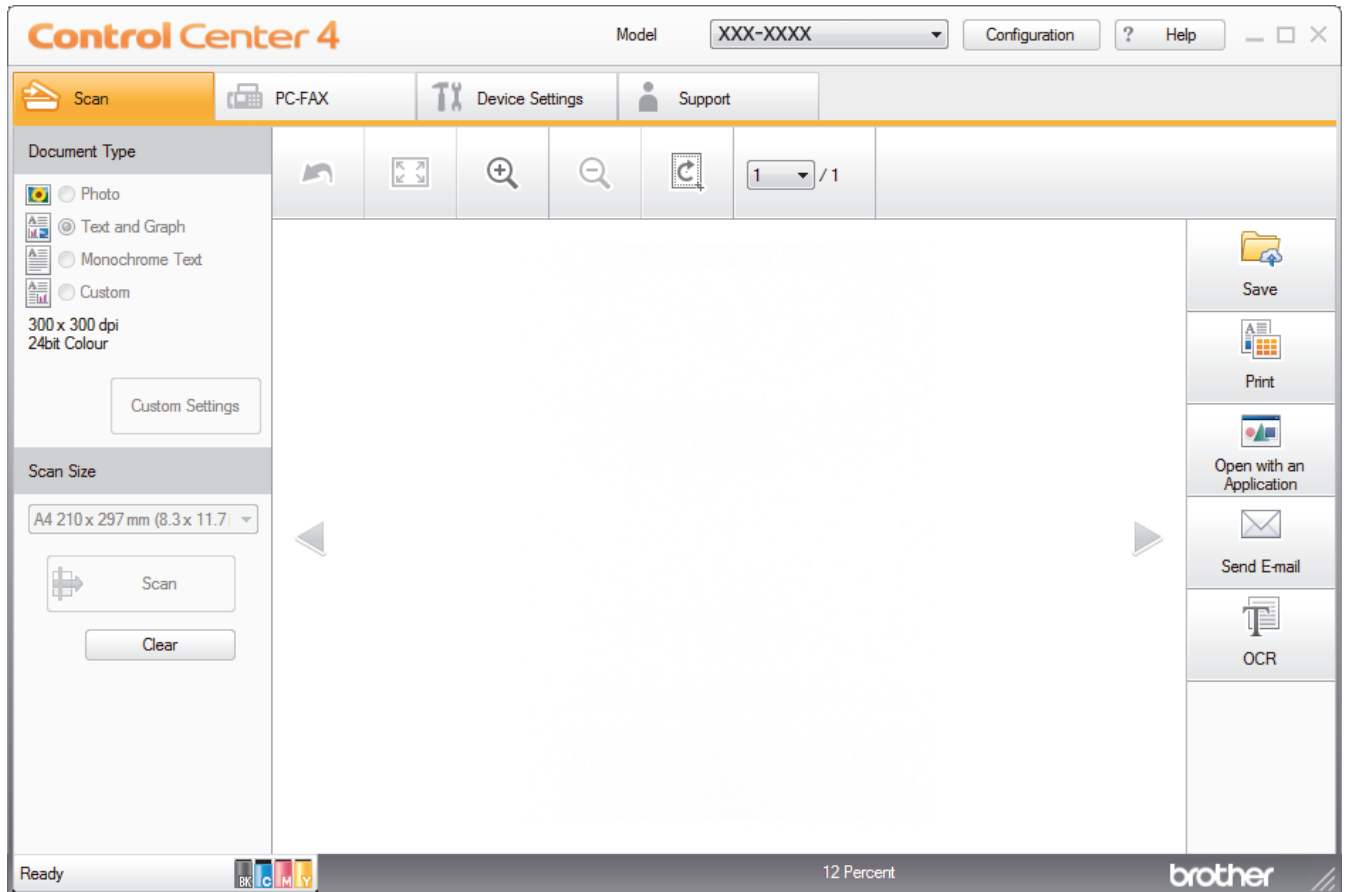

Advanced Mode



- **Home Mode**

ControlCenter4 Home Mode lets you access your machine's main features easily.

- **Advanced Mode**

ControlCenter4 Advanced Mode gives you more control over the details of your machine's features and allows you to customize one-button scan actions.

To change operation mode:

1. Click the  (**ControlCenter4**) icon in the task tray, and then select **Open**.
2. Click the **Configuration** button, and then select **Mode Select**.
3. The mode selection dialog box appears. Select either the **Home Mode** or **Advanced Mode** option.

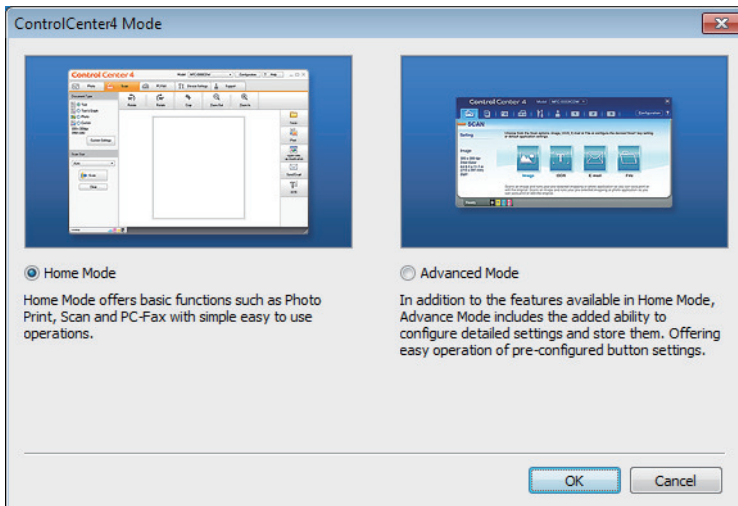

4. Click **OK**.



Related Information

- [ControlCenter4 \(Windows®\)](#)
-

Scan Using ControlCenter4 Home Mode (Windows®)

Use ControlCenter4 Home Mode to access your machine's main features.

- [Scan Using ControlCenter4 Home Mode \(Windows®\)](#)
- [Save Scanned Data to a Folder as a PDF File Using ControlCenter4 Home Mode \(Windows®\)](#)
- [Scan Both Sides of a Document Automatically Using ControlCenter4 Home Mode \(Windows®\)](#)
- [Scan Settings for ControlCenter4 Home Mode \(Windows®\)](#)

Scan Using ControlCenter4 Advanced Mode (Windows®)

ControlCenter4 Advanced Mode gives you more control over the details of your machine's features and allows you to customize one-button scan actions.

- [Scan Photos and Graphics Using ControlCenter4 Advanced Mode \(Windows®\)](#)
- [Save Scanned Data to a Folder as a PDF File Using ControlCenter4 Advanced Mode \(Windows®\)](#)
- [Scan Both Sides of a Document Automatically Using ControlCenter4 Advanced Mode \(Windows®\)](#)
- [Scan Both Sides of an ID Card Using ControlCenter4 Advanced Mode \(Windows®\)](#)
- [Scan to Email Attachment Using ControlCenter4 Advanced Mode \(Windows®\)](#)
- [Scan to an Editable Text File \(OCR\) Using ControlCenter4 Advanced Mode \(Windows®\)](#)
- [Scan Settings for ControlCenter4 Advanced Mode \(Windows®\)](#)

Set Up the Brother Machine Using ControlCenter4 (Windows®)



If Secure Function Lock is set to On, you cannot use Remote Setup.

1. Click the  (ControlCenter4) icon in the task tray, and then click **Open**.
2. Click the **Device Settings** tab.
3. Click the **Remote Setup** button.
4. Configure the settings as needed.

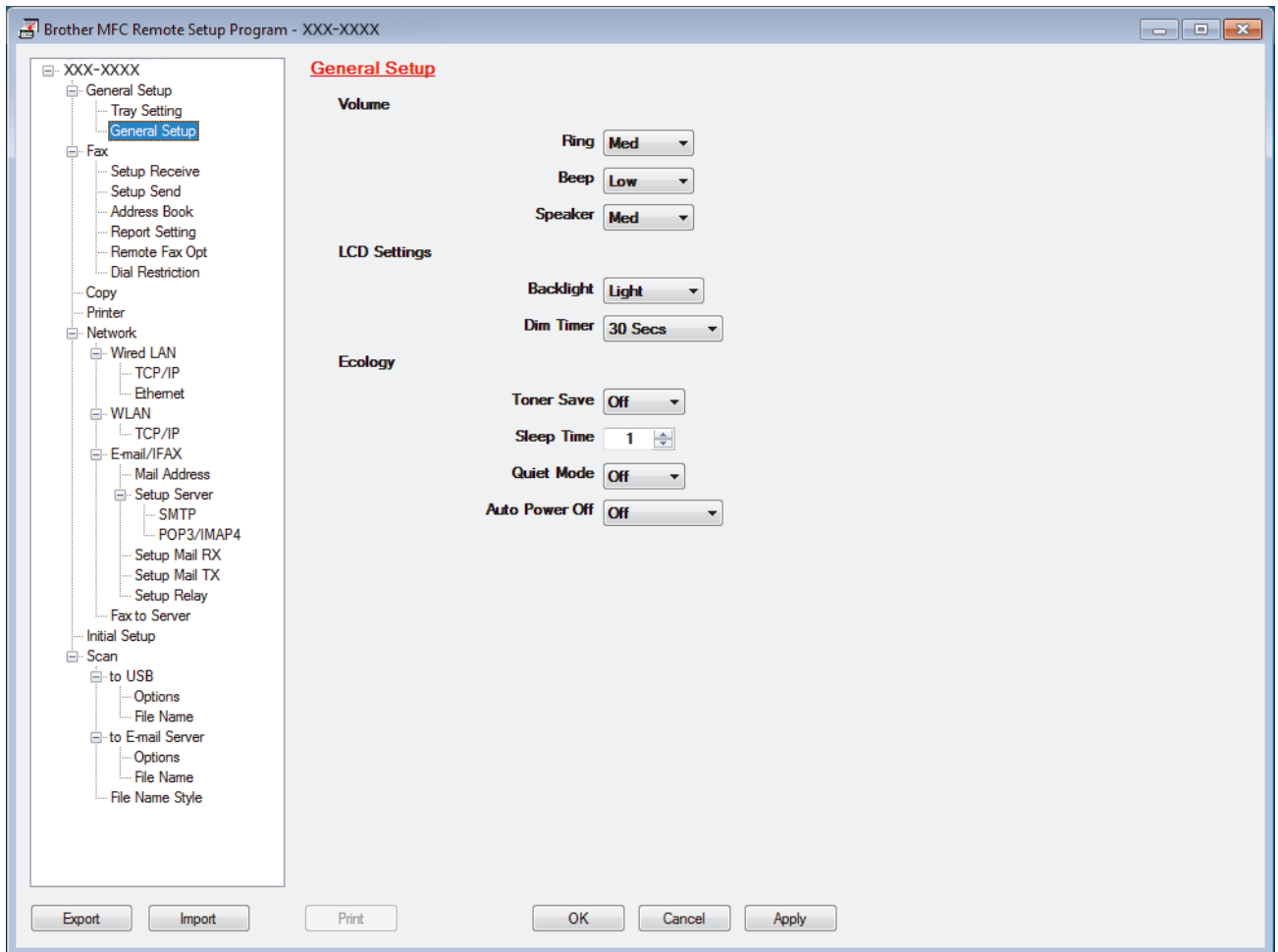

Export

Click to save the current configuration settings to a file.



Click **Export** to save your address book or all settings for your machine.

Import

Click to import a file and read its settings.

Print

Click to print the selected items on the machine. You cannot print the data until it is uploaded to the machine. Click **Apply** to upload the new data to the machine, and then click **Print**.

OK

Click to start uploading data to the machine, and then exit the Remote Setup Program. If an error message appears, confirm that your data is correct, and then click **OK**.

Cancel

Click to exit the Remote Setup Program without uploading data to the machine.

Apply

Click to upload data to the machine without exiting the Remote Setup Program.

5. Click **OK**.

- If your computer is protected by a firewall and is unable to use Remote Setup, you may need to configure the firewall settings to allow communication through port numbers 137 and 161.
- If you are using Windows® Firewall and you installed the Brother software and drivers from the installation disc, the necessary firewall settings have already been set.

**Related Information**

- [ControlCenter4 \(Windows®\)](#)
- [Remote Setup \(Windows®\)](#)

Create a Custom Tab Using ControlCenter4 Advanced Mode (Windows®)

You can create up to three customized tabs, each including up to five customized buttons, with your preferred settings.

Select **Advanced Mode** as the mode setting for ControlCenter4.

1. Click the  (**ControlCenter4**) icon in the task tray, and then click **Open**.
2. Click the **Configuration** button, and then select **Create custom tab**.
A custom tab is created.
3. To change the name of a custom tab, right-click the custom tab, and then select **Rename custom tab**.
4. Click the **Configuration** button, select **Create custom button**, and then select the button you want to create.
The settings dialog box appears.
5. Type the button name, and then change the settings, if needed. Click **OK**.

The setting options vary depending on the button you select.

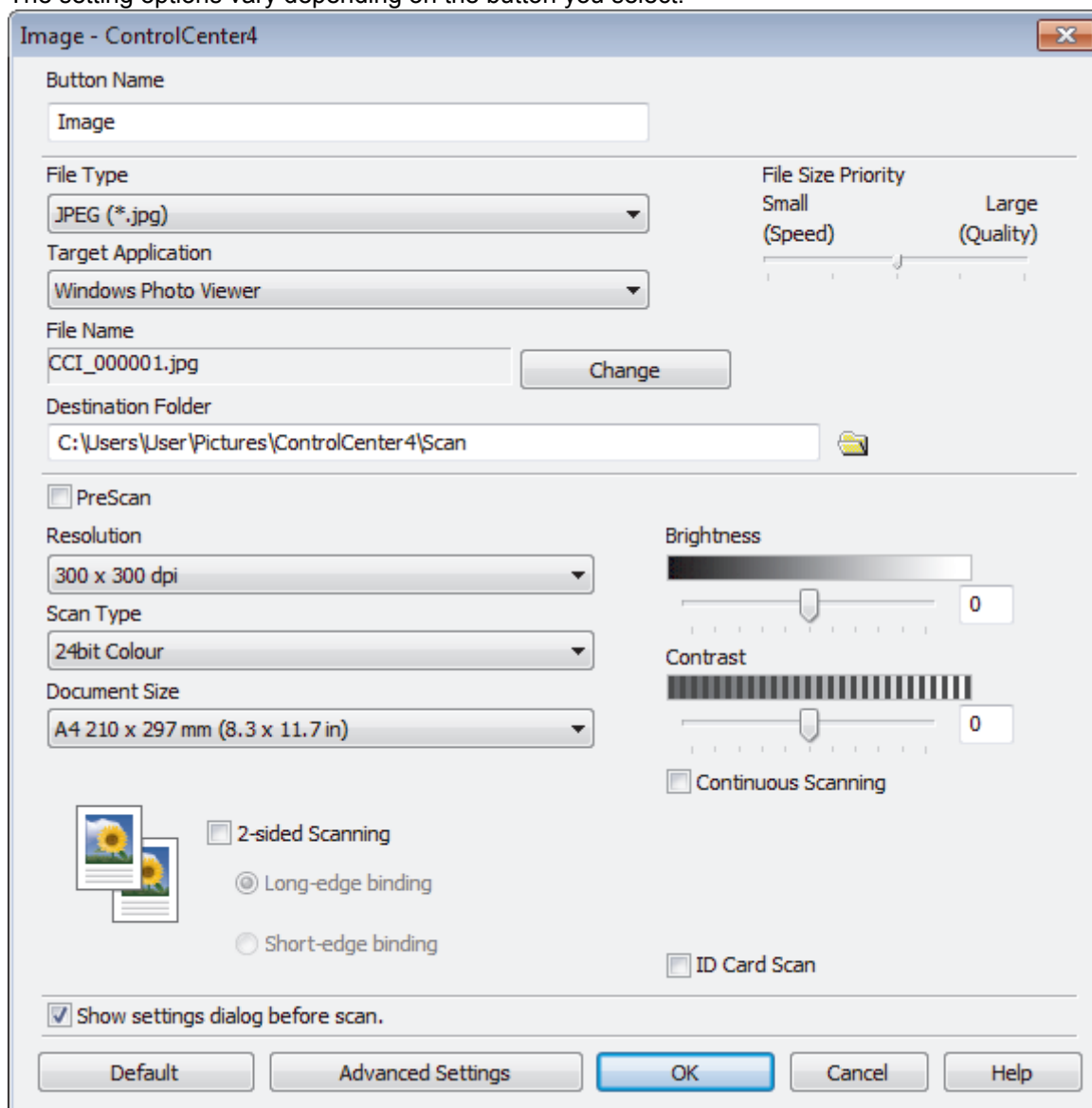



You can change or remove the created tab, button, or settings. Click the **Configuration** button, and then follow the menu.



Related Information

- [ControlCenter4 \(Windows®\)](#)
-

ControlCenter2 (Macintosh)

- [Scan Using ControlCenter2 \(Macintosh\)](#)
- [Set Up the Brother Machine Using ControlCenter2 \(Macintosh\)](#)

Scan Using ControlCenter2 (Macintosh)

Use Brother's ControlCenter software to scan photos and save them as JPEGs, PDFs, or other file formats.

- [Scan Using ControlCenter2 \(Macintosh\)](#)
- [Save Scanned Data to a Folder as a PDF File Using ControlCenter2 \(Macintosh\)](#)
- [Scan Both Sides of a Document Automatically Using ControlCenter2 \(Macintosh\)](#)
- [Scan Both Sides of an ID Card Using ControlCenter2 \(Macintosh\)](#)
- [Scan to Email Attachment Using ControlCenter2 \(Macintosh\)](#)
- [Scan to an Editable Text File \(OCR\) Using ControlCenter2 \(Macintosh\)](#)
- [Scan Settings for ControlCenter2 \(Macintosh\)](#)

Set Up the Brother Machine Using ControlCenter2 (Macintosh)

 If Secure Function Lock is set to On, you cannot use Remote Setup.

1. In the **Finder** menu bar, click **Go > Applications > Brother**, and then double-click the  (**ControlCenter**) icon.

The **ControlCenter2** screen appears.

2. Click the **DEVICE SETTINGS** tab.
3. Click the **Remote Setup** button.

The Remote Setup Program screen appears.

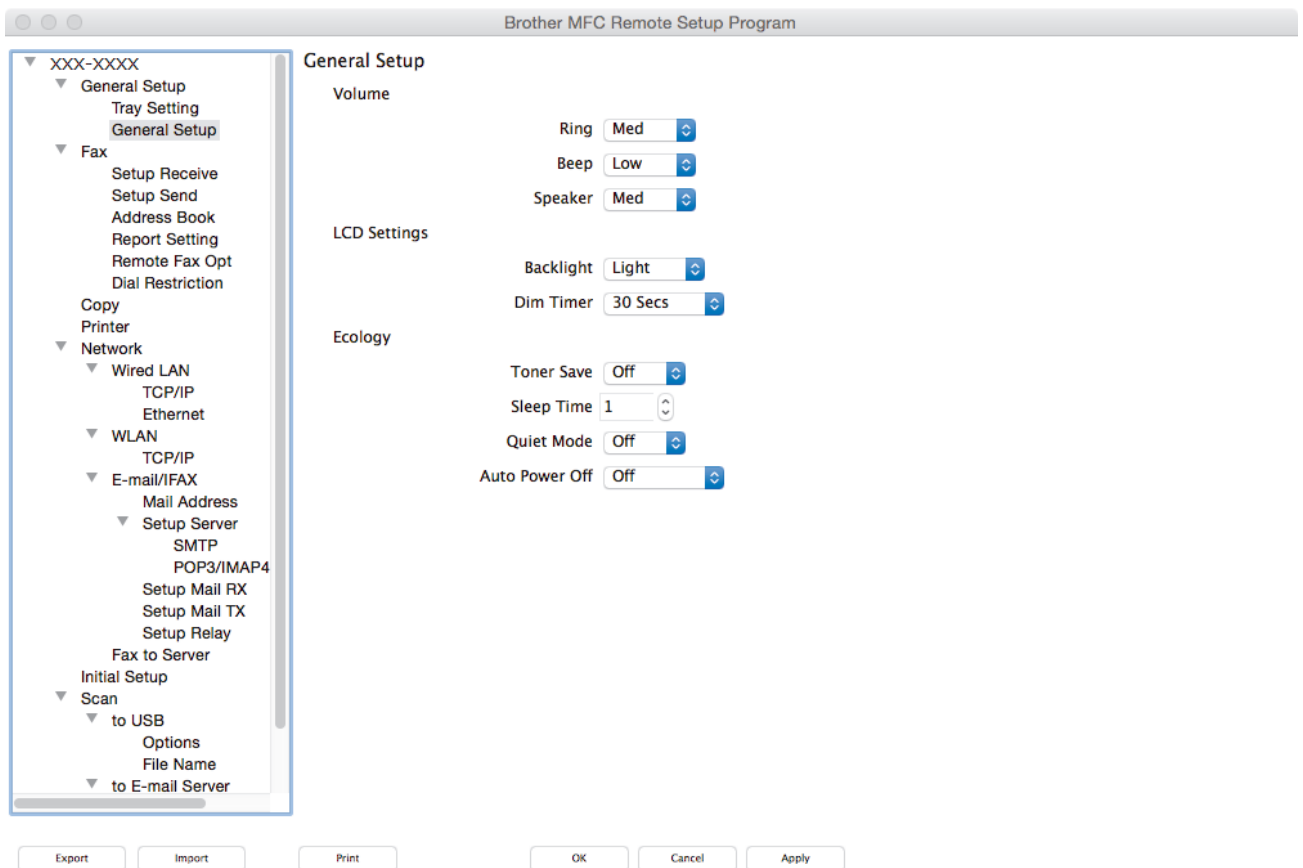

4. Configure the settings as needed.

Export

Click to save the current configuration settings to a file.

 Click **Export** to save your address book or all settings for your machine.

Import

Click to import a file and read its settings.

Print

Click to print the selected items on the machine. You cannot print the data until it is uploaded to the machine. Click **Apply** to upload the new data to the machine, and then click **Print**.

OK

Click to start uploading data to the machine, and then exit the Remote Setup Program. If an error message appears, enter the correct data again, and then click **OK**.

Cancel

Click to exit the Remote Setup Program without uploading data to the machine.

Apply

Click to upload data to the machine without exiting the Remote Setup Program.

5. When finished, click **OK**.

**Related Information**

- [ControlCenter2 \(Macintosh\)](#)
- [Remote Setup \(Macintosh\)](#)

Troubleshooting

Use this section to resolve typical problems you may encounter when using your Brother machine. You can correct most problems yourself.

IMPORTANT

For technical help, you must call the country where you bought the machine. Calls must be made from within that country.

Using non-Brother supplies may affect the print quality, hardware performance, and machine reliability.



If you need additional help, go to the Brother Solutions Center at support.brother.com.

First, check the following:

- The machine's power cord is connected correctly and the machine's power is on. See the *Quick Setup Guide*.
- All of the protective materials have been removed. See the *Quick Setup Guide*.
- Paper is loaded correctly in the paper tray.
- The interface cables are securely connected to the machine and the computer, or the wireless connection is set up on both the machine and your computer.
- Error and maintenance messages

If you did not solve the problem with the checks, identify the problem and then see *Related Information*.



Related Information

- [Error and Maintenance Messages](#)
- [Error Messages When Using the Brother Web Connect Feature](#)
- [Document Jams](#)
- [Paper Jams](#)
- [Printing Problems](#)
- [Improve the Print Quality](#)
- [Telephone and Fax Problems](#)
- [Network Problems](#)
- [Google Cloud Print Problems](#)
- [AirPrint Problems](#)
- [Other Problems](#)
- [Check the Machine Information](#)
- [Reset Your Brother Machine](#)

Error and Maintenance Messages



(MFC-L8900CDW)

If the LCD displays errors and your Android™ device supports the NFC feature, touch your device to the NFC symbol on your Brother machine to access the Brother Solutions Center and browse the latest FAQs from your device. (Your mobile telephone provider's message and data rates may apply.)



Make sure the NFC settings of both your Brother machine and your Android™ device are set to On.

As with any sophisticated office product, errors may occur and supply items may have to be replaced. If this happens, your machine identifies the error or required routine maintenance and shows the appropriate message. The most common error and maintenance messages are shown in the table.





Follow the instructions in the **Action** column to solve the error and remove the message.

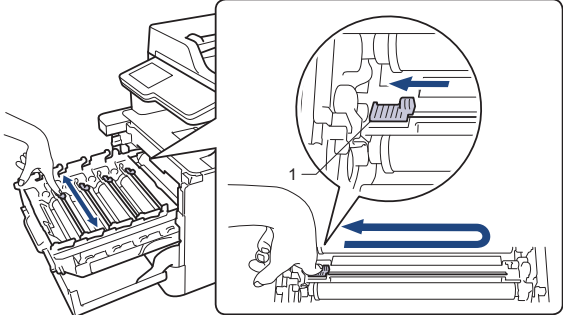



You can correct most errors and perform routine maintenance by yourself. If you need more tips: Visit support.brother.com, and click the **FAQs & Troubleshooting** page.



Error Message	Cause	Action
2-sided Disabled	The back cover of the machine is not closed completely.	Close the back cover of the machine until it locks in the closed position.
2-sided Disabled Reload paper, then press [Retry].	Although the size of paper in the paper tray matches the paper size that was selected from the control panel or printer driver, the machine has stopped printing when it encountered an additional, different size of paper in the tray.	Make sure the paper tray contains only the size of paper you select in either the control panel or printer driver, then press <i>Start</i> .
	The paper tray was pulled out before the machine completed printing on both sides of the paper.	Reinstall the paper tray and press <i>Start</i> .
Access Denied	The function you want to use is restricted by Secure Function Lock 3.0.	Call your administrator to check your Secure Function Lock Settings.
Calibration	Calibration failed.	<ul style="list-style-type: none"> Press and hold down  to turn off the machine. Wait a few seconds, and then turn it on again. Perform the color calibration again using the LCD. Install a new belt unit. If the problem continues, contact Brother Customer Service or your local Brother dealer.
Cartridge Error	The toner cartridge is not installed correctly.	<p>Pull out the drum unit, remove the toner cartridge for the color that is indicated on the LCD, and place it back in the drum unit. Install the drum unit in the machine again.</p> <p>If the problem continues, contact Brother Customer Service or your local Brother dealer.</p>
Comm.Error	Poor telephone line quality caused a communication error.	Send the fax again or connect the machine to another telephone line. If the problem continues, contact the telephone company and ask them to check your telephone line.
Condensation	Condensation may have formed inside the machine after a room temperature change.	Leave the machine turned on. Wait for 30 minutes with the front cover in the open position. Then turn off the machine and close the cover. Turn it on again.

Error Message	Cause	Action
Cooling Down	The temperature of the inside of the machine is too hot. The machine pauses its current print job and goes into cooling down mode.	Wait until the machine has finished cooling down. Make sure all vents on the machine are clear of obstructions. When the machine has cooled down, the machine will resume printing.
Cover is Open	The front cover is not completely closed.	Open and then firmly close the front cover of the machine.
Cover is Open.	The fuser cover is not completely closed or paper was jammed in the back of the machine when you turned on the power.	Close the fuser cover located inside the back cover of the machine. Make sure paper is not jammed inside the back of the machine, and then close the fuser cover.
Cover is Open.	The ADF cover is not completely closed.	Close the ADF cover. If the error message remains, press  .
Disconnected	The other person or other person's fax machine stopped the call.	Try to send or receive again. If calls are stopped repeatedly and you are using a VoIP (Voice over IP) system, try changing the Compatibility to Basic (for VoIP).
Document Jam	The document was not inserted or fed correctly, or the document scanned from the ADF was too long.	Remove the jammed paper from the ADF unit. Clear any debris or scraps of paper from the ADF unit paper path. Press  .
DR Mode in Use	The machine is set to Distinctive Ring mode. You cannot change the Receive Mode from Manual to another mode.	Set Distinctive Ring to Off.
Supplies Drum End Soon	The drum unit is near the end of its life.	Order a new drum unit before the LCD displays Replace Drum.
Drum !	The corona wires on the drum unit must be cleaned.	Clean the corona wires on the drum unit.  See Related Information: Clean the Corona Wires. If the problem continues, replace the drum unit with a new one.
	The drum unit or the toner cartridge and drum unit assembly is not installed correctly.	Remove the drum unit, remove the toner cartridges from the drum unit, and put the toner cartridges back into the drum unit. Reinstall the drum unit in the machine.
Drum Stop	It is time to replace the drum unit.	Replace the drum unit.
Jam 2-sided	The paper is jammed underneath the paper tray or the fuser unit.	Remove the paper tray or open the back cover to pull out all jammed paper.

Error Message	Cause	Action
Jam Inside	The paper is jammed inside the machine.	Open the front cover, remove the toner cartridge and drum unit assembly, and pull out all jammed paper. Close the front cover.
Jam MP Tray	The paper is jammed in the MP tray.	Remove all jammed paper from in and around the MP tray. Press <i>Retry</i> .
Jam Rear	The paper is jammed in the back of the machine.	Open the fuser cover and remove all jammed paper. Close the fuser cover. If the error message remains, press <i>Retry</i> .
Jam Tray 1 Jam Tray 2 Jam Tray 3 Jam Tray 4	The paper is jammed in the indicated paper tray.	Pull out the paper tray and remove all jammed paper as shown in the animation on the LCD.
Limit Exceeded	The print limit set in Secure Function Lock 3.0 was reached.	Call your administrator to check your Secure Function Lock Settings.
Media Type Mismatch	The media type specified in the printer driver differs from the paper type specified in the machine's menu.	Load the correct type of paper in the tray indicated on the LCD, and then select the correct media type in the Paper Type setting on the machine.
No Belt Unit	The belt unit is not installed or not installed correctly.	Reinstall the belt unit.
No HUB Support	A USB hub device is connected to the USB direct interface.	Disconnect the USB hub device from the USB direct interface.
No Drum Unit	The drum unit is not installed correctly.	Reinstall the toner cartridge and drum unit assembly.
No Paper	The machine is out of paper, or paper is not loaded correctly in the paper tray.	<ul style="list-style-type: none"> • Refill paper in the paper tray. Make sure the paper guides are set to the correct size. • If paper is in the tray, remove it and load it again. Make sure the paper guides are set to the correct size. • Do not overfill the paper tray.
No Paper Fed T1 No Paper Fed T2 No Paper Fed T3 No Paper Fed T4	The machine failed to feed paper from the indicated paper tray.	Pull out the paper tray indicated on the LCD and remove all jammed paper.
No Paper MP	The MP tray is out of paper, or paper is not loaded correctly in the MP tray.	<p>Do one of the following:</p> <ul style="list-style-type: none"> • Refill paper in the MP tray. Make sure the paper guides are set to the correct size. • If paper is in the tray, remove it and load it again. Make sure the paper guides are set to the correct size.
No Paper T1 No Paper T2 No Paper T3 No Paper T4	The machine failed to feed paper from the indicated paper tray.	<p>Do one of the following:</p> <ul style="list-style-type: none"> • Refill paper in the paper tray indicated on the LCD. Make sure the paper guides are set to the correct size. • If paper is in the tray, remove it and load it again. Make sure the paper guides are set to the correct size. <p>Do not overfill the paper tray.</p>
No Toner	The toner cartridge for the color indicated on the LCD is not installed or not installed correctly.	Remove the toner cartridge for the color indicated on the LCD from the drum unit, and put the toner cartridge back into the drum unit. If the problem continues, replace the toner cartridge.

Error Message	Cause	Action
No Tray T1 No Tray T2 No Tray T3 No Tray T4	The paper tray is not installed or not installed correctly.	Reinstall the paper tray indicated on the LCD.
No Waste Toner	The waste toner box is not installed or not installed correctly.	Reinstall the waste toner box.
Out of Fax Memory	The machine's fax memory is full.	If you are using Fax Preview function, delete unwanted received fax data. If you are using Memory Receive function and are not using fax preview function, print received fax data. <i>See Related Information: Print a Fax Stored in the Machine's Memory.</i>
Out of Memory	The machine's memory is full.	If a fax-sending or copy operation is in process Do one of the following: <ul style="list-style-type: none"> • Press Send Now to send the pages scanned so far. • Press Partial Print to copy the pages scanned so far. • Press Quit or  and wait until the other operations that are in progress finish, and then try again. If a scan operation is in process <ul style="list-style-type: none"> • Split the document into multiple parts. • Reduce the Resolution. • Reduce the File Size. • Select the high compression PDF file type. • Clear faxes from the memory. If a print operation is in process Press  and reduce the print resolution.
Paper Low Paper Low T1 Paper Low T2 Paper Low T3 Paper Low T4	The paper tray is nearly empty.	Refill the paper in the paper tray indicated on the LCD.
Print Data Full	The machine's memory is full.	Press  and delete the previously stored secure print data.
Print Unable ##	The machine has a mechanical problem.	<ul style="list-style-type: none"> • Press and hold  to turn off the machine, wait a few minutes, and then turn it on again. • If the problem continues, contact Brother Customer Service. Contact Brother Customer Service at: 1-877-BROTHER (1-877-276-8437) (in USA) www.brother.ca/support (in Canada) or to locate a Brother Authorized Service Center, visit: www.brother-usa.com/service

Error Message	Cause	Action
Registration	Registration failed.	<ul style="list-style-type: none"> Press and hold down  to turn off the machine. Wait a few seconds, and then turn it on again. Perform the color registration again using the LCD. Install a new belt unit. If the problem continues, contact Brother Customer Service or your local Brother dealer.
Supplies Replace Drum	It is time to replace the drum unit.	Replace the drum unit with a new one.
	The drum unit counter was not reset when a new drum was installed.	Reset the drum unit counter. See the instructions included with the new drum unit.
Replace Toner	The toner cartridge is at the end of its life. The machine stops all print operations. While memory is available, faxes are stored in the memory.	Replace the toner cartridge for the color indicated on the LCD.
Replace WT Box	It is time to replace the waste toner box.	Replace the waste toner box with a new one.
Scan Unable	The document is too long for 2-sided scanning.	Press  . For 2-sided scanning, use Letter, Legal, or Folio size paper. Other paper must be within the following size: Length: 5.8 to 14.0 in. (147.3 to 355.6 mm) Width: 4.1 to 8.5 in. (105 to 215.9 mm)
Scan Unable ##	The machine has a mechanical problem.	<ul style="list-style-type: none"> Press and hold  to turn off the machine, and then turn it on again. If the problem continues, contact Brother Customer Service. Contact Brother Customer Service at: 1-877-BROTHER (1-877-276-8437) (in USA) www.brother.ca/support (in Canada) or to locate a Brother Authorized Service Center, visit: www.brother-usa.com/service
Self-Diagnostic	The temperature of the fuser unit does not rise to a specified temperature within the specified time.	Press and hold  to turn off the machine, wait a few seconds, and then turn it on again. Leave the machine idle for 15 minutes with the power on.
	The fuser unit is too hot.	
Service Error ##	Machine's firmware has a problem.	<ul style="list-style-type: none"> Contact Brother Customer Service. Contact Brother Customer Service at: 1-877-BROTHER (1-877-276-8437) (in USA) www.brother.ca/support (in Canada) or to locate a Brother Authorized Service Center, visit: www.brother-usa.com/service
Short paper	The length of the paper in the tray is too short for the machine to deliver it to the Face down output tray.	Open the back cover (Face up output tray) to let the printed page exit onto the Face up output tray. Remove the printed pages, and then press Retry.

Error Message	Cause	Action
Size Error	The paper size defined in the printer driver is not supported by the defined tray.	Choose a paper size supported by the defined tray.
Size Error 2-sided	The paper size specified in the machine's paper size setting is not available for automatic 2-sided printing.	Press  (if required). Load the correct size of paper in the tray and set the tray for that paper size.
	The paper in the tray is not the correct size and is not available for automatic 2-sided printing.	Choose a paper size supported by 2-sided printing. Paper sizes available for automatic 2-sided printing are Letter, Legal, Mexico Legal and Folio.
Size Mismatch	The paper in the tray is not the correct size.	Load the correct size of paper in the tray indicated on the LCD and set the size of paper for the tray.
Supplies Belt End Soon	The belt unit is near the end of its life.	Order a new belt unit before the LCD displays <i>Replace Belt</i> .
Supplies Replace Belt	It is time to replace the belt unit.	Replace the belt unit with a new one.
Supplies Toner Low: X (X indicates the toner cartridge or drum unit color that is near the end of its life. BK=Black, C=Cyan, M=Magenta, Y=Yellow.)	If the LCD displays this message, you can still print. The toner cartridge is near the end of its life.	Order a new toner cartridge before the LCD displays <i>Replace Toner</i> .
Supplies WT Box End Soon	The waste toner box is almost full.	Order a new waste toner box before the LCD displays <i>Replace WT Box</i> .
Toner Error	One or more toner cartridges are not installed or not installed correctly.	Pull out the drum unit. Remove all the toner cartridges, and then put them back into the drum unit.
Too Many Trays	The number of installed Optional Trays exceeds the maximum number.	Reduce the number of Optional Trays.
Touchscreen Initialization Failed	The Touchscreen was pressed before the power on initialization was completed.	Make sure nothing is touching the Touchscreen.
	Debris may be stuck between the lower part of the Touchscreen and its frame.	Insert a piece of stiff paper between the lower part of the Touchscreen and its frame and slide it back and forth to push out any debris.
Tray 2 Error Tray 3 Error Tray 4 Error	The optional lower tray is not installed correctly.	Reinstall the lower tray.
Unusable Device	A USB device or USB Flash memory drive that is encrypted or not supported has been connected to the USB direct interface.	Unplug the device from the USB direct interface.
Unusable Device Remove the Device. Turn the power off and back on again.	A defective USB device or a high power consumption USB device has been connected to the USB direct interface.	<ul style="list-style-type: none"> Unplug the device from the USB direct interface. Press and hold  to turn off the machine, and then turn it on again.

Error Message	Cause	Action
Wrong Paper Size MP Wrong Paper Size T1 Wrong Paper Size T2 Wrong Paper Size T3 Wrong Paper Size T4	The specified tray ran out of paper during copying and the machine could not feed the same size paper from the next priority tray.	Refill the paper in the paper tray.



Related Information

- [Troubleshooting](#)
 - [Transfer Your Faxes or Fax Journal Report](#)
 - [Replace Supplies](#)
 - [Load and Print Using the Paper Tray](#)
 - [Load and Print Using the Multi-purpose Tray \(MP Tray\)](#)
 - [Replace the Drum Unit](#)
 - [Clean the Corona Wires](#)
 - [Print a Fax Stored in the Machine's Memory](#)
-

Transfer Your Faxes or Fax Journal Report

If the LCD displays:

- [Print Unable] ##
- [Scan Unable] ##

We recommend transferring your faxes to another fax machine or to your computer.

You can also transfer the Fax Journal report to see if there are any faxes you must transfer.



If there is an error message on the LCD after you transfer the faxes, disconnect your Brother machine from the power source for several minutes, and then reconnect it.



Related Information

- [Error and Maintenance Messages](#)
- [Transfer Faxes to Another Fax Machine](#)
- [Transfer Faxes to Your Computer](#)
- [Transfer the Fax Journal Report to Another Fax Machine](#)

Transfer Faxes to Another Fax Machine

If you have not set up your Station ID, you cannot enter Fax Transfer mode.

1. Press  [Settings] > [All Settings] > [Service] > [Data Transfer] > [Fax Transfer].



If your machine displays the [All Settings] menu on the Home screen, skip the [Settings] menu.

2. Do one of the following:
 - If the LCD displays [No Data], there are no faxes left in the machine's memory. Press [Close].
 - Enter the fax number to which faxes will be forwarded.
3. Press [Fax Start].



Related Information

- [Transfer Your Faxes or Fax Journal Report](#)
- [Set Your Station ID](#)

Transfer Faxes to Your Computer

1. Make sure you have installed the software and drivers on your computer, and then turn on **PC-FAX Receive** on the computer.

Do one of the following:

- (Windows® 7)

From the  (**Start**) menu, select **All Programs > Brother > Brother Utilities**.

Click the drop-down list and select your model name (if not already selected). Click **PC-FAX** in the left navigation bar, and then click **Receive**.

- (Windows® 8 and Windows® 10)

Click  (**Brother Utilities**), and then click the drop-down list and select your model name (if not already selected). Click **PC-FAX** in the left navigation bar, and then click **Receive**.

2. Make sure you have set [PC Fax Receive] on the machine.

If faxes are in the machine's memory when you set up PC-Fax Receive, the LCD displays [Send Fax to PC?].

3. Do one of the following:

- To transfer all faxes to your computer, press [Yes].
- To exit and leave the faxes in the memory, press [No].

4. Press .



Related Information

- [Transfer Your Faxes or Fax Journal Report](#)

Transfer the Fax Journal Report to Another Fax Machine

If you have not set up your Station ID, you cannot enter fax transfer mode.

1. Press  [Settings] > [All Settings] > [Service] > [Data Transfer] > [Report Transfer].



If your machine displays the [All Settings] menu on the Home screen, skip the [Settings] menu.

2. Enter the fax number to which the Fax Journal will be forwarded.
3. Press [Fax Start].



Related Information

- [Transfer Your Faxes or Fax Journal Report](#)
- [Set Your Station ID](#)

Error Messages When Using the Brother Web Connect Feature

Your Brother machine displays an error message if an error occurs. The most common error messages are shown in the table.

You can correct most errors yourself. If, after reading this table, you still need help, the Brother Solutions Center offers the latest troubleshooting tips.

Go to the Brother Solutions Center at support.brother.com.

Connection Error

Error Messages	Cause	Action
Connection Error 02 Network connection failed. Verify that the network connection is good.	The machine is not connected to a network.	<ul style="list-style-type: none"> Verify that the network connection is good. If the Web button was pressed soon after the machine was turned on, the network connection may not have been established yet. Wait and try again.
Connection Error 03 Connection failed to server. Check network settings.	<ul style="list-style-type: none"> Network or server settings are incorrect. There is a problem with the network or server. 	<ul style="list-style-type: none"> Confirm that network settings are correct, or wait and try again later. If the Web button was pressed soon after the machine was turned on, the network connection may not have been established yet. Wait and try again.
Connection Error 07 Connection failed to server. Wrong Date&Time.	Date and time settings are incorrect.	Set the date and time correctly. Note that if the machine's power cord is disconnected, the date and time settings may have reset to factory settings.

Authentication Error

Error Messages	Cause	Action
Authentication Error 01 Incorrect PIN code. Enter PIN correctly.	The PIN you entered to access the account is incorrect. The PIN is the four-digit number that was entered when registering the account to the machine.	Enter the correct PIN.
Authentication Error 02 Incorrect or expired ID, or this temporary ID is already used. Enter correctly or reissue temporary ID. Temporary ID is valid for 24 hours after it is issued.	The temporary ID that was entered is incorrect .	Enter the correct temporary ID.
	The temporary ID that was entered has expired. A temporary ID is valid for 24 hours.	Apply for Brother Web Connect access again and receive a new temporary ID, and then use the new ID to register the account to the machine.
Authentication Error 03 Display name has already been registered. Enter another display name.	The name you entered as the display name has already been registered to another service user.	Enter a different display name.

Server Error

Error Messages	Cause	Action
Server Error 01 Authentication failed. Do the following: 1. Go to http://bwc.brother.com to get a new temporary ID. 2. Press OK and enter your new temporary ID in the next screen.	The machine's authentication information (needed to access the service) has expired or is invalid.	Apply for Brother Web Connect access again to receive a new temporary ID, and then use the new ID to register the account to the machine.
Server Error 03 Failed to upload. Unsupported file or corrupt data. Confirm data of file.	The file you are trying to upload may have one of the following problems: <ul style="list-style-type: none">• The file exceeds the service's limit on number of pixels, file size, etc.• The file type is not supported.• The file is corrupted.	The file cannot be used: <ul style="list-style-type: none">• Check the service's size or format restrictions.• Save the file as a different type.• If possible, get a new, uncorrupted version of the file.
Server Error 13 Service temporarily unavailable. Try again later.	There is a problem with the service and it cannot be used now.	Wait and try again. If you get the message again, access the service from a computer to confirm if it is unavailable.

Shortcut Error

Error Messages	Cause	Action
ShortCut Error 02 Account is invalid. Please register account and shortcut again after deleting this shortcut.	The shortcut cannot be used because the account was deleted after the shortcut was registered.	Delete the shortcut, and then register the account and shortcut again.



Related Information

- [Troubleshooting](#)
-

Document Jams

- [Document is Jammed in the Top of the ADF Unit](#)
- [Document is Jammed under the Document Cover](#)
- [Remove Small Scraps of Paper Jammed in the ADF](#)

Document is Jammed in the Top of the ADF Unit

1. Remove any paper from the ADF that is not jammed.
2. Open the ADF cover.
3. Pull the jammed document out to the left. If the document rips or tears, be sure you remove any debris or scraps to prevent future jams.

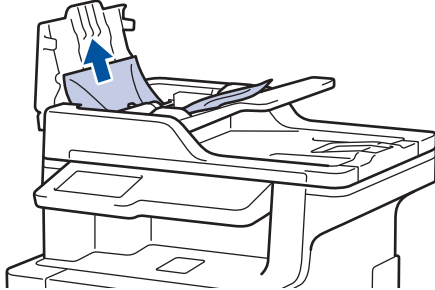

4. Close the ADF cover.
5. Press .

Related Information

- [Document Jams](#)

Document is Jammed under the Document Cover

1. Remove any paper from the ADF that is not jammed.
2. Lift the document cover.
3. Pull the jammed document out to the right. If the document rips or tears, be sure you remove any debris or scraps to prevent future jams.

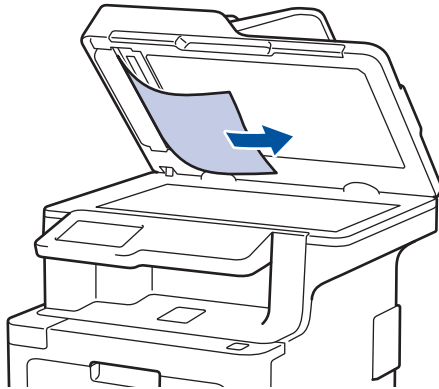

4. Close the document cover.
5. Press .

Related Information

- [Document Jams](#)

Remove Small Scraps of Paper Jammed in the ADF

1. Lift the document cover.
2. Insert a piece of stiff paper, such as cardstock, into the ADF to push any small paper scraps through.

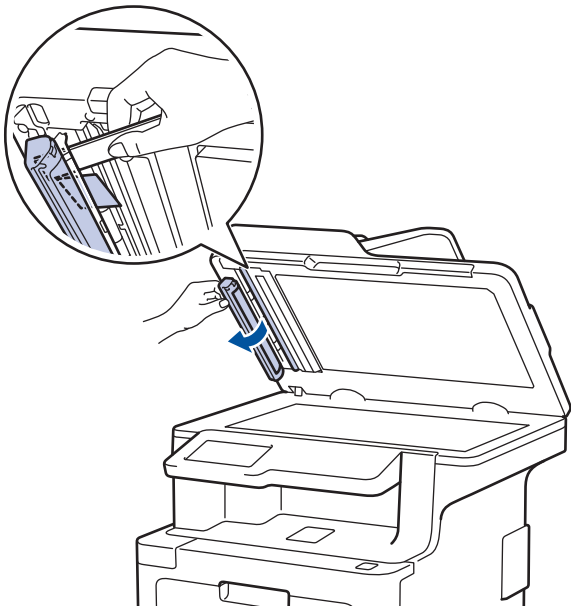
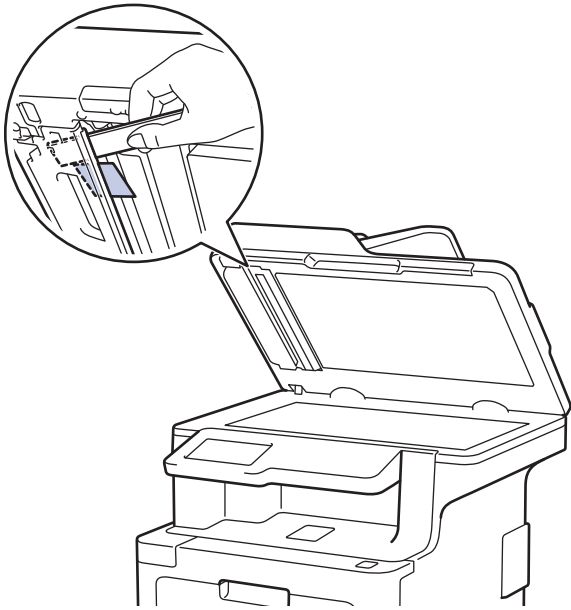

3. Close the document cover.
4. Press .

Related Information

- [Document Jams](#)

Paper Jams

Always remove the remaining paper from the paper tray and straighten the stack when you are adding new paper. This helps prevent multiple sheets of paper from feeding through the machine at one time and prevents paper jams.

- [Paper is Jammed in the MP tray](#)
- [Paper is Jammed in the Paper Tray](#)
- [Paper is Jammed in the Back of the Machine](#)
- [Paper is Jammed Inside the Machine](#)
- [Paper is Jammed underneath the Paper Tray](#)

Paper is Jammed in the MP tray

If the machine's control panel or the Status Monitor indicates that there is a jam in the machine's MP tray, follow these steps:

1. Remove the paper from the MP tray.
2. Remove any jammed paper from in and around the MP tray.

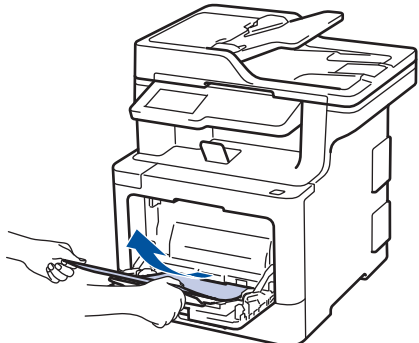

3. Fan the paper stack, and then put it back in the MP tray.
4. Reload paper in the MP tray and make sure the paper stays under the maximum paper height guides (1) on both sides of the tray. Place the paper's leading edge (top of paper) between the ▲ and ▼ arrows (2).

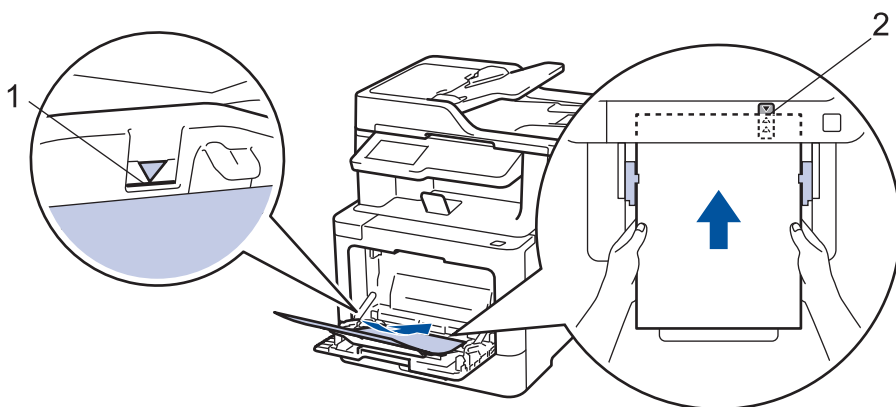

5. Follow the instructions on the machine's LCD.

✓ Related Information

- [Paper Jams](#)

Paper is Jammed in the Paper Tray

If the machine's control panel or the Status Monitor indicates that there is a jam in the paper tray, follow these steps:

1. Pull the paper tray completely out of the machine.

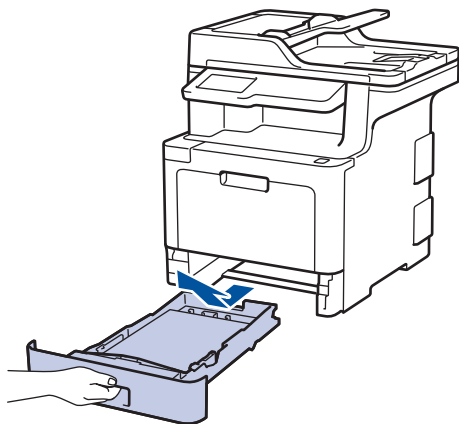

2. Slowly pull out the jammed paper.

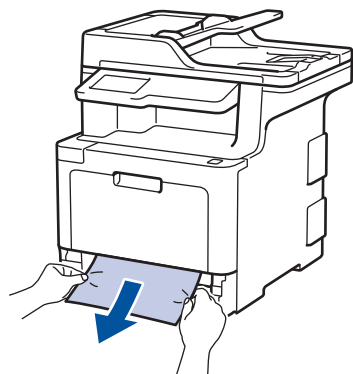

Pulling the jammed paper downward using both hands allows you to remove the paper more easily.

3. Fan the stack of paper to prevent further jams, and slide the paper guides to fit the paper size.

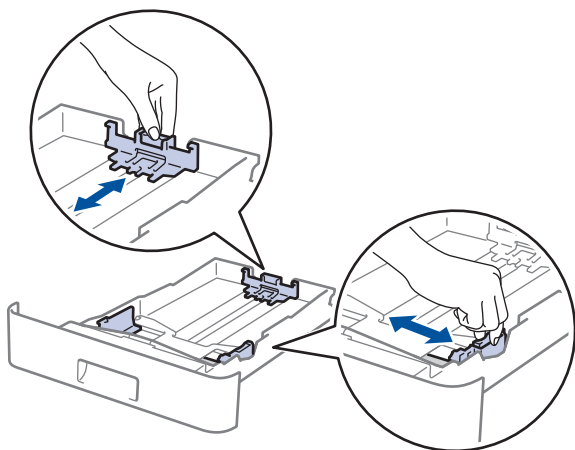

4. Make sure the paper is below the maximum paper mark (▼▼▼).

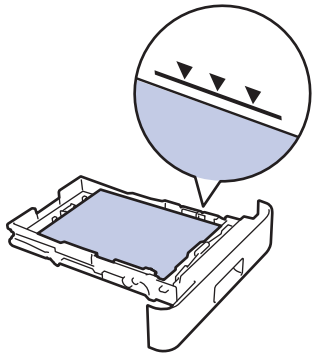

5. Put the paper tray firmly back in the machine.

Related Information

- [Paper Jams](#)

Paper is Jammed in the Back of the Machine

If the machine's control panel or the Status Monitor indicates that there is a jam in the back (Rear) of the machine, follow these steps:

1. Leave the machine turned on for 10 minutes for the internal fan to cool the extremely hot parts inside the machine.
2. Open the back cover.

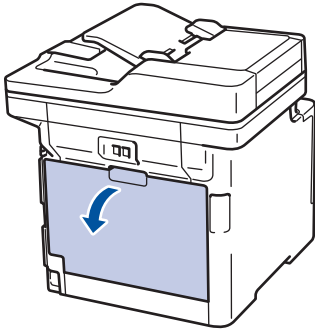

3. Pull the green levers at the left and right sides toward you to release the fuser cover.

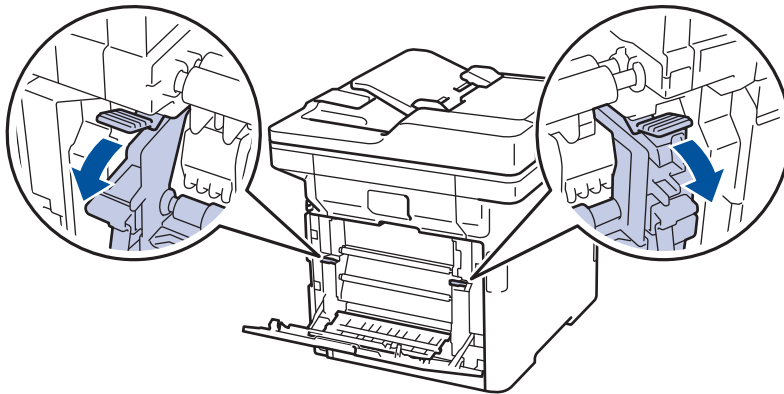

WARNING

HOT SURFACE

The machine's internal parts will be extremely hot. Wait for the machine to cool down before touching them.

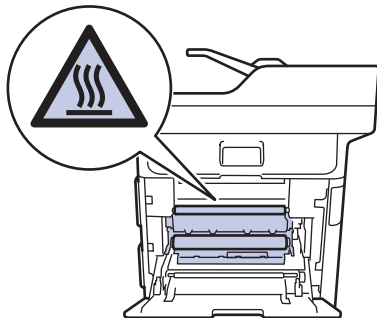

 If the gray envelope levers inside the back cover are pulled down to the envelope position, lift these levers to the original position before pulling the green tabs down.

4. Use both hands to gently pull the jammed paper out of the fuser unit.

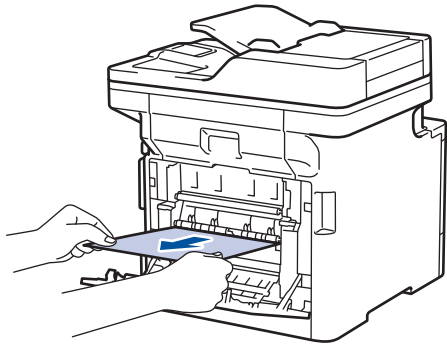

5. Close the fuser cover.

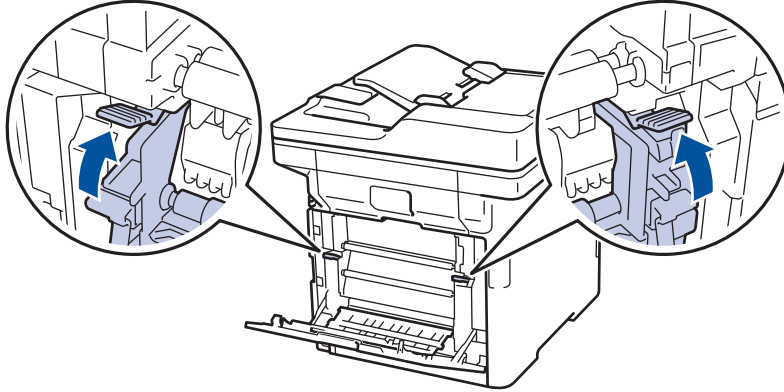

If you print on envelopes, pull down the gray envelope levers to the envelope position again before closing the back cover.

6. Close the back cover until it locks in the closed position.



Related Information

- [Paper Jams](#)

Paper is Jammed Inside the Machine

If the machine's control panel or the Status Monitor indicates that there is a jam inside the machine, follow these steps:

1. Press the front cover release button and pull open the front cover.

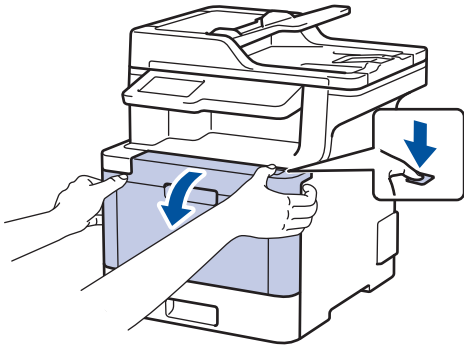

2. Hold the drum unit's green handle. Pull the drum unit out of the machine until it stops.

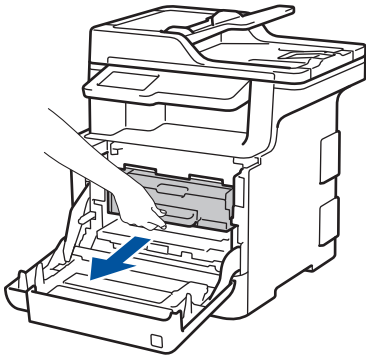

3. Turn the green lock lever (1) counterclockwise until it locks in the release position. Holding the green handles of the drum unit, lift the front of the drum unit and remove it from the machine.

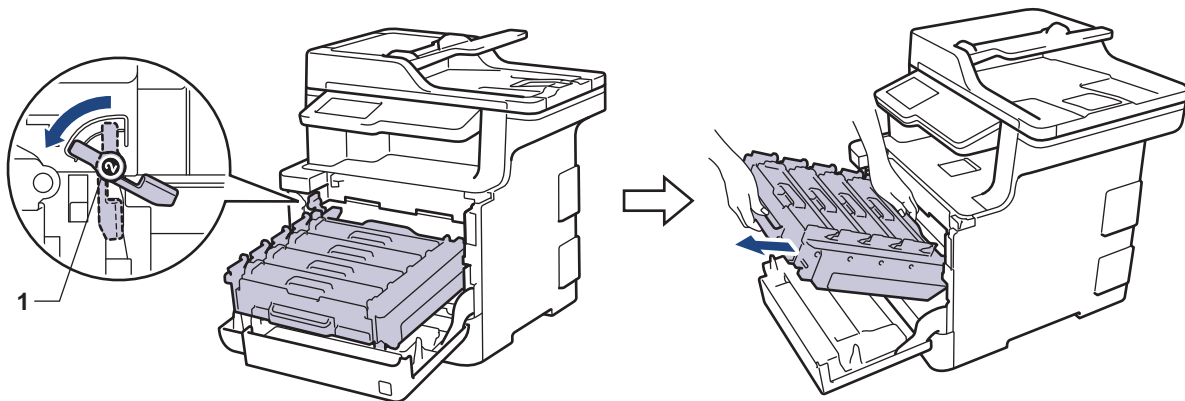

IMPORTANT

Hold the green handles of the drum unit when you carry it. **DO NOT** hold the sides of the drum unit.

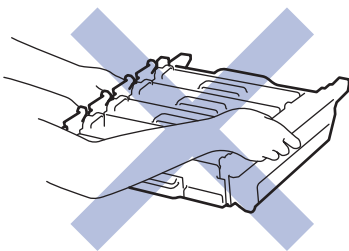

4. Pull out the jammed paper slowly.

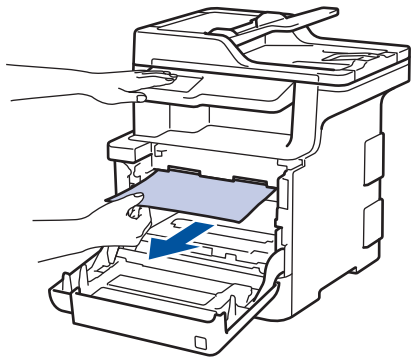

NOTE

To avoid print quality problems, DO NOT touch the shaded parts shown in the illustrations.

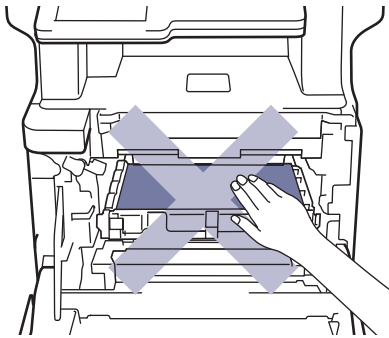

5. Make sure the green lock lever (1) is in the release position, as shown in the illustration.

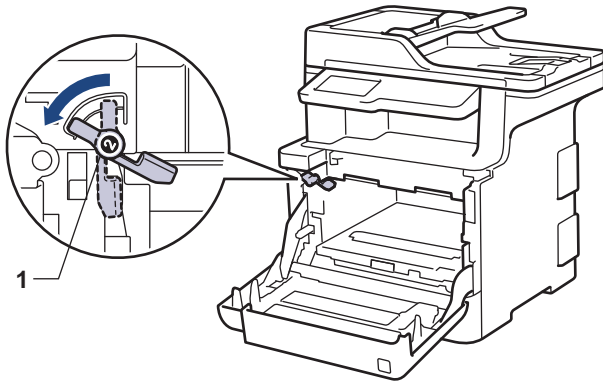

6. Gently slide the drum unit into the machine until it stops at the green lock lever.

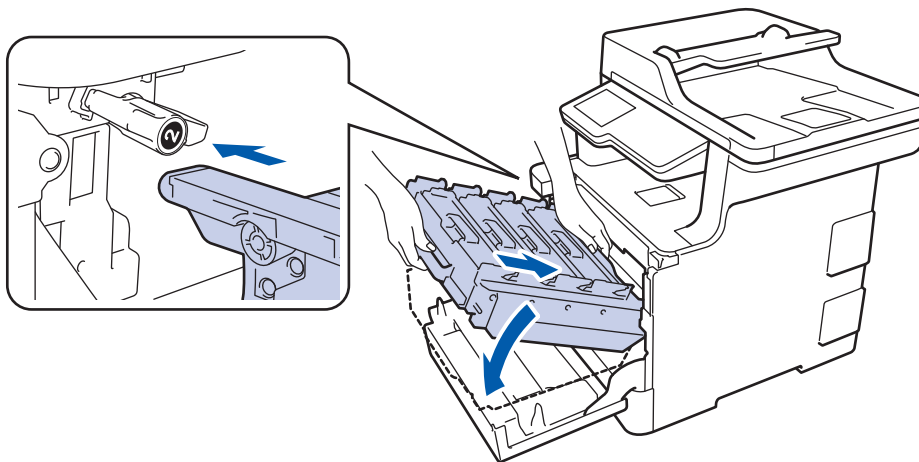

7. Turn the green lock lever clockwise to the lock position.

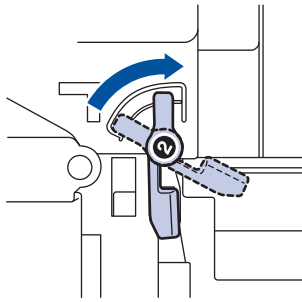

8. Using the green handle, push the drum unit back into the machine until it locks in place.

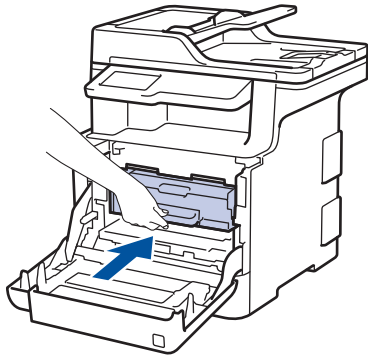

9. Close the machine's front cover.

Related Information

- [Paper Jams](#)

Paper is Jammed underneath the Paper Tray

If the machine's control panel or the Status Monitor indicates that there is a jam in the paper tray, follow these steps:

1. Leave the machine turned on for 10 minutes for the internal fan to cool the extremely hot parts inside the machine.
2. Pull the paper tray completely out of the machine.

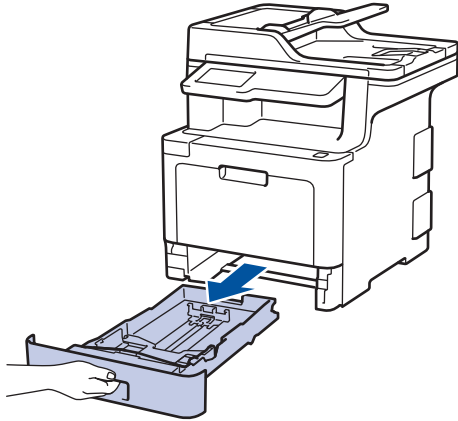

3. Make sure the jammed paper does not remain inside the machine.

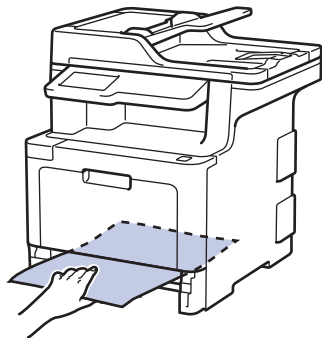

4. If paper is not jammed inside the machine, remove the paper from the paper tray, flip it over, and check underneath the paper tray.

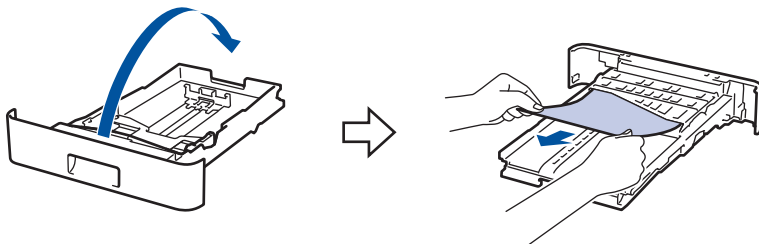

5. If the paper is not jammed in the paper tray, open the back cover.

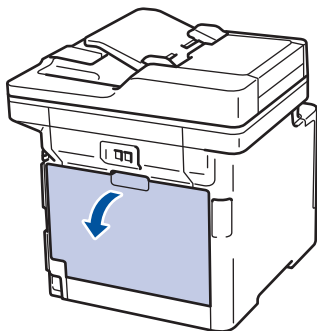

WARNING

HOT SURFACE

The machine's internal parts will be extremely hot. Wait for the machine to cool down before touching them.

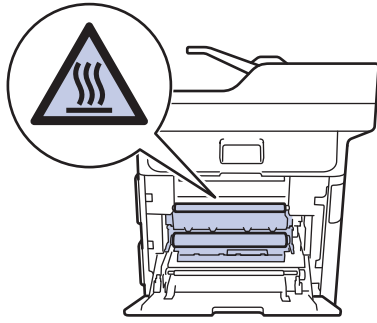

-
6. Use both hands to gently pull the jammed paper out of the back of the machine.

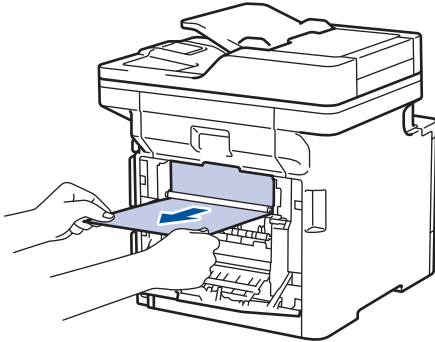







7. Close the back cover until it locks in the closed position.
8. Put the paper tray firmly back in the machine.



Related Information

- [Paper Jams](#)
-

Printing Problems

Difficulties	Suggestions
No printout	<p>Check the machine is not in Power Off mode.</p> <p>If the machine is in Power Off mode, press  on the control panel, and then send the print data again.</p> <p>Check that the correct printer driver has been installed and selected.</p> <p>Check to see if the Status Monitor or the machine's control panel displays an error status.</p> <p>Check that the machine is online:</p> <ul style="list-style-type: none"> • Windows® 7 and Windows Server® 2008 R2 Click  (Start) > Devices and Printers . Right-click Brother XXX-XXXX and click See what's printing. Click Printer in the menu bar. Make sure Use Printer Offline is not selected. • Windows Server® 2008 Click  (Start) > Control Panel > Hardware and Sound > Printers. Right-click Brother XXX-XXXX. Make sure Use Printer Online is not listed. If it is listed, click this option to set the driver Online. • Windows® 8 and Windows Server® 2012 Move your mouse to the lower right corner of your desktop. When the menu bar appears, click Settings > Control Panel. In the Hardware and Sound group, click Devices and Printers. Right-click the Brother XXX-XXXX. Click See what's printing. If printer driver options appear, select your printer driver. Click Printer in the menu bar and make sure that Use Printer Offline is not selected. • Windows® 10 and Windows Server® 2016 Click  > Windows System > Control Panel. In the Hardware and Sound group, click View devices and printers. Right-click the Brother XXX-XXXX. Click See what's printing. If printer driver options appear, select your printer driver. Click Printer in the menu bar and make sure that Use Printer Offline is not selected. • Windows Server® 2012 R2 Click Control Panel on the Start screen. In the Hardware group, click View devices and printers. Right-click the Brother XXX-XXXX. Click See what's printing. If printer driver options appear, select your printer driver. Click Printer in the menu bar and make sure Use Printer Offline is not selected. • Macintosh Click the System Preferences menu, and then select the Printers & Scanners option. When the machine is offline, delete it using the  button, and then add it using the  button.

Difficulties	Suggestions
The machine is not printing or has stopped printing.	Cancel the print job and clear it from the machine's memory. The printout may be incomplete. Send the print data again. <i>See Related Information:Cancel a Print Job.</i>
The headers or footers appear when the document displays on the screen but they do not show up when it is printed.	There is an unprintable area on the top and bottom of the page. Adjust the top and bottom margins in your document to allow for this.
The machine prints unexpectedly or it prints garbage.	Cancel the print job and clear it from the machine's memory. The printout may be incomplete. Send the print data again. <i>See Related Information:Cancel a Print Job.</i>
	Check the settings in your application to make sure they are set up to work with your machine.
	Confirm that the Brother printer driver is selected in your application's Print window.
The machine prints the first couple of pages correctly, then some pages have missing text.	Check the settings in your application to make sure they are set up to work with your machine.
	Your machine is not receiving all of the data sent from the computer. Make sure you connected the interface cable correctly.
The machine does not print on both sides of the paper even though the printer driver setting is 2-sided and the machine supports automatic 2-sided printing.	Check the paper size setting in the printer driver. You must select Letter, Legal, Folio, or Mexico Legal paper that is 16 to 28 lb (60 to 105 g/m ²).
Print speed is too slow.	Try changing the printer driver setting. The highest resolution needs longer data processing, sending and printing time.
	If you have enabled the Quiet Mode, disable the Quiet Mode on the printer driver or the machine's menu setting.
The machine does not feed paper.	If there is paper in the paper tray, make sure it is straight. If the paper is curled, straighten it. Sometimes it is helpful to remove the paper, turn the stack over and place it back in the paper tray.
	Reduce the amount of paper in the paper tray, and then try again.
	Make sure MP Tray is not selected for Paper Source in the printer driver.
	Clean the paper pick-up rollers.
The machine does not feed paper from the MP tray.	Fan the paper well and place it back in the MP tray firmly.
	Make sure MP Tray is selected as Paper Source in the printer driver.
The machine does not feed envelopes.	Load envelopes in the MP tray. Your application must be set to print the envelope size you are using. This is usually done in the Page Setup or Document Setup menu of your application.



Related Information

- [Troubleshooting](#)
- [Monitor the Status of the Machine from Your Computer \(Windows®\)](#)
- [Monitor the Status of the Machine from Your Computer \(Macintosh\)](#)
- [Cancel a Print Job](#)
- [Load and Print Using the Paper Tray](#)

-
- Clean the Paper Pick-up Rollers
 - Load and Print Using the Multi-purpose Tray (MP Tray)
-



Improve the Print Quality



If you have a print quality problem, print a test page first. If the printout looks good, the problem is probably not the machine. Check the interface cable connections and try printing a different document. If the printout or test page printed from the machine has a quality problem, check the examples of poor print quality and follow the recommendations in the table.

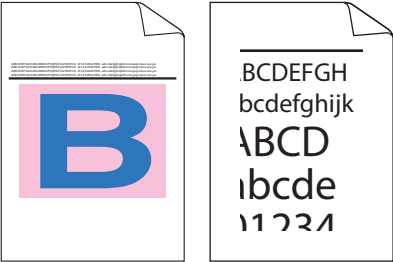

IMPORTANT

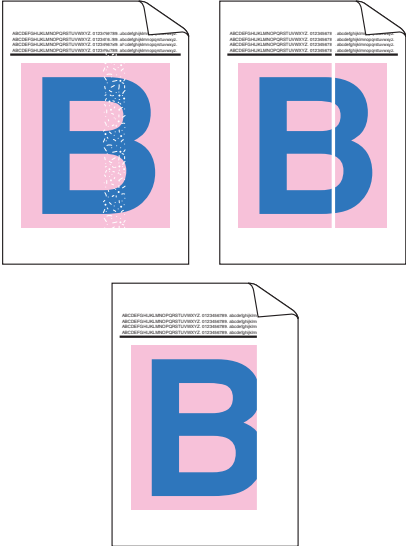
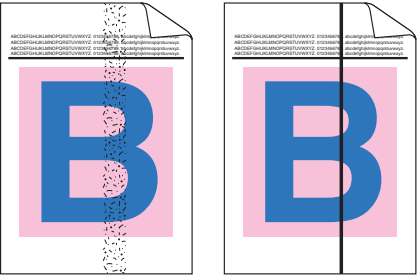

Using non-genuine supplies may affect the print quality, hardware performance, and machine reliability.

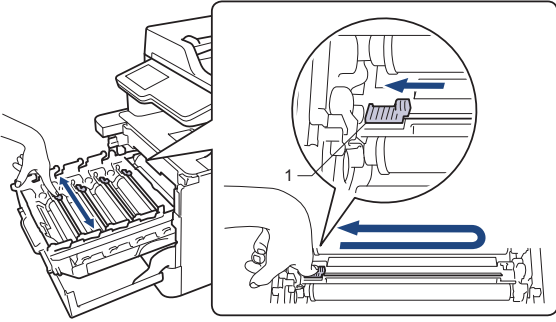
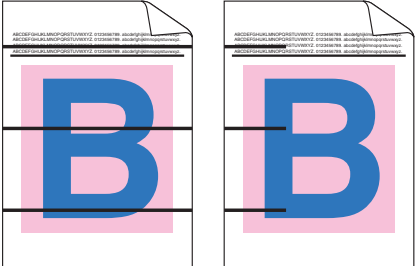

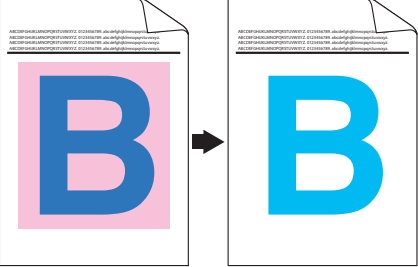
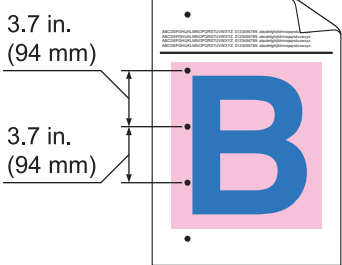
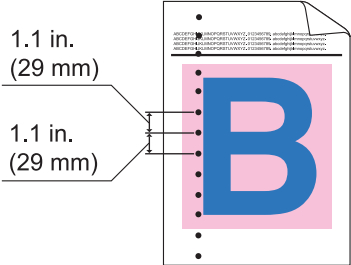
1. To get the best print quality, we suggest using recommended print media. Make sure you use paper that meets our specifications. See *Related Information:Recommended Print Media*
2. Check that the drum unit and toner cartridges are installed correctly.

Examples of poor print quality	Recommendation
 <p>Printed pages are compressed, horizontal stripes appear, or characters in the top, bottom, left, or right margins are cut off</p>	<p>Adjust the print margins in your document's application and reprint the job.</p>
 <p>Colored letters and thin letters in the original document are light or faint in the copy</p>	<ul style="list-style-type: none"> • Choose Text or Receipt in the copy quality setting. • Adjust the copy density and contrast.
 <p>Colors are light or faint on the whole page</p>	<ul style="list-style-type: none"> • Use the machine's LCD to perform calibration. See <i>Related Information:Calibrate Color Output</i>. • Adjust the copy density and contrast if you are copying. • Make sure Toner Save mode is off in the LCD or the printer driver. See <i>Related Information:Reduce Toner Consumption</i>. • Make sure the media type setting in the printer driver matches the type of paper you are using. • Shake all four toner cartridges gently. • Wipe the laser scanner windows with a dry, soft lint-free cloth.

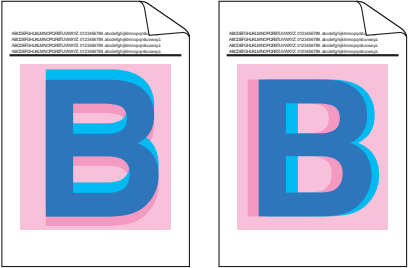
Examples of poor print quality	Recommendation
 <p data-bbox="188 712 766 748">Vertical white streaks or bands appear on the page</p>	<ul data-bbox="820 168 1452 398" style="list-style-type: none"> • Wipe the laser scanner windows with a dry, soft lint-free cloth. • Wipe the scanner glass strip with a dry lint free soft cloth. • Make sure foreign material such as a torn piece of paper, sticky notes, or dust is not inside the machine and around the drum unit and toner cartridge.
 <p data-bbox="177 1070 777 1106">Vertical colored streaks or bands appear on the page</p>	<ul data-bbox="820 757 1461 891" style="list-style-type: none"> • Wipe the scanner glass strip with a dry lint free soft cloth. • Clean all four corona wires (one for each color) inside the drum unit by sliding the green tab. <p data-bbox="852 913 1452 994">  Make sure the green tab of the corona wire is in the home position(1). </p>  <ul data-bbox="820 1339 1461 1644" style="list-style-type: none"> • Replace the toner cartridge that matches the color of the streak or band. To identify the color of the toner cartridge, visit the Brother Solutions Center at support.brother.com and view the FAQs & Troubleshooting page for your Brother model. <i>See Related Information: Replace the Toner Cartridge.</i> • Install a new drum unit. <i>See Related Information: Replace the Drum Unit.</i>
 <p data-bbox="229 1928 724 1964">Horizontal colored lines appear on the page</p>	<ul data-bbox="820 1664 1461 1944" style="list-style-type: none"> • Identify the color causing the problem and replace the toner cartridge that matches the color of the line. To identify the color of the toner cartridge, visit the Brother Solutions Center at support.brother.com to see the FAQs & Troubleshooting page. <i>See Related Information: Replace the Toner Cartridge.</i> • Install a new drum unit. <i>See Related Information: Replace the Drum Unit.</i>

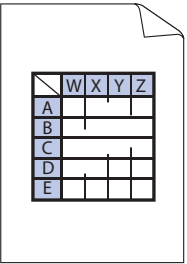
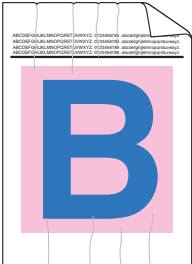
Examples of poor print quality	Recommendation
 <p data-bbox="406 443 544 472">White spots</p>	<ul data-bbox="818 168 1473 544" style="list-style-type: none"> • Make sure the media type setting in the printer driver matches the type of paper you are using. • Check the machine's environment. Conditions such as high humidity can cause hollow print. • If the problem is not solved after printing a few pages, the drum may have foreign material, such as glue from a label, stuck on the drum surface. Clean the drum unit. <i>See Related Information: Clean the Drum Unit.</i> • Install a new drum unit. <i>See Related Information: Replace the Drum Unit.</i>
 <p data-bbox="277 831 678 860">Blank page or some missing colors</p>	<ul data-bbox="818 566 1473 842" style="list-style-type: none"> • Identify the color causing the problem and install a new toner cartridge. To identify the color of the toner cartridge, visit the Brother Solutions Center at support.brother.com to see the FAQs & Troubleshooting page. <i>See Related Information: Replace the Toner Cartridge.</i> • Install a new drum unit. <i>See Related Information: Replace the Drum Unit.</i>
 <p data-bbox="293 1151 657 1180">Colored spots at 3.7 in. (94 mm)</p>	<ul data-bbox="818 880 1473 1115" style="list-style-type: none"> • If the problem is not solved after printing a few pages, the drum may have foreign material, such as glue from a label, stuck on the drum surface. Clean the drum unit. <i>See Related Information: Clean the Drum Unit.</i> • Install a new drum unit. <i>See Related Information: Replace the Drum Unit.</i>
 <p data-bbox="293 1471 657 1500">Colored spots at 1.1 in. (29 mm)</p>	<ul data-bbox="818 1200 1473 1397" style="list-style-type: none"> • Identify the color causing the problem and install a new toner cartridge. To identify the color of the toner cartridge, visit the Brother Solutions Center at support.brother.com to see the FAQs & Troubleshooting page. <i>See Related Information: Replace the Toner Cartridge.</i>
 <p data-bbox="325 1785 625 1814">Toner scatter or toner stain</p>	<ul data-bbox="818 1520 1473 1888" style="list-style-type: none"> • Check the machine's environment. Conditions such as high humidity and high temperatures may cause this print quality problem. • Identify the color causing the problem and put in a new toner cartridge. To identify the color of the toner cartridge, visit the Brother Solutions Center at support.brother.com to see the FAQs & Troubleshooting page. <i>See Related Information: Replace the Toner Cartridge.</i> • Install a new drum unit. <i>See Related Information: Replace the Drum Unit.</i>
<p data-bbox="185 1906 772 1935">The color of your printouts is not what you expected</p>	<ul data-bbox="818 1906 1473 2098" style="list-style-type: none"> • To improve the color density, calibrate the colors using the LCD. • To adjust the print position of colors for sharper edges, perform the color registration using the LCD. • Adjust the copy density and contrast if you are copying.

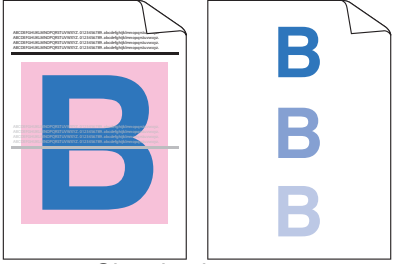
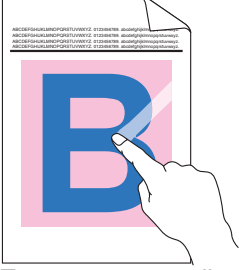
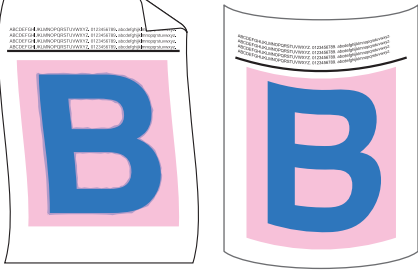
Examples of poor print quality	Recommendation
	<ul style="list-style-type: none"> • Make sure Toner Save mode is off in the LCD or the printer driver. • If the print quality of the black portion is not what you expected, select the Enhance Black Printing check box in the printer driver. • Clear the Improve Gray Color check box in the printer driver. • Identify the color causing the problem and put in a new toner cartridge. To identify the color of the toner cartridge, visit the Brother Solutions Center at support.brother.com to see the FAQs & Troubleshooting page. <i>See Related Information: Replace the Toner Cartridge.</i> • Install a new drum unit. <i>See Related Information: Replace the Drum Unit.</i>
 <p data-bbox="411 969 544 999">Color offset</p>	<ul style="list-style-type: none"> • Make sure the machine is on a solid level surface. • Perform the color registration using the LCD. • Install a new drum unit. <i>See Related Information: Replace the Drum Unit.</i> • Install a new belt unit. <i>See Related Information: Replace the Belt Unit.</i>
 <p data-bbox="261 1283 689 1312">Uneven color density across the page</p>	<ul style="list-style-type: none"> • Perform the calibration using the LCD. • Adjust the copy density and contrast if you are copying. • Clear the Improve Gray Color check box in the printer driver. • Identify the color causing the problem and put in a new toner cartridge. To identify the color of the toner cartridge, visit the Brother Solutions Center at support.brother.com to see the FAQs & Troubleshooting page. <i>See Related Information: Replace the Toner Cartridge.</i> • Install a new drum unit. <i>See Related Information: Replace the Drum Unit.</i>
 <p data-bbox="320 1749 635 1778">Missing thin lines in images</p>	<ul style="list-style-type: none"> • Make sure Toner Save mode is off in the LCD or the printer driver. • Change the print resolution. • If you use a Windows printer driver, choose Improve Pattern Printing in Print Setting of the Basic tab.
 <p data-bbox="379 2056 571 2085">Wrinkled printout</p>	<ul style="list-style-type: none"> • Check the paper type and quality. • Make sure the back cover is closed correctly. • Make sure the two gray levers inside the back cover are in the up position. • Make sure the media type setting in the printer driver matches the type of paper you are using.

Examples of poor print quality	Recommendation
 <p data-bbox="379 443 576 472">Ghosting images</p>	<ul data-bbox="818 170 1474 439" style="list-style-type: none"> • Check the machine's environment. Conditions such as low humidity and low temperatures may cause this print quality problem. • Make sure the media type setting in the printer driver matches the type of paper you are using. • Make sure the two gray levers inside the back cover are in the up position. • Install a new drum unit. <p data-bbox="858 450 1406 479"><i>See Related Information: Replace the Drum Unit.</i></p>
 <p data-bbox="363 779 603 808">Toner smears easily</p>	<ul data-bbox="818 499 1457 689" style="list-style-type: none"> • Make sure the two gray levers inside the back cover are in the up position. • Make sure the media type setting in the printer driver matches the type of paper you are using. • Choose Improve Toner Fixing mode in the printer driver. <p data-bbox="858 701 1437 853">If this selection does not provide enough improvement, change the printer driver setting in Media Type to a thick setting. If you are printing an envelope, choose Env. Thick in the media type setting.</p>
 <p data-bbox="352 1144 603 1173">Curled or wavy image</p>	<ul data-bbox="818 875 1469 1339" style="list-style-type: none"> • Choose Reduce Paper Curl mode in the printer driver. <p data-bbox="858 943 1433 1003">If the problem is not solved, choose Plain Paper in the media type setting.</p> <ul data-bbox="818 1014 1469 1339" style="list-style-type: none"> • If you are printing an envelope, choose Env. Thin in the Media Type Setting of the printer driver. • If you do not use the machine often, the paper may have been in the paper tray too long. Turn over the stack of paper in the paper tray. Also, fan the paper stack and then rotate the paper 180° in the paper tray. • Store the paper where it will not be exposed to high temperatures and high humidity. • Open the back cover (Face up output tray) to let the printed paper exit onto the Face up output tray.
 <p data-bbox="379 1697 576 1727">Envelope creases</p>	<ul data-bbox="818 1361 1457 1451" style="list-style-type: none"> • Make sure the envelope levers inside the back cover are pulled down to the envelope position when you print envelopes. <div data-bbox="858 1503 1474 1552" style="background-color: #e6f2ff; padding: 5px;">NOTE</div> <p data-bbox="882 1570 1457 1697">When you have finished printing, open the back cover and reset the two gray levers back to their original position (1) by lifting them up until they stop.</p>

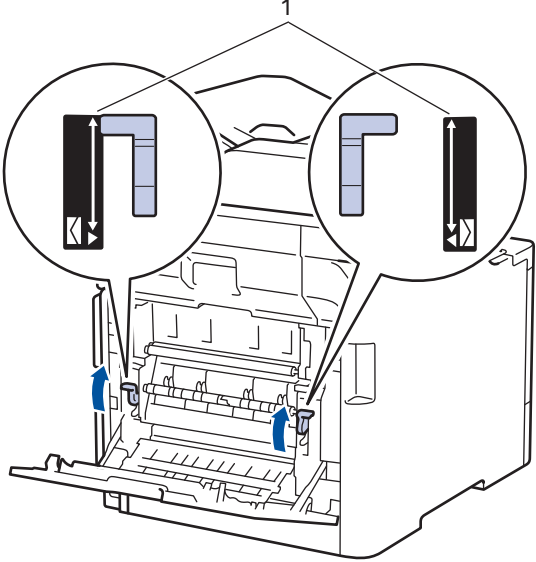
Examples of poor print quality	Recommendation
	 <p>The diagram shows a cross-section of an envelope feeder. A number '1' is positioned above the mechanism. Two circular callouts provide a magnified view of the envelope levers. In the left callout, a black vertical bar is shown moving upwards and then downwards, with a blue arrow indicating the upward stroke. In the right callout, a blue vertical bar is shown moving upwards and then downwards, with a black arrow indicating the downward stroke. Below the main diagram, two blue arrows point upwards towards the rollers of the feeder.</p> <ul style="list-style-type: none"> • If creases occur with the envelope levers in the envelope position, print with the back cover open and feed one envelope at a time from the MP tray.

✓ Related Information

- [Troubleshooting](#)
- [Test Print](#)
- [Clean the Drum Unit](#)
- [Recommended Print Media](#)
- [Calibrate Color Output](#)
- [Reduce Toner Consumption](#)
- [Replace the Toner Cartridge](#)
- [Replace the Drum Unit](#)
- [Replace the Belt Unit](#)

Telephone and Fax Problems

Telephone Line or Connections

Difficulties	Suggestions
Dialing does not work. (No dial tone)	Check all line cord connections. Make sure the telephone line cord is plugged into the telephone wall jack and the LINE jack of the machine. Make sure your machine has a dial tone by pressing the Hook button in Fax mode. If you subscribe to DSL, VoIP or MagicJack services, call your service provider for connection instructions.
	(Available only for some countries.) Change the Tone/Pulse setting.
	Send a manual fax by pressing Hook button, and dialing the number. Wait to hear fax-receiving tones before pressing Start button.
	If there is no dial tone, connect a known working telephone and telephone line cord to the jack. Then lift the external telephone's handset and listen for a dial tone. If there is still no dial tone, ask your telephone company to check the line and/or wall jack.
The machine does not answer when called.	Make sure the machine is in the correct receive mode for your setup. Check for a dial tone. If possible, call your machine to hear it answer. If there is still no answer, check that the telephone line cord is plugged into the telephone wall jack and the LINE jack of the machine. Make sure your machine has a dial tone by pressing the Hook button in Fax mode. If there is no ringing when you call your machine, ask your telephone company to check the line.

Handling Incoming Calls

Difficulties	Suggestions
Sending a Fax Call to the machine.	If you answered on an extension telephone, press your Fax Receive Code (the factory setting is *51). If you answered on the external telephone (connected to the EXT. jack), press the Start button to receive the fax. When your machine answers, hang up.
Custom features on a single line.	If you have Call Waiting, Voice Mail, an answering machine, an alarm system or other custom feature on a single telephone line with your machine, it may create a problem sending or receiving faxes. For Example: If you subscribe to Call Waiting or some other custom service and its signal comes through the line while your machine is sending or receiving a fax, the signal can temporarily interrupt or disrupt the faxes. Brother's ECM (Error Correction Mode) feature should help overcome this problem. This condition is related to the telephone system industry and is common to all devices that send and receive information on a single, shared line with custom features. If avoiding a slight interruption is crucial to your business, we recommend using a separate telephone line with no custom features.

Receiving Faxes

Difficulties	Suggestions
Cannot receive a fax.	Check all line cord connections. Make sure the telephone line cord is plugged into the telephone wall jack and the LINE jack of the machine. If you subscribe to DSL, VoIP, or MagicJack services, call your service provider for connection instructions. If you are using a VoIP system, try changing the VoIP setting to <i>Basic (for VoIP)</i> . This will lower modem speed and turn off Error Correction Mode (ECM).
	Make sure your machine has a dial tone by pressing the Hook button in Fax mode. If you hear static or interference on your fax line, contact your local telephone provider.

Difficulties	Suggestions
Cannot receive a fax.	<p>Make sure the machine is in the correct Receive Mode. This is determined by the external devices and telephone subscriber services you have on the same line as the Brother machine.</p> <ul style="list-style-type: none"> • If you have a dedicated fax line and want your Brother machine to automatically answer all incoming faxes, you should select Fax only mode. • If your Brother machine shares a line with an external answering machine, you should select the External TAD mode. In External TAD mode, your Brother machine will receive incoming faxes automatically and voice callers will be able to leave a message on your answering machine. • If your Brother machine shares the line with a Voice Mail subscriber service, see <i>Related Information: Voice Mail</i>. • If your Brother machine is on a line with the Distinctive Ring subscriber service, see <i>Related Information: Distinctive Ring</i>. • If your Brother machine shares a line with other telephones and you want it to automatically answer all incoming faxes, you should select the Fax/Tel mode. In Fax/Tel mode, your Brother machine will receive faxes automatically and produce a pseudo/double-ring to alert you to answer voice calls. • If you do not want your Brother machine to answer any incoming faxes automatically, you should select the Manual mode. In Manual mode, you must answer every incoming call and activate the machine to receive faxes.
	<p>Another device or service at your location may be answering the call before your Brother machine answers. To test this, lower the Ring Delay setting:</p> <ul style="list-style-type: none"> • If the Receive Mode is set to Fax Only or Fax/Tel, reduce the Ring Delay to one ring. See <i>Related Information: Set the Number of Rings Before the Machine Answers (Ring Delay)</i>. • If the Receive Mode is set to External TAD, reduce the number of rings programmed on your answering machine to two. • If the Receive Mode is set to Manual, DO NOT adjust the Ring Delay setting.
	<p>Have someone send you a test fax:</p> <ul style="list-style-type: none"> • If you received the test fax successfully, your machine is operating correctly. Remember to reset your Ring Delay or answering machine setting back to your original setting. If receiving problems recur after resetting the Ring Delay, then a person, device, or subscriber service is answering the fax call before the machine has a chance to answer. • If you were not able to receive the fax, then another device or subscriber service may be interfering with your fax reception or there may be a problem with your fax line.
	<p>If you are using a telephone answering machine (External TAD mode) on the same line as the Brother machine, make sure your answering machine is set up correctly.</p> <ol style="list-style-type: none"> 1. Plug the telephone line cord directly from the wall telephone jack to your Brother machine's LINE jack. 2. Remove the protective cap from your Brother machine's EXT jack, and then plug the telephone line cord from your answering machine into the EXT jack. 3. Set your answering machine to answer within 4 rings. If you are having problems receiving faxes or voice messages, set your answering machine to answer within 2 or 3 rings. 4. Record the outgoing message on your answering machine. <ul style="list-style-type: none"> • Record five seconds of silence at the beginning of your outgoing message. • Limit your speaking to 20 seconds. • End your outgoing message with your Fax Receive Code for people sending manual faxes. For example: "After the beep, leave a message or press *51 and Start to send a fax." 5. Set your answering machine to answer calls. 6. Set your Brother machine's Receive Mode to External TAD. See <i>Related Information: Choose the Correct Receive Mode</i>.
	<p>Make sure your Brother machine's Easy Receive feature is turned On. Easy Receive is a feature that allows you to receive a fax even if you answered the call on an external or extension telephone.</p>
	<p>If you often get transmission errors due to possible interference on the telephone line or if you are using a VoIP system, try changing the Compatibility setting to <i>Basic(for VoIP)</i>.</p>

Difficulties	Suggestions
Cannot receive a fax.	Contact your administrator to check your Secure Function Lock Settings.

Sending Faxes

Difficulties	Suggestions
Cannot send a fax.	Check all line cord connections. Make sure the telephone line cord is plugged into the telephone wall jack and the LINE jack of the machine. Make sure your machine has a dial tone by pressing the Hook button in Fax mode. If you subscribe to DSL, VoIP, or magicJack services, call your service provider for connection instructions.
	Make sure you pressed Fax and the machine is in Fax mode.
	Print the Transmission Verification Report and check for an error.
	Contact your administrator to check your Secure Function Lock Settings.
	Ask the other party to check that the receiving machine has paper.
Poor sending quality.	Try changing your resolution to Fine or S.Fine. Make a copy to check your machine's scanner operation. If the copy quality is poor, clean the scanner.
Transmission Verification Report says RESULT:NG.	There is probably temporary noise or static on the line. Try sending the fax again. If you are sending a PC-Fax message and get RESULT:NG on the Transmission Verification Report, your machine may be out of memory. To free up extra memory, you can turn off Fax Storage, print fax messages in memory or cancel a delayed fax. If the problem continues, ask the telephone company to check your telephone line.
	If you often get transmission errors due to possible interference on the telephone line or if you are using a VoIP system, try changing the Compatibility setting to Basic(for VoIP).
Sent faxes are blank.	Make sure you are loading the document correctly. When using the ADF, the document should be face up. When using the scanner glass, the document should be face down.
Vertical black lines when sending.	Black vertical lines on faxes you send are typically caused by dirt or correction fluid on the glass strip. Clean the glass strip.

Printing received faxes

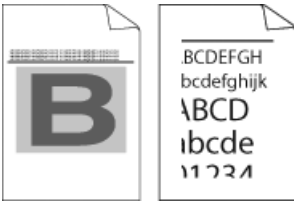
Difficulties	Suggestions
<ul style="list-style-type: none"> Condensed print Horizontal streaks Top and bottom sentences are cut off Missing lines 	<p>This is usually caused by a poor telephone connection. Make a copy; if your copy looks good, you probably had a bad connection, with static or interference on the telephone line. Ask the other party to send the fax again.</p>
Vertical black lines when receiving	The corona wires for printing may be dirty. Clean the corona wires in the drum unit.
	The sender's scanner may be dirty. Ask the sender to make a copy to see if the problem is with the sending machine. Try receiving from another fax machine.
Received faxes appear as split or blank pages.	Left and right margins are cut off or a single page is printed on two pages.
	Turn on Auto Reduction.

✓ Related Information

- [Troubleshooting](#)
- [Set Dial Tone Detection](#)

-
- Set Telephone Line Compatibility for Interference and VoIP Systems
 - Voice Mail
 - Distinctive Ring
 - Set the Number of Rings Before the Machine Answers (Ring Delay)
 - Choose the Correct Receive Mode
-

Set Dial Tone Detection

Setting the Dial Tone to [Detection] will shorten the Dial Tone detect pause.

1. Press  [Settings] > [All Settings] > [Initial Setup] > [Dial Tone].



If your machine displays the [All Settings] menu on the Home screen, skip the [Settings] menu.

2. Press [Detection] or [No Detection]
3. Press .



Related Information

- [Telephone and Fax Problems](#)

Set Telephone Line Compatibility for Interference and VoIP Systems

Problems sending and receiving faxes due to possible interference on the telephone line may be solved by reducing the modem speed to minimize errors in fax transmission. If you are using a Voice over IP (VoIP) service, Brother recommends changing the compatibility to Basic (for VoIP).



- VoIP is a type of phone system that uses an Internet connection, rather than a traditional phone line.
- Telephone providers frequently bundle VoIP together with Internet and cable services.

1. Press  [Settings] > [All Settings] > [Initial Setup] > [Compatibility].



If your machine displays the [All Settings] menu on the Home screen, skip the [Settings] menu.

2. Press the option you want.

- Select [High] to set the modem speed to 33600 bps.
- Select [Normal] to set the modem speed to 14400 bps.
- Select [Basic (for VoIP)] to reduce the modem speed to 9600 bps and turn off Error Correction Mode (ECM). Unless interference is a recurring problem on your telephone line, you may prefer to use this option only when needed.

3. Press .



Related Information

- [Telephone and Fax Problems](#)

Network Problems

- [Error Messages](#)
- [Use the Network Connection Repair Tool \(Windows®\)](#)
- [Where Can I Find My Brother Machine's Network Settings?](#)
- [I Cannot Complete the Wireless Network Setup Configuration](#)
- [My Brother Machine Cannot Print, Scan, or PC-FAX Receive over the Network](#)
- [I Want to Check that My Network Devices are Working Correctly](#)

Error Messages

Your Brother machine will display an error message if an error occurs. The most common error messages are shown in the table.

Error Messages	Cause	Action
The maximum number of devices are already connected using Wi-Fi Direct.	Two mobile devices are already connected to the Wi-Fi Direct network when the Brother machine is the Group Owner (G/O).	After the current connection between your Brother machine and another mobile device has shut down, try to configure the Wi-Fi Direct settings again. You can confirm the connection status by printing the Network Configuration Report.
Authentication Error, contact your administrator.	Your authentication setting for the Store Print Log to Network feature is not correct.	<ul style="list-style-type: none"> Make sure the Username and Password in Authentication Setting are correct. If the username is part of a domain, enter the username in one of the following styles: user@domain or domain\user. Make sure the time of the log file server matches the time from the SNTP server, or the Date&Time settings. Make sure the SNTP time server settings are configured correctly so the time matches the time used for authentication by Kerberos or NTLMv2. If there is no SNTP server, make sure the Date&Time and Time Zone settings are set correctly using Web Based Management or the control panel so the machine matches the time being used by the server providing the authentication.
Check User ID and Password.	The Kerberos Authentication error.	Make sure you have entered a correct user name and a password for the Kerberos server. For more information on the Kerberos server settings, contact your network administrator.
	The date, time and time zone settings of the Brother machine are not correct.	Confirm your machine's date, time and time zone settings.
	The DNS server configuration is not correct.	Contact your network administrator for the information on the DNS server settings.
	The Brother machine cannot connect to the Kerberos server.	Contact your network administrator for the information on the Kerberos server settings.
Connection Error	Other devices are trying to connect to the Wi-Fi Direct network at the same time.	<ul style="list-style-type: none"> Make sure there are no other devices trying to connect to the Wi-Fi Direct network, and then try to configure the Wi-Fi Direct settings again.
Connection Failed	The Brother machine and your mobile device cannot communicate during the Wi-Fi Direct network configuration.	<ul style="list-style-type: none"> Move the mobile device closer to your Brother machine. Move your Brother machine and the mobile device to an obstruction-free area. If you are using the PIN Method of WPS, make sure you have entered the correct PIN.
File Access Error, contact your administrator.	The Brother machine cannot access the destination folder for the Store Print Log to Network feature.	<ul style="list-style-type: none"> Make sure the stored directory name is correct. Make sure the stored directory is write-enabled. Make sure the file is not locked.
	In Web Based Management, you have selected the Cancel Print option in the Error Detection Setting of Store Print Log to Network .	Wait for about 60 seconds until this message disappears from the LCD.

Error Messages	Cause	Action
No Device	When configuring the Wi-Fi Direct network, the Brother machine cannot find your mobile device.	<ul style="list-style-type: none"> • Make sure your machine and mobile device are in the Wi-Fi Direct mode. • Move the mobile device closer to your Brother machine. • Move your Brother machine and the mobile device to an obstruction-free area. • If you are manually configuring the Wi-Fi Direct network, make sure you have entered the correct password. • If your mobile device has a configuration page for how to obtain an IP address, make sure the IP address of your mobile device has been configured via DHCP.
Server Timeout, contact your administrator.	The Brother machine cannot connect to the server for the Store Print Log to Network feature.	<ul style="list-style-type: none"> • Make sure your server address is correct. • Make sure your server is connected to the network. • Make sure the machine is connected to the network.
Server Timeout	The Brother machine cannot connect to the LDAP server.	<ul style="list-style-type: none"> • Make sure your server address is correct. • Make sure your server is connected to the network. • Make sure the machine is connected to the network.
	The Brother machine cannot connect to the Active Directory® server.	<ul style="list-style-type: none"> • Make sure your server address is correct. • Make sure your server is connected to the network. • Make sure the machine is connected to the network.
Wrong Date&Time, contact your administrator.	The Brother machine does not obtain the time from the SNTP time server or you have not configured the Date&Time for the machine.	<ul style="list-style-type: none"> • Make sure the settings to access the SNTP time server are configured correctly in Web Based Management. • Confirm the Date&Time settings of your machine are correct in Web Based Management.
Internal Error	The Brother machine's LDAP protocol is disabled.	Confirm your authentication method, and then enable the necessary protocol setting in the Web Based Management.
	The Brother machine's CIFS protocol is disabled.	



Related Information



- [Network Problems](#)

Use the Network Connection Repair Tool (Windows®)

Use the Network Connection Repair Tool to fix the Brother machine's network settings. It will assign the correct IP address and Subnet Mask.

- Windows® 7/Windows® 8/Windows® 10
You must log on with Administrator rights.
- Make sure the Brother machine is turned on and is connected to the same network as your computer.

1. Do one of the following:

Option	Description
Windows® 7	Click  (Start) > All Programs > Brother > Brother Utilities . Click the drop-down list and select your model name (if not already selected). Click Tools in the left navigation bar, and then click Network Connection Repair Tool .
Windows® 8/ Windows® 10	Launch  (Brother Utilities), and then click the drop-down list and select your model name (if not already selected). Click Tools in the left navigation bar, and then click Network Connection Repair Tool .



- If the **User Account Control** screen appears, click **Yes**.

2. Follow the on-screen instructions.

3. Check the diagnosis by printing the Network Configuration Report.



The Network Connection Repair Tool will start automatically if you select the **Enable Connection Repair Tool** option in the Status Monitor. Right-click the Status Monitor screen, and then click **Other Settings** > **Enable Connection Repair Tool**. This is not recommended when your network administrator has set the IP address to Static, since it will automatically change the IP address.

If the correct IP address and the Subnet Mask are still not assigned even after using the Network Connection Repair Tool, ask your network administrator for this information.



Related Information

- [Network Problems](#)
- [Print the Network Configuration Report](#)
- [My Brother Machine Cannot Print, Scan, or PC-FAX Receive over the Network](#)
- [I Want to Check that My Network Devices are Working Correctly](#)

Where Can I Find My Brother Machine's Network Settings?

- [Print the Network Configuration Report](#)
- [Change Machine Settings from Your Computer](#)

I Cannot Complete the Wireless Network Setup Configuration

Turn your wireless router off and back on. Then try to configure the wireless settings again. If you are unable to resolve the problem, follow the instructions below:

Investigate the problem using the WLAN Report.

Cause	Action	Interface
Your security settings (SSID/ Network Key) are not correct.	<ul style="list-style-type: none"> • Confirm the security settings using the Wireless Setup Helper utility. For more information and to download the utility, go to your model's Downloads page on the Brother Solutions Center at support.brother.com. • Select and confirm that you are using the correct security settings. <ul style="list-style-type: none"> - See the instructions supplied with your wireless LAN access point/router for information on how to find the security settings. - The manufacturer's name or model number of the wireless LAN access point/router may be used as the default security settings. - Consult with the access point/router manufacturer, your Internet provider, or network administrator. 	Wireless
Your Brother machine's MAC address is not allowed.	Confirm that the Brother machine's MAC Address is allowed in the filter. You can find the MAC Address on your Brother machine's control panel.	Wireless
Your wireless LAN access point/router is in stealth mode (not broadcasting the SSID).	<ul style="list-style-type: none"> • Enter the correct SSID name or Network Key manually. • Check the SSID name or the Network Key in the instructions supplied with your wireless LAN access point/router and reconfigure the wireless network setup. 	Wireless
Your security settings (SSID/ password) are not correct.	<ul style="list-style-type: none"> • Confirm the SSID and password. <ul style="list-style-type: none"> - When you are configuring the network manually, the SSID and password are displayed on your Brother machine. If your mobile device supports the manual configuration, the SSID and password will be displayed on your mobile device's screen. 	Wi-Fi Direct
You are using Android™ 4.0.	If your mobile device disconnects (approximately six minutes after using Wi-Fi Direct), try the one-push configuration using WPS (recommended) and set the Brother machine as a G/O.	Wi-Fi Direct
Your Brother machine is placed too far from your mobile device.	Move your Brother machine within about 3.3 feet (1 meter) of the mobile device when you configure the Wi-Fi Direct network settings.	Wi-Fi Direct
There are some obstructions (walls or furniture, for example) between your machine and the mobile device.	Move your Brother machine to an obstruction-free area.	Wi-Fi Direct
There is a wireless computer, Bluetooth-supported device, microwave oven, or digital cordless phone near the Brother machine or the mobile device.	Move other devices away from the Brother machine or the mobile device.	Wi-Fi Direct
If you have checked and tried all of the above, but still cannot complete the Wi-Fi	<ul style="list-style-type: none"> • Turn your Brother machine off and back on. Then try to configure the Wi-Fi Direct settings again. 	Wi-Fi Direct

Cause	Action	Interface
Direct configuration, do the following:	<ul style="list-style-type: none">If you are using your Brother machine as a client, confirm how many devices are allowed in the current Wi-Fi Direct network, and then check how many devices are connected.	

For Windows®

If your wireless connection has been interrupted, and you have checked and tried all of the above, we recommend using the Network Connection Repair Tool.



Related Information

- [Network Problems](#)
 - [Configure Your Machine for a Wireless Network When the SSID Is Not Broadcast](#)
 - [Use Wi-Fi Direct®](#)
-

My Brother Machine Cannot Print, Scan, or PC-FAX Receive over the Network

Cause	Action	Interface
Your security software blocks your machine's access to the network. (The Network scanning feature does not work.)	<ul style="list-style-type: none"> Windows® Configure the third-party Security/Firewall Software to allow Network scanning. To add port 54925 for Network scanning, type the information below: <ul style="list-style-type: none"> - In Name: Type any description, for example Brother NetScan. - In Port number: Type 54925. - In Protocol: UDP is selected. See the instruction manual that came with your third-party Security/Firewall Software or contact the software manufacturer. Macintosh Launch ControlCenter2. Click the Model pop-up menu, and then select Other... The Device Selector window appears. Reselect your network machine, make sure Status is idle, and then click OK. 	Wired/Wireless
Your security software blocks your machine's access to the network. (The network PC-Fax Receive feature does not work.) (Windows®)	<p>Set the third-party Security/Firewall Software to allow PC-FAX Rx. To add port 54926 for Network PC-FAX Rx, type the information below:</p> <ul style="list-style-type: none"> • In Name: Type any description, for example Brother PC-FAX Rx. • In Port number: Type 54926. • In Protocol: UDP is selected. <p>See the instruction manual that came with your third-party Security/Firewall Software or contact the software manufacturer.</p>	Wired/Wireless
Your security software blocks your machine's access to the network.	<p>Some security software might block access without showing a security alert dialog box even after successful installation.</p> <p>To allow access, see the instructions for your security software or ask the software manufacturer.</p>	Wired/Wireless
Your Brother machine was not assigned an available IP address.	<ul style="list-style-type: none"> • Confirm the IP address and the Subnet Mask. Verify that both the IP addresses and Subnet Masks of your computer and the Brother machine are correct and located on the same network. For more information about how to verify the IP address and the Subnet Mask, ask your network administrator. • Windows® Confirm the IP address and the Subnet Mask using the Network Connection Repair Tool. 	Wired/Wireless
The failed print job is still in your computer's print queue.	<ul style="list-style-type: none"> • If the failed print job is still in your computer's print queue, delete it. • Otherwise, double-click the printer icon in the following folder and cancel all documents: <ul style="list-style-type: none"> - Windows® 7 Click  (Start) > Devices and Printers > Printers and Faxes. 	Wired/Wireless

Cause	Action	Interface
	<ul style="list-style-type: none"> - Windows® 8 Move your mouse to the lower right corner of your desktop. When the menu bar appears, click Settings > Control Panel. In the Hardware and Sound group, click View devices and printers > Printers. - Windows® 10 and Windows Server® 2016 Click  > Windows System > Control Panel. In the Hardware and Sound group, click View devices and printers > Printers. - Windows Server® 2008 Click Start > Control Panel > Printers. - Windows Server® 2012 Move your mouse to the lower right corner of your desktop. When the menu bar appears, click Settings > Control Panel. In the Hardware group, click View devices and printers > Printers. - Windows Server® 2012 R2 Click Control Panel on the Start screen. In the Hardware group, click View devices and printers. - macOS v10.10.5, v10.11.x, v10.12 Click System Preferences > Printers & Scanners. 	
Your Brother machine is not connected to the wireless network.	Print the WLAN Report to check the error code on the printed report.	Wireless

If you have checked and tried all of the above, but your Brother machine still cannot print and scan, uninstall the Brother software and drivers and reinstall them.



Related Information

- [Network Problems](#)
- [Print the WLAN Report](#)
- [Wireless LAN Report Error Codes](#)
- [Use the Network Connection Repair Tool \(Windows®\)](#)
- [I Want to Check that My Network Devices are Working Correctly](#)

I Want to Check that My Network Devices are Working Correctly

Check	Action	Interface
Check that your Brother machine, access point/router, or network hub is turned on.	<p>Check the following:</p> <ul style="list-style-type: none"> The power cord is connected correctly and the Brother machine is turned on. The access point/router or hub is turned on and its link button is blinking. All protective packaging has been removed from the machine. The toner cartridge and drum unit are installed correctly. The front and back covers are fully closed. Paper is inserted correctly in the paper tray. (For wired networks) A network cable is securely connected to the Brother machine and to the router or hub. 	Wired/Wireless
Check the Link Status in the Network Configuration Report.	Print the Network Configuration Report and check that Ethernet Link Status or Wireless Link Status is Link OK .	Wired/Wireless
Check that you can "ping" the Brother machine from your computer.	<p>Ping the Brother machine from your computer using the IP address or the node name in the Windows® command prompt or Macintosh Terminal application:</p> <p>ping <ipaddress> or <nodename>.</p> <ul style="list-style-type: none"> Successful: Your Brother machine is working correctly and connected to the same network as your computer. Unsuccessful: Your Brother machine is not connected to the same network as your computer. <p>(Windows®) Ask the network administrator and use the Network Connection Repair Tool to fix the IP address and the subnet mask.</p> <p>(Macintosh) Confirm that the IP address and the Subnet Mask are set correctly.</p>	Wired/Wireless
Check that your Brother machine is connected to the wireless network.	Print the WLAN Report to check the error code on the printed report.	Wireless

If you have checked and tried all of the above but you are still having problems, see the instructions supplied with your wireless LAN access point/router to find the SSID and the Network Key information and set them correctly.



Related Information

- [Network Problems](#)
- [Print the Network Configuration Report](#)
- [Print the WLAN Report](#)
- [Wireless LAN Report Error Codes](#)
- [Use the Network Connection Repair Tool \(Windows®\)](#)
- [My Brother Machine Cannot Print, Scan, or PC-FAX Receive over the Network](#)

Google Cloud Print Problems

Difficulty	Suggestions
My Brother machine is not displayed in the printer list.	Make sure your machine is turned on.
	Confirm that Google Cloud Print™ is enabled.
	Confirm that your machine is registered with Google Cloud Print™. If it is not registered, try to register again.
I cannot print.	Make sure your machine is turned on.
	Confirm your network settings. See <i>Related Information</i> .
	Certain files may not be printable, or may not appear exactly as they are displayed.
I cannot register my Brother machine with Google Cloud Print™.	Make sure your machine is connected to a network with Internet access.
	Verify that the date and time are set correctly on your machine.
I do not see a confirmation message on my Brother machine when I try to register with Google Cloud Print™, even after repeating the registration steps.	Make sure your Brother machine is idle while you are registering with Google Cloud Print™.



Related Information

- [Troubleshooting](#)
- [Network Settings for Using Google Cloud Print](#)







AirPrint Problems

Difficulty	Suggestions
My Brother machine is not displayed in the printer list.	Make sure your Brother machine is turned on.
	Confirm the network settings. See <i>Related Information</i> .
	Move the mobile device closer to the wireless access point/router, or to your Brother machine.
I cannot print.	Make sure your Brother machine is turned on.
	Confirm the network settings. See <i>Related Information</i> .
I am trying to print a multiple-page document from an Apple device, but ONLY the first page is printing.	Make sure you are running the latest version of iOS. Refer to the following Apple support article for more information about AirPrint: support.apple.com/kb/HT4356 .

Related Information

- [Troubleshooting](#)
- [AirPrint Overview](#)

Other Problems

Difficulties	Suggestions
<p>The machine will not turn on.</p>	<p>Adverse conditions on the power connection (such as lightning or a power surge) may have triggered the machine's internal safety mechanisms. Unplug the power cord. Wait for ten minutes, then plug in the power cord and press  to turn on the machine.</p> <p>If the problem is not solved, press and hold  to turn off the machine. If you are using a backup battery or surge suppressor device, disconnect it to make sure it is not the problem. Plug the machine's power cord directly into a different known working wall outlet and press  to turn on the machine.</p>
<p>The machine cannot print EPS data that includes binary with the BR-Script3 printer driver.</p>	<p>(Windows®)</p> <p>To print EPS data, do the following:</p> <ol style="list-style-type: none"> For Windows® 7 and Windows Server® 2008 R2: Click the  Start button > Devices and Printers. For Windows Server® 2008: Click the  (Start) button > Control Panel > Hardware and Sound > Printers. For Windows® 8 and Windows Server® 2012: Move your mouse to the lower right corner of your desktop. When the menu bar appears, click Settings > Control Panel. In the Hardware and Sound¹ group, click View devices and printers. For Windows® 10 and Windows Server® 2016: Click  > Windows System > Control Panel. In the Hardware and Sound group, click View devices and printers. For Windows Server® 2012 R2: Click Control Panel on the Start screen. In the Hardware group, click View devices and printers. Right-click the Brother XXX-XXXX BR-Script3 icon, select Printer properties. From the Device Settings tab, choose TBCP (Tagged binary communication protocol) in Output Protocol. <p>(Macintosh)</p> <p>If your machine is connected to a computer with a USB interface, you cannot print EPS data that includes binary. You can print the EPS data at the machine through a network. For help installing the BR-Script3 printer driver through the network, go to the Brother Solutions Center at support.brother.com.</p>
<p>The Brother software cannot be installed.</p>	<p>(Windows®)</p> <p>If the Security Software warning appears on the computer screen during the installation, change the Security Software settings to permit the Brother product setup program or other program to run.</p> <p>(Macintosh)</p>

Difficulties	Suggestions
	If you are using a firewall function of anti-spyware or antivirus security software, temporarily disable it and then install the Brother software.

¹ For Windows Server® 2012: **Hardware and Sound**

Copying difficulties

Difficulties	Suggestions
Cannot make a copy.	Make sure you pressed Copy and the machine is in Copy mode. Contact your administrator to check your Secure Function Lock Settings.
Vertical black line appears in copies.	Black vertical lines on copies are typically caused by dirt or correction fluid on the glass strip, or the corona wires are dirty. Clean the glass strip and scanner glass and the white bar and white plastic above them.
Copies are blank.	Make sure you are loading the document correctly.

Scanning difficulties

Difficulties	Suggestions
TWAIN or WIA errors appear when starting to scan. (Windows®)	Make sure the Brother TWAIN or WIA driver is selected as the primary source in your scanning application. For example, in Nuance™ PaperPort™ 14SE, click Desktop > Scan Settings > Select to choose the Brother TWAIN/WIA driver.
TWAIN or ICA errors appear when starting to scan. (Macintosh)	Make sure the Brother TWAIN driver is selected as the primary source. You can also scan documents using the ICA Scanner Driver.
OCR does not work.	Try increasing the scanning resolution.
Cannot scan.	Contact your administrator to check your Secure Function Lock Settings.

Software difficulties

Difficulties	Suggestions
Cannot install software or print.	(Windows®) Run the install program again. This program will repair and reinstall the software.



Related Information

- [Troubleshooting](#)

Check the Machine Information

Follow these instructions to check your Brother machine's serial number and firmware version.

1. Press  [Settings] > [All Settings] > [Machine Info.].



If your machine displays the [All Settings] menu on the Home screen, skip the [Settings] menu.

2. Press one of the following options:

Option	Description
Serial No.	Check your machine's serial number.
Firmware Version	Check your machine's firmware version.
Page Counter	Check the number of total pages the machine has printed.
Parts Life	Check the percentage of the supplies' life that remains available.

3. Press .



Related Information

- [Troubleshooting](#)

Reset Your Brother Machine

1. Press  [Settings] > [All Settings] > [Initial Setup] > [Reset].



If your machine displays the [All Settings] menu on the Home screen, skip the [Settings] menu.

2. Swipe up or down or press ▲ or ▼ to display the type of reset functions, and then press the reset function you want to use.



- The network settings, the security settings and address book data will not be reset by the [Machine Reset].
- If you discard or transfer the machine, we recommend accomplishment of the [Factory Reset] to erase the personal data in the machine.

3. [Machine will reboot after resetting. Press [OK] for 2 seconds to confirm.] appears. Press [OK] for two seconds to confirm.

The machine will restart.

4. Press .



You can also reset the Network settings by pressing  [Settings] > [All Settings] > [Network] > [Network Reset].



Related Information

- [Troubleshooting](#)
- [Reset Functions Overview](#)

Reset Functions Overview

The following reset functions are available:



Unplug the interface cable before you choose Network Settings Reset function, All Settings Reset function or Factory Reset function.

1. Machine Reset

Reset all the machine's settings that you have changed, such as Date and Time and Ring Delay.

The Address Book, fax reports, and Call history will remain. (For MFC Models)

2. Network Settings Reset (For Network Models)

Reset the print server back to its default factory settings (includes Password and IP Address information).

3. Address Book and Fax Settings Reset (For MFC Models)

This function resets the following settings:

- Address Book
(Addresses and Groups)
- Programmed fax jobs in the memory
(Delayed Fax)
- Station ID
(name and number)
- Coverpage Message
- Fax receive settings
(Remote Access Code, Fax Storage, Fax Forwarding, Paging, and PC-Fax Receive (Windows® only))
- Report
(Transmission Verification Report / Tel Index List / Fax Journal)
- Setting Lock password

4. All Settings Reset

Reset all the machine's settings back to the settings that were set at the factory.

All Settings Reset takes less time than Factory Reset.

5. Factory Reset

Use the Settings Reset function to reset all machine's settings to the settings originally set at the factory.

Factory Reset takes more time than All Settings Reset.

Brother strongly recommends you perform this operation when you dispose of the machine.



Unplug the interface cable before you choose Network Settings Reset function, All Settings Reset function or Factory Reset function.



Related Information

- [Reset Your Brother Machine](#)

Routine Maintenance

- [Replace Supplies](#)
- [Clean the Machine](#)
- [Calibrate Color Output](#)
- [Correct Color Print Alignment \(Color Registration\)](#)
- [Check the Remaining Part Life](#)
- [Pack and Ship Your Brother Machine](#)
- [Replace Periodic Maintenance Parts](#)

Replace Supplies

You must replace supplies when the machine indicates that the life of the supply is over.

Using non-Brother supplies may affect the print quality, hardware performance, and machine reliability. The toner cartridge and drum unit are two separate supplies. Make sure both are installed as an assembly. The order number of supplies may vary depending on the country.

NOTE

- Be sure to seal up the used supplies tightly in a bag so that toner powder does not spill out of the cartridge.
- Visit www.brother.com/original/index.html for instructions on how to return your used supplies to the Brother collection program. If you choose not to return your used supply, discard the used supply according to local regulations, keeping it separate from domestic waste. If you have questions, contact your local waste disposal office.
- We recommend placing used and new supplies on a piece of paper to prevent accidentally spilling or scattering the material inside.
- If you use paper that is not a direct equivalent for the recommended print media, the life of supplies and machine parts may be reduced.
- The projected life for each of the toner cartridges is based on ISO/IEC 19798. Frequency of replacement will vary depending on the print volume, percentage of coverage, types of media used, and powering on/off the machine.
- Frequency of replacing supplies except toner cartridges will vary depending on the print volume, types of media used, and powering on/off the machine.
- Handle the toner cartridge carefully. If toner scatters on your hands or clothes, immediately wipe or wash it off with cold water.
- To avoid print quality problems, DO NOT touch the shaded parts shown in the illustrations.

Toner cartridge

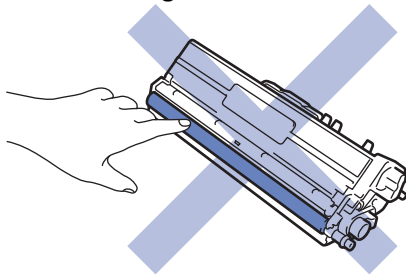

Drum unit

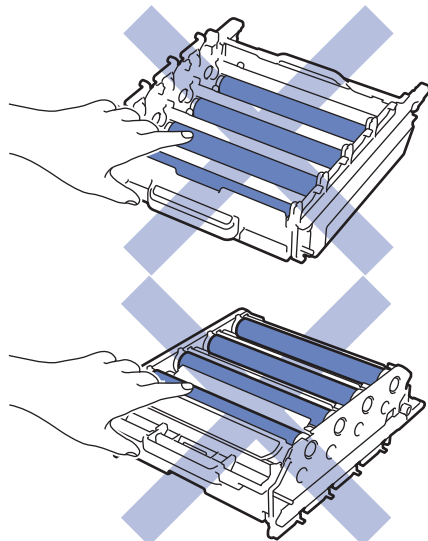

Belt unit

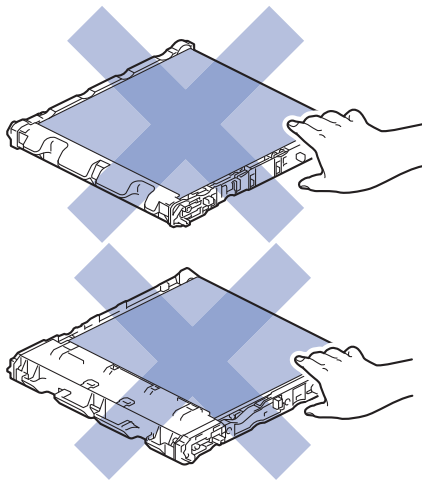

Waste toner box

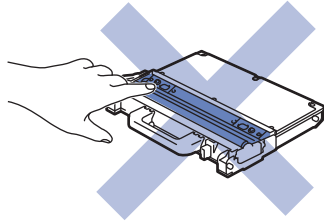

Related Information

- [Routine Maintenance](#)
 - [Replace the Toner Cartridge](#)
 - [Replace the Drum Unit](#)
 - [Replace the Belt Unit](#)
 - [Replace the Waste Toner Box](#)
 - [Reset the Drum Counter](#)
 - [Reset the Belt Unit Counter](#)
 - [Error and Maintenance Messages](#)
 - [Supplies](#)
-

Replace the Toner Cartridge

Before starting the replacement procedure, see *Related Information: Replace Supplies*.

1. Make sure the machine is turned on.
2. Press the front cover release button and pull open the front cover.

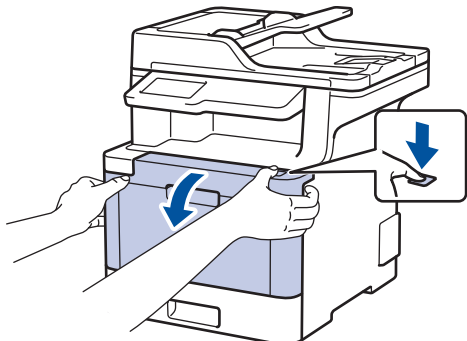

3. Hold the drum unit's green handle. Pull the drum unit out of the machine until it stops.

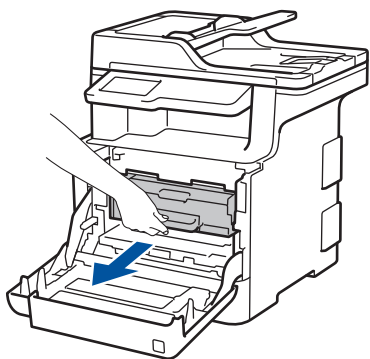

4. Hold the handle of the toner cartridge and gently push it away from you to unlock it. Pull it up and out of the drum unit. Repeat this for all toner cartridges.

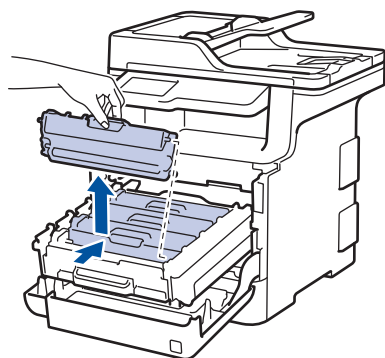

5. Clean the corona wire inside the drum unit by gently sliding the green tab from left to right and right to left several times. Repeat this for all the corona wires.

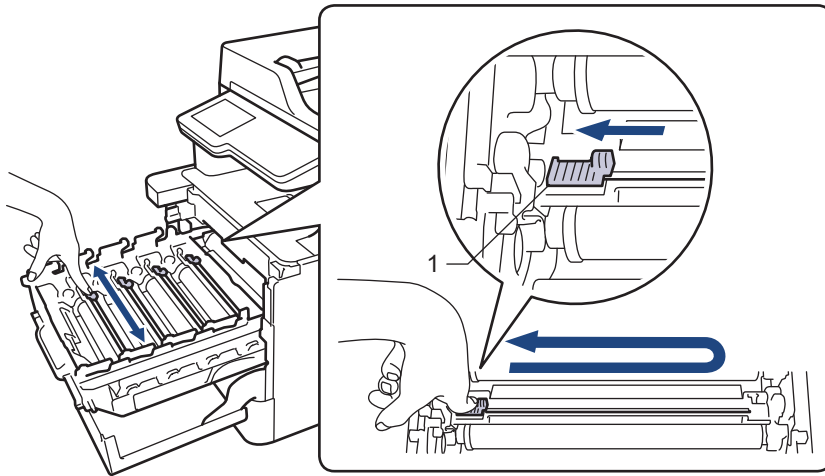

 To avoid poor print quality, be sure to lock the green tab into the home position (1), flush left with the left side of the drum.

6. Unpack the new toner cartridge.
7. Remove the protective cover.

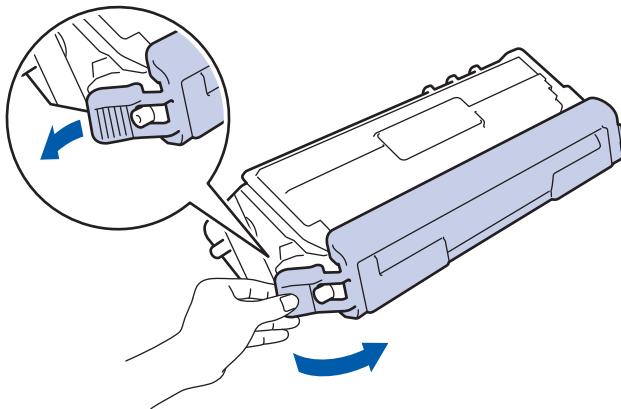

8. Insert the toner cartridge into the drum unit and gently pull it toward you until you hear it lock into place. Make sure that you match the toner cartridge color to the same color label on the drum unit. Repeat this for all toner cartridges.

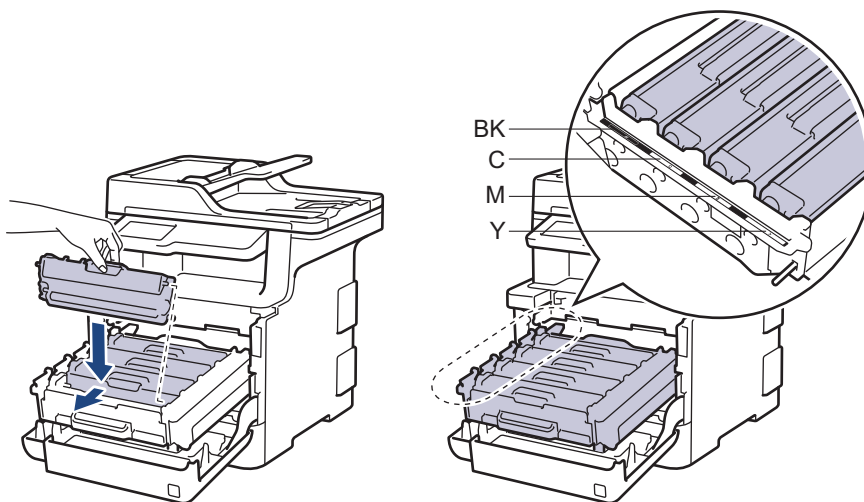

- BK: Black
- C: Cyan
- M: Magenta
- Y: Yellow

 Make sure you put the toner cartridge in correctly or it may separate from the drum unit.

9. Using the green handle, push the drum unit back into the machine until it locks in place.

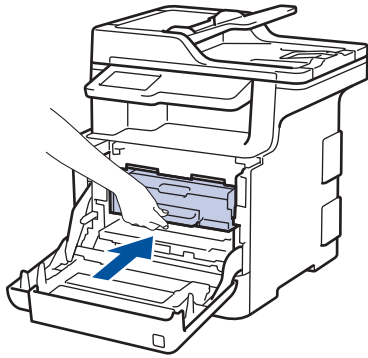

10. Close the machine's front cover.



- After replacing a toner cartridge, DO NOT turn off the machine or open the front cover until the machine's display returns to Ready Mode.
- The toner cartridge that comes with your Brother machine is a Starter toner cartridge.
- We recommend keeping a new toner cartridge ready for use when you see the Toner Low warning.
- To ensure high quality printing, we recommend using only Genuine Brother Brand toner cartridges. When you want to buy toner cartridges, contact Brother Customer Service.
- DO NOT unpack the new toner cartridge until you are ready to install it.
- If a toner cartridge is left unpacked for a long time, the toner life will be shortened.
- Brother strongly recommends you DO NOT refill the toner cartridge provided with your machine. We also strongly recommend you continue to use only Genuine Brother Brand replacement toner cartridges. Use or attempted use of third-party toner and/or cartridges in the Brother machine may cause damage to the machine and/or may result in unsatisfactory print quality. Our limited warranty coverage does not apply to any problem that is caused by the use of third party toner and/or cartridges. To protect your investment and obtain premium performance from the Brother machine, we strongly recommend the use of Genuine Brother Supplies.



Related Information

- [Replace Supplies](#)
- [Improve the Print Quality](#)

Replace the Drum Unit

Before starting the replacement procedure, see *Related Information: Replace Supplies*.

1. Make sure the machine is turned on.
2. Press the front cover release button and pull open the front cover.

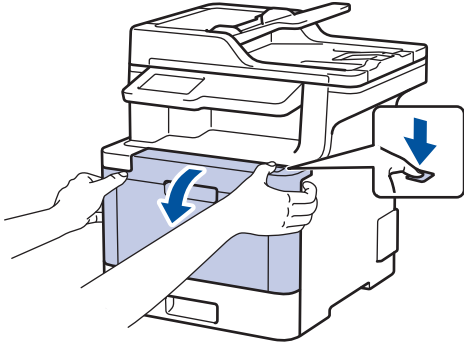

3. Hold the drum unit's green handle. Pull the drum unit out of the machine until it stops.

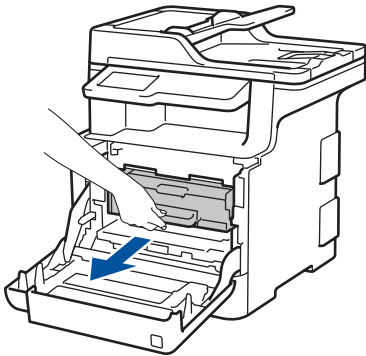

4. Turn the green lock lever (1) counterclockwise until it locks in the release position. Holding the green handles of the drum unit, lift the front of the drum unit and remove it from the machine.

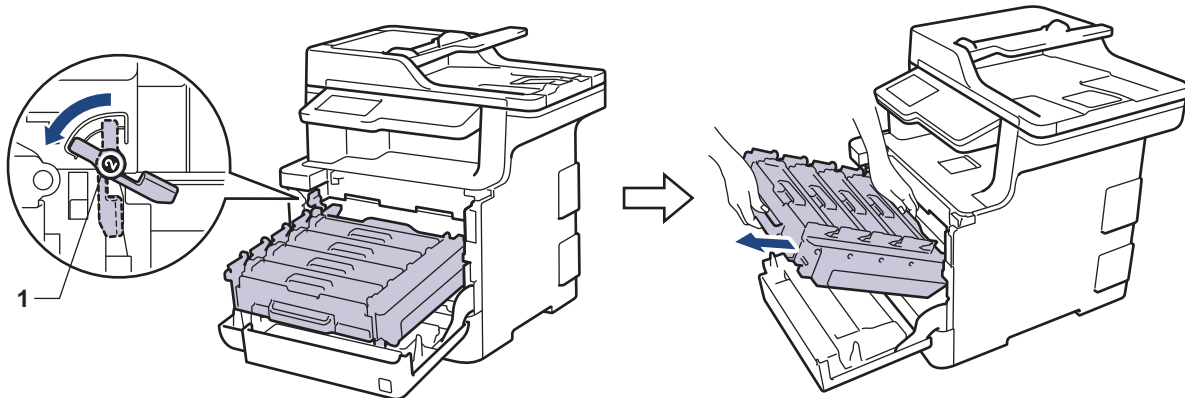

IMPORTANT

Hold the green handles of the drum unit when you carry it. DO NOT hold the sides of the drum unit.

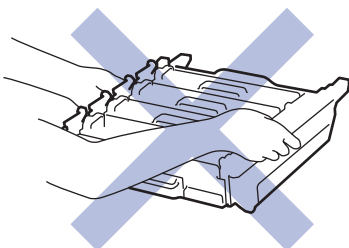

5. Unpack the new drum unit.

6. Remove the protective cover.

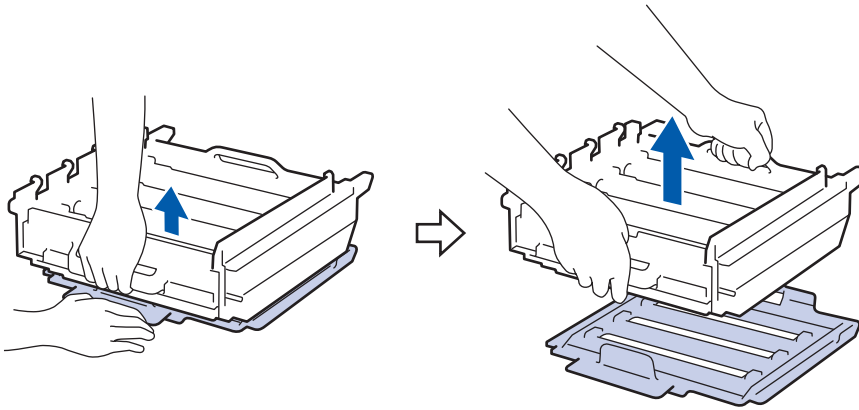

7. Hold the handle of the toner cartridge and gently push it away from you to unlock it. Pull it up and out of the drum unit. Repeat this for all toner cartridges.

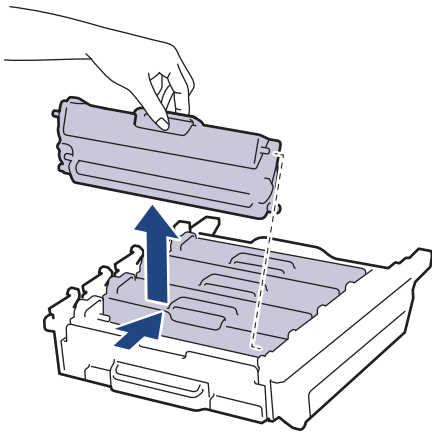

8. Reinsert the toner cartridge into the new drum unit and gently pull it toward you until you hear it lock into place. Make sure that you match the toner cartridge color to the same color label on the drum unit. Repeat this for all toner cartridges.

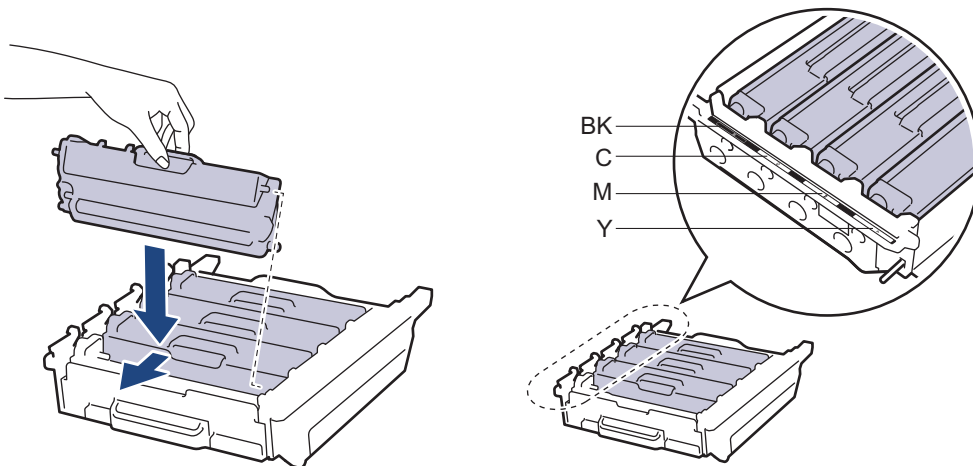

- BK: Black
- C: Cyan
- M: Magenta
- Y: Yellow



Make sure you put the toner cartridge in correctly or it may separate from the drum unit.

9. Make sure the green lock lever (1) is in the release position, as shown in the illustration.

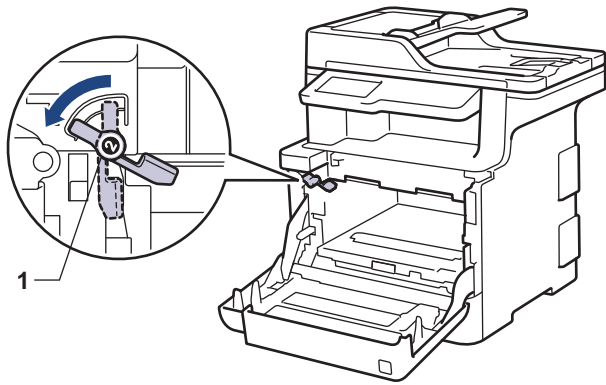

10. Gently slide the drum unit into the machine until it stops at the green lock lever.

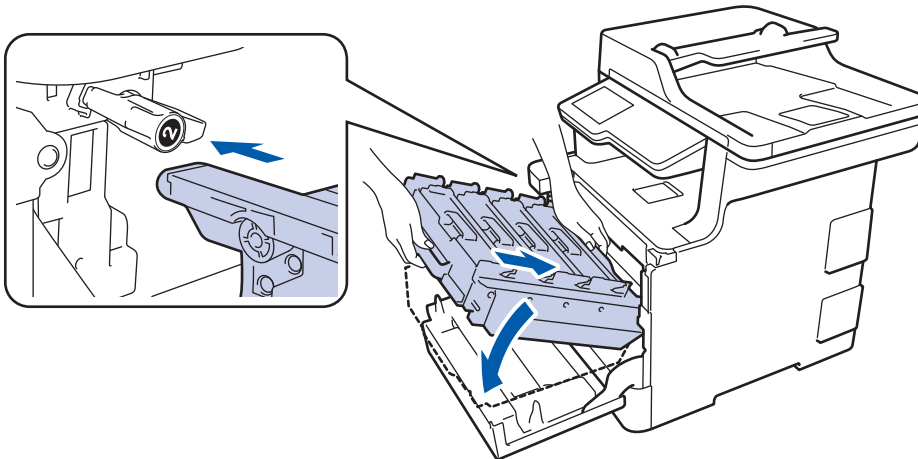

11. Turn the green lock lever clockwise to the lock position.

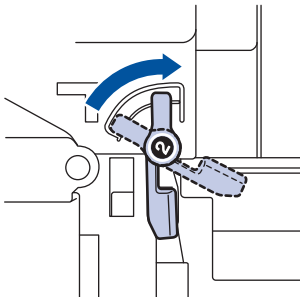

12. Using the green handle, push the drum unit back into the machine until it locks in place.

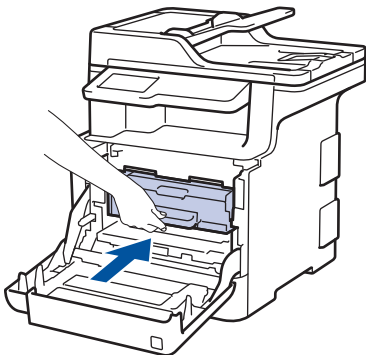

13. Close the machine's front cover.



After installing the new drum unit, you must reset the drum counter. See *Related Information: Reset the Drum Counter*.

NOTE

- Drum wear and tear occurs due to use and rotation of the drum and interaction with paper, toner and other materials in the paper path. In designing this product, Brother decided to use the number of

rotations of the drum as a reasonable determinant of the drum life. When a drum reaches the factory-established rotation limit corresponding to the rated page yield, the product's LCD will advise you to replace the drum. The product will continue to function; however, print quality may not be optimal.

- If an unpacked drum unit is placed in direct sunlight (or room light for long periods of time), the unit may be damaged.
- There are many factors that determine the actual drum life, such as the temperature, humidity, type of paper, type of toner used and so on. Under ideal conditions, the average drum life is estimated at approximately 30,000 pages based on 1 page per job and 50,000 pages based on 3 pages per job [A4/letter simplex pages]. The number of pages may be affected due to a variety of factors including but not limited to media type and media size.

Because we have no control over the many factors that determine the actual drum life, we cannot guarantee a minimum number of pages that will be printed by your drum.

- For best performance, use only genuine Brother toner.
- The machine should be used only in a clean, dust-free environment with adequate ventilation.

Printing with a non-Brother drum unit may reduce not only the print quality but also the quality and life of the machine itself. Warranty coverage does not apply to problems caused by the use of a non-Brother drum unit.



Related Information

- [Replace Supplies](#)
 - [Error and Maintenance Messages](#)
 - [Improve the Print Quality](#)
 - [Reset the Drum Counter](#)
-

Replace the Belt Unit

Before starting the replacement procedure, see *Related Information: Replace Supplies*.

1. Make sure the machine is turned on.
2. Press the front cover release button and pull open the front cover.

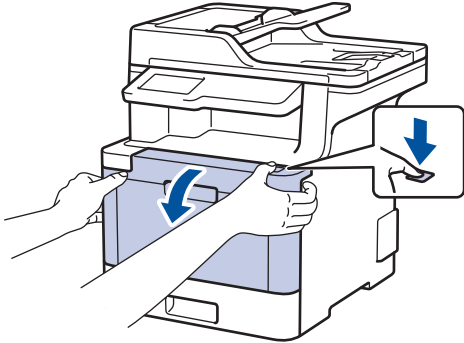

3. Hold the drum unit's green handle. Pull the drum unit out of the machine until it stops.

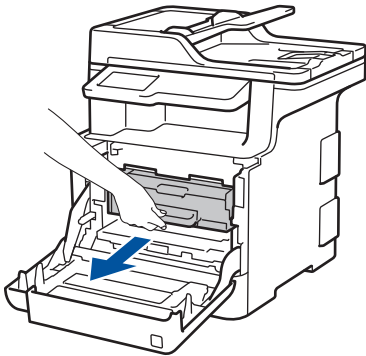

4. Turn the green lock lever (1) counterclockwise until it locks in the release position. Holding the green handles of the drum unit, lift the front of the drum unit and remove it from the machine.

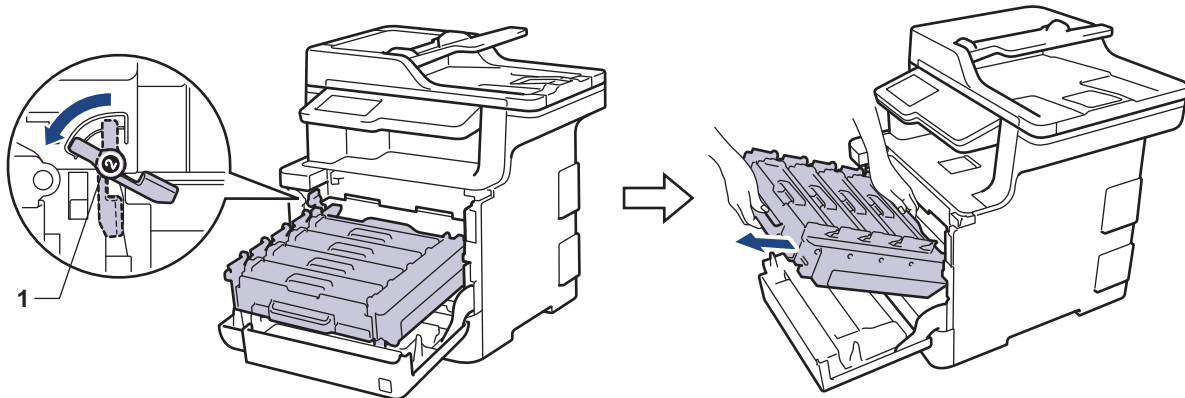

IMPORTANT

Hold the green handles of the drum unit when you carry it. **DO NOT** hold the sides of the drum unit.

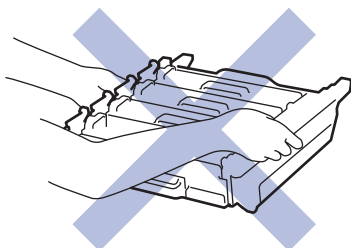

5. Hold the green handle of the belt unit with both hands and lift the belt unit up, then pull it out.

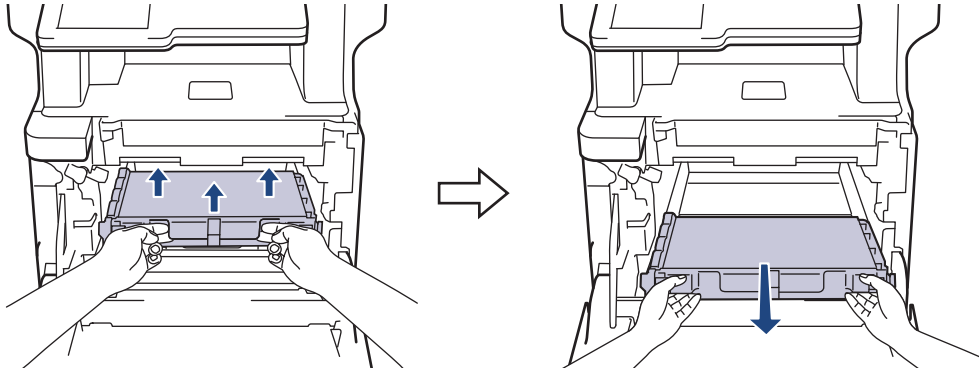

6. Unpack the new belt unit and install the new belt unit in the machine. Make sure the belt unit is level and fits firmly into place.

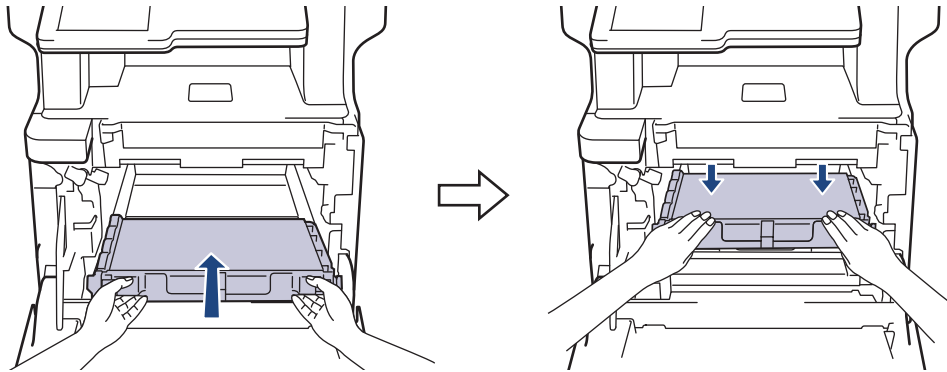

NOTE

To avoid print quality problems, DO NOT touch the shaded parts shown in the illustrations.

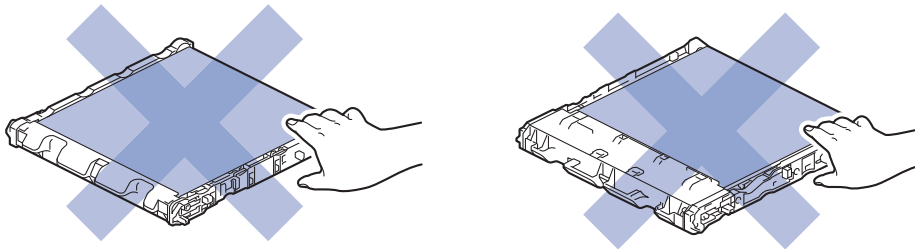

7. Make sure the green lock lever (1) is in the release position, as shown in the illustration.

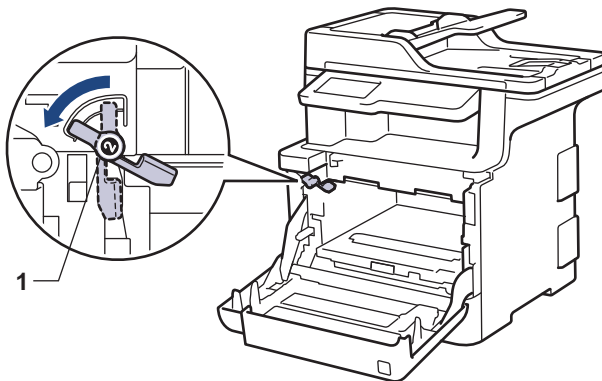

8. Gently slide the drum unit into the machine until it stops at the green lock lever.

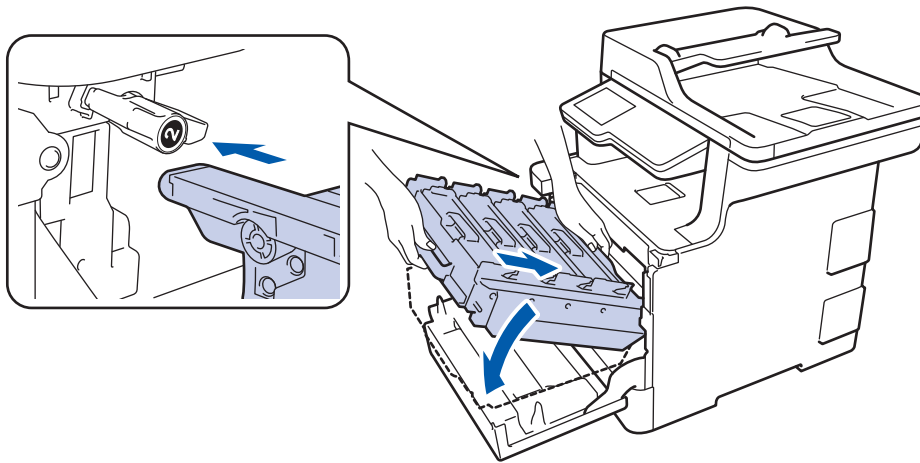

9. Turn the green lock lever clockwise to the lock position.

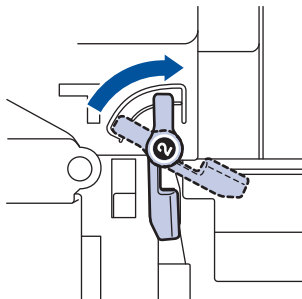

10. Using the green handle, push the drum unit back into the machine until it locks in place.

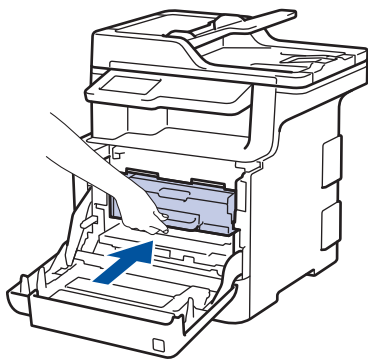

11. Close the machine's front cover.



After installing the new belt unit, you must reset the counter. See *Related Information: Reset the Belt Unit Counter*.



Related Information

- [Replace Supplies](#)
- [Improve the Print Quality](#)
- [Reset the Belt Unit Counter](#)

Replace the Waste Toner Box

Before starting the replacement procedure, see *Related Information: Replace Supplies*.

1. Make sure the machine is turned on.
2. Press the front cover release button and pull open the front cover.

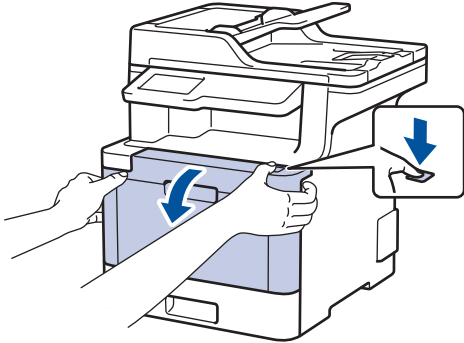

3. Hold the drum unit's green handle. Pull the drum unit out of the machine until it stops.

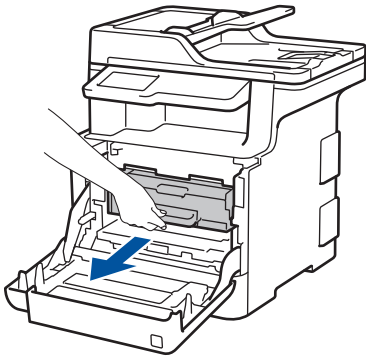

4. Turn the green lock lever (1) counterclockwise until it locks in the release position. Holding the green handles of the drum unit, lift the front of the drum unit and remove it from the machine.

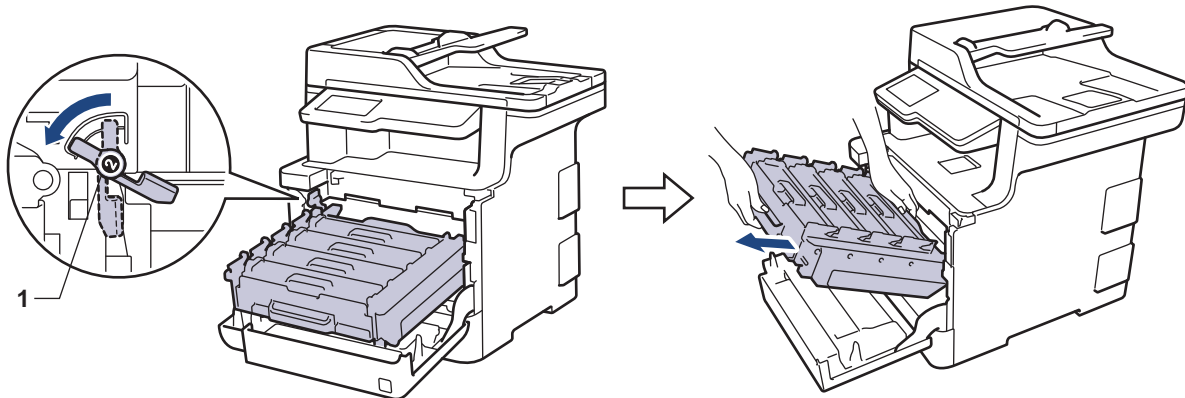

IMPORTANT

Hold the green handles of the drum unit when you carry it. **DO NOT** hold the sides of the drum unit.

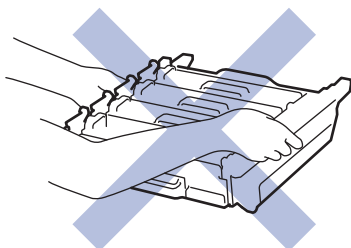

5. Hold the green handle of the belt unit with both hands and lift the belt unit up, then pull it out.

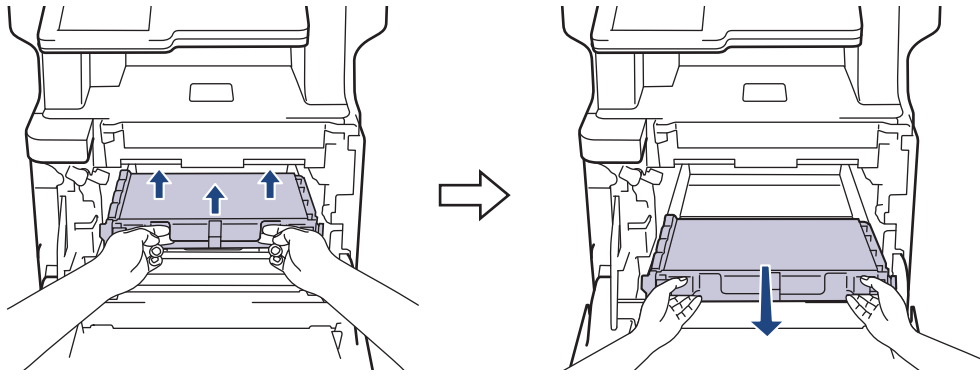

NOTE

To avoid print quality problems, DO NOT touch the shaded parts shown in the illustrations.

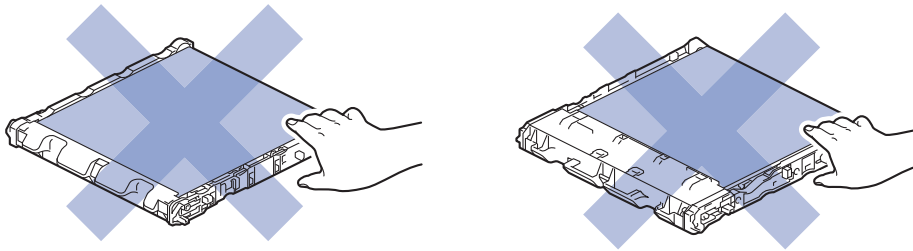

6. Remove the two pieces of orange packing material and discard them.

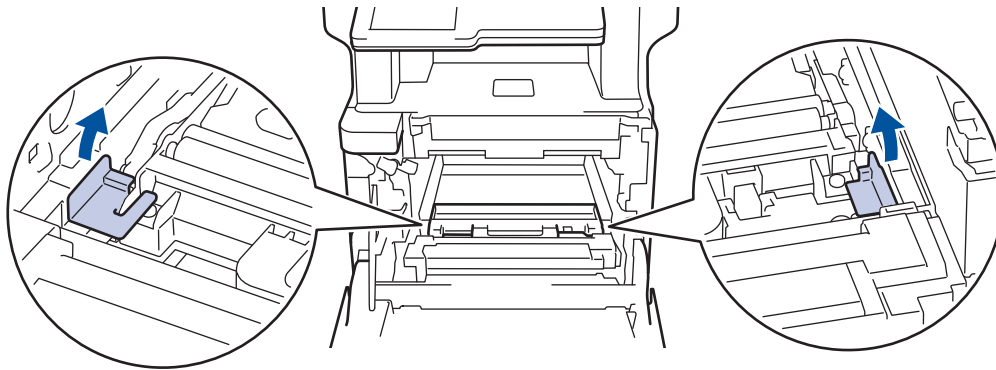

This step is only necessary when you are replacing the waste toner box for the first time, and is not required for the replacement waste toner box. The orange packing pieces are installed at the factory to protect your machine during shipment.

7. Hold the blue handle of the waste toner box and remove the waste toner box from the machine.

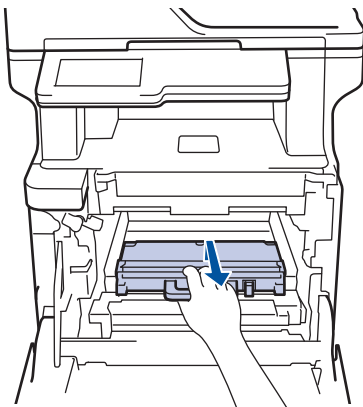

DO NOT reuse the waste toner box.

8. Unpack the new waste toner box and install the new waste toner box in the machine using the blue handle. Make sure the waste toner box is level and fits firmly into place.

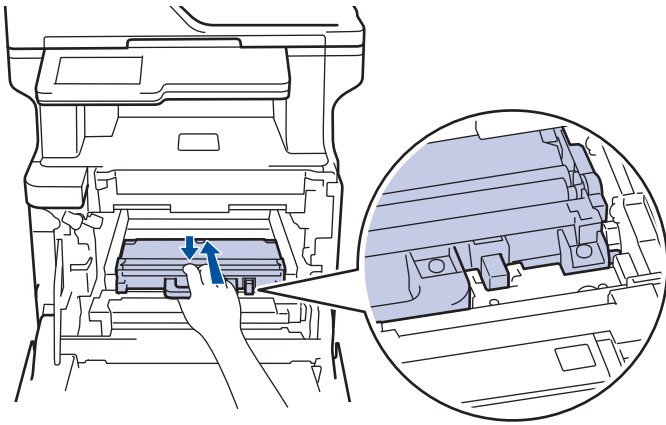

9. Slide the belt unit back into the machine. Make sure the belt unit is level and fits firmly into place.

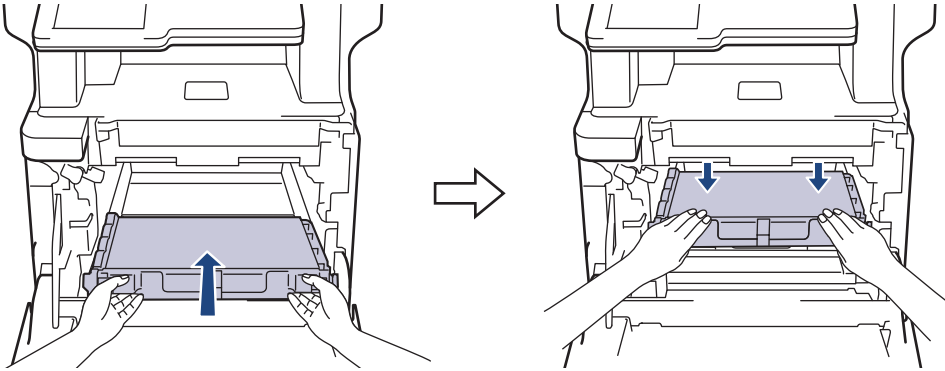

NOTE

To avoid print quality problems, DO NOT touch the shaded parts shown in the illustrations.

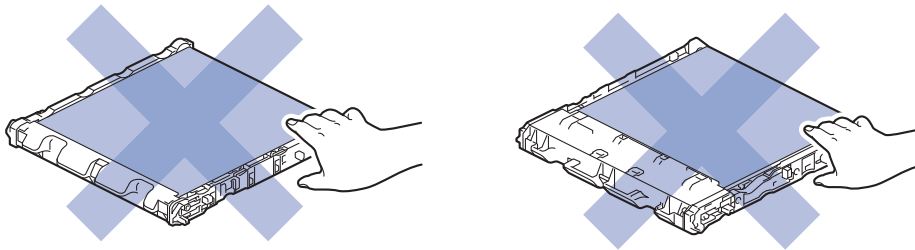

10. Make sure the green lock lever (1) is in the release position, as shown in the illustration.

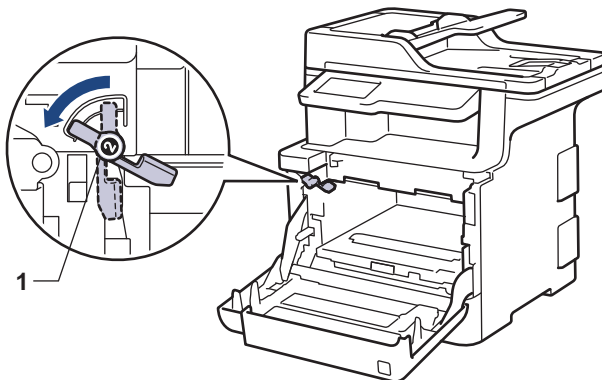

11. Gently slide the drum unit into the machine until it stops at the green lock lever.

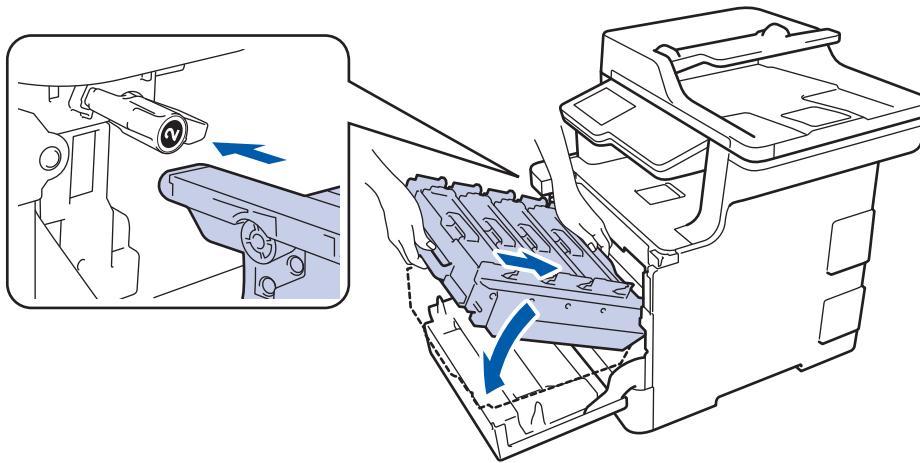

12. Turn the green lock lever clockwise to the lock position.

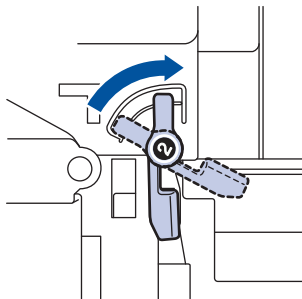

13. Using the green handle, push the drum unit back into the machine until it locks in place.

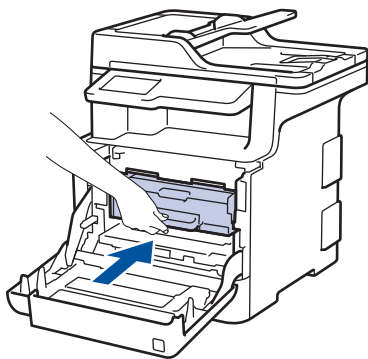

14. Close the machine's front cover.



Related Information

- [Replace Supplies](#)

Reset the Drum Counter

When you replace the drum unit with a new one, you must reset the drum counter by completing the following steps:

IMPORTANT

DO NOT reset the drum counter unless you are replacing the drum unit.

1. Make sure the machine is turned on.
2. Press  [Settings] > [All Settings] > [Machine Info.] > [Parts Life].



If your machine displays the [All Settings] menu on the Home screen, skip the [Settings] menu.

3. Press and hold [Drum] until the Touchscreen message changes.
4. Press [Yes].
5. Press .



Related Information

- [Replace Supplies](#)
- [Replace the Drum Unit](#)

Reset the Belt Unit Counter

When you replace a belt unit with a new one, you must reset the belt unit counter.

1. Make sure the machine is turned on.
2. Press  [Settings] > [All Settings] > [Machine Info.] > [Parts Life].



If your machine displays the [All Settings] menu on the Home screen, skip the [Settings] menu.

3. Press and hold [Belt] until the Touchscreen message changes.
4. Press [Yes].
5. Press .



Related Information

- [Replace Supplies](#)
- [Replace the Belt Unit](#)

Clean the Machine

Clean the outside and inside of the machine regularly with a dry, lint-free cloth.

When you replace the toner cartridge or the drum unit, make sure you clean the inside of the machine. If printed pages are stained with toner, clean the inside of the machine with a dry, lint-free cloth.

⚠ WARNING

- DO NOT use flammable substances, any type of spray, or an organic solvent/liquid containing alcohol or ammonia to clean the inside or outside of the product. Doing so could cause a fire. Instead, use only a dry, lint-free cloth.



IMPORTANT

- DO NOT use isopropyl alcohol to remove dirt from the control panel. It may crack the panel.
- To avoid print quality problems, DO NOT touch the shaded parts shown in the illustrations.

Toner cartridge

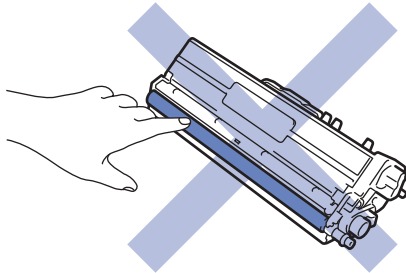

Drum unit

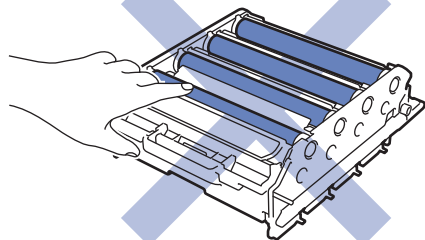
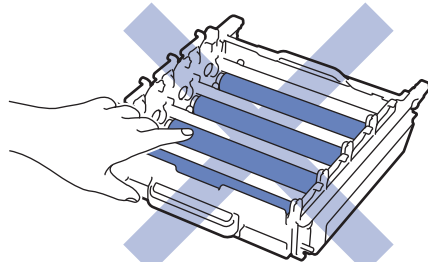

Belt unit

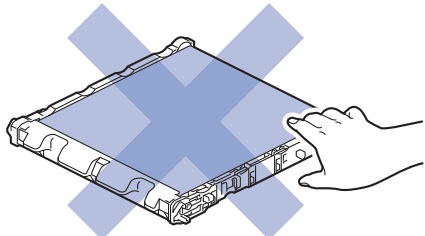

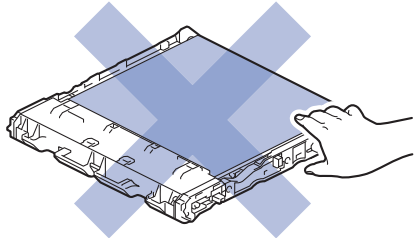

Waste toner box

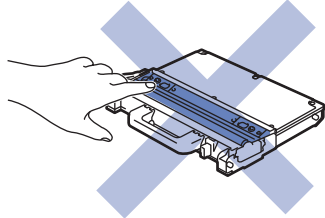

Related Information

- [Routine Maintenance](#)
 - [Clean the Scanner](#)
 - [Clean the Laser Scanner Windows](#)
 - [Clean the Touchscreen LCD](#)
 - [Clean the Corona Wires](#)
 - [Clean the Drum Unit](#)
 - [Clean the Paper Pick-up Rollers](#)
-

Clean the Scanner

1. Press and hold  to turn off the machine.
2. Lift the document cover (1). Clean the white plastic surface (2) and scanner glass (3) underneath it with a soft lint-free cloth moistened with water.

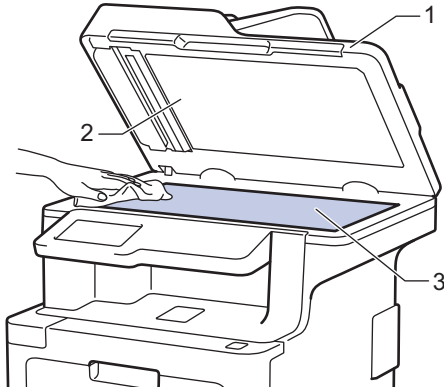

3. In the ADF unit, clean the white bar (1) and the scanner glass strip (2) underneath it with a soft lint-free cloth moistened with water.

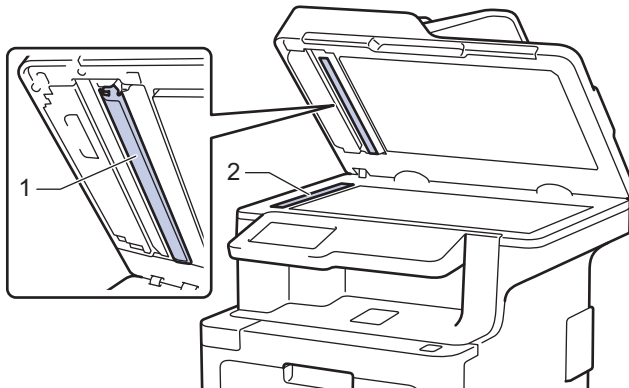

4. Open the scanner glass cover (1), and then clean the other white bar (2) and scanner glass strip (3) (supported models only).

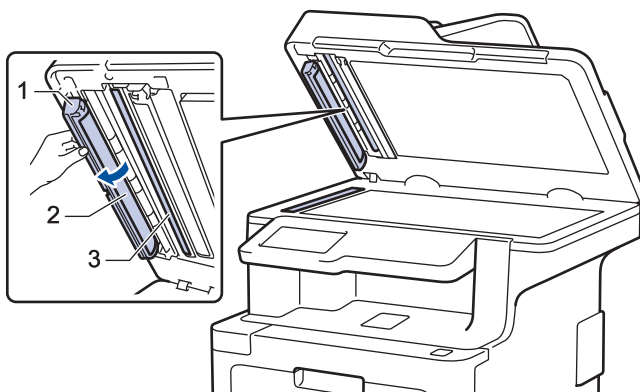

5. Close the document cover.
6. Press  to turn on the machine.

Related Information

- [Clean the Machine](#)

Clean the Laser Scanner Windows

1. Press and hold  to turn off the machine.
2. Press the front cover release button and pull open the front cover.

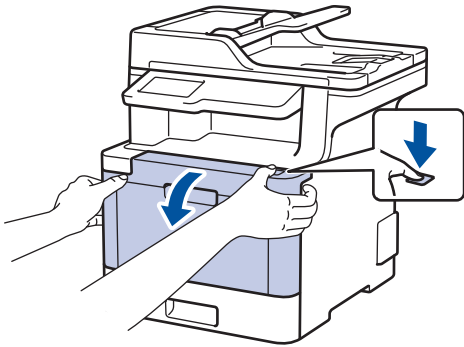

3. Hold the drum unit's green handle. Pull the drum unit out of the machine until it stops.

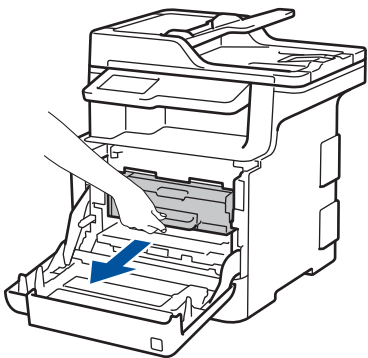

4. Turn the green lock lever (1) counterclockwise until it locks in the release position. Holding the green handles of the drum unit, lift the front of the drum unit and remove it from the machine.

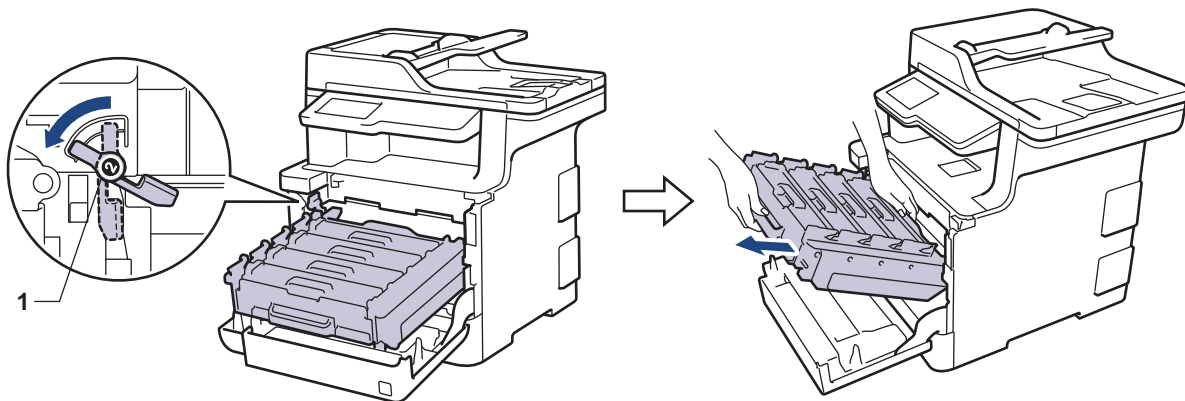

IMPORTANT

Hold the green handles of the drum unit when you carry it. DO NOT hold the sides of the drum unit.

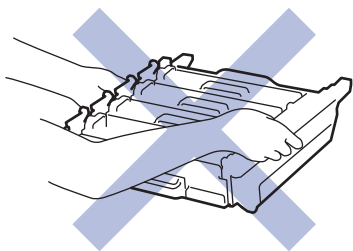

5. Wipe the four laser scanner windows (1) with a dry, soft, lint-free cloth.

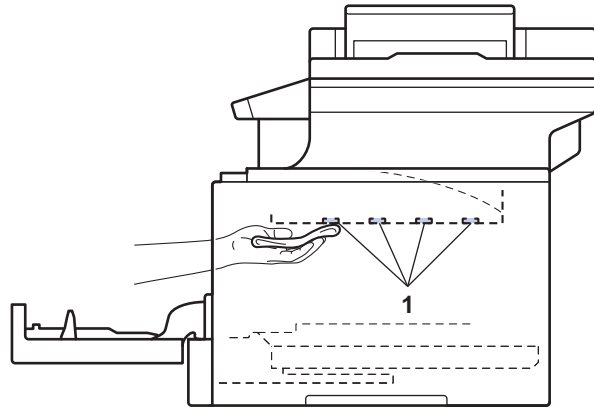
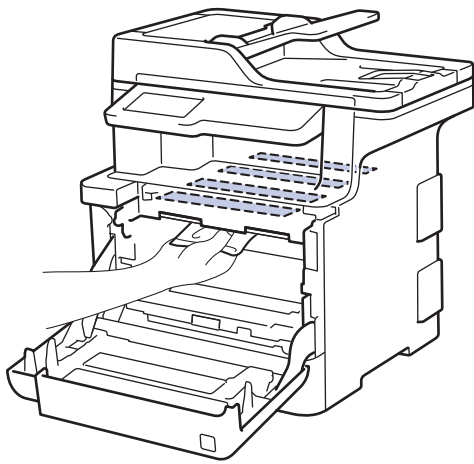

6. Make sure the green lock lever (1) is in the release position, as shown in the illustration.

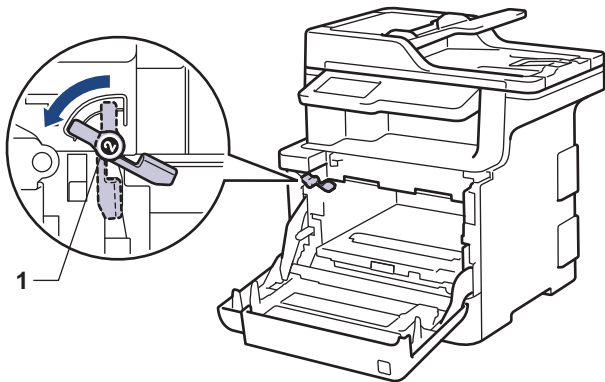

7. Gently slide the drum unit into the machine until it stops at the green lock lever.

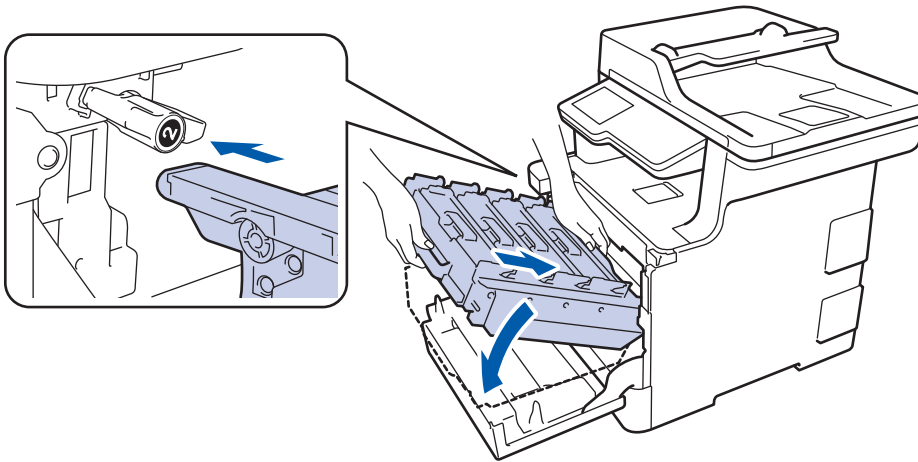

8. Turn the green lock lever clockwise to the lock position.

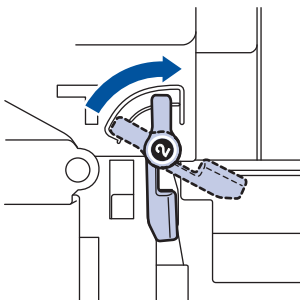

9. Using the green handle, push the drum unit back into the machine until it locks in place.

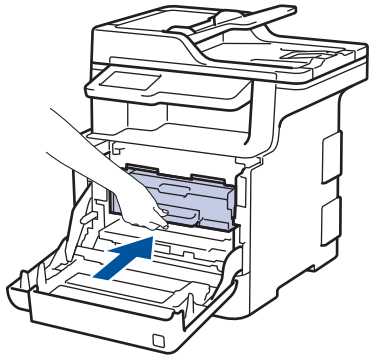

10. Close the machine's front cover.

11. Press  to turn on the machine.



Related Information

- [Clean the Machine](#)

Clean the Touchscreen LCD

IMPORTANT

DO NOT use any type of liquid cleaners (including ethanol).

1. Press and hold  to turn off the machine.
2. Clean the Touchscreen with a dry, soft lint-free cloth.

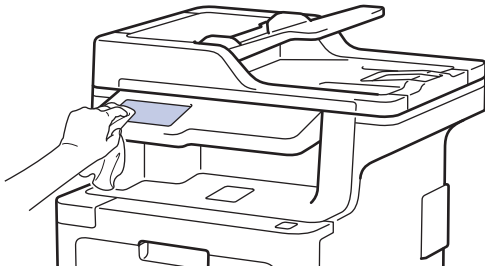

3. Press  to turn on the machine.



Related Information

- [Clean the Machine](#)

Clean the Corona Wires

1. Press the front cover release button and pull open the front cover.

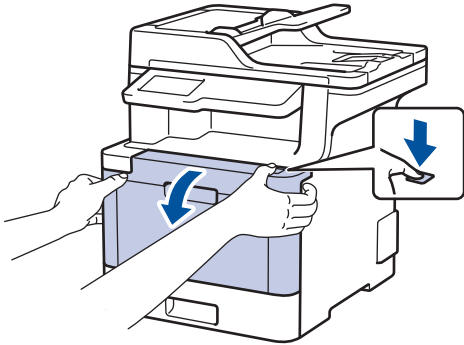

2. Hold the drum unit's green handle. Pull the drum unit out of the machine until it stops.

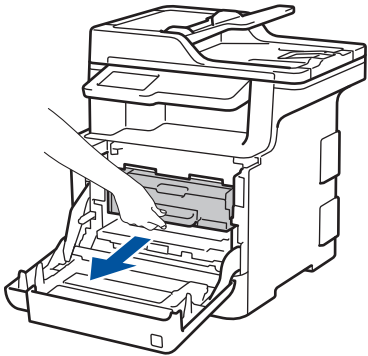

3. Hold the handle of the toner cartridge and gently push it away from you to unlock it. Pull it up and out of the drum unit. Repeat this for all toner cartridges.

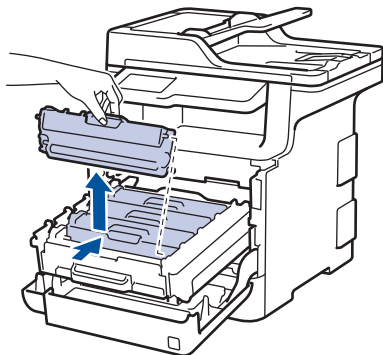

4. Clean the corona wire inside the drum unit by gently sliding the green tab from left to right and right to left several times. Repeat this for all the corona wires.

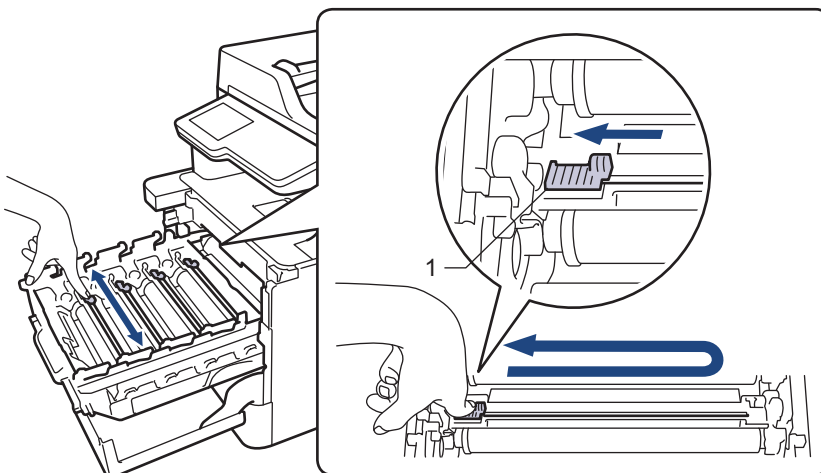



To avoid poor print quality, be sure to lock the green tab into the home position (1), flush left with the left side of the drum.

5. Insert the toner cartridge into the drum unit and gently pull it toward you until you hear it lock into place. Make sure that you match the toner cartridge color to the same color label on the drum unit. Repeat this for all toner cartridges.

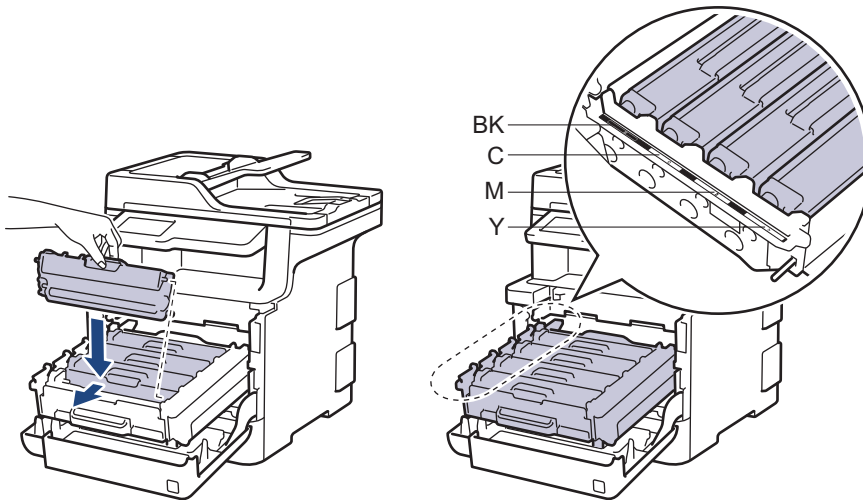

- BK: Black
- C: Cyan
- M: Magenta
- Y: Yellow



Make sure you put the toner cartridge in correctly or it may separate from the drum unit.

6. Using the green handle, push the drum unit back into the machine until it locks in place.

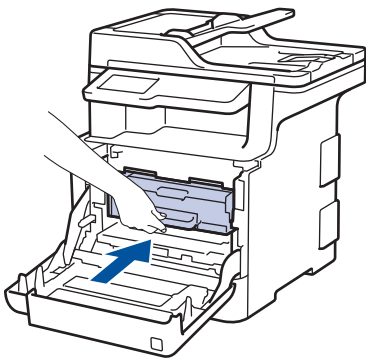

7. Close the machine's front cover.



Related Information

- [Clean the Machine](#)
- [Error and Maintenance Messages](#)

Clean the Drum Unit

If your printout has black or white dots or other repeating marks at 3.7 in. (94 mm) intervals, the drum may have foreign material, such as glue from a label, stuck on the drum surface.

1. Make sure the machine is in Ready Mode.
2. Press  [Settings] > [All Settings] > [Print Reports] > [Drum Dot Print].



If your machine displays the [All Settings] menu on the Home screen, skip the [Settings] menu.

3. Press [Yes].
The machine prints the Drum Dot Check Sheet.
4. Press and hold  to turn off the machine.
5. Press the front cover release button and pull open the front cover.

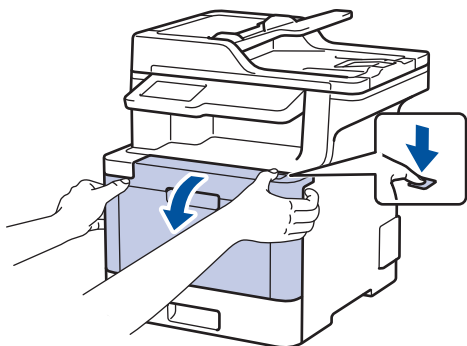

6. Hold the drum unit's green handle. Pull the drum unit out of the machine until it stops.

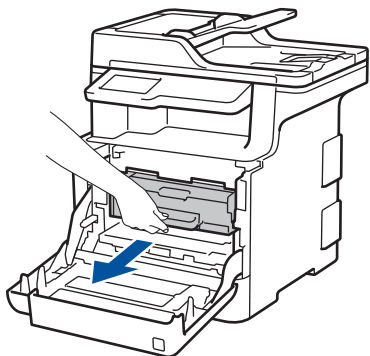

7. Turn the green lock lever (1) counterclockwise until it locks in the release position. Holding the green handles of the drum unit, lift the front of the drum unit and remove it from the machine.

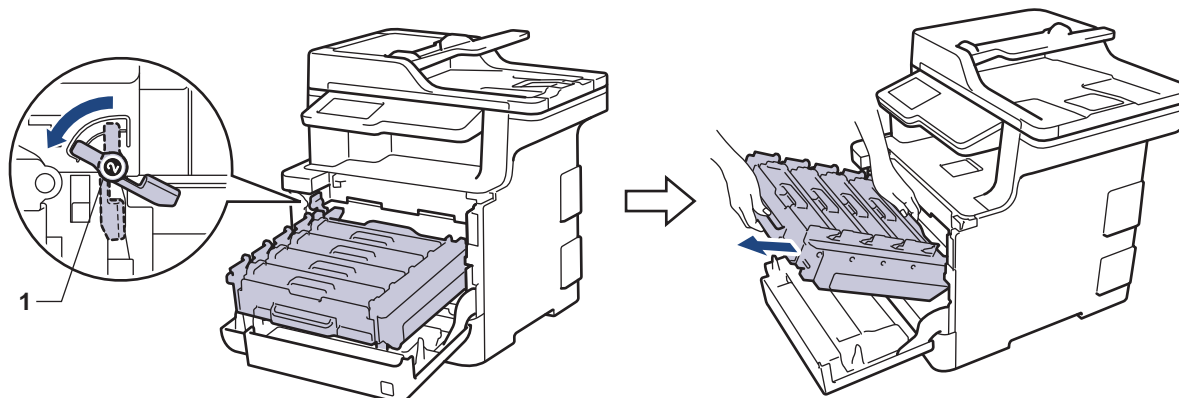

IMPORTANT

Hold the green handles of the drum unit when you carry it. DO NOT hold the sides of the drum unit.

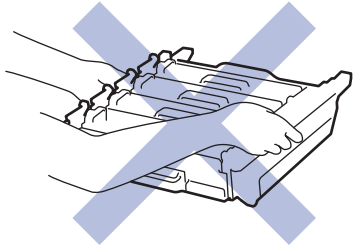

8. Hold the handle of the toner cartridge and gently push it away from you to unlock it. Pull it up and out of the drum unit. Repeat this for all toner cartridges.

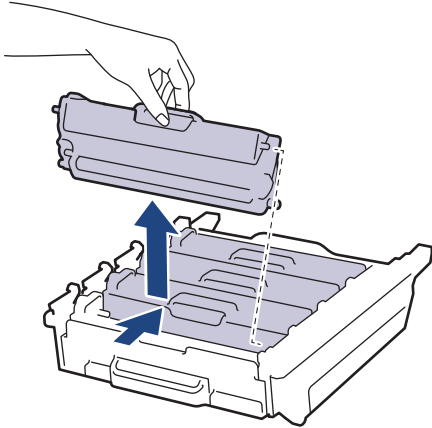

9. Turn the drum unit over by holding the green handles. Make sure that the drum unit gears (1) are on the left side.

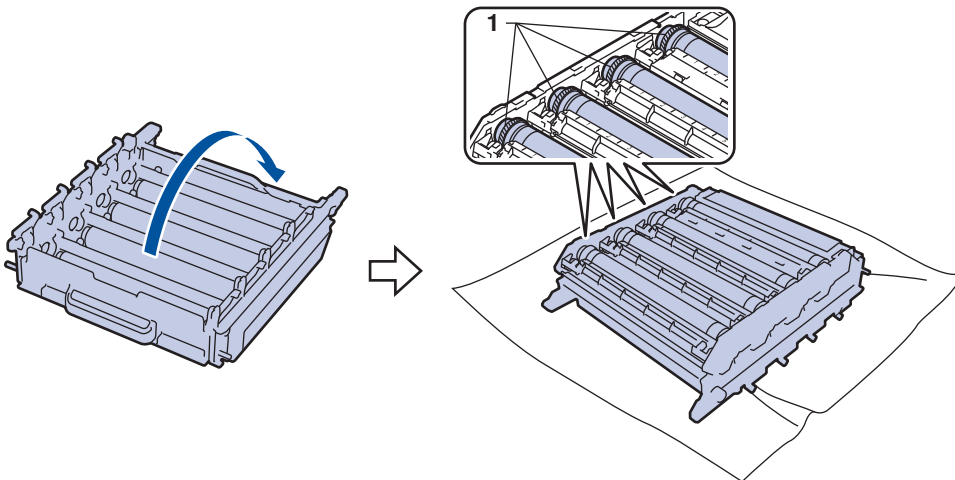

10. Use the numbered markers next to the drum roller to find the mark. For example, a cyan dot in column 2 on the check sheet would mean that there is a mark in the "2" region of the cyan drum.

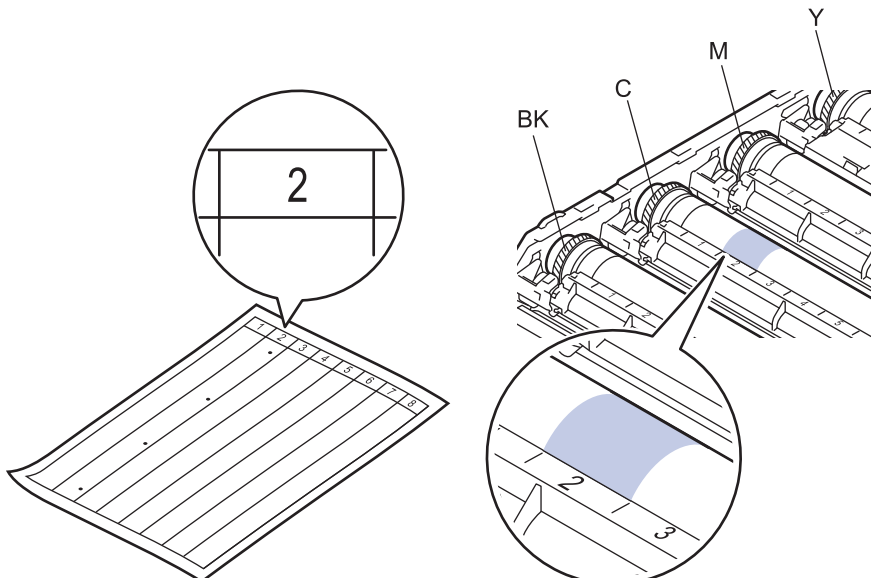

- BK: Black
- C: Cyan
- M: Magenta
- Y: Yellow

11. Hold the drum unit frame with both hands, place your left thumb on the drum unit gear, and roll the drum toward you by hand while looking at the surface of the suspected area.

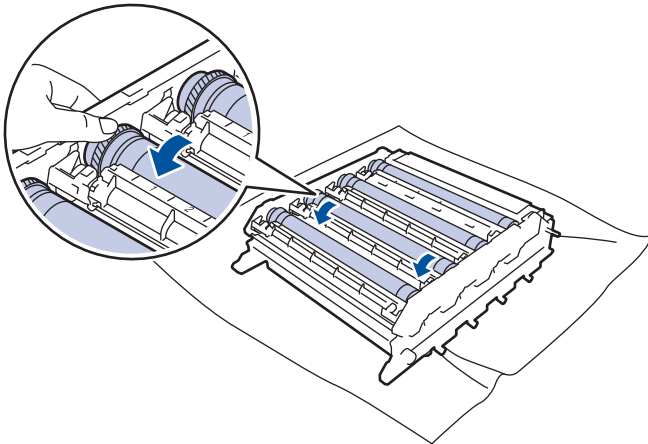

To avoid print quality problems, DO NOT touch the surface of the drum unit except the edge.

12. Wipe the surface of the drum gently with a dry cotton swab until the mark on the surface comes off.

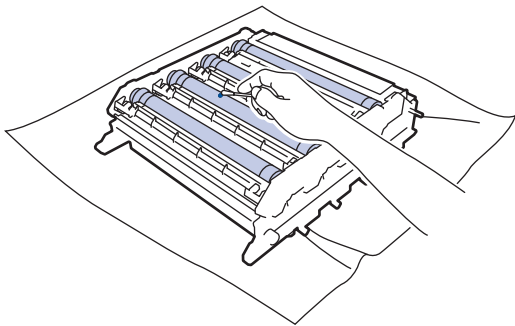

NOTE

DO NOT clean the surface of the photosensitive drum with a sharp object or any liquids.

13. Turn the drum unit over by holding the green handles.

14. Reinsert the toner cartridge into the new drum unit and gently pull it toward you until you hear it lock into place. Make sure that you match the toner cartridge color to the same color label on the drum unit. Repeat this for all toner cartridges.

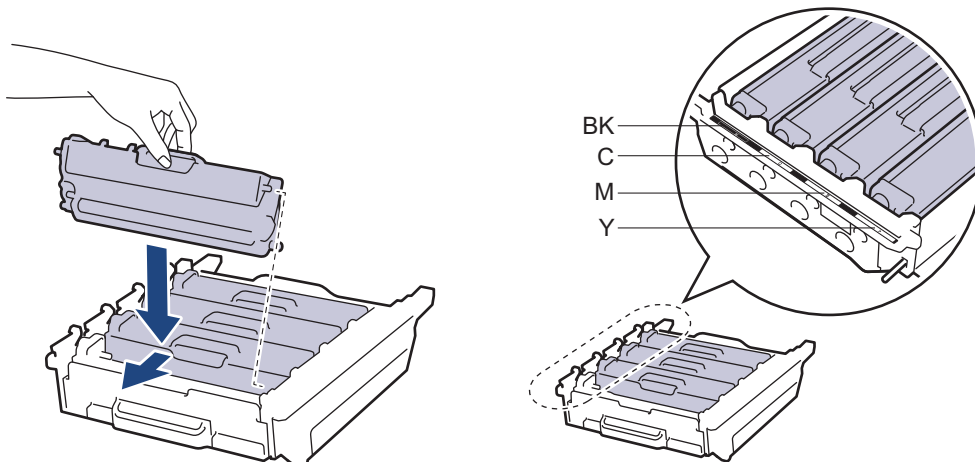

- BK: Black

- C: Cyan
- M: Magenta
- Y: Yellow



Make sure you put the toner cartridge in correctly or it may separate from the drum unit.

15. Make sure the green lock lever (1) is in the release position, as shown in the illustration.

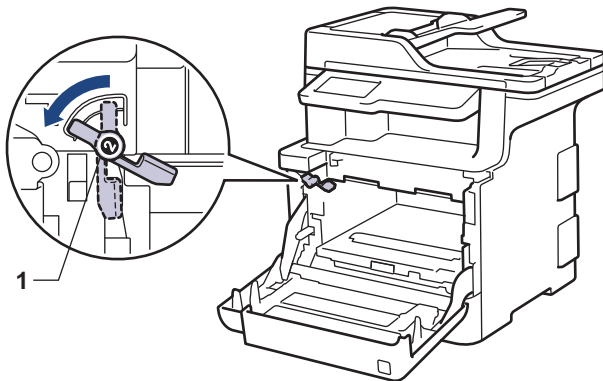

16. Gently slide the drum unit into the machine until it stops at the green lock lever.

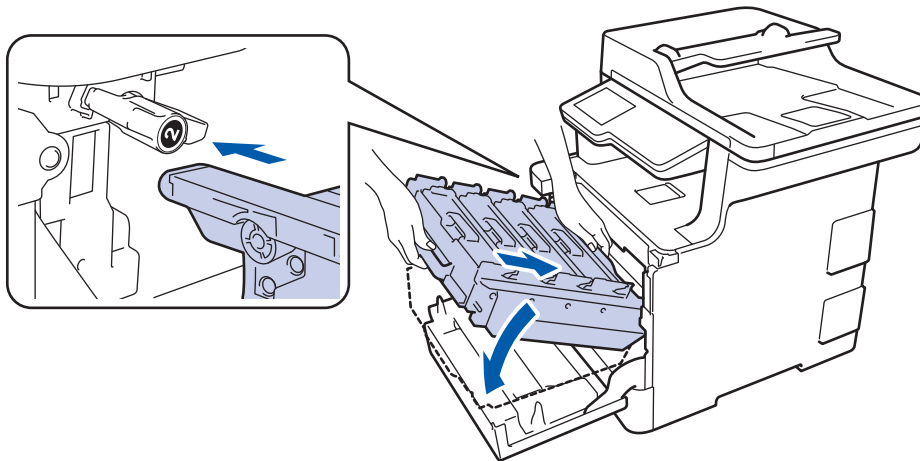

17. Turn the green lock lever clockwise to the lock position.

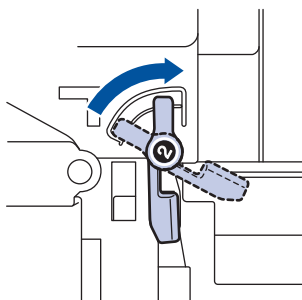

18. Using the green handle, push the drum unit back into the machine until it locks in place.

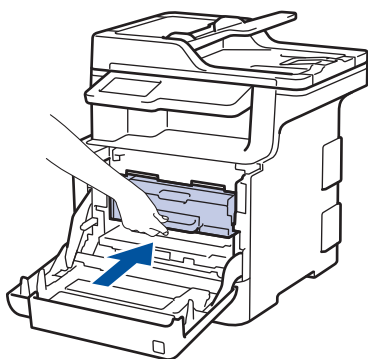

19. Close the machine's front cover.

20. Press  to turn on the machine.



Related Information

- [Clean the Machine](#)
- [Improve the Print Quality](#)

Clean the Paper Pick-up Rollers

Cleaning the paper pick-up rollers periodically may prevent paper jams by ensuring that paper feeds properly.

If you have paper feed problems, clean the pick-up rollers as follows:

1. Press and hold  to turn off the machine.
2. Pull the paper tray completely out of the machine.

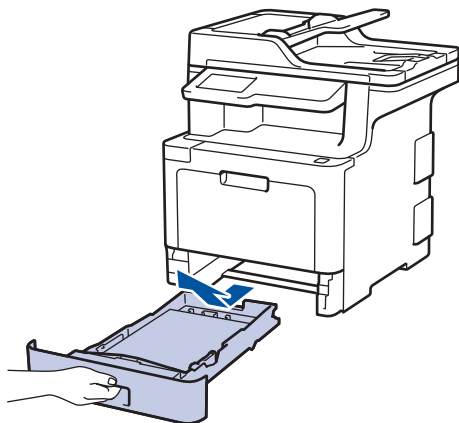

3. If paper is loaded or something is stuck inside in the paper tray, remove it.
4. Tightly wring out a lint-free cloth soaked in lukewarm water, and then wipe the separator pad on the paper tray to remove dust.

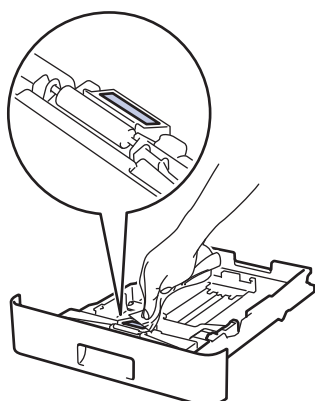

5. Wipe the two pick-up rollers inside the machine to remove dust.

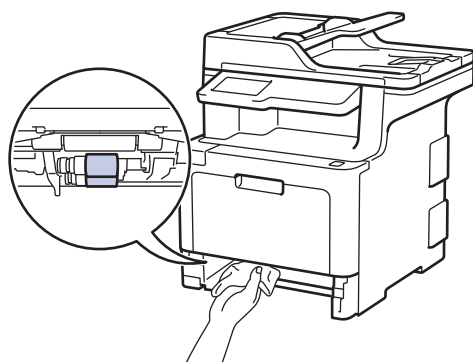

6. Reload the paper and put the paper tray firmly back in the machine.
7. Press  to turn on the machine.

Related Information

- [Clean the Machine](#)
- [Printing Problems](#)

Calibrate Color Output

The output density for each color may vary depending on the machine's environment, including factors like temperature and humidity. Calibrating your machine helps improve the output color density.



If you are using the Macintosh printer driver, the printer driver automatically retrieves the calibration data. To retrieve the data manually, you must perform the calibration using Brother's **Status Monitor**.

1. Press  [Toner] > [Calibration] > [Calibrate]
2. Press [Yes].



Calibration starts automatically, and will take a few minutes.

3. Press .





Related Information

- [Routine Maintenance](#)
- [Reset the Machine's Calibration Settings](#)
- [Improve the Print Quality](#)
- [Monitor the Status of the Machine from Your Computer \(Windows®\)](#)
- [Monitor the Status of the Machine from Your Computer \(Macintosh\)](#)

Reset the Machine's Calibration Settings

If the output color differs from what you see on your monitor, try resetting your machine's calibration parameters.

1. Press  [Toner] > [Calibration] > [Reset]
2. Press [Yes].
3. Press .



Related Information

- [Calibrate Color Output](#)
-

Correct Color Print Alignment (Color Registration)

If solid areas of color or images have cyan, magenta or yellow fringes, use the Color Registration function.

1. Press  [Toner] > [Registration]
2. Press [Yes].



Color registration starts automatically, and will take around 10 seconds or more.

3. Press .



Related Information

- [Routine Maintenance](#)

Check the Remaining Part Life

1. Press  [Settings] > [All Settings] > [Machine Info.] > [Parts Life].



If your machine displays the [All Settings] menu on the Home screen, skip the [Settings] menu.

2. Press the machine part you want to check.
The LCD displays the approximate remaining part life.

3. Press .



To display the approximate remaining life of the toner cartridge, press  on the LCD.



Related Information

- [Routine Maintenance](#)

Pack and Ship Your Brother Machine

WARNING

- To prevent possible injuries, at least two people should lift the product by holding it at the front and back.
- When you move the machine, carry the machine as shown in the illustration below.





- If the machine has the Optional Tray(s) installed, remove the Optional Tray(s) BEFORE moving the machine. Attempting to move the machine without removing the Optional Tray(s) may cause injury to you or damage to the machine.
- Pack the Optional Tray(s) separately in its original carton with original packing material.

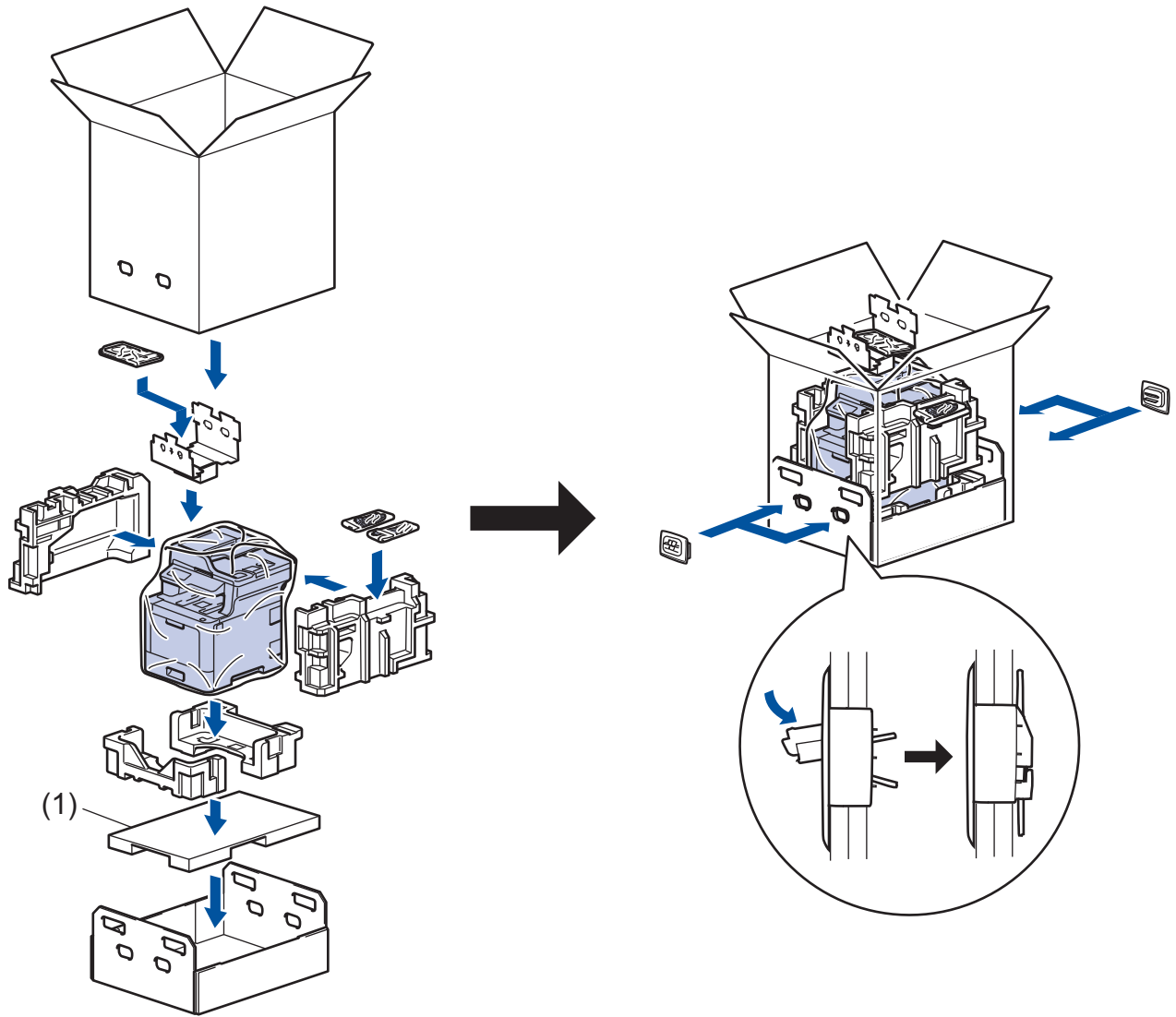

- If for any reason you must ship your machine, carefully repack the machine in the original packaging to avoid any damage during transit. The machine should be adequately insured with the carrier.
- Unless you are returning the machine as part of the Brother Exchange Service, leave the toner cartridge and drum unit inside the machine when you pack and ship it.

1. Press and hold  to turn off the machine. Leave the machine off for at least 10 minutes to cool down.
2. Disconnect all the cables, and then unplug the power cord from the AC power outlet.
3. Put the machine into the bag it originally came in.
4. Pack the machine, the printed materials, and the AC power cord (if applicable) in the original carton with the original packing material as shown. If you are returning your machine to Brother as part of the Exchange Service, pack only the machine. Keep all separate parts and printed materials to use with your "Exchange" machine.



 Packing (1) is only for certain models.

5. Close the carton and tape it shut.
6. If you have a Lower Tray, repack it as shown.

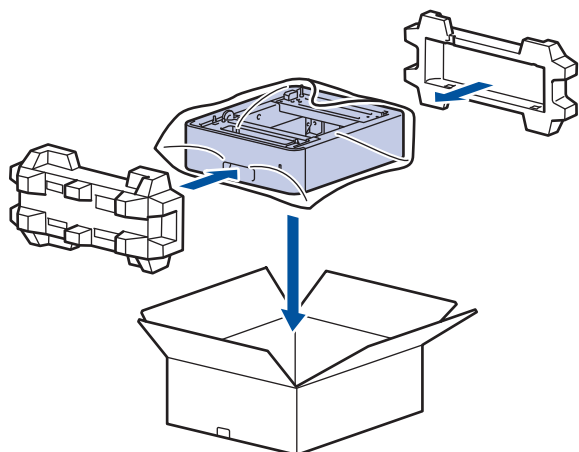

Related Information

- [Routine Maintenance](#)

Replace Periodic Maintenance Parts

Replace the following parts regularly to maintain print quality. The parts listed below must be replaced after printing approximately 50,000 pages¹ for the PF Kit MP and 100,000 pages¹ for the other parts.

Contact Brother Customer Service or a Brother Authorized Service Center when the following message appears on the LCD:

LCD Message	Description
Replace Fuser ²	Replace the Fuser Unit.
Replace Laser ²	Replace the Laser Unit.
Replace PF Kit 1 ²	Replace the Paper Feeding Kit for the Paper Tray.
Replace PF Kit 2 ^{2 3}	Replace the Paper Feeding Kit for the Optional Tray(s).
Replace PF Kit MP ²	Replace the Paper Feeding Kit for the Multi-purpose Tray.



Related Information

- [Routine Maintenance](#)

¹ Letter or A4 size 1-sided pages

² Replacement frequency depends on the complexity of printed pages, percentage of coverage, and the type of media used.

³ If you use the Optional Tray(s) with your machine, this message will appear on the LCD. When the machine has multiple Optional Trays, the machine displays messages using numbers corresponding to each Optional Tray.

Machine Settings

Customize settings and features, create shortcuts, and work with options displayed on the machine's LCD to make your Brother machine a more efficient work tool.

- [Change Machine Settings from the Control Panel](#)
- [Change Machine Settings from Your Computer](#)

Change Machine Settings from the Control Panel

- [In the Event of Power Failure \(Memory Storage\)](#)
- [General Settings](#)
- [Save Your Favorite Settings as a Shortcut](#)
- [Print Reports](#)
- [Settings and Features Tables](#)

In the Event of Power Failure (Memory Storage)

Your menu settings are stored permanently, and in the event of a power failure will not be lost. Temporary settings (for example, Contrast, Overseas Mode) will be lost.

- During a power failure, the machine will retain the date and time and programmed fax timer jobs (for example: Delayed Fax) for approximately 60 hours. Other fax jobs in the machine's memory will not be lost.



Related Information

- [Change Machine Settings from the Control Panel](#)
-

General Settings

- [Adjust the Machine's Volume](#)
- [Change for Daylight Saving Time Automatically](#)
- [Set Sleep Mode Countdown](#)
- [About Deep Sleep Mode](#)
- [Set Auto Power Off Mode](#)
- [Set the Date and Time](#)
- [Set the Time Zone](#)
- [Adjust the LCD Backlight Brightness](#)
- [Change How Long the LCD Backlight Stays On](#)
- [Set Your Station ID](#)
- [Set Tone or Pulse Dialing Mode \(For Canada\)](#)
- [Reduce Toner Consumption](#)
- [Add a Prefix to Every Fax Number](#)
- [Prevent Dialing a Wrong Number \(Dial Restriction\)](#)
- [Reduce Printing Noise](#)
- [Change the Language on the LCD](#)

Adjust the Machine's Volume

1. Press  [Settings] > [All Settings] > [General Setup] > [Volume].



If your machine displays the [All Settings] menu on the Home screen, skip the [Settings] menu.

2. Press one of the following options:
(The options will vary depending on your machine.)
 - [Ring]
Adjust the ring volume.
 - [Beep]
Adjust the volume of the beep you hear when you press a button, make a mistake, or after you send or receive a fax.
 - [Speaker]
Adjust the speaker volume.
3. Select the [Off], [Low], [Med] or [High] option, and then press the option you want.
4. Press .



Related Information

- [General Settings](#)

Change for Daylight Saving Time Automatically

You can program the machine to change automatically for Daylight Saving Time.

It will reset itself forward one hour in the spring, and backward one hour in the fall. Make sure you have set the correct date and time in the Date & Time setting.

1. Press  [Settings] > [All Settings] > [Initial Setup] > [Date & Time] > [Auto Daylight].



If your machine displays the [All Settings] menu on the Home screen, skip the [Settings] menu.

2. Press [On] or [Off].
3. Press .



Related Information

- [General Settings](#)

Set Sleep Mode Countdown

The Sleep Mode (or Power Save Mode) setting can reduce power consumption. When the machine is in Sleep Mode, it acts as though it is turned off. The machine will wake up and start printing when it receives a print job or a fax. Use these instructions to set a time delay (countdown) before the machine enters Sleep Mode.

- You can choose how long the machine must be idle before it goes into Sleep Mode.
- The timer will restart if any operation is carried out on the machine, such as receiving a print job.

1. Press  [Settings] > [All Settings] > [General Setup] > [Ecology] > [Sleep Time].



If your machine displays the [All Settings] menu on the Home screen, skip the [Settings] menu.

2. Enter the length of time (maximum 50 minutes) the machine will remain idle before entering Sleep Mode, and then press [OK].

3. Press .





Related Information

- [General Settings](#)

About Deep Sleep Mode

If the machine is in Sleep Mode and does not receive any jobs for certain length of time, the machine will automatically enter Deep Sleep Mode. The length of time is based on your specific model and settings.

Deep Sleep Mode uses less power than Sleep Mode.

Applicable Models	Machine's LCD in Deep Sleep Mode	Conditions That Will Wake the Machine
MFC-L8610CDW/ MFC-L8900CDW	The LCD backlight turns off and the Power LED brightens and dims.	<ul style="list-style-type: none">The machine receives a job.Someone presses ,  or the Touchscreen LCD.





Related Information

- [General Settings](#)

Set Auto Power Off Mode

If the machine is in Deep Sleep Mode for certain length of time, based on your model and settings, the machine will go into Power Off Mode automatically. The machine does not go into Power Off Mode when the machine is connected to a network or a telephone line, or has secure print data in the memory.

- To start printing, press  on the control panel and then send a print job.

1. Press  [Settings] > [All Settings] > [General Setup] > [Ecology] > [Auto Power Off].



If your machine displays the [All Settings] menu on the Home screen, skip the [Settings] menu.

2. Press the [Off], [1hour], [2hours], [4hours] or [8hours] option you want.

3. Press .



Related Information



- [General Settings](#)

Set the Date and Time

1. Press  [Settings] > [All Settings] > [Initial Setup] > [Date & Time] > [Date].



If your machine displays the [All Settings] menu on the Home screen, skip the [Settings] menu.

2. Enter the last two digits of the year using the LCD, and then press [OK].
3. Enter the two digits for the month using the LCD, and then press [OK].
4. Enter the two digits for the day using the LCD, and then press [OK].
5. Press [Clock Type].
6. Press [12h Clock] or [24h Clock].
7. Press [Time].
8. To enter the time, do one of the following:
 - If you selected [12h Clock] as the format in the [Clock Type] setting, enter the time (in 12-hour format) using the LCD.
Press  to select [AM] or [PM].
Press [OK].
 - If you selected [24h Clock] as the format in the [Clock Type] setting, enter the time (in 24-hour format) using the LCD.
Press [OK].
(For example: enter 19:45 for 7:45 PM.)
9. Press .



Related Information

- [General Settings](#)

Set the Time Zone

Set the time zone for your location on the machine.

For example, the time zone for Eastern Time in the USA and Canada is UTC-05:00. Pacific Time in the USA and Canada is UTC-08:00.

Time Zone	Standard Time
Hawaii-Aleutian Time Zone	UTC - 10:00
Alaska Time Zone	UTC - 9:00
Pacific Time Zone	UTC - 8:00
Mountain Time Zone	UTC - 7:00
Central Time Zone	UTC - 6:00
Eastern Time Zone	UTC - 5:00
Atlantic Time Zone	UTC - 4:00

1. Press  [Settings] > [All Settings] > [Initial Setup] > [Date & Time] > [Time Zone].



If your machine displays the [All Settings] menu on the Home screen, skip the [Settings] menu.

2. Enter your time zone.

3. Press [OK].

4. Press .



Related Information

- [General Settings](#)

Adjust the LCD Backlight Brightness

If you are having difficulty reading the LCD, changing the brightness setting may help.

1. Press  [Settings] > [All Settings] > [General Setup] > [LCD Settings] > [Backlight].



If your machine displays the [All Settings] menu on the Home screen, skip the [Settings] menu.

2. Press the [Light], [Med] or [Dark] option.
3. Press .



Related Information

- [General Settings](#)

Change How Long the LCD Backlight Stays On

Set how long the LCD backlight stays on.

1. Press  [Settings] > [All Settings] > [General Setup] > [LCD Settings] > [Dim Timer].



If your machine displays the [All Settings] menu on the Home screen, skip the [Settings] menu.

2. Press the option you want:

- [10Secs]
- [30Secs]
- [1Min]
- [2Mins]
- [3Mins]
- [5Mins]

3. Press .



Related Information

- [General Settings](#)

Set Your Station ID

Set the machine to print your Station ID and the fax's date and time at the top of each fax you send.

1. Press  [Settings] > [All Settings] > [Initial Setup] > [Station ID] > [Fax].



If your machine displays the [All Settings] menu on the Home screen, skip the [Settings] menu.

2. Enter your fax number (up to 20 digits) using the LCD, and then press [OK].
3. Press [Tel].
4. Enter your telephone number (up to 20 digits) using the LCD, and then press [OK].
5. Press [Name].
6. Enter your name (up to 20 characters) using the LCD, and then press [OK].



- Press  to cycle between letters, numbers and special characters. (The characters available may differ depending on your country.)



If your machine displays  , press .

- If you enter an incorrect character, press ◀ or ▶ to move the cursor to it and press . Press the correct character.
- To enter a space, press [Space] or ▶.
- For more information, see *Related Information*.

7. Press .



Related Information

- [General Settings](#)
- [How to Enter Text on Your Brother Machine](#)
- [Transfer Faxes to Another Fax Machine](#)
- [Transfer the Fax Journal Report to Another Fax Machine](#)

Set Tone or Pulse Dialing Mode (For Canada)

Your Brother machine is set for a Tone dialing service. If you have a Pulse dialing (rotary) service, you must change the dialing mode.

This feature is not available in some countries.

1. Press  [Settings] > [All Settings] > [Initial Setup] > [Tone/Pulse].



If your machine displays the [All Settings] menu on the Home screen, skip the [Settings] menu.

2. Press [Tone] or [Pulse].

3. Press .



Related Information

- [General Settings](#)

Reduce Toner Consumption

Using the Toner Save feature may reduce toner consumption. When Toner Save is set to on, the print on your documents appears lighter.

We DO NOT recommend using the Toner Save feature for printing photo or grayscale images.

1. Press  [Settings] > [All Settings] > [General Setup] > [Ecology] > [Toner Save].



If your machine displays the [All Settings] menu on the Home screen, skip the [Settings] menu.

2. Press [On] or [Off].
3. Press .



Related Information

- [General Settings](#)
- [Improve the Print Quality](#)

Add a Prefix to Every Fax Number

The Dial Prefix setting will automatically dial a predefined number before every fax number you dial. For example: If your telephone system requires a 9 to dial an outside number, use this setting to automatically dial 9 for every fax you send.



- Use the numbers and symbols from 0 to 9, #, and *. (You cannot use ! with any other numbers or symbols.)
- If your telephone system requires a time break recall (hookflash), press ! on the LCD.
- (Canada only) If pulse dialing mode is on, # and * are not available to use.

1. Press  [Settings] > [All Settings] > [Initial Setup] > [Dial Prefix].



If your machine displays the [All Settings] menu on the Home screen, skip the [Settings] menu.

2. Press [On] or [Off].

Option	Description
On	To activate the prefix number setting, select On. If you selected On, go to the next step to set a prefix number.
Off	To deactivate the prefix number setting, select Off. If you selected Off, press  to exit.

3. Press [Dial Prefix].

4. Enter a prefix number (up to five digits) using the LCD, and then press [OK].



To change the prefix number, press ◀ or ▶ to position the cursor under the digit to be deleted and press . Then press the correct digit.

Repeat until the prefix number is correct, and then press [OK].

5. Press .



Related Information

- [General Settings](#)

Prevent Dialing a Wrong Number (Dial Restriction)

This feature prevents users from sending a fax or call to the wrong number by mistake. You can set the machine to restrict dialing when you use the dial pad, Address Book, Shortcuts and LDAP search.

1. Press  [Settings] > [All Settings] > [Fax] > [Dial Restriction].



If your machine displays the [All Settings] menu on the Home screen, skip the [Settings] menu.

2. Press one of the following options:

- [Dial Pad]
- [Address Book]



If you combine Address Book numbers when dialing, the numbers will be recognized as dial pad input and will not be restricted.

- [Shortcuts]
- [LDAP Server]

3. Press one of the following options:

Option	Description
Enter # Twice	The machine prompts you to re-enter the number, and then if you re-enter the same number correctly, the machine will start dialing. If you re-enter the wrong number, the LCD will display an error message.
On	The machine restricts all fax sending and outbound calls for that dialing method.
Off	The machine does not restrict the dialing method.



- The [Enter # Twice] setting will not work if you use an external phone or press [Hook] before entering the number. You will not be asked to re-enter the number.
- If you choose [On] or [Enter # Twice], you cannot use the Broadcasting feature.

4. Press .



Related Information

- [General Settings](#)

Reduce Printing Noise

The Quiet Mode setting can reduce printing noise. When Quiet Mode is turned on, the print speed becomes slower. The factory setting is off.

1. Press  [Settings] > [All Settings] > [General Setup] > [Ecology] > [Quiet Mode].



If your machine displays the [All Settings] menu on the Home screen, skip the [Settings] menu.

2. Press [On] or [Off].
3. Press .



Related Information

- [General Settings](#)

Change the Language on the LCD

Change the LCD language if needed.

This feature is not available in some countries.

1. Press  [Settings] > [All Settings] > [Initial Setup] > [Local Language].



If your machine displays the [All Settings] menu on the Home screen, skip the [Settings] menu.

2. Press your language.
3. Press .



Related Information

- [General Settings](#)

Save Your Favorite Settings as a Shortcut

- [Add Shortcuts](#)
- [Change or Delete Shortcuts](#)
- [Assign a Shortcut to an ID Card](#)



Add Shortcuts

You can add the Fax, Copy, Scan, Web Connect and Apps settings you use most frequently by saving them as your Shortcuts. Later you can press the Shortcut to apply these settings instead of manually re-entering them.



Some Shortcut menus are not available depending on your model.

These instructions describe how to add a Copy Shortcut. The steps for adding a Fax, Scan, Web Connect or Apps Shortcut are very similar.

1. Press  [Shortcuts]. (If  [Shortcuts] is displayed.)
2. Press a tab.



Swipe to display the tab if needed.

3. Press  where you have not added a Shortcut.
4. Press [Copy].
5. Press > to access the preset copy settings.
6. Swipe to display the copy presets, and then press the copy preset you want.
7. Press [Options].
8. Swipe up or down or press ▲ or ▼ to display the available settings, and then press the setting you want to change.
9. Swipe up or down or press ▲ or ▼ to display the available options for the setting, and then press the option you want.
Repeat these two steps until you have selected all the settings and options you want.
10. When you have finished changing settings, press [OK]. (If the [OK] button is displayed.)
11. Press [Save as Shortcut].
12. Read and confirm the displayed list of settings you have selected, and then press [OK].
13. Enter a name for the Shortcut using the LCD, and then press [OK].





Related Information

- [Save Your Favorite Settings as a Shortcut](#)

Change or Delete Shortcuts



You cannot change a Web Connect Shortcut or Apps Shortcut. If you need to change them, delete them, and then add a new Shortcut.

1. Press  [Shortcuts]. (If  [Shortcuts] is displayed.)
2. Press a tab to display the Shortcut you want to change.



Swipe to display the tab if needed.

3. Press the Shortcut you want to change.
The settings for the Shortcut you selected appear.



To delete the Shortcut or edit the name, press and hold the Shortcut until the options appear, and then follow the on-screen menus.

4. Press [Options].
5. Change the settings for the Shortcut if needed.
6. Press [OK] (if needed).
7. When finished, press [Save as Shortcut].
8. Read and confirm the displayed list of settings you have selected, and then press [OK].
9. Do one of the following:
 - To overwrite the Shortcut, press [Yes].
 - If you do not want to overwrite the Shortcut, press [No] to enter a new Shortcut name.
Enter a new name using the LCD, and then press [OK].



To edit the name, hold down  to delete the current name.



Related Information

- [Save Your Favorite Settings as a Shortcut](#)

Assign a Shortcut to an ID Card

Related Models: MFC-L8900CDW

You can assign one machine Shortcut to your ID card. When you touch your ID card to the machine's NFC symbol, your personal Shortcut will automatically appear on the Touchscreen.



- You cannot use the same ID card for different Shortcuts.
- To use the ID card for another Shortcut, unregister the card first, and then register it with the new Shortcut.

1. Press the tab that contains the Shortcut you want to assign to your ID card.
2. Press and hold the Shortcut until the options appear.
3. Press [Register Card/NFC].
4. Touch the ID card to the NFC symbol.
5. Press [Register].

The Shortcut is assigned to the ID Card.



Related Information

- [Save Your Favorite Settings as a Shortcut](#)

Print Reports

- [Reports](#)
- [Print a Report](#)

Reports

The following reports are available:

Transmission

The Transmission report prints a Transmission Verification Report of your last transmission.

Address Book

The Address Book report prints an alphabetical list of names and numbers stored in the Address Book memory.

Fax Journal

The Fax Journal prints a list of information about your last 200 incoming and outgoing faxes. (TX means Transmit, RX means Receive)

User Settings

The User Settings report prints a list of your current settings.

Printer Settings

The Printer Settings report prints a list of your current printer settings.

Network Configuration (Models with network functionality)

The Network Configuration report prints a list of your current network settings.

Print File List

The Print File List prints a list of the fonts and print macros stored in the machine.

Drum Dot Print

The Drum Dot Print prints the drum dot sheet, which helps when it is time to clean the drum unit.

WLAN Report (Models with wireless network functionality)

The WLAN Report prints the wireless LAN connectivity diagnosis.



Related Information

- [Print Reports](#)

Print a Report

1. Press  [Settings] > [All Settings] > [Print Reports].



If your machine displays the [All Settings] menu on the Home screen, skip the [Settings] menu.

2. Swipe up or down or press ▲ or ▼ to display the report you want to print, and then press it.
3. Do one of the following:
 - If you choose [Transmission], do one of the following:
 - To view the Transmission Verification Report, press [View on LCD].
 - To print the Transmission Verification Report, press [Print Report].
 - If you choose other reports, go to next step.
4. Press [Yes].
5. Press .



Related Information

- [Print Reports](#)

Settings and Features Tables

The Settings tables will help you understand the menu selections and options that are found in the machine's programs.

- [Settings Tables \(MFC-L8610CDW\)](#)
- [Settings Tables \(MFC-L8900CDW\)](#)
- [Feature Tables \(MFC-L8610CDW\)](#)
- [Feature Tables \(MFC-L8900CDW\)](#)

Settings Tables (MFC-L8610CDW)

Related Models: MFC-L8610CDW



[Settings]

Level 1	Level 2	Level 3	Descriptions
	Date & Time	-	Access the Date and Time setting menus.
Toner	Toner Life	-	View the approximate remaining toner life.
	Test Print	-	Print a test page.
	Calibration	Calibrate	Initiate color calibration to check and correct colors.
		Reset	Reset the calibration parameters to the default settings.
Registration	-	Align the print position of each color.	
Network	Wired LAN	-	Access the Wired LAN setting menus.
	WLAN	-	Access the WLAN setting menus.
Screen Settings	-	-	Access the default screen setting menus.
Wi-Fi Direct	-	-	Access the Wi-Fi Direct setting menus.
Tray Setting	-	-	Access the tray setting menus.
All Settings	-	-	Configure the detailed settings.

[All Settings] > [General Setup]

Level 3	Level 4	Level 5	Descriptions	
Tray Setting	Paper Type	MP Tray	Select the paper type that matches the paper in the MP tray.	
		Tray #1	Select the paper type that matches the paper in the standard paper tray.	
		Tray #2 ¹	Select the paper type that matches the paper in the Optional Tray (Tray 2).	
		Tray #3 ¹	Select the paper type that matches the paper in the Optional Tray (Tray 3).	
		Tray #4 ¹	Select the paper type that matches the paper in the Optional Tray (Tray 4).	
		Paper Size	MP Tray	Select the size of paper you loaded in the MP tray.
			Tray #1	Select the size of paper you loaded in the standard paper tray.
			Tray #2 ¹	Select the size of paper you loaded in the Optional Tray (Tray 2).
	Tray #3 ¹		Select the size of paper you loaded in the Optional Tray (Tray 3).	
	Check Size	-	Select whether to display a message telling you to check that the size of the paper in the machine and the machine's Paper Size setting match.	
		Tray Use: Copy	-	Select the tray to be used for Copy.

Level 3	Level 4	Level 5	Descriptions
Tray Setting	Tray Use: Fax	-	Select the tray to be used for Fax.
	Tray Use: Print	-	Select the tray to be used for Print.
Volume	Ring	-	Adjust the ring volume.
	Beep	-	Adjust the beeper volume.
	Speaker	-	Adjust the speaker volume.
LCD Settings	Backlight	-	Adjust the brightness of the LCD backlight.
	Dim Timer	-	Set how long the LCD backlight stays on after you go back to your Main Home screen.
Screen Settings	Main Home Screen	-	Set the Main Home screen.
	Copy Screen	-	Set the default Copy screen.
	Scan Screen	-	Set the default Scan screen.
Notice Settings	Scan Result (Skip Blank Page)	-	Displays the total scanned pages and skipped blank pages after scanning is completed.
Ecology	Toner Save	-	Increase the page yield of the toner cartridge.
	Sleep Time	-	Set how much time will pass before the machine enters Power Saving Mode.
	Quiet Mode	-	Decrease printing noise.
	Auto Power Off	-	Set the number of hours that the machine will remain in Deep Sleep Mode before going into Power Off Mode.
Setting Lock	Set Password	-	Restrict unauthorized users from changing the machine's settings.
	Lock Off⇒On	-	
	New Password (Available only when you enter the password for the first time.)	-	

¹ Available if the Optional Tray(s) is installed.

[All Settings] > [Shortcut Settings]

Level 3	Level 4	Descriptions
(Select a Shortcut)	Rename	Change the shortcut name.
	Edit	Change the shortcut settings.
	Delete	Delete the shortcut.

[All Settings] > [Fax]

Level 3	Level 4	Level 5	Descriptions
Setup Receive	Receive Mode	-	Select the Receive Mode that best suits your needs.
	Ring Delay	-	Set the number of rings before the machine answers in Fax or Fax/Tel mode.
	F/T Ring Time	-	Set the length of the pseudo/double-ring time in Fax/Tel mode.
	Fax Preview	-	View received faxes on the LCD.
	Easy Receive	-	Receive fax messages automatically when you answer a call and hear fax tones.

Level 3	Level 4	Level 5	Descriptions
Setup Receive	Remote Codes	Remote Codes	Answer calls at an extension or external telephone and use codes to turn on or off the Remote Codes. You can personalize the codes.
		Fax Receive Code	
		Tel Answer	
	Auto Reduction	-	Reduce the size of incoming faxes.
	PC Fax Receive	On	Set the machine to send faxes to your computer.
		Off	You can turn on the Backup Print safety feature.
	Memory Receive	Off	-
		Fax Forward	Set the machine to forward fax messages, to call your pager or cell phone, or to store incoming faxes in the machine's memory (so you can retrieve them while you are away from your machine). If you select Fax Forward, you can turn on the Backup Print safety feature.
		Paging	
		Fax Storage	
Forward to Cloud	Forward incoming faxes to the online service.		
Fax Rx Stamp	-	Print the received time and date on the top of received faxes.	
2-sided	-	Print received faxes on both sides of the paper.	
Setup Send	Batch TX	-	Combine delayed faxes to the same fax number at the same time of day into one transmission.
	Coverpage Setting	Print Sample	Print a sample of the fax cover page. You can fill in information and fax it with your document.
		Coverpage Message	Set up your own comments for the fax cover page.
	Auto Redial	-	Set the machine to redial the last fax number after five minutes if the fax did not go through because the line was busy.
Destination	-	Set the machine to display the destination information on the LCD during fax dialing.	
Report Setting	Transmission	-	Select the initial setup for the Transmission Verification Report.
	Journal Period	Journal Period	Set the interval for automatic printing of the Fax Journal.
		Time	If you select an option other than Off and Every 50 Faxes, you can set the time for the option.
	Day	If you select Every 7 Days, you can set the day of the week.	
Print Fax	-	-	Print received faxes stored in the machine's memory.
Remote Access	-	-	Set your own code for Remote Retrieval.
Dial Restriction	Dial Pad	-	Set the machine to restrict dialing when using the dial pad.
	Address Book	-	Set the machine to restrict the dialing when using the Address Book.
	Shortcuts	-	Set the machine to restrict the dialing when using a Shortcut.
	LDAP Server	-	Set the machine to restrict the dialing of LDAP server numbers.

Level 3	Level 4	Level 5	Descriptions
Dial Restriction	(Available after Internet Fax (I-Fax) is downloaded)		
Remaining Jobs	-	-	Check which scheduled jobs are in the machine's memory and cancel selected jobs.
Miscellaneous	Distinctive	Distinctive	Turn on the telephone company's Distinctive Ring subscriber service to register your new ring pattern on the machine.
		Ring Pattern	Register your new ring pattern on the machine.

[All Settings] > [Printer]

Level 3	Level 4	Level 5	Descriptions	
Emulation	-	-	Select the emulation mode.	
Quality	-	-	Select the print quality.	
Print Options	Font List	HP LaserJet BR-Script 3	Print a list of the machine's internal fonts.	
	Test Print	-	Print a test page.	
2-sided	2-sided Print	-	Enable or disable 2-sided printing and choose long edge or short edge.	
	Single Image	-	For a print job where the last page is a 1-sided image, select the 1-sided Feed option to reduce printing time. When you use letterhead or preprinted paper, you must select the 2-sided Feed option. If you select 1-sided Feed for letterhead or preprinted paper, the last page will be printed on the reverse side.	
Auto Continue	-	-	Select if you want the machine to clear paper size errors or media type errors automatically, and use paper from other trays.	
Output Color	-	-	Set the output color.	
HP Tray Command	-	-	Select the correct version of HP LaserJet tray emulation.	
Reset Printer	-	-	Restore the printer settings to the factory settings.	
Color Correction	Calibration	Calibrate	Initiate color calibration to check and correct colors.	
		Reset	Reset the calibration parameters to the default settings.	
	Registration	-	Align the print position of each color.	
	Auto Correction	-	Set the machine to perform Color Calibration and Registration automatically.	
	Color Settings	Setting Mode		Select whether to apply the color print settings of the machine or the printer driver.
		Color Mode		Select the color mode.
		Improve Gray Color		Turn on or off to improve the image quality of shaded areas.
		Enhance Black Printing		Turn on or off if a black graphic does not print correctly.
Brightness			Adjust the brightness.	
Contrast		Adjust the contrast.		

Level 3	Level 4	Level 5	Descriptions
Color Correction	Color Settings	Red	Adjust the red color.
		Green	Adjust the green color.
		Blue	Adjust the blue color.

[All Settings] > [Network]

Level 3	Level 4	Level 5	Level 6	Descriptions
Wired LAN	TCP/IP	BOOT Method	IP Boot Tries	Select the BOOT method that best suits your needs.
		IP Address	-	Enter the IP address.
		Subnet Mask	-	Enter the Subnet mask.
		Gateway	-	Enter the Gateway address.
		Node Name	-	Enter the Node name. (up to 32 characters)
		WINS Configuration	-	Select the WINS configuration mode.
		WINS Server	Primary	Specify the IP address of the primary WINS server.
			Secondary	Specify the IP address of the secondary WINS server.
		DNS Server	Primary	Specify the IP address of the primary DNS server.
			Secondary	Specify the IP address of the secondary DNS server.
	APIPA	-	Set the machine to allocate the IP address from the link-local address range automatically.	
	IPv6	-	Turn the IPv6 protocol on or off. To use the IPv6 protocol, go to the Brother Solutions Center at support.brother.com for more information.	
	Ethernet	-	-	Select the Ethernet link mode.
	Wired Status	-	-	View the current wired status.
	MAC Address	-	-	View the machine's MAC address.
Set to Default	-	-	Restore the wired network settings to the factory settings.	
Wired Enable	-	-	Turn the Wired LAN on or off manually.	
WLAN	TCP/IP	BOOT Method	IP Boot Tries	Select the BOOT method that best suits your needs.
		IP Address	-	Enter the IP address.
		Subnet Mask	-	Enter the Subnet mask.
		Gateway	-	Enter the Gateway address.
		Node Name	-	Enter the Node name. (up to 32 characters)
		WINS Configuration	-	Select the WINS configuration mode.

Level 3	Level 4	Level 5	Level 6	Descriptions	
WLAN	TCP/IP	WINS Server	Primary	Specify the IP address of the primary WINS server.	
			Secondary	Specify the IP address of the secondary WINS server.	
		DNS Server	Primary	Specify the IP address of the primary DNS server.	
			Secondary	Specify the IP address of the secondary DNS server.	
		APIPA	-	Set the machine to allocate the IP address from the link-local address range automatically.	
		IPv6	-	Turn the IPv6 protocol on or off. To use the IPv6 protocol, go to the Brother Solutions Center at support.brother.com for more information.	
	Setup Wizard	-	-	Configure the wireless network settings using the setup wizard.	
	WLAN Assistant	-	-	Configure your wireless network settings using the Brother installation disc.	
	WPS	-	-	Configure your wireless network settings using the one-button push method.	
	WPS w/ PIN Code	-	-	Configure your wireless network settings using WPS with a PIN.	
	WLAN Status	Status	-	View the current wireless network status.	
		Signal	-	View the current wireless network signal strength.	
		SSID	-	View the current SSID.	
		Comm. Mode	-	View the current Communication Mode.	
	MAC Address	-	-	View the machine's MAC address.	
	Set to Default	-	-	Restore the wireless network settings to the factory settings.	
	WLAN Enable	-	-	Turns the wireless interface on or off.	
	Wi-Fi Direct	Push Button	-	-	Configure your Wi-Fi Direct network settings using the one-button push method.
		PIN Code	-	-	Configure your Wi-Fi Direct network settings using WPS with a PIN code.
		Manual	-	-	Configure your Wi-Fi Direct network settings manually.
Group Owner		-	-	Set your machine as the Group Owner.	
Device Information		Device Name	-	View your machine's device name.	
	SSID	-	View the Group Owner's SSID.		

Level 3	Level 4	Level 5	Level 6	Descriptions	
Wi-Fi Direct	Device Information			When the machine is not connected, the LCD displays Not Connected.	
		IP Address	-	View your machine's current IP Address.	
	Status Information	Status	-	View the current Wi-Fi Direct network status.	
		Signal	-	View the current Wi-Fi Direct network signal strength. When your machine acts as Group Owner, the LCD always indicates a strong signal.	
	I/F Enable	-	-	Turn the Wi-Fi Direct connection on or off.	
E-mail/IFAX (Available after Internet Fax (I-Fax) is downloaded)	Mail Address	-	-	Enter the email address.	
	Setup Server	SMTP	Server	Enter the SMTP server name and address.	
			Port	Enter the SMTP port number.	
			Auth. for SMTP	Select the Security method for email notification.	
			SSL/TLS	Send or receive an email via an email server that requires secure SSL/TLS communication.	
			Verify Cert.	Verify the SMTP Server Certificate automatically.	
		POP3/IMAP4	Protocol	Select the protocol for receiving an email from the server.	
			Server	Enter the server name and address.	
			Port	Enter the port number.	
			Mailbox Name	Enter the mailbox name. (Up to 60 characters)	
			Mailbox Password	Enter the password to login to the server. (Up to 32 characters)	
			Select Folder	Select the specified folder in the mailbox using the IMAP4 protocol.	
			SSL/TLS	Send or receive an email via an email server that requires secure SSL/TLS communication.	
			Verify Cert.	Verify the SMTP Server Certificate automatically.	
			APOP	Turn APOP on or off.	
		Setup Mail RX	Auto Polling	Auto Polling	Check the server for new messages automatically.
				Poll Frequency	Set the interval for checking new messages on the server.
			Header	-	Select the contents of the email header to be printed.

Level 3	Level 4	Level 5	Level 6	Descriptions
E-mail/IFAX (Available after Internet Fax (I-Fax) is downloaded)	Setup Mail RX	Del/Read Error Mail	-	The POP3 server deletes error emails automatically. The IMAP4 server deletes error emails automatically after you read them.
		Notification	-	Receive notification messages.
	Setup Mail TX	Sender Subject	-	View the subject.
		Size Limit	Size Limit Maximum Size (MB)	Limit the size of email documents.
		Notification	-	Send notification messages.
	Setup Relay	Relay Broadcast	-	Relay a document to another fax machine.
		Relay Domain	Relay XX	Register the Domain name.
		Relay Report	-	Print the relay Broadcast Report.
	Manual Receive	-	-	Check the POP3 or IMAP4 server for new messages manually.
	Web Connect Settings	Proxy Settings	Proxy Connection	-
Address			-	
Port			-	
User Name			-	
Password			-	
Fax to Server (Available after Internet Fax (I-Fax) is downloaded)	Fax to Server	-	-	Select the network connection type.
	Prefix	-	-	
	Suffix	-	-	
IPsec	-	-	-	IPsec is an optional security feature of the IP protocol that provides authentication and encryption services. We recommend contacting your network administrator before changing this setting.
Network Reset	-	-	-	Restore all network settings back to the factory settings.

[All Settings] > [Print Reports]

Level 3	Level 4	Descriptions
Transmission	View on LCD	Display Transmission Verification Reports about sent faxes.
	Print Report	Print a Transmission Verification Report of your last transmission.
Address Book	-	Print a list of names and numbers stored in the Address Book.
Fax Journal	-	Print a list of information about your last 200 incoming and outgoing faxes. (TX means Transmit. RX means Receive.)
User Settings	-	Print a list of your settings.
Printer Settings	-	Print a list of your Printer settings.
Network Configuration	-	Print a list of your Network settings.
Print File List	-	Print a list of data saved in the machine's memory.

Level 3	Level 4	Descriptions
Drum Dot Print	-	Print the Drum Dot Check Sheet.
WLAN Report	-	Print the wireless LAN connection results.

[All Settings] > [Machine Info.]

Level 3	Level 4	Level 5	Descriptions
Serial No.	-	-	Check your machine's serial number.
Firmware Version	Main Version	-	Check your machine's firmware version.
	Sub1 Version	-	
Page Counter	Total	Color	Check the number of the pages the machine has printed.
		Black and White	
	Fax	-	
	Copy	Color	
		Black and White	
	Print	Color	
		Black and White	
	Other	Color	
Black and White			
Parts Life ¹	Drum	-	Display the remaining life of the drum unit.
	Belt	-	Display the remaining life of the belt unit.
	Fuser	-	Display the remaining life of the fuser unit.
	Laser Unit	-	Display the remaining life of the laser unit.
	PF Kit MP	-	Display the remaining life of the PF kit MP.
	PF Kit 1	-	Display the remaining life of the PF Kit 1.
	PF Kit 2 ²	-	Display the remaining life of the PF Kit 2.
	PF Kit 3 ²	-	Display the remaining life of the PF Kit 3.
PF Kit 4 ²	-	Display the remaining life of the PF Kit 4.	

¹ Life is approximate and may vary by type of use.

² Available if the Optional Tray(s) is installed.

[All Settings] > [Initial Setup]

Level 3	Level 4	Descriptions
Date & Time	Date	Add the date and time on the screen and in the headings of the faxes you send.
	Time	
	Clock Type	Select the time format (12-hour or 24-hour).
	Auto Daylight	Set the machine to change automatically for Daylight Saving Time.
	Time Zone	Set your time zone.
Station ID	Fax	Enter your name and fax number so it appears on each page you fax.
	Tel	

Level 3	Level 4	Descriptions
Station ID	Name	Enter your name and fax number so it appears on each page you fax.
Tone/Pulse (Available only for some countries)	-	Select the dialing mode.
Dial Tone	-	Shorten the dial tone detect pause.
Dial Prefix	-	Set a prefix number to always be added before the fax number every time you dial.
Compatibility	-	Adjust the equalization for transmission difficulties. VoIP service providers offer fax support using various standards. If you regularly experience fax transmission errors, select Basic (for VoIP).
Reset	Machine Reset	Restore the machine settings that you have changed, such as Date and Time.
	Network Reset	Restore all network settings back to the factory settings.
	Address Book & Fax	Erase all stored phone numbers and fax settings.
	All Settings	Restore all the machine's settings back to the factory settings and delete the personal data in the memory. You cannot see the data on the machine.
	Factory Reset	Restore all the machine settings back to the factory settings and delete the personal data in the machine's memory. We recommend using this menu option if you want to delete all the data from the machine.
Local Language (Available only for some countries)	-	Change your LCD language.



Related Information

- [Settings and Features Tables](#)

Settings Tables (MFC-L8900CDW)

Related Models: MFC-L8900CDW

[All Settings] > [General Setup]

Level 3	Level 4	Level 5	Descriptions
Tray Setting	Paper Type	MP Tray	Select the paper type that matches the paper in the MP tray.
		Tray #1	Select the paper type that matches the paper in the standard paper tray.
		Tray #2 ¹	Select the paper type that matches the paper in the Optional Tray (Tray 2).
		Tray #3 ¹	Select the paper type that matches the paper in the Optional Tray (Tray 3).
		Tray #4 ¹	Select the paper type that matches the paper in the Optional Tray (Tray 4).
	Paper Size	MP Tray	Select the size of paper you loaded in the MP tray.
		Tray #1	Select the size of paper you loaded in the standard paper tray.
		Tray #2 ¹	Select the size of paper you loaded in the Optional Tray (Tray 2).
		Tray #3 ¹	Select the size of paper you loaded in the Optional Tray (Tray 3).
		Tray #4 ¹	Select the size of paper you loaded in the Optional Tray (Tray 4).
	Paper Low Notice	Paper Low Notice	Select whether to display a message telling you that the paper tray is nearly empty.
		Notice Level	Select the minimum paper level that will trigger the message.
	Check Size	-	Select whether to display a message telling you to check that the size of the paper in the machine and the machine's Paper Size setting match.
	Tray Use: Copy	-	Select the tray to be used for Copy.
	Tray Use: Fax	-	Select the tray to be used for Fax.
	Tray Use: Print	-	Select the tray to be used for Print.
Volume	Ring	-	Adjust the ring volume.
	Beep	-	Adjust the beeper volume.
	Speaker	-	Adjust the speaker volume.
LCD Settings	Backlight	-	Adjust the brightness of the LCD backlight.
	Dim Timer	-	Set how long the LCD backlight stays on after you go back to your Main Home screen.
Notice Settings	Scan Result (Skip Blank Page)	-	Displays the total scanned pages and skipped blank pages after scanning is completed.
Ecology	Toner Save	-	Increase the page yield of the toner cartridge.
	Sleep Time	-	Set how much time will pass before the machine enters Power Saving Mode.

Level 3	Level 4	Level 5	Descriptions
Ecology	Quiet Mode	-	Decrease printing noise.
	Auto Power Off	-	Set the number of hours that the machine will remain in Deep Sleep Mode before going into Power Off Mode.

¹ Available if the Optional Tray(s) is installed.

[All Settings] > [Shortcut Settings]

Level 3	Level 4	Descriptions
(Select a Shortcut)	Rename	Change the shortcut name.
	Edit	Change the shortcut settings.
	Delete	Delete the shortcut.
	Register Card/NFC	Assign a Shortcut to an ID card.
	Delete Card/NFC	Remove a Shortcut from an ID card.

[All Settings] > [Fax]

Level 3	Level 4	Level 5	Descriptions	
Setup Receive	Receive Mode	-	Select the Receive Mode that best suits your needs.	
	Ring Delay	-	Set the number of rings before the machine answers in Fax or Fax/Tel mode.	
	F/T Ring Time	-	Set the length of the pseudo/double-ring time in Fax/Tel mode.	
	Fax Preview	-	View received faxes on the LCD.	
	Easy Receive	-	Receive fax messages automatically when you answer a call and hear fax tones.	
	Remote Codes	Remote Codes	Remote Codes	Answer calls at an extension or external telephone and use codes to turn on or off the Remote Codes. You can personalize the codes.
		Fax Receive Code		
		Tel Answer		
	Auto Reduction	-	Reduce the size of incoming faxes.	
	PC Fax Receive	On	On	Set the machine to send faxes to your computer.
		Off	Off	You can turn on the Backup Print safety feature.
	Memory Receive	Off	Off	-
		Fax Forward	Fax Forward	Set the machine to forward fax messages, to call your pager or cell phone, or to store incoming faxes in the machine's memory (so you can retrieve them while you are away from your machine). If you select Fax Forward, you can turn on the Backup Print safety feature.
		Paging		
		Fax Storage		
Forward to Cloud		Forward incoming faxes to the online service.		
Fax Rx Stamp	-	Print the received time and date on the top of received faxes.		
2-sided	-	Print received faxes on both sides of the paper.		
Setup Send	Batch TX	-	Combine delayed faxes to the same fax number at the same time of day into one transmission.	
	Coverpage Setting	Print Sample	Print a sample of the fax cover page. You can fill in information and fax it with your document.	

Level 3	Level 4	Level 5	Descriptions
Setup Send	Coverpage Setting	Coverpage Message	Set up your own comments for the fax cover page.
	Auto Redial	-	Set the machine to redial the last fax number after five minutes if the fax did not go through because the line was busy.
	Destination	-	Set the machine to display the destination information on the LCD during fax dialing.
Report Setting	Transmission	-	Select the initial setup for the Transmission Verification Report.
	Journal Period	Journal Period	Set the interval for automatic printing of the Fax Journal.
		Time	If you select an option other than Off and Every 50 Faxes, you can set the time for the option.
		Day	If you select Every 7 Days, you can set the day of the week.
Print Fax	-	-	Print received faxes stored in the machine's memory.
Remote Access	-	-	Set your own code for Remote Retrieval.
Dial Restriction	Dial Pad	-	Set the machine to restrict dialing when using the dial pad.
	Address Book	-	Set the machine to restrict the dialing when using the Address Book.
	Shortcuts	-	Set the machine to restrict the dialing when using a Shortcut.
	LDAP Server	-	Set the machine to restrict the dialing of LDAP server numbers.
Remaining Jobs	-	-	Check which scheduled jobs are in the machine's memory and cancel selected jobs.
Miscellaneous	Distinctive	Distinctive	Turn on the telephone company's Distinctive Ring subscriber service to register your new ring pattern on the machine.
		Ring Pattern	Register your new ring pattern on the machine.

[All Settings] > [Printer]

Level 3	Level 4	Level 5	Descriptions
Emulation	-	-	Select the emulation mode.
Quality	-	-	Select the print quality.
Print Options	Font List	HP LaserJet	Print a list of the machine's internal fonts.
		BR-Script 3	
	Test Print	-	Print a test page.
2-sided	2-sided Print	-	Enable or disable 2-sided printing and choose long edge or short edge.
	Single Image	-	For a print job where the last page is a 1-sided image, select the 1-sided Feed option to reduce printing time. When you use letterhead or preprinted paper, you must select the 2-sided Feed option. If you select 1-sided Feed for letterhead or preprinted paper, the last page will be printed on the reverse side.

Level 3	Level 4	Level 5	Descriptions
Auto Continue	-	-	Select if you want the machine to clear paper size errors or media type errors automatically, and use paper from other trays.
Output Color	-	-	Set the output color.
HP Tray Command	-	-	Select the correct version of HP LaserJet tray emulation.
Reset Printer	-	-	Restore the printer settings to the factory settings.
Color Correction	Calibration	Calibrate	Initiate color calibration to check and correct colors.
		Reset	Reset the calibration parameters to the default settings.
	Registration	-	Align the print position of each color.
	Auto Correction	-	Set the machine to perform Color Calibration and Registration automatically.
	Color Settings	Setting Mode	Select whether to apply the color print settings of the machine or the printer driver.
		Color Mode	Select the color mode.
		Improve Gray Color	Turn on or off to improve the image quality of shaded areas.
		Enhance Black Printing	Turn on or off if a black graphic does not print correctly.
		Brightness	Adjust the brightness.
		Contrast	Adjust the contrast.
		Red	Adjust the red color.
		Green	Adjust the green color.
	Blue	Adjust the blue color.	

[All Settings] > [Network]

Level 3	Level 4	Level 5	Level 6	Descriptions
Wired LAN	TCP/IP	BOOT Method	IP Boot Tries	Select the BOOT method that best suits your needs.
		IP Address	-	Enter the IP address.
		Subnet Mask	-	Enter the Subnet mask.
		Gateway	-	Enter the Gateway address.
		Node Name	-	Enter the Node name. (up to 32 characters)
		WINS Configuration	-	Select the WINS configuration mode.
		WINS Server	Primary	Specify the IP address of the primary WINS server.
			Secondary	Specify the IP address of the secondary WINS server.
		DNS Server	Primary	Specify the IP address of the primary DNS server.
			Secondary	Specify the IP address of the secondary DNS server.

Level 3	Level 4	Level 5	Level 6	Descriptions	
Wired LAN	TCP/IP	APIPA	-	Set the machine to allocate the IP address from the link-local address range automatically.	
		IPv6	-	Turn the IPv6 protocol on or off. To use the IPv6 protocol, go to the Brother Solutions Center at support.brother.com for more information.	
	Ethernet	-	-	Select the Ethernet link mode.	
	Wired Status	-	-	View the current wired status.	
	MAC Address	-	-	View the machine's MAC address.	
	Set to Default	-	-	Restore the wired network settings to the factory settings.	
	Wired Enable (For wireless network models)	-	-	Turn the Wired LAN on or off manually.	
WLAN (For wireless network models)	TCP/IP	BOOT Method	IP Boot Tries	Select the BOOT method that best suits your needs.	
		IP Address	-	Enter the IP address.	
		Subnet Mask	-	Enter the Subnet mask.	
		Gateway	-	Enter the Gateway address.	
		Node Name	-	Enter the Node name. (up to 32 characters)	
		WINS Configuration	-	Select the WINS configuration mode.	
		WINS Server	Primary	Specify the IP address of the primary WINS server.	
			Secondary	Specify the IP address of the secondary WINS server.	
		DNS Server	Primary	Specify the IP address of the primary DNS server.	
			Secondary	Specify the IP address of the secondary DNS server.	
		APIPA	-	Set the machine to allocate the IP address from the link-local address range automatically.	
		IPv6	-	Turn the IPv6 protocol on or off. To use the IPv6 protocol, go to the Brother Solutions Center at support.brother.com for more information.	
		Setup Wizard	-	-	Configure the wireless network settings using the setup wizard.
		WLAN Assistant	-	-	Configure your wireless network settings using the Brother installation disc.
		WPS	-	-	Configure your wireless network settings using the one-button push method.
WPS w/ PIN Code	-	-	Configure your wireless network settings using WPS with a PIN.		

Level 3	Level 4	Level 5	Level 6	Descriptions	
WLAN (For wireless network models)	WLAN Status	Status	-	View the current wireless network status.	
		Signal	-	View the current wireless network signal strength.	
		SSID	-	View the current SSID.	
		Comm. Mode	-	View the current Communication Mode.	
	MAC Address	-	-	View the machine's MAC address.	
	Set to Default	-	-	Restore the wireless network settings to the factory settings.	
	WLAN Enable	-	-	Turns the wireless interface on or off.	
Wi-Fi Direct (For wireless network models)	Push Button	-	-	Configure your Wi-Fi Direct network settings using the one-button push method.	
	PIN Code	-	-	Configure your Wi-Fi Direct network settings using WPS with a PIN code.	
	Manual	-	-	Configure your Wi-Fi Direct network settings manually.	
	Group Owner	-	-	Set your machine as the Group Owner.	
	Device Information	Device Name	-	-	View your machine's device name.
		SSID	-	-	View the Group Owner's SSID. When the machine is not connected, the LCD displays Not Connected.
		IP Address	-	-	View your machine's current IP Address.
	Status Information	Status	-	-	View the current Wi-Fi Direct network status.
		Signal	-	-	View the current Wi-Fi Direct network signal strength. When your machine acts as Group Owner, the LCD always indicates a strong signal.
	I/F Enable	-	-	-	Turn the Wi-Fi Direct connection on or off.
NFC (Available only for certain models)	-	-	-	Turn the NFC function on or off.	
E-mail/IFAX	Mail Address	-	-	Enter the email address.	
	Setup Server	SMTP	Server	Enter the SMTP server name and address.	
			Port	Enter the SMTP port number.	
			Auth. for SMTP	Select the Security method for email notification.	
			SSL/TLS	Send or receive an email via an email server that requires secure SSL/TLS communication.	
Verify Cert.		Verify the SMTP Server Certificate automatically.			

Level 3	Level 4	Level 5	Level 6	Descriptions
E-mail/IFAX	Setup Server	POP3/IMAP4	Protocol	Select the protocol for receiving an email from the server.
			Server	Enter the server name and address.
			Port	Enter the port number.
			Mailbox Name	Enter the mailbox name. (Up to 60 characters)
			Mailbox Password	Enter the password to login to the server. (Up to 32 characters)
			Select Folder	Select the specified folder in the mailbox using the IMAP4 protocol.
			SSL/TLS	Send or receive an email via an email server that requires secure SSL/TLS communication.
			Verify Cert.	Verify the SMTP Server Certificate automatically.
			APOP	Turn APOP on or off.
	Setup Mail RX	Auto Polling	Auto Polling	Check the server for new messages automatically.
			Poll Frequency	Set the interval for checking new messages on the server.
		Header	-	Select the contents of the email header to be printed.
		Del/Read Error Mail	-	The POP3 server deletes error emails automatically. The IMAP4 server deletes error emails automatically after you read them.
		Notification	-	Receive notification messages.
	Setup Mail TX	Sender Subject	-	View the subject.
		Size Limit	Size Limit	Limit the size of email documents.
			Maximum Size (MB)	
		Notification	-	Send notification messages.
	Setup Relay	Relay Broadcast	-	Relay a document to another fax machine.
		Relay Domain	Relay XX	Register the Domain name.
		Relay Report	-	Print the relay Broadcast Report.
	Manual Receive	-	-	Check the POP3 or IMAP4 server for new messages manually.
	Web Connect Settings	Proxy Settings	Proxy Connection	-
Address			-	
Port			-	
User Name			-	
Password			-	
Fax to Server	Fax to Server	-	-	Select the network connection type.
	Prefix	-	-	

Level 3	Level 4	Level 5	Level 6	Descriptions
Fax to Server	Suffix	-	-	Select the network connection type.
IPsec	-	-	-	IPsec is an optional security feature of the IP protocol that provides authentication and encryption services. We recommend contacting your network administrator before changing this setting.
Network Reset	-	-	-	Restore all network settings back to the factory settings.

[All Settings] > [Print Reports]

Level 3	Level 4	Descriptions
Transmission	View on LCD	Display Transmission Verification Reports about sent faxes.
	Print Report	Print a Transmission Verification Report of your last transmission.
Address Book	-	Print a list of names and numbers stored in the Address Book.
Fax Journal	-	Print a list of information about your last 200 incoming and outgoing faxes. (TX means Transmit. RX means Receive.)
User Settings	-	Print a list of your settings.
Printer Settings	-	Print a list of your Printer settings.
Network Configuration	-	Print a list of your Network settings.
Print File List	-	Print a list of data saved in the machine's memory.
Drum Dot Print	-	Print the Drum Dot Check Sheet.
WLAN Report (For wireless network models)	-	Print the wireless LAN connection results.

[All Settings] > [Machine Info.]

Level 3	Level 4	Level 5	Descriptions
Serial No.	-	-	Check your machine's serial number.
Firmware Version	Main Version	-	Check your machine's firmware version.
	Sub1 Version	-	
Page Counter	Total	Color	Check the number of the pages the machine has printed.
		Black and White	
	Fax	-	
	Copy	Color	
		Black and White	
	Print	Color	
		Black and White	
	Other	Color	
Black and White			
Parts Life ¹	Drum	-	Display the remaining life of the drum unit.
	Belt	-	Display the remaining life of the belt unit.

Level 3	Level 4	Level 5	Descriptions
Parts Life ¹	Fuser	-	Display the remaining life of the fuser unit.
	Laser Unit	-	Display the remaining life of the laser unit.
	PF Kit MP	-	Display the remaining life of the PF kit MP.
	PF Kit 1	-	Display the remaining life of the PF Kit 1.
	PF Kit 2 ²	-	Display the remaining life of the PF Kit 2.
	PF Kit 3 ²	-	Display the remaining life of the PF Kit 3.
	PF Kit 4 ²	-	Display the remaining life of the PF Kit 4.

¹ Life is approximate and may vary by type of use.

² Available if the Optional Tray(s) is installed.

[All Settings] > [Initial Setup]

Level 3	Level 4	Descriptions
Date & Time	Date	Add the date and time on the screen and in the headings of the faxes you send.
	Time	
	Clock Type	Select the time format (12-hour or 24-hour).
	Auto Daylight	Set the machine to change automatically for Daylight Saving Time.
	Time Zone	Set your time zone.
Station ID	Fax	Enter your name and fax number so it appears on each page you fax.
	Tel	
	Name	
Tone/Pulse (Available only for some countries)	-	Select the dialing mode.
Dial Tone	-	Shorten the dial tone detect pause.
Dial Prefix	-	Set a prefix number to always be added before the fax number every time you dial.
Compatibility	-	Adjust the equalization for transmission difficulties. VoIP service providers offer fax support using various standards. If you regularly experience fax transmission errors, select Basic (for VoIP).
Reset	Machine Reset	Restore the machine settings that you have changed, such as Date and Time.
	Network Reset	Restore all network settings back to the factory settings.
	Address Book & Fax	Erase all stored phone numbers and fax settings.
	All Settings	Restore all the machine's settings back to the factory settings and delete the personal data in the memory. You cannot see the data on the machine.
	Factory Reset	Restore all the machine settings back to the factory settings and delete the personal data in the machine's memory. We recommend using this menu option if you want to delete all the data from the machine.
Local Language (Available only for some countries)	-	Change your LCD language.



[Admin Settings]

Level 2	Level 3	Level 4	Level 5	Descriptions
Home Screen Settings	Icons	-	-	Delete icons, add icons or move icons to other places on the Home screens.
	Background Color	-	-	Change the background color on the Touchscreen to White or Black.
	Tabs	Rename	Tab 1	Change the name of the tabs.
			Tab 2	
			Tab 3	
			Tab 4	
			Tab 5	
Tab 6				
	Main Home Screen	-	Set your Main Home screen.	
Home Screen Settings Reset	-	-	Restore Home screen settings back to the factory settings.	
Other Screen Settings	Copy Screen	-	-	Set the default Copy screen settings.
	Scan Screen	-	-	Set the default Scan screen settings.
Restriction Management	User Restriction Function	-	-	Enable or disable the restriction function, such as Secure Function Lock.
	Setting Lock	-	-	Restrict unauthorized users from changing the machine's settings.
	Setting Lock Details	-	-	Select the specific machine settings you want to restrict unauthorized users from changing.
Password	-	-	-	Register or change the password to log on to the Admin Settings menu.



Related Information

- [Settings and Features Tables](#)

Feature Tables (MFC-L8610CDW)

Related Models: MFC-L8610CDW

[Toner]

Level 3	Level 4	Descriptions
Toner Life	-	View the approximate remaining toner life for each color.
Test Print	-	Print a test page.
Calibration	Calibrate	Initiate color calibration to check and correct colors.
	Reset	Reset the calibration parameters to the default settings.
Registration	-	Align the print position of each color.

[Fax] (When Fax Preview is Off)

Level 3	Level 4	Level 5	Level 6	Descriptions
Redial / Pause	-	-	-	Redial the last number called. When you are entering a fax or telephone number on the control panel, Redial changes to Pause on the LCD. Press Pause when you need a delay while dialing numbers, such as access codes and credit card numbers. You can also store a pause when you set up addresses.
Hook	-	-	-	Press before dialing if you want to listen to make sure a fax machine has answered, and then press Fax Start.
Address Book	 (Search)	-	-	Search within the Address Book.
	Edit	Add New Address	Name Address	Store Address Book numbers, set up Group numbers for Broadcasting, change and delete Address Book numbers.
		Setup Groups	Name Add/ Delete	
		Change	(Select Address)	
		Delete	(Select Address)	
	(Select Address Book)	Apply	-	Start sending a fax using the Address Book.
Call History	Outgoing Call	(Select Outgoing Call)	Apply	Select a number from the Outgoing Call history and then send a fax to it, add it to the Address Book, or delete it.
			Edit	
Fax Start	-	-	-	Send a fax.
Options	Fax Resolution	-	-	Set the resolution for outgoing faxes.
	Contrast	-	-	Adjust the contrast.
	2-sided Fax	-	-	Set the 2-sided scanning format.

Level 3	Level 4	Level 5	Level 6	Descriptions
Options	Glass Scan Size	-	-	Adjust the scan area of the scanner glass to the size of the document.
	Broadcasting	Add Number	Add Number	Send the same fax message to more than one fax number.
			Add from Address book	
			Search in Address book	
	Delayed Fax	Delayed Fax	-	Set the time of day the delayed faxes will be sent.
		Set Time	-	
	Real Time TX	-	-	Send a fax without using the memory.
	Coverpage Setup	Coverpage Setup	-	Set the machine to automatically send a cover page that you have pre-programmed.
		Coverpage Message	-	
Total Pages		-		
Overseas Mode	-	-	Set to On if you have difficulty sending faxes overseas.	
Set New Default	-	-	Save your settings as the default.	
Factory Reset	-	-	Restore all settings back to the factory settings.	
Save as Shortcut	-	-	-	Save the current settings as a shortcut.



[Fax] (When Fax Preview is On)

Level 3	Level 4	Level 5	Descriptions
Sending Fax(es)	Redial / Pause	-	Redial the last number called. When you are entering a fax or telephone number on the control panel, Redial changes to Pause on the LCD. Press Pause when you need a delay while dialing numbers, such as access codes and credit card numbers. You can also store a pause when you set up addresses.
	Hook	-	Press before dialing if you want to listen to make sure a fax machine has answered, and then press Fax Start.
	Address Book	-	Select the address of the recipient from the address book.
	Call History	-	Select a number from the Outgoing Call history and then send a fax to it, add it to the Address Book, or delete it.
	Fax Start	-	Send a fax.
	Options	-	Select your settings.
	Save as Shortcut	-	Save the current settings as a shortcut.
Received Faxes	Print/Delete	Print All:New Fax(es)	Print the new received faxes.
		Print All (Old Faxes)	Print the old received faxes.

Level 3	Level 4	Level 5	Descriptions
Received Faxes	Print/Delete	Delete All:New Fax(es)	Delete the new received faxes.
		Delete All (Old Faxes)	Delete the old received faxes.
Address Book	-	-	Select the address of the recipient from the address book.
Call History	-	-	Select a number from the Outgoing Call history and then send a fax to it, add it to the Address Book, or delete it.



[Copy]

Level 3	Level 4	Level 5	Descriptions
Black Start	-	-	Make a black and white or grayscale copy.
Color Start	-	-	Make a color copy.
> (more Copy options)	Receipt	Black Start	Set the preset copy settings of Receipt.
		Color Start	
		Save as Shortcut	
		> (more Copy options)	
		Options	
	Normal	Black Start	Set the preset copy settings of Normal.
		Color Start	
		Save as Shortcut	
		> (more Copy options)	
		Options	
	2in1 (ID)	Black Start	Set the preset copy settings of 2in1(ID).
		Color Start	
		Save as Shortcut	
		> (more Copy options)	
		Options	
	2in1	Black Start	Set the preset copy settings of 2in1.
		Color Start	
		Save as Shortcut	
		> (more Copy options)	
		Options	
	2sided(1⇒2)	Black Start	Set the preset copy settings of 2-sided(1⇒2).
		Color Start	
		Save as Shortcut	
		> (more Copy options)	
Options			
2sided(2⇒2)		Black Start	Set the preset copy settings of 2-sided(2⇒2).
		Color Start	
		Save as Shortcut	

Level 3	Level 4	Level 5	Descriptions	
> (more Copy options)	2sided(2⇒2)	> (more Copy options)	Set the preset copy settings of 2-sided(2⇒2).	
		Options		
	Paper Save	Black Start	Black Start	Set the preset copy settings of Paper Save.
			Color Start	
			Save as Shortcut	
			> (more Copy options)	
			Options	
	Black Start	-	Start Copying.	
	Color Start	-		
	Options	-	Select your settings.	
Options	Enlarge/Reduce	100%	-	
		Enlarge	Select an enlargement ratio for the next copy.	
		Reduce	Select a reduction ratio for the next copy.	
		Custom(25-400%)	Enter an enlargement or reduction ratio.	
	Density	-	Adjust the density.	
	Tray Use	-	Select the tray that will be used.	
	2-sided Copy	Layout	Turn off or turn on 2-sided copying and select flip on long edge or flip on short edge.	
	2-sided Copy Page Layout	-	Select a page layout option when you make 2-sided N in 1 copies from a 2-sided document.	
	Quality	-	Select the Copy resolution for your document type.	
	Contrast	-	Adjust the contrast.	
	Stack/Sort	-	Select to stack or sort multiple copies.	
	Page Layout	-	Make N in 1 and 2 in 1 ID copies.	
	Color Adjust	-	Adjust the color for copies.	
Remove Background Color	-	Change the amount of background color that is removed.		
Save as Shortcut	-	-	Save the current settings as a shortcut.	



[Scan]

Level 3	Level 4	Level 5	Level 6	Descriptions
to USB	Scan Actions	-	-	Scan documents to a USB Flash memory drive.
	Options	Resolution	-	
		File Type	-	
		Scan Type	-	
		2-sided Scan	-	
		Document Size	-	
		Brightness	-	
		Contrast	-	
		File Name	-	

Level 3	Level 4	Level 5	Level 6	Descriptions
to USB	Options	File Name Style	-	Scan documents to a USB Flash memory drive.
		File Size	-	
		ADF Auto Deskew	-	
		Skip Blank Page	-	
		Skip Blank Page Sensitivity	-	
		Remove Background Color	-	
		Set New Default	-	
	Factory Reset	-		
Save as Shortcut	-	-		
Start	-	-		
to PC	to File	Scan Actions	-	Scan documents and save them to a folder on your computer.
		(Select USB or PC)	Options	
			Save as Shortcut	
			Start	
	to OCR	Scan Actions	-	Convert your scanned document to an editable text file.
		(Select USB or PC)	Options	
			Save as Shortcut	
			Start	
	to Image	Scan Actions	-	Scan photos or graphics into your graphics applications.
		(Select USB or PC)	Options	
			Save as Shortcut	
			Start	
to E-mail	Scan Actions	-	Send a scanned document as an email attachment.	
	(Select USB or PC)	Options		
		Save as Shortcut		
		Start		
to E-mail Server (MFC-L8610CDW: Available after Scan to Email Server is downloaded)	Scan Actions	-	-	Scan a black and white or a color document to the email address you want.
	Cancel	-	-	
	Manual	-	-	
	Address Book	 (Search)	-	
	Edit	-	-	

Level 3	Level 4	Level 5	Level 6	Descriptions
to E-mail Server (MFC-L8610CDW: Available after Scan to Email Server is downloaded)	Address Book	(Select Address Book)	-	Scan a black and white or a color document to the email address you want.
	Next	Destinations	-	
		Options	-	
		Save as Shortcut	-	
		Start	-	
Destinations	(Select Address)	-		
to My E-mail	-	-	-	Scan a black and white or a color document to your email address.
to FTP/SFTP	Scan Actions	-	-	Send scanned data via FTP/ SFTP.
	(Select Profile name)	Options	-	
		Save as Shortcut	-	
		Start	-	
to Network	Scan Actions	-	-	Send scanned data to a CIFS server on your local network or on the Internet.
	(Select Profile name)	Options	-	
		Save as Shortcut	-	
		Start	-	
to My Folder	-	-	-	Send scanned data to your folder in the CIFS server on your local network or on the Internet.
to SharePoint	Scan Actions	-	-	Send scanned data via a SharePoint® server.
	(Select Profile name)	Options	-	
		Save as Shortcut	-	
		Start	-	
to Web	-	-	-	Upload the scanned data to an Internet service.
WS Scan (Appears when you install a Web Services Scanner, which is displayed in your computer's Network explorer.)	Scan Actions	-	-	Scan data using the Web Service protocol.
	Scan	-	-	
	Scan for E- mail	-	-	
	Scan for Fax	-	-	
	Scan for Print	-	-	

WiFi (Wi-Fi®)

Level 3	Descriptions
TCP/IP 1	Change the TCP/IP settings.
Setup Wizard	Configure the wireless network settings using the setup wizard.
WLAN Assistant	Configure your wireless network settings using the Brother installation disc.
WPS	Configure your wireless network settings using the one-button push method.

Level 3	Descriptions
WPS w/ PIN Code 1	Configure the wireless network settings using WPS with a PIN code.
WLAN Status 1	Display the wireless network connection status.
MAC Address 1	Display the MAC address of the machine.
Set to Default 1	Restore wireless network settings of your machine to the factory settings.
WLAN Enable 1	Turn the wireless interface on or off.

¹ Available after the Wi-Fi® is set up

[Shortcuts]

Level 1	Level 2	Level 3	Descriptions
Edit/ Delete	(Select Shortcut)	Rename	Change the shortcut name.
		Edit	Change the shortcut settings.
		Delete	Delete the shortcut.
Add Shortcut	Copy	-	Select the settings you want.
	Fax	-	Select the settings you want.
	Scan	to File	Scan a black and white or a color document to your computer.
		to OCR	Convert your scanned document to an editable text file.
		to Image	Scan a color picture into your graphics application.
		to USB	Scan documents to a USB Flash memory drive.
		to E-mail	Scan a black and white or a color document into your email application.
		to E-mail Server (Available after Scan to Email Server is downloaded)	Scan a black and white or a color document to the email address you want.
		to Network	Send scanned data to a CIFS server on your local network or on the Internet.
		to FTP/SFTP	Send scanned data via FTP/SFTP.
	to SharePoint	Send scanned data via a SharePoint® server.	
Web	-	Connect the Brother machine to an Internet service. Web services may have been added and service names may have been changed by the provider since this document was published. Go to your model's Manuals page on the Brother Solutions Center at support.brother.com to download the Web Connect Guide.	
Apps	-	Connect the Brother machine to the Brother Apps service.	
These lists appears when each Shortcut name is pressed for two seconds.	Rename	-	Change the shortcut name.
	Edit	-	Change the shortcut settings.

Level 1	Level 2	Level 3	Descriptions
These lists appears when each Shortcut name is pressed for two seconds.	Delete	-	Delete the shortcut.



[Secure Print]

Level 1	Level 2	Level 3	Descriptions
Secure Print	(Select User)	(Select Secure Print Job)	You can print data saved in the machine's memory when you enter your four-digit password. Active only when the machine has secure print data.



[Web]

Level 1	Descriptions
Web	Connect the Brother machine to an Internet service.



[Apps]

Level 1	Descriptions
Apps	Connect the Brother machine to the Brother Apps service.



[USB]

Level 1	Level 2	Descriptions
USB	Scan to USB	Scan documents to a USB Flash memory drive.
	Direct Print	Print the data directly from the USB flash drive.



[2 in 1 ID Copy]

Level 1	Descriptions
2 in 1 ID Copy	Copy both sides of an identification card onto one page.



Related Information

- [Settings and Features Tables](#)

Feature Tables (MFC-L8900CDW)

Related Models: MFC-L8900CDW



(Wired Network Setup)

Level 3	Descriptions
TCP/IP	Change the TCP/IP settings.
Ethernet	Select the Ethernet link mode.
Wired Status	View the current wired status.
MAC Address	View the machine's MAC address.
Set to Default	Restore the wired network settings to the factory settings.
Wired Enable	Turn the Wired LAN on or off manually.



(Wi-Fi® Setup)

For wireless network models

Level 3	Descriptions
TCP/IP 1	Change the TCP/IP settings.
Setup Wizard	Configure the wireless network settings using the setup wizard.
WLAN Assistant	Configure your wireless network settings using the Brother installation disc.
WPS	Configure your wireless network settings using the one-button push method.
WPS w/ PIN Code 1	Configure the wireless network settings using WPS with a PIN code.
WLAN Status 1	Display the wireless network connection status.
MAC Address 1	Display the MAC address of the machine.
Set to Default 1	Restore wireless network settings of your machine to the factory settings.
WLAN Enable 1	Turn the wireless interface on or off.

¹ Available after the Wi-Fi® is set up



[Toner]

Level 3	Level 4	Descriptions
Toner Life	-	View the approximate remaining toner life for each color.
Test Print	-	Print a test page.
Calibration	Calibrate	Initiate color calibration to check and correct colors.
	Reset	Reset the calibration parameters to the default settings.
Registration	-	Align the print position of each color.



[Admin Settings]

Level 2	Descriptions
Admin Settings	Change the screen settings and restrict use of the machine.



[Fax] (When Fax Preview is Off)

Level 3	Level 4	Level 5	Level 6	Descriptions
Redial / Pause	-	-	-	Redial the last number called. When you are entering a fax or telephone number on the control panel, Redial changes to Pause on the LCD. Press Pause when you need a delay while dialing numbers, such as access codes and credit card numbers. You can also store a pause when you set up addresses.
Hook	-	-	-	Press before dialing if you want to listen to make sure a fax machine has answered, and then press Fax Start.
Address Book	 (Search)	-	-	Search within the Address Book.
	Edit	Add New Address	Name Address	Store Address Book numbers, set up Group numbers for Broadcasting, change and delete Address Book numbers.
		Setup Groups	Name Add/ Delete	
		Change	(Select Address)	
		Delete	(Select Address)	
	(Select Address Book)	Apply	-	Start sending a fax using the Address Book.
Call History	Outgoing Call	(Select Outgoing Call)	Apply	Select a number from the Outgoing Call history and then send a fax to it, add it to the Address Book, or delete it.
			Edit	
Fax Start	-	-	-	Send a fax.
Options	Fax Resolution	-	-	Set the resolution for outgoing faxes.
	Contrast	-	-	Adjust the contrast.
	2-sided Fax	-	-	Set the 2-sided scanning format.
	Glass Scan Size	-	-	Adjust the scan area of the scanner glass to the size of the document.
	Broadcasting	Add Number	Add Number	Send the same fax message to more than one fax number.
			Add from Address book	
Search in Address book				
Delayed Fax	Delayed Fax	-	Set the time of day the delayed faxes will be sent.	
		Set Time		-

Level 3	Level 4	Level 5	Level 6	Descriptions
Options	Real Time TX	-	-	Send a fax without using the memory.
	Coverpage Setup	Coverpage Setup	-	Set the machine to automatically send a cover page that you have pre-programmed.
		Coverpage Message	-	
		Total Pages	-	
	Overseas Mode	-	-	Set to On if you have difficulty sending faxes overseas.
	Set New Default	-	-	Save your settings as the default.
Factory Reset	-	-	Restore all settings back to the factory settings.	
Save as Shortcut	-	-	-	Save the current settings as a shortcut.



[Fax] (When Fax Preview is On)

Level 3	Level 4	Level 5	Level 6	Descriptions
Sending Fax(es)	Redial / Pause	-	-	Redial the last number called. When you are entering a fax or telephone number on the control panel, Redial changes to Pause on the LCD. Press Pause when you need a delay while dialing numbers, such as access codes and credit card numbers. You can also store a pause when you set up addresses.
	Hook	-	-	Press before dialing if you want to listen to make sure a fax machine has answered, and then press Fax Start.
	Address Book	-	-	Select the address of the recipient from the address book.
	Call History	-	-	Select a number from the Outgoing Call history and then send a fax to it, add it to the Address Book, or delete it.
	Fax Start	-	-	Send a fax.
	Options	-	-	Select your settings.
	Save as Shortcut	-	-	Save the current settings as a shortcut.
Received Faxes	Print/Delete	Print All:New Fax(es)	-	Print the new received faxes.
		Print All(Old Faxes)	-	Print the old received faxes.
		Delete All:New Fax(es)	-	Delete the new received faxes.
		Delete All(Old Faxes)	-	Delete the old received faxes.
Address Book	-	-	-	Select the address of the recipient from the address book.
Call History	-	-	-	Select a number from the Outgoing Call history and then send a fax to it, add it to the Address Book, or delete it.



[Copy]

Level 3	Level 4	Level 5	Descriptions
Black Start	-	-	Make a black and white or grayscale copy.
Color Start	-	-	Make a color copy.
> (more Copy options)	Receipt	Black Start	Set the preset copy settings of Receipt.
		Color Start	
		Save as Shortcut	
		> (more Copy options)	
		Options	
	Normal	Black Start	Set the preset copy settings of Normal.
		Color Start	
		Save as Shortcut	
		> (more Copy options)	
		Options	
	2in1 (ID)	Black Start	Set the preset copy settings of 2in1(ID).
		Color Start	
		Save as Shortcut	
		> (more Copy options)	
		Options	
	2in1	Black Start	Set the preset copy settings of 2in1.
		Color Start	
		Save as Shortcut	
		> (more Copy options)	
		Options	
	2sided (1⇒2)	Black Start	Set the preset copy settings of 2-sided(1⇒2).
		Color Start	
		Save as Shortcut	
		> (more Copy options)	
Options			
2sided (2⇒2)	Black Start	Set the preset copy settings of 2-sided(2⇒2).	
	Color Start		
	Save as Shortcut		
	> (more Copy options)		
	Options		
Paper Save	Black Start	Set the preset copy settings of Paper Save.	
	Color Start		
	Save as Shortcut		
	> (more Copy options)		
	Options		
Options	Enlarge/Reduce	100%	-
		Enlarge	Select an enlargement ratio for the next copy.

Level 3	Level 4	Level 5	Descriptions
Options	Enlarge/Reduce	Reduce	Select a reduction ratio for the next copy.
		Custom (25-400%)	Enter an enlargement or reduction ratio.
	Density	-	Adjust the density.
	Tray Use	-	Select the tray that will be used.
	2-sided Copy	Layout	Turn off or turn on 2-sided copying and select flip on long edge or flip on short edge.
	2-sided Copy Page Layout	-	Select a page layout option when you make 2-sided N in 1 copies from a 2-sided document.
	Quality	-	Select the Copy resolution for your document type.
	Contrast	-	Adjust the contrast.
	Stack/Sort	-	Select to stack or sort multiple copies.
	Page Layout	-	Make N in 1 and 2 in 1 ID copies.
	Color Adjust	-	Adjust the color for copies.
Remove Background Color	-	Change the amount of background color that is removed.	
Save as Shortcut	-	-	Save the current settings as a shortcut.



[Scan]

Level 3	Level 4	Level 5	Level 6	Descriptions	
to USB	Scan Actions	-	-	Scan documents to a USB Flash memory drive.	
	Options	Resolution	-		
		File Type	-		
		Scan Type	-		
		2-sided Scan	-		
		Document Size	-		
		Brightness	-		
		Contrast	-		
		File Name	-		
		File Name Style	-		
		File Size	-		
		ADF Auto Deskew	-		
		Skip Blank Page	-		
		Skip Blank Page Sensitivity	-		
		Remove Background Color	-		
	Set New Default	-			
Factory Reset	-				
Save as Shortcut	-	-			
Start	-	-			

Level 3	Level 4	Level 5	Level 6	Descriptions	
to PC	to File	Scan Actions	-	Scan documents and save them to a folder on your computer.	
		(Select USB or PC)	Options		
			Save as Shortcut		
			Start		
	to OCR	Scan Actions	-	Convert your scanned document to an editable text file.	
		(Select USB or PC)	Options		
			Save as Shortcut		
			Start		
	to Image	Scan Actions	-	Scan photos or graphics into your graphics applications.	
		(Select USB or PC)	Options		
			Save as Shortcut		
			Start		
to E-mail	Scan Actions	-	Send a scanned document as an email attachment.		
	(Select USB or PC)	Options			
		Save as Shortcut			
		Start			
to E-mail Server	Scan Actions	-	-	Scan a black and white or a color document to the email address you want.	
	Cancel	-	-		
	Manual	-	-		
	Address Book	 (Search)	-		-
		Edit	-		-
		(Select Address Book)	-		-
	Next	Destinations	-		-
		Options	-		-
Save as Shortcut		-	-		
Start		-	-		
Destinations	(Select Address)	-	-		
to My E-mail	-	-	-	Scan a black and white or a color document to your email address.	
to FTP/SFTP	Scan Actions	-	-	Send scanned data via FTP/SFTP.	
	(Select Profile name)	Options	-		
		Save as Shortcut	-		
		Start	-		
to Network	Scan Actions	-	-	Send scanned data to a CIFS server on your local network or on the Internet.	
	(Select Profile name)	Options	-		

Level 3	Level 4	Level 5	Level 6	Descriptions
to Network	(Select Profile name)	Save as Shortcut	-	Send scanned data to a CIFS server on your local network or on the Internet.
		Start	-	
to My Folder	-	-	-	Send scanned data to your folder in the CIFS server on your local network or on the Internet.
to SharePoint	Scan Actions	-	-	Send scanned data via a SharePoint® server.
	(Select Profile name)	Options	-	
		Save as Shortcut	-	
Start	-	-		
to Web	-	-	-	Upload the scanned data to an Internet service.
WS Scan (Appears when you install a Web Services Scanner, which is displayed in your computer's Network explorer.)	Scan Actions	-	-	Scan data using the Web Service protocol.
	Scan	-	-	
	Scan for E-mail	-	-	
	Scan for Fax	-	-	
	Scan for Print	-	-	



[Secure Print]

Level 2	Level 3	Level 4	Descriptions
Secure Print	(Select User)	(Select Secure Print Job)	You can print data saved in the machine's memory when you enter your four-digit password. Active only when the machine has secure print data.



[Web]

Level 2	Descriptions
Web	Connect the Brother machine to an Internet service.



[Apps]

Level 2	Descriptions
Apps	Connect the Brother machine to the Brother Apps service.



[USB]

Level 2	Level 3	Descriptions
USB	Scan to USB	Scan documents to a USB Flash memory drive.
	Direct Print	Print the data directly from the USB flash drive.



(Shortcuts)

Level 3	Level 4	Level 5	Descriptions
Add Shortcut	Copy	-	Select the settings you want.

Level 3	Level 4	Level 5	Descriptions
Add Shortcut	Fax	-	Select the settings you want.
	Scan	to File	Scan a black and white or a color document to your computer.
		to OCR	Convert your scanned document to an editable text file.
		to Image	Scan a color picture into your graphics application.
		to USB	Scan documents to a USB Flash memory drive.
		to E-mail	Scan a black and white or a color document into your email application.
		to E-mail Server	Scan a black and white or a color document to the email address you want.
		to Network	Send scanned data to a CIFS server on your local network or on the Internet.
		to FTP/SFTP	Send scanned data via FTP/SFTP.
	to SharePoint	Send scanned data via a SharePoint® server.	
	Web	-	Connect the Brother machine to an Internet service. Web services may have been added and service names may have been changed by the provider since this document was published. Go to your model's Manuals page on the Brother Solutions Center at support.brother.com to download the Web Connect Guide.
	Apps	-	Connect the Brother machine to the Brother Apps service.
These lists appears when each Shortcut name is pressed for two seconds.	Rename	-	Change the shortcut name.
	Edit	-	Change the shortcut settings.
	Delete	-	Delete the shortcut.
	Register Card/NFC	-	Assign a Shortcut to an ID card.
	Delete Card/NFC	-	Remove a Shortcut from an ID card.



[2 in 1 ID Copy]

Level 2	Descriptions
2 in 1 ID Copy	Copy both sides of an identification card onto one page.



Related Information

- [Settings and Features Tables](#)

Change Machine Settings from Your Computer

- [Change Machine Settings Using Web Based Management](#)
- [Change the Machine Settings Using Remote Setup](#)
- [Where Can I Find My Brother Machine's Network Settings?](#)
- [Network Management Software and Utilities](#)

Change Machine Settings Using Web Based Management

Web Based Management is a utility that uses a standard web browser to manage your machine using the Hyper Text Transfer Protocol (HTTP) or Hyper Text Transfer Protocol over Secure Socket Layer (HTTPS).

- [What is Web Based Management?](#)
- [Access Web Based Management](#)
- [Set a Login Password for Web Based Management](#)
- [Network Management Software and Utilities](#)

What is Web Based Management?

Web Based Management is a utility that uses a standard web browser to manage your machine using the Hyper Text Transfer Protocol (HTTP) or Hyper Text Transfer Protocol over Secure Socket Layer (HTTPS). Type your machine's IP address into your web browser to access and change your print server settings.



- We recommend Microsoft® Internet Explorer® 11 for Windows® and Safari 9 for Macintosh. Make sure that JavaScript and Cookies are always enabled in whichever browser you use.
- You must use the TCP/IP protocol on your network and have a valid IP address programmed into the print server and your computer.

The screenshot displays the Brother web-based management interface. At the top, there is a header with the IP address 'XXX -XXXX', a 'Please configure the password >>' button, and the 'brother' logo. Below the header is a navigation bar with tabs for 'General', 'Address Book', 'Fax', 'Copy', 'Print', 'Scan', 'Administrator', and 'Network'. The 'General' tab is selected. On the right side of the navigation bar, there is a 'Brother Solutions Center' logo and a 'Bottom' dropdown menu. The main content area is titled 'Status' and contains several sections: 'Device Status' with a green bar indicating 'Ready'; 'Automatic Refresh' with radio buttons for 'Off' (selected) and 'On'; 'Toner Level' with four color-coded bars for BK (black), C (cyan), M (magenta), and Y (yellow); 'Web Language' with a dropdown menu set to 'Auto'; and 'Device Location' with fields for 'Contact' and 'Location'.

- The actual screen may differ from the screen shown above.



Related Information

- [Change Machine Settings Using Web Based Management](#)

Access Web Based Management

- We recommend using the HTTPS security protocol when configuring settings using Web Based Management.
- When you use HTTPS for Web Based Management configuration, your browser will display a warning dialog box.

1. Start your web browser.
2. Type "http://machine's IP address" in your browser's address bar (where "machine's IP address" is the machine's IP address).

For example:

http://192.168.1.2



- If you are using a Domain Name System or enable a NetBIOS name, you can type another name, such as "SharedPrinter" instead of the IP address.

- For example:

http://SharedPrinter

If you enable a NetBIOS name, you can also use the node name.

- For example:

http://brnxxxxxxxxxxxx

The NetBIOS name can be found in the Network Configuration Report.

- For Macintosh, access Web Based Management by clicking the machine's icon on the **Status Monitor** screen.

3. No password is required by default. Type a password if you have set one, and then click .

You can now change the print server settings.

If you change the protocol settings, you must restart the machine after clicking **Submit** to activate the configuration.



Related Information

- [Change Machine Settings Using Web Based Management](#)
- [Print the Network Configuration Report](#)

Set a Login Password for Web Based Management

We recommend setting a login password to prevent unauthorized access to Web Based Management.

1. Start your web browser.
2. Type "http://machine's IP address" in your browser's address bar (where "machine's IP address" is the machine's IP address).

For example:

http://192.168.1.2



- If you are using a Domain Name System or enable a NetBIOS name, you can type another name, such as "SharedPrinter" instead of the IP address.

- For example:

http://SharedPrinter

If you enable a NetBIOS name, you can also use the node name.

- For example:

http://brnxxxxxxxxxxxx

The NetBIOS name can be found in the Network Configuration Report.

- For Macintosh, access Web Based Management by clicking the machine's icon on the **Status Monitor** screen.

3. No password is required by default. Type a password if you have set one, and then click .
4. Click **Administrator**.
5. Type the password you want to use in the **Enter New Password** field (8 to 32 characters).
6. Retype the password in the **Confirm New Password** field.
7. Click **Submit**.

In the future, every time you access Web Based Management, type the password in the **Login** field, and then click .

After configuring the settings, log off by clicking .



If you have not previously set a login password, you can also set a password by clicking the **Please configure the password** button on the machine's web page.



Related Information

- [Change Machine Settings Using Web Based Management](#)

Change the Machine Settings Using Remote Setup

The Remote Setup program lets you configure many of your Brother machine's settings from your computer. When you start Remote Setup, the settings on your Brother machine will be downloaded to your computer and displayed on your screen. If you change the settings on your computer, you can upload them directly to the machine.

- [Remote Setup \(Windows®\)](#)
- [Remote Setup \(Macintosh\)](#)

Remote Setup (Windows®)

- [Set Up the Brother Machine from Your Computer \(Windows®\)](#)
- [Set Up the Brother Machine Using ControlCenter4 \(Windows®\)](#)
- [Set Up Your Machine's Address Book Using ControlCenter4 \(Windows®\)](#)

Set Up the Brother Machine from Your Computer (Windows®)

 If Secure Function Lock is set to On, you cannot use Remote Setup.

1. Do one of the following:

- Windows® 7

Click  (**Start**) > **All Programs** > **Brother** > **Brother Utilities**.

Click the drop-down list and select your model name (if not already selected). Click **Tools** in the left navigation bar, and then click **Remote Setup**.

- Windows® 8 and Windows® 10

Launch  (**Brother Utilities**), and then click the drop-down list and select your model name (if not already selected). Click **Tools** in the left navigation bar, and then click **Remote Setup**.

The Remote Setup Program window appears.

 When your machine is connected via a Network, type the password if required.

2. Configure the settings as needed.

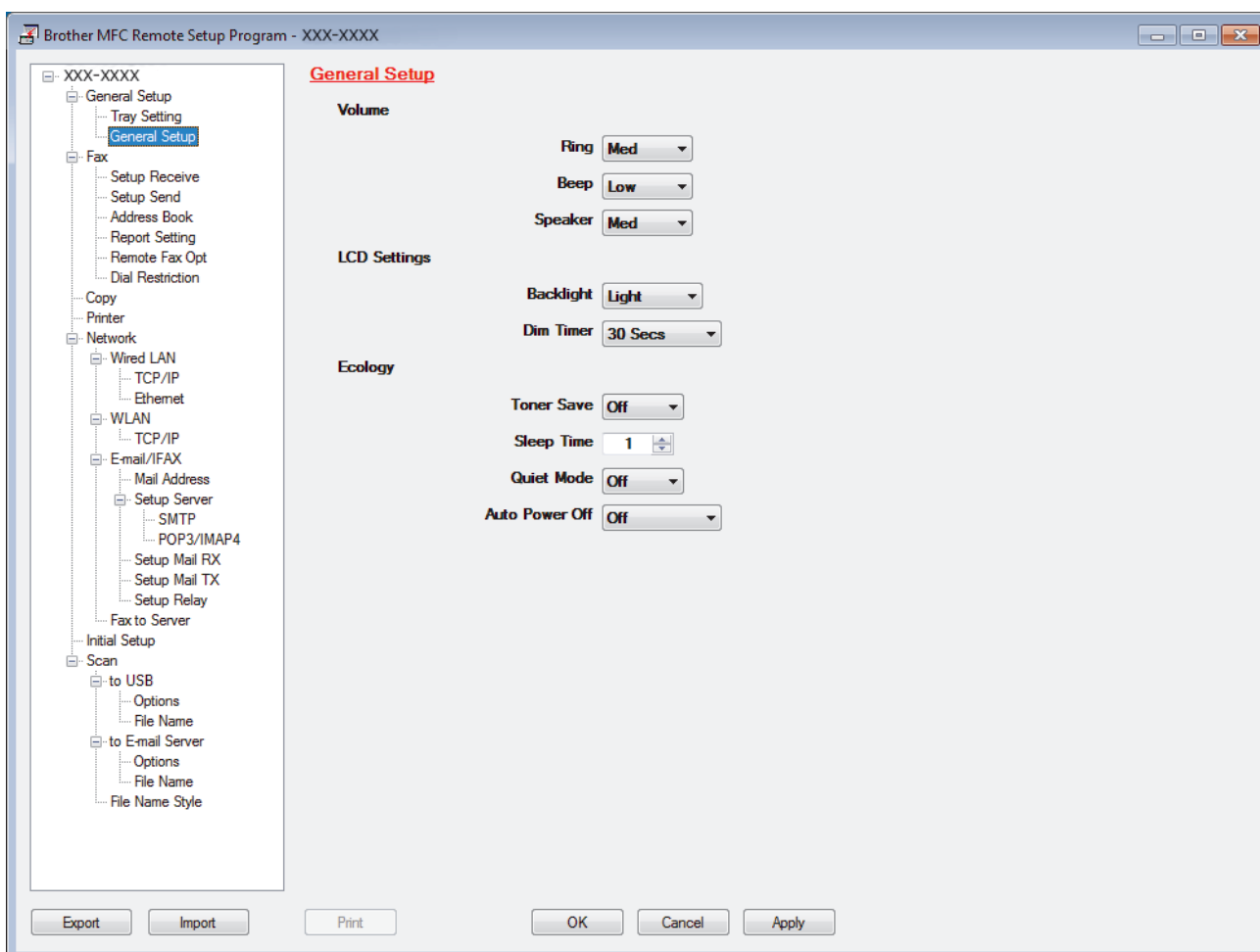

Export

Click to save the current configuration settings to a file.

 Click **Export** to save your address book or all settings for your machine.

Import

Click to import a file and read its settings.

Print

Click to print the selected items on the machine. You cannot print the data until it is uploaded to the machine. Click **Apply** to upload the new data to the machine, and then click **Print**.

OK

Click to start uploading data to the machine, and then exit the Remote Setup Program. If an error message appears, confirm that your data is correct, and then click **OK**.

Cancel

Click to exit the Remote Setup Program without uploading data to the machine.

Apply

Click to upload data to the machine without exiting the Remote Setup Program.

3. Click **OK**.

- If your computer is protected by a firewall and is unable to use Remote Setup, you may need to configure the firewall settings to allow communication through port numbers 137 and 161.
- If you are using Windows® Firewall and you installed the Brother software and drivers from the installation disc, the necessary firewall settings have already been set.

**Related Information**

- [Remote Setup \(Windows®\)](#)
-

Set Up the Brother Machine Using ControlCenter4 (Windows®)



If Secure Function Lock is set to On, you cannot use Remote Setup.

1. Click the  (ControlCenter4) icon in the task tray, and then click **Open**.
2. Click the **Device Settings** tab.
3. Click the **Remote Setup** button.
4. Configure the settings as needed.

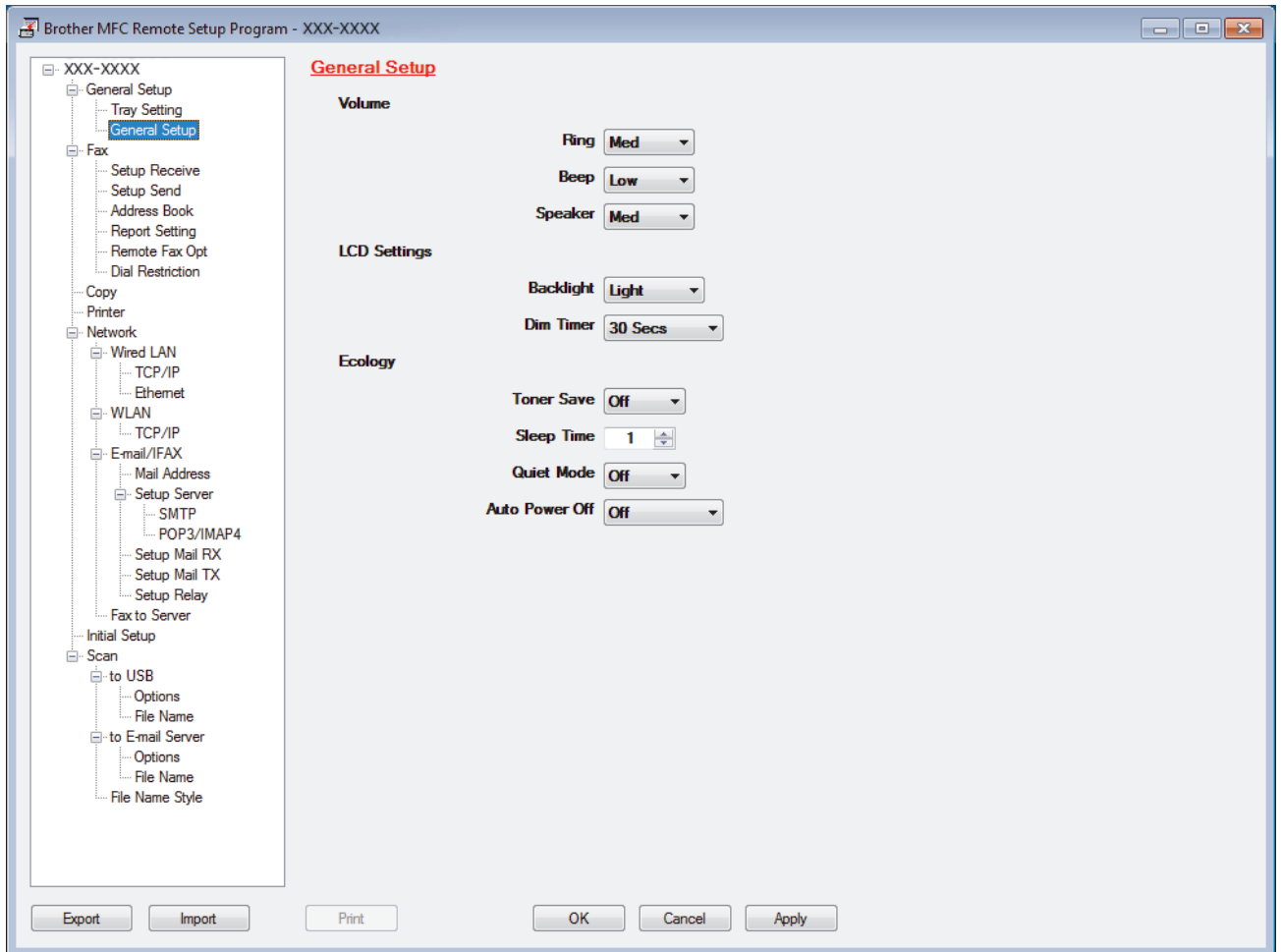

Export

Click to save the current configuration settings to a file.



Click **Export** to save your address book or all settings for your machine.

Import

Click to import a file and read its settings.

Print

Click to print the selected items on the machine. You cannot print the data until it is uploaded to the machine. Click **Apply** to upload the new data to the machine, and then click **Print**.

OK

Click to start uploading data to the machine, and then exit the Remote Setup Program. If an error message appears, confirm that your data is correct, and then click **OK**.

Cancel

Click to exit the Remote Setup Program without uploading data to the machine.

Apply

Click to upload data to the machine without exiting the Remote Setup Program.

5. Click **OK**.

- If your computer is protected by a firewall and is unable to use Remote Setup, you may need to configure the firewall settings to allow communication through port numbers 137 and 161.
- If you are using Windows® Firewall and you installed the Brother software and drivers from the installation disc, the necessary firewall settings have already been set.

**Related Information**

- [ControlCenter4 \(Windows®\)](#)
- [Remote Setup \(Windows®\)](#)

Set Up Your Machine's Address Book Using ControlCenter4 (Windows®)

Use Remote Setup through CC4 to add or change Address Book numbers on your computer.



If Secure Function Lock is set to On, you cannot use Remote Setup.

1. Click the  (**ControlCenter4**) icon in the task tray, and then click **Open**.
2. Click the **Device Settings** tab.
3. Click the **Address Book** button.
The **Address Book** opens in a Remote Setup window.
4. Add or update the Address Book information as needed.
5. Click **OK**.



Related Information

- [Remote Setup \(Windows®\)](#)

Remote Setup (Macintosh)

- [Set Up the Brother Machine Using ControlCenter2 \(Macintosh\)](#)
- [Set Up Your Machine's Address Book Using ControlCenter2 \(Macintosh\)](#)

Set Up the Brother Machine Using ControlCenter2 (Macintosh)



If Secure Function Lock is set to On, you cannot use Remote Setup.

1. In the **Finder** menu bar, click **Go > Applications > Brother**, and then double-click the  (**ControlCenter**) icon.

The **ControlCenter2** screen appears.

2. Click the **DEVICE SETTINGS** tab.
3. Click the **Remote Setup** button.

The Remote Setup Program screen appears.

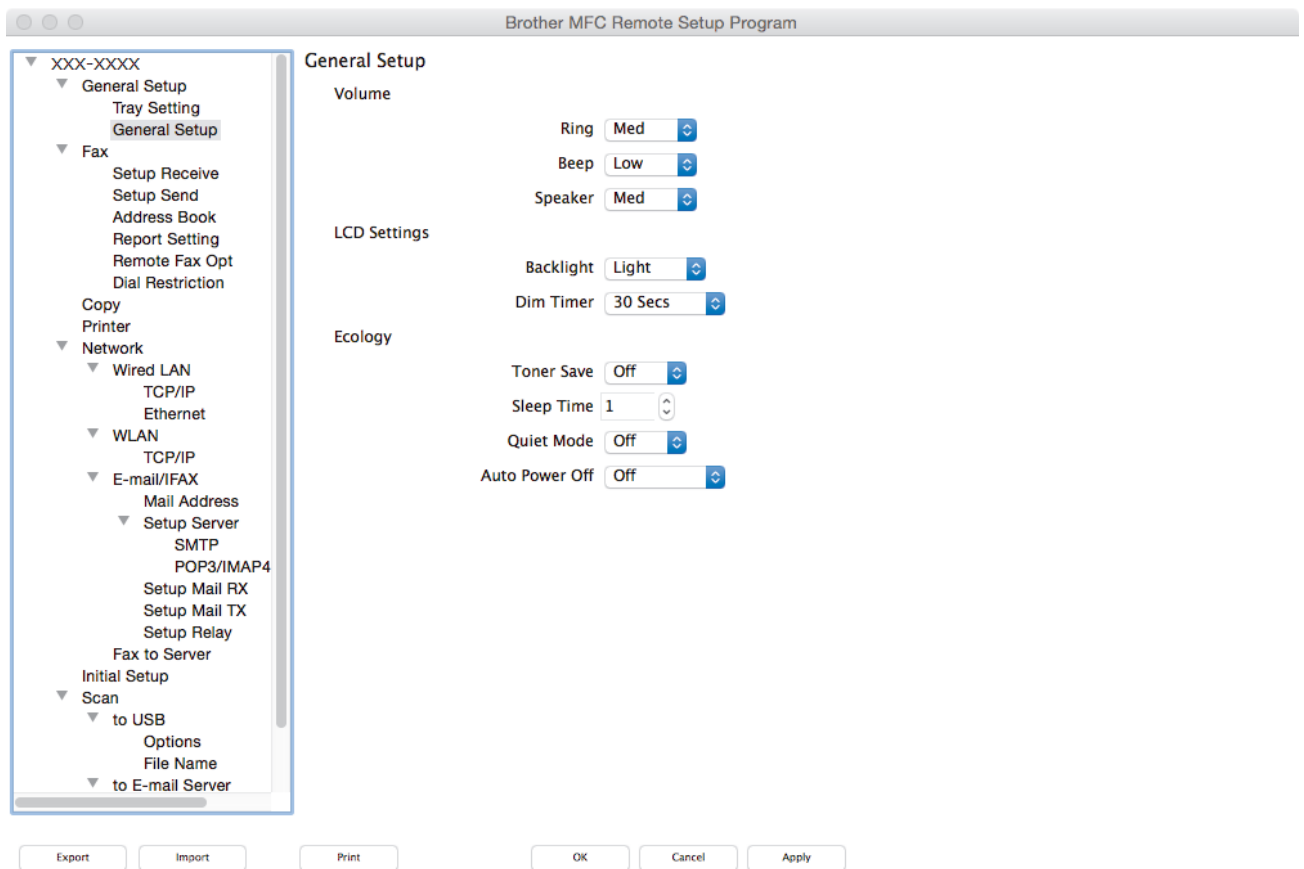

4. Configure the settings as needed.

Export

Click to save the current configuration settings to a file.



Click **Export** to save your address book or all settings for your machine.

Import

Click to import a file and read its settings.

Print

Click to print the selected items on the machine. You cannot print the data until it is uploaded to the machine. Click **Apply** to upload the new data to the machine, and then click **Print**.

OK

Click to start uploading data to the machine, and then exit the Remote Setup Program. If an error message appears, enter the correct data again, and then click **OK**.

Cancel

Click to exit the Remote Setup Program without uploading data to the machine.

Apply

Click to upload data to the machine without exiting the Remote Setup Program.

5. When finished, click **OK**.

**Related Information**

- [ControlCenter2 \(Macintosh\)](#)
 - [Remote Setup \(Macintosh\)](#)
-

Set Up Your Machine's Address Book Using ControlCenter2 (Macintosh)

Use Remote Setup through ControlCenter2 to add or change Address Book numbers on your computer.



If Secure Function Lock is set to On, you cannot use Remote Setup.

1. In the **Finder** menu bar, click **Go > Applications > Brother**, and then double-click the  (**ControlCenter**) icon.
The **ControlCenter2** screen appears.
2. Click the **DEVICE SETTINGS** tab.
3. Click the **Address Book** button.
The **Address Book** opens in a Remote Setup window.
4. Add or update the Address Book information as needed.
5. When finished, click **OK**.



Related Information

- [Remote Setup \(Macintosh\)](#)

Appendix

- [Specifications](#)
- [How to Enter Text on Your Brother Machine](#)
- [Supplies](#)
- [Important Information About Toner Cartridge Life](#)
- [Accessories](#)
- [Brother Numbers](#)

Specifications

General Specifications

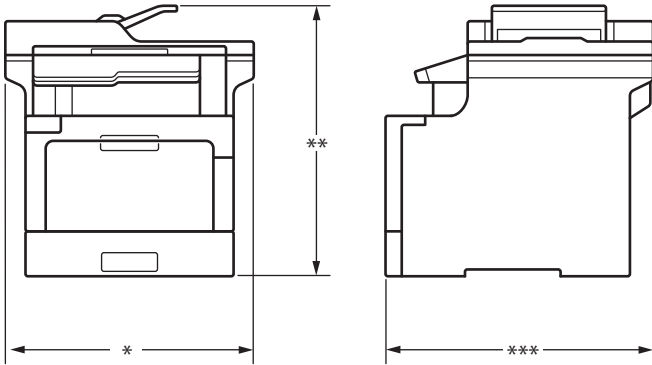
Printer Type		<ul style="list-style-type: none"> Laser
Print Method		<ul style="list-style-type: none"> Electrophotographic Laser Printer
Memory Capacity	Standard	<ul style="list-style-type: none"> (MFC-L8610CDW/MFC-L8900CDW) 512 MB
LCD (Liquid Crystal Display)		<ul style="list-style-type: none"> (MFC-L8610CDW) 3.7 in. (93.4 mm) TFT Color Touchscreen LCD ¹ (MFC-L8900CDW) 5.0 in. (118.5 mm) TFT Color Touchscreen LCD ¹
Power Source		<ul style="list-style-type: none"> 110 to 120 V AC 50/60 Hz
Power Consumption (Average)	Peak	<ul style="list-style-type: none"> Approximately 1230 W
	Printing ²	<ul style="list-style-type: none"> Approximately 600 W at 77 °F (25 °C)
	Printing (Quiet Mode) ²	<ul style="list-style-type: none"> Approximately 360 W at 77 °F (25 °C)
	Copying ²	<ul style="list-style-type: none"> Approximately 600 W at 77 °F (25 °C)
	Copying (Quiet Mode) ²	<ul style="list-style-type: none"> Approximately 370 W at 77 °F (25 °C)
	Ready ²	<ul style="list-style-type: none"> Approximately 75 W at 77 °F (25 °C)
	Sleep ²	<ul style="list-style-type: none"> Approximately 9.5 W
	Deep Sleep ²	<ul style="list-style-type: none"> (MFC-L8610CDW) Approximately 1.5 W (MFC-L8900CDW) Approximately 1.7 W
Power Off ^{2 3 4}		<ul style="list-style-type: none"> Approximately 0.02 W
Dimensions (Typical outline view) 		Unit: in. (mm) <ul style="list-style-type: none"> (MFC-L8610CDW) <ul style="list-style-type: none"> * : 17.1 (435) ** : 21.2 (539) *** : 20.7 (526) (MFC-L8900CDW) <ul style="list-style-type: none"> * : 19.5 (495) ** : 21.6 (549) *** : 20.7 (526)
Weights (with supplies)		<ul style="list-style-type: none"> (MFC-L8610CDW) 61.1 lb (27.7 kg) (MFC-L8900CDW) 63.1 lb (28.6 kg)

Noise Level	Sound Pressure	Printing	• LpAm = 49 dB (A)	
		Printing (Quiet Mode)	• LpAm = 44 dB (A)	
		Ready	• LpAm = Inaudible	
	Sound Power	Printing	Monochrome	• LWAd = 6.55 B (A)
			Color	• LWAd = 6.56 B (A)
		Printing (Quiet Mode)	Monochrome	• LWAd = 6.00 B (A)
Color			• LWAd = 6.00 B (A)	
Ready	• LWAd = Inaudible			
Temperature	Operating	• 50 to 90 °F (10 to 32 °C)		
	Storage	• 32 to 104 °F (0 to 40 °C)		
Humidity	Operating	• 20 to 80% (without condensation)		
	Storage	• 10 to 90% (without condensation)		
ADF (automatic document feeder)			<ul style="list-style-type: none"> • (MFC-L8610CDW) Up to 50 sheets • (MFC-L8900CDW) Up to 70 sheets For best results we recommend: <ul style="list-style-type: none"> • Temperature: 68 to 86 °F (20 to 30 °C) • Humidity: 50 to 70% • Paper: 20 lb (80 g/m²) 	

1 Measured diagonally

2 USB connections to computer

3 Measured according to IEC 62301 Edition 2.0.

4 Power consumption varies slightly depending on the usage environment.

Document Size Specification

Document Size	ADF Width	• 4.1 to 8.5 in. (105 to 215.9 mm)
	ADF Length	• 5.8 to 14.0 in. (147.3 to 355.6 mm)
	Scanner Glass Width	• Maximum 8.5 in. (215.9 mm)
	Scanner Glass Length	<ul style="list-style-type: none"> • (MFC-L8610CDW) Maximum 11.8 in. (300 mm) • (MFC-L8900CDW) Maximum 14 in. (355.6 mm)

Print Media Specifications

Paper Input	Paper Tray (Standard)	Paper Type	• Plain Paper, Letterhead, Colored Paper, Thin Paper, Recycled Paper
		Paper Size	• A4, Letter, A5, A5(Long Edge), A6, Executive, Legal, Folio, Mexico Legal
		Paper Weight	• 16 to 28 lb (60 to 105 g/m ²)

Paper Input	Paper Tray (Standard)	Maximum Paper Capacity	<ul style="list-style-type: none"> Up to 250 sheets of 20 lb (80 g/m²) Plain Paper
	Multi-Purpose Tray (MP tray)	Paper Type	<ul style="list-style-type: none"> Plain Paper, Letterhead, Colored Paper, Thin Paper, Thick Paper, Thicker Paper, Recycled Paper, Bond, Label, Envelope, Env. Thin, Env.Thick, Glossy Paper
		Paper Size	<ul style="list-style-type: none"> Width: 3 to 8.5 in. (76.2 to 215.9 mm) Length: 5 to 14 in. (127 to 355.6 mm) Envelope: COM-10, DL, C5, Monarch
		Paper Weight	<ul style="list-style-type: none"> 16 to 43 lb (60 to 163 g/m²)
		Maximum Paper Capacity	<ul style="list-style-type: none"> Up to 50 sheets of 20 lb (80 g/m²) Plain Paper Envelope: 10 envelopes up to 0.4 in. (10 mm) thick
	Paper Tray 2, 3, 4 (Optional) ^{1 2}	Paper Type	<ul style="list-style-type: none"> Plain Paper, Letterhead, Colored Paper, Thin Paper, Recycled Paper
		Paper Size	<ul style="list-style-type: none"> A4, Letter, A5, Executive, Legal, Folio, Mexico Legal
		Paper Weight	<ul style="list-style-type: none"> 16 to 28 lb (60 to 105 g/m²)
		Maximum Paper Capacity	<ul style="list-style-type: none"> LT-330CL Up to 250 sheets of 20 lb (80 g/m²) Plain Paper LT-340CL³ Up to 500 sheets of 20 lb (80 g/m²) Plain Paper
	Paper Output ⁴	Face Down Output Tray	
Face Up Output Tray		<ul style="list-style-type: none"> One sheet (face up delivery to the face up output tray) 	
2-sided	Automatic 2-sided Printing	Paper Type	<ul style="list-style-type: none"> Plain Paper, Letterhead, Colored Paper, Thin Paper, Recycled Paper, Glossy Paper
		Paper Size	<ul style="list-style-type: none"> Letter, Legal, Folio, Mexico Legal
		Paper Weight	<ul style="list-style-type: none"> 16 to 28 lb (60 to 105 g/m²)

¹ (MFC-L8610CDW) Maximum number of Lower Trays: Up to three LT-330CL Lower Trays

² (MFC-L8900CDW) Maximum number of Lower Trays: Up to three LT-330CL Lower Trays or up to two Lower Trays in any other combinations

³ Applicable to MFC-L8900CDW

⁴ For labels, we recommend removing the printed sheets from the output paper tray immediately after they exit the machine to avoid the possibility of smudging.

Fax Specifications

Compatibility	<ul style="list-style-type: none"> ITU-T Super Group 3
Coding System	<ul style="list-style-type: none"> MH / MR / MMR / JBIG
Modem Speed	<ul style="list-style-type: none"> 33,600 bps (with Automatic Fallback)
2-sided Print Receiving	<ul style="list-style-type: none"> Yes
Automatic 2-sided Sending	<ul style="list-style-type: none"> (MFC-L8900CDW) Yes (from ADF)

Scanning Width	• Maximum 8.19 in. (208 mm)	
Printing Width	• Maximum 8.19 in. (208 mm)	
Gray Scale	• 8 bit / 256 levels	
Resolution	Horizontal	• 203 dpi
	Vertical	• Standard: 98 dpi • Fine: 196 dpi • Super fine: 392 dpi • Photo: 196 dpi
Address Book	• 300 Locations	
Groups	• Up to 20	
Broadcasting	• 350 Locations	
Automatic Redial	• 1 time at 5 minutes intervals	
Memory Transmission	• Up to 500 pages ¹	
Out of Paper Reception	• Up to 500 pages ¹	

¹ 'Pages' refers to the 'ITU-T Test Chart #1' (a typical business letter, Standard resolution, JBIG code).

Copy Specification

Copy Width	• Maximum 8.27 in. (210 mm)
Automatic 2-sided Copy	• (MFC-L8900CDW) Yes (from ADF)
Sort Copy	• Yes
Stack Copy	• Up to 999 pages
Enlarge/Reduce	• 25 to 400% (in increments of 1%)
Resolution	• Maximum 1200 x 600 dpi
First Copy Out Time ¹	Monochrome • Less than 16 seconds at 73.4 °F (23 °C) / 115 V
	Color • Less than 17 seconds at 73.4 °F (23 °C) / 115 V

¹ From Ready Mode and standard tray

Scanner Specifications

Color / Black	• Yes / Yes
TWAIN Compliant	• Yes (Windows® 7 / Windows® 8 / Windows® 8.1 / Windows® 10) (macOS v10.10.5, v10.11.x, v10.12)
WIA Compliant	• Yes (Windows® 7 / Windows® 8 / Windows® 8.1 / Windows® 10)
ICA Compliant	• Yes (macOS v10.10.5, v10.11.x, v10.12)
Color Depth	• 48 bit color Processing (Input) • 24 bit color Processing (Output)
Gray Scale	• 16 bit color Processing (Input) • 8 bit color Processing (Output)

Resolution ¹	<ul style="list-style-type: none"> Up to 19200 x 19200 dpi (interpolated) Up to 1200 x 2400 dpi (from Scanner Glass) Up to 1200 x 600 dpi (from ADF)
Scanning Width	<ul style="list-style-type: none"> Maximum 8.27 in. (210 mm)
Automatic 2-sided Scanning	<ul style="list-style-type: none"> (MFC-L8900CDW) Yes (from ADF)

¹ Maximum 1200 × 1200 dpi scanning with the WIA driver in Windows® 7, Windows® 8, Windows® 8.1 and Windows® 10 (resolution up to 19200 × 19200 dpi can be selected by using the scanner utility)

Printer Specifications

Automatic 2-sided Print	<ul style="list-style-type: none"> Yes
Emulation	<ul style="list-style-type: none"> PCL6, BR-Script3, PDF Version 1.7, XPS Version 1.0
Resolution	<ul style="list-style-type: none"> 600 x 600 dpi, 2,400 dpi class (2400 x 600) quality
Print Speed ^{1 2}	1-sided print
	Monochrome
	<ul style="list-style-type: none"> Up to 33 pages/minute (Letter size) Up to 31 pages/minute (A4 size)
	Color
	<ul style="list-style-type: none"> Up to 33 pages/minute (Letter size) Up to 31 pages/minute (A4 size)
	2-sided Print
	Monochrome
	<ul style="list-style-type: none"> Up to 14 sides/minute (Up to 7 sheets/minute) (Letter or A4 size)
	Color
	<ul style="list-style-type: none"> Up to 14 sides/minute (Up to 7 sheets/minute) (Letter or A4 size)
First Print Time ³	Monochrome
	<ul style="list-style-type: none"> Less than 15 seconds at 73.4 °F (23 °C) / 115 V
	Color
	<ul style="list-style-type: none"> Less than 15 seconds at 73.4 °F (23 °C) / 115 V

¹ The print speed may change depending on the type of document you print.

² Print speed may be slower when the machine is connected by wireless LAN.

³ From Ready mode and standard tray

Interface Specifications

USB ^{1 2}	<ul style="list-style-type: none"> Hi-Speed USB 2.0 Use a USB 2.0 interface cable that is no more than 6 feet (2.0 meters) long.
LAN	<ul style="list-style-type: none"> 10Base-T/100Base-TX/1000Base-T^{3 4}
Wireless LAN	<ul style="list-style-type: none"> IEEE 802.11b/g/n (Infrastructure Mode) IEEE 802.11g/n (Wi-Fi Direct®)
NFC ⁵	<ul style="list-style-type: none"> (MFC-L8900CDW) Yes

¹ Your machine has a USB 2.0 Hi-Speed interface. The machine can also be connected to a computer that has a USB 1.1 interface.

² Third party USB ports are not supported.

³ Use a straight-through Category 5e (or greater) twisted-pair cable.

⁴ When you connect the machine to a Gigabit Ethernet Network, use network devices complying with the 1000BASE-T specification.

⁵ When you connect an external IC card reader, use a HID class driver supported device.

Direct Print Feature Specifications

Compatibility	<ul style="list-style-type: none"> PDF version 1.7, JPEG, Exif+JPEG, PRN (created by own printer driver), TIFF (scanned by Brother models), XPS version 1.0
Interface	<ul style="list-style-type: none"> USB direct interface : Front x 1

Supported Protocols and Security Features

Ethernet

10Base-T/100Base-TX/1000Base-T

Wireless LAN

IEEE 802.11b/g/n (Infrastructure Mode), IEEE 802.11g/n (Wi-Fi Direct)

Protocols (IPv4)

ARP, RARP, BOOTP, DHCP, APIPA (Auto IP), WINS/NetBIOS name resolution, DNS Resolver, mDNS, LLMNR responder, LPR/LPD, Custom Raw Port/Port 9100, POP3, SMTP Client, IPP/IPPS, FTP Client and Server, CIFS Client, TELNET Server, SNMPv1/v2c/v3, HTTP/HTTPS server, TFTP client and server, ICMP, Web Services (Print/Scan), SNTIP Client, LDAP, IMAP4

Protocols (IPv6)

NDP, RA, DNS resolver, mDNS, LLMNR responder, LPR/LPD, Custom Raw Port/Port 9100, IPP/IPPS, POP3, SMTP Client, FTP Client and Server, CIFS Client, TELNET Server, SNMPv1/v2c/v3, HTTP/HTTPS server, TFTP client and server, ICMPv6, SNTIP Client, LDAP, Web Services (Print/Scan), IMAP4

Network Security (Wired)

APOP, SMTP-AUTH, SSL/TLS (IPPS, HTTPS, SMTP, POP3, IMAP4), SNMP v3 802.1x (EAP-MD5, EAP-FAST, PEAP, EAP-TLS, EAP-TTLS), Kerberos, IPSec

Network Security (Wireless)

APOP, SMTP-AUTH, SSL/TLS (IPPS, HTTPS, SMTP, POP3, IMAP4), SNMP v3, 802.1x (LEAP, EAP-FAST, PEAP, EAP-TLS, EAP-TTLS), Kerberos, IPSec

Wireless Network Security

WEP 64/128 bit, WPA-PSK (TKIP/AES), WPA2-PSK (TKIP/AES) ¹

Wireless Certification

Wi-Fi Certification Mark License (WPA™/WPA2™ - Enterprise, Personal), Wi-Fi Protected Setup (WPS) Identifier Mark License, Wi-Fi CERTIFIED™ Wi-Fi Direct

Computer Requirements Specifications

Supported Operating Systems And Software Functions

Computer Platform & Operating System Version		PC Interface				Processor	For Drivers	Hard Disk Space to Install
		Parallel (IEEE1284)	USB ¹	10Base-T/100Base-TX/1000Base-T (Ethernet)	Wireless 802.11b/g/n			
Windows® Operating System	Windows® 7 / 8 / 8.1 ^{2 3}	N/A	Printing			32 bit (x86) or 64 bit (x64) processor	650 MB	1.2 GB
	Windows® 10 Home / 10 Pro /		PC Fax ⁴					

¹ Wi-Fi Direct supports WPA2-PSK (AES) only.

	10 Education / 10 Enterprise ^{2 3}				
	Windows Server® 2008	N/A	Printing		50 MB
	Windows Server® 2008 R2			64 bit (x64) processor	
	Windows Server® 2012				
	Windows Server® 2012 R2				
	Windows Server® 2016				
Macintosh Operating System	macOS v10.10.5	Printing		Intel® Processor	80 MB
	macOS v10.11.x	PC-Fax (Send) ⁴			400 MB
	macOS v10.12	Scanning			

¹ Third party USB ports are not supported.

² For WIA, 1200x1200 resolution. Brother Scanner Utility enables resolutions up to 19200 x 19200 dpi.

³ PaperPort™ 14SE supports Windows® 7, Windows® 8, Windows® 8.1 and Windows® 10.

⁴ PC-Fax supports black and white only.

For the latest driver updates, go to your model's **Downloads** page on the Brother Solutions Center at support.brother.com.

All trademarks, brand and product names are the property of their respective companies.



Related Information

- [Appendix](#)

How to Enter Text on Your Brother Machine

- When you must enter text on your Brother machine, a keyboard appears on the LCD.
- The characters that are available may differ depending on your country.
- The keyboard layout may differ depending on the operation you perform.



- Press to cycle between letters, numbers and special characters.



For certain models, press to select letters, numbers, special characters and additional letters (such as letters with diacritics).

- Press to cycle between lowercase and uppercase letters.
- To move the cursor to the left or right, press ◀ or ▶.

Inserting spaces

- To enter a space, press [Space] or ▶.

Making corrections

- If you entered a character incorrectly and want to change it, press ◀ or ▶ to move the cursor to the incorrect character, and then press . Enter the correct character.
- To insert a character, press ◀ or ▶ to move the cursor to the correct place, and then enter the character.
- Press for each character you want to erase, or press and hold to erase all the characters.



Related Information

- [Appendix](#)
- [Configure Your Machine for a Wireless Network Using the Machine's Control Panel Setup Wizard](#)
- [Configure Your Machine for a Wireless Network When the SSID Is Not Broadcast](#)
- [Set Your Station ID](#)

Supplies

When the time comes to replace supplies, such as the toner or drum, an error message will appear on your machine's control panel or in the Status Monitor. For more information about the supplies for your machine, visit www.brother.com/original/index.html or contact your local Brother dealer.

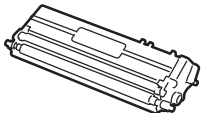
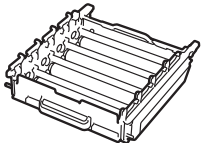

The supply order number will vary depending on your country and region.

Supply Items	Supply order No.	Approximate Life (Page Yield)	Applicable Models
Toner Cartridge 	Standard Toner: <ul style="list-style-type: none"> Black: TN-431BK Cyan: TN-431C Magenta: TN-431M Yellow: TN-431Y 	<ul style="list-style-type: none"> Black: Approximately 3,000 pages^{1 2} Cyan / Magenta / Yellow: Approximately 1,800 pages^{1 2} 	MFC-L8610CDW/MFC-L8900CDW
	High Yield Toner: <ul style="list-style-type: none"> Black: TN-433BK Cyan: TN-433C Magenta: TN-433M Yellow: TN-433Y 	<ul style="list-style-type: none"> Black: Approximately 4,500 pages^{1 2} Cyan / Magenta / Yellow: Approximately 4,000 pages^{1 2} 	MFC-L8610CDW/MFC-L8900CDW
	Super High Yield Toner: <ul style="list-style-type: none"> Black: TN-436BK Cyan: TN-436C Magenta: TN-436M Yellow: TN-436Y 	<ul style="list-style-type: none"> Black: Approximately 6,500 pages^{1 2} Cyan / Magenta / Yellow: Approximately 6,500 pages^{1 2} 	MFC-L8900CDW
	Starter Toner: (Supplied with your machine)	<ul style="list-style-type: none"> Black: Approximately 3,000 pages^{1 2} Cyan / Magenta / Yellow: Approximately 1,800 pages^{1 2} 	MFC-L8610CDW/MFC-L8900CDW
Drum Unit 	<ul style="list-style-type: none"> DR-431CL 	<ul style="list-style-type: none"> Approximately 30,000 pages³ 	MFC-L8610CDW/MFC-L8900CDW

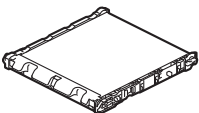
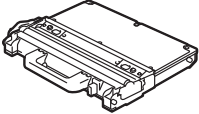
Supply Items	Supply order No.	Approximate Life (Page Yield)	Applicable Models
Belt Unit 	<ul style="list-style-type: none"> BU-330CL 	<ul style="list-style-type: none"> Approximately 50,000 pages⁴ 	MFC-L8610CDW/MFC-L8900CDW
Waste Toner Box 	<ul style="list-style-type: none"> WT-320CL 	<ul style="list-style-type: none"> Approximately 50,000 pages² 	MFC-L8610CDW/MFC-L8900CDW

¹ Approximate cartridge yield is declared in accordance with ISO/IEC 19798.

² Letter or A4 size 1-sided pages

³ Approximately 30,000 pages based on 1 page per job and 50,000 pages based on 3 pages per job [A4/Letter simplex pages]. The number of pages may be affected due to a variety of factors including but not limited to media type and media size.

⁴ Approximately 50,000 pages based on 1 page per job and 130,000 pages based on 3 pages per job [A4/Letter simplex pages]. The number of pages may be affected due to a variety of factors including but not limited to media type and media size.



Related Information

- [Appendix](#)
- [Replace Supplies](#)

Important Information About Toner Cartridge Life

Toner Cartridge Life

This product detects the life of the toner cartridges using the following two methods:

- Detection by counting the dots of each color that are necessary to create an image
- Detection by counting the rotations of the developer roller

This product has a function that will count the dots of each color used to print every document and the rotations of each toner cartridge's developer roller. The print operation will stop when either of the upper limits is reached. The upper limit is set above the number of dots or rotations that would be required for the cartridge to perform consistently with its advertised page yield. This function is intended to reduce the risk of poor print quality and damage to the machine.

There are two messages that indicate when the toner is low or needs replacing: Toner Low and Replace Toner.

Toner Low is displayed on the LCD when the number of dots or rotations of the developer roller nears its maximum count: Replace Toner is displayed on the LCD when the number of dots or rotations of the developer roller reaches its maximum count.

Color Correction

The number of developer roller rotations that are counted may not only be for normal operations, such as printing and copying, but also for machine adjustments, such as Color Calibration and Color Registration.

Color Calibration (Adjustment of Color Density)

To obtain stable print quality, the density of each toner cartridge needs to be maintained at a fixed value. If the density balance between the colors cannot be kept, the tint becomes unstable, and accurate color reproduction becomes unavailable. The toner density can change due to chemical changes to the toner that affect its electrical charge, deterioration of the developer unit, and temperature and humidity levels in the machine. During calibration, the density level adjustment test patterns are printed on the belt unit.

Calibration is mainly performed at the following times:

- When the user manually selects calibration from the operation panel or the printer driver.
(Please perform calibration if color density needs to be improved.)
- When a used toner cartridge is replaced with a new one.
- When the machine detects that the ambient temperature and humidity have changed.
- When a specified number of printed pages is reached.

Color Registration (Correction of Color Position)

In this machine, the drum unit and developer unit are prepared for black (K), yellow (Y), magenta (M), and cyan (C), respectively. Four color images are combined into one image, and therefore color registration errors (for example, how the four color images align) might occur. When registration errors occur, registration correction test patterns are printed on the belt unit.

Registration is mainly performed at the following times:

- When the user manually selects registration from the operation panel.
(Please perform registration if a color registration error needs to be corrected.)
- When a specified number of printed pages is reached.



Related Information

- [Appendix](#)

Accessories

Availability of accessories may vary depending on your country or region. For more information about the accessories for your machine, visit www.brother.com/original/index.html or contact your Brother dealer or Brother Customer Service.

Order No.	Items	Applicable Models
LT-330CL	Lower Tray (250 sheets)	• MFC-L8610CDW/MFC-L8900CDW ^{1 2}
LT-340CL	Lower Tray (500 sheets)	• MFC-L8900CDW ²

¹ (MFC-L8610CDW) Maximum number of Lower Trays: Up to three LT-330CL Lower Trays

² (MFC-L8900CDW) Maximum number of Lower Trays: Up to three LT-330CL Lower Trays or up to two Lower Trays in any other combinations

Related Information

- [Appendix](#)

Brother Numbers

IMPORTANT

For technical help, you must call the country where you bought the machine. Calls must be made **from within** that country.

FAQs (Frequently Asked Questions)

The Brother Solutions Center is our one-stop resource for all your Machine needs. Download the latest software and utilities and read FAQs and troubleshooting tips to learn how to get the most from your Brother product.

Check here for Brother driver updates, too.

support.brother.com

For Customer Service

In USA:

www.brother-usa.com/support (Self-Service/Email/Chat)

1-877-BROTHER (1-877-276-8437)

In Canada:

www.brother.ca/support

(Self-Service Videos, Email, Chat, Facebook and Twitter Help)

If you have comments or suggestions, write us at:

In USA:

Printer Customer Support

Brother International Corporation

7905 North Brother Boulevard

Bartlett, TN 38133

In Canada:

Brother International Corporation (Canada), Ltd.

Customer Experience Team

1, rue Hotel de Ville Dollard-des-Ormeaux, PQ, Canada H9B 3H6

Service Center Locator (USA only)

For the location of a Brother authorized service center, call 1-877-BROTHER (1-877-276-8437) or visit www.brother-usa.com/service.

Service Center Locations (Canada only)

For the location of a Brother authorized service center, visit www.brother.ca/support.

Ordering Accessories and Supplies

For best quality results use only genuine Brother supplies, which are available at most Brother retailers. If you cannot find the supplies you need and have a Visa, MasterCard, Discover, American Express credit card, or PayPal account, you can order directly from Brother. Visit us online for a complete selection of the Brother accessories and supplies that are available for purchase.

NOTE

In Canada, only Visa and MasterCard are accepted.

In USA:

1-877-552-MALL (1-877-552-6255)

1-800-947-1445 (assistance via fax)

www.brothermall.com

In Canada:

www.brother.ca



Related Information

- [Appendix](#)
-

Brother International Corporation
200 Crossing Boulevard
P.O. Box 6911
Bridgewater, NJ 08807-0911 USA

Brother International Corporation (Canada) Ltd.
1 rue Hôtel de Ville,
Dollard-des-Ormeaux, QC, Canada H9B 3H6

brother

Visit us on the World Wide Web
www.brother.com

These machines are approved for use in the country of purchase only. Local Brother companies or their dealers will support only machines purchased in their own countries.



USA/CAN
Version 0