

MB5000 series Online Manual

Read Me First
Useful Functions Available on the Machine
Overview of the Machine
Printing
Copying
Scanning
Faxing
Troubleshooting

Contents

Read Me First.	17
Symbols Used in This Document.	18
Trademarks and Licenses.	19
Search Tips.	23
Notes on Operation Explanations.	25
Useful Functions Available on the Machine.	26
Connect Wirelessly with Ease in "Access Point Mode".	27
Download a Variety of Content Materials.	28
Print Items with Easy-PhotoPrint+ (Web Application).	29
Use the Machine More Conveniently with Quick Toolbox.	30
Connection Methods Available on the Machine.	31
Connection without Using an Access Point (Windows XP).	33
Restrictions.	36
Notice for Web Service Printing.	38
Use MAXIFY Cloud Link.	40
Using MAXIFY Cloud Link from Your Printer.	41
Before Using MAXIFY Cloud Link from Your Printer.	42
Preparing to Use MAXIFY Cloud Link from Your Printer.	43
Application Management.	46
Using MAXIFY Cloud Link.	51
Cloud Windows.	54
Cloud Troubleshooting.	57
Using MAXIFY Cloud Link from Your Smartphone, Tablet, or Computer.	58
Before Using Canon Inkjet Cloud Printing Center.	59
Requirements for Canon Inkjet Cloud Printing Center operation.	60
Preparations Before Using Canon Inkjet Cloud Printing Center.	62
Printing Your Printer registration ID.	70
Canon Inkjet Cloud Printing Center window.	71
Using Canon Inkjet Cloud Printing Center.	88
Adding a Printer.	92
Adding a MAXIFY Cloud Link User.	94
Troubleshooting Canon Inkjet Cloud Printing Center.	99

What is a Security code?	101
Printing with Google Cloud Print.	102
Preparations for Printing with Google Cloud Print.	103
Printing from Computer or Smartphone with Google Cloud Print.	107
Printing from AirPrint Compliant Device.	109
Checking Printer Information.	114
Online Storage Integration Function.	117
How to Use Print from E-mail.	118
Preparing to Use Print from E-mail.	122
Timezone List.	125
Print Easily from a Smartphone or Tablet with MAXIFY Printing Solutions.	126
Printing with Windows RT.	127
Overview of the Machine.	128
Safety Guide.	129
Safety Precautions.	130
Regulatory and Safety Information.	131
Main Components and Basic Operations.	138
Main Components.	139
Front View.	140
Rear View.	142
Inside View.	143
Operation Panel.	144
About the Power Supply of the Machine.	145
Confirming that the Power Is On.	146
Turning the Machine On and Off.	147
Notice for the Power Plug/Power Cord.	149
Notice for Unplugging the Power Cord.	150
Using the Operation Panel.	151
Entering Numbers, Letters, and Symbols.	155
Loading Paper / Originals.	157
Loading Paper.	158
Paper Source to Load Paper.	159
Loading Plain Paper / Photo Paper.	161
Loading Envelopes.	166
Media Types You Can Use.	170

Paper Load Limit.	172
Media Types You Cannot Use.	173
Printing Area.	174
Printing Area.	175
Other Sizes than Letter, Legal, Envelopes.	176
Letter, Legal.	177
Envelopes.	178
Loading Originals.	179
Position to Load Originals.	180
Loading Originals on the Platen Glass.	181
Loading Documents in the ADF (Auto Document Feeder).	182
How to Load Originals for Each Function.	183
Originals You Can Load.	185
Inserting the USB Flash Drive.	187
Inserting the USB Flash Drive.	188
Removing the USB Flash Drive.	189
Replacing an Ink Tank.	190
Replacing an Ink Tank.	191
Checking the Ink Status.	196
Checking the Ink Status with the Touch Screen on the Machine.	197
Maintenance.	198
When Printing Becomes Faint or Colors Are Incorrect.	199
Maintenance Procedure.	200
Printing the Nozzle Check Pattern.	202
Examining the Nozzle Check Pattern.	204
Cleaning the Print Head.	206
Cleaning the Print Head Deeply.	208
Aligning the Print Head.	210
Aligning the Print Head Manually.	212
Performing Maintenance from a Computer.	216
Cleaning the Print Heads from Your Computer.	217
Use Your Computer to Print a Nozzle Check Pattern.	219
Aligning the Print Head Position from Your Computer.	220
Aligning the Print Head Position Manually from Your Computer.	221
Cleaning the Machine.	224
Cleaning the Exterior of the Machine.	225
Cleaning the Platen Glass and Document Cover.	226

Cleaning the ADF (Auto Document Feeder)	227
Cleaning the Paper Feed Roller.	229
Cleaning the Inside of the Machine (Bottom Plate Cleaning).	231
Cleaning the Pad in the Cassette.	234
Changing the Machine Settings.	235
Changing Machine Settings from Your Computer.	236
Checking the Ink Status from Your Computer.	237
Registering a Changed Printing Profile.	238
Managing the Printer Power.	240
Reducing the Printer Noise.	241
Changing the Printer Operation Mode.	243
Changing the Machine Settings Using the Operation Panel.	245
Changing the Machine Settings Using the Operation Panel.	246
FAX settings.	248
Print settings.	252
LAN settings.	253
Device user settings.	258
Language selection.	260
Firmware update.	261
Cassette settings.	262
Administrator password setting.	263
Operation restrictions.	264
Reset setting.	265
About ECO settings.	267
About Quiet setting.	270
Using the Machine with the Access Point Mode.	272
Registering the Favorite Settings (Custom profiles).	276
Checking the Total Number of Uses of the Machine.	278
Information about Network Connection.	279
Useful Information about Network Connection.	280
Default Values Set at Factory (Network).	281
Connecting the Machine to the Computer Using a USB Cable.	282
When Detecting the Printers Have the Same Name.	283
Connecting to Other Computer with LAN/Changing the Connection Method from USB to LAN.	284
Printing Out Network Setting Information.	285
About Network Communication.	288
Changing and Confirming Network Settings.	289

IJ Network Tool.	290
Canon IJ Network Tool Screen.	291
Canon IJ Network Tool Menus.	293
Changing the Settings in the Wireless LAN Sheet.	295
Changing the WEP Detailed Settings.	299
Changing the WPA/WPA2 Detailed Settings.	301
Changing the Settings in the Wired LAN Sheet.	303
Changing the Settings in the Admin Password Sheet.	304
Monitoring Wireless Network Status.	306
Initializing the Network Settings of the Machine.	308
Viewing the Modified Settings.	309
Appendix for Network Communication.	310
Using the Card Slot over a Network.	311
About Technical Terms.	313
Restrictions.	320
Tips for Ensuring Optimal Printing Quality.	321
Useful Information about Ink.	322
Key Points to Successful Printing.	323
Be Sure to Check Paper Settings before Printing.	324
Be Sure to Set Cassette Paper Information after Loading Paper.	325
Canceling a Print Job.	326
Key to Enjoying Consistent Printing Quality.	327
Precautions for Safe Transport of the Machine.	328
Legal Limitations on Use of Your Product and Use of Images.	330
Specifications.	331
Administrator Settings.	336
About the Machine Administration.	337
Setting the Administrator Password.	338
Restricting the Operation.	340
About the Administrator Password.	342
Printing.	343
Printing from a Computer.	344
Printing with Application Software that You are Using (Printer Driver).	345
Printing with Easy Setup.	346
Paper Settings on the Printer Driver and the Printer (Media Type).	350
Paper Settings on the Printer Driver and the Printer (Paper Size).	351

Various Printing Methods.	352
Setting the Number of Copies and Printing Order.	353
Setting the Stapling Margin.	355
Scaling the Printing to Fit the Paper Size.	356
Scaled Printing.	358
Page Layout Printing.	359
Duplex Printing.	361
Printing on Postcards.	363
Displaying the Print Results before Printing.	364
Setting Paper Dimensions (Custom Size).	365
Changing the Print Quality and Correcting Image Data.	367
Printing a Color Document in Monochrome.	368
Specifying Color Correction.	369
Optimal Photo Printing of Image Data.	371
Adjusting Colors with the Printer Driver.	372
Printing with ICC Profiles (Specifying an ICC Profile from the Application Software).	373
Printing with ICC Profiles (Specifying an ICC Profile from the Printer Driver).	375
Adjusting Color Balance.	376
Adjusting Brightness.	378
Adjusting Intensity.	380
Adjusting Contrast.	382
Overview of the Printer Driver.	384
Canon IJ Printer Driver.	385
How to Open the Printer Driver Setup Window.	386
Page Setup Dialog.	387
Print Dialog.	388
Quality & Media.	390
Color Options.	391
Margin.	393
Canon IJ Printer Utility.	394
Opening the Canon IJ Printer Utility.	396
Maintenance of this Printer.	397
Display the Printing Status Screen.	398
Deleting the Undesired Print Job.	400
Instructions for Use (Printer Driver).	401
Updating the Printer Driver.	402
Obtaining the Latest Printer Driver.	403
Delete the Unnecessary Canon IJ Printer from the Printer List.	404
Before Installing the Printer Driver.	405

Installing the Printer Driver.	406
Printing Using the Operation Panel of the Machine.	407
Printing Photo Data.	408
Printing Photographs Saved on a USB Flash Drive.	409
Setting Items for Photo Printing Using the Operation Panel of the Machine.	414
Using Useful Display Functions.	415
Printing Documents (PDF File) Saved on a USB Flash Drive.	417
Paper setting for Printing.	421
Copying.	424
Making Copies.	425
Displaying the Preview Screen.	428
Setting Items for Copying.	430
Reducing or Enlarging a Copy.	433
Two-Sided Copying.	435
About Special Copy Menu.	437
Copying Thick Originals Such as Books.	438
Copying Two Pages to Fit onto a Single Page.	439
Copying Four Pages to Fit onto a Single Page.	441
Collated Copying.	444
Scanning.	446
Scanning from a Computer.	447
Scanning with IJ Scan Utility.	448
What Is IJ Scan Utility (Scanner Software)?.	449
Starting IJ Scan Utility.	451
Scanning Documents.	452
Scanning Photos.	453
Scanning with Favorite Settings.	454
Scanning Items Larger than the Platen (Image Stitch).	455
Extracting Text from Scanned Images (OCR).	459
Sending Scanned Images via E-mail.	461
Scanning Multiple Items at One Time.	462
Scanning Multiple Documents at One Time from the ADF (Auto Document Feeder).	465
Saving after Checking Scan Results.	470
IJ Scan Utility Screens.	473
IJ Scan Utility Main Screen.	474

Settings Dialog.	476
Network Selection Screen.	525
Save Settings Dialog.	527
Image Stitch Window.	530
Scanning with Scanner Driver.	534
Image Corrections and Color Adjustments.	535
General Notes (Scanner Driver).	539
Updating the Scanner Driver.	540
Obtaining the Latest Scanner Driver.	541
Before Installing the Scanner Driver.	542
Installing the Scanner Driver.	543
Useful Information on Scanning.	544
Adjusting Cropping Frames in the Image Stitch Window.	545
Resolution.	546
Data Formats.	548
Placing Items (When Scanning from a Computer).	549
Scanning from the Operation Panel of the Machine.	552
Forwarding Scanned Data to the Computer Using the Operation Panel of the Machine.	553
Attaching the Scanned Data to E-mail Using the Operation Panel of the Machine.	556
Saving Scanned Data on the USB Flash Drive Using the Operation Panel of the Machine.	559
Forwarding Scanned Data to Shared Folder on the Computer Using the Operation Panel of the Machine.	563
Deleting Scanned Data on USB Flash Drive.	566
Setting Items for Scanning Using the Operation Panel of the Machine.	568
Network Scan Settings.	570
Selecting a Response to Commands from the Operation Panel Using IJ Scan Utility.	572
Faxing.	575
Preparing for Faxing.	576
Connecting the Telephone Line.	577
Setting the Telephone Line Type.	580
Setting the Receive Mode.	583
Setting the Sender Information.	587
Sending Faxes Using the Operation Panel of the Machine.	594
Sending Faxes by Entering Fax/Telephone Number.	595
Resending Faxes (Redialing a Busy Number).	599
Setting Items for Sending Faxes.	601
Sending Faxes Using Useful Functions.	602

Sending a Fax after Speaking on Telephone.	603
Sending a Fax to the Registered Recipient.	605
Sending the Same Document to Several Recipients (Sequential Broadcasting).	607
Preventing Mistransmission of Faxes.	611
Using the On Hook Dial Function.	613
Registering Recipients.	615
Registering Recipients Using the Operation Panel of the Machine.	616
Registering the Fax/Telephone Number of Recipients.	617
Registering Recipients in Group Dial.	621
Changing Registered Information.	625
Deleting Registered Information.	626
Printing a List of the Registered Destinations.	627
Registering Recipients Using Speed Dial Utility.	628
Starting Up Speed Dial Utility.	629
Speed Dial Utility Dialog.	630
Saving Registered Information on the Machine to Your Computer.	632
Registering a Fax/telephone Number Using Speed Dial Utility.	633
Changing a Fax/telephone Number Using Speed Dial Utility.	635
Deleting a Fax/telephone Number Using Speed Dial Utility.	637
Changing Sender Information Using Speed Dial Utility.	638
Registering/Changing Rejected Number Using Speed Dial Utility.	639
Calling the Registered Information Up from Your Computer and Registering the Information to the Machine.	640
Uninstalling Speed Dial Utility.	641
Receiving Faxes.	642
Receiving Faxes.	643
Changing the Paper Settings.	648
Memory Reception.	650
Receiving Faxes Using Useful Functions.	652
Saving Received Faxes Automatically on a USB Flash Drive.	653
Forwarding Received Faxes Automatically to Shared Folder on the Computer.	655
Remote Reception.	657
Rejecting Fax Reception.	658
Using the Caller ID Service to Reject Calls.	661
Other Useful Fax Functions.	663
Using the Information Services.	664
Transmission/Reception of Faxes Using ECM.	667
Document Stored in Machine's Memory.	668

Printing a Document in Machine's Memory.	669
Deleting a Document in Machine's Memory.	671
Saving a Document in Machine's Memory to USB Flash Drive.	673
Forwarding a Document in Machine's Memory to Shared Folder on the Computer.	676
Summary of Reports and Lists.	679
Troubleshooting.	684
Problems with Network Communication.	685
Problems with the Machine While Using with Network.	686
The Machine Stopped Working Suddenly.	687
Printing Speed Is Slow.	690
Cannot Use the Machine on Replacing an Access Point or Changing Its settings.	691
Cannot Detect a Machine on a Network.	693
Cannot Detect the Machine When Setting up Network Communication.	694
Cannot Detect the Machine during Wireless LAN Setup: Check 1.	695
Cannot Detect the Machine during Wireless LAN Setup: Check 2.	696
Cannot Detect the Machine during Wireless LAN Setup: Check 3.	697
Cannot Detect the Machine during Wireless LAN Setup: Check 4.	698
Cannot Detect the Machine during Wireless LAN Setup: Check 5.	699
Cannot Detect the Machine during Wireless LAN Setup: Check 6.	700
Cannot Detect the Machine during Wired LAN Setup: Check 1.	701
Cannot Detect the Machine during Wired LAN Setup: Check 2.	702
Cannot Detect the Machine during Wired LAN Setup: Check 3.	703
Cannot Detect the Machine during Wired LAN Setup: Check 4.	704
Cannot Detect the Machine during Wired LAN Setup: Check 5.	705
Cannot Detect the Machine during Wired LAN Setup: Check 6.	706
The Machine Cannot Be Detected in the Wireless LAN.	707
The Machine Cannot Be Detected in the Wired LAN.	709
Other Problems with Network.	710
Forgot an Access Point Name, SSID, or a Network Key.	711
The Message Is Displayed on the Computer Screen During Setup.	713
The Administrator Password Set to the Machine Was Forgotten.	715
Checking Information about the Network.	716
How to Restore the Machine's Network Settings to Factory Default.	718
Problems with Printing.	719
Printing Does Not Start.	720
Paper Jams.	722
Paper Does Not Feed Properly/"No Paper" Error Occurs.	723

Cannot Print Properly with Automatic Duplex Printing.	725
Copying/Printing Stops Before It Is Completed.	726
Problems with Printing Quality.	727
Print Results Not Satisfactory.	728
Cannot Print to End of Job.	729
No Printing Results/Printing Is Blurred/Colors Are Wrong/White Streaks.	730
Lines Are Misaligned.	733
Printed Paper Curls or Has Ink Blots.	734
Paper Is Smudged/Printed Surface Is Scratched.	735
Back of the Paper Is Smudged.	739
Colors Are Uneven or Streaked.	740
Ink Is Not Ejected.	742
Problems with Faxing.	743
Problems Sending Faxes.	744
Problems Receiving Faxes.	747
Cannot Send a Fax Clearly.	751
Telephone Problems.	752
Problems with Scanning.	753
Problems with Scanning.	754
Scanner Does Not Work.	755
Scanner Driver Does Not Start.	756
Error Message Appears and the Scanner Driver Screen Does Not Appear.	757
Cannot Scan Multiple Items at One Time.	758
Slow Scanning Speed.	759
"There is not enough memory." Message Is Displayed.	760
Computer Stops Operating during Scanning.	761
Scanned Image Does Not Open.	762
Scan Results Not Satisfactory.	763
Moire Appears in Scan Results.	764
Scan Quality (Image Displayed on the Monitor) Is Poor.	765
Scanned Image Is Surrounded by Extra White Areas.	766
Cannot Scan at the Correct Size.	767
Position or Size of the Image Cannot be Detected Correctly When Scanning from the Operation Panel.	768
Item Is Placed Correctly, but the Scanned Image Is Slanted.	769
Scanned Image Is Enlarged (Reduced) on the Computer Monitor.	770
Problems with the Machine.	771

The Machine Cannot Be Powered On.	772
Cannot Connect to Computer with a USB Cable Properly.	773
Cannot Communicate with the Machine with USB Connection.	774
The Display on the Touch Screen Cannot Be Seen At All.	775
An Unintended Language Is Displayed on the Touch Screen.	776
Print Head Holder Does Not Move to the Position for Replacing.	777
Problems with Installation/Downloading.	778
Cannot Install the MP Drivers.	779
Uninstalling IJ Network Tool.	780
About Errors/Messages Displayed.	781
If an Error Occurs.	782
A Message for Faxing Is Displayed on the Fax Standby Screen.	783
A Message Is Displayed.	786
If You Cannot Resolve the Problem.	790
Support Code List.	791
Support Code List (When Paper Is Jammed).	793
1300.	794
1303.	798
1313.	801
1314.	804
2801.	807
In Other Cases.	809
1003.	810
1200.	811
1310.	812
1575.	813
1600.	814
1660.	815
1688.	816
1700.	817
1701.	818
1754.	819
1755.	820
1871.	821
1890.	822

2001.....	823
2002.....	824
2110.....	825
2120.....	828
2500.....	829
2700.....	830
2802.....	831
2803.....	832
4100.....	834
4103.....	835
5011.....	836
5012.....	837
5040.....	838
5100.....	839
5102.....	840
5103.....	841
5104.....	842
5105.....	843
5200.....	844
5203.....	845
5204.....	846
5205.....	847
5206.....	848
5207.....	849
5208.....	850
5209.....	851
5400.....	852
5500.....	853
5501.....	854
5B00.....	855
5B01.....	856
5C01.....	857
6000.....	858
6500.....	859

6502.....	860
6700.....	861
6800.....	862
6801.....	863
6900.....	864
6901.....	865
6902.....	866
6910.....	867
6911.....	868
6920.....	869
6921.....	870
6930.....	871
6931.....	872
6932.....	873
6933.....	874
6936.....	875
6937.....	876
6938.....	877
6939.....	878
693A.....	879
6940.....	880
6941.....	881
6942.....	882
6943.....	883
6944.....	884
6945.....	885
6946.....	886
7100.....	887
7200.....	888
7201.....	889
7202.....	890
7203.....	891
7204.....	892
7205.....	893

7300.....	894
9000.....	895
9500.....	896
B202.....	897
B203.....	898
B204.....	899
B502.....	900
B503.....	901
B504.....	902
C000.....	903

Read Me First

■ [Notes on Online Manual Usage](#)

■ [How to Print](#)

Notes on Online Manual Usage

- Reproduction, diversion or copying of any text, photo or image published in the *Online Manual* (hereinafter referred to as "this guide"), in whole or in part, is prohibited.
- In principle, Canon shall change or delete the contents of this guide without prior notice to customers. In addition, Canon may suspend or stop the disclosure of this guide due to unavoidable reasons. Canon shall not be liable for any damage suffered by customers as a result of changes in or deletion of information in this guide, or suspension/stoppage of disclosure of this guide.
- Although the contents of this guide have been prepared with utmost care, please contact the service center if you find any incorrect or missing information.
- In principle, the descriptions in this guide are based on the product at the time of its initial sale.
- This guide does not disclose the manuals of all the products sold by Canon. See the manual supplied with the product when using a product that is not described in this guide.

How to Print

Use the print function of your Web browser to print this guide.

To print background colors and images, follow the steps below to display the Print dialog options, then select the **Print backgrounds** checkbox.

1. Click **Print...** from the **File** menu.
2. Click **Show Details** or  (Down Arrow).
3. Select **Safari** from the pop-up menu.

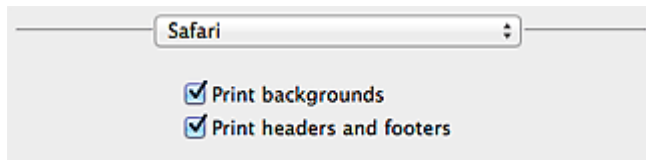

Symbols Used in This Document

Warning

Instructions that, if ignored, could result in death or serious personal injury caused by incorrect operation of the equipment. These must be observed for safe operation.

Caution

Instructions that, if ignored, could result in personal injury or material damage caused by incorrect operation of the equipment. These must be observed for safe operation.

Important

Instructions including important information. To avoid damage and injury or improper use of the product, be sure to read these indications.

Note

Instructions including notes for operation and additional explanations.

Basic

Instructions explaining basic operations of your product.

Note

- Icons may vary depending on your product.

Trademarks and Licenses

- Microsoft is a registered trademark of Microsoft Corporation.
- Windows is a trademark or registered trademark of Microsoft Corporation in the U.S. and/or other countries.
- Windows Vista is a trademark or registered trademark of Microsoft Corporation in the U.S. and/or other countries.
- Internet Explorer is a trademark or registered trademark of Microsoft Corporation in the U.S. and/or other countries.
- Mac, Mac OS, AirPort, Safari, Bonjour, iPad, iPhone and iPod touch are trademarks of Apple Inc., registered in the U.S. and other countries. AirPrint and the AirPrint logo are trademarks of Apple Inc.
- IOS is a trademark or registered trademark of Cisco in the U.S. and other countries and is used under license.
- Google Cloud Print, Google Chrome, Android, Google Play and Picasa are either registered trademarks or trademarks of Google Inc.
- Adobe, Photoshop, Photoshop Elements, Lightroom, Adobe RGB and Adobe RGB (1998) are either registered trademarks or trademarks of Adobe Systems Incorporated in the United States and/or other countries.
- Photo Rag is a trademark of Hahnemühle FineArt GmbH.
- Bluetooth is a trademark of Bluetooth SIG, Inc., U.S.A. and licensed to Canon Inc.

Note

- The formal name of Windows Vista is Microsoft Windows Vista operating system.

Copyright (c) 2003-2004, Apple Computer, Inc. All rights reserved.

Redistribution and use in source and binary forms, with or without modification, are permitted provided that the following conditions are met:

1. Redistributions of source code must retain the above copyright notice, this list of conditions and the following disclaimer.
2. Redistributions in binary form must reproduce the above copyright notice, this list of conditions and the following disclaimer in the documentation and/or other materials provided with the distribution.
3. Neither the name of Apple Computer, Inc. ("Apple") nor the names of its contributors may be used to endorse or promote products derived from this software without specific prior written permission.

THIS SOFTWARE IS PROVIDED BY APPLE AND ITS CONTRIBUTORS "AS IS" AND ANY EXPRESS OR IMPLIED WARRANTIES, INCLUDING, BUT NOT LIMITED TO, THE IMPLIED WARRANTIES OF MERCHANTABILITY AND FITNESS FOR A PARTICULAR PURPOSE ARE DISCLAIMED. IN NO EVENT SHALL APPLE OR ITS CONTRIBUTORS BE LIABLE FOR ANY DIRECT, INDIRECT, INCIDENTAL, SPECIAL, EXEMPLARY, OR CONSEQUENTIAL DAMAGES (INCLUDING, BUT NOT LIMITED TO, PROCUREMENT OF SUBSTITUTE GOODS OR SERVICES; LOSS OF USE, DATA, OR PROFITS; OR BUSINESS INTERRUPTION) HOWEVER CAUSED AND ON ANY THEORY OF LIABILITY, WHETHER IN CONTRACT, STRICT LIABILITY, OR TORT INCLUDING NEGLIGENCE OR OTHERWISE) ARISING IN ANY WAY OUT OF THE USE OF THIS SOFTWARE, EVEN IF ADVISED OF THE POSSIBILITY OF SUCH DAMAGE.

Apache License

Version 2.0, January 2004

<http://www.apache.org/licenses/>

TERMS AND CONDITIONS FOR USE, REPRODUCTION, AND DISTRIBUTION

1. Definitions.

"License" shall mean the terms and conditions for use, reproduction, and distribution as defined by Sections 1 through 9 of this document.

"Licensor" shall mean the copyright owner or entity authorized by the copyright owner that is granting the License.

"Legal Entity" shall mean the union of the acting entity and all other entities that control, are controlled by, or are under common control with that entity. For the purposes of this definition, "control" means (i) the power, direct or indirect, to cause the direction or management of such entity, whether by contract or otherwise, or (ii) ownership of fifty percent (50%) or more of the outstanding shares, or (iii) beneficial ownership of such entity.

"You" (or "Your") shall mean an individual or Legal Entity exercising permissions granted by this License.

"Source" form shall mean the preferred form for making modifications, including but not limited to software source code, documentation source, and configuration files.

"Object" form shall mean any form resulting from mechanical transformation or translation of a Source form, including but not limited to compiled object code, generated documentation, and conversions to other media types.

"Work" shall mean the work of authorship, whether in Source or Object form, made available under the License, as indicated by a copyright notice that is included in or attached to the work (an example is provided in the Appendix below).

"Derivative Works" shall mean any work, whether in Source or Object form, that is based on (or derived from) the Work and for which the editorial revisions, annotations, elaborations, or other modifications represent, as a whole, an original work of authorship. For the purposes of this License, Derivative Works shall not include works that remain separable from, or merely link (or bind by name) to the interfaces of, the Work and Derivative Works thereof.

"Contribution" shall mean any work of authorship, including the original version of the Work and any modifications or additions to that Work or Derivative Works thereof, that is intentionally submitted to Licensor for inclusion in the Work by the copyright owner or by an individual or Legal Entity authorized to submit on behalf of the copyright owner. For the purposes of this definition, "submitted" means any form of electronic, verbal, or written communication sent to the Licensor or its representatives, including but not limited to communication on electronic mailing lists, source code control systems, and issue tracking systems that are managed by, or on behalf of, the Licensor for the purpose of discussing and improving the Work, but excluding communication that is conspicuously marked or otherwise designated in writing by the copyright owner as "Not a Contribution."

"Contributor" shall mean Licensor and any individual or Legal Entity on behalf of whom a Contribution has been received by Licensor and subsequently incorporated within the Work.

2. Grant of Copyright License. Subject to the terms and conditions of this License, each Contributor hereby grants to You a perpetual, worldwide, non-exclusive, no-charge, royalty-free, irrevocable copyright license to reproduce, prepare Derivative Works of, publicly display, publicly perform, sublicense, and distribute the Work and such Derivative Works in Source or Object form.
3. Grant of Patent License. Subject to the terms and conditions of this License, each Contributor hereby grants to You a perpetual, worldwide, non-exclusive, no-charge, royalty-free, irrevocable (except as stated in this section) patent license to make, have made, use, offer to sell, sell, import, and otherwise transfer the Work, where such license applies only to those patent claims licensable by such Contributor that are necessarily infringed by their Contribution(s) alone or by combination of

their Contribution(s) with the Work to which such Contribution(s) was submitted. If You institute patent litigation against any entity (including a cross-claim or counterclaim in a lawsuit) alleging that the Work or a Contribution incorporated within the Work constitutes direct or contributory patent infringement, then any patent licenses granted to You under this License for that Work shall terminate as of the date such litigation is filed.

4. Redistribution. You may reproduce and distribute copies of the Work or Derivative Works thereof in any medium, with or without modifications, and in Source or Object form, provided that You meet the following conditions:
 1. You must give any other recipients of the Work or Derivative Works a copy of this License; and
 2. You must cause any modified files to carry prominent notices stating that You changed the files; and
 3. You must retain, in the Source form of any Derivative Works that You distribute, all copyright, patent, trademark, and attribution notices from the Source form of the Work, excluding those notices that do not pertain to any part of the Derivative Works; and
 4. If the Work includes a "NOTICE" text file as part of its distribution, then any Derivative Works that You distribute must include a readable copy of the attribution notices contained within such NOTICE file, excluding those notices that do not pertain to any part of the Derivative Works, in at least one of the following places: within a NOTICE text file distributed as part of the Derivative Works; within the Source form or documentation, if provided along with the Derivative Works; or, within a display generated by the Derivative Works, if and wherever such third-party notices normally appear. The contents of the NOTICE file are for informational purposes only and do not modify the License. You may add Your own attribution notices within Derivative Works that You distribute, alongside or as an addendum to the NOTICE text from the Work, provided that such additional attribution notices cannot be construed as modifying the License.

You may add Your own copyright statement to Your modifications and may provide additional or different license terms and conditions for use, reproduction, or distribution of Your modifications, or for any such Derivative Works as a whole, provided Your use, reproduction, and distribution of the Work otherwise complies with the conditions stated in this License.

5. Submission of Contributions. Unless You explicitly state otherwise, any Contribution intentionally submitted for inclusion in the Work by You to the Licensor shall be under the terms and conditions of this License, without any additional terms or conditions. Notwithstanding the above, nothing herein shall supersede or modify the terms of any separate license agreement you may have executed with Licensor regarding such Contributions.
6. Trademarks. This License does not grant permission to use the trade names, trademarks, service marks, or product names of the Licensor, except as required for reasonable and customary use in describing the origin of the Work and reproducing the content of the NOTICE file.
7. Disclaimer of Warranty. Unless required by applicable law or agreed to in writing, Licensor provides the Work (and each Contributor provides its Contributions) on an "AS IS" BASIS, WITHOUT WARRANTIES OR CONDITIONS OF ANY KIND, either express or implied, including, without limitation, any warranties or conditions of TITLE, NON-INFRINGEMENT, MERCHANTABILITY, or FITNESS FOR A PARTICULAR PURPOSE. You are solely responsible for determining the appropriateness of using or redistributing the Work and assume any risks associated with Your exercise of permissions under this License.
8. Limitation of Liability. In no event and under no legal theory, whether in tort (including negligence), contract, or otherwise, unless required by applicable law (such as deliberate and grossly negligent acts) or agreed to in writing, shall any Contributor be liable to You for damages, including any direct, indirect, special, incidental, or consequential damages of any character arising as a result of this License or out of the use or inability to use the Work (including but not limited to damages for loss of

goodwill, work stoppage, computer failure or malfunction, or any and all other commercial damages or losses), even if such Contributor has been advised of the possibility of such damages.

9. **Accepting Warranty or Additional Liability.** While redistributing the Work or Derivative Works thereof, You may choose to offer, and charge a fee for, acceptance of support, warranty, indemnity, or other liability obligations and/or rights consistent with this License. However, in accepting such obligations, You may act only on Your own behalf and on Your sole responsibility, not on behalf of any other Contributor, and only if You agree to indemnify, defend, and hold each Contributor harmless for any liability incurred by, or claims asserted against, such Contributor by reason of your accepting any such warranty or additional liability.

END OF TERMS AND CONDITIONS

Enter keywords in the search window and click  (Search).

You can search for target pages in this guide.

Search Tips

You can search for target pages by entering keywords in the search window.

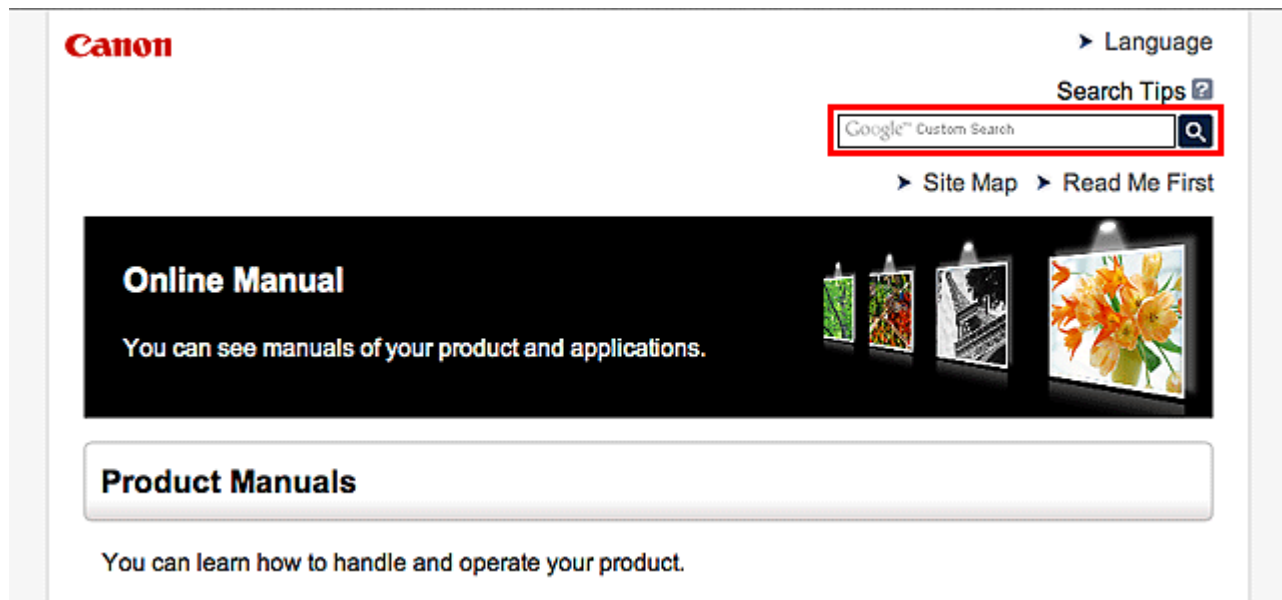

►► Note

- The displayed screen may vary.
- When searching from this page or the "Home" page without entering your product's model name or your application's name, all products supported by this guide will be considered for the search. If you want to narrow down the search results, add your product's model name or your application's name to the keywords.

• **Searching for Functions**

Enter your product's model name and a keyword for the function you want to learn about

Example: When you want to learn how to load paper

Enter "(your product's model name) load paper" in the search window and perform a search

• **Troubleshooting Errors**

Enter your product's model name and a support code

Example: When the following error screen appears

Enter "(your product's model name) 1000" in the search window and perform a search

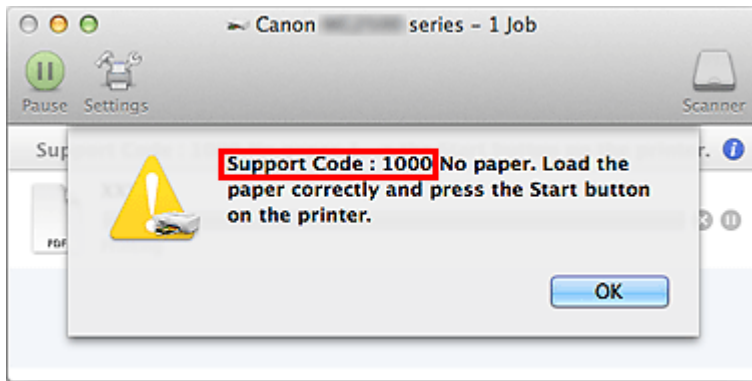

►► Note

- The displayed screen varies depending on your product.

• Searching for Application Functions

Enter your application's name and a keyword for the function you want to learn about

Example: When you want to learn how to print collages with My Image Garden

Enter "My Image Garden collage" in the search window and perform a search

• Searching for Reference Pages

Enter your model name and a reference page title*

* You can find reference pages more easily by entering the function name as well.

Example: When you want to browse the page referred to by the following sentence on a scanning procedure page

Refer to "Color Settings Tab" for your model from Home of the *Online Manual* for details.

Enter "(your product's model name) scan Color Settings Tab" in the search window and perform a search

Notes on Operation Explanations

In this guide, most of the operations are described based on the windows displayed when OS X Mavericks v10.9 is used.

Useful Functions Available on the Machine

- **Connect Wirelessly with Ease in "Access Point Mode"**
- **Download a Variety of Content Materials**
- **Print Items with Easy-PhotoPrint+ (Web Application)**
- **Use the Machine More Conveniently with Quick Toolbox**
- **Connection Methods Available on the Machine**
- **Notice for Web Service Printing**
- **Use MAXIFY Cloud Link**
- **Printing with Google Cloud Print**
- **Printing from AirPrint Compliant Device**
- **Checking Printer Information**
- **Online Storage Integration Function**
- **How to Use Print from E-mail**
- **Print Easily from a Smartphone or Tablet with MAXIFY Printing Solutions**
- **Printing with Windows RT**

Connect Wirelessly with Ease in "Access Point Mode"

The machine supports "access point mode" in which you can connect to the machine wirelessly from a computer or smartphone even in an environment without an access point or wireless LAN router. Switch to "access point mode" with simple steps to enjoy scanning and printing wirelessly.

When you use the machine with the access point mode, be sure to specify the access point name of the machine and the security setting in advance.

■ [Using the Machine with the Access Point Mode](#)



Download a Variety of Content Materials

CREATIVE PARK

A "printing materials site" where you can download all the printing materials for free.

Various types of content such as seasonal cards and paper crafts that can be made by assembling paper parts are provided.

CREATIVE PARK PREMIUM

A service where customers using models that support PREMIUM Contents can download exclusive printing materials.

PREMIUM Contents can be downloaded easily via Easy-PhotoPrint+. Downloaded PREMIUM Contents can be printed directly with Easy-PhotoPrint+.

To download PREMIUM Contents, make sure that genuine Canon ink tanks/ink cartridges are installed for all colors on a supported printer.



►► Note

- The designs of PREMIUM Contents provided in this page are subject to change without prior notice.

Print Items with Easy-PhotoPrint+ (Web Application)

You can easily create and print personalized items such as calendars and collages, anytime and anywhere, by simply accessing Easy-PhotoPrint+ on the web from a computer or tablet.

By using Easy-PhotoPrint+, you can create items in the latest environment without going through the trouble of installation.

Moreover, you can use various photos for your item through integration with social networks such as Facebook, or with online storage, web albums, etc.

Refer to "Easy-PhotoPrint+ Guide" for details.



Use the Machine More Conveniently with Quick Toolbox

Quick Toolbox is a shortcut menu that lets you access the functions you want to use with one click. After installing utilities compatible with Quick Toolbox, they will be added to this menu. The Quick Toolbox provides a convenient way to quickly launch added utilities for making machine settings and doing other management tasks.

Refer to "Quick Toolbox Guide" for details.



Connection Methods Available on the Machine

The following connection methods are available on the machine.

Wireless Connection

With an access point



Without an access point



Wired Connection



USB Connection



Wireless Connection

There are two methods for connecting the printer to your device (such as a smartphone). One method is to connect using an access point, and the other method is to connect without using an access point. The two connection methods cannot be used at the same time.

If you have an access point (or wireless network router), it is recommended that you use the method described in Connection Using an Access Point.

When connecting another device while a device is already connected to the printer, connect it using the same connection method as the connected device.

If you connect using a different connection method, the connection to the device in use will be disabled.

Connection Using an Access Point



- Connect the printer and a device using an access point.
- Connection methods vary depending on the access point type.
- You can change network settings such as the SSID and security protocol on the printer.

- When the connection between a device and an access point is completed and  (Wi-Fi icon) is displayed in the device's screen, you can connect the device to the printer using the access point.

Connection without Using an Access Point



- Connect the printer and a device without using an access point. Connect a device and the printer directly using the printer's access point mode function.
- When establishing a connection in access point mode, Internet connection may become unavailable. In that case, web services for the printer cannot be used.
- If you connect a device connected to the Internet via an access point to the printer that is in access point mode, the connection between the device and access point will be disabled. In that case, the connection of the device may switch to a mobile data connection automatically depending on your device. Transmission fees for connecting to the Internet using a mobile data connection apply.
- In access point mode, you can connect up to five devices at the same time. If you try to connect a sixth device while five devices are already connected, an error will appear. If an error appears, disconnect a device that does not use the printer, then configure settings again.
- Network settings such as the SSID and security protocol can be changed on the printer.

When Using Windows XP:

Connection without Using an Access Point (Windows XP)

Restrictions

(Appears in a new window)

Wired Connection

Connect the printer and a hub or router with an Ethernet cable. Prepare an Ethernet cable.

USB Connection

Connect the printer and a computer with a USB cable. Prepare a USB cable.

Connection without Using an Access Point (Windows XP)

Restrictions

(Appears in a new window)

1. Press the **HOME** button (A) on the printer.

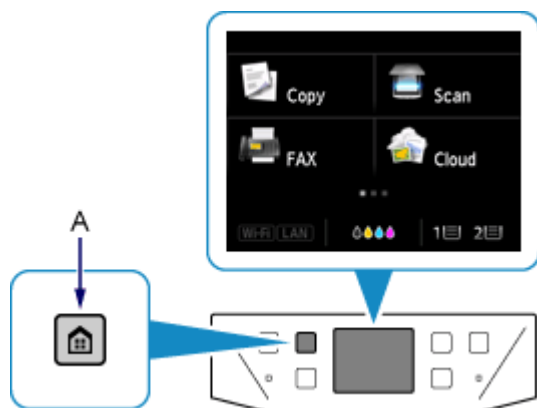

2. Tap the bottom left (B) of the screen.

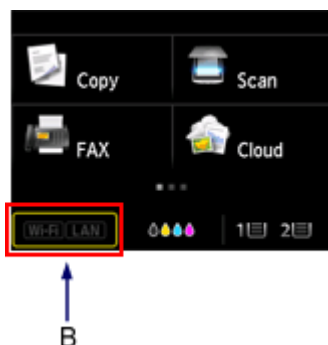

3. Tap **Access point mode active**.

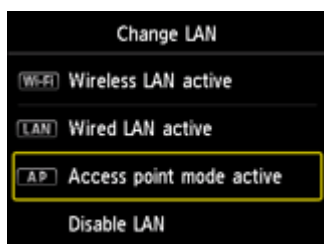

4. Check the **SSID** displayed in the printer screen.
5. Tap **Details**, check the **Password** (network key), then tap **OK**.
You will use the **SSID** and **Password** (network key) in the subsequent steps.

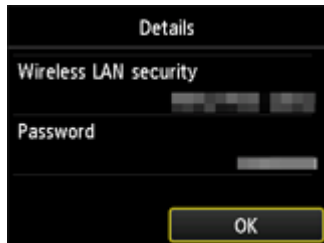
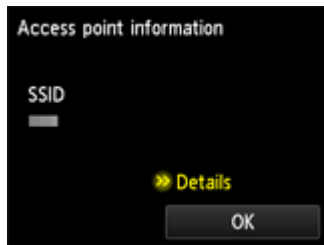

6. Tap **OK**.

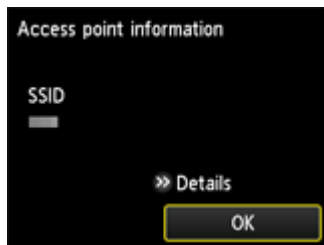

7. Right-click the **Wireless Network Connection** icon in the notification area of the taskbar on the computer, then select **View Available Wireless Networks**.



8. Select the network name (SSID) you want to use, then click **Connect**.

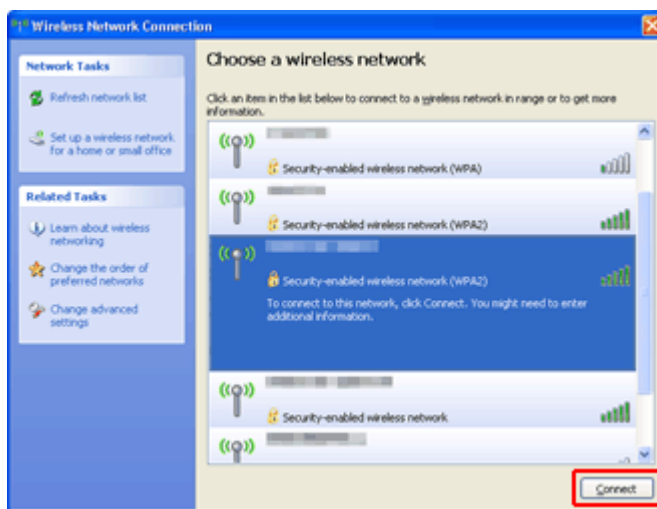

9. Enter the **Password (Network key)**, then click **Connect**.



10. When connection is complete, click **Back** until the screen below appears. Proceed with the setup.

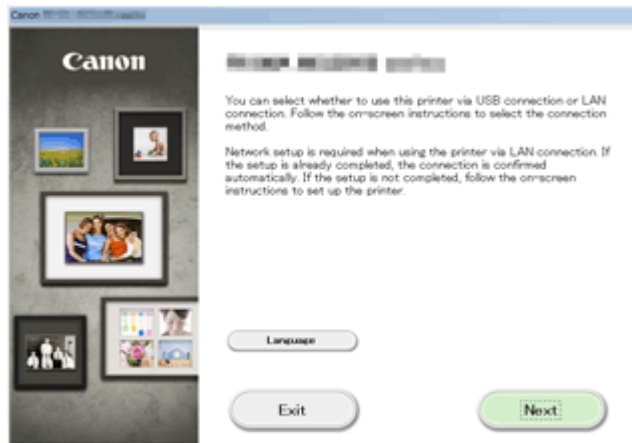

Restrictions

When connecting another device while a device (such as a smartphone) is already connected to the printer, connect it using the same connection method as the connected device.

If you connect using a different connection method, the connection to the device in use will be disabled.

Connection Using a Wired Network cannot be performed on printers that do not support a wired connection.

Connection Using an Access Point

- Make sure that a device and an access point (or wireless network router) are connected. For details on how to check the settings, refer to the manual supplied with the access point or contact its manufacturer.

As for a device already connected to the printer without using an access point, reconnect it via an access point.

- The configuration, router functions, setup procedures and security settings of the network device vary depending on your system environment. For details, refer to the manual of your network device or contact its manufacturer.
- Check if your device supports IEEE802.11n (2.4 GHz), IEEE802.11g or IEEE802.11b.
- If your device is set to the "IEEE802.11n only" mode, WEP or TKIP cannot be used as a security protocol. Change the security protocol for your device to something other than WEP and TKIP or change the setting to something other than "IEEE802.11n only."

The connection between your device and the access point will be temporarily disabled while changing the setting. Do not operate the screen of this guide until the setup is complete.

- For office use, consult your network administrator.
- Take added care when connecting to a network that is not protected with security measures, as there is a risk of disclosing data such as your personal information to a third party.

Connection without Using an Access Point

▶▶▶ Important

- If you connect a device connected to the Internet via an access point to the printer that is in access point mode, the connection between the device and access point will be disabled. In that case, the connection of the device may switch to a mobile data connection automatically depending on your device. When you connect to the Internet using a mobile data connection, charges may apply depending on your contract.
 - When you connect a device and the printer in access point mode, the connection information will be saved to Wi-Fi settings. The device may be connected to the printer automatically even after disconnecting it or connecting it to another access point.
 - You cannot connect to an access point and the printer that is in access point mode at the same time. If you have an access point, it is recommended that you use the access point to connect to the printer.
 - To prevent automatic connection to the printer that is in access point mode, change the connection mode after using the printer, or set not to connect automatically in the Wi-Fi settings of the device.

For details on how to change the settings of a device, refer to the manual supplied with the device or contact its manufacturer.

- When connecting a device and the printer in access point mode, Internet connection may become unavailable. In that case, web services for the printer cannot be used.
- In access point mode, you can connect up to five devices at the same time. If you try to connect a sixth device while five devices are already connected, an error will appear.
If an error appears, disconnect a device that does not use the printer, then configure settings again.
- Devices connected to the printer in access point mode cannot communicate with each other.
- Firmware updates for the printer are not available while using the access point mode.
- When a device has been connected to the printer without using an access point and you want to set it up again using the same connection method, disconnect it first. Disable the connection between the device and printer in the Wi-Fi setting screen.

Connection Using a Wired Network

- This printer cannot be used over wireless and wired connections at the same time.
- When using a router, connect the printer and a device to the LAN side (same network segment).

Notice for Web Service Printing

When Using Web Service

- Canon does not guarantee the continuity and reliability of the web services provided, the availability of site access, or permission to download the materials.
- Canon may at any time update, change, or delete the information provided through the web service, or may suspend or discontinue the service without prior notice. Canon shall not be held responsible for any damages resulting from such actions.
- In no event shall Canon be liable for any damages whatsoever resulting from the use of the web services.
- User registration is necessary before using the photo sharing site.
When you use the photo sharing site, observe the conditions of use of the site and use the service within your own responsibility.
- All or part of the web service may not be available depending on the country or region you live in.
- Depending on your network environment, some functions on web service are not available. Even if they are available, it may take a while to print or display the contents, or communication may be interrupted while operation is in progress.
- When you use web service, your machine's name, information of your region or country, your selected language, and what kind of service you use (e.g. photo sharing site) are sent to and saved in our server. Canon is unable to identify specific customers using this information.
- Your login name and password for the photo sharing site are saved in the machine's memory (not encrypted).
If you hand over the machine to anyone or dispose of it, delete your login name and password from the machine's memory in advance.
- The account information will be sent to Canon Inc. server (located in Japan), then forwarded to the service provider's server.
- Canon handles your account information as follows:
 - Your account information will be used in personal identification process of the selected service.
 - Canon will not provide your account information to any third party without your consent, except for sending to the service provider or providing based on laws and regulations.
 - After the conclusion of non-disclosure agreement, Canon may deposit your account information to the contractor to achieve the purpose of use.
 - Canon endeavors to secure the safety of your account information.
 - It is at your option to enter and send your account information. However, the service that requires to enter your account information is not available unless you enter and send it.
 - Your account information does not remain in Canon Inc. server. At the latest, it will be deleted when you have disconnected your printer from LAN.
 - For details, contact a Canon-authorized sales representative in the country or region you live in.

To Those Living in Mainland China

- PIXMA/MAXIFY Cloud Link, Easy-PhotoPrint+, and some functions of PIXMA/MAXIFY Printing Solutions, which are included with this machine, are provided by Canon Inc.
However, as the server is installed outside of mainland China, some of these services may not be available yet.

Copyrights and Rights of Publicity

When printing from the photo sharing site:

- Observe the conditions of use of the photo sharing site when you use photos on the site.
- It is unlawful to reproduce or edit the copyrighted work of another person without permission from the copyright holder, except for personal use, use within the home, or other use within the limited scope as defined by the copyright. Additionally, reproducing or editing photographs of people may infringe on Rights of Publicity.

When printing downloaded template forms:

1. The copyright of each material (photos, illustrations, logos, or documents: hereinafter referred to as "the materials") provided on the web template printing service belongs to their respective owners. Issues pertaining to Rights of Publicity may arise regarding the use of any of people or characters displayed on the web template printing service.

Except as otherwise permitted (please see "2" below), copying, modifying or distributing all or a portion of any of the materials contained on the web template printing service without prior consent of the respective rights (Rights of Publicity and Copyright) holder is strictly prohibited.

2. All of the materials provided on the web template printing service can be freely used for personal and non-commercial purposes.

Use MAXIFY Cloud Link

By using MAXIFY Cloud Link, you can connect your printer to a cloud service, such as CANON iIMAGE GATEWAY, Evernote, or Twitter, and use the following functions without using a computer:

- Print images from a photo-sharing service
- Print documents from a data management service
- Save scanned images to a data management service.
- Use Twitter to report the printer status, such as no paper or low ink levels.

In addition, you can use various functions by adding and registering apps that are linked with various cloud services.

■ [Using MAXIFY Cloud Link from Your Printer](#)

■ [Using MAXIFY Cloud Link from Your Smartphone, Tablet, or Computer](#)



▶▶▶ Important

- In certain countries, MAXIFY Cloud Link may not be available or the available apps may be different.
- Some apps require that you have an account before you use those apps. For such apps, please set up an account beforehand.
- To find out which models support MAXIFY Cloud Link check the Canon homepage.
- The screen display may change without prior notice.

Using MAXIFY Cloud Link from Your Printer

- ▶ [Before Using MAXIFY Cloud Link from Your Printer](#)
- ▶ [Preparing to Use MAXIFY Cloud Link from Your Printer](#)
- ▶ [Using MAXIFY Cloud Link](#)
- ▶ [Cloud Troubleshooting](#)

Before Using MAXIFY Cloud Link from Your Printer

First, check the following content:

- **Precautions**

If you plan to use the web service to print documents, be sure to check these [precautions](#) beforehand.

- **Network environment**

The printer must be connected to a LAN and to the Internet.

If your printer is not connected to a LAN, see here and set one up.

For information on the LAN and Internet settings, see the manual of your network devices or contact the manufacturer.

▶▶▶ Important

- The user will bear the cost of Internet access.

■ [Preparing to Use MAXIFY Cloud Link from Your Printer](#)

Copyright c 1991-2013 Unicode, Inc. All rights reserved. Distributed under the Terms of Use in <http://www.unicode.org/copyright.html>.

This software is based in part on the work of the Independent JPEG Group.

THE BASIC LIBRARY FUNCTIONS

Written by: Philip Hazel

Email local part: ph10

Email domain: cam.ac.uk

University of Cambridge Computing Service, Cambridge, England.

Copyright (c) 1997-2008 University of Cambridge All rights reserved.

THE "BSD" LICENCE

Redistribution and use in source and binary forms, with or without modification, are permitted provided that the following conditions are met:

- * Redistributions of source code must retain the above copyright notice, this list of conditions and the following disclaimer.
- * Redistributions in binary form must reproduce the above copyright notice, this list of conditions and the following disclaimer in the documentation and/or other materials provided with the distribution.
- * Neither the name of the University of Cambridge nor the name of Google Inc. nor the names of their contributors may be used to endorse or promote products derived from this software without specific prior written permission.

THIS SOFTWARE IS PROVIDED BY THE COPYRIGHT HOLDERS AND CONTRIBUTORS "AS IS" AND ANY EXPRESS OR IMPLIED WARRANTIES, INCLUDING, BUT NOT LIMITED TO, THE IMPLIED WARRANTIES OF MERCHANTABILITY AND FITNESS FOR A PARTICULAR PURPOSE ARE DISCLAIMED. IN NO EVENT SHALL THE COPYRIGHT OWNER OR CONTRIBUTORS BE LIABLE FOR ANY DIRECT, INDIRECT, INCIDENTAL, SPECIAL, EXEMPLARY, OR CONSEQUENTIAL DAMAGES (INCLUDING, BUT NOT LIMITED TO, PROCUREMENT OF SUBSTITUTE GOODS OR SERVICES; LOSS OF USE, DATA, OR PROFITS; OR BUSINESS INTERRUPTION) HOWEVER CAUSED AND ON ANY THEORY OF LIABILITY, WHETHER IN CONTRACT, STRICT LIABILITY, OR TORT (INCLUDING NEGLIGENCE OR OTHERWISE) ARISING IN ANY WAY OUT OF THE USE OF THIS SOFTWARE, EVEN IF ADVISED OF THE POSSIBILITY OF SUCH DAMAGE.

Preparing to Use MAXIFY Cloud Link from Your Printer

Follow the steps described below to register the printer information to the cloud service server.

1. Check that the printer is connected to the Internet

2. From the printer home screen, select  **Cloud**

3. When the registration completed screen appears, select **OK**



4. On the confirmation screen, select **Next**

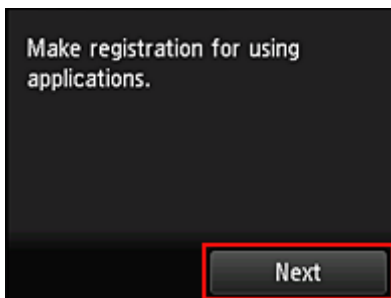

▶▶▶ Note

- [If multiple users will be using the printer](#) after the initial registration, select the login user name from the user selection screen, enter the [Security code](#), and proceed with the registration. If the **Security code** is incorrect, use your smartphone, tablet, or computer, and change the setting from the [User information](#) of the Canon Inkjet Cloud Printing Center.

5. In the **License agreement** and **Privacy statement** windows, read the statements, and then select **Agree** if you agree

<License agreement>

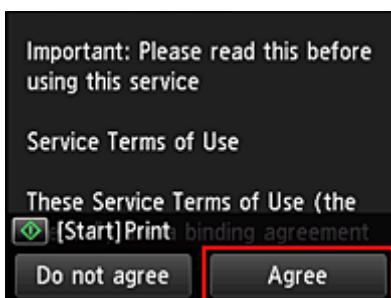



<Privacy statement>

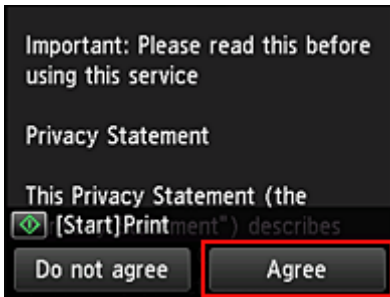

▶▶▶ Note

- If you select **Disagree**, a confirmation screen of canceling the user information registration appears. If you select **Yes**, the user information registration is canceled, and you return to the Home screen.
Even if you select **Disagree**, you can still use this service by selecting **Agree** from the registration screen later.
- You can print the displayed information by pressing the **Start** button.

6. On the **Time zone** screen, select the time closest to your region, and then select **Next**

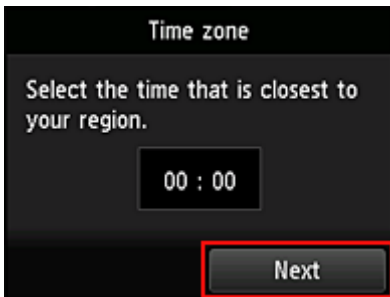

7. In the time zones list, select the region closest to you

For some regions, a screen for applying the daylight saving time setting may appear.

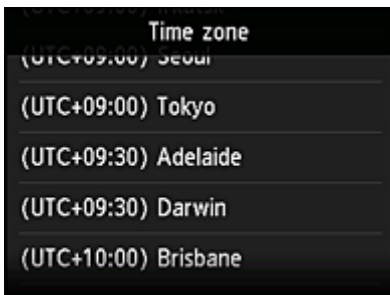

8. When a message appears notifying that the app is now available, select **Open list**

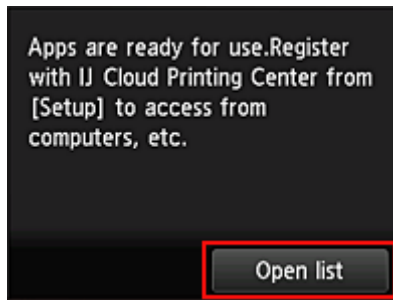

The registration of printer information is completed, and a list of apps is displayed. See [here](#) for the description of the apps list screen.

After you complete the registration, you can [print photos and documents](#) that have been uploaded to apps on the linked cloud service and [add/delete/sort apps](#).

■ [Using MAXIFY Cloud Link](#)

Application Management

Only the [Administrator of the printer](#) can use this service.

This section explains how to [add](#), [delete](#), and [sort](#) apps.

Add apps

You can add your favorite apps to the printer.
Follow the steps described below to add apps.

1. From the printer home screen, select  **Cloud**
2. On the cloud's Main screen, select **Add/delete**

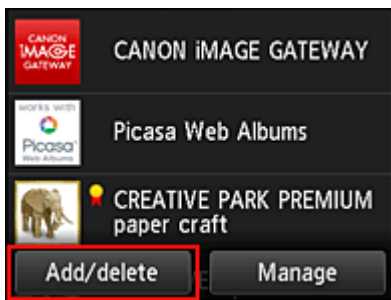

3. Select **Register apps**

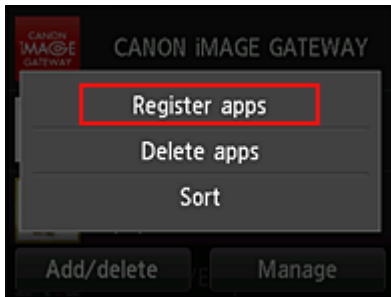

4. From the list, select the category of the app

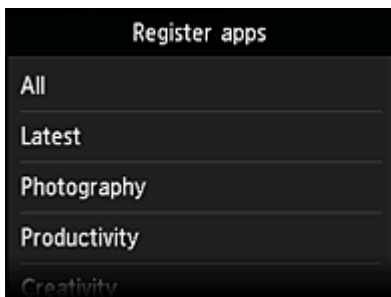

5. From the displayed apps list, select the app that you want to register

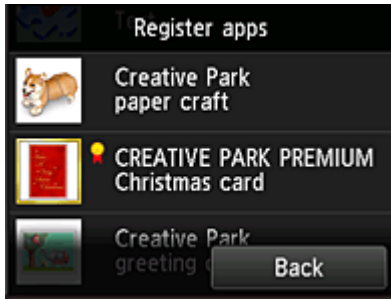

▶▶▶ Note

- Description of displayed icons
 : Can be used with genuine Canon ink.

6. Select **Register**

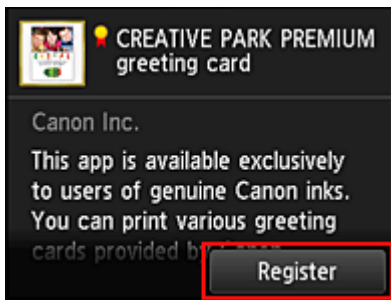

The registration is completed and the app is added to the apps list.

To register another app, repeat the procedure from step 5.

To end the app registration, select **Back** and return to the cloud's Main screen.

▶▶▶ Important

- Some apps may require a linked app account before you can use the app. If this is the case, set up an account beforehand.

Delete apps

You can delete unnecessary apps from the apps list.

Follow the steps described below to delete apps.

1. From the printer home screen, select  **Cloud**
2. On the cloud's Main screen, select **Add/delete**

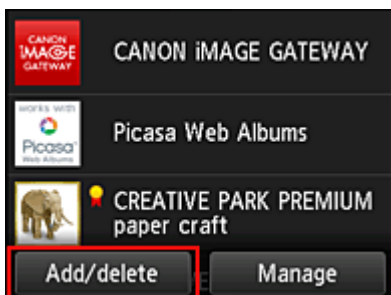

3. Select **Delete registered apps**

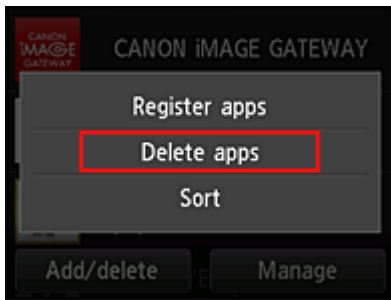

4. From the apps list, select the app that you want to delete

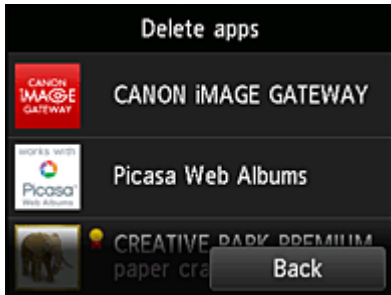

➤➤➤ Note

- Description of displayed icons
 -  : Cannot be used because it is not yet released, not available in your region, or does not support your model.
 -  : Can be used with genuine Canon ink.

5. Select **Delete**

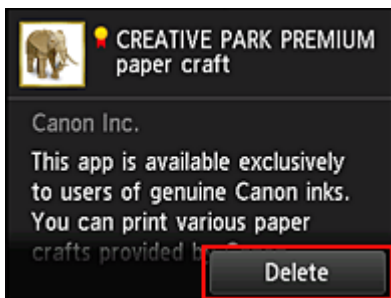

When the deletion is finished, the app will be deleted from the apps list on the main screen.

To delete another app, repeat the procedure from step 4.

To end the app deletion, select **Back** and return to the cloud's Main screen.

Sort apps

You can sort apps displayed on the apps list.

Follow the steps described below to sort apps.

1. From the printer home screen, select  **Cloud**

2. On the cloud's Main screen, select **Add/delete**

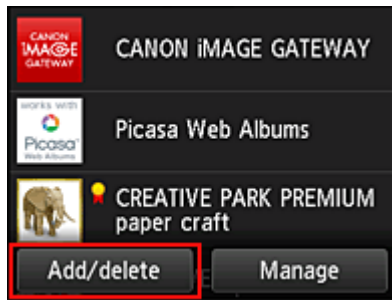

3. Select **Sort**

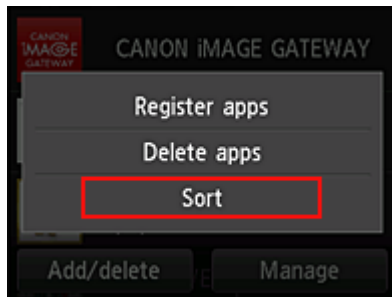

4. On the apps list, select the app that you want to sort

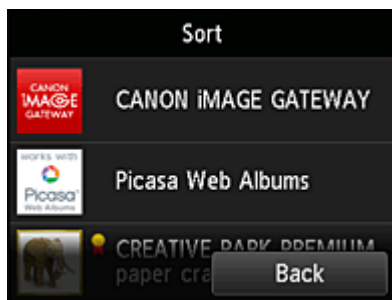

➤➤➤ Note

- Description of displayed icons
 - ⊘ : Cannot be used because it is not yet released, not available in your region, or does not support your model.
 - 🏆 : Can be used with genuine Canon ink.

5. Use ▲ / ▼ buttons to move the app

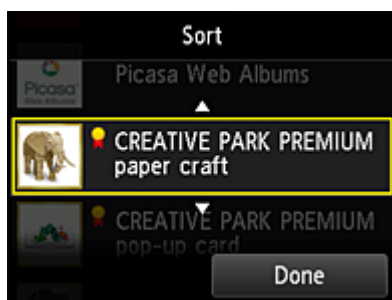

6. Select **Done**

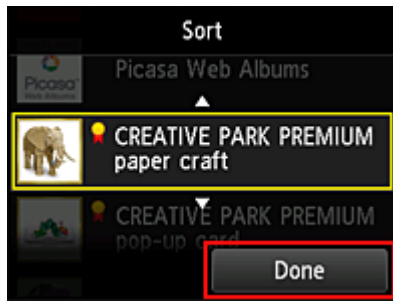

Sorting is complete.

To continue the sorting, repeat the procedure from step 4.

To end the sorting, select **Back** and return to the cloud's Main screen.

Using MAXIFY Cloud Link

This section introduces the photo printing procedure by using CANON iIMAGE GATEWAY as an example.

Important

- The available functions differ depending on the app.
- The printing procedure differs depending on the app.
- You need to get the account and register photo and other data beforehand.
- The following file formats can be printed: jpg, jpeg, pdf, docx, doc, xlsx, xls, pptx, ppt, and rtf.
The file formats that can be printed differ depending on the app.
- Before you print, check that printer is on and is connected to the network. Then start.

Note

- You can use CANON iIMAGE GATEWAY to print jpg and jpeg file formats.

1. On the [Main screen](#), select the app to be used
2. Enter the information according to the instructions on the authentication screen, and then select **Log in**

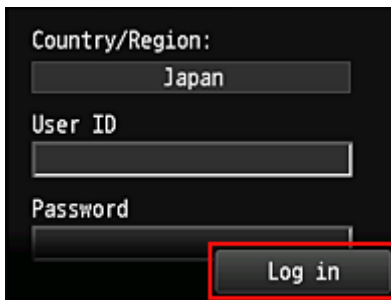

Important

- Some apps may not be fully displayed in the display area. If this is the case, scroll up, down, right, and left to change the display area.

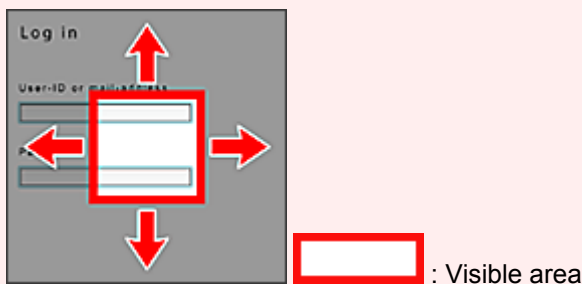

- The Login screen may vary between apps.
- After logging in, you may be asked from an external service to agree to use their app. Agree if you are using the app.

3. In the displayed album list, select the album of your choice



4. In the displayed image list, select the image that you want to print, and then select **Next**



5. Make the necessary print settings, and then select **Color**

A message that indicates the completion of issuing print job appears, and printing starts.



To continue printing, select **Continue**, and perform the operation from Step 3.

To end the printing, select **Apps**. The screen returns to the apps list screen.

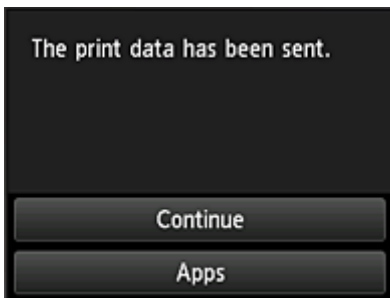

»» Important

- If a print job is not printed within 24 hours after the print job is issued, the print job will expire and cannot be printed.
- With premium apps that limit the number of print jobs, print jobs that cannot be printed due to expiration and other reasons are also included in the print count.

»» Note

- To leave a usage history of this service, from the Home window on the operation panel, select 

 **Setup -> Web service setup -> Web service connection setup -> IJ Cloud Printing Center setup -> History setting for this service -> Save.**

■ [Cloud Troubleshooting](#)

Cloud Windows

This section describes the Main screen of **Cloud** and the services available on the Main screen. When using the **Cloud** function, follow the steps described below first and display the Main screen.

▶▶▶ Important

- With this service, the functions available to **Standard user** of the printer are different from those available to the printer **Administrator**.
Standard user can only use the functions marked by an asterisk (*).



When you select **Cloud** from the printer home screen, the cloud's Main screen appears.

You can use areas shown below to perform various functions, including printing photos and documents*, and adding, starting*, and managing apps.



- (1) [Display area](#)
- (2) [Add/delete button](#)
- (3) [Manage button](#)

▶▶▶ Important

- Some apps may require you to have an account before using the app. If this is the case, get the account beforehand.
- After selecting the app, some apps may not be fully displayed in the display area. If this is the case, scroll up, down, right, and left to change the display area.

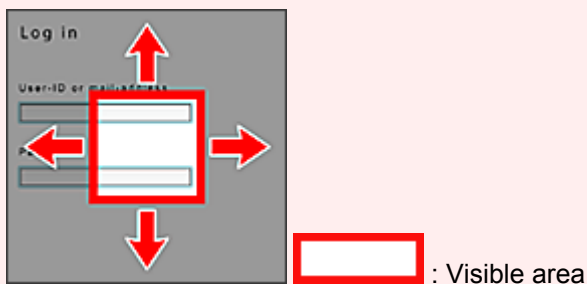

- The app is not displayed if it is not yet released, or if the language not available in your region is selected in the display language setting.

(1) Display area

The display changes based on the menu you select.

Immediately after the cloud's Main screen appears, a list of the registered apps appears.

To start an app, select the app that you want to use on the list.

»» Note

- Description of displayed icons



: Cannot be used because it is not yet released, not available in your region, or does not support your model.



: Can be used with genuine Canon ink.

(2) Add/delete button

Use this button to add, delete, and sort apps.

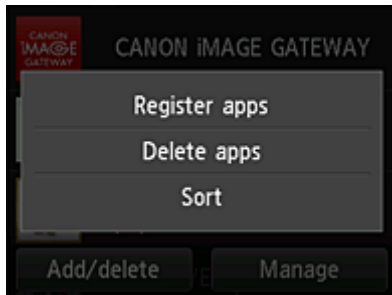

Register apps

Select this to add your favorite apps.

- [See here for details on how to add apps](#)

Delete apps

Select this to delete registered apps.

- [See here for details on how to delete apps](#)

Sort

Select this to sort the apps list.

- [See here for details on how to sort the apps list](#)

(3) Manage button

Use this button to manage jobs*, log out of an app*, show the license agreement and privacy statement*, and set the time zone*.

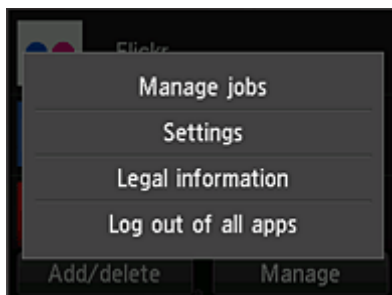

Manage jobs*

From the **Status list** window, you can check the status of a job.

Settings*

Select this to set the **Time zone**.

Select your region on the list. For some regions, you can set whether or not to apply the daylight saving time setting.

»» Important

- If you cannot find your region on the list, select the one closest to your region.

Legal information*

This shows the **License agreement** and **Privacy statement**.

Press the **Start** button to print the displayed information.

Log out of all apps*

You can log out at the same time from all apps that you are logged into.

»» Note

- Some apps may not allow you to log out when you are logged on. If you want to log in with a different account, you need to use this function to log out first.
- Once you log out, you need to log in again. You may lose the settings with some apps.

Cloud Troubleshooting

If you cannot print

Check the following if you cannot print.

- Check that the printer is connected to the Internet.
- Check that the printer is connected to a LAN and the LAN environment is connected to the Internet.
- Check that no error message is displayed on the printer's LCD monitor.



- If printing does not start even after you wait awhile, go to the printer home screen and run **Setup -> Web service inquiry**. If printing does not start, run the inquiry several times.

If the problem is not resolved, use the printer driver from your computer to perform the print job and check whether the data can be printed normally on the printer.

If you still cannot print, see the troubleshooting page for your model on the Home of the *Online Manual*.

▶▶ Note

- With a wireless LAN connection, after the printer is turned on, it may take several minutes before communication is possible. Check that your printer is connected to the wireless network, and wait a while before you start printing.
- If the printer is not turned on or is not connected to the Internet, and consequently a print job is not processed within 24 hours after it was submitted, the print job is automatically canceled. If this happens, check the printer power and the Internet connection, and then re-submit the print job.

Using MAXIFY Cloud Link from Your Smartphone, Tablet, or Computer

- ▶ **Before Using Canon Inkjet Cloud Printing Center**
- ▶ **Preparations Before Using Canon Inkjet Cloud Printing Center**
- ▶ **Using Canon Inkjet Cloud Printing Center**
- ▶ **Adding a Printer**
- ▶ **Adding a MAXIFY Cloud Link User**
- ▶ **Troubleshooting Canon Inkjet Cloud Printing Center**

Before Using Canon Inkjet Cloud Printing Center

Canon Inkjet Cloud Printing Center is a service that links with the cloud function of the printer and allows you to perform operations such as registering and managing apps from your smartphone or tablet device, and checking the print status, print error, and ink status of the printer. You can also print app photos and documents from your smartphone or tablet.

First, check the following content:

- **Precautions**

If you plan to use the web service to print documents, be sure to check these [precautions](#) beforehand.

- **Printer specification**

Check that Canon Inkjet Cloud Printing Center supports the printer.

- **Network environment**

The printer must be connected to a LAN and to the Internet.

▶▶▶ Important

- The user will bear the cost of Internet access.

- **Operating requirements**

For computers, smartphones, and tablet devices, see "[Requirements for Canon Inkjet Cloud Printing Center operation](#)".

▶▶▶ Important

- This service may not be available in certain countries or regions. Also even if the service is available, there are apps that cannot be used in certain regions.

■ [Preparations Before Using Canon Inkjet Cloud Printing Center](#)

Requirements for Canon Inkjet Cloud Printing Center operation

Computer

CPU	x86 or x64 1.6 GHz or higher
RAM	2 GB or higher
Monitor display	Resolution 1024 x 768 pixels or higher Number of display colors 24 bits (true-color) or higher

OS	Browser
Windows XP SP3 or later	Internet Explorer 8* Mozilla Firefox Google Chrome
Windows Vista SP1 or later	Internet Explorer 8*, 9 Mozilla Firefox Google Chrome
Windows 7	Internet Explorer 8*, 9, 10, 11 Mozilla Firefox Google Chrome
Windows 8	Internet Explorer 10 Mozilla Firefox Google Chrome
Windows 8.1	Internet Explorer 11 Mozilla Firefox Google Chrome
Mac OS X v10.6-OS X Mavericks v10.9	Safari 5.1, 6, 7

* When you use Internet Explorer 8, the web pages may not display correctly. Canon recommends that you upgrade to Internet Explorer 9 or later, or use another browser.

Smartphone or tablet

OS	Browser	Resolution
iOS 5.1 or later	OS standard browser	320 x 480 (HVGA) or higher
Android 2.3.3 or later		480 x 800 (HVGA) or higher

*Android3.x is not supported.

Important

- On the browser you are using, enable JavaScript and cookies.
- If you use the zoom function or change the font size on your browser, the web pages may not display correctly.
- If you use the translation function of Google Chrome, the web pages may not display correctly.
- If you use a proxy server outside of your country, the service may not be able to determine the correct region.



- In an in-house network environment, the 5222 port must be released. For confirmation instructions, contact the network administrator.

Preparations Before Using Canon Inkjet Cloud Printing Center

To use the Canon Inkjet Cloud Printing Center, you need to follow the steps described below and register the user information.



Print registration information from the printer

1. From the home window, select  **Setup** ->  **Web service setup** -> **Web service connection setup** -> **IJ Cloud Printing Center setup** -> **Register with this service**
2. In the registration confirmation window, Select **Yes**

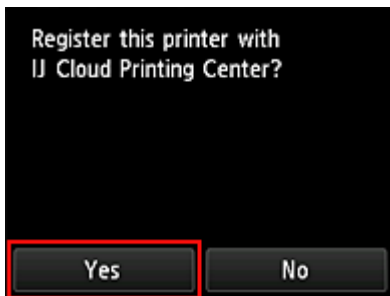

3. In the print settings, select the display language



4. Follow the instructions displayed in the window, and print the URL of the authentication site and the [Printer registration ID](#)

Set A4 size or Letter size or Legal size plain paper and select **OK**.

The authentication URL and **Printer registration ID** are printed.

»» Note

- You will use this printed page in the next step.

Canon Inkjet Cloud Printing Center

User registration

To use Canon Inkjet Cloud Printing Center, you need to register the printer owner information.

Access the URL below from a browser on a computer, smartphone, etc., then enter the printer registration ID to register.

[Note]

All operations up to the completion of registration must be performed within approximately 60 minutes from now. Beyond that time, the printer registration ID below will be disabled.

URL:

Printer registration ID:

Copyright CANON INC.

»» Important

- The operation to complete the registration should be done within 60 minutes.

Access the URL on the printed page, and then enter the e-mail address and other necessary information

»» Important

- Do not use the Back button of the web browser while an operation is processing. The screen may not transition properly.

1. Use the web browser on your PC, smartphone, tablet, or other devices to access the authentication URL

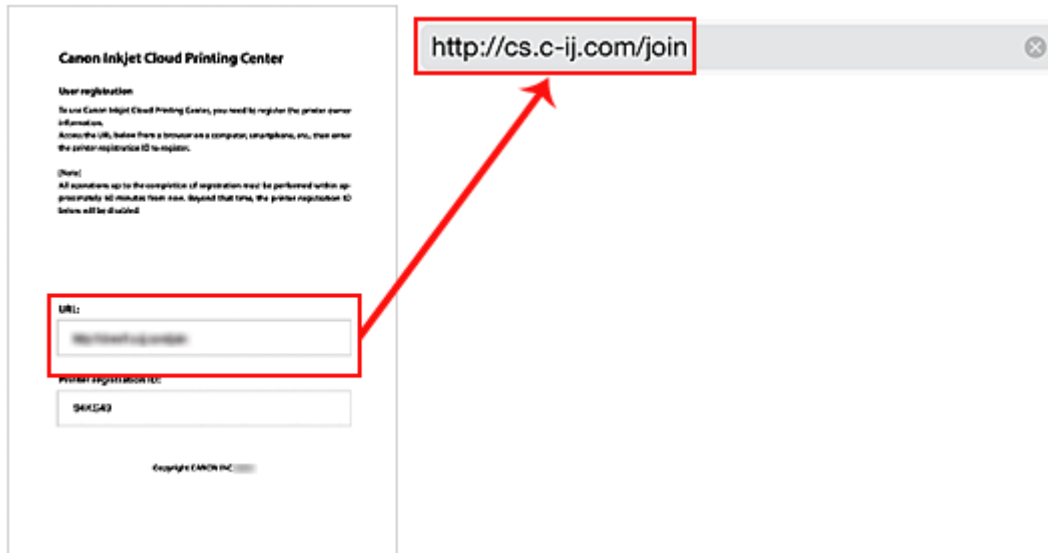

2. On the Login screen, select **Create new account**



3. Enter the **E-mail address** and **Printer registration ID** of the printer's owner, and then select **OK**

The registration page URL is sent to the e-mail address entered.

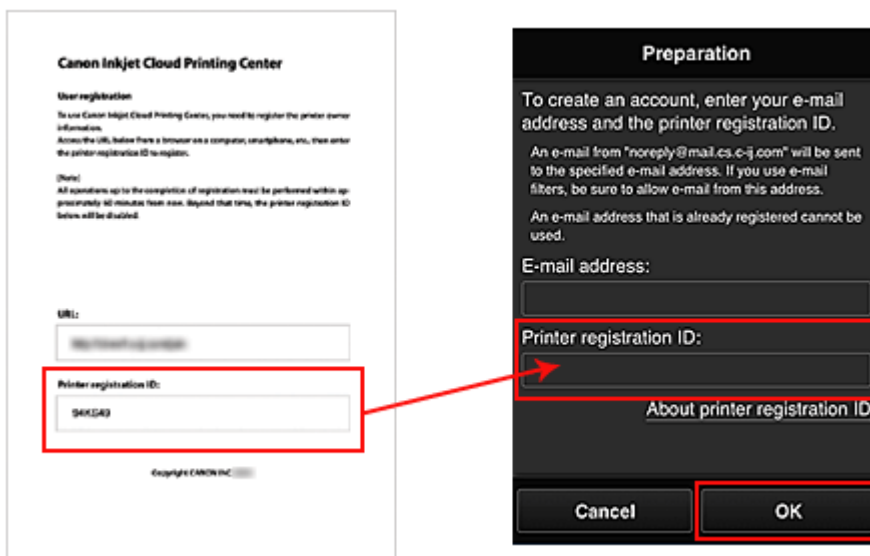

Important

- There are character restrictions for the e-mail address, as shown below.
 - You can use up to 255 alphanumeric characters consisting of single-byte characters and symbols (!\$*/^_{}|~.-@).
 - Multibyte characters cannot be used.
You will get an error if the e-mail address you enter contains a character that cannot be used.
- If you registered a different e-mail address by mistake, you can cancel the registration by going to the printer's Home screen and selecting **Setup** (or by pressing the **Setup** button on the operation panel) -> **Web service setup** -> **Connection setup** -> **IJ Cloud Printing Center setup (IJCloudPrintingCtr)** -> **Delete from this service**.
- You may not be able to receive the notification if you are using a spam filter. If you have a setting to receive only the e-mails from certain domains, be sure to change the setting to allow receiving e-mails from "noreply@mail.cs.c-ij.com".
There will be no error display even if you could not receive the e-mail because of the spam filter setting or if you entered an incorrect e-mail address.

Access the URL in the e-mail, register the information, and complete the user registration

1. When an e-mail with the subject "Information on Canon Inkjet Cloud Printing Center" is sent to the e-mail address that you entered, select the URL
2. In the **License agreement** and **Privacy statement** windows of Canon Inkjet Cloud Printing Center, read the statements, and select **Agree** if you agree

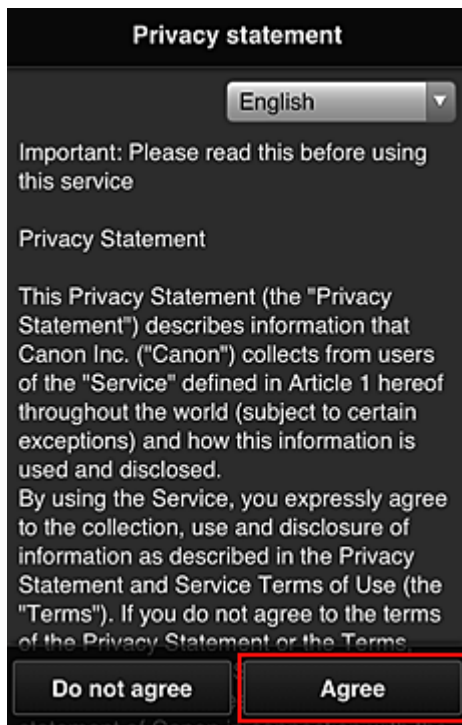
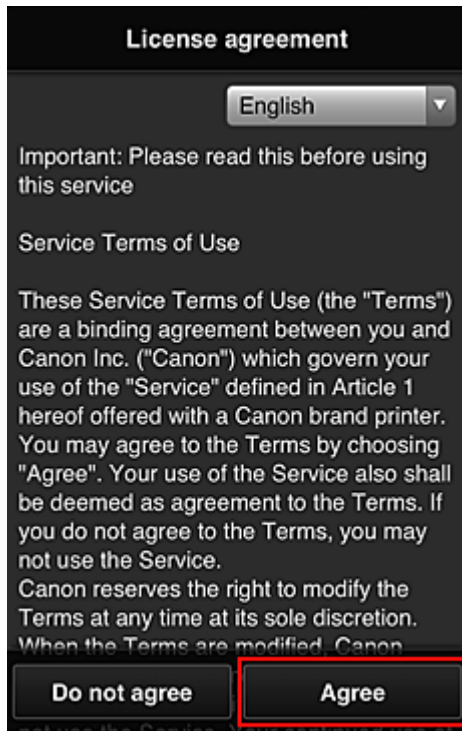

3. In the user information entry screen, enter your **Password**, and select **Next**
Enter your password for logging in to the Canon Inkjet Cloud Printing Center.

Register user info

Set a password for logging into this service.

Password:

Password (Confirmation):

8 to 32 characters

Cancel Next

»» Important

- There are character restrictions for the **Password**, as shown below.
- The password needs to be between 8 and 32 characters long, using single-byte alphanumeric characters and symbols (!"#\$%&'()*+,-./:;<=>?@[\\]^_`{|}~). (Alphabets are case-sensitive)

4. Enter the **User name**

Enter the name that identifies the user.

Register user info

User Name:

1 to 20 characters

Time zone:

(UTC) Coordinated Universal Time ▼

Back Next

»» Important

- The **User name** entry field has the following character restrictions:

- The user name needs to be between 1 and 20 characters long, using single-byte alphanumeric characters and symbols (!"#\$\$%&'()*+,-./:;<=>?@[\\]^_`{|}~). (Alphabets are case-sensitive)

5. Specify the **Time zone** setting, and select **Next**

Select your region on the list. If you cannot find your region on the list, select the one closest to your region.

Apply daylight saving time

This appears only when there is a daylight saving time in the **Time zone** that you selected.

Select whether or not to apply the daylight saving time.

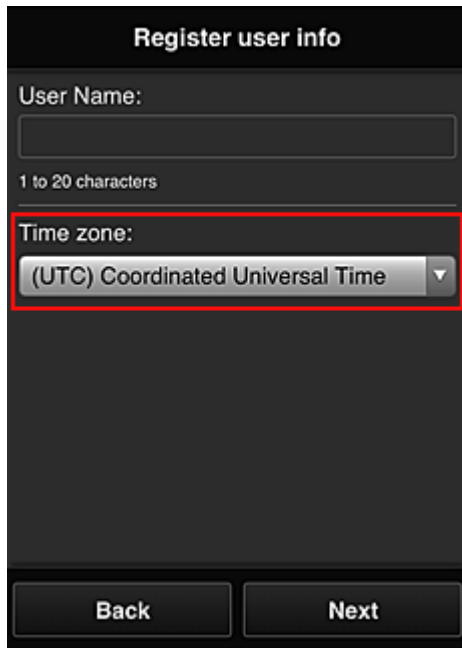

The screenshot shows a mobile application interface titled "Register user info". It features a "User Name:" label above a text input field, with a note below it stating "1 to 20 characters". Below the input field is a "Time zone:" label above a dropdown menu. The dropdown menu is open, showing the selected option "(UTC) Coordinated Universal Time" with a downward arrow. At the bottom of the screen, there are two buttons: "Back" and "Next".

6. Enter the **Security code** and select **Done**

A [Security code](#) identifies the user when multiple other users are sharing the same printer.

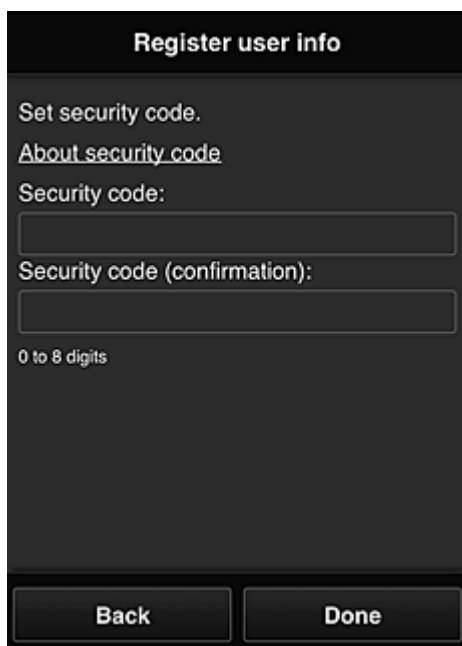

The screenshot shows a mobile application interface titled "Register user info". It features a "Set security code." label, followed by a link "[About security code](#)". Below this is a "Security code:" label above a text input field. Underneath is a "Security code (confirmation):" label above another text input field. A note below the second input field states "0 to 8 digits". At the bottom of the screen, there are two buttons: "Back" and "Done".

»» Important

- The **Security code** entry field has the following character restrictions:
 - Single-byte numbers

The registration is complete. A registration completion message is displayed.

When you select the **OK** button in the message, the login screen is displayed.

Enter the registered e-mail address and password, and [log in](#) to the Canon Inkjet Cloud Printing Center.

■ [Using Canon Inkjet Cloud Printing Center](#)

Printing Your Printer registration ID



To add a printer by using Canon Inkjet Cloud Printing Center, you will need a **Printer registration ID**.

From the operation panel of this printer, print the URL of the authentication site and your **Printer registration ID**. The procedure is as follows:

1. Check that the printer is connected to the Internet

▶▶▶ Important

- To use this function, you must connect this printer to the Internet.

2. From the home window, select  **Setup** ->  **Web service setup** -> **Web service connection setup** -> **IJ Cloud Printing Center setup** -> **Register with this service**

3. In the registration confirmation window, Select **Yes**



4. In the print settings, select the display language



5. Follow the instructions displayed in the window, and print the URL of the authentication site and your **Printer registration ID**

When you set A4 size or Letter size or Legal size plain paper and select **OK**, the authentication site URL and your **Printer registration ID** are printed.

▶▶▶ Important

- The operation to complete the registration should be done within 60 minutes.

Canon Inkjet Cloud Printing Center window

This section describes the Canon Inkjet Cloud Printing Center screens that are displayed on your smartphone, tablet device, or computer.

■ [Description of the Login screen](#)

■ [Description of the Main screen](#)

Description of the Login screen

This section provides the description of the Login screen of Canon Inkjet Cloud Printing Center.

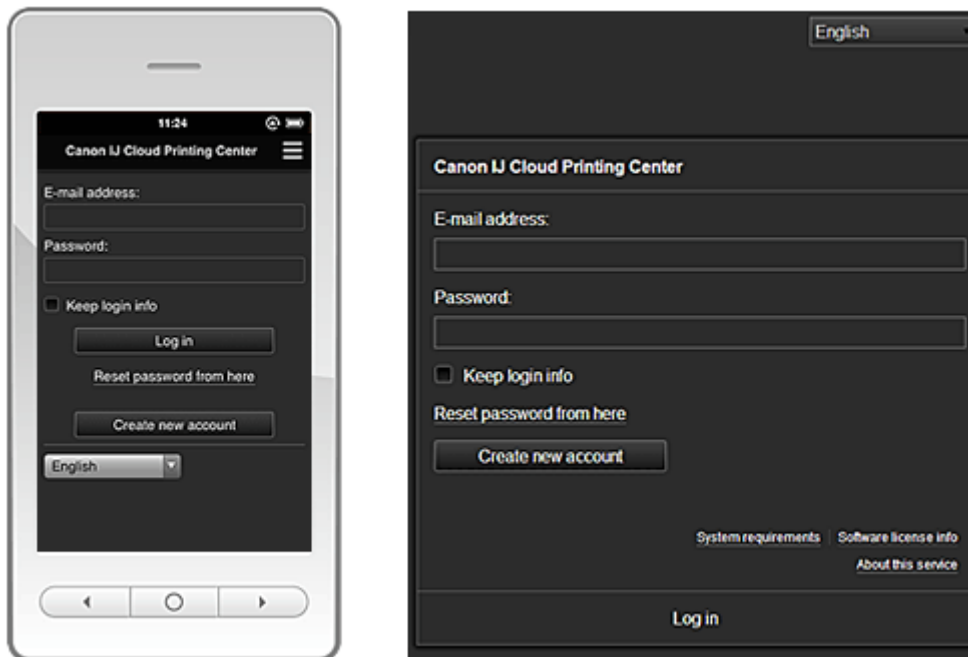

►► Important

- You have 5 tries to enter your password. If you fail, you will not be able to log in for about the next hour.
- You remain logged in for an hour after the last access.

Language

Select the language you will be using.

E-mail address

Enter the e-mail address that you entered in the user registration.

►► Important

- The e-mail address is case-sensitive. Make sure the case is correct.

Password

Enter the password that you entered in the user registration.

Keep login info

When you select the check box, the login screen is skipped for 14 days since the last day that the service screen was accessed.

Reset password from here

Select this if you forgot the password.

Reset your password by following the instructions on the screen.

Create new account

A new registration will be added to the Canon Inkjet Cloud Printing Center.

For a new registration, you need the [Printer registration ID](#).

System requirements

This displays the system requirements for the Canon Inkjet Cloud Printing Center.

Help/legal notices (smartphone and tablet devices only)

The description of the Canon Inkjet Cloud Printing Center screen and various reminders are displayed.

Software license info

The licensing information of Canon Inkjet Cloud Printing Center is displayed.

About this service

This displays the descriptions of this service.

Description of the Main screen

When you log in to the Canon Inkjet Cloud Printing Center, the Main screen appears.

▶▶ Important

- With this service, the functions available to [Standard user](#) of the printer are different from those available to the printer [Administrator](#).
Standard user can only use the functions marked by an asterisk (*).

You can use areas shown below to start*, add, and manage apps.

If you are using a smartphone or a tablet, you can also print photos and documents.

■ [If you are using a smartphone or tablet](#)

■ [If you are using a PC](#)

If you are using a smartphone or tablet

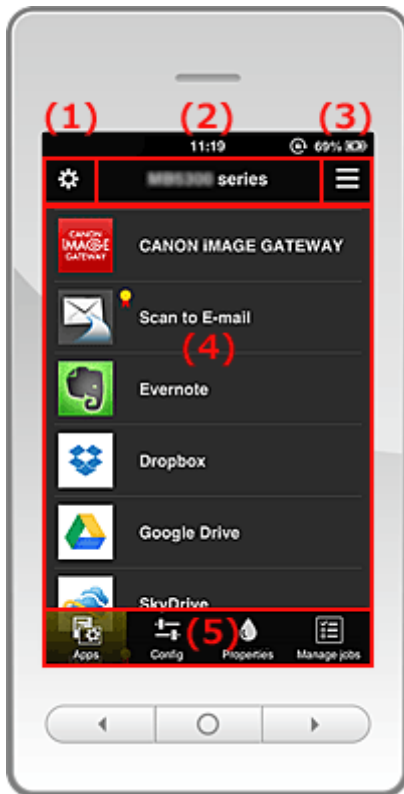

- (1) [Left context menu](#)
- (2) [Printer name area](#)
- (3) [Right context menu](#)
- (4) [Display area](#)
- (5) [Menu area](#)

(1) Left context menu

When you select , the **Mng. printer** screen of the **Manage users** screen appears. For general users, the **Select printer** screen appears.

Mng. printer screen (Select printer screen)

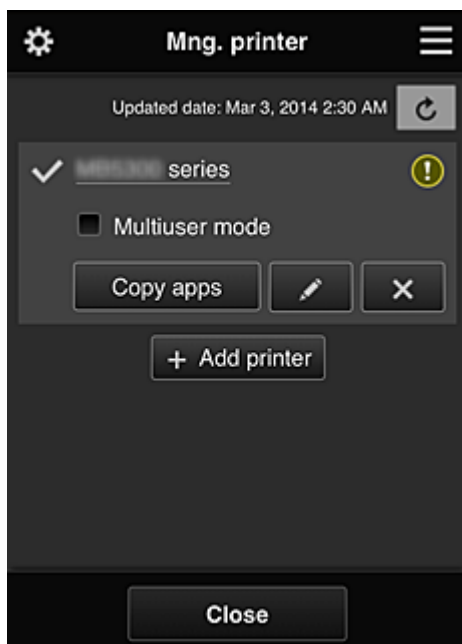

From the **Mng. printer** screen (**Select printer** screen), you can [check*](#) and [update*](#) printer information registered to the Canon Inkjet Cloud Printing Center, [change printer names](#), [delete printers](#), [add printers](#), and [copy apps](#).

- **Check the printer information***



The registered printer name is displayed.

indicates the currently selected printer.

 indicates that an error occurred on the printer.

- **Display update date/time of the printer information***

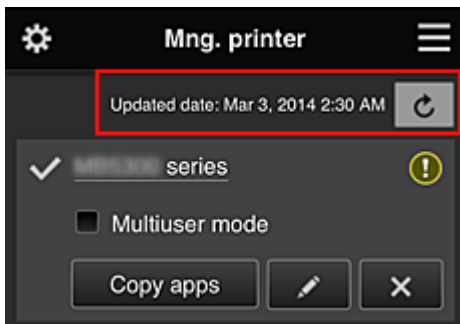

This displays the date and time the printer information was last updated.

 refreshes the information.

- **Multiuser mode**

If multiple users are using the printer, select the [Multiuser mode](#) check box.

- **Copy apps**

Select this to copy apps added in the selected printer to another printer.

When you select , the screen shown below appears.

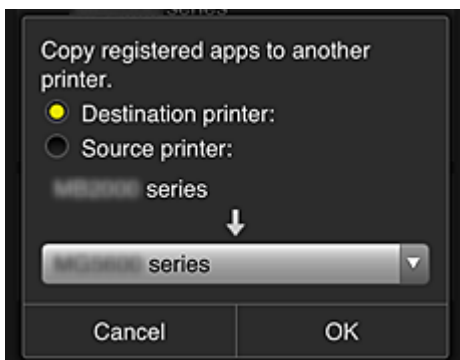

Set the **Destination printer** and the **Source printer**. Then select **OK**.

- **Change the printer name**

When you select , a screen to change the printer name appears. Follow the instructions on the screen to change the name.

▶▶▶ Note

- The printer name entry has the following character limitation:
 - Up to 128 characters

- **Delete printers**

When you select , the printer is deleted from the Canon Inkjet Cloud Printing Center. When transferring the ownership of the printer, select **Clear the information saved on the printer**.

- **Add printers**

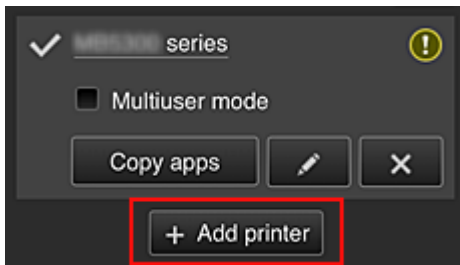

Select this to add printers to be used in the Canon Inkjet Cloud Printing Center. You need a [Printer registration ID](#) to add a printer.

▶▶▶ Note

- Up to 16 printers are guaranteed to operate for each e-mail address.

Manage users screen

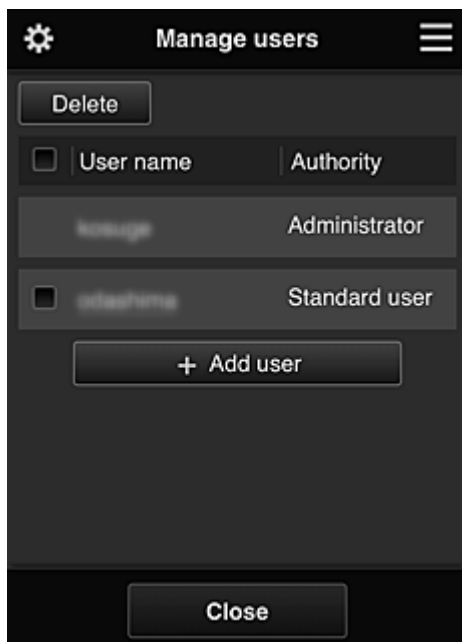

From the **Manage users** screen, you can [check user information](#) registered to the Canon Inkjet Cloud Printing Center, [delete users](#), [add users](#), and [change the Administrator and Standard user settings](#).

- **User deletion**

Select the check box of the user to be deleted, and select **Delete**.

However, you cannot delete yourself. To delete yourself, cancel your membership from the [user information](#) screen.

- **Adding a user**

Select **Add user**. The user registration screen appears.

- **Changing Administrator and Standard user settings**

You can change the privileges of the **Administrator** and **Standard users**.

(2) Printer name area

The registered name of the printer selected is displayed.

The **Administrator** can [change the printer name](#).

(3) Right context menu

When you select , the context menu appears.

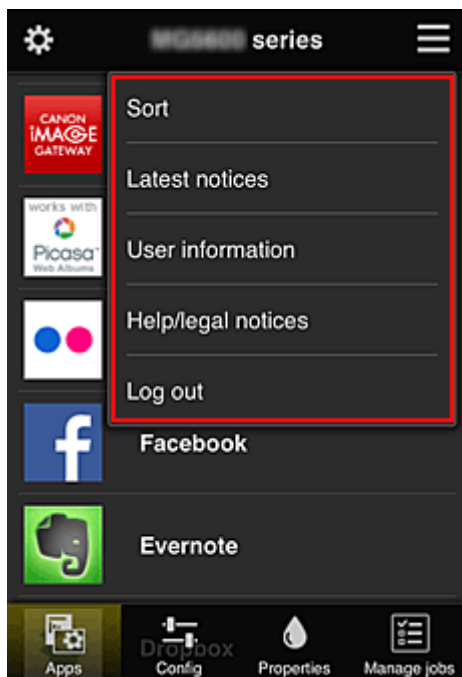

The information displayed depends on the menu currently selected in the menu area.

The  symbol indicates that there is a new unread notice.



- **Sort** **Sort**

This displays the screen to sort registered apps.

You can use the   buttons to change the display order of apps. When you finish sorting, press the **Done** button to confirm the order.

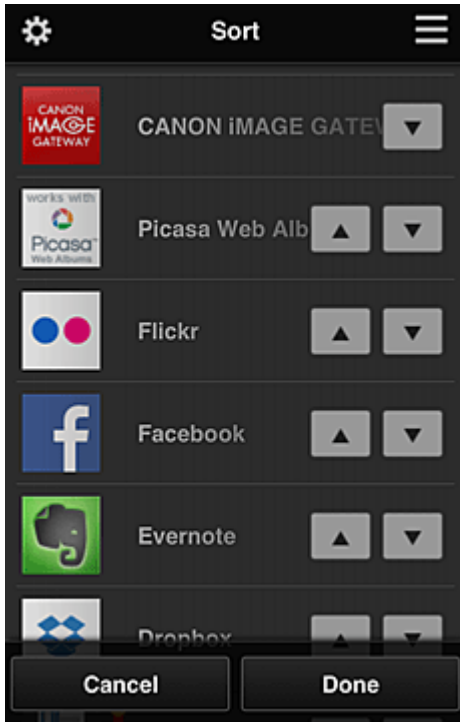

- **Latest notices** Latest notices*

This displays the latest notices. The  symbol indicates that there is a new unread notice.

- **User information** User information*

This displays the User information screen.

You can change the registered e-mail address, password, language, time zone, and other settings.

- **Help/legal notices** Help/legal notices*

The description of the Canon Inkjet Cloud Printing Center screen and various reminders are displayed.

- **Log out** Log out*

This opens the Log out screen of the Canon Inkjet Cloud Printing Center.

(4) Display area

The display changes based on the menu you select.

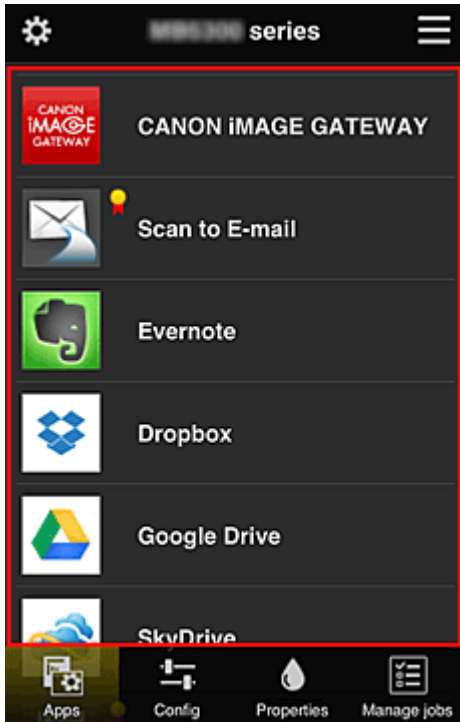

(5) Menu area

The following 4 menu buttons are displayed:

-  **Apps***

This displays the list of registered apps in the [Display area](#).

-  **Config**

This displays the Register apps screen in the [Display area](#).

The display can be toggled between **Registered** and **Search apps**.

The **Registered** screen lists registered apps.

You can check the information of these apps or deregister them.

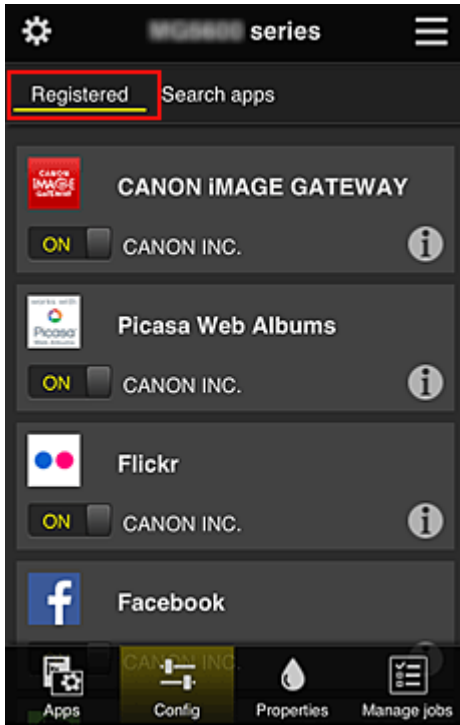

On the **Search apps** screen, the apps that you can register by using the Canon Inkjet Cloud Printing Center are displayed by category.

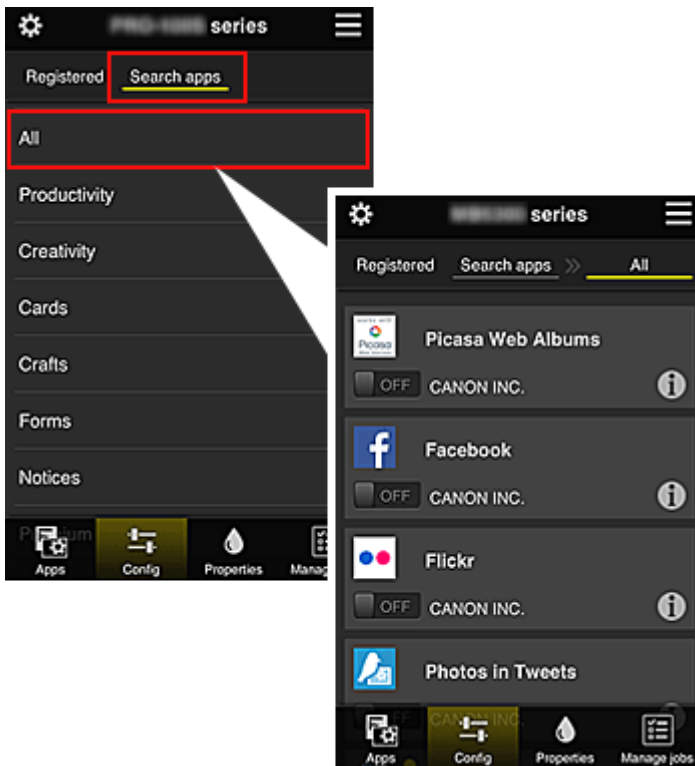

- When you select , the details of the app are displayed.
- When you select , you can choose to register or unregister the app.

▶▶▶ Note

- Description of displayed icons

: Cannot be used because it is not yet released, not available in your region, or does not support your model.

: Can be used with genuine Canon ink.

- 
Properties*

This screen displays the status of the printer that is currently selected.

You can check how much ink is remaining or details about an error that occurred. You can also access the ink purchasing site and the *Online Manual*.

»»» Important

- The Properties displayed may differ from the actual status at the display time, depending on the printer status.

- 
Manage jobs*

This screen displays the print status and the print history.

You can check the print status by looking at **Status list**, and the print history by looking at **History**.

You can also cancel print jobs and delete history information.

To cancel or delete a job, select that job and then select **Cancel** or **Delete**.

If you are using a PC

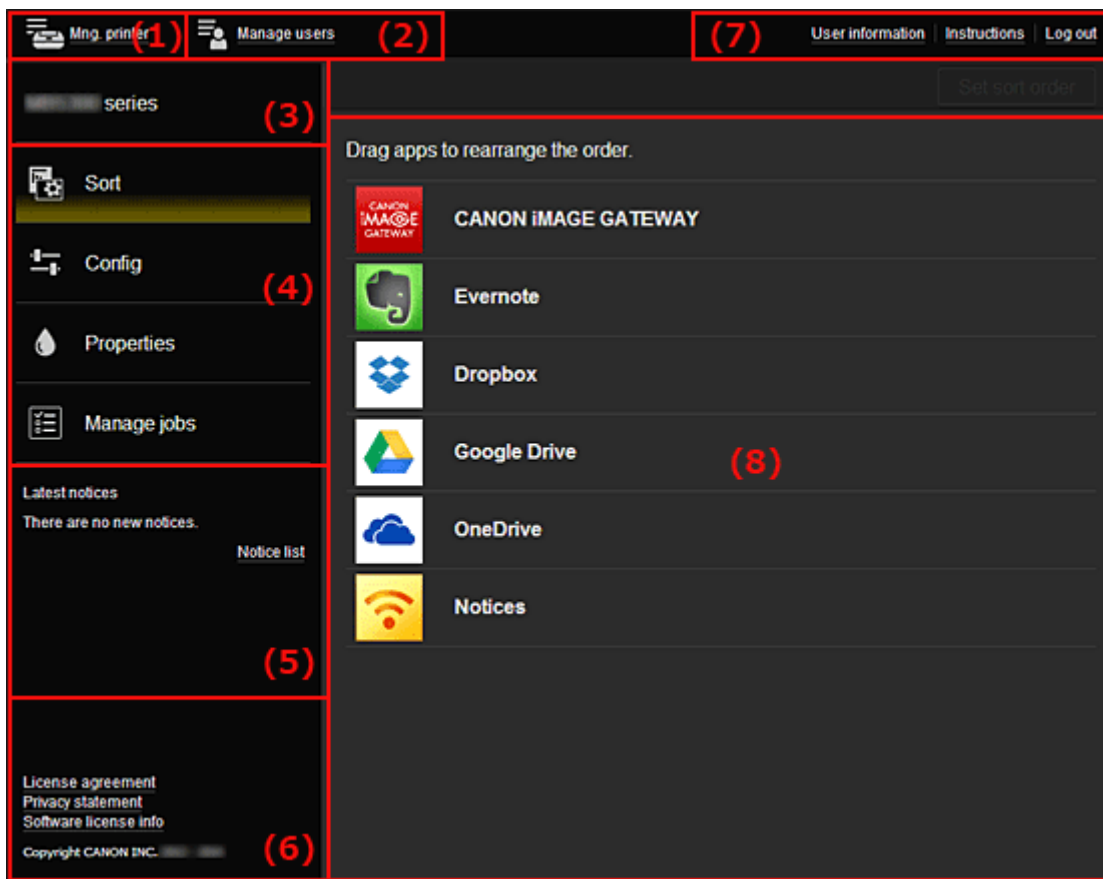

- (1) [Mng. printer \(Select printer\) button](#)
- (2) [Manage users button](#)
- (3) [Printer name area](#)
- (4) [Menu area](#)
- (5) [Notices area](#)
- (6) [Information area](#)
- (7) [Global navigation area](#)

(8) [Display area](#)

(1) Mng. printer (Select printer) button

When you select the **Mng. printer (Select printer)** button, the **Mng. printer (Select printer)** screen appears.

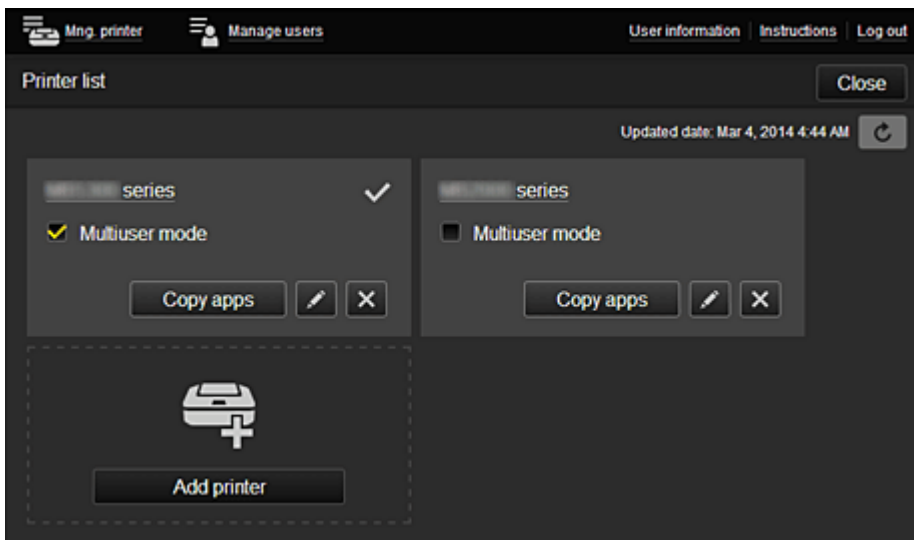

From the **Mng. printer** screen (**Select printer** screen), you can [check*](#) and [update*](#) printer information registered to the Canon Inkjet Cloud Printing Center, [change printer names](#), [delete printers](#), [add printers](#), and [copy apps](#).

• **Check the printer information***

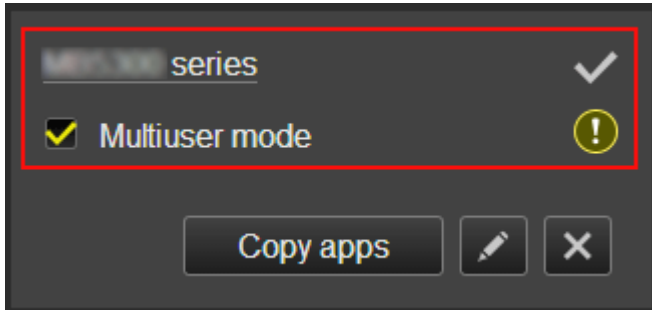

The registered printer name is displayed.

indicates the currently selected printer.

 indicates that an error occurred on the printer.

• **Display update date/time of the printer information***

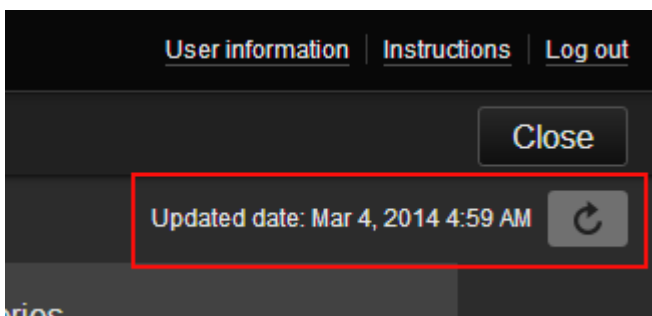

This displays the date and time the printer information was last updated.

 refreshes the information.

- **Multuser mode**

If multiple users are using the printer, select the [Multuser mode](#) check box.

- **Change the printer name**

When you select , a screen to change the printer name appears. Follow the instructions on the screen to change the name.

▶▶▶ **Note**

- The printer name entry has the following character limitation:
 - Up to 128 characters

- **Delete printers**

When you select , the printer is deleted from the Canon Inkjet Cloud Printing Center. When transferring the ownership of the printer, select **Clear the information saved on the printer**.

- **Add printers**

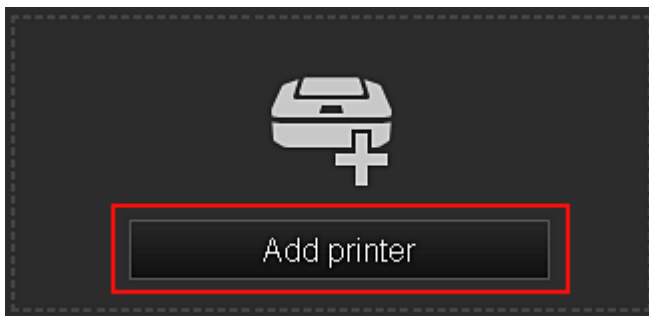

Select this to add printers to be used in the Canon Inkjet Cloud Printing Center. You need a [Printer registration ID](#) to add a printer.

▶▶▶ **Note**

- Up to 16 printers are guaranteed to operate for each e-mail address.

- **Copy apps**

Select this to copy apps added in the selected printer to another printer.

When you select , the screen shown below appears.

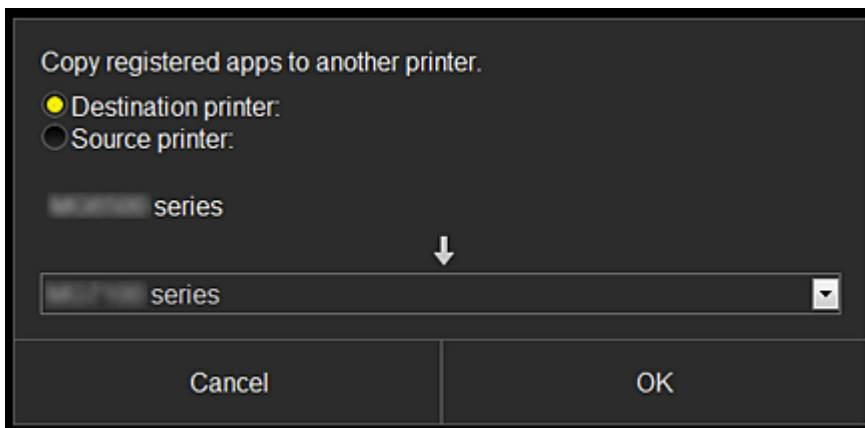

Set the **Destination printer** and the **Source printer**. Then select **OK**.

(2) Manage users button

When you select the **Manage users** button, the Manage users screen appears.

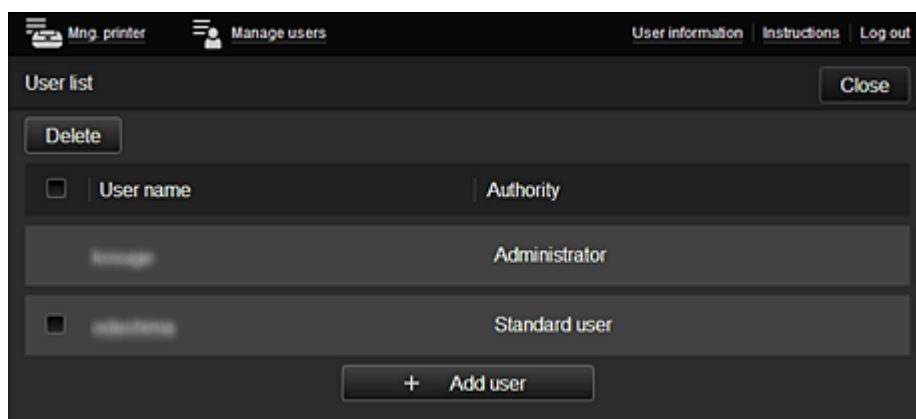

From the **Manage users** screen, you can [check user information](#) registered to the Canon Inkjet Cloud Printing Center, [delete users](#), [add users](#), and [change the Administrator and Standard user settings](#).

- **User deletion**

Select the check box of the user to be deleted, and select **Delete**.

However, you cannot delete yourself. To delete yourself, cancel your membership from the [user information](#) screen.

- **Adding a user**

Select **Add user**. The user registration screen appears.

- **Changing Administrator and Standard user settings**

You can change the privileges of the **Administrator** and **Standard users**.

(3) Printer name area

The registered name of the printer selected is displayed.

The **Administrator** can use the **Mng. printer** functions to [change the printer name](#).

(4) Menu area

The following 4 menu buttons are displayed:

-  **Sort (Apps)**

This displays the list of registered apps in the [Display area](#).

Drag the app to change the order.

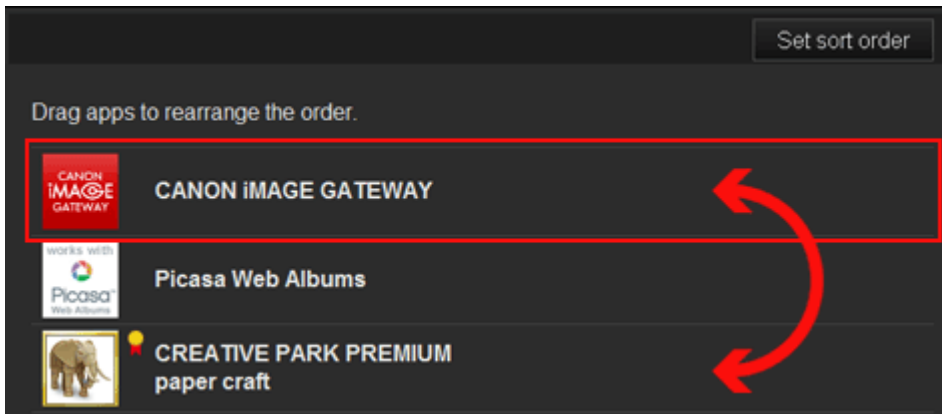

When you finish sorting, press the **Set sort order** button and confirm the order.

- 
Config

This displays the Register apps screen in the [Display area](#).

The display can be toggled between **Registered** and **Search apps**.

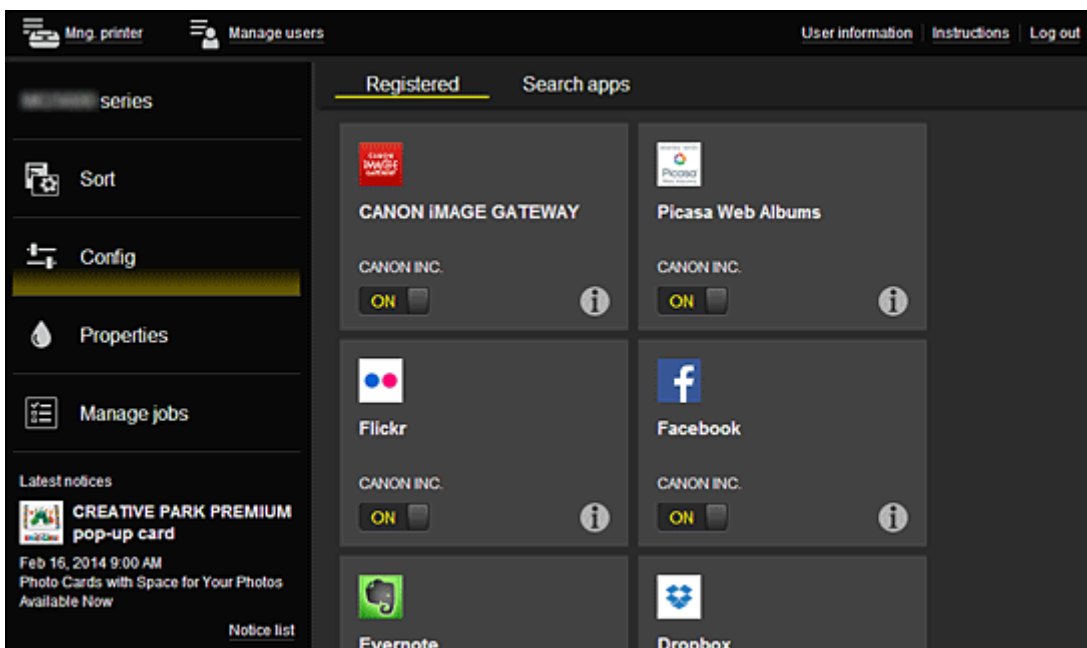

The **Registered** screen lists registered apps.

You can check the information of these apps or deregister them.

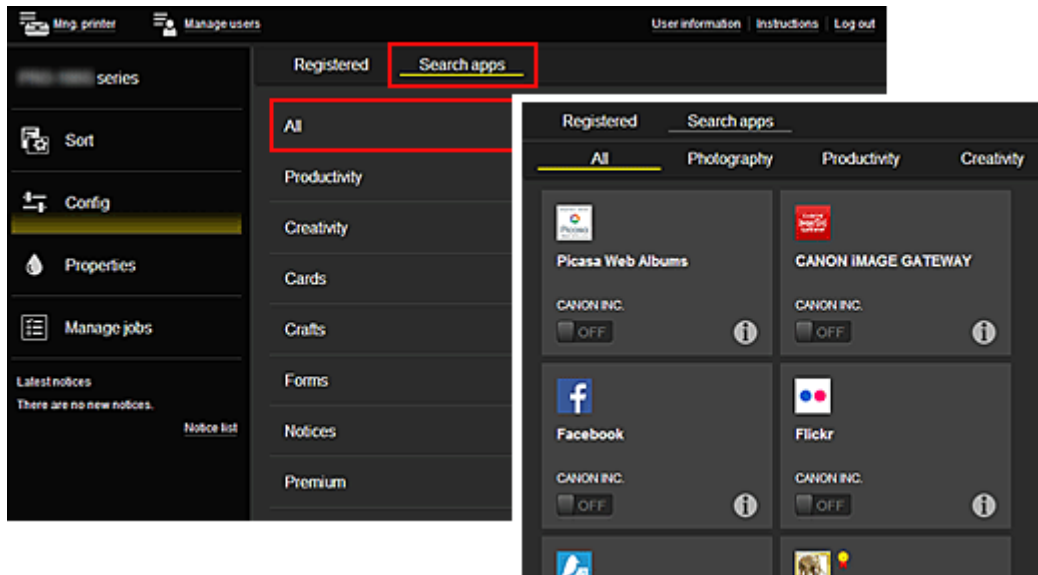

On the **Search apps** screen, the apps that you can register by using the Canon Inkjet Cloud Printing Center are displayed by category.



- When you select , the details of the app are displayed.
- When you select , you can choose to register or unregister the app.

»»» Note

- Description of displayed icons

 : Cannot be used because it is not yet released, not available in your region, or does not support your model.

 : Can be used with genuine Canon ink.



• Properties*

This screen displays the status of the printer that is currently selected. You can check how much ink is remaining or details about an error that occurred. You can also access the ink purchasing site and the *Online Manual*.

»»» Important

- The Properties displayed may differ from the actual status at the display time, depending on the printer status.

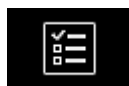

• Manage jobs*

This screen displays the print status and the print history. You can check the print status by looking at **Status list**, and the print history by looking at **History**. You can also cancel print jobs and delete history information. To cancel or delete a job, select that job and then select **Cancel** or **Delete**.

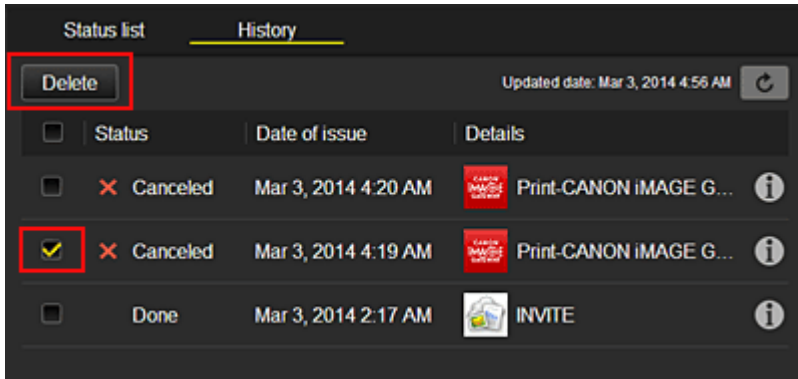

(5) Notices area

This displays the latest notice. Nothing is displayed in this area if there is no notice. When you select **Notice list**, you can display up to 40 items.

(6) Information area

This display other information, including the privacy statement and other companies' licensing information.

(7) Global navigation area

The **User information***, **Instructions***, and **Log out*** buttons are displayed. Press the **User information** to change the settings.

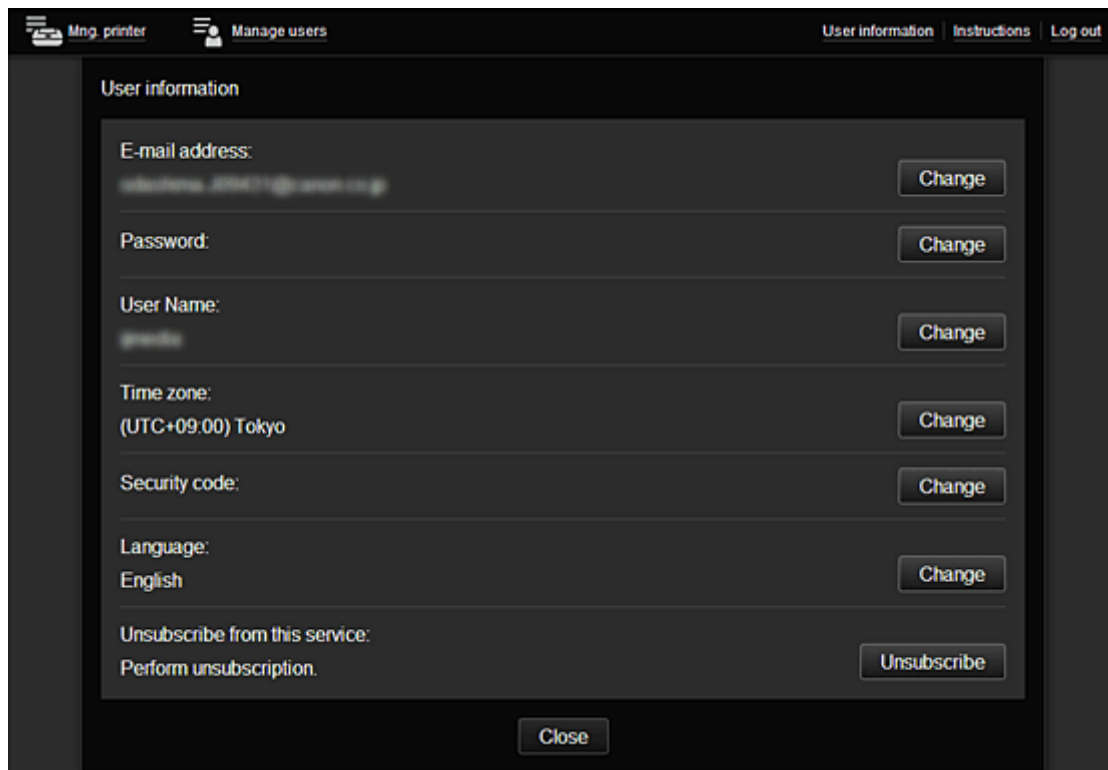

(8) Display area

The display changes based on the menu you select.

Mng. printer Manage users User information Instructions Log out

series

Sort

Config

Properties

Manage jobs

Latest notices
There are no new notices.
Notice list

License agreement
Privacy statement
Software license info
Copyright CANON INC.

Set sort order

Drag apps to rearrange the order.

- CANON IMAGE GATEWAY
- Evernote
- Dropbox
- Google Drive
- OneDrive
- Notices

Using Canon Inkjet Cloud Printing Center

When the user registration is completed, you can log in to the Canon Inkjet Cloud Printing Center and use the service.

1. From your PC, smartphone, or tablet, access the service login URL (<http://cs.c-ij.com/>)
2. On the Login screen, enter the **E-mail address** and **Password**, and then select **Log in**

▶▶▶ Important

- The e-mail address and password are case-sensitive. Make sure the case is correct.

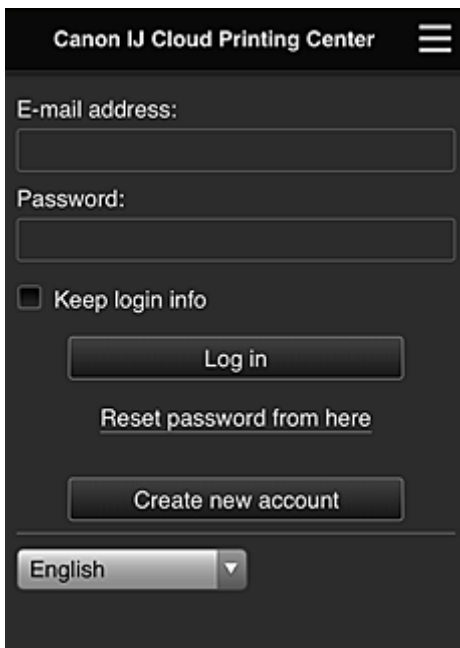

E-mail address

Enter the e-mail address that you entered in the user registration.

Password

Enter the password that you entered in the user registration.

Keep login info

When you select the check box, the login screen is skipped for 14 days since the last day that the service screen was accessed.

▶▶▶ Important

- If you fail to log in five straight times, you will not be able to login again for an hour.
- You remain logged in for an hour after the last access.
- The service may not function properly if you log in from multiple devices at the same time.

After logging in, you can use useful services such as adding/managing apps that work in conjunction with this product's cloud functionality and checking the ink status.

For screen descriptions and operation instructions, see "[Canon Inkjet Cloud Printing Center window](#)".

Printing procedure

This section introduces the photo printing procedure by using CANON iIMAGE GATEWAY as an example.

▶▶▶ Important

- The available functions differ depending on the app.
- The printing procedure differs depending on the app.
- You need to get the account and register photo and other data beforehand.
- The following file formats can be printed: jpg, jpeg, pdf, docx, doc, xlsx, xls, pptx, ppt, and rtf.
The file formats that can be printed differ depending on the app.
- Before you print, check that printer is on and is connected to the network. Then start.
- This is available if you are using a smartphone or tablet.

▶▶▶ Note

- You can use CANON IMAGE GATEWAY to print jpg and jpeg file formats.

1. On the Main screen, select the app to be used
2. Enter the information according to the instructions on the authentication screen, and then select **Log in**

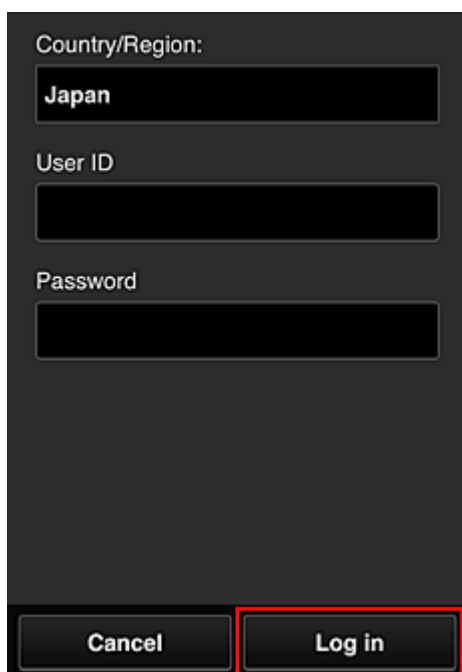

The screenshot shows a dark-themed authentication screen. At the top, it says "Country/Region:" followed by a dropdown menu showing "Japan". Below that is a "User ID" field, and then a "Password" field. At the bottom, there are two buttons: "Cancel" on the left and "Log in" on the right. The "Log in" button is highlighted with a red rectangular border.

3. In the displayed album list, select the album of your choice

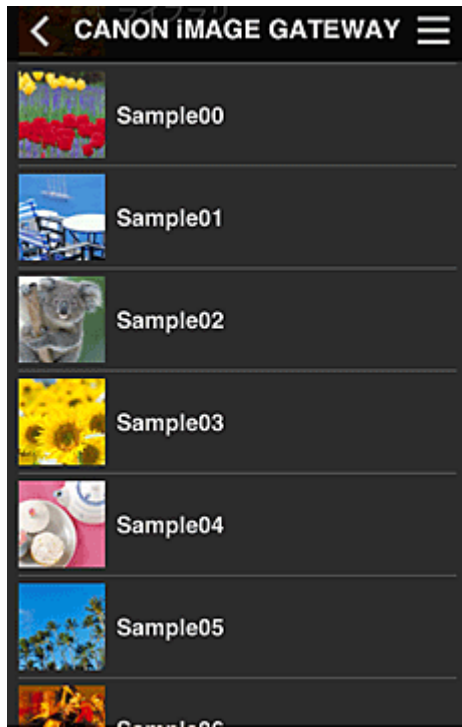

4. In the displayed image list, select the image that you want to print, and then select **Next**



5. Make the necessary print settings, and then select **Print**

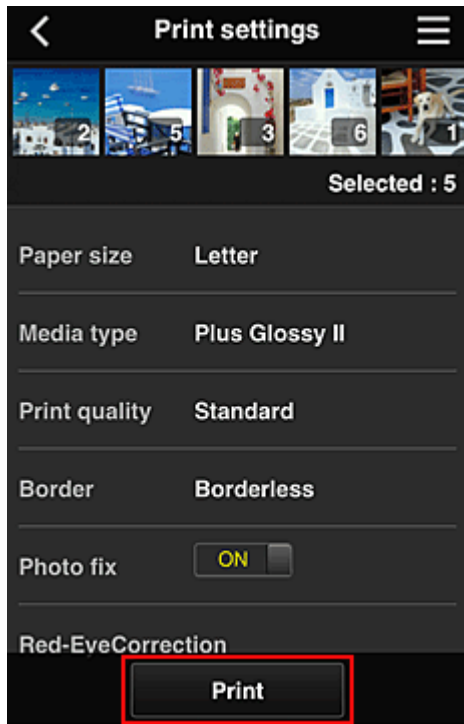

6. A print job completion message appears, and printing starts

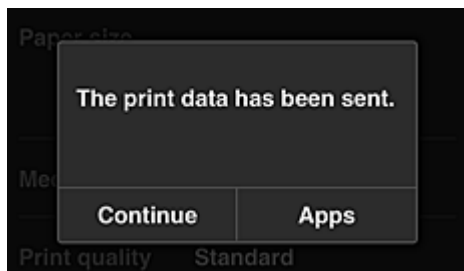

To continue printing, select **Continue**, and perform the operation from Step 3.

To end the printing, select **Apps**. The screen returns to the apps list screen.

»» Important

- If a print job is not printed within 24 hours after the print job is issued, the print job will expire and cannot be printed.
- With premium apps that limit the number of print jobs, print jobs that expire and cannot be printed are also included in the print count.

■ [Adding a Printer](#)

Adding a Printer

With one account, you can use the Canon Inkjet Cloud Printing Center services on multiple printers.

The procedure for adding a printer is as follows:

1. Print the [registration information](#) from the printer to be added
2. From the browser on your smartphone, tablet, or computer, access the authentication site URL

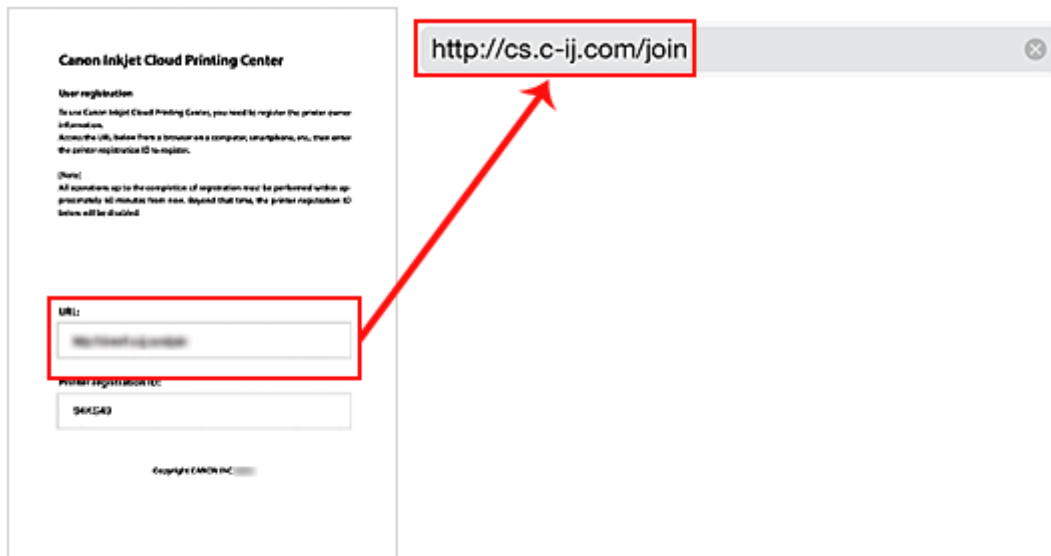

3. Select **Add printer**

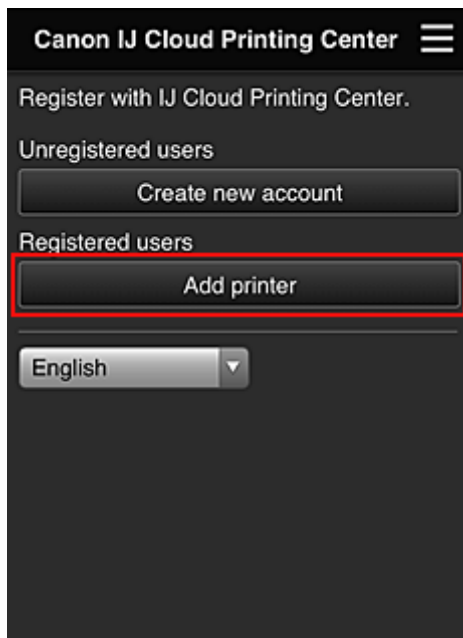

4. When the confirmation message is displayed, select **OK**
5. Enter your **Printer registration ID**, and select **OK**

Add printer

Add a printer. Enter the printer registration ID.

Printer registration ID:

[About printer registration ID](#)

Cancel OK

▶▶▶ **Note**

- When you access the service from **Remote UI**, the **Printer registration ID** is entered automatically.

Printer addition is completed.

■ [Adding a MAXIFY Cloud Link User](#)

Adding a MAXIFY Cloud Link User

Several people can use one printer.

This section describes the user addition procedure and the user privileges.

Adding a user

1. On the service screen, select **Manage users**

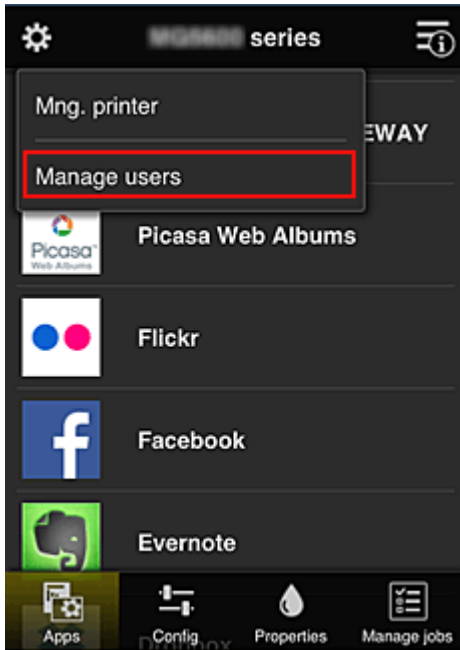

2. Select **Add user**

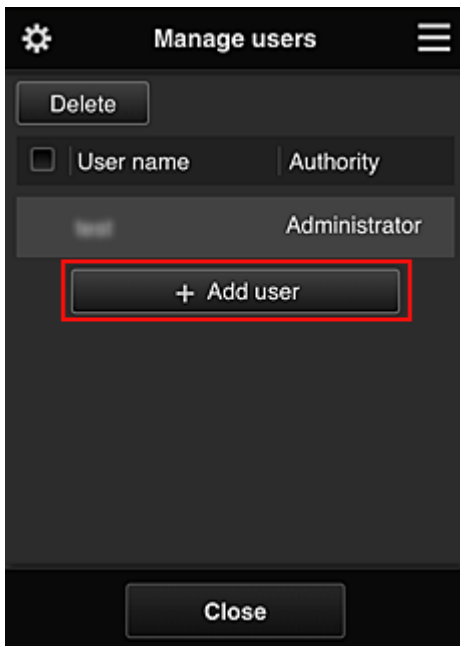

▶▶▶ Note

- When you select **Add user**, the service first checks whether the maximum number of users has been reached. If new users can be added, the user registration screen appears.
- The maximum number of users that can be added for 1 printer is 20.

3. Enter the e-mail address of the user to be added, and then select **OK**

The URL for completing the registration is then sent to the entered e-mail address.

4. Access the URL reported in the e-mail

5. Read the terms displayed in the **License agreement** and **Privacy statement** screens. If you agree to the terms, select **Agree**.

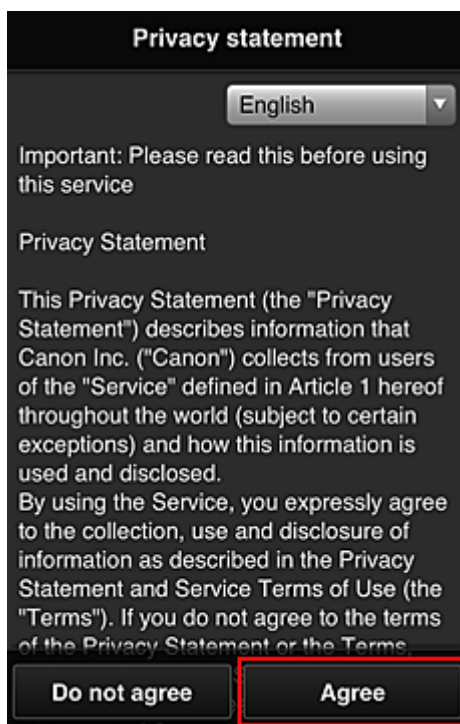
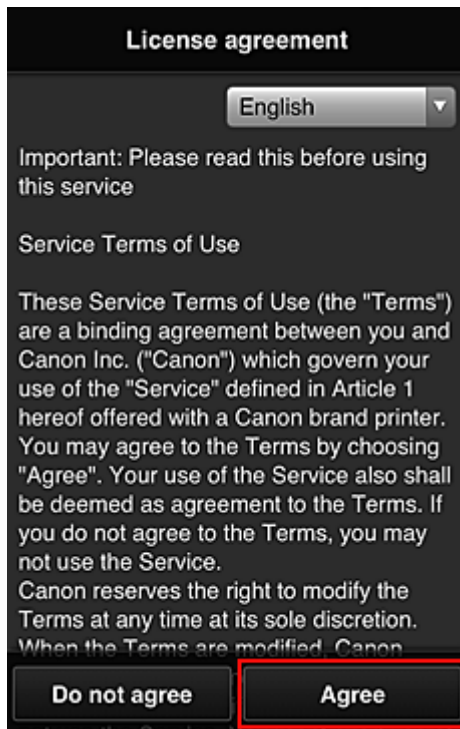

6. In the user information entry screen, enter your **Password**, and select **Next**

Enter your password for logging in to the Canon Inkjet Cloud Printing Center.

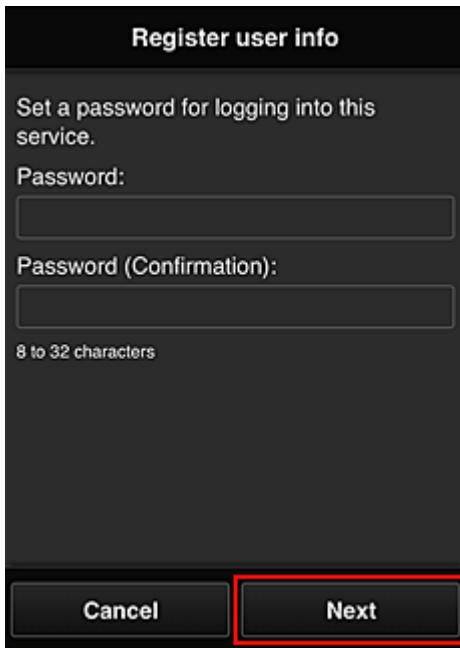

The screenshot shows a dark-themed interface titled "Register user info". Below the title, it says "Set a password for logging into this service." There are two text input fields: "Password:" and "Password (Confirmation):". Below the second field, it says "8 to 32 characters". At the bottom, there are two buttons: "Cancel" and "Next". The "Next" button is highlighted with a red border.

»» Important

- There are character restrictions for the password, as shown below.
- The password needs to be between 8 and 32 characters long, using single-byte alphanumeric characters and symbols (!"#\$%&'()*+,-./:;<=>@[]^_`{|}~). (Alphabets are case-sensitive)

7. Enter the **User Name**

Enter the name that identifies the user.

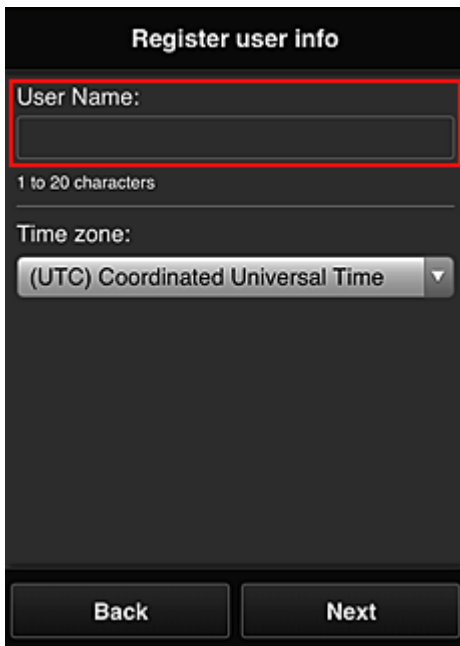

The screenshot shows the same "Register user info" screen. The "User Name:" field is now the focus, with a red border around it. Below it, it says "1 to 20 characters". Below that is a "Time zone:" dropdown menu with "(UTC) Coordinated Universal Time" selected. At the bottom, there are two buttons: "Back" and "Next".

»» Important

- The **User Name** entry field has the following character restrictions:

- The user name needs to be between 1 and 20 characters long, using single-byte alphanumeric characters and symbols (!"#\$\$%&'()*+,-./:;<=>?@[\\]^_`{|}~). (Alphabets are case-sensitive)

8. Set **Time zone** and select **Next**

Select your region on the list. If you cannot find your region on the list, select the one closest to your region.

Apply daylight saving time

This appears only when there is a daylight saving time in the time zone that you selected.

Select whether or not to apply the daylight saving time.



The screenshot shows a mobile application interface titled "Register user info". It features a "User Name:" label above a text input field, with a note "1 to 20 characters" below it. Below the input field is a "Time zone:" label above a dropdown menu. The dropdown menu is open, showing the selected option "(UTC) Coordinated Universal Time" with a downward arrow. At the bottom of the screen, there are two buttons: "Back" and "Next".

9. Enter the **Security code** and select **Done**

Enter the code for authenticating the user.

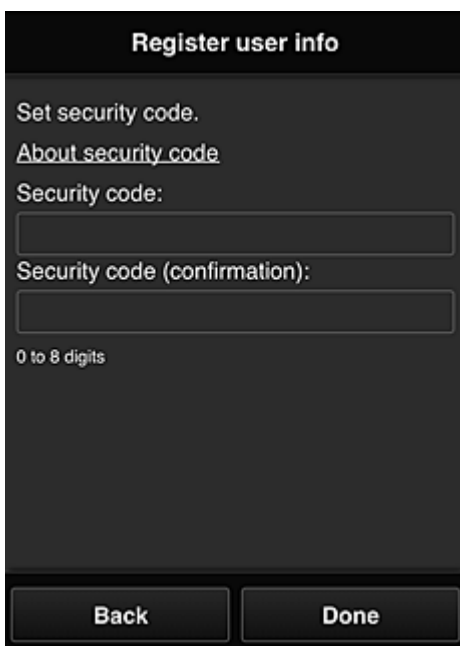

The screenshot shows a mobile application interface titled "Register user info". It features a "Set security code." label, followed by a link "[About security code](#)". Below this is a "Security code:" label above a text input field. Below that is a "Security code (confirmation):" label above another text input field. At the bottom of the screen, there are two buttons: "Back" and "Done".

»» Important

- The **Security code** entry field has the following character restrictions:
 - Single-byte numbers

The main registration is complete, and a registration completion e-mail is sent.

»» Note

- A cookie for the selected user is added to the printer, and the login status of each user is recovered. Cookies for up to 8 users can be registered to 1 printer.

Printer user privileges

If several users are using the cloud service for 1 printer, each user is categorized as the **Administrator** or a **Standard user**.

»» Note

- The user who is registered first becomes the **Administrator**. The administrator can change the privileges of users from the [Manage users screen](#).

An **Administrator** can change printer information, add and delete apps, manage users, and perform various other operations.

A **Standard user** can check printer information and start apps.

For information about the functions that each user can use, refer to the "[Canon Inkjet Cloud Printing Center window](#)".

If you are using MAXIFY Cloud Link from the printer, select **Multiuser mode** in the [Mng. printer screen](#) to set the printer to **Multiuser mode**. Each user can then start an app and print documents.

■ [Troubleshooting Canon Inkjet Cloud Printing Center](#)

Troubleshooting Canon Inkjet Cloud Printing Center

- [If an app cannot be installed](#)
- [If the registered app is not in the Apps list](#)
- [If the information is not updated when you press the **Update** button](#)
- [If you do not receive the registration e-mail](#)
- [If you cannot print](#)
- [Printing starts on its own even if you do not do anything](#)
- [If you are unable to log in correctly even after entering the correct password in iOS or Mac](#)

If an app cannot be installed

Check the country or region where the printer was purchased.

If the printer is taken outside the country or region where it was purchased, apps cannot be installed.

If the registered app is not in the Apps list

Check the display language of Canon Inkjet Cloud Printing Center.

If the display language is switched to a language that does not support an app, the app will not be displayed in the apps list but will continue to be registered.

If you switch back to the target language of the app, it will be displayed in the apps list and you will be able to start, register, or unregister the app.

If the information is not updated when you press the Update button

Because the Properties screen requires network connection with this product, the information may not be reflected immediately. Please wait awhile, and then try updating the information again.

If the information is still not updated, then check that the product is connected to the Internet.

If you do not receive the registration e-mail

You may have entered a different e-mail address during the user registration of Canon Inkjet Cloud Printing Center.



On the printer's Home screen, select **Setup** -> **Web service setup** -> **Web service connection setup** -> **IJ Cloud Printing Center setup** -> **Delete from this service** to delete the service registration.

After resetting the printer, repeat the user registration of Canon Inkjet Cloud Printing Center from the beginning.

If you cannot print

Check the following if you cannot print.

- Check that the printer is connected to the Internet.
- Check that the printer is connected to a LAN and the LAN environment is connected to the Internet.
- Check that no error message is displayed on the printer's LCD monitor.



- If printing does not start even after you wait awhile, go to the printer home screen and run **Setup -> Web service inquiry**. If printing does not start, run the inquiry several times.

If the problem is not resolved, use the printer driver from your computer to perform the print job and check whether the data can be printed normally on the printer.

If you still cannot print, see the troubleshooting page for your model on the Home of the *Online Manual*.

▶▶▶ Note

- With a wireless LAN connection, after the printer is turned on, it may take several minutes before communication is possible. Check that your printer is connected to the wireless network, and wait a while before you start printing.
- If the printer is not turned on or is not connected to the Internet, and consequently a print job is not processed within 24 hours after it was submitted, the print job is automatically canceled. If this happens, check the printer power and the Internet connection, and then re-submit the print job.

Printing starts on its own even if you do not do anything

A third party may be able to illegally use the Canon Inkjet Cloud Printing Center services.



On the printer's Home screen, select **Setup -> Web service setup -> Web service connection setup -> IJ Cloud Printing Center setup -> Delete from this service** to delete the service registration.

After resetting the printer, repeat the user registration of Canon Inkjet Cloud Printing Center from the beginning.

If you are unable to log in correctly even after entering the correct password in iOS or Mac

If you are using iOS or Mac, and the password contains the ¥ symbol, enter a backslash instead. For instructions on entering a backslash, see the OS help.

What is a Security code?

A **Security code** identifies the user when multiple other users are sharing the same printer.

Important

- If you do not set a **Security code**, another user may use your account.
- This code is valid only when you use MAXIFY Cloud Link from the printer operation panel. You cannot use this code when you access the Canon Inkjet Cloud Printing Center from your smartphone, tablet, or computer.

Printing with Google Cloud Print

The printer is compatible with Google Cloud Print™ (Google Cloud Print is a service provided by Google Inc.).

By using Google Cloud Print, you can print from anywhere with applications or services supporting Google Cloud Print.

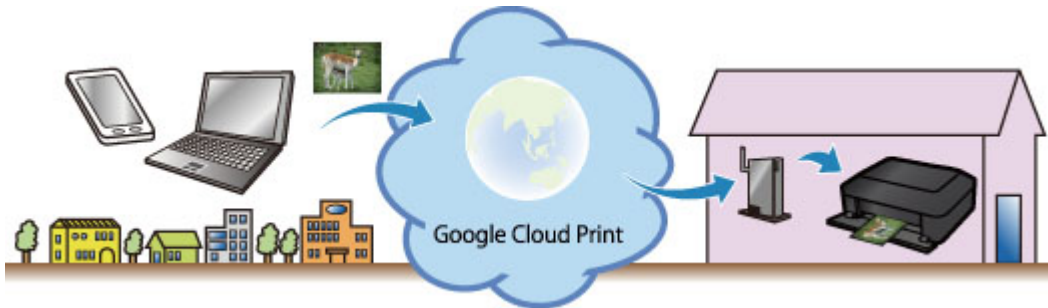

1. [Preparations for Printing with Google Cloud Print](#)
2. [Printing from Computer or Smartphone with Google Cloud Print](#)

►► Important

- LAN connection with the printer and Internet connection are required to register the printer and to print with Google Cloud Print. Internet connection fees apply.
- This function may not be available depending on the country or region you live in.

Preparations for Printing with Google Cloud Print

To print with Google Cloud Print, you need to get Google account and register the printer with Google Cloud Print in advance.

■ [Getting Google Account](#)

If you already have Google account, register the printer.

■ [Registering the Printer with Google Cloud Print](#)

Getting Google Account

First, get your Google account in order to register the printer with Google Cloud Print.

Access to Google Cloud Print with the web browser on the computer or the mobile device, then register the required information.

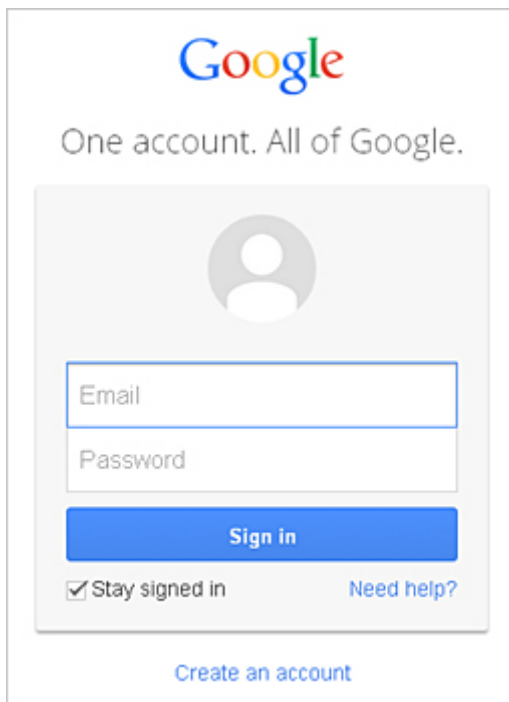

* The screen above may change without prior notice.

Registering the Printer with Google Cloud Print

Register the printer with Google Cloud Print.

If the firmware version is Ver. 2.010 or later, registration is possible from Google Chrome on your computer, smartphone, or tablet device.

■ [Registration Using Google Chrome](#)

For earlier versions, register the information from the printer.

■ [Registration from the Printer](#)

▶▶▶ Important

- For instructions on checking the firmware version and updating the firmware, refer to "[Firmware Update](#)".
- After you update the firmware, you must re-register the printer even if it was already registered.

- When you register a printer, the printer must be connected to the LAN and the LAN environment must be connected to the Internet. Note that the customer is responsible for all Internet connection fees.
- When the printer owner changes, [delete the printer registration from Google Cloud Print](#).

Registration Using Google Chrome

1. Start the Google Chrome browser on your computer, smartphone, or tablet device.

Then from  (Chrome menu), select **Sign in to Chrome...**, and log in to your Google account

2. From  (Chrome menu), select **Settings**

3. Click **Show advanced settings...** to display the information. Then for **Google Cloud Print**, select **Manage**

4. Select **Add printers** for the printer to be added

5. When the confirmation message for registering the printer appears, select **OK**

Printer registration is complete.

Registration from the Printer

The authentication procedure using the web browser on the computer or the mobile device is required in the process of registering. Because the authentication URL is printed from printer when the authentication process is performed, prepare A4 size or Letter size or Legal size plain paper.

1. Make sure that the printer is turned on
2. From the Home screen, select **Setup**
3. Select **Web service setup -> Connection setup -> Google Cloud Print setup -> Register with Google Cloud Print**

Note

- If you have already registered the printer with Google Cloud Print, the confirmation message to re-register the printer is displayed.

4. When the confirmation screen to register the printer is displayed, select **Yes**

5. Select a display language on the print setting screen of Google Cloud Print

The confirmation message to print the authentication URL is displayed.

6. Load A4 size or Letter size or Legal size plain paper, then select **OK**

The authentication URL is printed.

7. Ensure that the authentication URL is printed, select **Yes**
8. Perform the authentication process using the web browser on the computer or the mobile device

Access to the URL using the web browser on the computer or the mobile device and perform the authentication process following the on-screen instructions.

►► Note

- Perform the authentication process with your Google account which you have gotten in advance.

9. When the message that the registration is complete is displayed on the LCD of the printer, select **OK**

When authentication process is complete properly, the registration items are displayed. When authentication process is complete, [you can print the data with Google Cloud Print](#).

When authentication process is not complete properly and the error message is displayed, select **OK**. When the confirmation message to print the authentication URL is displayed, print the authentication URL, then perform the authentication process on the computer again.

Deleting the Printer from Google Cloud Print

To change the printer owner or to re-register the printer, first delete the printer from Google Cloud Print by using the respective procedure.

■ [Deletion from Google Chrome](#)

■ [Deletion from the Printer](#)

Deletion from Google Chrome

1. Start the Google Chrome browser on your computer, smartphone, or tablet device.

Then from  (Chrome menu), select **Sign in to Chrome...**, and log in to your Google account

2. From  (Chrome menu), select **Settings**
3. Click **Show advanced settings...** to display the information. Then for **Google Cloud Print**, select **Manage**
4. Select **Delete** for the printer to be deleted
5. When the confirmation message for deleting the printer appears, select **OK**

Deletion from the Printer

1. Make sure that the printer is turned on
2. From the Home screen, select **Setup**
3. Select **Web service setup** -> **Connection setup** -> **Google Cloud Print setup** -> **Delete from Google Cloud Print**
4. When the confirmation screen to delete the printer is displayed, select **Yes**

Printing from Computer or Smartphone with Google Cloud Print

When you send print data with Google Cloud Print, the printer receives the print data and prints it automatically if the printer is turned on.

When printing from a smartphone, tablet, computer, or other external device by using Google Cloud Print, load paper into the printer in advance.

Sending the Print Data with Google Cloud Print

1. Make sure that the printer is turned on

▶▶▶ Note

- If you want to send the print data from an outside location, turn on the printer in advance.

2. Send print data from your smartphone, tablet, or computer

The figure below is an example of when printing from the web browser corresponding with Google Cloud Print. The screen differs depending on the applications or services supporting Google Cloud Print.

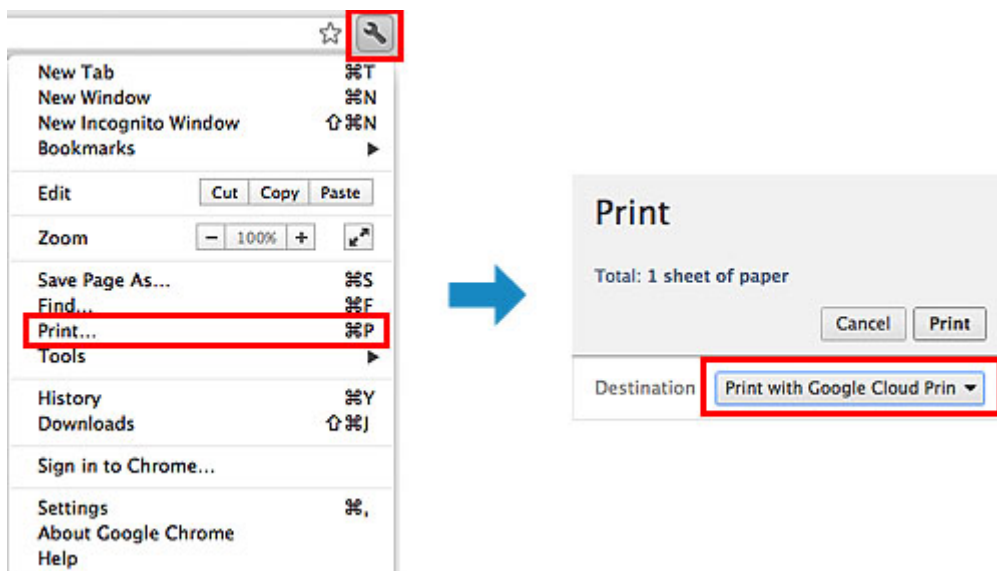

When the preparation for printing with Google Cloud Print is complete and when the printer is turned on, the printer receives the print data and prints it automatically.

▶▶▶ Note

- If the firmware version is Ver. 2.010 or later, you can select which printer to use. For the printing method, you can also select using the local network or using the cloud.
- Depending on the communication status, it may take a while to print the print data or the printer may not receive the print data.
- While printing with Google Cloud Print, the printing may be canceled depending on the printer's status, such as when the printer is being operated or an error has occurred. To resume printing, check the printer's status, then print with Google Cloud Print again.
- For print settings:
 - If you select the media type other than plain paper or if you select the paper size other than A4/ Letter/B5/A5-size, the print data is printed in single-sided even when you select the duplex print setting. (* The paper size differs depending on the model of your printer. For information about

the supported paper sizes, go to the *Online Manual* home page, and refer to the "Cannot Print Properly with Automatic Duplex Printing" for your model.)

- If you select plain paper as media type or if you select B5/A5/Legal-size as paper size, the print data is printed with border even when you select the borderless print setting.
- The print results may differ from the print image depending on the print data.
- Depending on the device sending the print data, you may not select the print settings when sending the print data with Google Cloud Print.

When you want to print from Google Cloud Print immediately

When the printer cannot receive the print data, or you want to start printing immediately, you can check whether there is a print job on the Google Cloud Print and start printing manually.

Follow the steps below.

▶▶▶ Important

- Depending on your printer model, this function may not be available.

1. Make sure that the printer is turned on
2. From the Home screen, select **Setup**
3. Select **Web service inquiry**

▶▶▶ Note

- If you have not registered the printer with Google Cloud Print, **Web service inquiry** is not displayed.

[Register the printer with Google Cloud Print.](#)

4. Select **Print from Google Cloud Print**

The confirmation screen to check is displayed.

5. Select **Yes**

If there is the print data, the printer receives the print data and prints it.

Printing from AirPrint Compliant Device

This document explains how to use AirPrint to print wirelessly from your iPad, iPhone and iPod touch to a Canon printer.

AirPrint enables you to print photos, email, Web pages and documents from your Apple device directly to your printer without installing a driver.



Checking Your Environment

First, check your environment.

- **AirPrint Operation Environment**

To use AirPrint, you will need one of the following Apple devices running the latest version of iOS:

- iPad (all models)
- iPhone (3GS or later)
- iPod touch (3rd generation or later)

- **Network Environment**

The Apple device (iPad, iPhone, or iPod touch) and this printer must be connected to the same Wi-Fi network or connected in AP mode.

▶▶▶ Note

- If your iPad, iPhone or iPod touch is running the latest version of iOS, you do not need to download and install any drivers or additional software.

Printing with AirPrint

1. Check that this printer is turned on and the Apple device and this printer is connected to the LAN or connected in AP mode.
2. From the app of your Apple device, tap the operation icon to display the menu options.

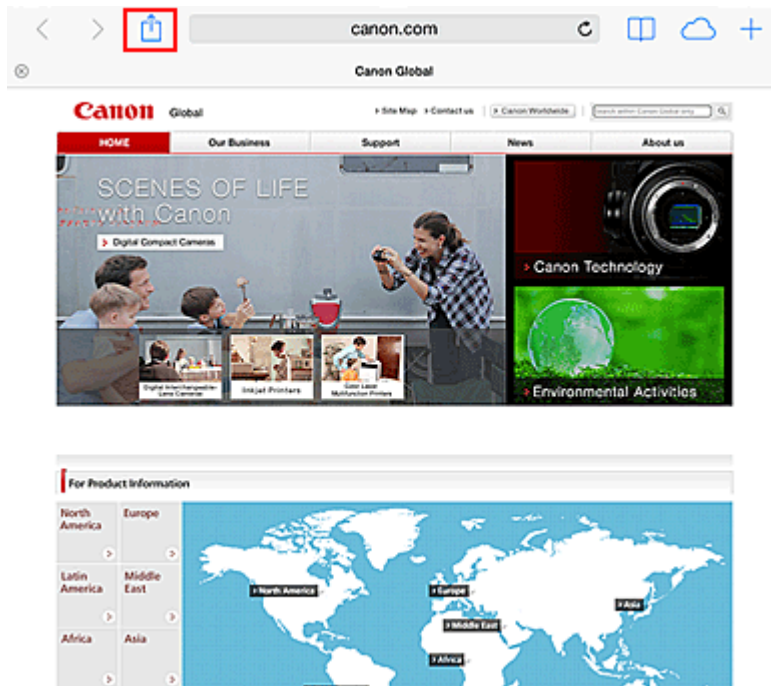

3. From the menu options, tap **Print**.

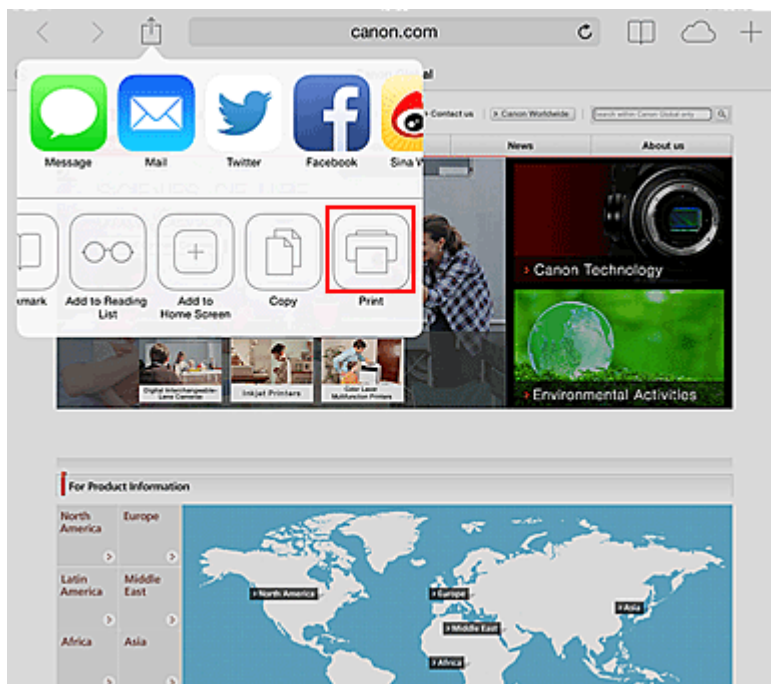

4. From **Printer Options**, select the model that you are using.

»»» Important

- Because some app does not support AirPrint, **Printer Options** may not be displayed. If an app does not let you use printer options, you cannot print from that app.

»»» Note

- The **Printer Options** differ depending on the app and model you are using.

5. When printing a file type that has multiple pages, such as a PDF file, click **Range** and then click **All Pages** or select the range of pages to be printed.
6. For **1 Copy**, click **+** or **-** to set the number of required copies.
7. For **Duplex Printing**, click **On** to enable duplex printing or click **Off** to disable the function.
8. Tap the **Print**.

When you execute printing, the printer prints according to the specified settings.

Paper Size

With AirPrint, the paper size is selected automatically according to the app being used on the Apple device and the region in which AirPrint is used.

When Apple's photo app is used, the default paper size is L size in Japan, and 4"x6" or KG in other countries and regions.

When documents are printed from Apple's Safari app, the default paper size is letter size in the U.S. region, and A4 in Japan and Europe.

►► Important

- Your app may support different paper sizes.

Checking the Print Status

During printing, a **Print Center** icon is displayed in the list of recently used apps, and you can use it to check the print progress.

Press the Home button on the Apple device twice to set the **Multitasking** mode. Then swipe to the right to display the **Print Center** icon and a **Print Summary**.

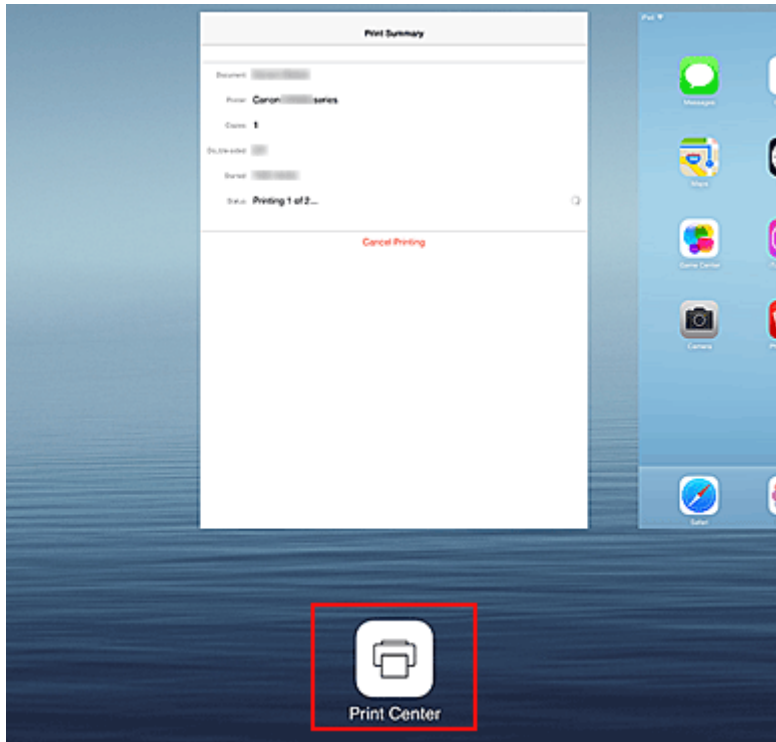

Deleting a Print Job

To delete a print job with AirPrint, use one of the following two methods:

- From the printer: If your printer has a LCD monitor, use the operation panel to cancel the print job. If your printer does not have a LCD monitor, press the **Stop** button on the printer to cancel the print job.
- From an Apple device: Press the Home button on the Apple device twice to set the **Multitasking** mode, and then swipe to the right. Tap the **Print Center** icon to display a **Print Summary**. Tap the print job to be canceled, and then tap **Cancel Printing**.

AirPrint Troubleshooting

If the document does not print, check the following:

1. Check that the printer power is on. If the printer power is on, turn it off and then back on again, and check whether the issue is resolved.
2. Check that the printer is connected by LAN to the same network subnet as the device on which iOS is installed.
3. Check that the printer has enough paper and ink.
4. If your printer has a LCD monitor, check that no error message is displayed on the LCD monitor.

If the problem persists, use the printer driver on your computer to execute printing and check whether the document can be printed normally on the printer.

If the document cannot be printed, refer to the *Online Manual* for your model.

»» Note

- After you turn on the printer, it may take few minutes before the printer can communicate through a wireless LAN connection. Confirm that the printer is connected to the wireless LAN, and then try printing.
- If Bonjour on the printer is disabled, AirPrint cannot be used. Check the LAN settings on the printer, and enable Bonjour.

»» Note

- The windows used in the explanations may differ from those displayed by your Apple product or app.

Checking Printer Information



You can use your smartphone, tablet, or computer to check the **Printer status** and execute utility functions from apps such as Canon Inkjet Print Utility and MAXIFY Printing Solutions.

You can also use the convenient web services presented by Canon.

1. Selecting Printer Information in an Apps Screen

▶▶▶ Note

- You can also enter IPv4 address directly in the web browser to display printer information.

1. From the home window, select  **Setup** ->  **Device settings** -> **LAN settings** -> **Confirm LAN settings** -> **WLAN setting list** or **LAN setting list**. Then from the displayed window, check the IP address.

2. From your computer, smartphone, or tablet device, open the Web browser, and enter the following URL:

http:// <Printer IP address>

For <Printer IP address>, enter the IP address that you checked in the previous procedure.

2. Entering **Username** and Administrator's Password

From the authentication screen, enter the **Username** and **Password**.

Username: ADMIN

Password: See "[About the Administrator Password.](#)"

▶▶▶ Note

- The **Username** display may differ depending on your browser.

3. Displaying Printer Information

The top screen for printer information is displayed.

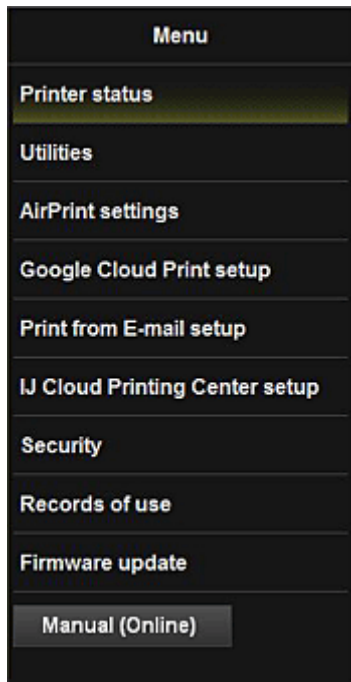

Printer status

This function displays printer information such as the remaining ink amount, the status, and detailed error information.

You can also connect to the ink purchase site or support page, and use Web Services.

Utilities

This function allows you to set and execute the printer utility functions such as cleaning.

AirPrint settings

This function allows you to specify the Apple AirPrint settings, such as position information.

Google Cloud Print setup

This function allows you to register this printer to Google Cloud Print or delete the printer.

Print from E-mail setup

Allows you to register printers, check print addresses, and delete registered printers.

IJ Cloud Printing Center setup

Allows you to register to IJ Cloud Printing Center or to delete a registration.

Security

Allows you to set the **Administrator's** password and **Operation restrictions** for the machine.

»» Important

- For the initial **Password**, see "[About the Administrator Password.](#)"
For Security reasons, we recommend that you change the **Password** to an individual password.
- The following character restrictions apply to the password that you enter:
 - Set the password by using 0 to 32 characters.
 - The allowed characters are single-byte alphanumeric characters.

Records of use

Displays a record of your printer usage, such as the number of copies you printed.

Firmware update

This function allows you to update the firmware and check version information.

Manual (Online)

This function displays the *Online Manual*.

Online Storage Integration Function

The printer can integrate with online storage services such as Evernote.



Integration with Online Notetaking Service "Evernote"

If an Evernote client application is installed on your computer, you can import scanned images into the application and upload them to the Evernote server.

The uploaded images can be browsed from other computers, smartphones, etc.

To use Evernote, you need to create an account. See the "CREATE ACCOUNT" page of Evernote for account creation.

- **Settings**

In the Settings Dialog of IJ Scan Utility, select the item you want to set, then select Evernote for **Send to an application** in **Application Settings**.

Refer to "Settings Dialog" for your model from Home of the *Online Manual* for details.

»» Important

- The Evernote service features are subject to change or termination without prior notice.

How to Use Print from E-mail

By using **Print from E-mail**, you can easily print a photo or document saved on your smartphone, tablet, or computer just by attaching it to an e-mail.

You can print simply from outside like a travel destination. Also, your family or friends can print by registering beforehand.

You can use **Print from E-mail** on any Canon printer that supports the service.

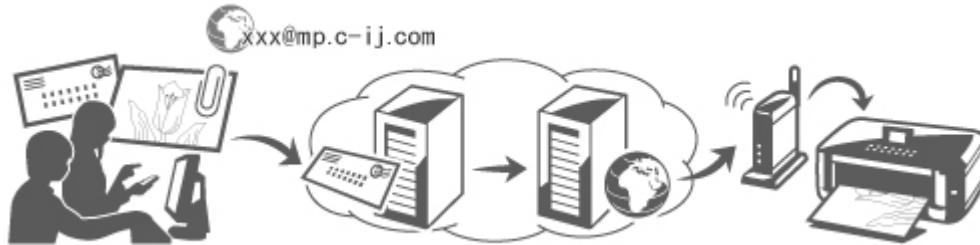

Checking Your Environment

First, check your environment.

- **Network environment**

This product needs to be connected to a LAN with an Internet connection.

►► Important

- The user will bear the cost of Internet access.
- This function may not be available in some countries/regions.
- Depending on your printer model, this function may not be available.

Preparing to use Print from E-mail

To use **Print from E-mail**, you need to register the printer by entering information about the printer's owner.



1. Print the printer registration page's URL and the PIN code
2. Access the URL and enter the owner's e-mail address and other required information
3. Check if an e-mail has been sent to the e-mail address you entered

4. Access the URL provided in the e-mail and complete the printer registration process

▶▶▶ Note

- The e-mail address that appears on the screen when you have finished registering is the e-mail address that will be used just for the **Print from E-mail** function.

■ [For details about the registration procedure, see here](#)

Printing from Your Smartphone, Tablet, or Computer

1. Prepare a file that you want to print

The file format, number of files, and file size that this printing function supports are provided below.

Supported File Formats

- Adobe PDF files
- JPEG files
- .doc/.docx/.xls/.xlsx/.ppt/.pptx files

▶▶▶ Important

- Only files that are attached to e-mail can be printed. E-mail messages cannot be printed.
- Adobe PDF files and .doc/.docx/.xls/.xlsx/.ppt/.pptx files that are encrypted, password-protected, or set to print disabled cannot be printed.
- Files that are attached as compressed files cannot be printed.
- Files other than Adobe PDF files, JPEG files and .doc/.docx/.xls/.xlsx/.ppt/.pptx files cannot be printed.

Supported Number of Files and File Sizes



- Up to 10 attachment files can be printed.
- The maximum size of an e-mail with attachment files is 10 MB.

▶▶▶ Note

- The size of an e-mail is determined based on the size of the entire transmission file, including the e-mail message and the header. Therefore sometimes an attachment file cannot be printed even if the size of the attachment file is less than 10 MB.
- If the size of an attached JPEG file is less than 10 KB, the file cannot be printed.

2. Attach the file that you want to print from your smartphone, tablet, or computer to the e-mail and send it to the e-mail address for printing

To check the print address, from the operation panel of this printer, display the home window and

select  **Setup** ->  **Web service setup** -> **Web service connection setup** -> **Print from E-mail setup** -> **Check address for printing**.

▶▶▶ Important

- You will not be able to use the service during periods when the service is undergoing maintenance.

Use the Service With More Than One Person

To allow multiple users to use this function, register users (other than the printer's owner) as members.

1. The printer's owner uses his/her smartphone, tablet, or computer to access the service's login URL (<https://pr.mp.c-ij.com/po>) and logs in

2. Select the printer name that you want to add the member. Click **Member Settings** -> **Add** to enter the member's e-mail address, and click **Add**

A URL of the member registration page is sent to the e-mail address of the newly registered member.

3. Registered member accesses to the URL that is included in the e-mail, and complete the registration

You can use this service from registered e-mail address.

▶▶ Note

- You can register up to 500 members.

Print from E-mail Troubleshooting

- [The Document Does Not Print](#)
- [If You Cannot Register to the Service or Delete the Service](#)
- [If You Cannot Print after the Printer Is Repaired](#)

The Document Does Not Print

If the document does not print, check the following:

- Check that the printer power is on.
If the printer power is on, turn it off and then back on again, and check whether the issue is resolved.
- Check that the printer is connected to the network.
- Check that the printer is connected to a LAN and the LAN has an Internet connection.
- Look at the printer LCD monitor and check that no error message is displayed.
If the problem persists, use the printer driver on your computer to execute printing and check whether the document can be printed normally on the printer.
If the document cannot be printed, refer to the *Online Manual* for your printer.
- Check that the file attached to the e-mail is an Adobe PDF file, a JPEG file, or a .doc/.docx/.xls/.xlsx/.ppt/.pptx file.
- Check whether the e-mail address of the send destination is correct.
To check the print address, from the operation panel of this printer, display the home window and



select  **Setup** -> **Web service setup** -> **Web service connection setup** -> **Print from E-mail setup** -> **Check address for printing**.

- Check that the user's e-mail address for using this service is registered.
If you want to check the error details, the printer owner have to access the login URL (<https://pr.mp.c-ij.com/po>).
- In the **Print Status** screen, click **Go to Print History Screen** and check the history of jobs that were sent. You can check the error details.

If you want to check the error details, the printer owner have to access the login URL (<https://pr.mp.c-ij.com/po>).

►► Note

- For a wireless LAN connection, after the printer is turned on, it may take a few minutes before communication becomes possible. Confirm that your printer is connected to the wireless LAN, and then try printing.

If You Cannot Register to the Service or Delete the Service

If You Cannot Register to the Service

- If the printer operation panel display the message "**Failed to register with "Print from E-mail".**", the registration to **Print from E-mail** may not have been completed in time. Select **OK** to release the error, and start over again from the beginning.
- Check that the firmware version of the printer has been updated.

If You Do Not Receive the URL to Complete the Registration by E-mail

- An incorrect e-mail address may have been entered. Wait about 30 minutes, and operate the printer operation panel to print the printer registration URL and PIN code. Then re-register from the beginning.

If You Cannot Delete the Service

- If the printer operation panel display the message "**Failed to connect to "Print from E-mail". Only the information on the printer was deleted.**" is displayed, it could be that the registration information on the service could not be deleted even though the **Print from E-mail** information stored on this printer was deleted.
Select **OK** to release the error, and then access the service's login URL (<https://pr.mp.c-ij.com/po>) to delete the registration information.
- If the **Print from E-mail** information stored on this printer could not be deleted even though the registration information on the service was deleted, from the operation panel of this printer, display



the home window and select **Setup** -> **Web service setup** -> **Web service connection setup** -> **Print from E-mail setup** -> **Delete registered printer**, and delete the registration information.

If You Cannot Print after the Printer Is Repaired

Re-registering the printer and the printer owner

- When the printer is repaired, all of the registered information is deleted and **Print from E-mail** can no longer be used.

If you want to use this service again, you must re-register the printer and the printer owner.

For information about the re-registration procedure, see "[Preparing to Use Print from E-mail](#)".

Even if users other than the owner were registered as members, repeat the registration starting from [here](#).

Preparing to Use Print from E-mail

To use this service to print a photo or document, you need to follow the procedure provided below and register the printer.

Print the Printer Registration Page's URL and the PIN Code

First, print the printer registration page's URL and the PIN code.

Check that there is sufficient amount of ink in the printer, and then print using the printer's operation panel.

1. Check that the printer is connected to the network

»» Important

- This product needs to be connected to a LAN with an Internet connection.

2. From the operation panel of this printer, display the home window and select 

 **Setup** -> **Web service setup** -> **Web service connection setup** -> **Print from E-mail setup** -> **Register printer.**

3. Follow the instructions on the screen and print the printer registration URL and PIN code

»» Important

- Do not turn off the power on the printer until the registration process is completed. Access the printed URL and log in within 25 minutes.
- If you canceled the registration before it is completed, repeat the procedure from printing the registration information.

Access the Printed URL and Enter the Owner's E-mail Address and Other Required Information

Next, enter the owner's e-mail address and other required information.

1. Access the printed URL by using the browser on your smartphone, tablet, or computer, and select **Log In**
2. In the use agreement window, select **Agree**

»» Important

- If you do not select **Agree** in the use agreement window, you will not be able to register as the printer owner.

3. Enter the printer owner's e-mail address, and select **Next**

»» Important

- An e-mail is sent with the required information for completing the registration to the e-mail address entered for the printer's owner.
- If domain-specific reception is set, change the setting so that mail can be received from "info@mp.c-ij.com"

»» Note

- The e-mail address of the printer owner cannot be changed once the printer owner is registered.
To change the e-mail address, delete the registration of the registered printer, and re-register the printer owner by using the new e-mail address. In this case, all previously registered information will be deleted.
- The notification is sent automatically to the registered e-mail address when the printing or service maintenance starts.

4. In the **Printer Owner Registration** window, enter the information shown below, and click **Next**

User Name

Enter any name.

The name that you enter is displayed at login.

»» Important

- The maximum number of characters that can be entered is 30.

Language

Select the language that you are using.

The language that you select is used in notification e-mails such as print start notices.

Time Zone

Refer to [this section](#), and select the standard time of the city that is nearest to the region where you live.

Date/Time Display Format

Select the format of your choice.

The format that you select is applied to the date/time information in the screens and notification e-mails of this service.

Daylight Saving Time

This setting is combined with the **Time Zone** setting, and applied to the date/time information in the screens and notification e-mails of this service.

When you select **ON**, 1 hour is added to the **Time Zone** setting when the date/time information is displayed.

5. In the **Printer Registration** window, enter the **Printer Name**, and select **Confirm**

Enter any name that will allow you to identify the printer.

»» Important

- The maximum number of characters that can be entered is 30.

6. In the **Confirm Owner Registration** window, check the registration information, and select **Register**

A temporary password will be displayed.

»» Important

- The temporary password that appears is not included in the notification e-mail. Be sure to write down the temporary password before closing the screen.

Check if an E-mail Has Been Sent to the E-mail Address You Entered

A URL is notified to complete the registration to the e-mail address that for the registered printer's owner.

Access the URL in the E-mail and Complete the Printer Registration

1. Access the URL provided in the e-mail

»» Important

- You have to complete the registration within 30 minutes.

2. Enter the registered e-mail address of the printer's owner, the temporary password, and select **Log In**

3. Set a password of your choice, and select **Register**

When the password setting process is completed, the printer's e-mail address and the service's URL are displayed, and the printer's registration process is completed.

»» Important

- When you enter the password, the following character restrictions apply.
 - Set a password that has 8 or more characters.
 - The characters that you can use are single-byte uppercase letters, single-byte lowercase letters, and single-byte numbers.
 - In the password, combine all of the different types of characters that can be used.
- The displayed printer's e-mail address and the URL of the login page are not sent. Be sure to write down the printer's e-mail address and the URL of the login page before closing the screen.

Timezone List

(UTC-12:00)	International Date Line West
(UTC-11:00)	Midway Island
(UTC-10:00)	Hawaii
(UTC-09:00)	Alaska
(UTC-08:00)	Tijuana, Baja California, Pacific Time (US & Canada)
(UTC-07:00)	Arizona, Chihuahua, La Paz, Mazatlan, Mountain Time (US & Canada)
(UTC-06:00)	Guadalajara, Mexico City, Monterrey, Saskatchewan, Central America, Central Time (US & Canada)
(UTC-05:00)	Indiana (East), Bogota, Lima, Quito, Eastern Time (US & Canada), Caracas
(UTC-04:00)	Asuncion, Santiago, Georgetown, La Paz, San Juan, Manaus, Atlantic Time (Canada), Newfoundland
(UTC-03:00)	Cayenne, Greenland, Buenos Aires, Brasilia, Montevideo
(UTC-02:00)	Mid-Atlantic
(UTC-01:00)	Azores, Cape Verde Is.
(UTC+00:00)	Casablanca, Dublin, Edinburgh, Lisbon, London, Monrovia, Reykjavik, Coordinated Universal Time
(UTC+01:00)	Amsterdam, Berlin, Bern, Rome, Stockholm, Vienna, Sarajevo, Skopje, Warsaw, Zagreb, Brussels, Copenhagen, Madrid, Paris, Belgrade, Bratislava, Budapest, Ljubljana, Prague, West Central Africa
(UTC+02:00)	Athens, Bucharest, Istanbul, Amman, Windhoek, Jerusalem, Cairo, Harare, Pretoria, Beirut, Helsinki, Kyiv, Riga, Sofia, Tallinn, Vilnius, Minsk
(UTC+03:00)	Kuwait, Riyadh, Tbilisi, Nairobi, Baghdad, Moscow, St. Petersburg, Volgograd, Tehran
(UTC+04:00)	Abu Dhabi, Muscat, Yerevan, Baku, Port Louis, Kabul
(UTC+05:00)	Islamabad, Karachi, Ekaterinburg, Tashkent, Sri Jayawardenepura, Chennai, Kolkata, Mumbai, New Delhi, Kathmandu
(UTC+06:00)	Astana, Dhaka, Almaty, Novosibirsk, Yangon (Rangoon)
(UTC+07:00)	Krasnoyarsk, Bangkok, Hanoi, Jakarta
(UTC+08:00)	Irkutsk, Ulaan Bataar, Kuala Lumpur, Singapore, Perth, Taipei, Beijing, Chongqing, Hong Kong, Urumqi
(UTC+09:00)	Seoul, Yakutsk, Osaka, Sapporo, Tokyo, Adelaide, Darwin
(UTC+10:00)	Vladivostok, Canberra, Melbourne, Sydney, Guam, Port Moresby, Brisbane, Hobart
(UTC+11:00)	Magadan, Solomon Is., New Caledonia
(UTC+12:00)	Auckland, Wellington, Fiji, Marshall Is., Petropavlovsk-Kamchatsky
(UTC+13:00)	Samoa, Nuku'alofa

Print Easily from a Smartphone or Tablet with MAXIFY Printing Solutions

Use MAXIFY Printing Solutions to easily print photos saved on a smartphone or tablet wirelessly. You can also receive scanned data (PDF or JPEG) directly on a smartphone or tablet without using a computer.

MAXIFY Printing Solutions can be downloaded from App Store and Google Play.



Printing with Windows RT

When you use Windows RT, printing is easy because you simply connect this printer to the network.

For information about connecting to the network, see the setup URL (<http://www.canon.com/ijsetup>) for using this product from your computer, smartphone, or tablet device.

When the connection is complete, the Canon Inkjet Print Utility software, which allows you to specify detailed print settings, is downloaded automatically.

By using Canon Inkjet Print Utility, you can check the **Printer status** and specify detailed print settings. (The available functions will differ depending on your usage environment and connection method.)

Overview of the Machine

▶ **Safety Guide**

- Safety Precautions
- Regulatory and Safety Information

▶ **Main Components and Basic Operations**

- Main Components
- About the Power Supply of the Machine
- Using the Operation Panel
- Entering Numbers, Letters, and Symbols

▶ **Loading Paper / Originals**

- Loading Paper
- Loading Originals
- Inserting the USB Flash Drive

▶ **Replacing an Ink Tank**

- Replacing an Ink Tank
- Checking the Ink Status from Your Computer
- Checking the Ink Status

▶ **Maintenance**

- When Printing Becomes Faint or Colors Are Incorrect
- Performing Maintenance from a Computer
- Cleaning the Machine

▶ **Changing the Machine Settings**

- Changing Machine Settings from Your Computer
- Changing the Machine Settings Using the Operation Panel
- Registering the Favorite Settings (Custom profiles)
- Checking the Total Number of Uses of the Machine

▶ **Information about Network Connection**

- Useful Information about Network Connection

▶ **About Network Communication**

- Changing and Confirming Network Settings
- Appendix for Network Communication

▶ **Tips for Ensuring Optimal Printing Quality**

- Useful Information about Ink
- Key Points to Successful Printing
- Be Sure to Check Paper Settings before Printing
- Be Sure to Set Cassette Paper Information after Loading Paper
- Canceling a Print Job
- Key to Enjoying Consistent Printing Quality
- Precautions for Safe Transport of the Machine

▶ **Legal Limitations on Use of Your Product and Use of Images**

▶ **Specifications**

Safety Guide

- ▶ **Safety Precautions**
- ▶ **Regulatory and Safety Information**

Safety Precautions

Choosing a location

- Do not install the machine in a location that is unstable or subject to excessive vibration.
- Do not install the machine in locations that are very humid or dusty, in direct sunlight, outdoors, or close to a heating source.
To avoid the risk of fire or electric shocks, use the machine under the operating environment specified in the On-screen Manual.
- Do not place the machine on a thick rug or carpet.
- Place the machine with its back in a location that is more than 2 inches (5 cm) away from the wall.

Power supply

- Ensure that the area around the power outlet is kept clear at all times so you can easily unplug the power cord if necessary.
- Never remove the plug by pulling on the cord.
Pulling the cord may damage the power cord, leading to possible fire or electrical shock.
- Do not use an extension lead/cord.

Working around the machine

- Never put your hands or fingers in the machine while it is printing.
- When moving the machine, carry the machine at both ends. In case the machine weighs more than 14 kg, it is recommended to have two people lifting the machine. Accidental dropping of the machine causes injury. For the machine's weight, refer to the On-screen Manual.
- Do not place any object on the machine. Especially do not place metal objects (paper clips, staples, etc.) or containers of flammable solvents (alcohol, thinners, etc.) on top of the machine.
- Do not transport or use the machine on a slant, vertically or upside-down, as the ink may leak and damage the machine.

Working around the machine (For the multifunction printer)

- When loading a thick book on the Platen Glass, do not press hard on the Document Cover. The Platen Glass may break and cause injury.

Print Heads/ink tanks and FINE Cartridges

- Keep ink tanks out of the reach of children. In case ink* is accidentally licked or swallowed, rinse out mouth or give one or two glasses of water to drink. If irritation or discomfort occurs, obtain medical advice immediately.
* Clear Ink contains nitrate salts (For models containing Clear Ink).
- In case ink gets in contact with eyes, rinse with water immediately. In case ink gets in contact with skin, wash with soap and water immediately. If irritation to eyes or skin persists, obtain medical advice immediately.
- Never touch the electrical contacts on a Print Head or FINE Cartridges after printing.
The metal parts may be very hot and could cause burns.
- Do not throw ink tanks and FINE Cartridges into fire.
- Do not attempt to disassemble or modify the Print Head, ink tanks, and FINE Cartridges.

Regulatory and Safety Information

For models containing lithium battery

- Dispose of used batteries according to the local regulations.
- Risk of explosion if battery is replaced by an incorrect type.

IMPORTANT SAFETY INSTRUCTIONS

SAVE THESE INSTRUCTIONS

When using your telephone equipment, basic safety precautions should always be followed to reduce the risk of fire, electric shock and injury to persons, including the following:

1. Do not use this product near water, for example, near a bath tub, wash bowl, kitchen sink or laundry tub, in a wet basement or near a swimming pool.
2. Avoid using this product during an electrical storm. There may be a remote risk of electric shock from lightning.
3. Do not use this product to report a gas leak in the vicinity of the leak.

"CAUTION - To reduce the risk of fire, use only No. 26 AWG or larger telecommunication line cord."

IMPORTANTES MESURES DE SÉCURITÉ

CONSERVER CES INSTRUCTIONS

Certaines mesures de sécurité doivent être prises pendant l'utilisation de matériel téléphonique afin de réduire les risques d'incendie, de choc électrique et de blessures.

En voici quelquesunes :

1. Ne pas utiliser l'appareil près de l'eau, p.ex., près d'une baignoire, d'un lavabo, d'un évier de cuisine, d'un bac à laver, dans un sous-sol humide ou près d'une piscine.
2. Éviter d'utiliser l'appareil pendant un orage électrique. Ceci peut présenter un risque de choc électrique causé par la foudre.
3. Ne pas utiliser l'appareil pour signaler une fuite de gaz s'il est situé près de la fuite.

"ATTENTION - Pour réduire les risques d'incendie, utiliser uniquement des conducteurs de télécommunications 26 AWG au de section supérieure."

Users in the U.S.A.

FCC Notice (U.S.A. Only)

For 120V, 60Hz model

Model Number: K10411 (Contains FCC ID: AZDK30357)

This device complies with Part 15 of the FCC Rules. Operation is subject to the following two conditions: (1) This device may not cause harmful interference, and (2) this device must accept any interference received, including interference that may cause undesired operation.

Note: This equipment has been tested and found to comply with the limits for a Class B digital device, pursuant to Part 15 of the FCC Rules. These limits are designed to provide reasonable protection against harmful interference in a residential installation. This equipment generates, uses and can radiate radio frequency energy and, if not installed and used in accordance with the instructions, may cause harmful interference to radio communications.

However, there is no guarantee that interference will not occur in a particular installation. If this equipment

does cause harmful interference to radio or television reception, which can be determined by turning the equipment off and on, the user is encouraged to try to correct the interference by one or more of the following measures:

- Reorient or relocate the receiving antenna.
- Increase the separation between the equipment and receiver.
- Connect the equipment into an outlet on a circuit different from that to which the receiver is connected.
- Consult the dealer or an experienced radio/TV technician for help.

Use of a shielded cable is required to comply with Class B limits in Subpart B of Part 15 of the FCC Rules.

Do not make any changes or modifications to the equipment unless otherwise specified in the manual. If such changes or modifications should be made, you could be required to stop operation of the equipment.

FCC ID:AZDK30357

Changes or modifications not expressly approved by the party responsible for compliance could void the user's authority to operate equipment.

This transmitter must not be co-located or operating in conjunction with any other antenna or transmitter.

The equipment complies with FCC radiation exposure limits for uncontrolled equipment. This equipment should be installed and operated with minimum distance at least 20cm between the radiator and persons body (excluding extremities: hands, wrists, feet and ankles) and must not be colocated or operated with any other antenna or transmitter.

Canon U.S.A., Inc.
One Canon Park
Melville, New York 11747
1-800-652-2666

Pre-Installation Requirements

Order Information

When ordering service from the telephone company for this equipment, the following may be required.

Universal Service Order Code (USOC): RJ11C

The Facility Interface Code (FIC): 02LS2

Service Order Code (SOC): 9.0F

Connection of the Equipment

This equipment complies with Part 68 of the FCC rules and the requirements adopted by the ACTA.

A label on this equipment contains, among other information, a product identifier in the format US:AAAEQ##TXXXX. If requested, this number must be provided to the telephone company.

The REN is used to determine the number of devices that may be connected to a telephone line.

Excessive RENs on a telephone line may result in the devices not ringing in response to an incoming call. In most but not all areas, the sum of RENs should not exceed five (5.0). To be certain of the number of devices that may be connected to a line, as determined by the total RENs, contact the local telephone company. The REN for this product is part of the product identifier that has the format US:AAAEQ##TXXXX. The digits represented by ## are the REN without a decimal point (e.g., 03 is a REN of 0.3).

A plug and jack used to connect this equipment to the premises wiring and telephone network must comply with the applicable FCC Part 68 rules and requirements adopted by the ACTA. A compliant telephone cord and modular plug is provided with this product. It is designed to be connected to a compatible modular jack that is also compliant. See installation instructions for details.

Connection to party lines is subjected to state tariffs. Contact the state public utility commission, public service commission or corporation commission for information.

If your home has specially wired alarm equipment connected to the telephone line, ensure the installation of this equipment does not disable your alarm equipment. If you have questions about what will disable alarm equipment, consult your telephone company or a qualified installer.

In Case of Equipment Malfunction

Should any malfunction occur which cannot be corrected by the procedures described in the Online Manual, disconnect the equipment from the telephone line cable, turn off the power and disconnect the power cord. The telephone line cable should not be reconnected or the main power switch turned ON until the problem is completely resolved. Users should contact their local authorized Canon Facsimile Service Dealer for the servicing of equipment.

Information regarding Authorized Service Facility locations can be obtained by calling the Canon Customer Center.

Rights of the Telephone Company

If this equipment causes harm to the telephone network, the telephone company may temporarily disconnect service. The telephone company also retains the right to make changes in facilities and services that may affect the operation of this equipment. When such changes are necessary, the telephone company is required to give adequate prior notice to the user. However, if advance notice is not possible, the telephone company will notify the customer as soon as possible. Also, the customer will be advised of his/her right to file a complaint with the FCC if he/she believes it is necessary.

Warning

The Telephone Consumer Protection Act of 1991 makes it unlawful for any person to use a computer or other electronic device to send any message via a telephone FAX machine unless such message clearly contains in a margin at the top or bottom of each transmitted page, or on the first page of the transmission, the date and time it is sent and an identification of the business or other entity, or other individual sending the message and the telephone number of the sending machine or such business, other entity, or individual.

In order to program this information into your FAX machine, you should complete the procedure to register your name, unit's telephone number, time, and date. Refer to the Online Manual.

Users in Canada

This device complies with Industry Canada license-exempt RSS standard(s). Operation is subject to the following two conditions:

(1) this device may not cause interference, and (2) this device must accept any interference, including interference that may cause undesired operation of the device.

This equipment complies with IC radiation exposure limits set forth for an uncontrolled environment and meets RSS-102 of the IC radio frequency (RF) Exposure rules. This equipment should be installed and

operated keeping the radiator at least 20cm or more away from person's body (excluding extremities: hands, wrists, feet and ankles).

Pre-Installation Requirements

Notice

This equipment meets the applicable Industry Canada technical specifications.

The Ringer Equivalence Number is an indication of the maximum number of devices allowed to be connected to a telephone interface. The termination on an interface may consist of any combination of devices subject only to the requirement that the sum of the RENs of all the devices does not exceed five.

Pour les usagers résidant au Canada

Le présent appareil est conforme aux CNR d'Industrie Canada applicables aux appareils radio exempts de licence. L'exploitation est autorisée aux deux conditions suivantes :

(1) l'appareil ne doit pas produire de brouillage, et (2) l'utilisateur de l'appareil doit accepter tout brouillage radioélectrique subi, même si le brouillage est susceptible d'en compromettre le fonctionnement.

Cet équipement est conforme aux limites d'exposition aux rayonnements énoncées pour un environnement non contrôlé et respecte les règles d'exposition aux fréquences radioélectriques (RF) CNR-102 de l'IC. Cet équipement doit être installé et utilisé en gardant une distance de 20 cm ou plus entre le dispositif rayonnant et le corps (à l'exception des extrémités : mains, poignets, pieds et chevilles).

Conditions de pré-installation

Avis

Le présent matériel est conforme aux spécifications techniques applicables d'Industrie Canada.

L'indice d'équivalence de la sonnerie (IES) sert à indiquer le nombre maximal de terminaux qui peuvent être raccordés à une interface téléphonique. La terminaison d'une interface peut consister en une combinaison quelconque de dispositifs, à la seule condition que la somme d'indices d'équivalence de la sonnerie de tous les dispositifs n'excède pas 5.

Users in New Zealand

The grant of a Telepermit for any item of terminal equipment indicates only that Telecom has accepted that the item complies with minimum conditions for connection to its network. It indicates no endorsement of the product by Telecom, nor does it provide any sort of warranty. Above all, it provides no assurance that any item will work correctly in all respects with another item of Telepermitted equipment of a different make or model, nor does it imply that any product is compatible with all of Telecom's network services.

This equipment is not capable, under all operating conditions, of correct operation at the higher speeds for which it is designed.

Telecom will accept no responsibility should difficulties arise in such circumstances.

This condition typically to 56 kbit/s modems and V34 facsimile machines.

Please note when you connect an extension phone to this device, if you use an extension phone which has features such as "last number redial", redial memory numbers may be lost.

This equipment should not be used under any circumstances that may constitute a nuisance to other Telecom customers.

Telepermitted equipment only may be connected to the auxiliary telephone port. The auxiliary telephone port is not specifically designed for 3-wire connected equipment that may not respond to incoming ringing when attached to this port.

Users in Jordan

This printer contains WLAN Module approved by TRC/LPD/2013/130

Name of WLAN Module : K30357

Only for European Union and EEA (Norway, Iceland and Liechtenstein)

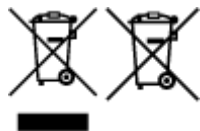

These symbols indicate that this product is not to be disposed of with your household waste, according to the WEEE Directive (2012/19/EU), the Battery Directive (2006/66/EC) and/or national legislation implementing those Directives. If a chemical symbol is printed beneath the symbol shown above, in accordance with the Battery Directive, this indicates that a heavy metal (Hg = Mercury, Cd = Cadmium, Pb = Lead) is present in this battery or accumulator at a concentration above an applicable threshold specified in the Battery Directive. This product should be handed over to a designated collection point, e.g., on an authorized one-for-one basis when you buy a new similar product or to an authorized collection site for recycling waste electrical and electronic equipment (EEE) and batteries and accumulators. Improper handling of this type of waste could have a possible impact on the environment and human health due to potentially hazardous substances that are generally associated with EEE. Your cooperation in the correct disposal of this product will contribute to the effective usage of natural resources. For more information about the recycling of this product, please contact your local city office, waste authority, approved scheme or your household waste disposal service or visit www.canon-europe.com/weee, or www.canon-europe.com/battery.

Korisnici u Srbiji

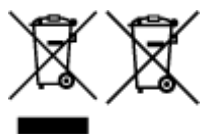

Ovaj simbol označava da ovaj proizvod ne sme da se odlaže sa ostalim kućnim otpadom, u skladu sa WEEE Direktivom (2012/19/EU), Direktivom o baterijama (2006/66/EC) i nacionalnim zakonima. Ukoliko je ispod gore navedenog simbola odštampan hemijski simbol, u skladu sa Direktivom o baterijama, ovaj simbol označava da su u ovoj bateriji ili akumulatoru prisutni teški metali (Hg – živa, Cd – kadmijum, Pb - olovo) u koncentracijama koje premašuju prihvatljivi prag naveden u Direktivi o baterijama. Ovaj proizvod treba predati određenom centru za prikupljanje, npr. po principu „jedan-za-jedan“ kada kupujete sličan novi proizvod, ili ovlašćenom centru za prikupljanje za reciklažu istrošene električne i elektronske opreme (EEE), baterija i akumulatora. Nepravilno rukovanje ovom vrstom otpada može imati negativne posledice po životnu sredinu i ljudsko zdravlje usled potencijalno opasnih materijala koji se uglavnom vezuju za EEE. Vaša saradnja na ispravnom odlaganju ovog proizvoda će doprineti efikasnom korišćenju prirodnih resursa. Više informacija o tome kako možete da reciklirate ovaj proizvod potražite od lokalnih gradskih vlasti, komunalne službe, odobrenog plana reciklaže ili servisa za odlaganje kućnog otpada, ili posetite stranicu www.canon-europe.com/weee, ili www.canon-europe.com/battery.

India only.



This product is not to be disposed of with your household waste, according to the e-waste (Management and Handling) Rules, 2011.

This product should be handed over to a designated collection point, e.g., to an authorized collection site for recycling waste electrical and electronic equipment (EEE). Improper handling of this type of waste could have a possible negative impact on the environment and human health due to potentially hazardous substances that are generally associated with EEE. At the same time, your cooperation in the correct disposal of this product will contribute to the effective usage of natural resources. For more information regarding return and recycling of WEEE products, please visit <http://www.canon.co.in/environment/>.

Also, this product complies with the "India E-waste Rule 2011" and prohibits use of lead, mercury, hexavalent chromium, polybrominated biphenyls or polybrominated diphenyl ethers in concentrations exceeding 0.1 % by weight and 0.01 % by weight for Cadmium, except for the exemptions set in Schedule II of the Rule.

Environmental Information

Reducing your environmental impact while saving money

Power Consumption and Activation Time

The amount of electricity a device consumes depends on the way the device is used. This product is designed and set in a way to allow you to reduce your electricity costs. After the last print it switches to Ready Mode. In this mode it can print again immediately if required. If the product is not used for a time, the device switches to its Power Save Mode. The devices consume less power (Watt) in these modes. If you wish to set a longer Activation Time or would like to completely deactivate the Power Save Mode, please consider that this device may then only switch to a lower energy level after a longer period of time or not at all.

Canon does not recommend extending the Activation Times from the optimum ones set as default.

Energy Star®

The Energy Star® programme is a voluntary scheme to promote the development and purchase of energy efficient models, which help to minimise environmental impact.

Products which meet the stringent requirements of the Energy Star® programme for both environmental benefits and the amount of energy consumption will carry the Energy Star® logo accordingly.

Paper types

This product can be used to print on both recycled and virgin paper (certified to an environmental stewardship scheme), which complies with EN12281 or a similar quality standard. In addition it can support printing on media down to a weight of 64g/m², lighter paper means less resources used and a lower environmental footprint for your printing needs.

Regulatory Model Code (RMC) is for identification and proof that the product complies with the regulations. Please note that RMC is different from the marketing model number of the product.



CE

Main Components and Basic Operations

- **Main Components**
- **About the Power Supply of the Machine**
- **Using the Operation Panel**
- **Entering Numbers, Letters, and Symbols**

Main Components

- ▶ **Front View**
- ▶ **Rear View**
- ▶ **Inside View**
- ▶ **Operation Panel**

Front View

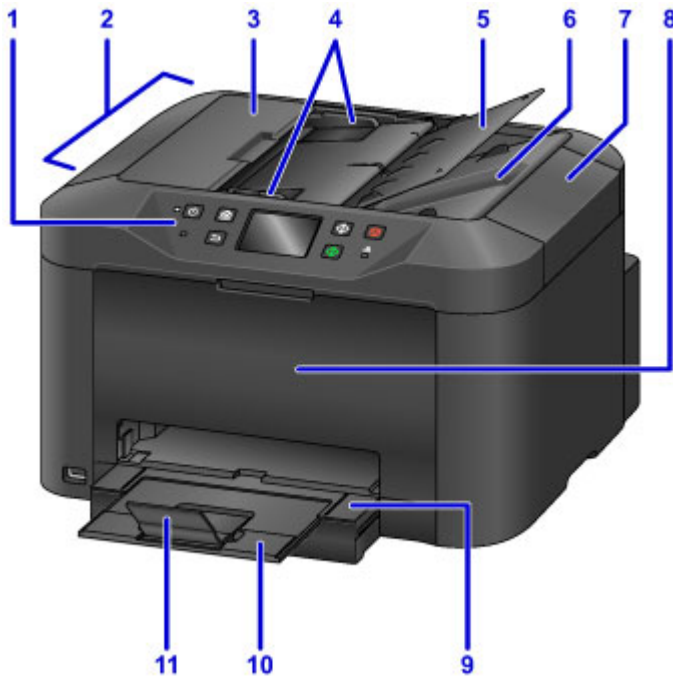

(1) operation panel

Use to change the settings of the machine or to operate it.

■ [Operation Panel](#)

(2) ADF (Auto Document Feeder)

Load a document here. The documents loaded in the document tray are scanned automatically one sheet at a time.

■ [Loading Documents in the ADF \(Auto Document Feeder\)](#)

(3) document feeder cover

Open when clearing jammed documents.

(4) document guides

Adjust these guides to match the width of document in the ADF.

(5) document tray

Open to load a document in the ADF. You can load two or more sheets of document of the same size and thickness. Load the document with the side you want to scan facing up.

(6) document output slot

Documents scanned from the ADF are delivered here.

(7) document cover

Open to load an original on the platen glass.

(8) front cover

Open to replace an ink tank or remove jammed paper inside the machine.

(9) paper output tray

Pull out to support printed paper. It will then cover the cassette. Pull out for normal use.

(10) output tray extension

Extend to support ejected paper.

(11) paper output support

Open to support ejected paper.

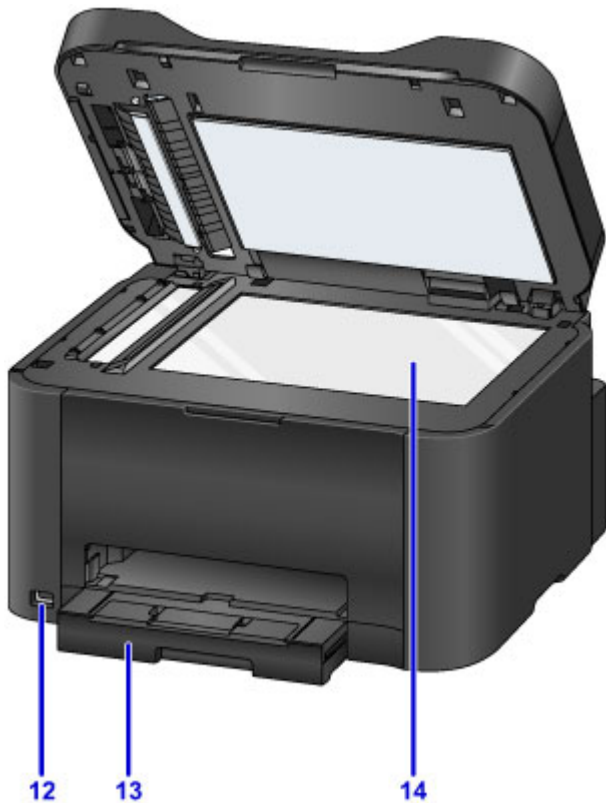

(12) USB flash drive port

[Insert a USB flash drive](#) to this port.

⚠ Warning

- Do not connect any equipment other than the USB flash drives to the USB flash drive port of the machine. This may cause fire, electric shock, or damage to the machine.

➤➤ Important

- Do not touch the metal casing.
- Do not use the USB cable longer than 10 feet (3 meters) to connect to the machine since it may affect the operation of other peripheral devices.

(13) cassette

Load paper here. Two or more sheets of the same size and type of paper can be loaded at the same time, and fed automatically one sheet at a time.

■ [Paper Source to Load Paper](#)

(14) platen glass

Load an original here.

Rear View

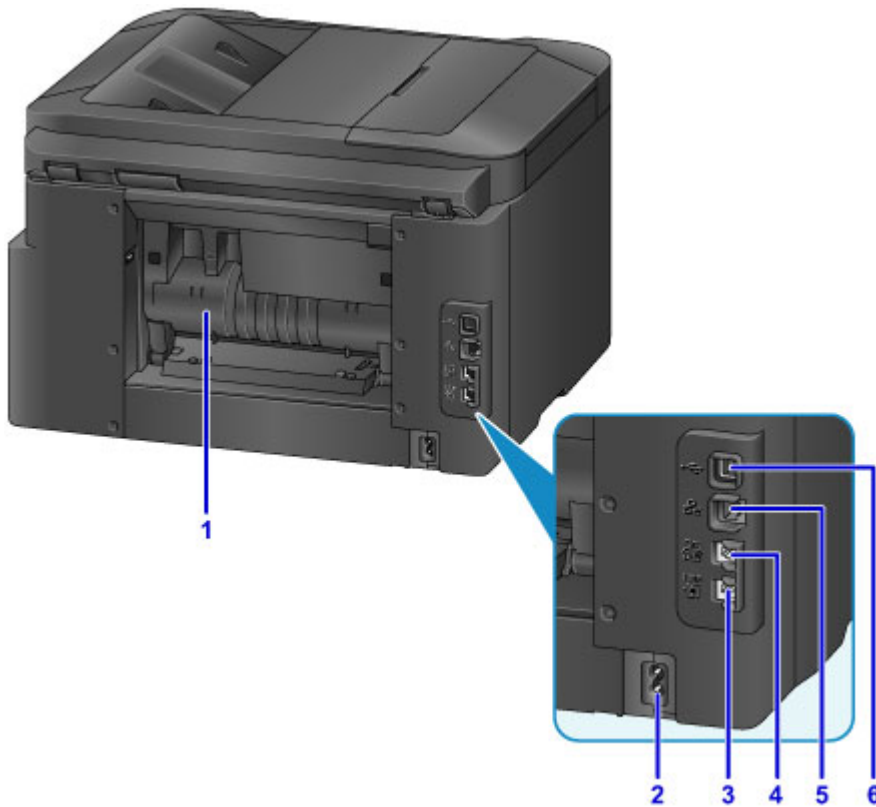

(1) rear cover

Open when removing jammed paper.

(2) power cord connector

Plug in the supplied power cord.

(3) telephone line jack

Connect the telephone line.

(4) external device jack

Connect an external device such as telephone or answering machine.

(5) wired LAN connector

Plug in the LAN cable to connect the machine to a LAN.

(6) USB port

Plug in the USB cable to connect the machine with a computer.

▶▶ Important

- Do not touch the metal casing.
- Do not plug in or unplug the USB cable or LAN cable while the machine is printing or scanning originals with the computer.

Inside View

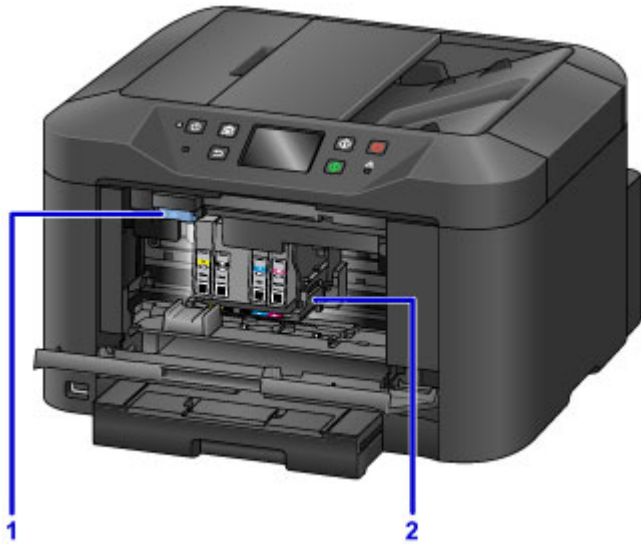

(1) ink tank eject lever

Push up when removing an ink tank.

(2) print head holder

The print head is pre-installed.

»» Note

- For details on replacing an ink tank, see [Replacing an Ink Tank](#).

Operation Panel

* All lamps on the operation panel are shown lit in the figure below for explanatory purposes.

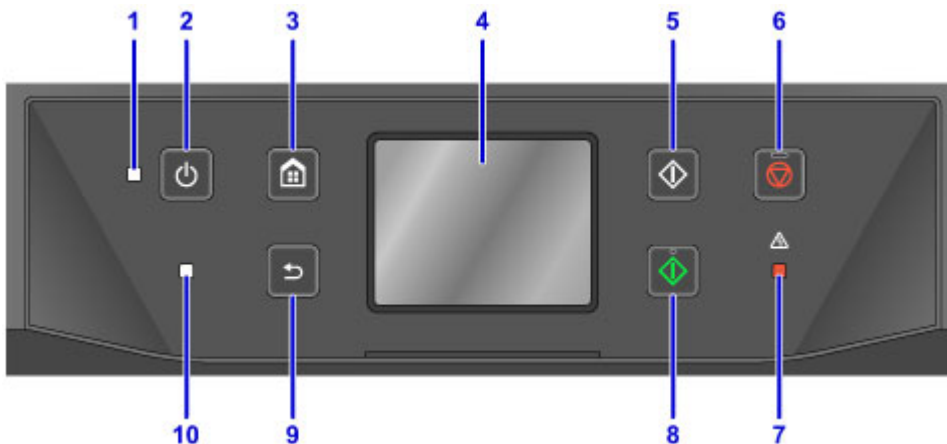

(1) POWER lamp

Lights after flashing when the power is turned on.

(2) ON button

Turns the power on or off. Before turning on the power, make sure that the document cover is closed.

■ [Turning the Machine On and Off](#)

(3) HOME button

Used to display the HOME screen.

■ [Using the Operation Panel](#)

(4) touch screen

Displays messages, menu items, and the operational status. Directly touch the screen lightly with your finger tip to select a menu item or displayed button.

■ [Basic Operation of the touch screen](#)

(5) Black button

Starts black & white copying, scanning, faxing, etc.

(6) Stop button

Cancels operation when print, copy, scan, or fax transmission/reception job is in progress.

(7) Alarm lamp

Lights or flashes when an error occurs.

(8) Color button

Starts color copying, scanning, faxing, etc.

(9) Back button

Returns the screen to the previous screen.

(10) FAX Memory lamp

Lights when there are received or unsend documents stored in the machine's memory.

▶▶▶ Note

- When buttons on the operation panel are touched, the machine generates keypad or alarm sounds as necessary. The sound volume can be adjusted in **Sound control** of **Device user settings**.

■ [Device user settings](#)

About the Power Supply of the Machine

- **Confirming that the Power Is On**
- **Turning the Machine On and Off**
- **Notice for the Power Plug/Power Cord**
- **Notice for Unplugging the Power Cord**

Confirming that the Power Is On

The **POWER** lamp is lit when the machine is turned on.

Even if the touch screen is off, if the **POWER** lamp is lit, the machine is on.



▶▶▶ Note

- It takes about 10 seconds until you can operate the machine after you turn on its power. Wait until the HOME screen is displayed on the touch screen.
- The touch screen display will turn off if the machine is not operated for about 5 minutes. To restore the display, touch the touch screen. The display will be also restored when receiving faxes or performing the print operation from a computer.

Turning the Machine On and Off

Turning on the machine

1. Press the **ON** button to turn on the machine.

The **POWER** lamp flashes and then remains lit.

- [Confirming that the Power Is On](#)



▶▶▶ Note

- It takes about 10 seconds until you can operate the machine after you turn on its power. Wait until the HOME screen is displayed on the touch screen.
- If the **Alarm** lamp lights up or flashes and an error message is displayed on the touch screen, see [A Message Is Displayed](#).
- You can set the machine to automatically turn on at the specified day of week or time. For details on **Power control - ON settings**, see below.

From the machine

- [About ECO settings](#)

From the computer

- [Managing the Printer Power](#)

Turning off the machine

1. Press the **ON** button to turn off the machine.

When the **POWER** lamp stops flashing, the machine is turned off.



▶▶▶ Important

- When you [unplug the power cord](#) after turning off the machine, be sure to confirm that the **POWER** lamp is off.

»» Note

- The machine cannot send or receive faxes when the power is turned off.
- The power cannot be turned off while the machine is sending or receiving a fax, or when unsent faxes are stored in the machine's memory.
- You can set the machine to automatically turn off at the specified day of week or time. For details on **Power control - OFF settings**, see below.

From the machine

- [About ECO settings](#)

From the computer

- [Managing the Printer Power](#)

Notice for the Power Plug/Power Cord

Check the power plug/power cord once a month to confirm that it does not have anything unusual described below.

- The power plug/power cord is hot.
- The power plug/power cord is rusty.
- The power plug/power cord is bent.
- The power plug/power cord is worn.
- The power plug/power cord is split.

Caution

- If you find anything unusual with the power plug/power cord described above, [unplug the power cord](#) and call for service. Using the machine with one of the unusual conditions above may cause a fire or an electric shock.

Notice for Unplugging the Power Cord

To unplug the power cord, follow the procedure below.

▶▶▶ Important

- When you unplug the power cord, press the **ON** button, then confirm that the **POWER** lamp is off. Unplugging the power cord before the **POWER** lamp is turned off may cause drying or clogging of the print head and print quality may be reduced.
- If the power cord is unplugged, all documents stored in the machine's memory will be lost. Send or print a necessary document, or save it on a USB flash drive before unplugging the power cord.

1. Press the **ON** button to turn the machine off.



2. Confirm that the **POWER** lamp is off.



3. Unplug the power cord.

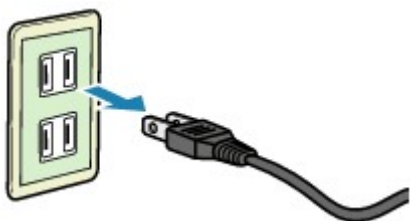

The specification of the power cord differs depending on the country or region of use.

Using the Operation Panel

The operation panel consists of the touch screen (A) and buttons (B).

Touch the HOME screen on the touch screen with your finger tip to select menus for copying, scanning, and other functions.

The HOME screen comprises three separate screens.

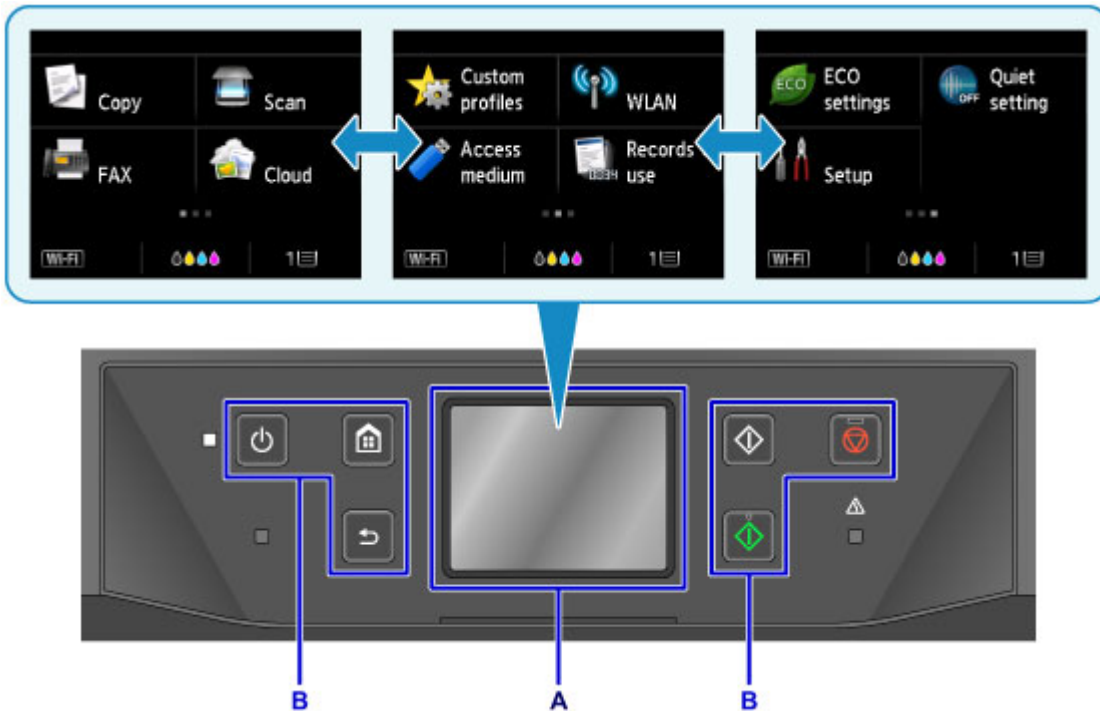

A: touch screen

B: Buttons on the operation panel

Basic Operation of the touch screen

Touch the touch screen lightly with your finger tip or move your finger to access various functions or settings.

►►► Important

- When operating the touch screen, make sure to avoid the followings, which may cause the machine to malfunction or damage the machine.
 - Strongly pressing the touch screen.
 - Pressing the touch screen with other than your finger (especially with sharpened tips, such as on ballpoint pens, pencils, or nails).
 - Touching the touch screen with wet or dirty hands.
 - Placing any objects on the touch screen.
- Do not attach a protective sheet on the touch screen. Removing it may damage the touch screen.

Tap

Touch lightly with your finger tip and immediately release.

Use to select an item or photo on the screen.

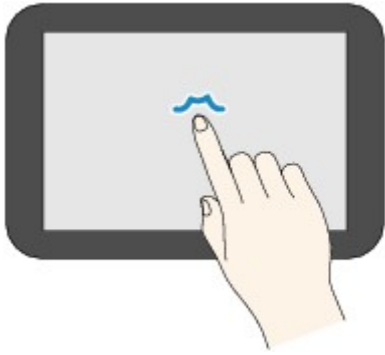

Touch

Touch lightly with your finger tip.

To move forward (or go back) menus or photos continuously, keep touching the forward (or back) mark.

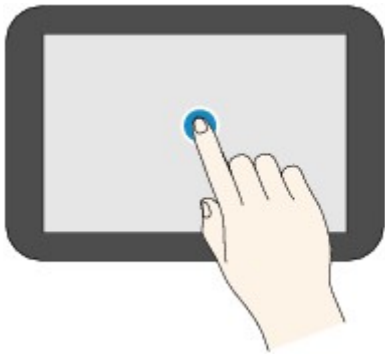

Flick

Flick your finger on the screen up, down, left, or right.

Use to switch menus or move forward or backward through photos.

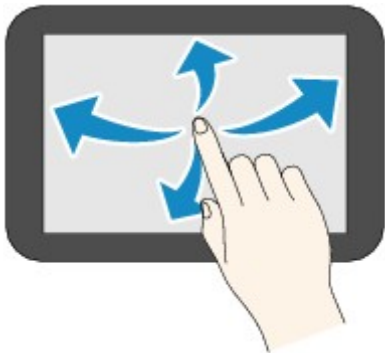

Drag

While lightly touching the screen, move your finger up, down, left, or right.

Use to view lists of items or move sliders.

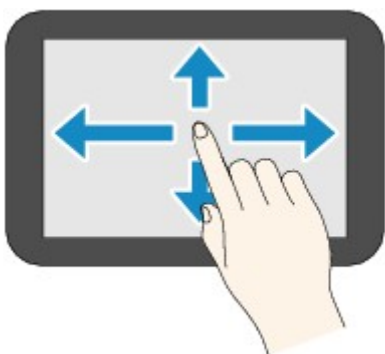

An Operation Example of the touch screen

Example: The touch screen operations available on the copy standby screen



Tap A to display the print settings menu.

Drag the screen up or down, then tap the option you want to select.

After the list is displayed, tap the setting to select.

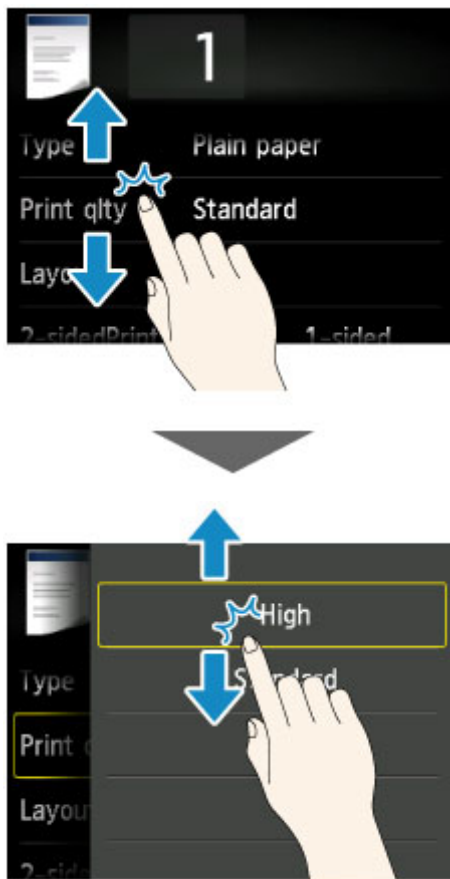

Tap B to display the screen for selecting the number of copies.





Tap the numbers to specify the number of copies, then tap **OK**.

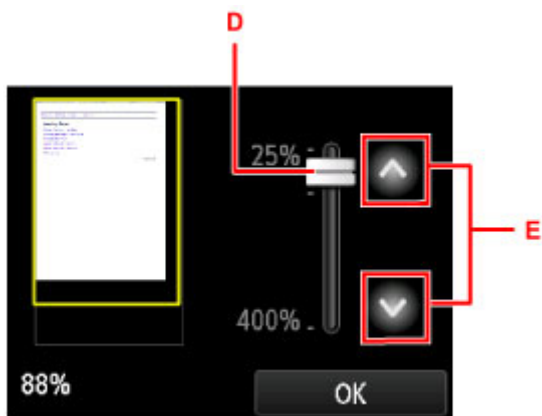

Tap C to display the preview screen.

Drag the sidebar (D) up or down to enlarge or reduce the zoom % while viewing the preview image at left.



Tapping  or  (E) also changes the zoom. Hold your finger on  or  to continuously change the magnification.

After the copy magnification is selected, tap **OK**.

Entering Numbers, Letters, and Symbols

The machine allows you to enter or edit characters by selecting them from an on-screen character list when entering information, such as unit name, a recipient's name for the directory, etc.

Switching the Input Mode

The machine has an alphabetic mode and number/symbol mode. To switch between them, tap  (A) at the bottom left.

To switch between lower and upper case modes in the alphabetic mode and the type of symbols in the number/symbol mode, tap  (B).

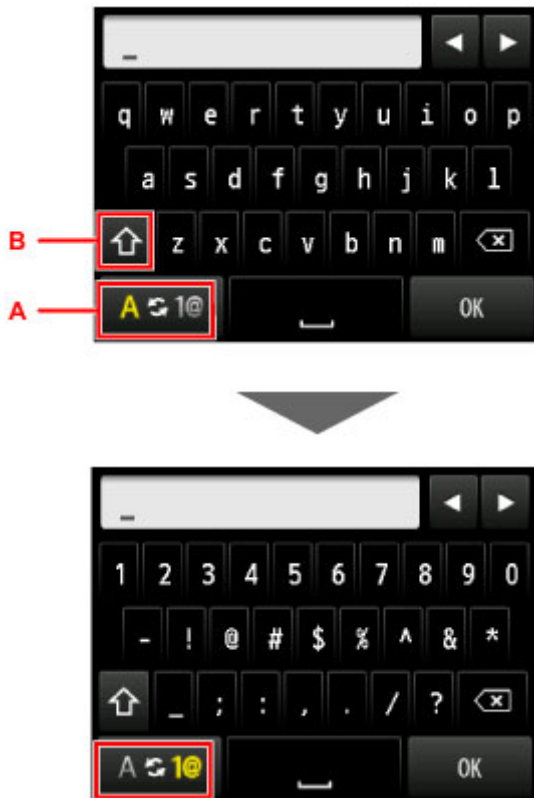

➤➤➤ Note

- For unit telephone number entry or fax/telephone number entry in the directory, only the numbers and symbols available for that type of entry are displayed on the screen.

Entering or Editing Numbers, Letters, and Symbols



The input method is as follows.

- To move the insertion position (cursor position) in the entry field (C)

Tap or (D).

- To delete an entered character

Move the cursor under the character to delete, then tap (E).

Keep on touching to continue deleting characters.

- To insert a space

Tap (F).

After entry is complete, tap **OK** (G).

Key assignments for multiple languages

Repeatedly tap the same key until the character you want to enter is displayed in the entry field (C).

Key	Lower case	Upper case
a / A	a á â ã ä å æ	A Ä Å Æ
c / C	c ç	C Ç
e / E	e ë é è ê	E É Ê Ë
i / I	í î ï ï	I Í Î Ï
n / N	n ñ	N Ñ
o / O	o ø ö ó ô õ	O Ø Ö Õ Ö
p / P	p þ	P Þ
u / U	u ü ú û û	U Ü Ú Û Ü
y / Y	y ý	Y Ý

Loading Paper / Originals

- ▶ **Loading Paper**
- ▶ **Loading Originals**
- ▶ **Inserting the USB Flash Drive**

Loading Paper

- **Paper Source to Load Paper**
- **Loading Plain Paper / Photo Paper**
- **Loading Envelopes**
- **Media Types You Can Use**
- **Media Types You Cannot Use**
- **Printing Area**

Paper Source to Load Paper

Adjusting the cassette according to the Paper

The cassette can be adjusted to three lengths. Press down the lock (A) on the cassette to extend the cassette.

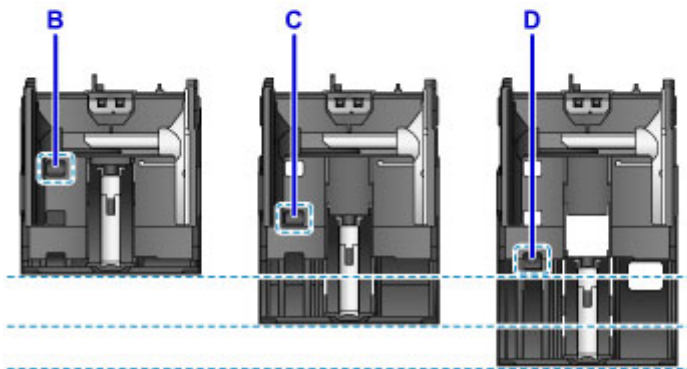
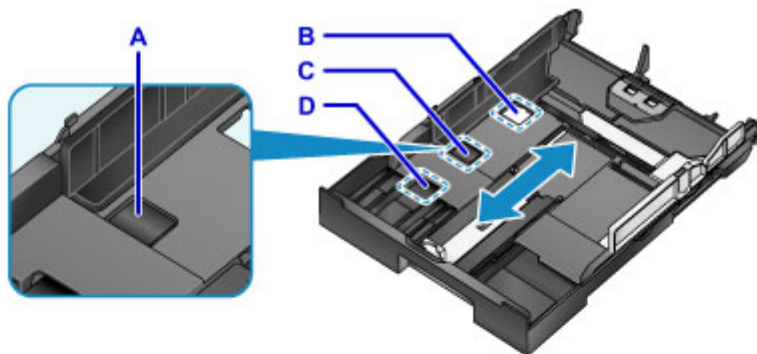

B: Lock position for stowing the cassette

When not using this machine for long period of time or moving it, set it to the position B. The cassette will fit into the width of the machine. Paper cannot be loaded while in this position.

C: Lock position for A4 or Letter-sized paper or smaller

For A4 or Letter-sized paper or smaller, set it to the position C. The cassette sticks out of the machine, but you can cover it by pulling out the paper output tray. Set the cassette to this position for normal use.

D: Lock position for paper larger than A4 or Letter size

For paper larger than A4 size, such as Legal size, set the cassette to the position D. When the cassette is set to this position and inserted into the machine, pulling out the paper output tray will not fully cover it. (The cassette sticks out of the machine.)

Loading Paper with the Print Side Facing Down

If the paper has a print side (front or back), such as photo paper, load it with the whiter side (or glossy side) facing down.

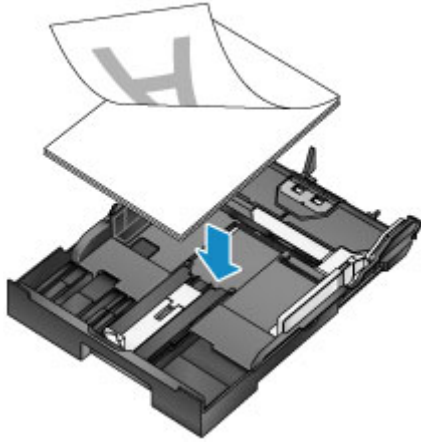

►► Note

- When printing, be sure to select the correct page size and media type. If the wrong page size and media type are selected, the machine may feed paper from the wrong paper source or may not print with the proper print quality.

For details on loading paper in a cassette, see below.

■ [Loading Plain Paper / Photo Paper](#)

■ [Loading Envelopes](#)

Loading Plain Paper / Photo Paper

You can load paper in the cassette.

▶▶▶ Important

- If you cut plain paper into small size such as 4" x 6" (10 x 15 cm) or 5" x 7" (13 x 18 cm) to perform trial print, it can cause paper jams.

▶▶▶ Note

- We recommend Canon genuine photo paper for printing photos.
For details on the Canon genuine paper, see [Media Types You Can Use](#).
- You can use general copy paper.
- For the page size and paper weight you can use for this machine, see [Media Types You Can Use](#).
- For loading envelopes, see [Loading Envelopes](#).

1. Prepare paper.

Align the edges of paper. If paper is curled, flatten it.

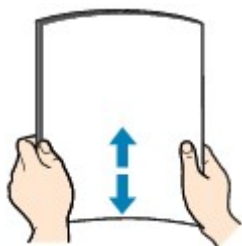

▶▶▶ Note

- Align the edges of paper neatly before loading. Loading paper without aligning the edges may cause paper jams.
- If paper is curled, hold the curled corners and gently bend them in the opposite direction until the paper becomes completely flat.
For details on how to flatten curled paper, see "Load the paper after correcting its curl." in [Paper Is Smudged/Printed Surface Is Scratched](#).
- When using Photo Paper Plus Semi-gloss SG-201, even if the sheet is curled, load one sheet at a time as it is. If you roll up this paper to flatten, this may cause cracks on the surface of the paper and reduce the print quality.

2. Pull out the cassette from the machine.



3. Slide the paper guide (A) in front and (B) on the right to open the guides.

4. Load the paper stack WITH THE PRINT SIDE FACING DOWN, and place it in the center of the cassette.

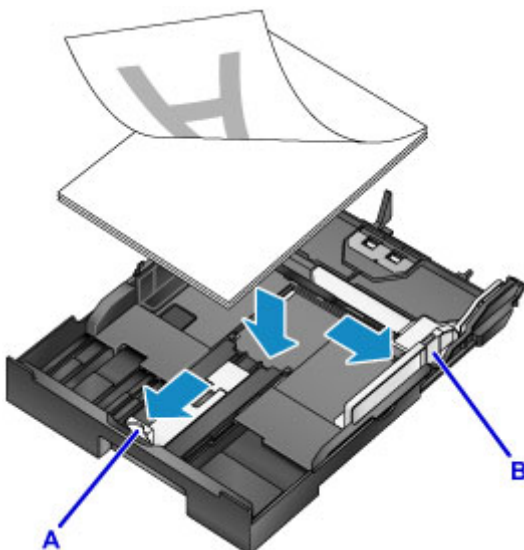

Important

- Always load paper in the portrait orientation (C). Loading paper in the landscape orientation (D) can cause paper jams.

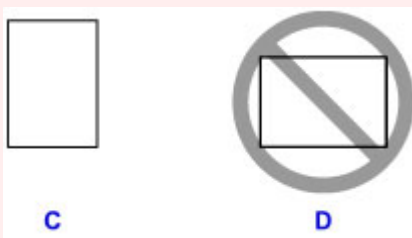

Note

- If paper has print side (front or back), such as photo paper, load it with the whiter side (or glossy side) facing down.
 - Align the paper stack with the edge of the cassette as shown in the figure below.
- If the paper stack is in contact with the protrusion (E), the paper may not be fed properly.

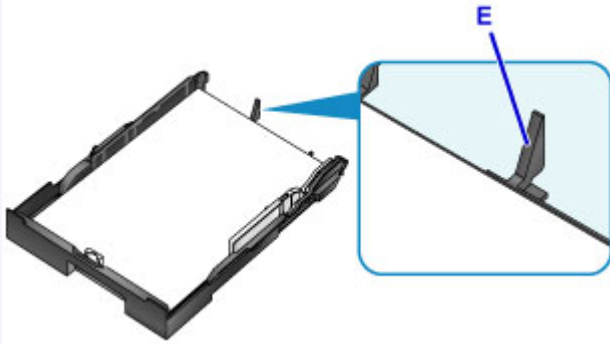

- To load 5" x 7" (13 x 18 cm) size paper or smaller, raise the tab (F) of the paper guide.

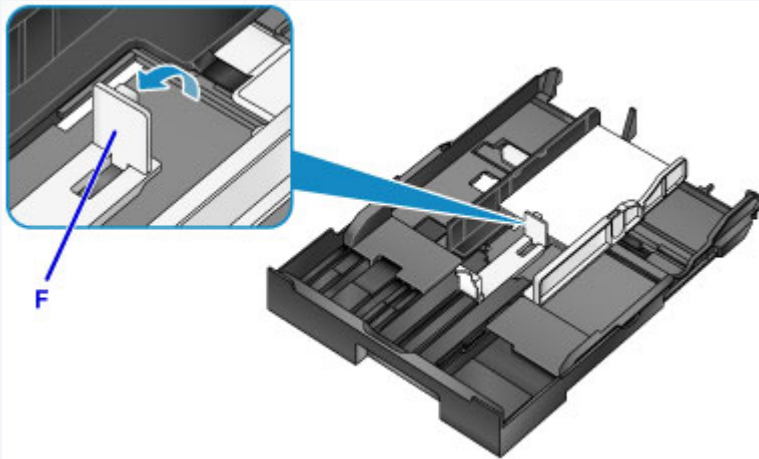

- To load paper larger than A4 size in the cassette, press down the lock (G) on the cassette, then extend the cassette all the way out.

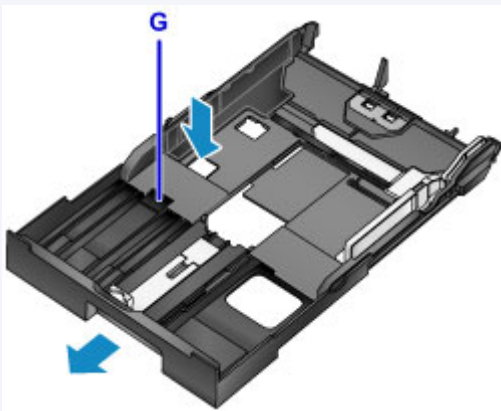

5. Align the paper guide (A) in front with the paper stack.

For standard sizes, set the paper guide (A) to where it clicks into place.

6. Slide the paper guide (B) on the right to align the right and left guides with both sides of the paper stack.

Do not slide the paper guides too hard against the paper. The paper may not be fed properly.

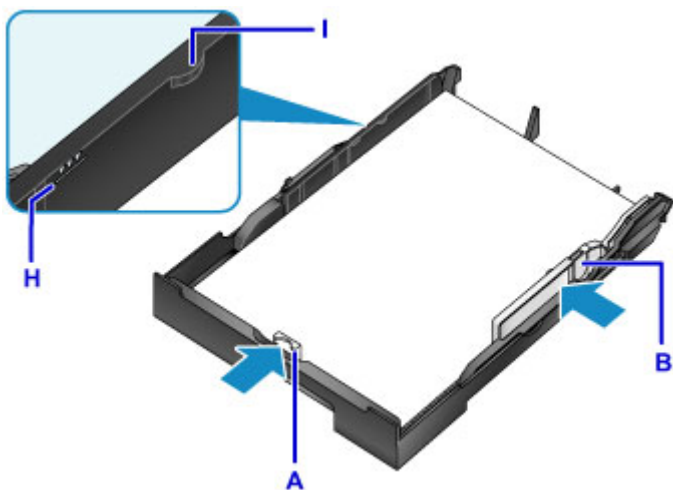

►► Note

- Do not load sheets of paper higher than the load limit mark (H).
- Keep the paper stack height below the tabs (I) of the paper guides.

7. Insert the cassette into the machine.

Push the cassette into the machine until it stops.

After inserting the cassette into the machine, the paper information registration screen for the cassette is displayed on the touch screen.



►► Note

- When A4 or Letter-sized paper or smaller is loaded, the cassette stops at the same position as the extended paper output tray, which then covers the cassette.
- When paper larger than A4 or Letter size is loaded, the extended cassette protrudes beyond the paper output tray. Do not force the cassette into the machine any further. This can damage the machine or cassette.

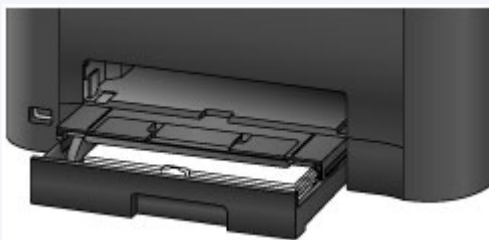

8. Select the size and type of the loaded paper in the cassette at **Page size** and **Type**, then tap **Register**.

If a message is displayed on the screen, follow the directions in the message to complete registration.

■ [Paper setting for Printing](#)

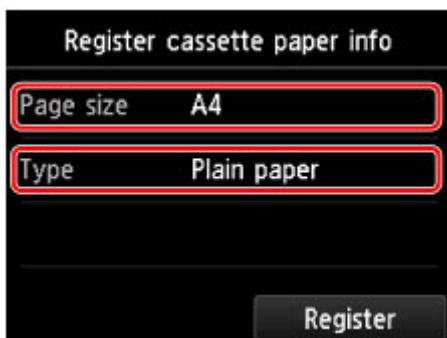

9. Extend the output tray extension (J), then open the paper output support (K).

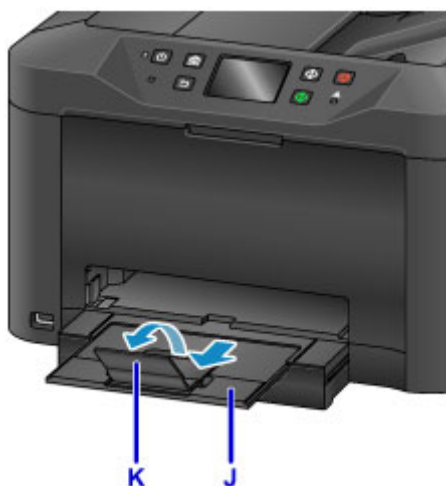

▶▶▶ Note

- When printing, select the size and type of the loaded paper on the print settings screen of the operation panel or printer driver.

Loading Envelopes

The address is automatically rotated and printed according to the envelope's direction by specifying with the printer driver properly.

▶▶▶ Important

- Printing of envelopes from the operation panel is not supported.
- Do not use the following envelopes. They could jam in the machine or cause the machine to malfunction.
 - Envelopes with an embossed or treated surface
 - Envelopes with a double flap
 - Envelopes whose gummed flaps are already moistened and adhesive

1. Prepare envelopes.

- Press down on all four corners and edges of the envelopes to flatten them.

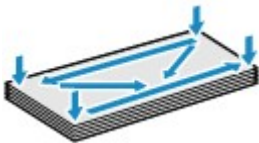

- If the envelopes are curled, hold the opposite corners and gently twist them in the opposite direction.



- If the corner of the envelope flap is folded, flatten it.
- Use a pen to press the leading edge in the inserting direction flat and sharpen the crease.

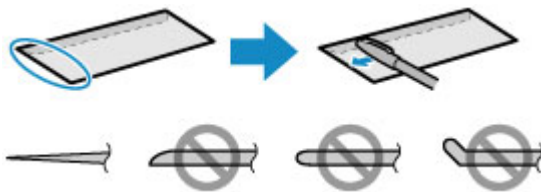

The figures above show a side view of the leading edge of the envelope.

▶▶▶ Important

- The envelopes may jam in the machine if they are not flat or the edges are not aligned. Make sure that no curl or puff exceeds 0.1 inch (3 mm).

2. Pull out the cassette from the machine.



3. Slide the paper guide (A) in front and (B) on the right to open the guides.

4. Load the envelopes WITH THE PRINT SIDE FACING DOWN, and place them in the center of the cassette.

The folded flap of the envelope will be faced up as shown in the figure below (C).

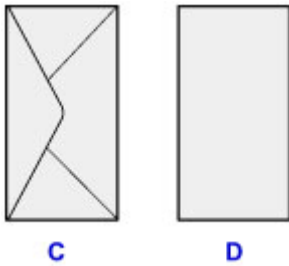

C: Rear side

D: Address side

Up to 10 envelopes can be loaded at once.

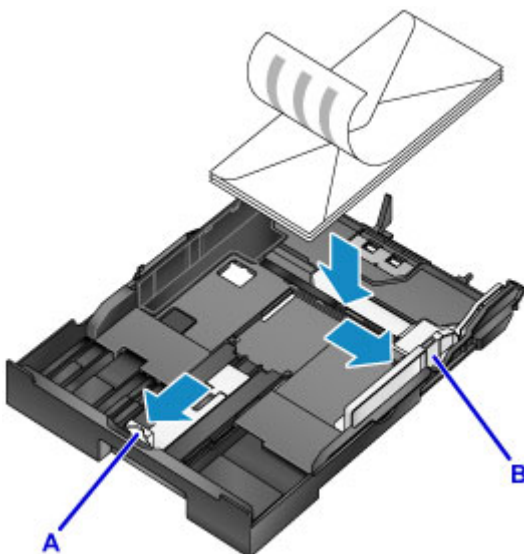

►► Note

- Align the envelope stack with the edge of the cassette as shown in the figure below.
If the envelopes are in contact with the protrusion (E), the envelopes may not be fed properly.

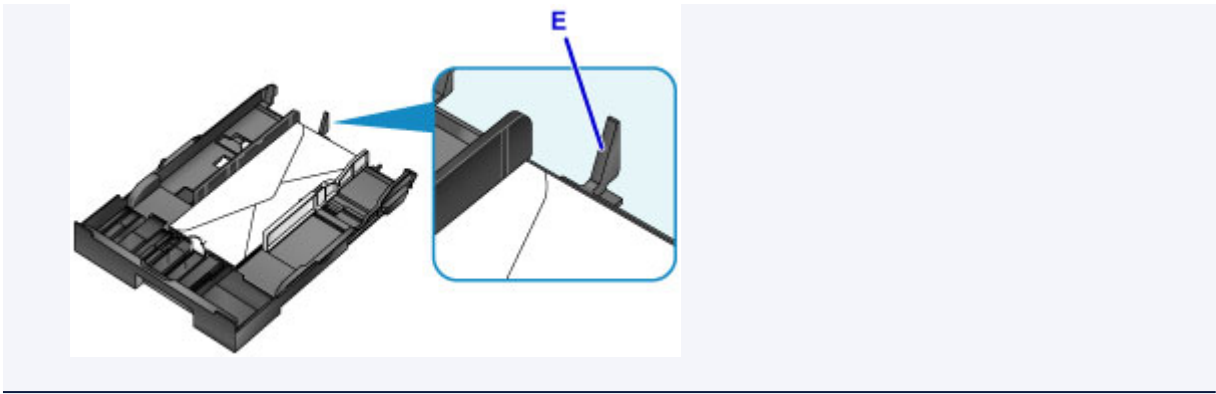

5. Align the paper guide (A) in front with the envelopes.

6. Slide the paper guide (B) on the right to align the right and left guides with both sides of the envelopes.

Do not slide the paper guides too hard against the envelopes. The envelopes may not be fed properly.

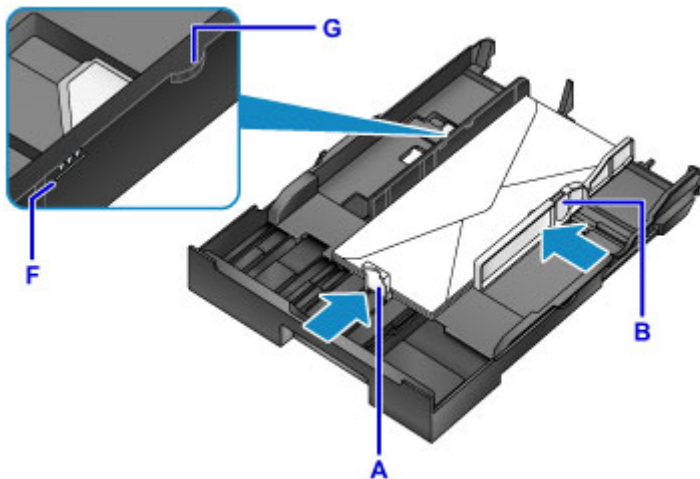

▶▶▶ Note

- Do not load envelopes higher than the load limit mark (F).
- Keep the envelope stack height below the tabs (G) of the paper guides.

7. Insert the cassette into the machine.

Push the cassette into the machine until it stops.

After inserting the cassette into the machine, the paper information registration screen for the cassette is displayed on the touch screen.



8. Select the size and type of the loaded envelopes in the cassette at **Page size** and **Type**, then tap **Register**.

■ [Paper setting for Printing](#)

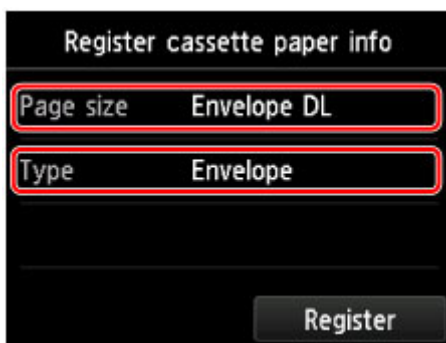

9. Extend the output tray extension (H), then open the paper output support (I).

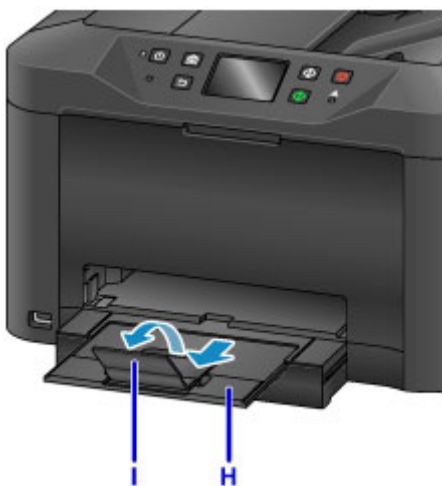

▶▶ Note

- When printing, select the size and type of the loaded envelopes on the print settings screen of the printer driver.

Media Types You Can Use

To get the best printing result, choose paper suitable for printing. Canon provides various types of paper suitable for documents as well as paper suitable for photos or illustrations. We recommend the use of Canon genuine paper for printing your important photos.

Media Types

Commercially available papers

- Plain Paper (including recycled paper)
- Envelopes*[1](#)

Canon genuine papers

The Model Number of Canon genuine paper is shown in brackets. Refer to the instruction manual supplied with the paper for detailed information on the printable side and notes on handling paper. For information on the page sizes available for each Canon genuine paper, access our website.

▶▶▶ Note

- You may not be able to purchase some Canon genuine papers depending on the country or region of purchase. Paper is not sold in the US by Model Number. Purchase paper by name.

Paper for printing photos:

- Glossy Photo Paper "Everyday Use" <GP-501/GP-601>
- Photo Paper Glossy <GP-601>
- Photo Paper Plus Glossy II <PP-201>
- Photo Paper Pro Luster <LU-101>
- Photo Paper Plus Semi-gloss <SG-201>
- Matte Photo Paper <MP-101>

Paper for printing business documents:

- High Resolution Paper <HR-101N>*[1](#)

*1 Printing to this paper from the operation panel is not supported.

■ [Paper Load Limit](#)

■ [Paper Settings on the Printer Driver and the Printer \(Media Type\)](#)

Page Sizes

You can use the following page sizes.

▶▶▶ Note

- Printing on the envelopes from the operation panel is not supported.

Standard sizes:

- Letter
- Legal
- A5
- A4

- B5
- 4" x 6" (10 x 15 cm)
- 5" x 7" (13 x 18 cm)
- 8" x 10" (20 x 25 cm)
- Envelope DL
- Envelope Com 10

Non-standard sizes:

You can print on non-standard size paper within the following ranges.

- Minimum size: 3.50 x 5.00 inches (89.0 x 127.0 mm)
- Maximum size: 8.50 x 14.00 inches (215.9 x 355.6 mm)

Paper Weight

You can use paper in the following weight range.

- 17 to 28 lb (64 to 105 g /m²) (plain paper except for Canon genuine paper)

Do not use heavier or lighter paper (except for Canon genuine paper), as it could jam in the machine.

Notes on Storing Paper

- Take out only the necessary number of paper from the package, just before printing.
- To avoid curling, when you do not print, put unused paper back into the package and keep it on a level surface. And also, store it avoiding heat, humidity, and direct sunlight.

Paper Load Limit

Commercially Available Papers

Media Name	Cassette	Paper Output Tray
Plain Paper (including recycled paper)*1	Approx. 250 sheets	Approx. 75 sheets
Envelopes	10 envelopes	*2

Canon Genuine Papers

▶▶▶ Note

- We recommend that you remove the previously printed sheet from the paper output tray before continuously printing to avoid blurs and discoloration (except for High Resolution Paper <HR-101N>).

Paper for printing photos:

Media Name <Model No.>	Cassette
Glossy Photo Paper "Everyday Use" <GP-501/GP-601>*3	10 sheets: A4 and Letter 20 sheets: 4" x 6" (10 x 15 cm)
Photo Paper Glossy <GP-601>*3	10 sheets: A4 and Letter 20 sheets: 4" x 6" (10 x 15 cm)
Photo Paper Plus Glossy II <PP-201>*3	10 sheets: A4, Letter, 5" x 7" (13 x 18 cm), and 8" x 10" (20 x 25 cm) 20 sheets: 4" x 6" (10 x 15 cm)
Photo Paper Pro Luster <LU-101>*3	10 sheets: A4 and Letter
Photo Paper Plus Semi-gloss <SG-201>*3	10 sheets: A4, Letter, 5" x 7" (13 x 18 cm), and 8" x 10" (20 x 25 cm) 20 sheets: 4" x 6" (10 x 15 cm)
Matte Photo Paper <MP-101>	10 sheets: A4 and Letter 20 sheets: 4" x 6" (10 x 15 cm)

Paper for printing business documents:

Media Name <Model No.>	Cassette	Paper Output Tray
High Resolution Paper <HR-101N>	65 sheets	65 sheets

*1 Proper feeding of paper may not be possible at the maximum capacity depending on the type of paper or environmental conditions (either very high or low temperature or humidity). In such cases, reduce the number of paper you load at a time to less than half.

*2 We recommend that you remove the previously printed envelope from the paper output tray before continuously printing to avoid blurs and discoloration.

*3 When loading paper in stacks, the print side may become marked as it is fed or paper may not feed properly. In this case, load one sheet at a time.

Media Types You Cannot Use

Do not use the following types of paper. Using such paper will cause not only unsatisfactory results, but also the machine to jam or malfunction.

- Folded, curled, or wrinkled paper
- Damp paper
- Paper that is too thin (weighing less than 17 lb (64 g /m²))
- Paper that is too thick (plain paper weighing more than 28 lb (105 g /m²), except for Canon genuine paper)
- Paper thinner than a postcard, including plain paper or notepad paper cut to a small size (when printing on paper smaller than A5)
- Picture postcards
- Postcards affixed with photos or stickers
- Envelopes with a double flap
- Envelopes with an embossed or treated surface
- Envelopes whose gummed flaps are already moistened and adhesive
- Any type of paper with holes
- Paper that is not rectangular
- Paper bound with staples or glue
- Paper with adhesives
- Paper decorated with glitter, etc.

Printing Area

- ▶ **Printing Area**
- ▶ **Other Sizes than Letter, Legal, Envelopes**
- ▶ **Letter, Legal**
- ▶ **Envelopes**

Printing Area

To ensure the best print quality, the machine allows a margin along each edge of media. The actual printable area will be the area inside these margins.

Recommended printing area  : Canon recommends that you print within this area.

Printable area  : The area where it is possible to print. However, printing in this area can affect the print quality or the paper feed precision.

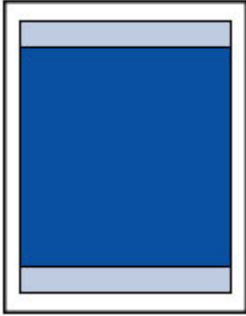

▶▶ Note

- With performing Automatic Duplex Printing and Duplex (Two-sided) Copying, the printable area will be 0.08 inch (2 mm) smaller at the top margin.

Other Sizes than Letter, Legal, Envelopes

Size	Printable Area (width x height)
A5	5.56 x 7.95 inches (141.2 x 202.0 mm)
A4	8.00 x 11.38 inches (203.2 x 289.0 mm)
B5	6.90 x 9.80 inches (175.2 x 249.0 mm)
4" x 6" (10 x 15 cm)	3.73 x 5.69 inches (94.8 x 144.4 mm)
5" x 7" (13 x 18 cm)	4.73 x 6.69 inches (120.2 x 169.8 mm)
8" x 10" (20 x 25 cm)	7.73 x 9.69 inches (196.4 x 246.0 mm)

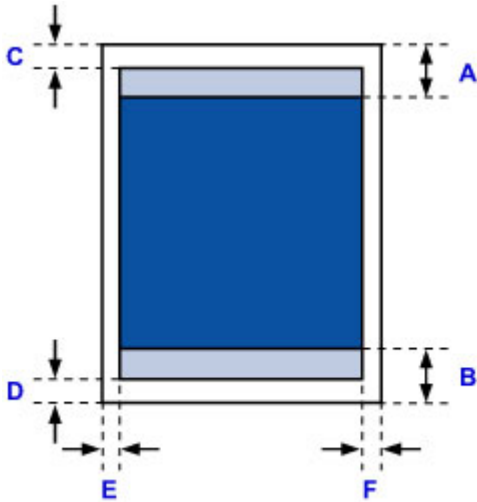

Recommended printing area

A: 1.80 inches (45.8 mm)

B: 1.45 inches (36.8 mm)

Printable area

C: 0.12 inch (3.0 mm)

D: 0.20 inch (5.0 mm)

E: 0.13 inch (3.4 mm)

F: 0.13 inch (3.4 mm)

Letter, Legal

Size	Printable Area (width x height)
Letter	8.00 x 10.69 inches (203.2 x 271.4 mm)
Legal	8.00 x 13.69 inches (203.2 x 347.6 mm)

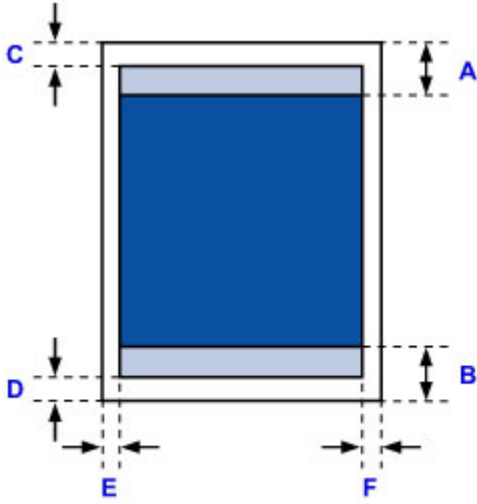

Recommended printing area

A: 1.80 inches (45.8 mm)

B: 1.45 inches (36.8 mm)

Printable area

C: 0.12 inch (3.0 mm)

D: 0.20 inch (5.0 mm)

E: 0.25 inch (6.4 mm)

F: 0.25 inch (6.3 mm)

Envelopes

Size	Recommended Printing Area (width x height)
Envelope DL	3.88 x 6.69 inches (98.8 x 170.0 mm)
Envelope Com 10	3.68 x 8.24 inches (93.5 x 209.3 mm)

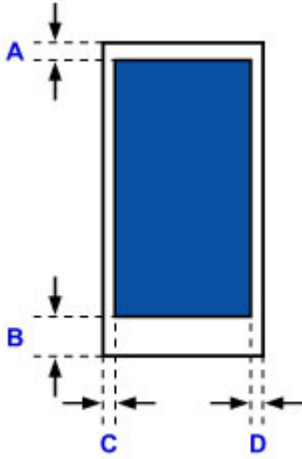

 Recommended printing area

Envelope DL

- A: 0.83 inch (21.0 mm)
- B: 1.14 inches (29.0 mm)
- C: 0.22 inch (5.6 mm)
- D: 0.22 inch (5.6 mm)

Envelope Com 10

- A: 0.12 inch (3.0 mm)
- B: 1.14 inches (29.0 mm)
- C: 0.22 inch (5.6 mm)
- D: 0.22 inch (5.6 mm)

Loading Originals

- ▶ **Position to Load Originals**
- ▶ **Loading Originals on the Platen Glass**
- ▶ **Loading Documents in the ADF (Auto Document Feeder)**
- ▶ **How to Load Originals for Each Function**
- ▶ **Originals You Can Load**

Position to Load Originals

The machine has two positions to load originals: platen glass and ADF (Auto Document Feeder).

Select the position to load the original according to the size, type, or usage.

■ [Originals You Can Load](#)

Loading Documents, Photos, or Book on the platen glass

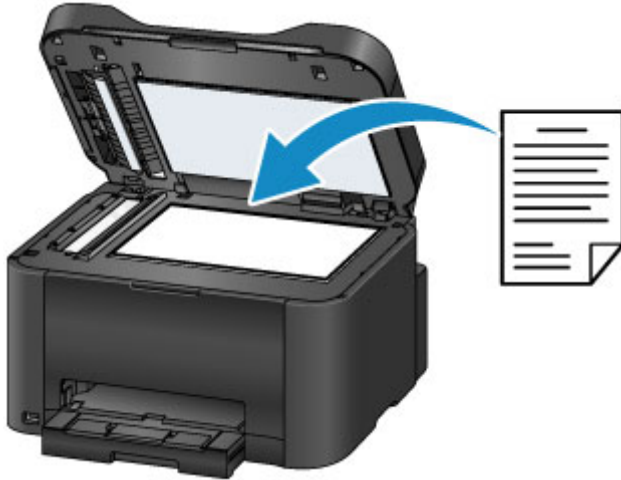

Loading Two or More Sheets of Document of the Same Size and Thickness in the ADF

You can also load a sheet of document in the ADF.

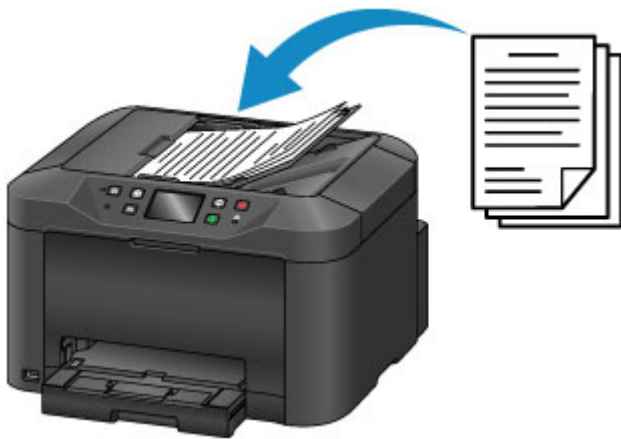

▶▶ Note

- To scan the original at optimum quality, load it on the platen glass.

Loading Originals on the Platen Glass

1. Open the document cover.

▶▶▶ Important

- When opening or closing the document cover, do not touch the buttons and touch screen on the operation panel. Doing so may result in an unexpected operation.

2. Load the original WITH THE SIDE TO SCAN FACING DOWN on the platen glass.

■ [Originals You Can Load](#)

■ [How to Load Originals for Each Function](#)



▶▶▶ Important

- Be sure to observe the following when loading the original on the platen glass.
 - Do not place any objects weighing 4.4 lb (2.0 kg) or more on the platen glass.
 - Do not put any pressure of 4.4 lb (2.0 kg) or more on the platen glass, such as pressing down the original.

Failure to observe the above may cause the scanner to malfunction or the platen glass to break.

3. Close the document cover gently.



▶▶▶ Important

- After loading the original on the platen glass, be sure to close the document cover before starting to copy, fax, or scan.

Loading Documents in the ADF (Auto Document Feeder)

▶▶▶ Note

- To scan a document at optimum quality, load it on the platen glass.

1. Make sure that any original has been removed from the platen glass.
2. Open the document tray.



3. Insert the document in the document tray until you hear a beep sound.

Load the document WITH THE SIDE TO SCAN FACING UP in the document tray.

■ [Originals You Can Load](#)

▶▶▶ Note

- When you set the alarm to be silent in **Sound control** of **Device user settings**, the alarm will not beep even if the document is inserted in the document tray.

■ [Device user settings](#)

4. Adjust the document guides (A) to match the width of the document.

Do not slide the document guides too hard against the document. The document may not be fed properly.

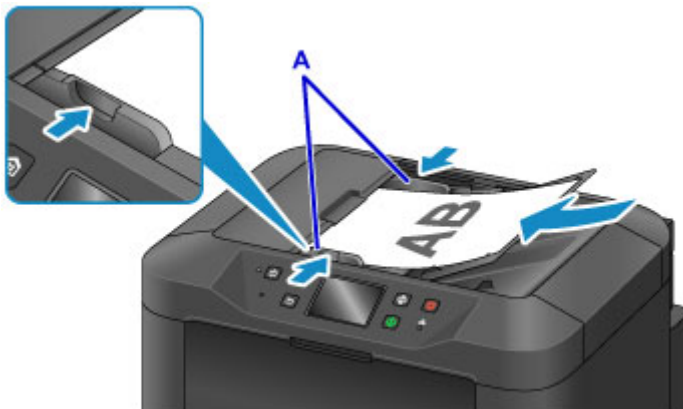

How to Load Originals for Each Function

Load the original in the correct position according to the function to use. If you do not load the original correctly, it may not be scanned properly.

Loading the Original to Be Aligned with the alignment mark

- Load originals to copy or fax
- Select **Document** or **Photo** for **Doc.type** in **Scan** and specify a standard size (A4, Letter, etc.) for **Scan size**
- With a software application on a computer,
 - scan text documents, magazines, or newspapers
 - select a standard size (A4, Letter, etc.) to scan originals

Place the original WITH THE SIDE TO SCAN FACING DOWN on the platen glass and align it with the alignment mark . Portions placed on the diagonally striped area cannot be scanned.

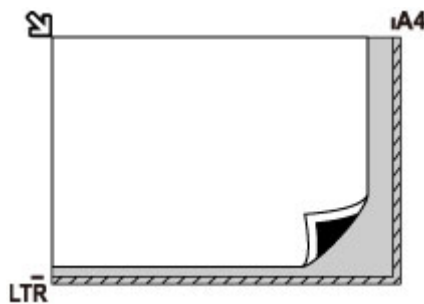

Important

- The machine cannot scan the striped area (A) (0.04 inch (1 mm) from the edges of the platen glass).

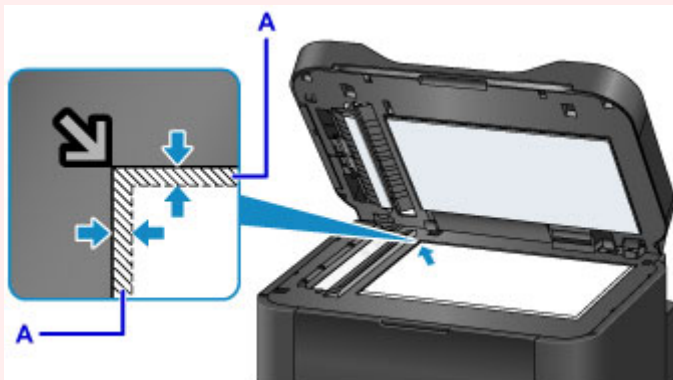

Loading Only One Original in the Center of the platen glass

- Select **Photo** for **Doc.type** in **Scan**, and specify **Auto scan** for **Scan size** to scan one original
- Scan one printed photo, postcard, business card, or disc with a software application on a computer

Place the original WITH THE SIDE TO SCAN FACING DOWN, with 0.4 inch (1 cm) or more space between the edges (diagonally striped area) of the platen glass. Portions placed on the diagonally striped area cannot be scanned.

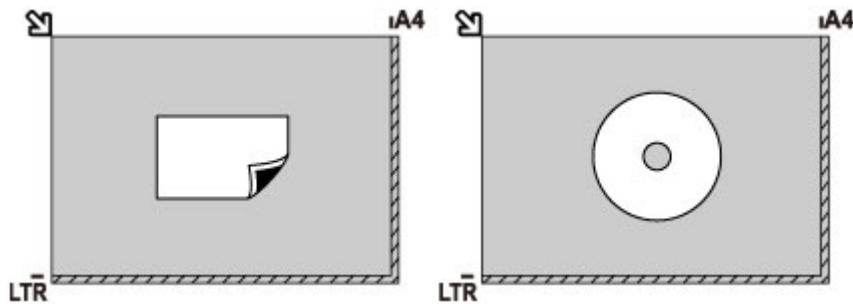

Loading Two or More Originals on the platen glass

- Select **Photo** for **Doc.type** in **Scan**, and specify **Auto multi scan** for **Scan size** to scan two or more originals
- Scan two or more printed photos, postcards, or business cards with a software application on a computer

Place the originals WITH THE SIDE TO SCAN FACING DOWN. Allow 0.4 inch (1 cm) or more space between the edges (diagonally striped area) of the platen glass and the originals, and between the originals. Portions placed on the diagonally striped area cannot be scanned.

You can place up to 12 items.

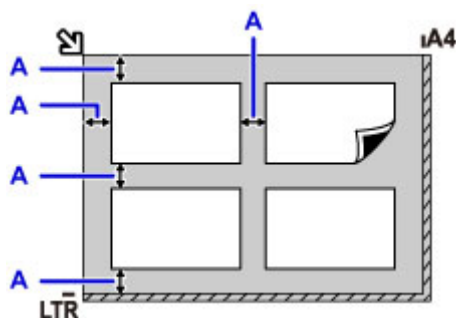

A: More than 0.4 inch (1 cm)

►► Note

- The Skew Correction function automatically compensates for the originals placed at an angle of up to approximately 10 degrees. Slanted photos with a long edge of 7.1 inches (180 mm) or more cannot be corrected.
- Non-rectangular or irregular shaped photos (such as cut out photos) may not be scanned properly.

Originals You Can Load

platen glass

Item	Details
Types of originals	<ul style="list-style-type: none"> - Text document, magazine, or newspaper - Printed photo, postcard, business card, or disc (BD/DVD/CD, etc.) - Documents that are not suitable for the ADF
Size (width x height)	Max. 8.5 x 11.7 inches (216 x 297 mm)
Quantity	1 sheet or multiple sheets*
Thickness	Max. 0.12 inch (3.1 mm)

* Two or more originals can be loaded on the platen glass depending on the selected function.

■ [How to Load Originals for Each Function](#)

ADF (Auto Document Feeder)

Item	Details
Types of originals	Multipage plain-paper documents of the same size, thickness, and weight
Size (width x height)	<ul style="list-style-type: none"> - Max. 8.5 x 14.0 inches (216 x 356 mm) - Min. 5.8 x 5.8 inches (148 x 148 mm) <p>Only A4 or Letter-sized documents for two-sided copy, 2-on-1 copy, and 4-on-1 copy</p>
Quantity	<ul style="list-style-type: none"> - A4 or Letter size: Max. 50 sheets (20 lb (75 g /m²) paper), up to 0.20 inch (5 mm) in height - Legal size: Max. 10 sheets (20 lb (75 g /m²) paper), up to 0.04 inch (1 mm) in height - Other sizes: 1 sheet
Thickness	0.003 to 0.005 inch (0.07 to 0.13 mm)
Weight	16.0 to 25.3 lb (60 to 95 g /m ²)

➤➤➤ Note

- Make sure any glue, ink, correction fluid, or the like on the document is completely dry before loading it on the platen glass or in the ADF.

However, do not load glued documents in the ADF even if the glue is dry, as this may cause paper jams.

- Remove all staples, paper clips, and the like before feeding the document.
- Load Legal-sized documents in the ADF.
- Do not load the following types of documents in the ADF. They will jam.
 - Wrinkled or creased paper
 - Curled paper
 - Torn paper
 - Paper with holes
 - Glued paper

- Paper with sticky notes
 - Carbon paper or carbon-backed paper
 - Surface treated paper
 - Onion skin or thin paper
 - Photo or thick paper
-

Inserting the USB Flash Drive

- [Inserting the USB Flash Drive](#)
- [Removing the USB Flash Drive](#)

Inserting the USB Flash Drive

Printable Image Data

- This machine accepts images taken with a camera compliant with the Design rule for Camera File system (Exif 2.2/2.21/2.3 compliant), TIFF (Exif 2.2/2.21/2.3 compliant). Other image or movie types such as RAW images cannot be printed.
- The machine accepts images scanned and saved with the machine when **Doc.type** is set to **Photo** and **Format** is set to **JPEG** (file extension ".jpg").

▶▶▶ Note

- This device incorporates exFAT technology licensed from Microsoft.
- If your USB flash drive cannot be inserted into the USB flash drive port of the machine, you may be required to use an extension cable for the USB flash drive. Purchase it at electronics retail stores.
- Some USB flash drives may have recognition problem, and these devices may not guarantee proper operation of the machine.
- You may not be able to use USB flash drives with security function.

1. Insert the USB flash drive into the USB flash drive port.

Make sure that the USB flash drive is correctly oriented before inserting it straightforward into the USB flash drive port.

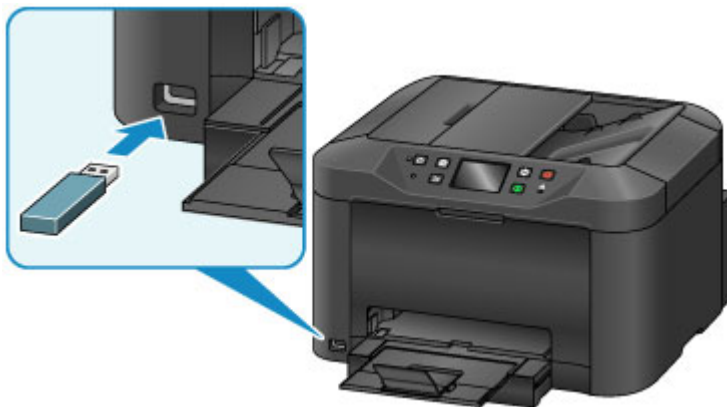

Removing the USB Flash Drive

1. Make sure that the machine is not reading or writing data from/to the USB flash drive.

A message is displayed on the touch screen during such operations.

Important

- Do not remove the USB flash drive or turn off the power while the machine is reading or writing data from/to it.

Note

- If your USB flash drive has the access lamp, refer to the instruction manual supplied with the USB flash drive to check if the reading or writing operation is completed on the USB flash drive.

2. Remove the USB flash drive.

Hold the USB flash drive and remove it straightforward from the machine.

Replacing an Ink Tank

- [Replacing an Ink Tank](#)
- [Checking the Ink Status](#)

Replacing an Ink Tank

When remaining ink cautions or errors occur, the message will appear on the touch screen to inform you of the error. Take appropriate action according to the message.

■ [A Message Is Displayed](#)

▶▶▶ Note

- If print results become faint or white streaks appear despite sufficient ink levels, see [Maintenance Procedure](#).

Replacing Procedure

When you need to replace an ink tank, follow the procedure below.

▶▶▶ Important

- If you remove an ink tank, replace it immediately. Do not leave the machine with the ink tank removed.
- Use a new ink tank for replacement. Installing a used ink tank may cause the nozzles to clog. Furthermore, with such an ink tank, the machine will not be able to inform you when to replace the ink tank properly.
- Once an ink tank has been installed, do not remove it from the machine and leave it out in the open. This will cause the ink tank to dry out, and the machine may not operate properly when it is reinstalled. To maintain optimal printing quality, use an ink tank within six months of first use.

▶▶▶ Note

- Color ink may be consumed even when printing a black-and-white document or when black-and-white printing is specified.

Every ink is also consumed in the standard cleaning and deep cleaning of the print head, which may be necessary to maintain the performance of the machine. When an ink tank is out of ink, replace it immediately with a new one.

■ [Useful Information about Ink](#)

1. Make sure that the power is turned on, then open the front cover.

The replaceable ink tank is displayed on the touch screen and the print head holder (A) moves to the replacement position of that ink tank.

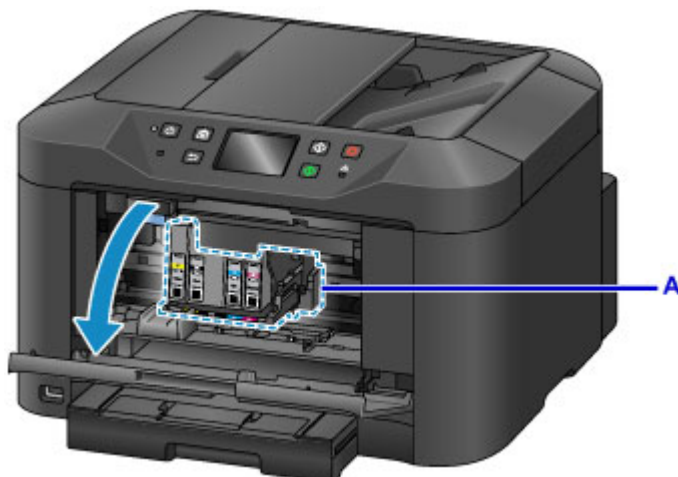

Caution

- Do not hold the print head holder to stop or move it forcibly. Do not touch the print head holder until it stops completely.

Important

- Do not remove an ink tank until a new one is prepared to be installed.
 - Once you remove an ink tank, the machine will not operate until a new one is installed.
 - Once you remove an ink tank, the machine will not operate even if the removed ink tank is just reinstalled.
- You cannot remove the ink tank which is not placed at the replacement position. Removing it forcibly may cause the machine to malfunction or damage the machine.
- Do not touch the metallic parts or other parts inside the machine.
- If the front cover is left open for more than 60 minutes, the print head holder moves to the right. In this case, close and reopen the front cover.

Note

- If the message for the ink tank replacement is displayed on the touch screen, check it and then tap **OK**.

2. When an ink tank for replacement is displayed on the touch screen, push up the ink tank eject lever (B).

The ink tank will be ejected.

When you want to replace another ink tank, tap **Next** to display the screen for the ink tank to replace.

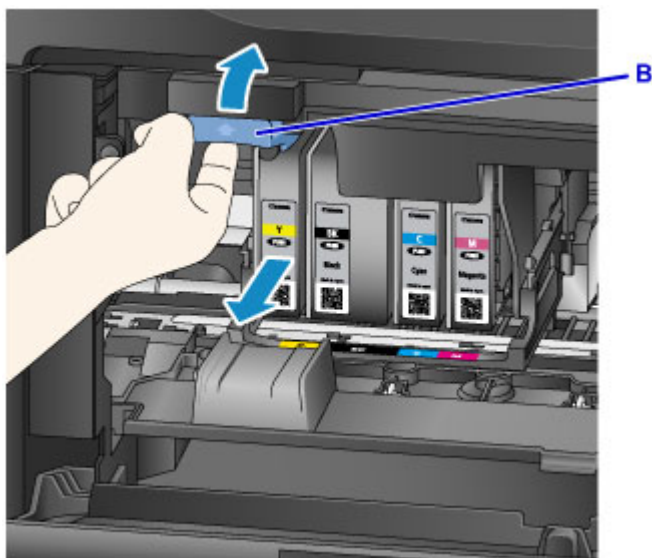

Important

- Place the removed ink tank into a plastic bag immediately after removing from the machine. Otherwise, ink residue may stain your clothes or the surrounding area.
- Do not touch other parts besides the ink tanks.
- Discard the empty ink tank according to the local laws and regulations regarding disposal of consumables.
- Handle the ink tanks carefully. Do not drop or apply excessive pressure to them.

3. Remove the ink tank from the package.

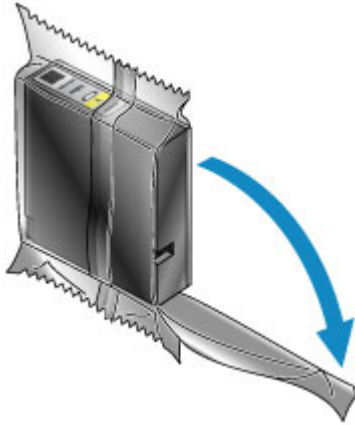

»» Important

- Do not touch the contact (C) and joint (D) of the ink tank.

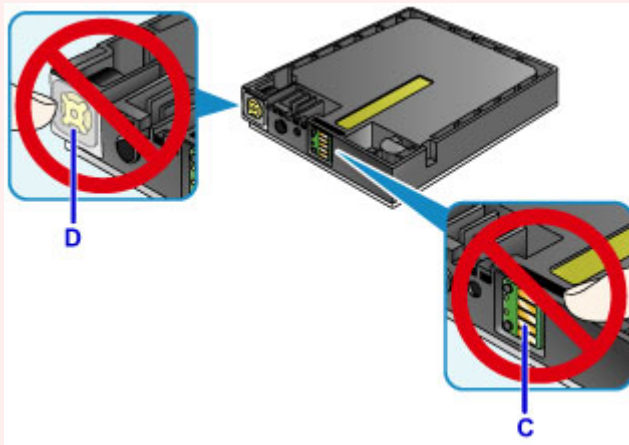

4. Insert a new ink tank aligning it with the installation guide (E) of the machine.

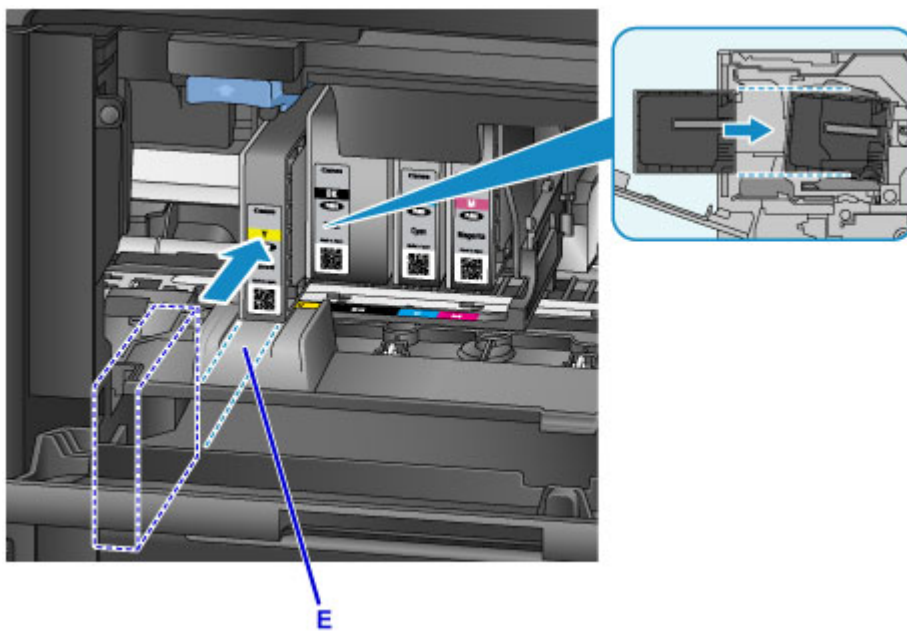

»» Important

- You cannot insert the ink tank in the wrong position. Check the label under the installation position, then install the ink tank in the correct position.

5. Push the ink tank until it snaps firmly into place.

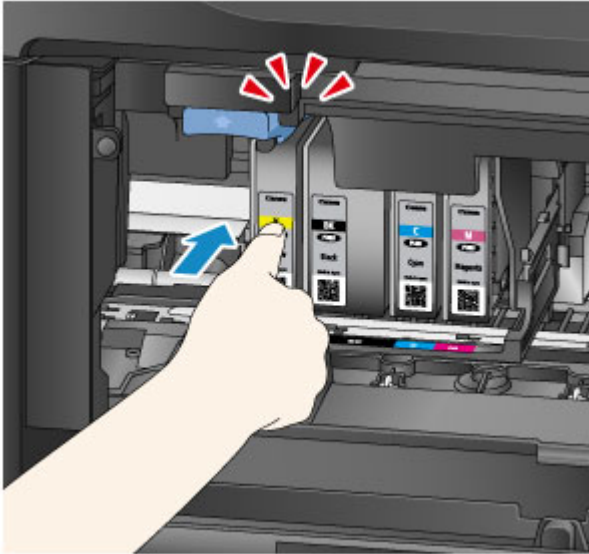

6. Tap **Exit** on the touch screen.

If **Next** is displayed on the screen, it means there is another ink tank that can be replaced.

If you want to replace this ink tank, tap **Next** and then repeat procedures from step 2.

To exit the ink tank replacement, tap **Next** until **Exit** is displayed on the screen.

The print head holder moves to the standby position. You cannot remove the ink tank while at this position.

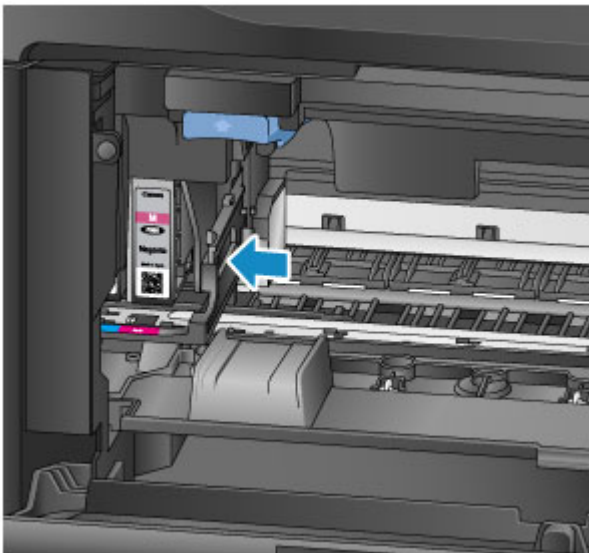

»» Important

- You cannot print unless all the ink tanks are installed. Be sure to install all the ink tanks.
- An installed ink tank cannot be removed until the message to replace it is displayed.

7. Close the front cover.



After replacing the ink tanks, the machine starts mixing the ink automatically. Wait until the machine has stopped making operating noise. (This takes about 1 to 2 minutes.)

▶▶▶ Note

- If the error message appears on the touch screen, take appropriate action.
 - [A Message Is Displayed](#)
- If the print head is out of alignment, as indicated by misaligned printed ruled lines or similar symptoms, [align the print head](#).
- The machine may make noise during operation.

Checking the Ink Status

- ▶ **Checking the Ink Status with the Touch Screen on the Machine**

You can also check the ink status on the computer screen.

- ▶ **Checking the Ink Status from Your Computer**

Checking the Ink Status with the Touch Screen on the Machine

1. Make sure that the power is turned on, and display the HOME screen.

If the HOME screen is not displayed, press the **HOME** button to display it.

2. Tap  on the HOME screen.

[Using the Operation Panel](#)

A symbol appears in the area (A) if there is any information about the remaining ink level.

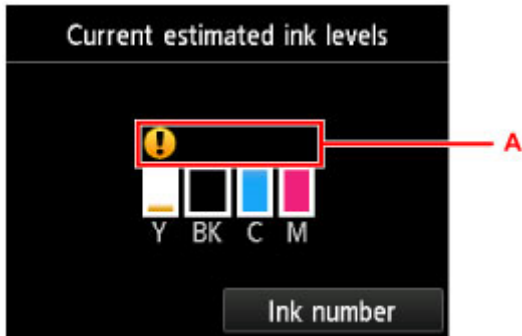

Example: 

Ink tank is running low. Prepare a new ink tank.

Note

- The above screen shows estimated ink levels.
- The **Current estimated ink levels** screen can also be displayed by tapping **Setup** in the HOME screen and selecting **Estimated ink levels** in the setup menu.
- Tap **Ink number** to display and print the model number of the ink tank.
- You can also check the ink status on a screen of the touch screen displayed while printing.
- You can also check the ink status on the computer screen.

[Checking the Ink Status from Your Computer](#)

Maintenance

- **When Printing Becomes Faint or Colors Are Incorrect**
- **Performing Maintenance from a Computer**
- **Cleaning the Machine**

When Printing Becomes Faint or Colors Are Incorrect

- **Maintenance Procedure**
- **Printing the Nozzle Check Pattern**
- **Examining the Nozzle Check Pattern**
- **Cleaning the Print Head**
- **Cleaning the Print Head Deeply**
- **Aligning the Print Head**
- **Aligning the Print Head Manually**

Maintenance Procedure

If print results are blurred, colors are not printed correctly, or print results are unsatisfactory (e.g. misaligned printed ruled lines), perform the maintenance procedure below.

►►► Note

- Increasing the print quality in the printer driver settings may improve the print result.

- [Changing the Print Quality and Correcting Image Data](#)

When the Print Results Are Blurred or Uneven:

|| Step1 Print the nozzle check pattern.

From the machine

- [Printing the Nozzle Check Pattern](#)

From the computer

- [Use Your Computer to Print a Nozzle Check Pattern](#)

|| Step2 [Examine the nozzle check pattern.](#)

If there are missing lines or horizontal white streaks in the pattern:



|| Step3 Clean the print head.

From the machine

- [Cleaning the Print Head](#)

From the computer

- [Cleaning the Print Heads from Your Computer](#)

After cleaning the print head, print and examine the nozzle check pattern: ➔ [Step1](#)

If the problem is not resolved after performing from step 1 to step 3 twice:



|| Step4 Clean the print head deeply.

From the machine

- [Cleaning the Print Head Deeply](#)

From the computer

- [Cleaning the Print Heads from Your Computer](#)

►►► Note

- When you have performed the procedure until step 4 and the problem has not been resolved, turn off the power and clean the print head deeply again after 24 hours. Do not unplug the power cord when turning off the power.

If the problem is still not resolved, the print head may be damaged. Contact the service center.

When the Print Results Are Not Even such as the Ruled Lines Are Misaligned:

|| Step | Align the print head.

From the machine

■ [Aligning the Print Head](#)

From the computer

■ [Aligning the Print Head Position from Your Computer](#)

Printing the Nozzle Check Pattern

Print the nozzle check pattern to determine whether the ink ejects properly from the print head nozzle.

▶▶▶ Note

- When the ink has run out during printing the nozzle check pattern, the error message will appear on the touch screen.

■ [A Message Is Displayed](#)

You need to prepare: a sheet of A4 or Letter-sized plain paper

1. Make sure that the power is turned on.
2. Load a sheet of A4 or Letter-sized plain paper in the cassette.

After inserting the cassette into the machine, the paper information registration screen is displayed on the touch screen. Select **A4** or **Letter** for **Page size** and **Plain paper** for **Type**, then tap **Register**.

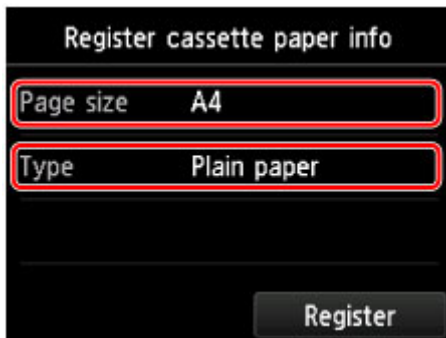

If a message is displayed on the screen, follow the directions in the message to complete registration.

3. Extend the output tray extension, then open the paper output support.

4. Flick the HOME screen, then tap  **Setup**.

■ [Using the Operation Panel](#)

The setup menu screen will appear.

5. Tap  **Maintenance**.

The **Maintenance** screen will appear.

6. Tap **Print nozzle check pattern**.

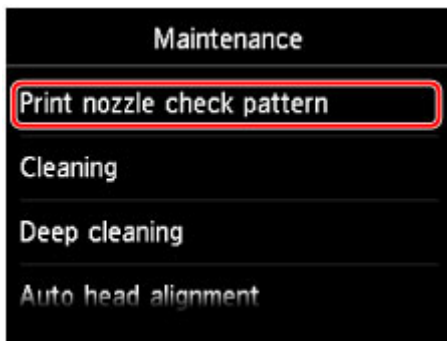

The confirmation screen will appear.

7. Tap **Yes**.

The nozzle check pattern will be printed and two pattern confirmation screens will appear on the touch screen.

8. [Examine the nozzle check pattern.](#)

Examining the Nozzle Check Pattern

Examine the nozzle check pattern, and clean the print head if necessary.

1. Check if there are missing lines in the pattern C or horizontal white streaks in the pattern D.

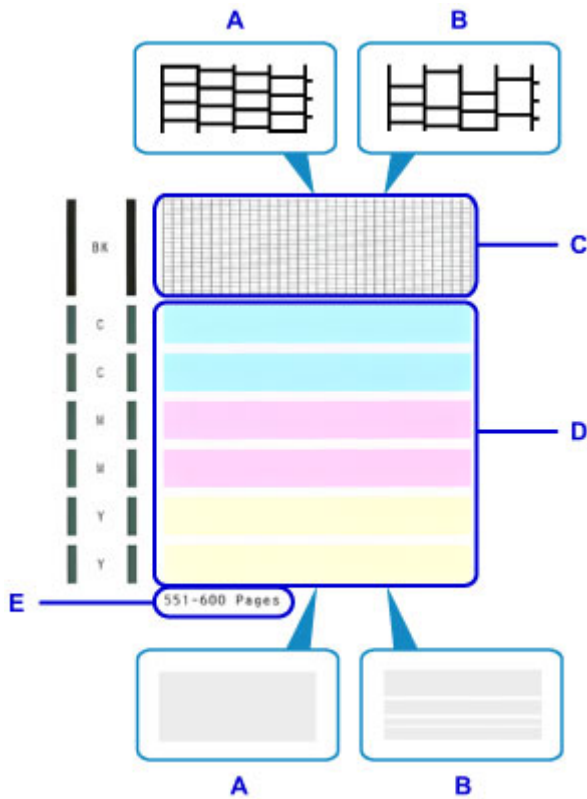

- A: No missing lines/No horizontal white streaks
- B: Lines are missing/Horizontal white streaks are present
- E: Number of sheets printed so far

2. Select the pattern that is closer to the printed nozzle check pattern on the confirmation screen.

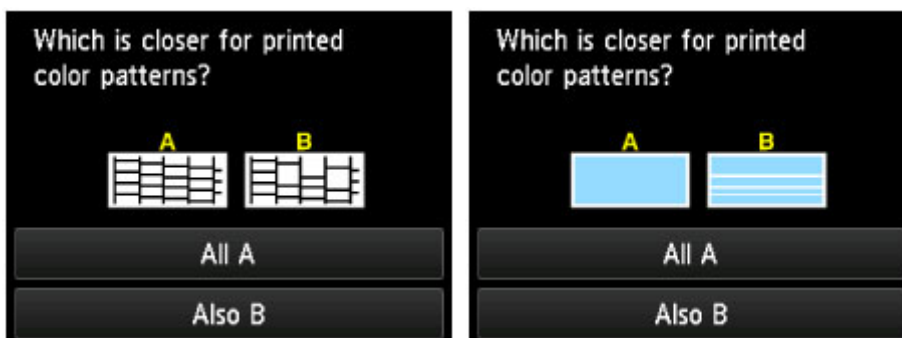

For A (no missing lines or no horizontal white streaks) in both the pattern C and pattern D:

The cleaning is not required. Tap **All A**, confirm the message, then tap **OK**.

The screen will return to the **Maintenance** screen.

For B (lines are missing or horizontal white streaks are present) in the pattern C or pattern D, or in both patterns:

The cleaning is required. Tap **Also B**, then tap **Yes** on the cleaning confirmation screen.

The machine starts cleaning the print head.

■ [Cleaning the Print Head](#)

▶▶▶ Note

- The total number of sheets printed so far is shown in increments of 50 sheets on the printout of the nozzle check pattern.

Cleaning the Print Head

Clean the print head if lines are missing or if horizontal white streaks are present in the printed nozzle check pattern. Cleaning unclogs the nozzles and restores the print head condition. Cleaning the print head consumes ink, so clean the print head only when necessary.

▶▶▶ Note

- You can also clean the print head using the computer. When using the computer, select the ink group to clean, then start cleaning.
 - [Cleaning the Print Heads from Your Computer](#)
- When cleaning the print head using the operation panel, the print head of all ink colors are cleaned.

You need to prepare: a sheet of A4 or Letter-sized plain paper

1. Make sure that the power is turned on.
2. Load a sheet of A4 or Letter-sized plain paper in the cassette.

After inserting the cassette into the machine, the paper information registration screen is displayed on the touch screen. Select **A4** or **Letter** for **Page size** and **Plain paper** for **Type**, then tap **Register**.

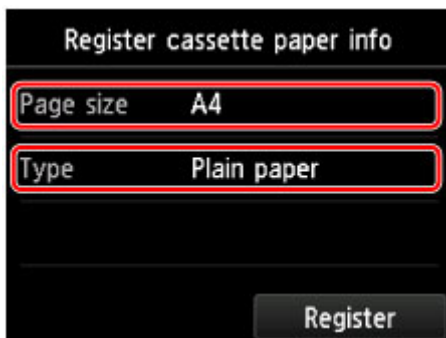

If a message is displayed on the screen, follow the directions in the message to complete registration.

3. Extend the output tray extension, then open the paper output support.

4. Flick the HOME screen, then tap  **Setup**.

■ [Using the Operation Panel](#)

The setup menu screen will appear.

5. Tap  **Maintenance**.

The **Maintenance** screen will appear.

6. Tap **Cleaning**.



The confirmation screen will appear.

7. Tap **Yes**.

The machine starts cleaning the print head.

Do not perform any other operations until the machine completes the cleaning of the print head. This takes about 2 minutes.

The pattern print confirmation screen will appear.

8. Tap **Yes**.

The nozzle check pattern will be printed.

9. [Examine the nozzle check pattern](#).

▶▶▶ **Note**

- If the problem is not resolved after cleaning the print head twice, [clean the print head deeply](#).

Cleaning the Print Head Deeply

If print quality does not improve by the standard cleaning of the print head, clean the print head deeply. Cleaning the print head deeply consumes more ink than the standard cleaning of the print head, so clean the print head deeply only when necessary.

▶▶▶ Note

- You can also clean the print head deeply using the computer. When using the computer, select the ink group to clean, then start the deep cleaning.
 - [Cleaning the Print Heads from Your Computer](#)
- When cleaning the print head deeply using the operation panel, the print head of all ink colors are cleaned.

You need to prepare: a sheet of A4 or Letter-sized plain paper

1. Make sure that the power is turned on.
2. Load a sheet of A4 or Letter-sized plain paper in the cassette.

After inserting the cassette into the machine, the paper information registration screen is displayed on the touch screen. Select **A4** or **Letter** for **Page size** and **Plain paper** for **Type**, then tap **Register**.

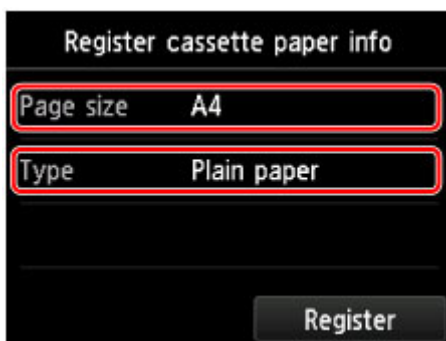

If a message is displayed on the screen, follow the directions in the message to complete registration.

3. Extend the output tray extension, then open the paper output support.

4. Flick the HOME screen, then tap  **Setup**.

■ [Using the Operation Panel](#)

The setup menu screen will appear.

5. Tap  **Maintenance**.

The **Maintenance** screen will appear.

6. Tap **Deep cleaning**.

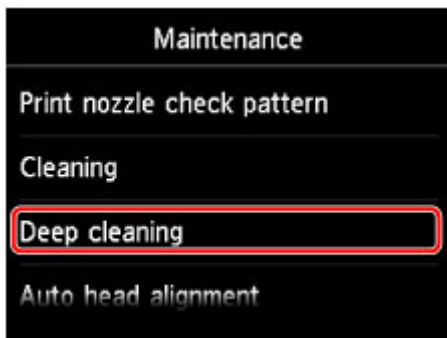

The confirmation screen will appear.

7. Tap **Yes**.

The machine starts cleaning the print head deeply.

Do not perform any other operations until the machine completes the deep cleaning of the print head. This takes about 2 to 3 minutes.

The pattern print confirmation screen will appear.

8. Tap **Yes**.

The nozzle check pattern will be printed.

9. When the completion message appears, tap **OK**.

10. [Examine the nozzle check pattern](#).

If the problem is not resolved, turn off the power and clean the print head deeply again after 24 hours. Do not unplug the power cord when turning off the power.

If the problem is still not resolved, the print head may be damaged. Contact the service center.

Aligning the Print Head

If printed ruled lines are misaligned or print results are otherwise unsatisfactory, adjust the print head position.

▶▶▶ Note

- When the ink has run out during printing the nozzle check pattern, the error message will appear on the touch screen.

■ [A Message Is Displayed](#)

You need to prepare: a sheet of A4 or Letter-sized plain paper (including recycled paper)*

* Be sure to use paper that is white and clean on both sides.

1. Make sure that the power is turned on.
2. Load a sheet of A4 or Letter-sized plain paper in the cassette.

After inserting the cassette into the machine, the paper information registration screen is displayed on the touch screen. Select **A4** or **Letter** for **Page size** and **Plain paper** for **Type**, then tap **Register**.

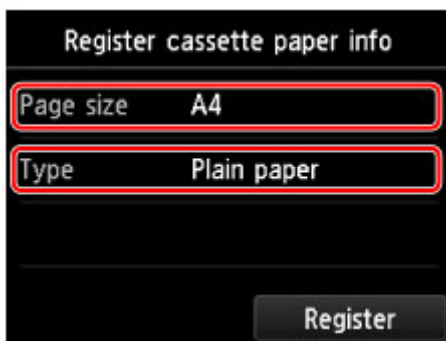

If a message is displayed on the screen, follow the directions in the message to complete registration.

3. Extend the output tray extension, then open the paper output support.

4. Flick the HOME screen, then tap  **Setup**.

■ [Using the Operation Panel](#)

The setup menu screen will appear.

5. Tap  **Maintenance**.

The **Maintenance** screen will appear.

6. Tap **Auto head alignment**.



The confirmation screen will appear.

7. Tap **Yes**.

The print head alignment sheet will be printed and the print head position will be adjusted automatically.

This takes about 3 to 4 minutes.

»» **Note**

- If the automatic adjustment of the print head position has failed, the error message appears on the touch screen.

■ [A Message Is Displayed](#)

8. When the completion message appears, tap **OK**.

»» **Note**

- If the print results are still not satisfactory after adjusting the print head position as described above, [align the print head manually](#).

You can also align the print head manually from a computer.

■ [Aligning the Print Head Position Manually from Your Computer](#)

Aligning the Print Head Manually

If printed ruled lines are misaligned or print results are still not satisfactory after adjusting the print head position automatically, adjust the print head position manually.

▶▶▶ Note

- For details on adjusting the print head position automatically, see [Aligning the Print Head](#).

You need to prepare: two sheets of A4 or Letter-sized plain paper

1. Make sure that the power is turned on.
2. Load two sheets of A4 or Letter-sized plain paper in the cassette.

After inserting the cassette into the machine, the paper information registration screen is displayed on the touch screen. Select **A4** or **Letter** for **Page size** and **Plain paper** for **Type**, then tap **Register**.

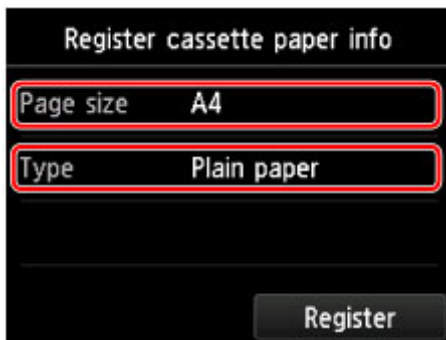

If a message is displayed on the screen, follow the directions in the message to complete registration.

3. Extend the output tray extension, then open the paper output support.

4. Flick the HOME screen, then tap  **Setup**.

■ [Using the Operation Panel](#)

The setup menu screen will appear.

5. Tap  **Maintenance**.

The **Maintenance** screen will appear.

6. Tap **Manual head alignment**.

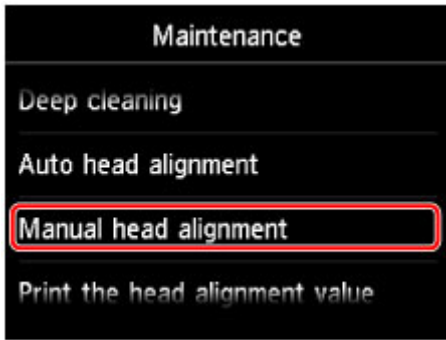

The confirmation screen will appear.

▶▶▶ **Note**

- To print and check the current head position adjustment values, select **Print the head alignment value**.

7. Tap **Yes**.

The print head alignment pattern is printed.

8. When the message "**Did the patterns print correctly?**" appears, confirm that the pattern is printed correctly, tap **Yes**.

9. Confirm the message, then tap **Next**.

The input screen for the head position adjustment values will appear.

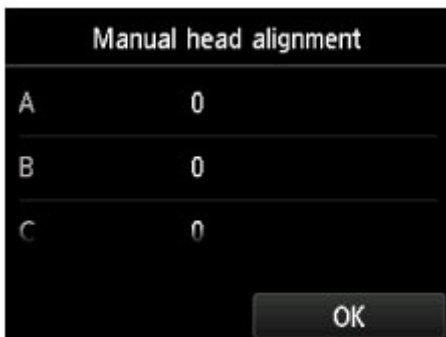

10. Look at the first pattern, tap A to check the printed patterns, then tap the number of the pattern in column A that has the least noticeable vertical streaks.

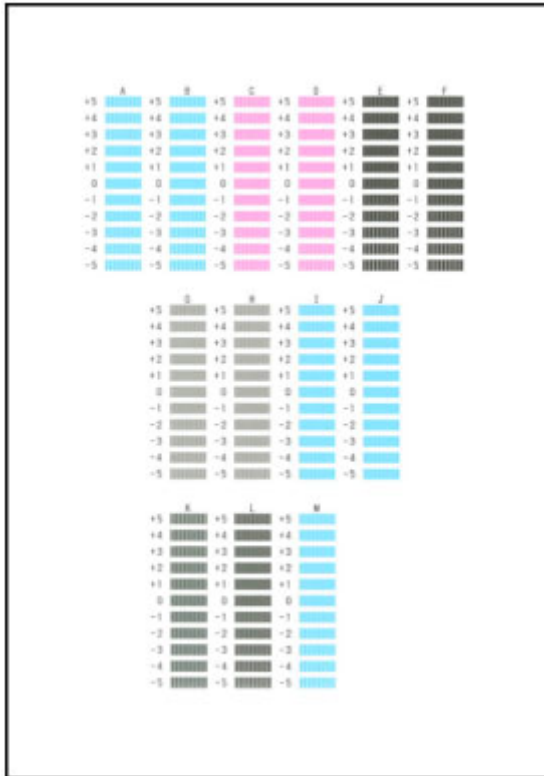

►►► **Note**

- If it is difficult to pick the best pattern, pick the setting that produces the least noticeable vertical streaks.

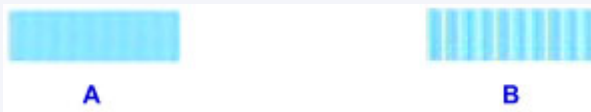

- A: Unnoticeable vertical streaks
- B: Noticeable vertical streaks

11. Repeat the same procedure until you finish inputting the pattern number for columns B to M, then tap **OK**.

12. Confirm the message, then tap **OK**.

The second pattern is printed.

13. Look at the second pattern, tap N to check the printed patterns, then tap the number of the pattern in column N that has the least noticeable horizontal streaks.

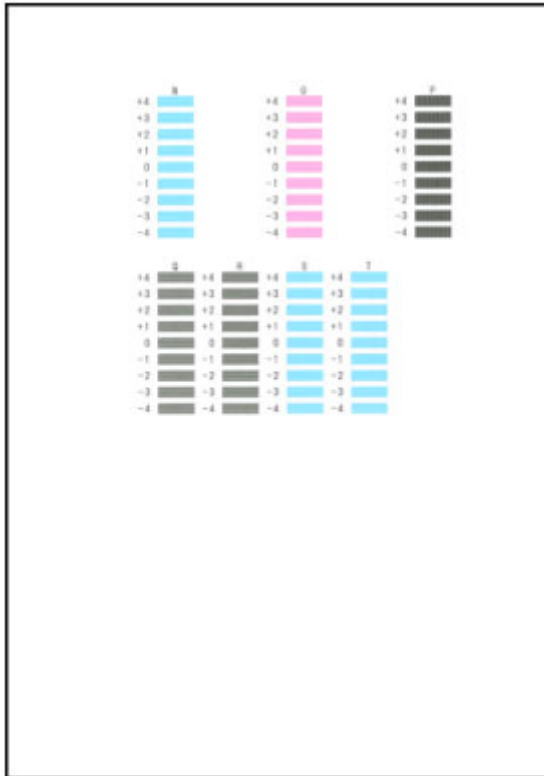

»» Note

- If it is difficult to pick the best pattern, pick the setting that produces the least noticeable horizontal streaks.

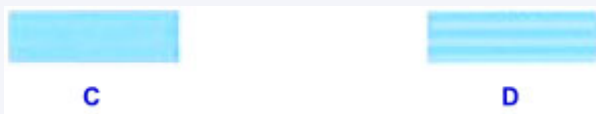

- C: Unnoticeable horizontal streaks
- D: Noticeable horizontal streaks

1. Repeat the same procedure until you finish inputting the pattern number for columns O to T, then tap **OK**.
For column P, pick the least noticeable vertical streaks.
2. Confirm the message, then tap **OK**.

Performing Maintenance from a Computer

- **Cleaning the Print Heads from Your Computer**
- **Use Your Computer to Print a Nozzle Check Pattern**
- **Aligning the Print Head Position from Your Computer**
- **Checking the Ink Status from Your Computer**

Cleaning the Print Heads from Your Computer

The print head cleaning function allows you to clear up clogged print head nozzle. Perform print head cleaning if printing is faint or a specific color fails to print, even though there is enough ink.

The procedure for cleaning the print head is as follows:



Cleaning

1. Select **Cleaning** from the pop-up menu on the [Canon IJ Printer Utility](#)

2. Click the **Cleaning** icon

When the dialog opens, select the ink group for which cleaning is to be performed.

Click  to display the items you need to check before performing cleaning.

3. Execute cleaning

Make sure that the printer is on and then click **OK**.

Print head cleaning starts.

4. Complete cleaning

The **Nozzle Check** dialog opens after the confirmation message.

5. Check the results

To check whether the print quality has improved, click **Print Check Pattern**. To cancel the check process, click **Cancel**.

If cleaning the head once does not resolve the print head problem, clean it once more.

»» Important

- **Cleaning** consumes a small amount of ink.
Cleaning the print head frequently will rapidly deplete your printer's ink supply. Consequently, perform cleaning only when necessary.



Deep Cleaning

Deep Cleaning is more thorough than cleaning. Perform deep cleaning when two **Cleaning** attempts do not resolve the print head problem.

1. Select **Cleaning** from the pop-up menu on the [Canon IJ Printer Utility](#)

2. Click the **Deep Cleaning** icon

When the dialog opens, select the ink group for which deep cleaning is to be performed.

Click  to display the items you need to check before performing deep cleaning.

3. Execute deep cleaning

Make sure that the printer is on and then click **OK**.

Click **OK** when the confirmation message appears.

Print head deep cleaning starts.

4. Complete deep cleaning

The **Nozzle Check** dialog opens after the confirmation message.

5. Check the results

To check whether the print quality has improved, click **Print Check Pattern**. To cancel the check process, click **Cancel**.

Important

- **Deep Cleaning** consumes a larger amount of ink than **Cleaning**.
Cleaning the print head frequently will rapidly deplete your printer's ink supply. Consequently, perform cleaning only when necessary.

Note

- If there is no sign of improvement after **Deep Cleaning**, turn off the printer, wait 24 hours, and then perform **Deep Cleaning** again. If there is still no sign of improvement, the ink may have run out or the print head may be worn. For details on the remedial action to be taken, see "[Ink Is Not Ejected](#)."

Related Topic

- [Use Your Computer to Print a Nozzle Check Pattern](#)

Use Your Computer to Print a Nozzle Check Pattern

The nozzle check function allows you to check whether the print head is working properly by printing a nozzle check pattern. Print the pattern if printing becomes faint, or if a specific color fails to print.

The procedure for printing a nozzle check pattern is as follows:



Nozzle Check

1. Select **Test Print** from the pop-up menu on the [Canon IJ Printer Utility](#)

2. Click the **Nozzle Check** icon

The confirmation message appears.

Click  to display the items that you need to check before printing the nozzle check pattern.

3. Load paper in the printer

Load one sheet of A4 size or Letter size plain paper into the cassette.

▶▶ Note

- If the cassette paper information registered on the printer is not set to A4 size and plain paper, an error may occur. For instructions on what to do if an error occurs, see "[Paper setting for Printing.](#)"
For details about the cassette paper information to be registered on the printer, see the following:
 - [Paper Settings on the Printer Driver and the Printer \(Media Type\)](#)
 - [Paper Settings on the Printer Driver and the Printer \(Paper Size\)](#)

4. Print a nozzle check pattern

Make sure that the printer is on and click **Print Check Pattern**.

Printing of the nozzle check pattern begins.

5. Check the print result

When the dialog opens, check the print result. If the print result is normal, click **Quit**.

If the print result is smudged or if there are any unprinted sections, click **Cleaning** to clean the print head.

Related Topic

- [Cleaning the Print Heads from Your Computer](#)

Aligning the Print Head Position from Your Computer

Print head alignment corrects the installation positions of the print head and improves deviated colors and lines.

This printer supports two head alignment methods: automatic head alignment and manual head alignment. Normally, the printer is set for automatic head alignment.

If the printing results of automatic print head alignment are not satisfactory, [perform manual head alignment](#).

The procedure for performing automatic print head alignment is as follows:



Print Head Alignment

1. Select **Test Print** from the pop-up menu on the [Canon IJ Printer Utility](#)

2. Click the **Print Head Alignment** icon

A message is displayed.

3. Load paper in the printer

Load one sheet of A4 size or Letter size plain paper into the cassette.

▶▶▶ Note

- The number of sheets to be used differs when you select the manual head alignment.
- If the cassette paper information registered on the printer is not set to A4 size and plain paper, an error may occur. For instructions on what to do if an error occurs, see "[Paper setting for Printing](#)."

For details about the cassette paper information to be registered on the printer, see the following:

- [Paper Settings on the Printer Driver and the Printer \(Media Type\)](#)
- [Paper Settings on the Printer Driver and the Printer \(Paper Size\)](#)

4. Execute head alignment

Make sure that the printer is on and click **Align Print Head**.

Print head alignment starts.

▶▶▶ Important

- Do not open the operation panel while printing is in progress.

▶▶▶ Note

- Wait until printing ends before performing other operations. Printing takes about 3 to 4 minutes to complete.

▶▶▶ Note

- After head alignment is completed, you can print and check the current setting. To do so, click the **Print Head Alignment** icon and when the message is displayed, click **Print Alignment Value**.

Aligning the Print Head Position Manually from Your Computer

Print head alignment corrects the installation positions of the print head and improves deviated colors and lines.

This printer supports two head alignment methods: [automatic head alignment](#) and manual head alignment. Normally, the printer is set for automatic head alignment.

If the printing results of automatic print head alignment are not satisfactory, perform manual head alignment.

The procedure for performing manual print head alignment is as follows:



Print Head Alignment

1. Select **Custom Settings** from the pop-up menu on the [Canon IJ Printer Utility](#)
2. Switch head alignment to manual
Check the **Align heads manually** check box.
3. Apply the settings
Click **Apply** and when the confirmation message appears, click **OK**.
4. Select **Test Print** from the pop-up menu on the Canon IJ Printer Utility
5. Click the **Print Head Alignment** icon
A message is displayed.
6. Load paper in the printer
Load two sheets of A4 size or Letter size plain paper into the cassette.

▶▶▶ Note

- If the cassette paper information registered on the printer is not set to A4 size and plain paper, an error may occur. For instructions on what to do if an error occurs, see "[Paper setting for Printing.](#)"

For details about the cassette paper information to be registered on the printer, see the following:

- [Paper Settings on the Printer Driver and the Printer \(Media Type\)](#)
- [Paper Settings on the Printer Driver and the Printer \(Paper Size\)](#)

7. Execute head alignment

Make sure that the printer is on and click **Align Print Head**.

The first pattern is printed.

▶▶▶ Important

- Do not open the operation panel while printing is in progress.

8. Check the printed pattern

Enter the numbers of the patterns with the least noticeable streaks in the associated boxes, and click **OK**.

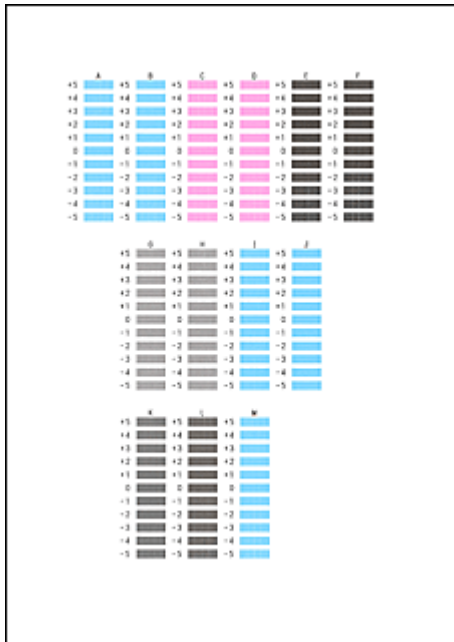

➤➤➤ **Note**

- If it is difficult to pick the best pattern, pick the setting that produces the least noticeable vertical streaks.



(A)



(B)

(A) Least noticeable vertical streaks

(B) Most noticeable vertical streaks

9. Confirm the displayed message and click **OK**

The second pattern is printed.

➤➤➤ **Important**

- Do not open the operation panel while printing is in progress.

10. Check the printed pattern

Enter the numbers of the patterns with the least noticeable stripes or streaks in the associated boxes, and click **OK**.

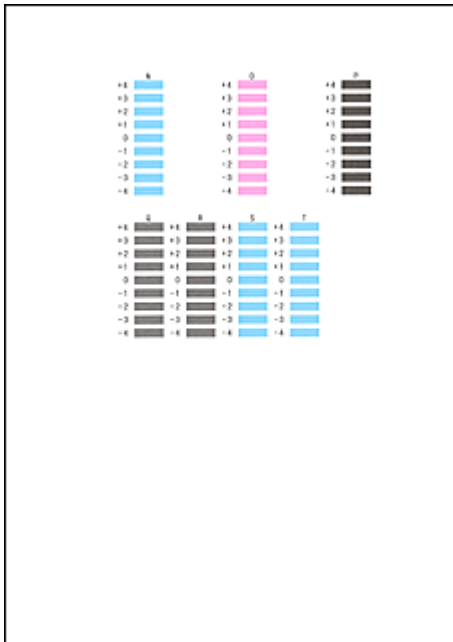

➤➤➤ **Note**

- If it is difficult to pick the best pattern, pick the setting that produces the least noticeable horizontal stripes.



(A)



(B)

(A) Least noticeable horizontal stripes

(B) Most noticeable horizontal stripes

- If it is difficult to pick the best pattern, pick the setting that produces the least noticeable vertical streaks.



(A)



(B)

(A) Least noticeable vertical streaks

(B) Most noticeable vertical streaks

➤➤➤ **Note**

- After head alignment is completed, you can print and check the current setting. To do so, click the **Print Head Alignment** icon and when the message is displayed, click **Print Alignment Value**.

Cleaning the Machine

- **Cleaning the Exterior of the Machine**
- **Cleaning the Platen Glass and Document Cover**
- **Cleaning the ADF (Auto Document Feeder)**
- **Cleaning the Paper Feed Roller**
- **Cleaning the Inside of the Machine (Bottom Plate Cleaning)**
- **Cleaning the Pad in the Cassette**

Cleaning the Exterior of the Machine

Be sure to use a soft and dry cloth such as eyeglasses cleaning cloth and wipe off dirt on the surface gently. Smooth out wrinkles on the cloth if necessary before cleaning.

▶▶▶ Important

- Be sure to turn off the power and unplug the power cord before cleaning the machine.
 - The power cannot be turned off while the machine is sending or receiving a fax, or when unsent faxes are stored in the machine's memory. Make sure if the machine completed sending or receiving all the faxes before unplugging the power cord.
 - The machine cannot send or receive faxes when the power is turned off.
 - If the power cord is unplugged, all documents stored in the machine's memory will be lost. Send or print a necessary document, or save it on a USB flash drive before unplugging the power cord.
- Do not use tissue paper, paper towels, rough-textured cloth, or similar materials for cleaning so as not to scratch the surface. Paper tissue powder or fine threads may remain inside the machine and cause problems such as print head blockage and poor printing results.
- Never use volatile liquids such as thinners, benzene, acetone, or any other chemical cleaner to clean the machine, as this may cause a malfunction or damage the surface of the machine.
- When cleaning the touch screen, be sure to use a soft cloth, such as eyeglasses cleaning cloth, to wipe off dirt on the surface. Do not apply excessive pressure. Never use cleaners containing organic solvents to wipe the touch screen.

Cleaning the Platen Glass and Document Cover

▶▶▶ Important

- Be sure to turn off the power and unplug the power cord before cleaning the machine.
 - The power cannot be turned off while the machine is sending or receiving a fax, or when unsent faxes are stored in the machine's memory. Make sure if the machine completed sending or receiving all the faxes before unplugging the power cord.
 - The machine cannot send or receive faxes when the power is turned off.
 - If the power cord is unplugged, all documents stored in the machine's memory will be lost. Send or print a necessary document, or save it on a USB flash drive before unplugging the power cord.
- Do not use tissue paper, paper towels, rough-textured cloth, or similar materials for cleaning so as not to scratch the surface. Paper tissue powder or fine threads may remain inside the machine and cause problems such as print head blockage and poor printing results.
- Never use volatile liquids such as thinners, benzene, acetone, or any other chemical cleaner to clean the machine, as this may cause a malfunction or damage the surface of the machine.

With a soft, clean, lint-free and dry cloth, wipe the platen glass (A), the inner side of the document cover (white sheet) (B), the glass of the ADF (Auto Document Feeder) (C), and the inner side of the ADF (white area) (D) gently. Make sure not to leave any residue, especially on the glass surfaces.

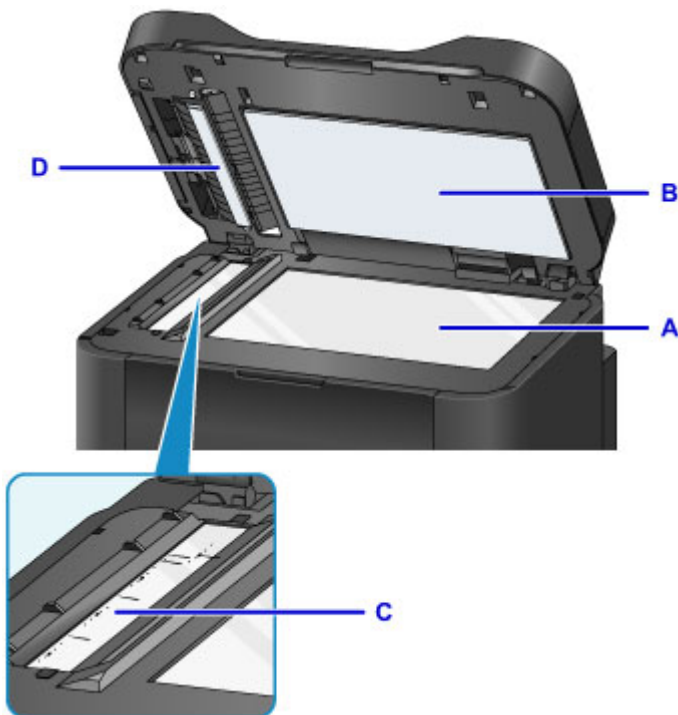

▶▶▶ Important

- The inner side of the document cover (white sheet) (B) is easily damaged, so wipe it gently.
- Glue, ink, correction fluid, or other substances on the ADF glass (C in the above figure) will cause black streaks on scanned images. If there is any on the glass, gently wipe it off.

Cleaning the ADF (Auto Document Feeder)

Be sure to use a soft, clean, lint-free and dry cloth to clean the ADF (Auto Document Feeder).

▶▶▶ Important

- Be sure to turn off the power and unplug the power cord before cleaning the machine.
 - The power cannot be turned off while the machine is sending or receiving a fax, or when unsend faxes are stored in the machine's memory. Make sure if the machine completed sending or receiving all the faxes before unplugging the power cord.
 - The machine cannot send or receive faxes when the power is turned off.
 - If the power cord is unplugged, all documents stored in the machine's memory will be lost. Send or print a necessary document, or save it on a USB flash drive before unplugging the power cord.
- Do not use tissue paper, paper towels, rough-textured cloth, or similar materials for cleaning so as not to scratch the surface. Paper tissue powder or fine threads may remain inside the machine and cause problems such as print head blockage and poor printing results.
- Never use volatile liquids such as thinners, benzene, acetone, or any other chemical cleaner to clean the machine, as this may cause a malfunction or damage the surface of the machine.

1. Open the document tray.



2. Open the document feeder cover.



3. With the clean cloth, wipe off any paper dust from the inside of the document feeder cover (A).

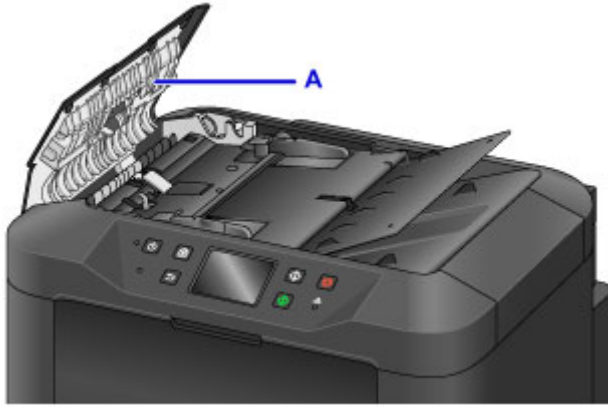

4. After wiping, close the document feeder cover by pushing it until it clicks into place.
5. Close the document tray.

Cleaning the Paper Feed Roller

If the paper feed roller is dirty or paper powder is attached to it, paper may not be fed properly.

In this case, clean the paper feed roller. Cleaning will wear out the paper feed roller, so perform this only when necessary.

You need to prepare: three sheets of A4 or Letter-sized plain paper

1. Make sure that the power is turned on.

2. Flick the HOME screen, then tap  **Setup**.

■ [Using the Operation Panel](#)

The setup menu screen will appear.

3. Tap  **Maintenance**.

The **Maintenance** screen will appear.

4. Tap **Roller cleaning**.

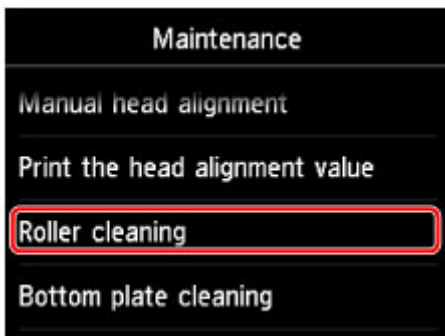

The confirmation screen will appear.

5. Tap **Yes**.
6. Follow the message to remove any paper from the cassette.
7. Tap **OK**.
The paper feed roller will rotate as it is cleaned.
8. Make sure that the paper feed roller has stopped rotating, then follow the message to load three sheets of A4 or Letter-sized plain paper in the cassette.
9. Extend the output tray extension, then open the paper output support.
10. Tap **OK**.

The machine starts cleaning. The cleaning will be complete when the paper is ejected.

11. When the completion message appears, tap **OK**.

If the problem is not resolved after cleaning the paper feed roller, contact the service center.

Cleaning the Inside of the Machine (Bottom Plate Cleaning)

Remove stains from the inside of the machine. If the inside of the machine becomes dirty, printed paper may get dirty, so we recommend performing cleaning regularly.

You need to prepare: a sheet of A4 or Letter-sized plain paper*

* Be sure to use a new piece of paper.

1. Make sure that the power is turned on.

2. Flick the HOME screen, then tap  **Setup**.

■ [Using the Operation Panel](#)

The setup menu screen will appear.

3. Tap  **Maintenance**.

The **Maintenance** screen will appear.

4. Tap **Bottom plate cleaning**.

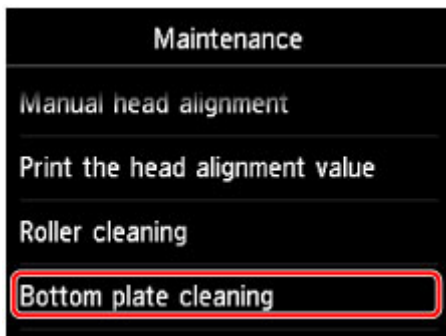

The confirmation screen will appear.

5. Tap **Yes**.
6. Follow the message to remove any paper from the cassette, then tap **OK**.
7. Fold a single sheet of A4 or Letter-sized plain paper in half widthwise, then unfold the paper.
8. Fold one side of the opened paper in another half, aligning the edge with the center crease, unfold the paper, then tap **OK**.

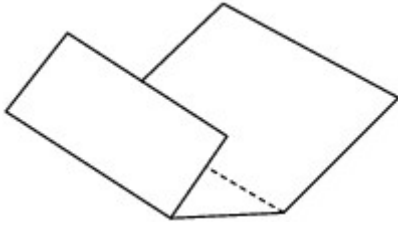

9. Load only this sheet of paper in the cassette with the ridges of the creases facing up and the edge of the half with no crease facing to the far side.



10. Extend the output tray extension, then open the paper output support.

11. Tap **OK**.

The paper cleans the inside of the machine as it feeds through the machine.

Check the folded parts of the ejected paper. If they are smudged with ink, perform Bottom Plate Cleaning again.

12. When the completion message appears, tap **OK**.

▶▶▶ Note

- When performing Bottom Plate Cleaning again, be sure to use a new piece of paper.

If the problem is not resolved after performing cleaning again, the protrusions inside the machine may be stained. Wipe off any ink from the protrusions using a cotton swab or the like.

▶▶▶ Important

- Be sure to turn off the power and unplug the power cord before cleaning the machine.
 - The power cannot be turned off while the machine is sending or receiving a fax, or when unsent faxes are stored in the machine's memory. Make sure if the machine completed sending or receiving all the faxes before unplugging the power cord.
 - The machine cannot send or receive faxes when the power is turned off.
 - If the power cord is unplugged, all documents stored in the machine's memory will be lost. Send or print a necessary document, or save it on a USB flash drive before unplugging the power cord.



Cleaning the Pad in the Cassette

If the pad in a cassette is smeared with paper powder or dirt, two or more sheets of paper may be ejected. Follow the procedure below to clean the pad in a cassette.

You need to prepare: cotton swab

1. Pull out the cassette from the machine, then remove all the paper.
2. Clean the pad (A) sideways with a moistened cotton swab.

▶▶▶ Important

- After cleaning the smeared pad, dry it completely.

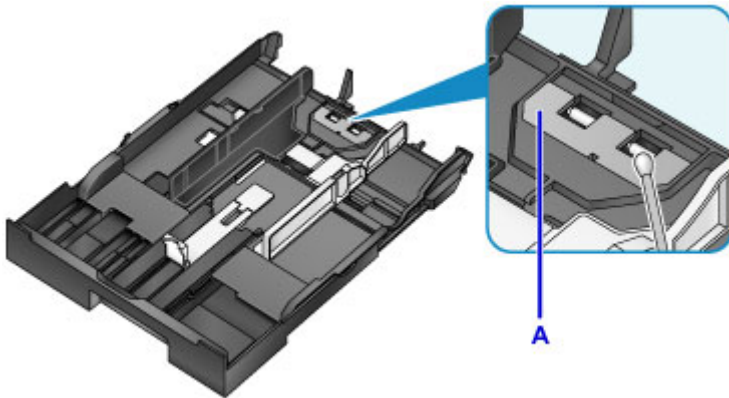

3. Reload the paper, then insert the cassette into the machine.

▶▶▶ Note

- If a message is displayed on the screen after inserting the cassette into the machine, tap **Register**.

If the problem is not resolved, contact the service center.

Changing the Machine Settings

- ▶ **Changing Machine Settings from Your Computer**
- ▶ **Changing the Machine Settings Using the Operation Panel**
- ▶ **Registering the Favorite Settings (Custom profiles)**
- ▶ **Checking the Total Number of Uses of the Machine**

Changing Machine Settings from Your Computer

- **Checking the Ink Status from Your Computer**
- **Registering a Changed Printing Profile**
- **Managing the Printer Power**
- **Reducing the Printer Noise**
- **Changing the Printer Operation Mode**

Checking the Ink Status from Your Computer

You can check the detailed information such as the remaining ink level and the ink tank types of your model.

1. Select **Ink Level Information** from the pop-up menu on the [Canon IJ Printer Utility](#)

An illustration of the ink types and their status is displayed.

If a warning or error related to the remaining ink level occurs, the printer driver displays an icon to let you know.

2. If necessary, click **Ink Details**

You can check the ink-related information.

Note

- **Ink Details** is displayed when the ink level is low.
- Click  to check which ink tank your model uses.
- Click **Update** to display the current remaining ink level.

Registering a Changed Printing Profile

You can name and register the printing profile you made in the [Print Dialog](#). The registered printing profile can be called up from **Presets** to be used. You can also delete the unnecessary printing profile.

The procedure for registering a printing profile is as follows:

Registering a Printing Profile

1. In the Print dialog, set the necessary items
2. Select **Save Current Settings as Preset... (Save As...)** from the **Presets**

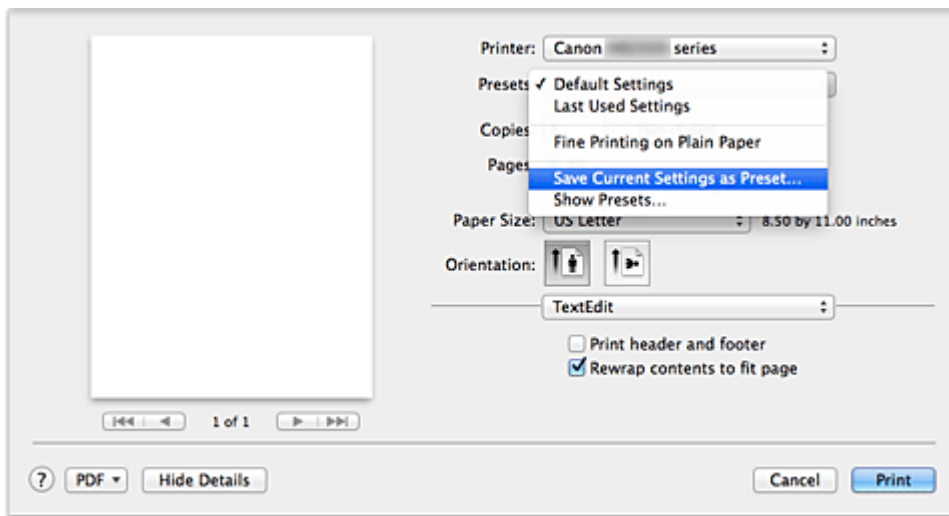

3. Save the settings

In the displayed dialog, enter a name in **Preset Name**, and if necessary, set **Preset Available For**. Then click **OK**.

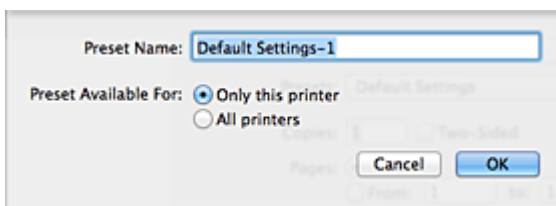

»»» Important

- There are also print settings that cannot be saved to preset.

Using Registered Printing Profile

1. On **Presets** in the Print dialog, select the name of printing profile you want to use
Printing profile in the Print dialog will be updated to the called profile.

Deleting Unnecessary Printing Profile

1. Select the printing profile to be deleted

- If you are using OS X Mavericks v10.9, OS X Mountain Lion v10.8, or OS X Lion v10.7

In the print dialog, select **Show Presets...** in the **Presets** section. Then in the dialog that appears, select the name of the printing profile to be deleted.

- If you are using Mac OS X v10.6.8

On **Presets** in the Print dialog, select the name of printing profile you want to delete.

2. Delete the printing profile

- If you are using OS X Mavericks v10.9, OS X Mountain Lion v10.8, or OS X Lion v10.7

Click **Delete**, and click **OK**. The selected printing profiles will be deleted from **Presets**.

- If you are using Mac OS X v10.6.8

On **Presets** in the Print dialog, click **Delete**. The selected printing profiles will be deleted from **Presets**.

Managing the Printer Power

This function allows you to manage the printer power from the printer driver.

The procedure for managing the printer power is as follows:



Power Off

The **Power Off** function turns off the printer. When you use this function, you will not be able to turn the printer on from the printer driver.

1. Select **Power Settings** from the pop-up menu on the [Canon IJ Printer Utility](#)
2. Execute power off

Click **Power Off**, and when the confirmation message appears, click **OK**.

The printer power switches off.

▶▶ Important

- You cannot receive faxes when the printer is switched off.

Reducing the Printer Noise

The silent function allows you to reduce the operating noise of this printer. Select when you wish to reduce the operating noise of the printer at night, etc.

Using this function may lower the print speed.

The procedure for using the quiet mode is as follows:

1. Select **Quiet Settings** from the pop-up menu on the [Canon IJ Printer Utility](#)

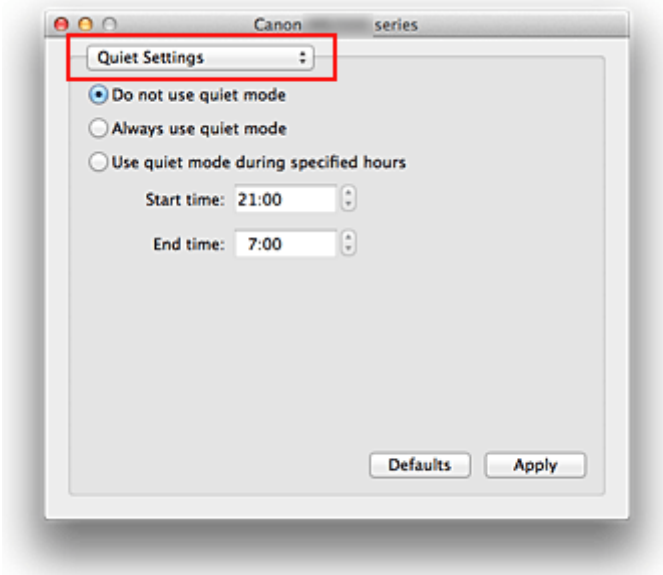

▶▶▶ Note

- If the computer is unable to communicate with the printer, a message may be displayed because the computer cannot access the function information that was set on the printer. If this happens, click **Cancel** to display the most recent settings specified on your computer.

2. Set the quiet mode

If necessary, specify one of the following items:

Do not use quiet mode

Select this option when you wish to use the printer with volume of normal operating noise.

Always use quiet mode

Select this option when you wish to reduce the operating noise of the printer.

Use quiet mode during specified hours

Select this option when you wish to reduce the operating noise of the printer during a specified period of time.

Set the **Start time** and the **End time** of the quiet mode you wish to be activated. If both are set to the same time, the quiet mode will not function.

▶▶▶ Important

- You can set the quiet mode from the operation panel of the printer or the printer driver. No matter how you use to set the quiet mode, the mode is applied when you perform operations from the operation panel of the printer or printing and scanning from the computer.

3. Apply the settings

Make sure that the printer is on and click **Apply**.
Click **OK** when the confirmation message appears.

The settings are enabled hereafter.

Note

- The effects of the quiet mode may be less depending on the print quality settings.

Changing the Printer Operation Mode

If necessary, switch between various modes of printer operation.

The procedure for configuring **Custom Settings** is as follows:

1. Make sure that the printer is on, and then select **Custom Settings** from the pop-up menu on the [Canon IJ Printer Utility](#)

▶▶▶ Note

- If the computer is unable to communicate with the printer, a message may be displayed because the computer cannot access the function information that was set on the printer. If this happens, click **Cancel** to display the most recent settings specified on your computer.

2. If necessary, complete the following settings:

Ink Drying Wait Time

You can set the length of the printer rest time until printing of the next page begins. Moving the slider to the right increases the pause time, and moving the slider to the left decreases the time. If the paper gets stained because the next page is ejected before the ink on the printed page dries, increase the ink drying wait time. Reducing the ink drying wait time speeds up printing.

Display Guide Message

Displays a guide when you perform operations in which the paper setting procedure is complicated.

Hagaki Printing

Displays the guide message before the printer begins hagaki printing.

To hide the guide messages, select the **Do not show again** check box in the displayed dialog.

To display the guide messages again, display the Canon IJ Printer Utility pop-up menu, select **Custom Settings**, and then check the **Hagaki Printing** check box.

▶▶▶ Important

- With OS X Mavericks v10.9, OS X Mountain Lion v10.8, or OS X Lion v10.7, you cannot use **Display Guide Message**. Therefore, if you check the **Do not show again** check box when a guide message is displayed before printing starts, this will stop any more guide messages from being displayed.

Prevent paper abrasion

The printer can increase the gap between the print head and the paper during high-density printing to prevent paper abrasion.

Check this check box to prevent paper abrasion.

Align heads manually

Usually, the **Print Head Alignment** function of **Test Print** on the pop-up menu in the Canon IJ Printer Utility is set to automatic head alignment, but you can change it to manual head alignment. If the printing results of automatic print head alignment are not satisfactory, [perform manual head alignment](#).

Check this check box to perform the manual head alignment. Uncheck this check box to perform the automatic head alignment.

Don't detect mismatch of paper settings when printing from computer

When you print documents from your computer and the paper settings on the print dialog and the cassette paper information registered on the printer do not match, this setting disables the message

display and allows you to continue printing.

To disable detection of paper setting mismatches, select this check box.

3. Apply the settings

Click **Apply** and when the confirmation message appears, click **OK**.

The printer operates with the modified settings hereafter.

Changing the Machine Settings Using the Operation Panel

- ▶ **Changing the Machine Settings Using the Operation Panel**
- ▶ **FAX settings**
- ▶ **Print settings**
- ▶ **LAN settings**
- ▶ **Device user settings**
- ▶ **Language selection**
- ▶ **Firmware update**
- ▶ **Cassette settings**
- ▶ **Administrator password setting**
- ▶ **Operation restrictions**
- ▶ **Reset setting**
- ▶ **About ECO settings**
- ▶ **About Quiet setting**
- ▶ **Using the Machine with the Access Point Mode**

Changing the Machine Settings Using the Operation Panel

This section describes the procedure to change the settings in the **Device settings** screen, taking the steps to specify **Prevent paper abrasion** as an example.

1. [Make sure that the machine is turned on.](#)

2. Flick the HOME screen, then tap  **Setup**.

[Using the Operation Panel](#)

3. Tap  **Device settings**.

The **Device settings** screen is displayed.

4. Tap the setting item to adjust.



The setting screen for the selected item is displayed.

5. Tap the setting item.

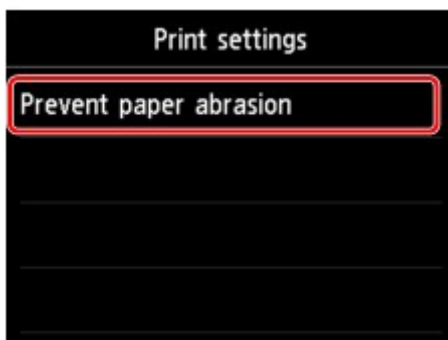

6. Tap the setting to specify.



You can select the setting menus below.

■ [FAX settings](#)

■ [Print settings](#)

■ [LAN settings](#)

■ [Device user settings](#)

■ [Language selection](#)

■ [Firmware update](#)

■ [Cassette settings](#)

■ [Administrator password setting](#)

■ [Operation restrictions](#)

■ [Reset setting](#)

▶▶▶ Important

- Depending on the setting item, authentication by the administrator password is required.

■ [About the Machine Administration](#)

If you do not know the administrator password, ask the administrator of the machine you are using.

▶▶▶ Note

- You can use the machine considering the environment, such as setting 2-sided printing as default or enabling the machine to turn on/off automatically.

■ [About ECO settings](#)

- You can reduce the operating noise when printing at night.

■ [About Quiet setting](#)

FAX settings

▶▶▶ Important

- This setting item is for the administrator.

This section describes the setting items in **FAX settings**.

■ [FAX user settings](#)

■ [Advanced FAX settings](#)

■ [Auto print settings](#)

■ [Auto save setting](#)

■ [Security control](#)

■ [Easy setup](#)

▶▶▶ Note

- Before changing the settings, you can confirm the current settings by printing USER'S DATA LIST.

■ [Summary of Reports and Lists](#)

FAX user settings

• User information settings

Registers your name and fax/telephone number printed on sent faxes.

■ [Registering User Information](#)

• Telephone line type (Country or region of purchase other than China)

Selects the telephone line type setting for the machine.

■ [Setting the Telephone Line Type](#)

▶▶▶ Note

- This setting may not be available depending on the country or region of purchase.

• Telephone line auto selection (China only)

If you select **ON**, the telephone line type is selected automatically.

If you select **OFF**, you can select the telephone line type manually.

■ [Setting the Telephone Line Type](#)

Advanced FAX settings

• Auto redial

Enables/disables automatic redialing.

If you select **ON**, you can specify the maximum number of redial attempts and the length of time the machine waits between redial attempts.

• Dial tone detect

Avoids mistransmission when reception and transmission occur at the same time.

If you select **ON**, the machine transmits the fax after confirming the dial tone.

▶▶ Note

- This setting may not be available depending on the country or region of purchase.

• **Pause time settings**

Sets the length of pause time for each when you enter "P" (pause).

• **TTI position**

Selects the position of the sender information (outside or inside the image area).

• **Remote RX**

Enables/disables remote reception.

If you select **ON**, you can specify the remote reception ID.

■ [Remote Reception](#)

• **Color transmission**

When faxing color documents using the ADF, selects whether to convert them into black & white data if the recipient's fax machine does not support color faxing.

If you select **Disconnect**, the machine does not send color documents when the recipient's fax machine does not support color faxing.

• **RX image reduction**

Enables/disables automatic reduction of incoming faxes so that they fit in the selected paper.

If you select **ON**, you can select the image reduction direction.

• **Adv. communication settings**

◦ **ECM TX**

Selects whether to send faxes in Error Correction Mode (ECM).

■ [Transmission/Reception of Faxes Using ECM](#)

◦ **ECM RX**

Selects whether to receive faxes in Error Correction Mode (ECM).

■ [Transmission/Reception of Faxes Using ECM](#)

◦ **TX start speed**

Selects the fax transmission speed.

The fax transmission start speed will be faster as the value is bigger.

When the telephone line condition or connection is poor, selecting a lower transmission start speed may solve transmission problems.

◦ **RX start speed**

Selects the fax reception speed.

The fax reception start speed will be faster as the value is bigger.

When the telephone line condition or connection is poor, selecting a lower reception start speed may solve reception problems.

Auto print settings

- **Received documents**

Selects whether to print the received fax automatically when receiving a fax.

If you select **Do not print**, the received fax is stored in the machine's memory.

For details on the received fax stored in the machine's memory:

■ [Document Stored in Machine's Memory](#)

- **Activity report**

Selects whether to print ACTIVITY REPORT automatically.

If you select **Print**, the machine prints ACTIVITY REPORT for the 20 histories of sent and received faxes automatically.

For details on the procedure to print ACTIVITY REPORT manually:

■ [Summary of Reports and Lists](#)

- **TX report**

Selects whether to print TX REPORT/ERROR TX REPORT automatically after sending a fax.

If you print the report, select **Print error only** or **Print for each TX**.

If you select **Print error only** or **Print for each TX**, you can specify the print setting that the first page of the fax is printed along with the report.

- **RX report**

Selects whether to print RX REPORT automatically after receiving a fax.

If you print RX REPORT, select **Print error only** or **Print for each RX**.

- **Print when out of ink**

Sets whether to continue printing the received fax without storing it in the machine's memory when the ink has run out.

However, part or all of the fax may not be printed since the ink has run out.

Auto save setting

Selects whether to save the received fax on the USB flash drive automatically or to forward to the shared folder on the computer automatically after receiving a fax.

■ [Saving Received Faxes Automatically on a USB Flash Drive](#)

■ [Forwarding Received Faxes Automatically to Shared Folder on the Computer](#)

Security control

- **FAX number re-entry**

If you select **ON**, you can set the machine to send faxes after entering the number twice. By using this setting, you can avoid the mistransmission of faxes.

■ [Preventing Mistransmission of Faxes](#)

- **Check RX FAX information**

If you select **ON**, the machine checks whether the recipient's fax machine information matches the dialed number. If it matches the number, the machine starts to send faxes.

■ [Preventing Mistransmission of Faxes](#)

- **Hook key setting**

If you select **Enable**, you can use the on hook function.

- **FAX reception reject**

If you select **ON**, the machine rejects the reception of faxes with no sender information or faxes from specific senders.

■ [Rejecting Fax Reception](#)

- **Caller rejection**

If you subscribe to the Caller ID service, the machine detects the sender's Caller ID. If the sender's ID matches the condition specified in this setting, the machine rejects the phone call or fax reception from the sender.

If you select **Yes** on the subscribing confirmation screen, you can specify the settings of rejection.

■ [Using the Caller ID Service to Reject Calls](#)

▶▶▶ **Note**

- This setting may not be supported depending on the country or region of purchase. Contact your telephone company to confirm whether it provides this service.

Easy setup

The machine must be set up depending on your telephone line and use of the faxing function. Follow the procedure according to the instructions on the touch screen.

▶▶▶ **Note**

- You can specify the setup setting individually or the advanced setting.

For details on how to specify the setting:

■ [Preparing for Faxing](#)

Print settings

- **Prevent paper abrasion**

Use this setting only if the print surface becomes smudged.

»» Important

- Be sure to set this back to **OFF** after printing since it may result in lower printing speed or lower print quality.

LAN settings

▶▶▶ Important

- This setting item is for the administrator.

- **Change LAN**

Enables either wireless LAN, wired LAN, or access point mode. You can also disable all.

- **Wireless LAN setup**

Selects the setup method for wireless LAN connection.

▶▶▶ Note

- You can also enter this setting menu by selecting **WLAN** on the HOME screen. In this case, enable wireless LAN.

When this menu is selected, the machine starts searching for a WPS-compatible access point. If the machine detects the access point, follow the on-screen instructions to set up wireless LAN. If an access point is not detected or if you select another setup method, select one of the setup methods below.

- **Standard setup**

Select when you perform settings for wireless LAN manually using the operation panel of the machine.

- **WPS (Push button method)**

Select when you perform settings for wireless LAN using an access point supporting a Wi-Fi Protected Setup (WPS) push button method. Follow the on-screen instructions during setup.

- **Other setup**

- **Advanced setup**

- Select when you perform settings for wireless LAN manually. You can specify multiple WEP keys.

- **WPS (PIN code method)**

- Select when you perform settings for wireless LAN using an access point supporting a Wi-Fi Protected Setup (WPS) PIN code method. Follow the on-screen instructions during setup.

- **Cableless setup**

- Select if you specify the settings of the access point information to the machine directly from a device (such as a smartphone) without operating the access point. Follow the on-screen instructions of the connecting device for the setup procedure.

- **Confirm LAN settings**

The list of wireless/wired LAN settings or the access point mode of this machine is displayed on the touch screen.

You can print the list from this setting menu.

- **WLAN setting list**

The list of wireless LAN settings of this machine is displayed on the touch screen.

The following setting items are displayed.

Items	Setting
-------	---------

Connection	Active/Inactive
SSID	XXXXXXXXXXXXXXXXXXXX XXXXXXXXXXXXXXXXXXXX
Communication mode	Infrastructure
Channel	XX
Wireless LAN security	Inactive/WEP(64bit)/WEP(128bit)/WPA-PSK(TKIP)/WPA-PSK(AES)/WPA2-PSK(TKIP)/WPA2-PSK(AES)
IPv4 address	XXX. XXX. XXX. XXX
IPv4 subnet mask	XXX. XXX. XXX. XXX
IPv4 default gateway	XXX. XXX. XXX. XXX
IPv6 address	XXXX: XXXX: XXXX: XXXX: XXXX: XXXX: XXXX: XXXX
IPv6 subnet prefix length	XXX
IPv6 default gateway	XXXX: XXXX: XXXX: XXXX: XXXX: XXXX: XXXX: XXXX
MAC address	XX:XX:XX:XX:XX:XX
IPsec settings	Enable (ESP)/Enable (ESP & AH)/Enable (AH)/Disable
Pre-shared key	XXXXXXXXXXXXXXXXXXXX
Printer name	XXXXXXXXXXXXXXXXXXXX
Bonjour service name	XXXXXXXXXXXXXXXXXXXX XXXXXXXXXXXXXXXXXXXX XXXXXXXXXXXXXXXXXXXX XXXXXXXXXXXXXXXXXXXX

("XX" represents alphanumeric characters.)

- **LAN setting list**

The list of wired LAN settings of this machine is displayed on the touch screen.

The following setting items are displayed.

Items	Setting
Connection	Active/Inactive
IPv4 address	XXX. XXX. XXX. XXX
IPv4 subnet mask	XXX. XXX. XXX. XXX
IPv4 default gateway	XXX. XXX. XXX. XXX
IPv6 address	XXXX: XXXX: XXXX: XXXX: XXXX: XXXX: XXXX: XXXX
IPv6 subnet prefix length	XXX

IPv6 default gateway	XXXX: XXXX: XXXX: XXXX: XXXX: XXXX: XXXX: XXXX
MAC address	XX:XX:XX:XX:XX:XX
IPsec settings	Enable (ESP)/Enable (ESP & AH)/Enable (AH)/Disable
Pre-shared key	XXXXXXXXXXXXXXXXXXXX
Printer name	XXXXXXXXXXXXXXXXXXXX
Bonjour service name	XXXXXXXXXXXXXXXXXXXX XXXXXXXXXXXXXXXXXXXX XXXXXXXXXXXXXXXXXXXX XXXXXXXXXXXXXXXXXXXX

("XX" represents alphanumeric characters.)

- **AP mode setting list**

The list of access point mode settings of this machine is displayed on the touch screen.

The following setting items are displayed.

Items	Setting
Connection	Active/Inactive
SSID	XXXXXXXXXXXXXXXXXXXX XXXXXXXXXXXXXXXXXXXX
Password	XXXXXXXXXXXX
Communication mode	Access point mode
Channel	3
Wireless LAN security	Inactive/WPA2-PSK(AES)
IPv4 address	XXX. XXX. XXX. XXX
IPv4 subnet mask	XXX. XXX. XXX. XXX
IPv4 default gateway	XXX. XXX. XXX. XXX
IPv6 address	XXXX: XXXX: XXXX: XXXX: XXXX: XXXX: XXXX: XXXX
IPv6 subnet prefix length	XXX
IPv6 default gateway	XXXX: XXXX: XXXX: XXXX: XXXX: XXXX: XXXX: XXXX
MAC address	XX:XX:XX:XX:XX:XX
IPsec settings	Disable
Pre-shared key	XXXXXXXXXXXXXXXXXXXX
Printer name	XXXXXXXXXXXXXXXXXXXX

Bonjour service name	XXXXXXXXXXXXXX XXXXXXXXXXXXXX XXXXXXXXXXXXXX XXXXXXXXXXXXXX
-----------------------------	--

("XX" represents alphanumeric characters.)

- **Print LAN details**

You can print out the network settings of the machine such as its IP address and SSID.

For more information on the machine's network setting is printed out:

■ [Printing Out Network Setting Information](#)

▶▶▶ Important

- This printout contains valuable information about your computer. Handle it with care.

- **Other settings**

▶▶▶ Important

- You cannot select the items below when **Disable LAN** is selected for **Change LAN**.

- **Set printer name**

Specifies the printer name. You can use up to 15 characters for the name.

▶▶▶ Note

- You cannot use the same printer name as that already used for other LAN connected devices.
- You cannot use a hyphen for the initial or last character of the printer name.

- **TCP/IP settings**

Performs IPv4 or IPv6 setting.

- **WSD setting**

Setting items when you use WSD (one of the network protocols supported in Windows 8.1, Windows 8, Windows 7, and Windows Vista).

Enable/disable WSD

Selects whether WSD is enabled or disabled.

▶▶▶ Note

- When this setting is enabled, the printer icon is displayed on the Network Explorer in Windows 8.1, Windows 8, Windows 7, and Windows Vista.

WSD scan from this device

Selecting **Enable** allows you to transfer the scanned data to the computer using WSD.

Timeout setting

Specifies the timeout length.

- **Bonjour settings**

Setting items for LAN using Bonjour for Mac OS.

Enable/disable Bonjour

Selecting **Enable** allows you to use Bonjour to perform the network settings.

Service name

Specifies the Bonjour service name. You can use up to 48 characters for the name.

▶▶▶ Note

- You cannot use the same service name as that already used for other LAN connected devices.

◦ LPR protocol setting

Activates/deactivates the LPR setting.

◦ Wireless LAN DRX setting

Selecting **Enable** allows you to activate discontinuous reception when using wireless LAN. It allows you to save electricity.

▶▶▶ Note

- Depending on the access point you are using, discontinuous reception may not be activated even though **Enable** is selected.
- Discontinuous reception is activated only while the machine is on standby. (The touch screen is in the screen saver mode.)

◦ Wired LAN DRX setting

Selecting **Enable** allows you to activate discontinuous reception when the machine is connected to a device compatible with wired LAN. It allows you to save electricity.

◦ Access point mode settings

When you use the machine as an access point, specify the access point name and the security setting.

■ [Using the Machine with the Access Point Mode](#)

Device user settings

▶▶▶ Important

- This setting item is for the administrator.

- **Date/time setting**

Sets the current date and time.

■ [Setting the Sender Information](#)

- **Date display format**

Sets the format of dates displayed on the touch screen and printed on sent faxes and photos.

▶▶▶ Note

- When **ON** is selected for **Print date** on the print settings screen in printing from a USB flash drive, the shooting date is printed in the date display format you selected.

■ [Setting Items for Photo Printing Using the Operation Panel of the Machine](#)

- **Daylight saving time setting**

Enables/disables the summer time setting. If you select **ON**, you can select additional sub-settings. This setting may not be available depending on the country or region of purchase.

- **Start date/time**

Sets the date and time that summer time starts.

Month: Specify the month.

Week: Specify the week.

DOW: Specify the day of the week.

The screen to set the shift time to start summer time will be displayed after specifying the items above and tapping **OK**.

After specifying the shift time and tapping **OK**, you can specify the end date/time.

- **End date/time**

Sets the date and time that summer time ends.

Month: Specify the month.

Week: Specify the week.

DOW: Specify the day of the week.

The screen to set the shift time to end summer time will be displayed after specifying the items above and tapping **OK**.

Specify the shift time, then tap **OK**.

- **Sound control**

Selects the volume.

- **Keypad volume**

Selects the beep volume when tapping the touch screen or the buttons on the operation panel.

- **Alarm volume**

Selects the alarm volume.

- **Line monitor volume**

Selects the line monitor volume.

- **Offhook alarm**

Selects the alarm volume when the phone receiver is not put on the hook properly.

- **Country or region**

Selects the country or region where you are using the machine.

▶▶▶ Note

- This setting may not be available depending on the country or region of purchase.

- **Device info sending setting**

Selects whether you will send the printer usage information to Canon server. The information sent to Canon will be utilized to develop better products. Select **Agree** to send the printer usage information to Canon server.

Language selection

Important

- This setting item is for the administrator.

Changes the language for the messages and menus on the touch screen.

Firmware update

▶▶▶ Important

- This setting item is for the administrator.

You can update the firmware of the machine, check the firmware version, or perform settings of a notification screen, a DNS server and a proxy server.

▶▶▶ Note

- Only **Check current version** is available when **Disable LAN** is selected for **Change LAN** in **LAN settings**.

• Install update

Performs the firmware update of the machine. If you select **Yes**, the firmware update starts. Follow the on-screen instructions to perform update.

▶▶▶ Important

- When you use this function, make sure that the machine is connected to the Internet.
- If the firmware update is carried out, all faxes stored in the machine's memory are deleted.
- You cannot start the firmware update under the following conditions:
 - While the machine is sending or receiving a fax
 - While the machine is storing the unprinted fax in machine's memory (memory reception)
 - When the unsent faxes are stored in the machine's memory

▶▶▶ Note

- If the firmware update is not complete, check the following and take an appropriate action.
 - When using wired LAN, make sure that the machine is connected to the computer with a LAN cable properly.
 - Check the network settings such as an access point or a router.
 - If **Cannot connect to the server.** is displayed on the touch screen, tap **OK**, then try again after a while.

• Check current version

You can check the current firmware version.

• Update notification setting

When **Yes** is selected and the firmware update is available, the screen to inform you of the firmware update is displayed on the touch screen.

• DNS server setup

Performs settings for a DNS server. Select **Auto setup** or **Manual setup**. If you select **Manual setup**, follow the display on the touch screen to perform settings.

• Proxy server setup

Performs settings for a proxy server. Follow the display on the touch screen to perform settings.

Cassette settings

By registering the paper size and the media type loaded in the cassette, you can prevent the machine from misprinting by displaying the message before printing starts when the paper size or the media type of the loaded paper differs from the print settings.

For details:

[Paper Setting for Printing](#)

- **Register cassette paper info**

Registers the paper size and the media type you load in the cassette.

Note

- When you register the paper size and the media type, the screen to select whether you apply the settings to those for copying is displayed. Select **Yes** to apply the registered settings to copying.
- For details on the proper combination of paper settings you can specify by the printer driver or on the touch screen:

- [Setting the Media Type with the Printer Driver and on the Printer](#)

- [Setting the Paper Size with the Printer Driver and on the Printer](#)

- **Detect paper setting mismatch**

If you select **Yes**, the machine detects whether the paper size and the media type are identical with those registered in **Register cassette paper info**. If printing starts with the settings that do not match, an error message is displayed on the touch screen.

Note

- When **No** is selected, **Register cassette paper info** or **Detect cassette reinsertion** is disabled.

- **Detect cassette reinsertion**

If you select **Yes**, the machine detects the cassette is reinserted. When the **Register cassette paper info** screen is displayed, register the paper size and the media type.

Administrator password setting

▶▶ Important

- This setting item is for the administrator.

You can specify or disable the administrator password.

Specifying the administrator password requires you to enter the password to change the machine settings or connection settings.

Entering the administrator password is required to change the setting items in the following menus.

- **ECO settings**
- **Quiet setting**
- **Web service setup**
- **FAX settings**
- **LAN settings**
- **Device user settings**
- **Language selection**
- **Firmware update**
- **Administrator password setting**
- **Operation restrictions**
- **Reset setting**

When the confirmation screen to specify the administrator password is displayed, tap **Yes**. When the message is displayed, tap **OK**.

The screen to show the range where the administrator password is valid is displayed.

Select the range, then specify the administrator password (0 to 32 alphanumeric characters).

Remote UI/Network Tool

Entering the administrator password is required to change the setting items using the Remote UI or IJ Network Tool.

LCD/Remote UI/Network Tool

Entering the administrator password is required to change the setting items using the operation panel of the machine, the Remote UI, or IJ Network Tool.

Operation restrictions

▶▶▶ Important

- This setting item is for the administrator.

You can restrict printing, copying, or faxing operations or to use a USB flash drive or a shared folder on the computer.

▶▶▶ Note

- When no operation restrictions are enabled, the confirmation screen to enable operation restrictions is displayed. Tapping **Yes** enables you to restrict operations. If you have already restricted any operations, the menu items are displayed. Tapping **Change operation restrictions** enables you to change the settings of operation restrictions.

Copy

Restricts copying operations. If you select **Restrict all copying**, you can restrict all copying operations. If you select **Restrict color copying**, you can restrict color copying operations only.

Print from storage medium

Restricts to print from a USB flash drive.

Scan to USB flash drive

Restricts to save the scanned data on a USB flash drive.

Scan to destination folder

Restricts to forward the scanned data to a shared folder on the computer.

FAX transmission

Restricts to send a fax.

FAX reception

Restricts to receive a fax.

▶▶▶ Important

- If the machine receives a fax while **Restrict** is selected, **Not available. An operation restriction is set.** is displayed on the touch screen and the fax standby screen is displayed. In this case, you cannot receive the faxes. Ask the administrator of the machine you are using to change the setting, then have the sender resend the faxes.

Directory

Restricts operations related to the machine's directory.

▶▶▶ Note

- If you disable all restrictions, tap **Cancel operation restrictions** when the menu items are displayed. When the confirmation screen is displayed, tap **Yes**.
To disable each operation restriction, tap the item, then tap **Do not restrict**.

Reset setting

▶▶▶ Important

- This setting item is for the administrator.

Reverts all settings you made to the machine back to the default. However, some data may not be changed, depending on the current usage state of your machine.

▶▶▶ Important

- Depending on the setting item, it is necessary to perform connection or setup again after you have reverted the setting back to the default.

- **Web service setup only**

Reverts the Web service settings back to the default.

- **LAN settings only**

Reverts the LAN settings other than the administrator password back to the default.

After resetting, perform setup again as necessary.

- **Telephone number only**

Reverts the telephone/fax number settings to default.

- **Settings only**

Reverts the settings such as the paper size, media type, or other setting items back to the default. The LAN settings and the telephone/fax number are not reverted.

- **Device info sending setting only**

Reverts only the device information sending settings.

- **FAX settings only**

Reverts the fax settings to the default. Disconnect the telephone line from the machine before you revert this setting item.

After resetting, perform setup again as necessary.

- **Reset all**

Reverts all settings you made to the machine back to the default. The administrator password specified for the machine reverts to the default setting.

After resetting, perform setup again as necessary.

▶▶▶ Note

- You cannot change the following setting items back to the default:

- The language displayed on the touch screen
- The current position of the print head
- The country or region selected for **Country or region**
- Total use of copying, scanning, and faxing recorded in **Records of use**

You can delete the registered user's name or telephone number following the procedure below.

1. Display the **User information settings** screen.

■ [Setting the Sender Information](#)

2. Tap the user's name or the telephone number, then delete all characters or numbers.

3. Tap **OK** when you finished deleting all characters or numbers.

About ECO settings

This setting allows you to use automatic duplex printing as a default to save paper and to turn the machine on/off automatically to save electricity.

■ ■ [Using Duplex Printing](#)

■ ■ [Turning on/off the machine automatically](#)

▶▶▶ Important

- Depending on the setting item, authentication by the administrator password is required.

■ ■ [About the Machine Administration](#)

If you do not know the administrator password, ask the administrator of the machine you are using.

Using Duplex Printing

Follow the procedure below to use duplex printing.

1. [Make sure that the machine is turned on.](#)

2. Flick the HOME screen, then tap  **ECO settings**.

■ ■ [Using the Operation Panel](#)

3. Tap **Two-sided printing setting**.

4. Specify the settings as necessary.



- A. Tap to select two-sided copying as a default.
- B. Tap to select duplex printing PDF files saved on a USB flash drive as a default.
- C. Tap to select two-sided printing of sent/received faxes, reports, or lists as a default.
- D. Tap to specify the print settings.

▶▶▶ Note

- When duplex printing is selected, the  icon is displayed on each menu of the HOME screen or on the setting items for duplex printing on each print setting screen.

Turning on/off the machine automatically

Follow the procedure below to use power saving function.

1. [Make sure that the machine is turned on.](#)

2. Flick the HOME screen, then tap  **ECO settings**.

[Using the Operation Panel](#)

3. Tap **Power control**.
4. Specify the settings as necessary.

When you specify the time and day to turn the machine on:

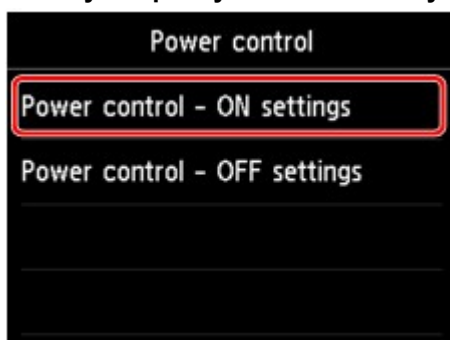

1. Tap **Power control - ON settings**.
2. Tap **ON** on the displayed screen.

The screen below is displayed.

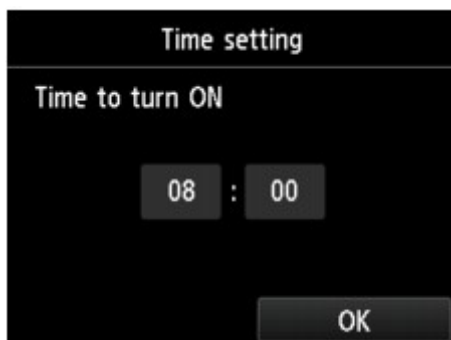

3. Tap the time.

The screen below is displayed.



4. Tap the numbers to specify the time to turn the machine on.

You can specify the hour from 0 to 24 and specify the minute in increments of 10 minutes.

5. Tap **OK** to confirm the time to turn the machine on.

After confirming the time to turn the machine on, the screen to specify the day is displayed. Tap the day, tap **Enable** or **Disable**, then tap **OK**. The setting is valid on the day(s) you select **Enable** for.

When you specify the time and day to turn the machine off:

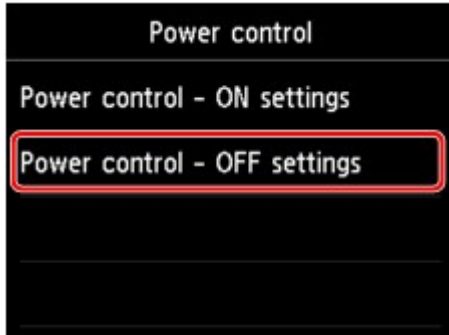

1. Tap **Power control - OFF settings**.
2. Tap **ON** on the displayed screen.

The screen below is displayed.

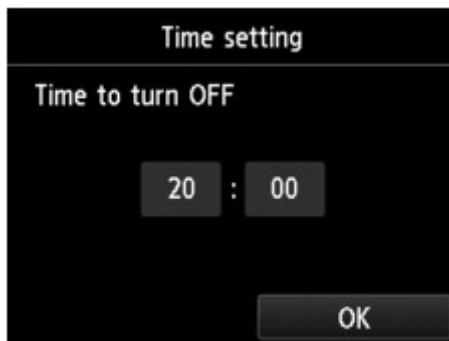

3. Tap the time.

The screen below is displayed.



4. Tap the numbers to specify the time to turn the machine off.

You can specify the hour from 0 to 24 and specify the minute in increments of 10 minutes.

5. Tap **OK** to confirm the time to turn the machine off.

After confirming the time to turn the machine off, the screen to specify the day is displayed. Tap the day, tap **Enable** or **Disable**, then tap **OK**. The setting is valid on the day(s) you select **Enable** for.

About Quiet setting

Enables this function on the machine if you want to reduce the operating noise, such as when printing at night. In addition, you can specify the time range to reduce the operating noise.

▶▶▶ Important

- Set the current date and time in advance.
 - [Setting the Sender Information](#)
 - Authentication by the administrator password may be required to change the setting.
 - [About the Machine Administration](#)
- If you do not know the administrator password, ask the administrator of the machine you are using.

Follow the procedure below to perform setting.

1. [Make sure that the machine is turned on.](#)

2. Flick the HOME screen, then tap  **Quiet setting**.

■ [Using the Operation Panel](#)

3. Tap **Use quiet mode** or **Use during specified hours**.

- When **Use quiet mode** is selected:

The confirmation screen is displayed, then the  icon appears as the **Quiet setting** menu icon.

- When **Use during specified hours** is selected:

The **Quiet hours** screen is displayed.



- A. Tap to display the screen below.



1. Tap the numbers to specify the starting time.

You can specify the hour from 0 to 24.

2. Tap to confirm the starting time.

After specifying the starting time, specify the ending time following the same procedure.

B. Tap to confirm the time to start and to end.

You can reduce the operating noise during the specified time.

The confirmation screen is displayed, then the  icon appears as the **Quiet setting** menu icon.

»» Important

- Operating speed may be reduced compared to when the quiet mode is not selected.
- This function may not be so effective depending on the machine's setting. Furthermore, certain noise, such as when the machine is preparing for printing, is not reduced.

»» Note

- You can set the quiet mode from the operation panel of the machine or the printer driver. No matter how you set the quiet mode, the mode is applied when you perform operations from the operation panel of the machine or printing and scanning from the computer.

Using the Machine with the Access Point Mode

By using the machine as an access point in an environment that does not have wireless LAN router or access point, or by using the machine as an access point temporarily in an environment that has wireless LAN router or access point, you can connect the machine to an external device such as a computer or a smartphone and print/scan from them.

This section describes how to enable the access point mode, the access point name of the machine, and the security setting.

■ ■ [How to enable the Access Point Mode](#)

■ ■ [Printing/Scanning with the Access Point Mode](#)

■ ■ [How to terminate the Access Point Mode](#)

■ ■ [Setting of the Access Point Mode](#)

▶▶▶ Important

- Before using the machine with the access point mode, confirm the usage restrictions then switch the machine to the access point mode.

■ ■ [Restrictions](#)

- If you use the machine with the access point mode for the long time, it is recommended that you change the default access point name and the default password to the combination of numbers and letters with the point of view of security.

How to enable the Access Point Mode

Enable the access point mode following the procedure below.

1. [Make sure that the machine is turned on.](#)

2. Flick the HOME screen, then tap  **Setup**.

■ ■ [Using the Operation Panel](#)

3. Tap  **Device settings**.

4. Tap **LAN settings**.

5. Tap **Change LAN**.

6. Tap **Access point mode active**.

The access point name (SSID) that set currently is displayed. (When using the machine for the first time, the default setting is displayed.)

When detecting the machine from the external device such as a computer or a smartphone, you can detect with the access point name (SSID).

»» Note

- Tapping **Details** displays the security setting.
The password required when connecting from the external device is also displayed.
- You can specify the access point name (SSID) and the security setting optionally.
[■ Setting of the Access Point Mode](#)

7. Tap **OK**.

The access point mode is enabled and the machine can be used as an access point.

Printing/Scanning with the Access Point Mode

Print/Scan with the access point mode following the procedure below.

1. Connect an external device such as a computer or a smartphone to the machine via wireless LAN.

Perform wireless LAN settings with your external device, then assign the access point name specified for the machine as a destination.

»» Note

- For details on how to perform wireless LAN settings with an external device, refer to the device's instruction manual.
- When a WPA2-PSK (AES) password is valid on the machine, entering the password is required to connect an external device to the machine via wireless LAN. Enter the password specified for the machine.

2. Start printing or scanning from an external device such as a computer or a smartphone.

»» Note

- For details on how to print or scan from an external device such as a computer or a smartphone via wireless LAN, refer to the device's or application's instruction manual.

How to terminate the Access Point Mode

In environments that the machine is connected with the computer over the wireless LAN usually, set the machine to the wireless LAN connection following the procedure below when you finish using the machine with the access point mode temporarily.

1. Flick the HOME screen, then tap  **Setup**.

[■ Using the Operation Panel](#)

2. Tap  **Device settings**.

3. Tap **LAN settings**.

4. Tap **Change LAN**.

5. Tap **Wireless LAN active**.

If you do not use the machine over wireless LAN, select **Wired LAN active** or **Disable LAN**.

Setting of the Access Point Mode

Specify the settings for the access point mode following the procedure below.

1. [Make sure that the machine is turned on.](#)

2. Flick the HOME screen, then tap  **Setup**.

 [Using the Operation Panel](#)

3. Tap  **Device settings**.

4. Tap **LAN settings**.

5. Tap **Other settings**.

6. Tap **Access point mode settings**.

The screen to enter the access point name (SSID) is displayed.

7. Tap the touch screen.

8. Enter the access point name (up to 32 characters).

Enter the access point name when you use the machine as an access point.

9. Tap **OK** to finish entering the name.

10. Tap **OK** to finish specifying the access point name.

11. Select the security setting.

Disable

Finishes the access point settings without specifying the security setting.

WPA2-PSK (AES)

Specifies the security setting applying WPA2-PSK (AES). Proceed to the next step when the screen to specify the password is displayed.

12. Tap the touch screen.

13. Enter the password (8 to 10 characters).
14. Tap **OK** to finish entering the password.
15. Tap **OK** to finish specifying the password setting.

▶▶ Note

- If you change the access point mode setting of the machine, also change the access point setting of the external device such as a computer or a smartphone.

Registering the Favorite Settings (Custom profiles)

You can register the favorite copying, scanning, or faxing settings and call them up from the HOME screen.

You can register up to 20 settings.

■ [Registering the Setting](#)

■ [Calling Up the Registered Setting](#)

■ [Editing/Deleting the Registered setting](#)

Registering the Setting

Tap **Save profile** on each standby screen or on the screen displayed after the settings are specified.

Copy standby screen

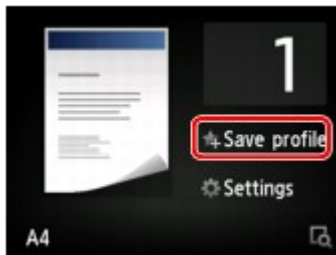

Scan standby screen

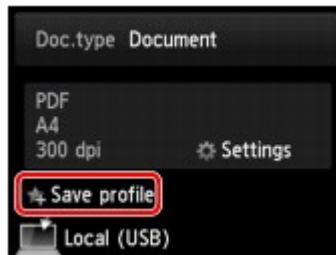

Fax transmission standby screen

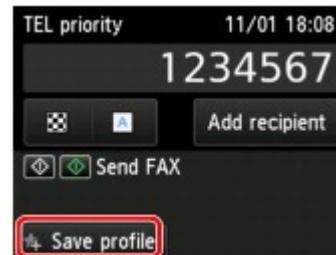

When the confirmation screen of **Save profile** is displayed, tap **Yes**.

When the screen to enter the name of the setting is displayed, enter the name, then tap **Register**.

▶▶▶ Note

- If you tap **Register** without entering the name, the name currently shown is applied as the name of the setting.

Calling Up the Registered Setting

Follow the procedure below to call up the registered setting.

1. [Make sure that the machine is turned on.](#)

2. Flick the HOME screen, then tap  **Custom profiles**.

■ [Using the Operation Panel](#)

3. Tap the setting you want to call up.

▶▶▶ Note

- You can change the displayed items by tapping **Switch view**.

Editing/Deleting the Registered setting

Follow the procedure below to edit or delete the registered setting.



1. [Make sure that the machine is turned on.](#)

2. Flick the HOME screen, then tap  **Custom profiles.**

■ [Using the Operation Panel](#)

3. Tap **Edit/delete.**

You can change the order or name of the registered settings and delete the settings.

- To change the order of the registered settings
 1. Tap **Rearrange.**
 2. Tap the setting you want to move.
 3. Tap  or  to move the selected setting.
 4. Tap **Apply.**
 5. Tap **Exit.**
- To change the name of the registered settings
 1. Tap **Rename.**
 2. Tap the setting you want to rename.
 3. Enter the new name, then tap **OK.**

■ [Entering Numbers, Letters, and Symbols](#)

4. Tap **Exit.**
- To delete the registered settings
 1. Tap **Delete.**
 2. Tap the setting you want to delete.
 3. Tap **Yes** on the displayed screen.
 4. Tap **Exit.**

Checking the Total Number of Uses of the Machine

You can check the total number of uses of the machine (e.g. the total number of printing, copying, sending/receiving faxes, or scanning).

1. [Make sure that the machine is turned on.](#)

2. Flick the HOME screen, then tap  **Records of use.**

■ [Using the Operation Panel](#)

The **Records of use** screen is displayed.

3. Tap the item to check.

Total sheets used on the device

Displays the total number of printing.

You can check the total number of black and white printing, color printing, printing on plain paper, printing on paper other than plain paper, One-sided printing, or Two-sided printing respectively.

No. of sheets used for copying

Displays the total number of copying.

You can check the total number of black and white copying, color copying, copying on plain paper, copying on paper other than plain paper, One-sided copying, Two-sided copying, 2-on-1 copying (One-sided/Two-sided), or 4-on-1 copying (One-sided/Two-sided) respectively.

No. of sheets used for FAX

Displays the total number of received or printed faxes.

You can check the total number of black and white printing, color printing, One-sided printing, or Two-sided printing respectively.

Sheets used for other functions

Displays the total number of printing other than copying or faxing.

You can check the total number of black and white printing, color printing, printing on plain paper, printing on paper other than plain paper, One-sided printing, or Two-sided printing respectively.

Number of FAX sheets sent

Displays the total number of sent faxes.

You can check the total number of black and white transmission or color transmission respectively.

Number of sheets scanned

Displays the total number of scanning.

You can check the total number of scanning on the platen glass or that in the ADF respectively.

▶▶▶ **Note**

- The record of the total number of uses is not reverted even if the machine is reverted back to the default by **Reset setting** in **Device settings**.

Information about Network Connection

- ▶ [Useful Information about Network Connection](#)

Useful Information about Network Connection

- **Default Values Set at Factory (Network)**
- **Connecting the Machine to the Computer Using a USB Cable**
- **When Detecting the Printers Have the Same Name**
- **Connecting to Other Computer with LAN/Changing the Connection Method from USB to LAN**
- **Printing Out Network Setting Information**

Default Values Set at Factory (Network)

Default Values of the LAN Connection

Item	The default
Change LAN	Disable LAN
SSID	BJNPSETUP
Communication mode	Infrastructure
Wireless LAN security	Disable
IP address (IPv4)	Auto setup
IP address (IPv6)	Auto setup
Set printer name*	XXXXXXXXXXXX
Enable/disable IPv6	Enable
Enable/disable WSD	Enable
Timeout setting	1 minute
Enable/disable Bonjour	Enable
Service name	Canon MB5000 series
LPR protocol setting	Enable
Wireless LAN DRX setting	Enable
Wired LAN DRX setting	Enable

("XX" represents alphanumeric characters.)

* The default value in this item varies by machine. You can check the value in this item using the operation panel on the machine.

[LAN settings](#)

Default Values of the Access Point Mode

Item	The default
SSID (access point name)	XXXXXX-MB5000series
Wireless LAN security	WPA2-PSK (AES)
Password	Serial number of the machine

(XXXXXX is the last six digits of MAC address of the machine.)

Connecting the Machine to the Computer Using a USB Cable

Connect the machine and the computer using a USB cable as the illustration below. The USB port is located on the rear of the machine.

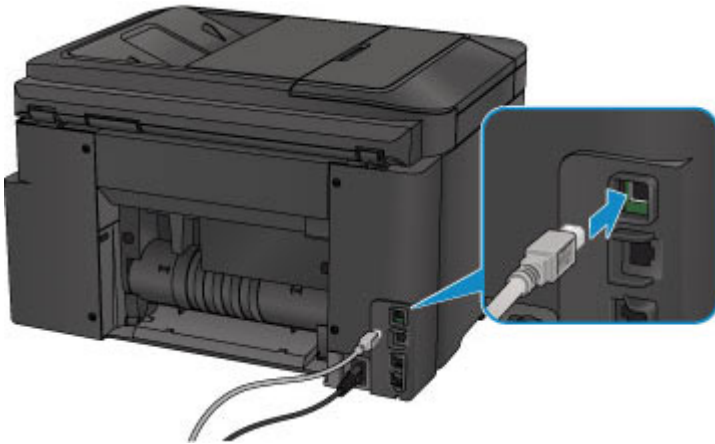

When Detecting the Printers Have the Same Name

When the printer is detected, you may see multiple printers of the same name on the detection result screen. The printer names on the screen are displayed with the MAC address added at the end of the names or displayed as the printer name specified by Bonjour.

Select a printer with checking the MAC address, the printer name specified by Bonjour, or the serial number set to the printer against that on the detection result screen.

▶▶▶ Note

- A serial number may not be displayed on the detection result screen.

To check the MAC address of the printer, print out the network setting information using the operation panel of the printer.

■ [Printing Out Network Setting Information](#)

Additionally, you can check the network setting information on the touch screen of the printer. Select **WLAN setting list** from **Confirm LAN settings** in **LAN settings** under **Device settings**, and check the item displayed on the touch screen.

■ [LAN settings](#)

Connecting to Other Computer with LAN/Changing the Connection Method from USB to LAN

To add the computer connecting the machine with LAN or to change the connection method between the machine and the computer from USB to LAN, perform setup according to the instructions on our website.

Connecting to Other Computer with LAN

To add the computer connecting the machine with LAN, perform setup according to the instructions on our website.

Changing the Connection Method from USB to LAN

To change the connection method to LAN while you are using the machine with USB connection, perform setup again according to the instructions on our website and select **Change Connection Method**.

Printing Out Network Setting Information

You can print out the current network settings of the machine using the operation panel of the machine.

▶▶▶ Important

- This print out contains valuable information about your computer. Handle it with care.

1. [Make sure that the machine is turned on.](#)
2. [Load a sheet of A4 or Letter-sized plain paper.](#)

3. Flick the HOME screen, then tap  **Setup**.

■ [Using the Operation Panel](#)

The menu screen is displayed.

4. Tap  **Device settings**.

5. Tap **LAN settings**.

6. Tap **Confirm LAN settings**.

7. Tap **Print LAN details**.

8. Tap **Yes**.

The machine starts printing the network setting information.

The following information on the machine's network setting is printed out.

Item	Explanations of the item	Setting
Wireless LAN	Wireless LAN	Enable/Disable
Connection	Connection status	Active/Inactive
MAC Address	MAC Address	XX:XX:XX:XX:XX:XX
SSID	SSID	SSID of the wireless LAN/SSID of the access point mode
Password	Password	Password of the access point mode (8 to 10 alphanumeric characters)
Communication Mode	Communication Mode	Infrastructure/Access Point Mode
Channel *1	Channel	XX (1 to 13)
Encryption	Method of the Encryption	none/WEP/TKIP/AES
WEP Key Length	WEP Key Length	Inactive/128/64

Authentication	Method of the Authentication	none/auto/open/shared/WPA-PSK/WPA2-PSK
Signal Strength	Signal Strength	0 to 100 [%]
TCP/IP Version	TCP/IP Version	IPv4 & IPv6/IPv4
IPv4 IP Address	Selected IP Address (IPv4)	XXX.XXX.XXX.XXX
IPv4 Default Gateway	Default Gateway (IPv4)	XXX.XXX.XXX.XXX
Subnet Mask	Subnet Mask	XXX.XXX.XXX.XXX
IPv6 IP Address *2	Selected IP Address (IPv6)	XXXX:XXXX:XXXX:XXXX XXXX:XXXX:XXXX:XXXX
IPv6 Default Gateway *2	Default Gateway (IPv6)	XXXX:XXXX:XXXX:XXXX XXXX:XXXX:XXXX:XXXX
Subnet Prefix Length *2	Subnet Prefix Length	XXX
IPsec *3	IPsec setting	Active
Security Protocol *3	Method of the Security Protocol	ESP/ESP & AH/AH
Wireless LAN DRX	Discontinuous reception (wireless LAN)	Enable/Disable
Wired LAN	Wired LAN	Enable/Disable
Connection	Status of the Wired LAN	Active/Inactive
MAC Address	MAC Address	XX:XX:XX:XX:XX:XX
TCP/IP Version	TCP/IP Version	IPv4 & IPv6/IPv4
IPv4 IP Address	Selected IP Address (IPv4)	XXX.XXX.XXX.XXX
IPv4 Default Gateway	Default Gateway (IPv4)	XXX.XXX.XXX.XXX
Subnet Mask	Subnet Mask	XXX.XXX.XXX.XXX
IPv6 IP Address *2	Selected IP Address (IPv6)	XXXX:XXXX:XXXX:XXXX XXXX:XXXX:XXXX:XXXX
IPv6 Default Gateway *2	Default Gateway (IPv6)	XXXX:XXXX:XXXX:XXXX XXXX:XXXX:XXXX:XXXX
Subnet Prefix Length *2	Subnet Prefix Length	XXX
IPsec *3	IPsec setting	Active
Security Protocol *3	Method of the Security Protocol	ESP/ESP & AH/AH
Wired LAN DRX	Discontinuous reception (wired LAN)	Enable/Disable
Other Settings	Other settings	-
Printer Name	Printer name	Printer name (Up to 15 alphanumeric characters)

WSD	WSD setting	Enable/Disable
WSD Timeout	Timeout	1/5/10/15/20 [min]
LPR Protocol	LPR protocol setting	Enable/Disable
Bonjour	Bonjour setting	Enable/Disable
Bonjour Service Name	Bonjour service name	Bonjour service name (Up to 52 alphanumeric characters)
DNS Server	Getting DNS Server automatically	Auto/Manual
Primary Server	Primary server address	XXX.XXX.XXX.XXX
Secondary Server	Secondary server address	XXX.XXX.XXX.XXX
Proxy Server	Proxy Server setting	Enable/Disable
Proxy Port	Specifying Proxy Port	1 to 65535
Proxy Address	Proxy Address	XXXXXXXXXXXXXXXXXXXXXXX

("XX" represents alphanumeric characters.)

*1 Depending on the country or region of purchase, one of the channels from 1 to 11 is printed.

*2 Only when IPv6 is enabled, the status of the network is printed.

*3 Only IPv6 and the IPsec setting are enabled, the status of the network is printed.

About Network Communication

- **Changing and Confirming Network Settings**
- **Appendix for Network Communication**

Changing and Confirming Network Settings

- ▶ **IJ Network Tool**
- ▶ **Canon IJ Network Tool Screen**
- ▶ **Canon IJ Network Tool Menus**
- ▶ **Changing the Settings in the Wireless LAN Sheet**
- ▶ **Changing the WEP Detailed Settings**
- ▶ **Changing the WPA/WPA2 Detailed Settings**
- ▶ **Changing the Settings in the Wired LAN Sheet**
- ▶ **Changing the Settings in the Admin Password Sheet**
- ▶ **Monitoring Wireless Network Status**
- ▶ **Initializing the Network Settings of the Machine**
- ▶ **Viewing the Modified Settings**

IJ Network Tool

IJ Network Tool is a utility that enables you to display and modify the machine network settings. It is installed when the machine is set up.

▶▶▶ Important

- To use the machine over LAN, make sure you have the equipment necessary for the connection type, such as an access point or a LAN cable.
- Do not start up IJ Network Tool while printing.
- Do not print when IJ Network Tool is running.
- If the firewall function of your security software is turned on, a message may appear warning that Canon software is attempting to access the network. If the warning message appears, set the security software to always allow access.

Starting up IJ Network Tool

1. Select **Applications** from the **Go** menu of Finder, double-click **Canon Utilities > IJ Network Tool**, and double-click the **Canon IJ Network Tool** icon.

Depending on the printer you are using, an administrator password is already specified for the printer at the time of purchase. When you change the network settings, authentication by the administrator password is required.

For details:

■ [About the Administrator Password](#)

For improving security, it is recommended to change the administrator password.

■ [Changing the Settings in the Admin Password Sheet](#)

Canon IJ Network Tool Screen

This section describes the items displayed on the **Canon IJ Network Tool** screen.

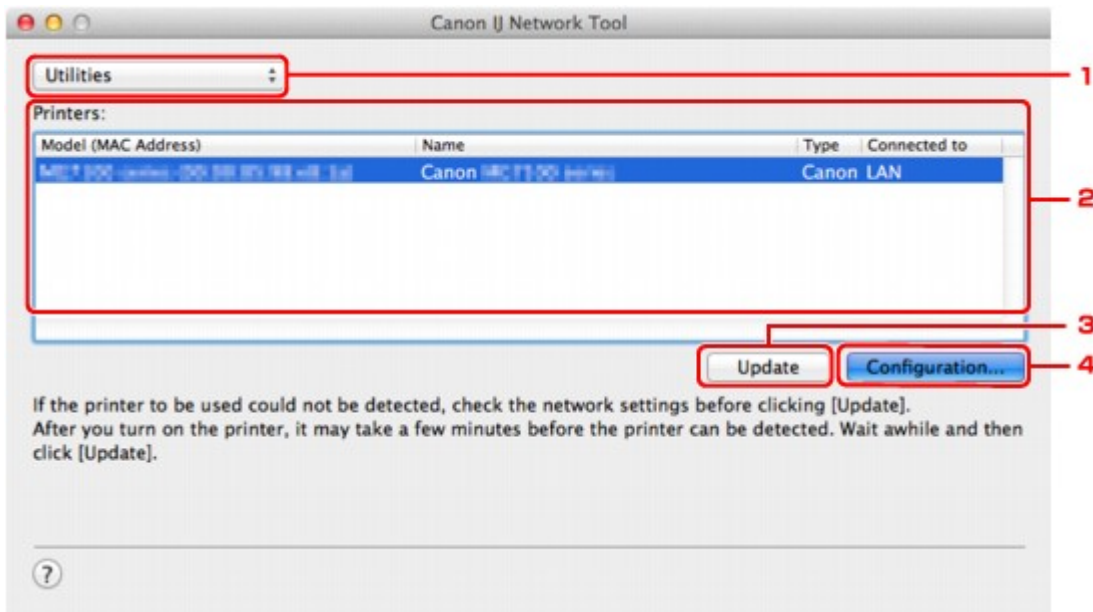

1. Utilities

Modifies the settings of the machine.

Select to change the network name (SSID) settings.

Setup

Sets up the machine.

If you setup the machine from scratch, connect your computer and the machine with a USB cable.

2. Printers:

Printer name, type, and connection destination are displayed.

The selected printer can be set up or be modified.

3. Update

Performs printer detection again. Click this button if the target printer is not displayed.

▶▶▶ Important

- To change the printer's network settings using IJ Network Tool, it must be connected via a LAN.
- If the printer on a network is not detected, make sure that the printer is turned on, then click **Update**. It may take several minutes to detect printers. If the printer is not yet detected, connect the machine and the computer with a USB cable, then click **Update**.
- If the printer is being used from another computer, a screen is displayed informing you of this condition.

▶▶▶ Note

- This item has the same function as **Refresh** in the **View** menu.

4. **Configuration...**

Enabled when **Utilities** is selected. Click to display the **Configuration** screen to configure settings of the selected printer.

Note

- This item has the same function as **Configuration...** in the **Settings** menu.

Canon IJ Network Tool Menus

This section describes the menus in **Canon IJ Network Tool**.



1. Canon IJ Network Tool menu

About Canon IJ Network Tool

Displays the version of this application.

Quit Canon IJ Network Tool

Exits IJ Network Tool.

2. View menu

Status

Displays the **Status** screen to confirm the printer connection status and wireless communication status.

In the access point mode, this item is grayed out and you cannot confirm the printer connection status.

Refresh

Updates and displays the contents of **Printers**: to the latest information.

▶▶▶ Important

- To change the printer's network settings using IJ Network Tool, it must be connected via a LAN.
- If the printer on a network is not detected, make sure that the printer is turned on, then select **Refresh**. It may take several minutes to detect printers. If the printer is not yet detected, connect the machine and the computer with a USB cable, then select **Refresh**.
- If the printer is being used from another computer, a screen is displayed informing you of this condition.

▶▶▶ Note

- This item has the same function as **Update** in the **Canon IJ Network Tool** screen.

Network Information

Displays the **Network Information** screen to confirm the network settings of the printer.

3. Settings menu

Configuration...

Displays the **Configuration** screen to configure settings of the selected printer.

▶▶▶ Note

- This item has the same function as **Configuration...** in the **Canon IJ Network Tool** screen.

Maintenance...

Displays the **Maintenance** screen to revert the network settings of the printer to factory default.

Set up printer's wireless LAN...

You can change the access point mode settings. Perform settings following the message on the screen.

If you change the **Encryption Method:** setting and the **Password:** setting, on the **Set up printer's wireless LAN** screen, the changed settings are applied to the printer settings.

▶▶▶ Note

- You can use this function only when you are using a computer compatible with the wireless LAN.

4. Help menu

Instructions

Displays this guide.

Changing the Settings in the Wireless LAN Sheet

To change the wireless network settings of the printer, connect the printer and the computer with a USB cable temporarily. If you modify the wireless network settings of the computer over wireless connection without USB connection, your computer may not be able to communicate with the machine after modifying the settings.

▶▶▶ Note

- This screen is not available depending on the printer you are using.
- Activate the wireless LAN setting of the printer to change the settings in the **Wireless LAN** sheet.

1. [Start up IJ Network Tool.](#)

2. Select the printer in **Printers**:

When the printer is connected to the computer with a USB cable temporarily, select the printer with **USB** appearing in the **Connected to** column.

3. Click the **Configuration...** button.

4. Click the **Wireless LAN** button.

5. Change the settings or confirm.

Click **OK** after changing configuration. A screen is displayed asking you for confirmation before the settings are sent to the printer. If you click **OK**, the settings are sent to the printer and the **Transmitted Settings** screen is displayed.



1. Network Type:

Displays the wireless LAN mode currently selected.

AirPort Network (Infra)

Connects the printer to the wireless LAN with an access point.

Access point mode

Connects external wireless communication devices (e.g. computers, smartphones, or tablets) to the printer using it as an access point.

»» Note

- When **Access point mode** is displayed on **Network Type:**, you cannot change the settings on the **Wireless LAN** sheet or the **Admin Password** sheet.
 - You can perform setting from **Set up printer's wireless LAN...** on the **Settings** menu when you use the printer with the access point mode.
- Depending on the printer you are using, you can change the settings using the operation panel.

2. Network (SSID):

The network name (SSID) of the wireless LAN currently used is displayed.

In the access point mode, the access point name (SSID) of the printer is displayed.

»» Note

- Enter the same SSID that the access point is configured to use. The SSID is case-sensitive.

3. Search...

The **Access Points** screen is displayed to select an access point to connect to.

 [Access Points Screen](#)

»» Note

- When IJ Network Tool runs over a LAN, the button is grayed out and cannot be selected. Connect the printer and the computer with a USB cable temporarily to change the settings.

4. Encryption Method:

Select the encryption method used over the wireless LAN.

»» Important

- If all encryption types of the access point, printer, or computer do not match, the printer cannot communicate with the computer. If the printer cannot communicate with the computer after the encryption type of the printer was switched, make sure that encryption types for the computer and the access point match that set to the printer.
- If you connect to a network that is not protected with security measures, there is a risk of disclosing data such as your personal information to a third party.

Do Not Use

Select to disable encryption.

Use Password (WEP)

Transmission is encrypted using a WEP key you specified.

If a network password (WEP) has not been set, the **WEP Details** screen is displayed automatically. To change WEP settings set before, click **Configuration...** to display the screen.

 [Changing the WEP Detailed Settings](#)

Use WPA/WPA2

Transmission is encrypted using a network key you specified.

The security has been strengthened more than WEP.

If a network key has not been set, the **Authentication Type Confirmation** screen is displayed automatically. To change network key settings before, click **Configuration...** to display the **WPA/WPA2 Details** screen.

■ [Changing the WPA/WPA2 Detailed Settings](#)

5. Configuration...

The detailed settings screen is displayed. The network password (WEP) or the WPA/WPA2 key selected in **Encryption Method**: can be confirmed and changed.

For details on WEP setting:

■ [Changing the WEP Detailed Settings](#)

For details on WPA/WPA2 setting:

■ [Changing the WPA/WPA2 Detailed Settings](#)

6. TCP/IP Setting:

Sets the IP address of the printer to be used over the LAN. Specify a value appropriate for your network environment.

Get IP address automatically

Select this option to use an IP address automatically assigned by a DHCP server. DHCP server functionality must be enabled on your wireless LAN router or access point.

Use following IP address

Select this option if no DHCP server functionality is available in your setup where you use the printer, or you want to use a particular IP address or a fixed IP address.

• Access Points Screen

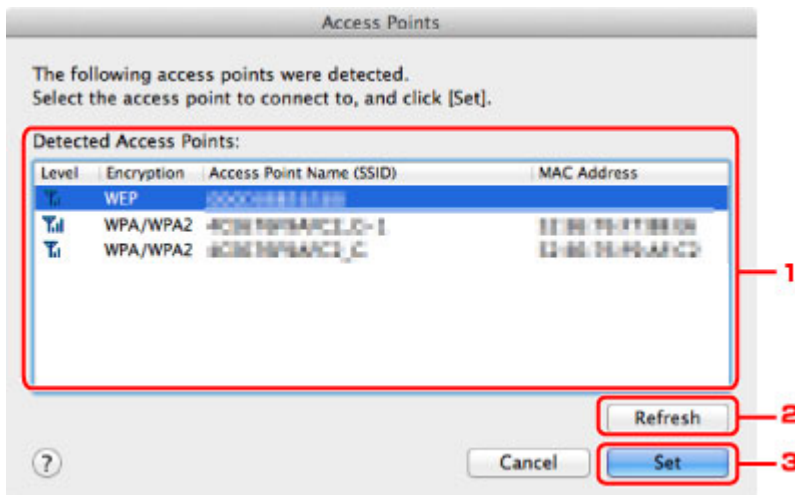

1. Detected Access Points:

The signal strength from the access point, encryption type, name of access point, and the radio channel can be confirmed.

►►► Important

- If you connect to a network that is not protected with security measures, there is a risk of disclosing data such as your personal information to a third party.

»» Note

- Signal strength is displayed as follows.

 : Good

 : Fair

 : Poor

- Type of encryption is displayed as follows.

Blank: No encryption

WEP: WEP is set

WPA/WPA2: WPA/WPA2 is set

2. Refresh

Click to update the list of access points when your target access point is not detected.

If the target access point is set to a closed network (the stealth mode), click **Cancel** to return to the previous screen and enter the network name (SSID) in **Network (SSID)**.

»» Note

- Make sure that the access point is turned on.

3. Set

Click to set the network name (SSID) in **Network (SSID)**: on the **Wireless LAN** sheet.

»» Note

- The **WEP Details** screen or the **WPA/WPA2 Details** screen appears if the selected access point is encrypted. In this case, configure the details to use the same encryption settings set to the access point.
- Access points that cannot be used by this machine (including those configured to use different encryption methods) are displayed grayed out and cannot be configured.

Changing the WEP Detailed Settings

▶▶▶ Note

- This screen is not available depending on the printer you are using.

To change the wireless network settings of the printer, connect the printer and the computer with a USB cable temporarily. If you modify the wireless network settings of the computer over wireless connection without USB connection, your computer may not be able to communicate with the machine after modifying the settings.

1. [Start up IJ Network Tool.](#)

2. Select the printer in **Printers:**.

When the printer is connected to the computer with a USB cable temporarily, select the printer with **USB** appearing in the **Connected to** column.

3. Click the **Configuration...** button.

4. Click the **Wireless LAN** button.

5. Select **Use Password (WEP)** in **Encryption Method:** and click **Configuration....**

The **WEP Details** screen is displayed.

6. Change the settings or confirm.

When changing the password (WEP key), the same change must be made to the password (WEP key) of the access point.

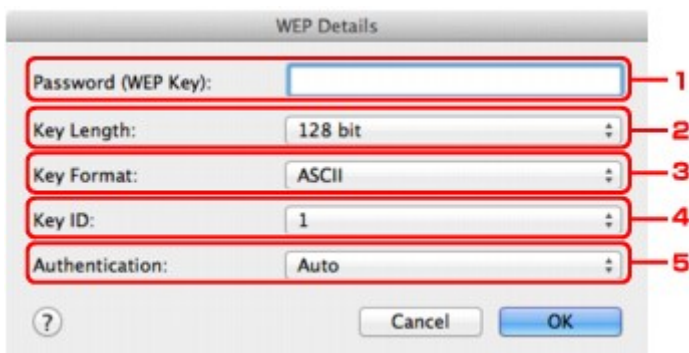

1. Password (WEP Key):

Enter the same key as the one set to the access point.

The number of characters and character type that can be entered differ depending on the combination of the key length and key format.

		Key Length	
		64 bit	128 bit
Key Format	ASCII	5 characters	13 characters

	Hexadecimal (Hex)	10 digits	26 digits
--	----------------------------	-----------	-----------

2. **Key Length:**

Select either **64 bit** or **128 bit**.

3. **Key Format:**

Select either **ASCII** or **Hex**.

4. **Key ID:**

Select the Key ID (index) set to the access point.

»» Note

- When the printer is connected to an AirPort Base Station via a LAN:

When the printer is connected to an AirPort Base Station via a LAN, confirm the settings in **Wireless Security** of **AirPort Utility**.

- Select **64 bit** if **WEP 40 bit** is selected for the key length in the AirPort Base Station.
- Select **1** for **Key ID**. Otherwise your computer will not be able to communicate with the printer via the access point.

5. **Authentication:**

Select the authentication method to authenticate the printer's access to the access point.

Normally, select **Auto**. If you want to specify the method manually, select **Open System** or **Shared Key** according to the setting of the access point.

7. Click **OK**.

»» Important

- If the printer cannot communicate with the computer after the encryption type of the printer was switched, make sure that encryption types for the computer and the access point match that set to the printer.

Changing the WPA/WPA2 Detailed Settings

▶▶▶ Note

- This screen is not available depending on the printer you are using.

To change the wireless network settings of the printer, connect the printer and the computer with a USB cable temporarily. If you modify the wireless network settings of the computer over wireless connection without USB connection, your computer may not be able to communicate with the machine after modifying the settings.

The example screenshots in this section refer to the WPA detailed settings.

1. [Start up IJ Network Tool.](#)

2. Select the printer in **Printers:**.

When the printer is connected to the computer with a USB cable temporarily, select the printer with **USB** appearing in the **Connected to** column.

3. Click the **Configuration...** button.

4. Click the **Wireless LAN** button.

5. Select **Use WPA/WPA2** in **Encryption Method:** and click **Configuration....**

6. Enter the passphrase, then click **OK**.

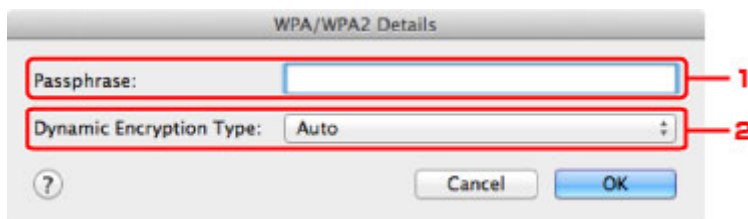

1. **Passphrase:**

Enter the passphrase set to the access point. The passphrase should be a string of 8 to 63 alphanumeric characters or a 64-digit hexadecimal value.

If you do not know the access point passphrase, refer to the instruction manual provided with the access point or contact its manufacturer.

2. **Dynamic Encryption Type:**

The dynamic encryption method is selected from either TKIP (basic encryption) or AES (secure encryption) automatically.

▶▶▶ Important

- If **Auto** is not displayed on **Dynamic Encryption Type:**, select either **TKIP(Basic Encryption)** or **AES(Secure Encryption)**.

- If the printer cannot communicate with the computer after the encryption type of the printer was switched, make sure that encryption types for the computer and the access point match that set to the printer.

▶▶ Note

- This machine supports WPA/WPA2-PSK (WPA/WPA2-Personal) and WPA2-PSK (WPA2-Personal).
-

Changing the Settings in the Wired LAN Sheet

▶▶▶ Note

- This screen is not available depending on the printer you are using.
- Activate the wired LAN setting of the printer to change the settings in the **Wired LAN** sheet.

1. [Start up IJ Network Tool.](#)
2. Select the printer in **Printers:**.
3. Click the **Configuration...** button.
4. Click the **Wired LAN** button.
5. Change the settings or confirm.

Click **OK** after changing configuration. A screen is displayed asking you for confirmation before the settings are sent to the printer. If you click **OK**, the settings are sent to the printer and the **Transmitted Settings** screen is displayed.

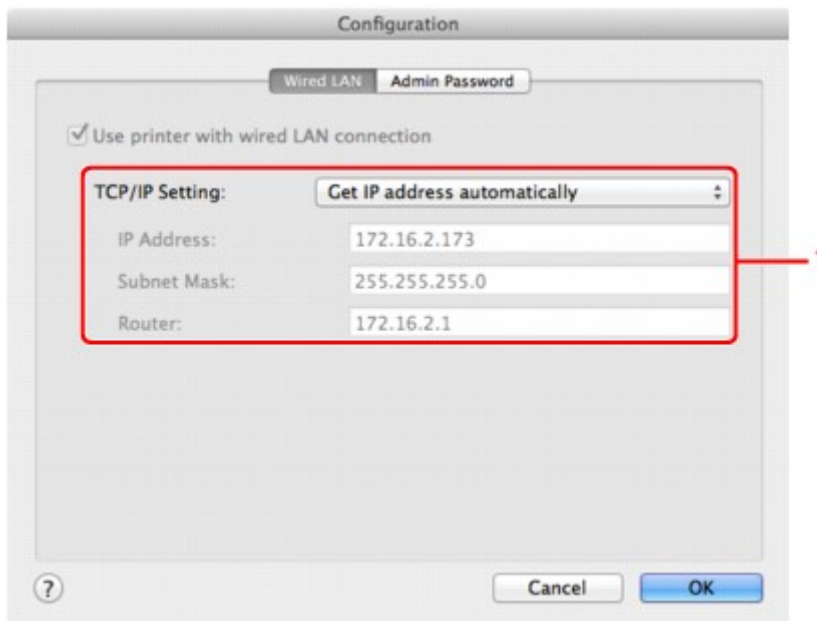

1. TCP/IP Setting:

Sets the IP address of the printer to be used over the LAN. Specify a value appropriate for your network environment.

Get IP address automatically

Select this option to use an IP address automatically assigned by a DHCP server. DHCP server functionality must be enabled on your router.

Use following IP address

Select this option if no DHCP server functionality is available in your setup where you use the printer, or you want to use a particular IP address or a fixed IP address.

Changing the Settings in the Admin Password Sheet

►►► Note

- You cannot change the settings when using the access point mode.

1. [Start up IJ Network Tool.](#)
2. Select the printer in **Printers:**.
3. Click the **Configuration...** button.
4. Click the **Admin Password** button.
The **Admin Password** sheet is displayed.
5. Change the settings or confirm.



1. Use admin password

Set an administrator password with privileges to set up and change detailed options. To use this feature, select this check box and enter a password.

►►► Important

- The password should consist of alphanumeric characters and be no longer than 32 characters. The password is case-sensitive. Do not forget the password you set.

2. Password:

Enter the password to set.

3. Password Confirmation:

Enter the password again for confirmation.

6. Click **OK**.

A screen is displayed asking you for confirmation before the settings are sent to the printer. If you click **OK**, the settings are sent to the printer and the **Transmitted Settings** screen is displayed.

Enter Password Screen

The following screen is displayed if an administrator password is set to the printer.



- **Admin Password**

Enter the administrator password that was set. For security purposes, your password is not displayed as you type it.

»» Important

- If you forget the administrator password you specified, initialize the printer to revert the password to the default setting.

- **OK**

Click this item after you enter the administrator password.

- **Cancel**

This item returns you to list of detected printers. If you do not enter the correct administrator password, you cannot operate the printer.

Monitoring Wireless Network Status

▶▶▶ Note

- This screen is not available depending on the printer you are using.
- When using the machine over the wired LAN, you cannot monitor network status.

1. [Start up IJ Network Tool.](#)
2. Select the printer in **Printers:**.
3. Select **Status** from the **View** menu.

The **Status** screen is displayed and you can check the printer status and connection performance.

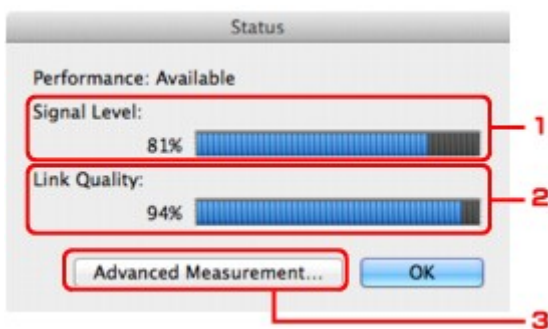

1. **Signal Level:**

Indicates the strength of the signal received by the printer, ranging from 0% to 100%.

2. **Link Quality:**

Indicates the signal quality excluding the noise while communicating, ranging from 0% to 100%.

▶▶▶ Important

- If the indicated value is low, move your printer closer to the wireless network device.

3. **Advanced Measurement...**

Click to examine the connection performance between the printer and the access point. Follow the instructions on the screen to start measuring and display the status. Measurement takes a few minutes.

When  is displayed in **Connection performance between the printer and the access point:**, the printer can communicate with the access point. Otherwise, refer to displayed comments and Help for improving the status of communication link, and click **Remeasurement**.

- Check that the printer and the access point are located within the wireless connectivity range with no obstacles between them.

- Check if the distance between the printer and the access point is not too far.

If they are too far, move them closer together (within 164 ft./50 m).

- Check that there is no barrier or obstacle between the printer and the access point.

In general, connection performance decreases for communications through walls or between different floors. Adjust the locations to avoid such situations.

- Check that there are no sources of radio interference near the printer and the access point.

The wireless connection may use the same frequency band as microwave ovens and other sources of radio interference. Try to keep the printer and the access point away from such sources.

- Check if the radio channel of the access point is close to that of other access points nearby.

If the radio channel of the access point is close to that of other access points nearby, the connection performance may become unstable. Be sure to use a radio channel that does not interfere with other access points.

- Check that the printer and the access point face each other.

Connection performance may depend on the orientations of the wireless devices. Replace the access point and the printer in another direction to achieve the best performance.

- Check whether other computers are not accessing the printer.

If  appears in the result of the measurement, check whether other computers are not accessing the printer.

If  still appears even if you have tried the above, finish the measurement, then restart the IJ Network Tool to start over the measurement.

Note

- If any messages appear on **Overall Network Performance:**, move the machine and access point as instructed to improve the performance.

Initializing the Network Settings of the Machine

▶▶▶ Important

- Note that initialization erases all network settings on the machine, and printing or scanning operation from a computer over network may become impossible. To use the machine over network, perform setup according to the instructions on our website.

1. [Start up IJ Network Tool.](#)
2. Select the printer in **Printers:**.
3. Select **Maintenance...** from the **Settings** menu.

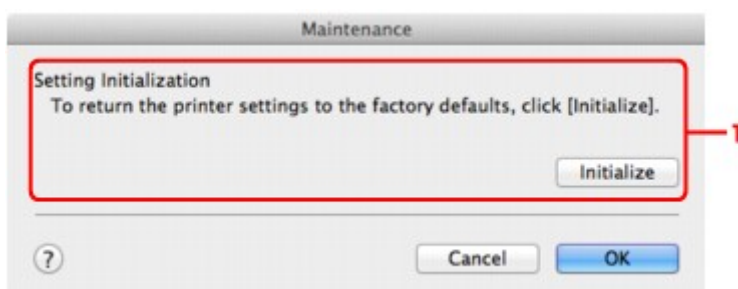

1. **Setting Initialization**

Initialize

Reverts all the network settings of the printer to factory default.

4. Click **Initialize**.

The **Setting Initialization** screen is displayed.

Click **OK** to initialize the network settings of the printer. Do not turn off the printer during initialization.

Click **OK** when initialization is complete.

Performing initialization when connected over wireless LAN will break the connection, so perform setup according to the instructions on our website.

▶▶▶ Note

- You can change the network settings of the printer using IJ Network Tool with USB connection after initializing the LAN settings. To change the network settings using Canon IJ Network Tool, activate wireless LAN in advance.

Viewing the Modified Settings

The **Confirmation** screen is displayed when you modified the printer settings on the **Configuration** screen. When you click **OK** on the **Confirmation** screen, the following screen is displayed for confirming the modified settings.

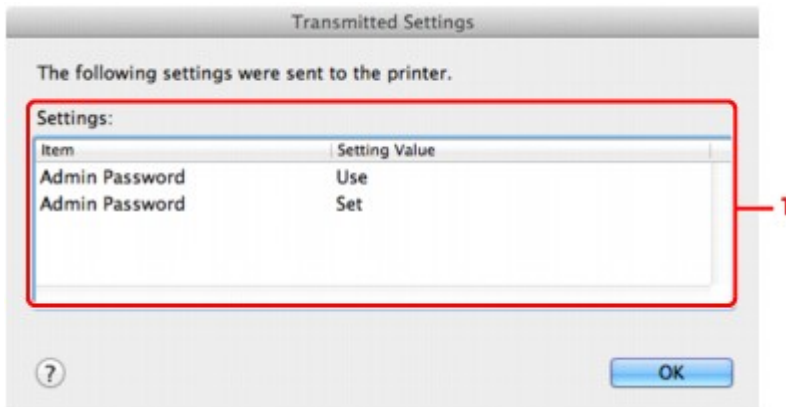

1. Settings:

A list of changes made in the **Configuration** screen is displayed.

Appendix for Network Communication

- ▶ **Using the Card Slot over a Network**
- ▶ **About Technical Terms**
- ▶ **Restrictions**

Using the Card Slot over a Network

▶▶▶ Note

- This screen is not available depending on the printer you are using.

■ [Mounting the Card Slot as the Network Drive](#)

■ [Restrictions on Card Slot Use over a Network](#)

Mounting the Card Slot as the Network Drive

The card slot must be mounted to use it over a network.

To mount the card slot as the network drive, follow the procedure below.

1. Insert a memory card into the card slot of the machine.
2. Check the current printer name.
You can check the current printer name on the LCD of the printer.
3. On Finder, click the **Go** menu and **Connect to Server**.
4. Input "smb://xxxxxxxxxxx/canon_memory/", then click **Connect**.

For example, if the current printer name is "123ABC000000", then input "smb://123ABC000000/canon_memory/".

5. Make sure that the card slot is mounted.

When the card slot is mounted, the following icon appears on the desktop or in the **Computer** window on the **Go** menu of Finder.



▶▶▶ Note

- The authentication screen may appear. If it appears, you do not need to input the password.
- If you cannot mount the card slot with the method above, input the IP address of the machine instead of the current printer name, and try again. For example, "smb://192.168.1.1/canon_memory/". If you mount the card slot with the IP address, you have to remount it whenever the machine's IP address changes.

Restrictions on Card Slot Use over a Network

- You cannot write data to a memory card in the card slot over a network. You can only read data from a memory card.

- The card slot can be shared by multiple computers, if the machine is connected to a network. Multiple computers can read files from a memory card in the card slot at the same time.
- If your computer joins a domain, the card slot may not be mounted as the network drive.
- If you use the memory card stored the large size files or many files, a large amount of card access may be generated. In this case, the operation in the memory card may be impossible or slow. Operate after the **Access** lamp of the machine is lit.

- When you access the network drive for the card slot over the network, file names consisting of eight or less lowercase letters (not including its extension) may be shown in uppercase.

For example, a file name such as "abcdefg.doc" will be "ABCDEFGG.DOC", while a name such as "AbcdeFG.doc" will appear the same.

The file is not actually renamed, but merely appears to be changed.

- Disable the function to write files to a memory card from a computer to read files from a memory card over a network.

About Technical Terms

In this section, technical terms used in the manual are explained.

[A](#)

[B](#)

[C](#)

[D](#)

[E](#)

[F](#)

[G](#)

[H](#)

[I](#)

[J](#)

[K](#)

[L](#)

[M](#)

[N](#)

[O](#)

[P](#)

A

- **Access Point**

A wireless transceiver or base station that receives information from wireless clients/the machine and rebroadcasts it. Required in an infrastructure network.

- **Access point mode**

The machine is used as an access point to connect external wireless communication devices (e.g. computers, smartphones, or tablets) in an environment where no access point or wireless LAN router is available. You can connect up to 5 devices to the machine using the access point mode.

- **Ad-hoc**

Client computer and machine setting where wireless communication occurs on a peer-to-peer basis, i.e., all clients in with the same SSID/network name communicate directly with each other. No access point is required. This machine does not support ad-hoc communication.

- **Admin Password**

Administrator password in IJ Network Tool to restrict access to network users. It must be entered to access the printer and change printer settings.

- **AES**

An encryption method. It is optional for WPA/WPA2. Strong cryptographic algorithm adopted within U.S. government organizations for information processing.

- **AirPort Network (Infra)**

Client computer and machine setup where all wireless communications pass through an access point.

- **Authentication Method**

The method that an access point uses to authenticate a printer through a wireless LAN. The methods are agreeable each other.

When using WEP as an encryption method, the authentication method is able to fix to **Open System** or **Shared Key**.

For WPA/WPA2, authentication method is PSK.

- **Auto**

The printer automatically changes its authentication method to match the access point.

- **Open System**

In this authentication method, the communication partner is authenticated without using WEP key even if **Use Password (WEP)** is selected.

- **Shared Key**

In this authentication method, the communication partner is authenticated using the WEP key that was set for encryption.

B

- **Bonjour**

A service built into Mac OS X operating system to detect the connectable devices on a network automatically.

C

- **Channel**

Frequency channel for wireless communication. In the infrastructure mode, the channel is automatically adjusted to match that set to the access point. This machine supports channels 1 to 13. (Channels 12 and 13 are not supported depending on the country or region of purchase.) Note that the number of channels that can be used for your wireless LAN varies depending on the region or country.

D

- **DHCP server functionality**

The router or the access point assigns an IP address automatically whenever the printer or the personal computer on a network starts up.

- **DNS server**

A server that converts device names into IP addresses. When specifying IP addresses manually, specify the addresses of both a primary and a secondary server.

F

- **Firewall**

It is a system that prevents an unlawful computer access in the network. To prevent, you can use the firewall function of a broadband router, the security software installed in the computer, or operation system for computer.

I

- **IEEE 802.11b**

International standard for wireless LAN using the 2.4 GHz frequency range with a throughput of up to 11 Mbps.

- **IEEE 802.11g**

International standard for wireless LAN using the 2.4 GHz frequency range with a throughput of up to 54 Mbps. Compatible with 802.11b.

- **IEEE 802.11n**

International standard for wireless LAN using the 2.4 GHz and 5 GHz frequency ranges. Even when using two or more antennas simultaneously or obtaining a bigger transfer rate than before by using multiple communication channels at the same time, the transmission speed may be influenced by the connected apparatus.

At the maximum transfer rate of 600 Mbps, it is possible to communicate with multiple computer terminals within a dozen or so metre radius.

Compatible with 802.11b and 802.11g.

- **IP Address**

A unique number with four parts separated by dots. Every network device that is connected to the Internet has an IP address. Example: 192.168.0.1

An IP address is usually assigned by an access point or a DHCP server of the router automatically.

- **IPv4/IPv6**

They are internetwork-layer protocol used on the internet. IPv4 uses 32-bit addresses and IPv6 uses 128-bit addresses.

K

- **Key Format**

Select either **ASCII** or **Hex** as the Password (WEP) key format. The character that can be used for the WEP key differs depending on the selected key formats.

- ASCII

Specify with a 5 or 13-character string that can include alphanumeric and underscore "_" characters. It is case-sensitive.

- Hex

Specify a 10-digit or 26-digit string that can contain hexadecimal (0 to 9, A to F, and a to f).

- **Key Length**

Length of the WEP key. Select either 64 bits or 128 bits. Longer key length allows you to set a more complex WEP key.

L

- **Link Quality**

The status of connection between the access point and the printer excluding noise (interference) is indicated with a value from 0 to 100%.

- **LPR**

A platform-independent printing protocol used in TCP/IP networks. It is not supported bidirectional communication.

M

- **MAC Address (AirPort ID)**

Also known as the physical address. A unique and permanent hardware identifier that is assigned to network devices by its manufacturer. MAC addresses are 48 bits long and are written as a hexadecimal number separated by colons, i.e., 11:22:33:44:55:66.

N

- **Network (SSID)**

Unique label for wireless LAN. It is often represented such as a network name or a access point name.

SSID distinguishes one wireless LAN from another to prevent interference.

The printer and all clients on a wireless LAN must use the same SSID in order to communicate with each other. The SSID can be up to 32 characters long, and is made up of alphanumeric characters. The SSID may also be referred to by its network name.

P

- **Password (WEP)/Password (WEP Key)**

An encryption method employed by IEEE 802.11. Shared security key used to encrypt and decrypt data sent over wireless networks. This printer supports key length of 64 bits or 128 bits, key format of ASCII code or Hexadecimal, and key number of 1 to 4.

- **Performance**

Indicates the status on whether the printer can be used.

- **Proxy server**

A server that links a LAN-connected computer to the Internet. When using a proxy server, specify the address and the port number of the proxy server.

- **PSK**

An encryption method employed by WPA/WPA2.

R

- **Router**

A relay device to connect to another network.

S

- **Signal Level**

The strength of the signal received by the printer from the access point is indicated with a value from 0 to 100%.

- **SSID**

Unique label for wireless LAN. It is often represented such as a network name or an access point name.

SSID distinguishes one wireless LAN from another to prevent interference.

The printer and all clients on a wireless LAN must use the same SSID in order to communicate with each other. The SSID can be up to 32 characters long, and is made up of alphanumeric characters. The SSID may also be referred to by its network name.

- **Stealth**

In the stealth mode, an access point hides itself by not broadcasting its SSID. The client must specify the SSID set to the access point to detect it.

The stealth mode is called a "closed network".

- **Subnet Mask Address**

IP address has two components, the network address and the host address. Subnet Mask used to calculate the Subnet Mask address from the IP address. A Subnet Mask is usually assigned by an access point or a DHCP server of the router automatically.

Example:

IP Address: 192.168.127.123

Subnet Mask: 255.255.255.0

Subnet Mask Address: 192.168.127.0

T

- **TCP/IP**

Suite of communications protocols used to connect hosts on the Internet or the LAN. This protocol allows different terminals to communicate with each other.

- **TKIP**

An encryption protocol employed by WPA/WPA2.

U

- **USB**

Serial interface designed to enable you to "hot-swap" devices, i.e., by plugging and unplugging them without turning off the power.

W

- **WEP/WEP Key**

An encryption method employed by IEEE 802.11. Shared security key used to encrypt and decrypt data sent over wireless networks. This printer supports key length of 64 bits or 128 bits, key format of ASCII code or Hexadecimal, and key number of 1 to 4.

- **Wi-Fi**

International association that certifies interoperability of wireless LAN products based on the IEEE 802.11 specification.

This machine is a Wi-Fi authorized product.

- **Wireless LAN**

A network that, instead of being connected by physical wires, is connected by a wireless technology, such as Wi-Fi.

- **WPA**

Security framework announced by the Wi-Fi Alliance in October 2002. The security has been strengthened more than WEP.

- Authentication

WPA defines the following authentication methods: WPA Personal that can be used without an authentication server, plus WPA Enterprise that do require an authentication server.

This machine supports WPA Personal.

- Passphrase

This encrypted key is used to perform WPA Personal authentication.

The passphrase should be a string of 8 to 63 alphanumeric characters or a 64-digit hexadecimal value.

- **WPA2**

Security framework released by the Wi-Fi Alliance in September 2004 as a later version of WPA. Provides a stronger encryption mechanism through Advanced Encryption Standard (AES).

- Authentication

WPA2 defines the following authentication methods: WPA2 Personal that can be used without an authentication server, plus WPA2 Enterprise that do require an authentication server.

This machine supports WPA2 Personal.

- Passphrase

This encrypted key is used to perform WPA2 Personal authentication.

The passphrase should be a string of 8 to 63 alphanumeric characters or a 64-digit hexadecimal value.

- **WPS (Wi-Fi Protected Setup)**

WPS is a standard for easy and secure establishment of a wireless network.

There are 2 primary methods used in the Wi-Fi Protected Setup:

PIN entry: a mandatory method of setup for all WPS certified devices

Push button configuration (PBC): an actual push button on the hardware or through a simulated push button in the software.

Restrictions

If you use a printer over the wireless LAN, the printer may recognize nearby wireless systems, you should set a network key (WEP or WPA/WPA2) to the access point to encrypt wireless transmission. Wireless communication with a product that does not comply with the Wi-Fi standard cannot be guaranteed.

Connecting with too many computers may affect the printer performance, such as printing speed.

Tips for Ensuring Optimal Printing Quality

- ▶ **Useful Information about Ink**
- ▶ **Key Points to Successful Printing**
- ▶ **Be Sure to Check Paper Settings before Printing**
- ▶ **Be Sure to Set Cassette Paper Information after Loading Paper**
- ▶ **Canceling a Print Job**
- ▶ **Key to Enjoying Consistent Printing Quality**
- ▶ **Precautions for Safe Transport of the Machine**

Useful Information about Ink

How is ink used for various purposes other than printing?

Ink may be used for purposes other than printing.

When you use the Canon printer for the first time after you install the bundled ink tanks, the printer consumes a small amount of ink in the amount to enable printing by filling the nozzles of the Print Head with ink.

The printing costs described in the brochures or websites are based on the consumption data from not the first ink tank /ink cartridge but the succeeding ink tank /ink cartridge.

Ink is sometimes used to maintain the optimal printing quality.

To keep printer's performance, Canon printer performs cleaning automatically according to its condition. When the printer performs cleaning, a small amount of ink is consumed. In this case, all colors of ink may be consumed.

[Cleaning function]

The cleaning function helps the printer to suck air bubbles or ink itself from the nozzle and thus prevents print quality degradation or nozzle clogging.

Does black-and-white printing use color ink?

Black-and-white printing may use ink other than black ink depending on the type of printing paper or the settings of the printer driver. So, color ink is consumed even when printing in black-and-white.

▶▶▶ Note

- The machine uses pigment ink. Due to the nature of the pigment ink, the ink on the printed surface may be removed when being rubbed or scratched.

Key Points to Successful Printing

Check the machine status before printing!

- Is the print head OK?

If a print head nozzle is clogged, print will be faint and papers will be wasted. Print the nozzle check pattern to check the print head.

■ [Maintenance Procedure](#)

- Is the inside of the machine smeared with ink?

After printing large quantities of paper, the area where papers go through may get smeared with ink. Clean the inside of your machine with [Bottom Plate Cleaning](#).

Check how to load the paper correctly!

- Is the paper loaded in the correct orientation?

To load paper in a cassette, load paper WITH THE PRINTING SIDE FACING DOWN.

■ [Loading Paper](#)



- Is the paper curled?

The curled paper causes paper jam. Flatten the curled paper, then reload it.

■ "Load the paper after correcting its curl." in [Paper Is Smudged/Printed Surface Is Scratched](#)

Be Sure to Check Paper Settings before Printing

Before printing, make paper settings in the operation panel or the computer screen.

There are various types of paper, such as paper with a special surface coating for printing photos at optimal quality and paper suitable for documents.

Each media type has specific preset settings (how ink is used and sprayed, distance from nozzles, etc.), that allow you to print to that type with optimal image quality. The wrong paper settings may cause poor printout color quality or scratches on the printed surface.

If you notice blurring or uneven colors, increase the print quality setting and try printing again.

Be Sure to Set Cassette Paper Information after Loading Paper

When you insert a cassette into the machine after loading paper, the screen for setting the type and size of paper is displayed. Set the cassette paper information according to the type and size of loaded paper.

To prevent incorrect printing, this machine has a function that detects whether the information set for the paper loaded in the cassette matches the paper settings. Before printing, make paper settings in accordance with the cassette paper information. When this function is enabled, an error message is displayed if these settings do not match to prevent incorrect printing. When this error message is displayed, check and correct the paper settings.

To check cassette paper information, display the paper information screen on the operation panel.

Canceling a Print Job

Never press the ON button!

If you press the **ON** button while printing is in progress, the print data sent from the computer queues in the machine and you may not be able to continue to print.

Press the **Stop** button to cancel printing.

Key to Enjoying Consistent Printing Quality

The key to printing with the optimal printing quality is to prevent the print head from drying or clogging. Always observe the following rules for optimal printing quality.

Never unplug the power cord until the power is turned off!

If you press the **ON** button to turn off the power, the machine caps the print head (nozzles) automatically to prevent from drying. If you unplug the power cord from the wall outlet while the **POWER** lamp is lit or flashing, the print head will not be capped properly and this will cause drying or clogging.

When [unplugging the power cord](#), make sure that the **POWER** lamp is not lit.

▶▶▶ Important

- If the power cord is unplugged, all documents stored in the machine's memory will be lost. Send or print a necessary document, or save it on a USB flash drive before unplugging the power cord.

Print periodically!

Just as the tip of a felt pen becomes dry and unusable if it has not been used for a long time, even if it is capped, the print head too, may become dried or clogged if the machine has not been used for a long time. We recommend you to use the machine at least once a month.

Ink is mixed at fixed intervals.

The machine is set to automatically mix the ink to maintain optimal printing quality. Therefore, printing on a regular basis helps keep the ink in good condition.

If the machine is not used for an extended period of time, the machine will automatically mix the ink before printing.

▶▶▶ Note

- Depending on the type of paper, ink may blur if you trace the printed area with a highlight pen or paint-stick, or bleed if water or sweat comes in contact with the printed area.

Precautions for Safe Transport of the Machine

When relocating the machine, make sure of the following.

▶▶▶ Important

- Pack the machine in a sturdy box so that it is placed with its bottom facing down, using sufficient protective material to ensure safe transport.
- Always transport the machine with ink tanks installed. If you transport the machine without ink tanks, ink in the print head may leak.
- With the print head and ink tank left installed in the machine, press the **ON** button to turn off the power. This allows the machine to automatically cap the print head, thus preventing it from drying.
- After packing, do not tilt the box containing the machine or turn it on its side or upside down. Doing so may cause the ink to leak during transport and cause damage to the machine.
- When a shipping agent is handling transport of the machine, have its box marked "THIS SIDE UP" to keep the machine with its bottom facing down. Mark also with "FRAGILE" or "HANDLE WITH CARE".



1. Turn the machine off.
2. Confirm that the **POWER** lamp is off and [unplug the power cord](#).

▶▶▶ Important

- Do not unplug the machine while the **POWER** lamp is lit or flashing, as it may cause malfunction or damage to the machine, making the machine unable to print.

3. Remove the cassette from the machine, then shorten it until the retraction position after removing paper.

■ [Paper Source to Load Paper](#)

4. Close the paper output support, then retract the output tray extension and the paper output tray.
5. Reinsert the cassette.
6. Unplug the printer cable from the computer and from the machine, then unplug the power cord from the machine.

7. Use adhesive tape to secure all the covers on the machine to keep them from opening and to prevent the cassette from falling out during transportation. Then pack the machine in the plastic bag.
8. Attach the protective material to the machine when packing the machine in the box.

Legal Limitations on Use of Your Product and Use of Images

It may be unlawful to make copies of, scan, print, or use reproductions of the following documents.

The list provided is non-exhaustive. When in doubt, check with a legal representative in your jurisdiction.

- Paper money
- Money orders
- Certificates of deposit
- Postage stamps (canceled or uncanceled)
- Identifying badges or insignias
- Selective service or draft papers
- Checks or drafts issued by governmental agencies
- Motor vehicle licenses and certificates of title
- Traveler's checks
- Food stamps
- Passports
- Immigration papers
- Internal revenue stamps (canceled or uncanceled)
- Bonds or other certificates of indebtedness
- Stock certificates
- Copyrighted works/works of art without permission of copyright owner

Specifications

General Specifications

Printing resolution (dpi)	600 (horizontal) x 1200 (vertical)
Interface	<p>USB Port: Hi-Speed USB *1</p> <p>USB Flash Drive Port: USB flash drive</p> <p>LAN Port: Wired LAN: 100BASE-TX / 10BASE-T Wireless LAN: IEEE802.11n / IEEE802.11g / IEEE802.11b *2</p> <p>*1 A computer that complies with Hi-Speed USB standard is required. Since the Hi-Speed USB interface is fully upwardly compatible with USB 1.1, it can be used at USB 1.1.</p> <p>*2 Setup possible through Standard setup, WPS (Wi-Fi Protected Setup), WCN (Windows Connect Now) or Cableless setup.</p> <p>USB and LAN can be used at the same time.</p> <p>Wireless LAN and wired LAN cannot be used at the same time.</p>
Print width	8 inches/203.2 mm
Operating environment	<p>Temperature: 41 to 95 °F (5 to 35 °C) Humidity: 10 to 90 % RH (no condensation)</p> <p>* The performance of the printer may be reduced under certain temperature and humidity conditions.</p> <p>Recommended conditions: Temperature: 59 to 86 °F (15 to 30 °C) Humidity: 10 to 80 % RH (no condensation)</p> <p>* For the temperature and humidity conditions of papers such as photo paper, refer to the paper's packaging or the supplied instructions.</p>
Storage environment	<p>Temperature: 32 to 104 °F (0 to 40 °C) Humidity: 5 to 95 % RH (no condensation)</p>
Power supply	AC 100-240 V, 50/60 Hz
Power consumption	<p>Printing (Copy): Approx. 29 W Standby (minimum): Approx. 1.0 W *1*2 OFF: Approx. 0.3 W *1</p> <p>*1 USB connection to PC *2 The wait time for standby cannot be changed.</p>
External dimensions	<p>Approx. 18.3 (W) x 15.5 (D) x 11.5 (H) inches Approx. 463 (W) x 394 (D) x 291 (H) mm</p> <p>* With the Paper Output Tray and Cassette retracted.</p>
Weight	Approx. 25.0 lb (Approx. 11.4 kg)

	* With the Print Head and ink tanks installed.
Print Head/Ink	Total 4352 nozzles (BK 1280 nozzles, C/M/Y 512 x 6 nozzles)
ADF capacity	<p>A4 or Letter size: max. 50 sheets (20 lb/75 g /m² paper), up to 0.20 inch/5 mm in height</p> <p>Legal size: max. 10 sheets (20 lb/75 g /m² paper), up to 0.04 inch/1 mm in height</p> <p>Other sizes: 1 sheet</p>

Copy Specifications

Multiple copy	max. 99 pages
Intensity adjustment	9 positions, Auto intensity (AE copy)
Reduction / Enlargement	25 % - 400 % (1 % unit)

Scan Specifications

Scanner driver	<p>Windows: TWAIN 1.9 Specification, WIA</p> <p>Mac OS: ICA</p>
Maximum scanning size	<p>Platen Glass: A4/Letter, 8.5" x 11.7"/216 x 297 mm</p> <p>ADF: A4/Letter/Legal, 8.5" x 14.0"/216 x 356 mm</p>
Scanning resolution	<p>Optical resolution (horizontal x vertical) max: 1200 x 1200 dpi *1</p> <p>Interpolated resolution max: 19200 x 19200 dpi *2</p> <p>*1 Optical Resolution represents the maximum sampling rate based on ISO 14473.</p> <p>*2 Increasing the scanning resolution will limit the maximum possible scanning area.</p>
Gradation (Input / Output)	<p>Gray: 16 bit/8 bit</p> <p>Color: 48 bit/24 bit (RGB each 16 bit/8 bit)</p>

Fax Specifications

Applicable line	Public Switched Telephone Network (PSTN)
Communication mode	Super G3, G3
Data compressing system	<p>Black: MH, MR, MMR</p> <p>Color: JPEG</p>
Modem speed	<p>max. 33.6 kbps</p> <p>(Automatic fallback)</p>
Transmission speed	<p>Black: Approx. 3 seconds/page at 33.6 kbps</p> <p>(Based on ITU-T No.1 chart for US specifications and Canon FAX Standard chart No.1 for others, both in standard mode.)</p> <p>Color: Approx. 1 minute/page at 33.6 kbps</p>

	(Based on Canon COLOR FAX TEST SHEET.)
Gradation	Black: 256 levels Color: 24 bit Full Color (RGB each 8 bit)
Density adjustment	3 levels
Memory	Transmission/reception: approx. 250 pages (Based on ITU-T No.1 chart for US specifications and Canon FAX Standard chart No.1 for others, both in standard mode.)
Fax resolution	Black Standard: 203 pels/inch x 98 lines/inch (8 pels/mm x 3.85 lines/mm) Black Fine, Photo: 203 pels/inch x 196 lines/inch (8 pels/mm x 7.70 lines/mm) Black Extra fine: 300 x 300 dpi Color: 200 x 200 dpi
Dialing	Automatic dialing - Recipient (max. 100 destinations) - Group dial (max. 99 destinations) Regular dialing Automatic redialing Manual redialing (max. 10 destinations)
Others	Activity report (after every 20 transactions) Sequential broadcasting (max. 101 destinations) Rejected numbers (max. 10 destinations)

Network Specifications

Communication protocol	TCP/IP
Wired LAN	Supported Standards: IEEE802.3u (10BASE-TX) / IEEE802.3 (10BASE-T) Transfer speed: 10 M/100 Mbps (auto switching)
Wireless LAN	Supported Standards: IEEE802.11n / IEEE802.11g / IEEE802.11b Frequency bandwidth: 2.4 GHz Channel: 1-11 or 1-13 * Frequency bandwidth and available channels differ depending on country or region. Communication distance: Indoors 164 feet/50 m * Effective range varies depending on the installation environment and location. Security: WEP (64/128 bits) WPA-PSK (TKIP/AES) WPA2-PSK (TKIP/AES) Setup: Standard setup WPS (Push button configuration/PIN code method)

	WCN (WCN-NET) Cableless setup Other Features: Administration password
--	--

Minimum System Requirements

Conform to the operating system's requirements when higher than those given here.

Windows

Operating System	Windows 8, Windows 8.1 Windows 7, Windows 7 SP1 Windows Vista SP1, Windows Vista SP2 Windows XP SP3 32-bit only For the printer driver and fax driver: Windows Server 2003*, Windows Server 2003 R2*, Windows Server 2008, Windows Server 2008 R2, Windows Server 2012, and Windows Server 2012 R2 * XPS driver is not supported.
Browser	Internet Explorer 8 or later
Hard Disk Space	2.5 GB Note: For bundled software installation. The necessary amount of hard disk space may be changed without notice.
Display	XGA 1024 x 768

Mac OS

Operating System	Mac OS X v10.6.8 or later
Browser	Safari 5 or later
Hard Disk Space	0.5 GB Note: For bundled software installation. The necessary amount of hard disk space may be changed without notice.
Display	XGA 1024 x 768

Other Supported OS

Some functions may not be available with each OS. Refer to the manual or the Canon web site for details on operation with iOS, Android, and Windows RT.

Mobile Printing Capability

Apple AirPrint
Google Cloud Print

Print from E-mail
MAXIFY Cloud Link

- An internet connection is required to view the *Online Manual*.
- Windows: Operation can only be guaranteed on a computer with Windows 8.1, Windows 8, Windows 7, Windows Vista or Windows XP pre-installed.
- Windows: A CD-ROM Drive or internet connection is required during software installation.
- Windows: Internet Explorer 8, 9, 10 or 11 is required to install Easy-WebPrint EX.
- Windows: Some functions may not be available with Windows Media Center.
- Windows: .NET Framework 4 or 4.5 must be installed to use the Windows software.
- Windows: XPS Essentials Pack is required to print on Windows XP.
- Windows: The TWAIN driver (ScanGear) is based on the TWAIN 1.9 Specification and requires the Data Source Manager bundled with the operating system.
- Mac OS: Hard Disk must be formatted as Mac OS Extended (Journaled) or Mac OS Extended.
- Mac OS: For Mac OS, an internet connection is required during software installation.
- In an in-house network environment, the 5222 port must be open. Contact the network administrator for details.

Information in this guide is subject to change without notice.

Administrator Settings

- **About the Machine Administration**
- **Setting the Administrator Password**
- **Restricting the Operation**

About the Machine Administration

Specifying the administrator password or restricting some operations allows you to manage the use of the machine.

When you use the machine after specifying the administrator password or restricting some operations, it is recommended to assign an administrator.

▶▶▶ Important

- When the administrator password is specified or some operations are restricted, the screens below are displayed.

Ex: When the screen to enter the administrator password is displayed:



Ex: When all the copying operations are restricted:

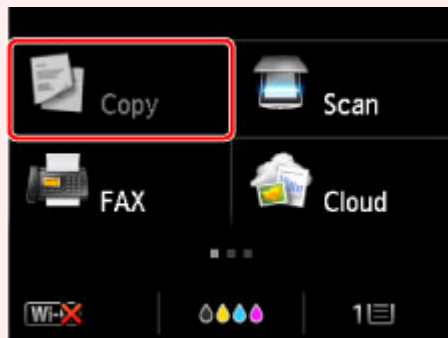

Ex: When the message about operation restriction is displayed:

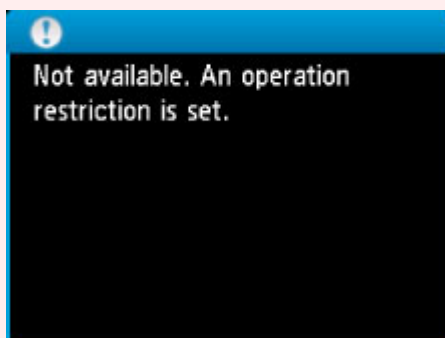

- An administrator password is already specified for the machine at the time of purchase.

For details:

■ ■ [About the Administrator Password](#)

■ ■ [Setting the Administrator Password](#)

■ ■ [Restricting the Operation](#)

Setting the Administrator Password

You can specify or disable the administrator password.

Specifying the administrator password requires you to enter the password to change the machine settings or connection settings.

Entering the administrator password is required to change the setting items in the following menus.

- **ECO settings**
- **Quiet setting**
- **Web service setup**
- **FAX settings**
- **LAN settings**
- **Device user settings**
- **Language selection**
- **Firmware update**
- **Administrator password setting**
- **Operation restrictions**
- **Reset setting**

Follow the procedure below to specify the administrator password.

1. [Make sure that the machine is turned on.](#)

2. Flick the HOME screen, then tap  **Setup**.

■ [Using the Operation Panel](#)

3. Tap  **Device settings**.

4. Tap **Administrator password setting**.

5. When the confirmation screen to specify the administrator password is displayed, tap **Yes**.

6. Check the message, then tap **OK**.

7. Tap the range where the administrator password is valid.

Remote UI/Network Tool

Entering the administrator password is required to change the setting items using the Remote UI or IJ Network Tool.

LCD/Remote UI/Network Tool

Entering the administrator password is required to change the setting items using the operation panel of the machine, the Remote UI, or IJ Network Tool.

8. Enter the administrator password.

Tap the area to enter a password, then enter the password (0 to 32 alphanumeric characters).

Tap **OK** when you finished entering the administrator password.

9. Tap **Apply**.

10. Enter the administrator password you specified again.

Tap the area to enter a password, then enter the password you specified.

Tap **OK** when you finished entering the administrator password.

11. Tap **Apply**.

The administrator password is enabled.

When You Want to Change or Disable the Administrator Password:

When the administrator password is enabled, tapping **Setup**, **Device settings**, and **Administrator password setting** in this order and entering the administrator password displays **Change administrator password** and **Remove administrator password** on the touch screen. Select either item, then follow the on-screen instructions to perform settings.

Restricting the Operation

You can restrict printing, copying, or faxing operations or to use a USB flash drive or a shared folder on the computer.

1. [Make sure that the machine is turned on.](#)

2. Flick the HOME screen, then tap  **Setup**.

■ [Using the Operation Panel](#)

3. Tap  **Device settings**.

4. Tap **Operation restrictions**.

5. When the confirmation screen of operation restriction is displayed, tap **Yes**.

If you have already performed operation restriction setting, the menu items are displayed. Tap **Change operation restrictions**.

6. Tap an operation you want to restrict, then tap a function you want to restrict.

Copy

Restricts copying operations. If you select **Restrict all copying**, you can restrict all copying operations. If you select **Restrict color copying**, you can restrict color copying operations only.

Print from storage medium

Restricts to print from a USB flash drive.

Scan to USB flash drive

Restricts to save the scanned data on a USB flash drive.

Scan to destination folder

Restricts to forward the scanned data to a shared folder on the computer.

FAX transmission

Restricts to send a fax.

FAX reception

Restricts to receive a fax.

▶▶ Important

- If the machine receives a fax while **Restrict** is selected, **Not available. An operation restriction is set.** is displayed on the touch screen and the fax standby screen is displayed. In this case, you cannot receive the faxes. Ask the administrator of the machine you are using to change the setting, then have the sender resend the faxes.

Directory

Restricts operations related to the machine's directory.

7. Tap **Exit**.

The operation restrictions you selected are enabled.

»» Note

- If you disable all restrictions, tap **Cancel operation restrictions** in step 5. When the confirmation screen is displayed, tap **Yes**.

To disable each operation restriction, tap the item in step 6, then tap **Do not restrict**.

About the Administrator Password

An administrator password "canon" is already specified for the printer at the time of purchase.

▶▶ Important

- For security reasons, it is recommended to change the password before you use the printer.
- You can change the password using one of the tools below. (Some tools may not be available depending on the printer you are using.)
 - operation panel of the printer
 - IJ Network Tool
 - printer information screen displayed on some Canon application software
- When you change the password, use 0 to 32 alphanumeric characters.
- If the password has been changed while you are sharing the printer and you do not know the password, ask the administrator of the printer you are using.
- The password reverts to the default setting by initializing the printer settings.

Printing

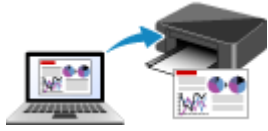

Printing from a Computer



Printing Using the Operation Panel of the Machine



Paper setting for Printing

Printing from a Computer

- ▶ **Printing with Application Software that You are Using (Printer Driver)**

Printing with Application Software that You are Using (Printer Driver)

- ▶ **Printing with Easy Setup**  **Basic**
- ▶ **Various Printing Methods**
- ▶ **Changing the Print Quality and Correcting Image Data**
- ▶ **Overview of the Printer Driver**
- ▶ **Updating the Printer Driver**

Printing with Easy Setup

The simple setup procedure for carrying out appropriate printing on this printer is as follows:

1. [Check that the printer is turned on](#)
2. [Load paper](#) on the printer
3. Select the printer

Select your model from the **Printer** list in the [Print Dialog](#).

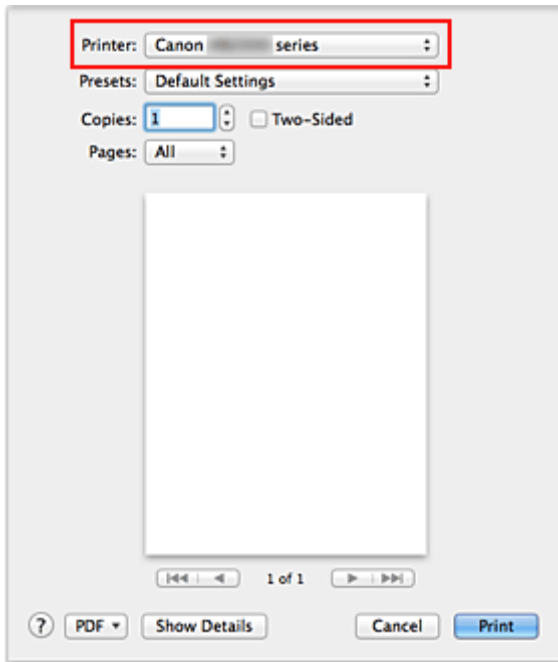

►►► Note

- Click **Show Details** (▾) (the disclosure triangle) to switch the Setup window to the detailed display.

4. Select the paper size

For **Paper Size**, select the paper size to be used.

If necessary, set the number of copies, the pages to be printed, and the orientation.

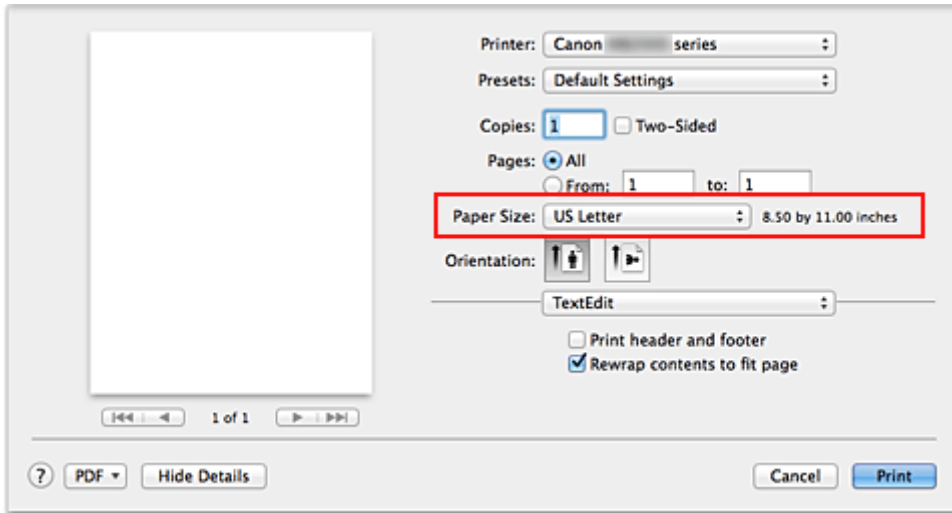

5. Select **Quality & Media** from the pop-up menu

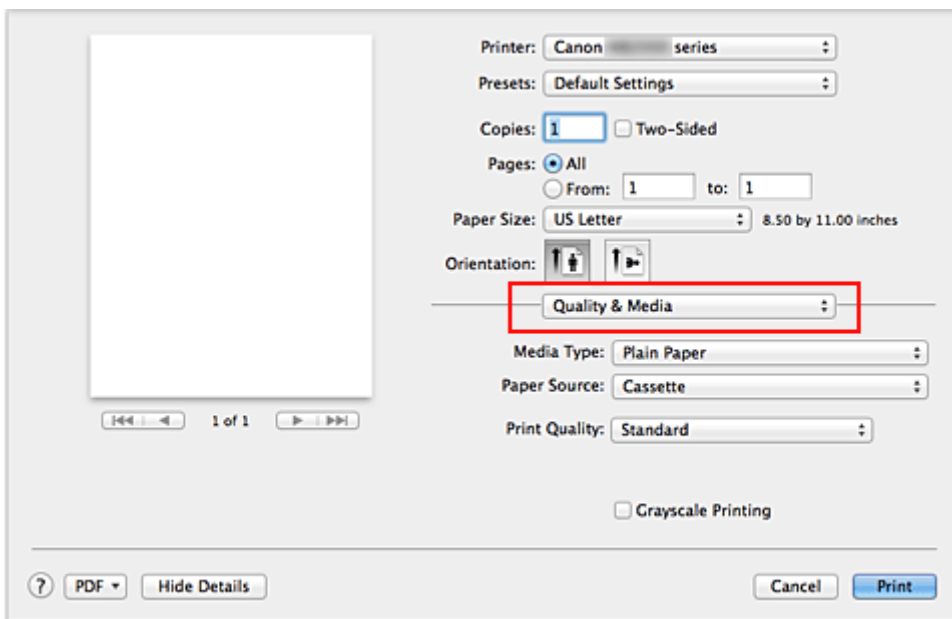

6. Select the media type

For **Media Type**, select the same paper type loaded in the printer.

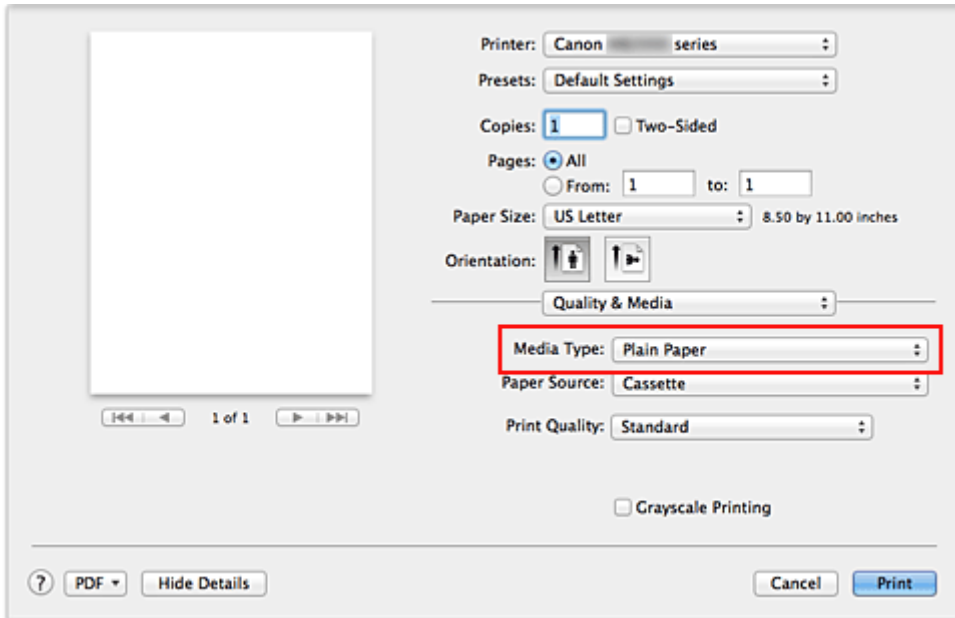

7. Select the print quality

For **Print Quality**, select **High** or **Standard** according to your purpose.

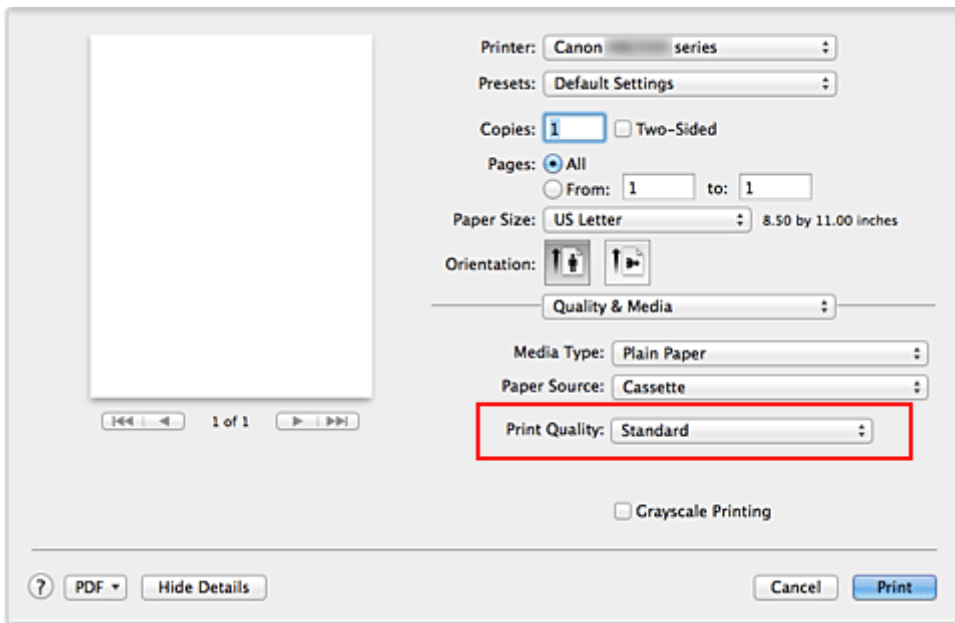

»»» **Important**

- The print quality settings that can be selected may differ depending on a printing profile.

8. Complete the setup

Click **Print**.

When you execute print, the document will be printed in accordance with the type and size of the media.

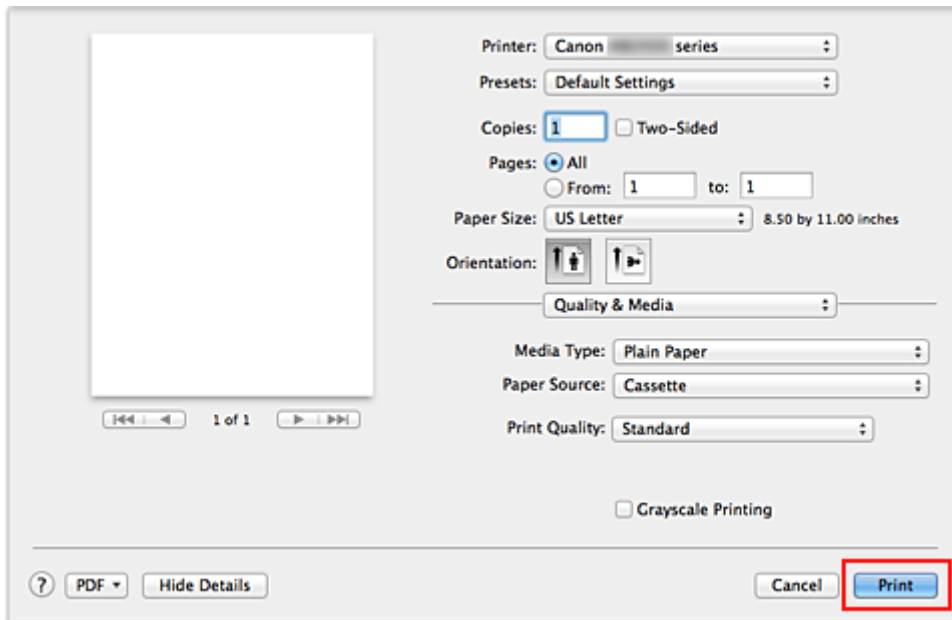

►►► Important

- In the **Presets** section, click **Save Current Settings as Preset... (Save As...)** to [register the specified settings](#).

►►► Note

- If the paper settings on the print dialog differ from the cassette paper information registered on the printer, an error may occur. For instructions on what to do if an error occurs, see "[Paper setting for Printing](#)."
For details about the cassette paper information to be registered on the printer, see the following:
 - [Paper Settings on the Printer Driver and the Printer \(Media Type\)](#)
 - [Paper Settings on the Printer Driver and the Printer \(Paper Size\)](#)

Paper Settings on the Printer Driver and the Printer (Media Type)

When you use this printer, selecting a media type and [paper size](#) that matches the print purpose will help you achieve the best print results.

You can use the following media types on this printer.

Commercially available papers

Media name	Media Type in the printer driver	Cassette paper information registered on the printer
Plain Paper (including recycled paper)	Plain Paper	Plain paper
Envelopes	Envelope	Envelope

Canon genuine papers (Photo Printing)

Media name <Model No.>	Media Type in the printer driver	Cassette paper information registered on the printer
Photo Paper Plus Glossy II <PP-201>	Photo Paper Plus Glossy II	Plus Glossy II
Photo Paper Pro Luster <LU-101>	Photo Paper Pro Luster	Pro Luster
Photo Paper Plus Semi-gloss <SG-201>	Photo Paper Plus Semi-gloss	Plus Semi-gloss
Photo Paper Glossy <GP-501/GP-601>	Glossy Photo Paper	Glossy
Matte Photo Paper <MP-101>	Matte Photo Paper	Matte

Canon genuine papers (Business Letter Printing)

Media name <Model No.>	Media Type in the printer driver	Cassette paper information registered on the printer
High Resolution Paper <HR-101N>	High Resolution Paper	High-Res Paper

Paper Settings on the Printer Driver and the Printer (Paper Size)

When you use this printer, selecting a paper size that matches the print purpose will help you achieve the best print results.

You can use the following paper sizes on this printer.

Paper Size in the printer driver	Cassette paper information registered on the printer
US Letter	Letter
US Legal	Legal
A5	A5
A4	A4
JIS B5 (B5 JIS)	B5
4 x 6	KG/4"x6"(10x15)
5 x 7	2L/5"x7"(13x18)
8 x 10	8"x10"(20x25cm)
L	L(89x127mm)
Envelope #10	Envelope Com 10
Envelope DL	Envelope DL
Envelope You4	Others
Yougata 6	Others
Custom Size	Others

Various Printing Methods

- **Setting the Number of Copies and Printing Order**
- **Setting the Stapling Margin**
- **Scaling the Printing to Fit the Paper Size**
- **Scaled Printing**
- **Page Layout Printing**
- **Duplex Printing**
- **Printing on Postcards**
- **Displaying the Print Results before Printing**
- **Setting Paper Dimensions (Custom Size)**

Setting the Number of Copies and Printing Order

Collate pages + Reverse Collate pages + Normal Reverse

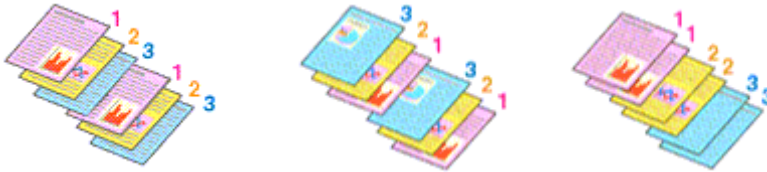

The procedure for specifying the number of copies and printing order is as follows:

1. Specify the number of copies to be printed

Specify the number of copies to print from the **Copies** in the [Print Dialog](#).

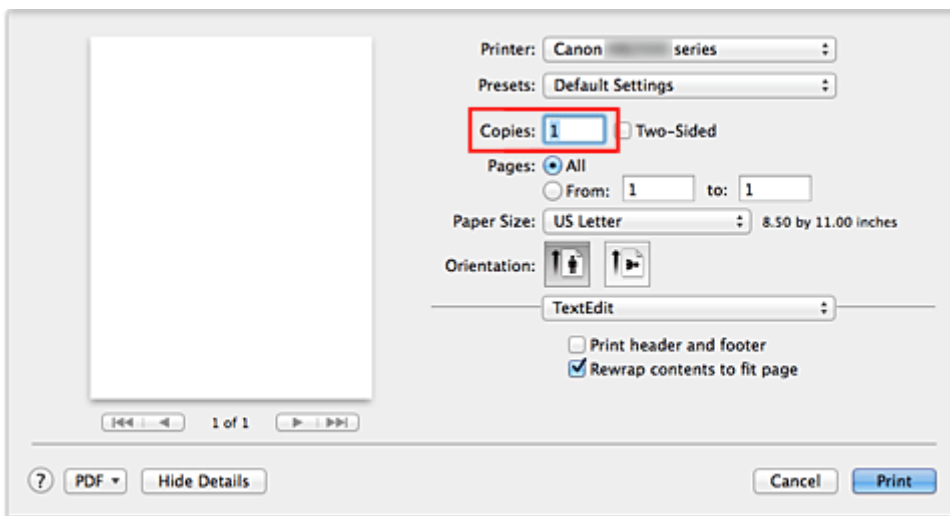

2. Select **Paper Handling** from the pop-up menu

3. Check the **Collate pages** check box when you are specifying multiple copies in the **Copies** box

Check the **Collate pages** check box to print all the pages of a single copy together.
Uncheck this check box to print all pages with the same page number together.

4. Specify the print order

Check **Page Order**.

When you select **Automatic** or **Reverse**, printing starts from the last page.

When you select **Normal**, printing starts from the first page.

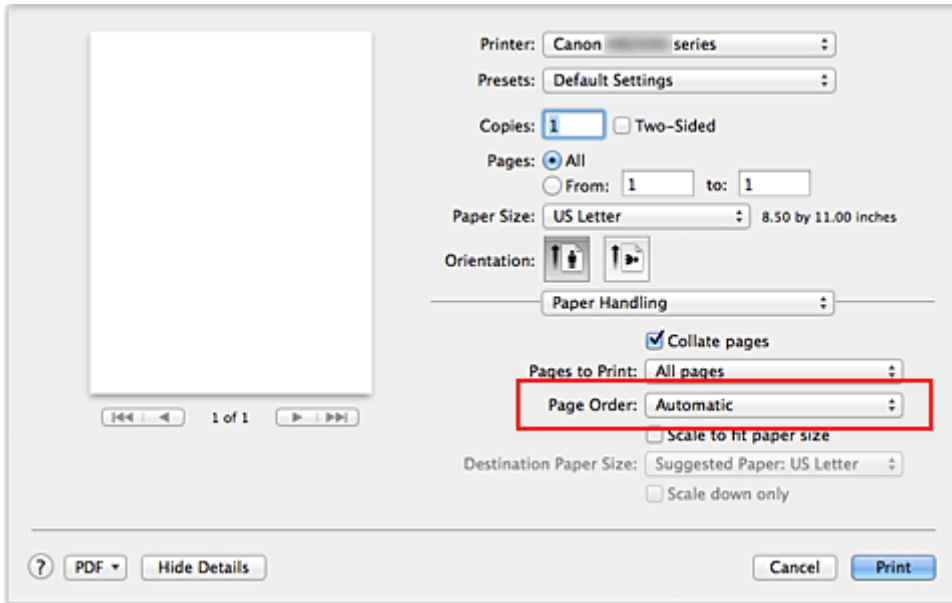

5. Complete the setup

Click **Print**.

When you execute print, the specified number of copies will be printed with the specified printing order.

»»» Important

- When the application software that you used to create the document has the same function, specify the settings on the printer driver. However, if the print results are not acceptable, specify the function settings on the application software. When you specify the number of copies and the printing order with both the application software and this printer driver, the number of copies may be multiplied numbers of the two settings or the specified printing order may not be enabled.

Setting the Stapling Margin



The procedure for setting the margin width and the staple side is as follows:

1. Select **Margin** from the pop-up menu on the [Print Dialog](#)

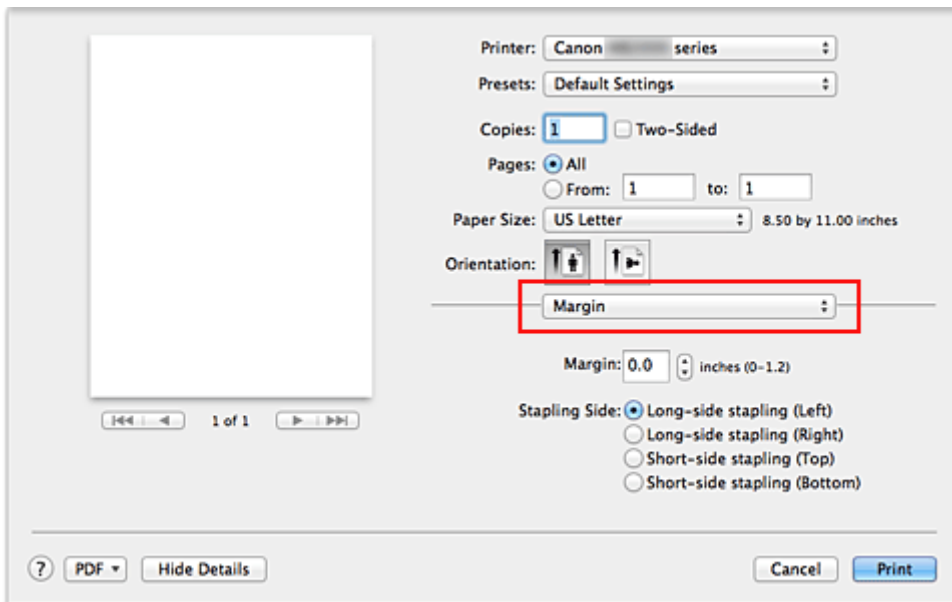

2. Set the margin width and the staple side

If necessary, set the **Margin** width, and select a stapling position from the **Stapling Side** list.

▶▶▶ Note

- The printer automatically reduces the print area depending on the staple position margin.
- Depending on the **Two-Sided** setting in the **Layout** pop-up menu, the **Stapling Side** that can be selected differs.

3. Complete the setup

Click **Print**.

When you execute print, the data is printed with the specified margin width and staple side.

Scaling the Printing to Fit the Paper Size



The procedure for printing a document that is automatically enlarged or reduced to fit the page size to be used is as follows:

1. Check the paper size

Check that the **Paper Size** in the [Print Dialog](#) is the same as the paper size that you set in the application software.

2. Select **Paper Handling** from the pop-up menu

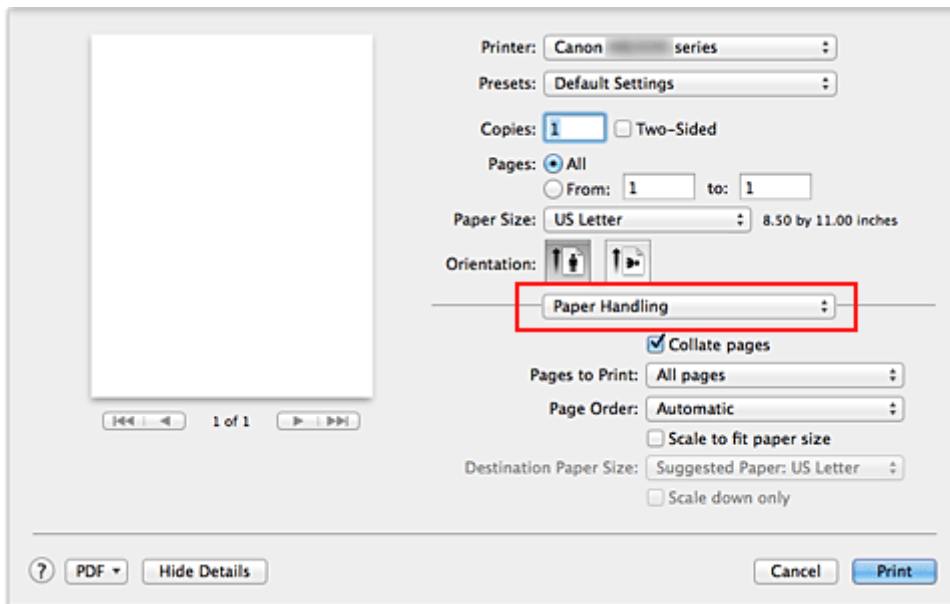

3. Set the print paper size

Check the **Scale to fit paper size** check box. Then from the **Destination Paper Size** pop-up menu, select the paper size that is actually loaded in the printer.

4. If necessary, check the **Scale down only** check box

When you check this check box, the document will be reduced to fit to the paper size when the document size is larger than the page size. The document will be printed in the original size when the document size is smaller than the page size.

5. Complete the setup

Click **Print**.

When you execute print, the document will be enlarged or reduced to fit to the page size.

Scaled Printing



The procedure for printing a document with pages enlarged or reduced is as follows:

1. Select the printer

In the [Page Setup Dialog](#), select your model name from the **Format For** list.

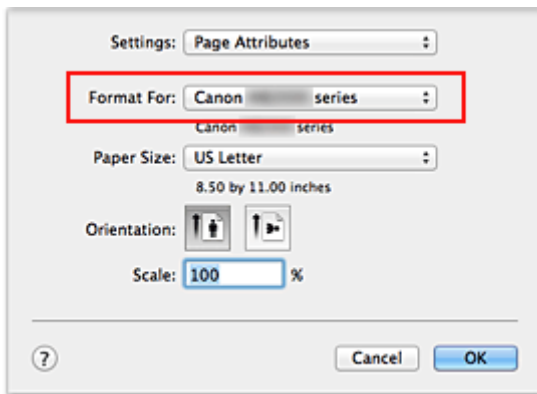

2. Set scaled printing

Specify the scaling factor in the **Scale** box, and click **OK**.

▶▶▶ Note

- Depending on the **Scale** value that you set, an error message may be displayed.

3. Complete the setup

On the [Print Dialog](#), click **Print**.

When you execute print, the document will be printed with the specified scale.

▶▶▶ Important

- When the application software which you used to create the original has the scaled printing function, configure the settings on your application software. You do not need to configure the same setting in the Page Setup dialog.

Page Layout Printing

The page layout printing function allows you to print more than one page image on a single sheet of paper.

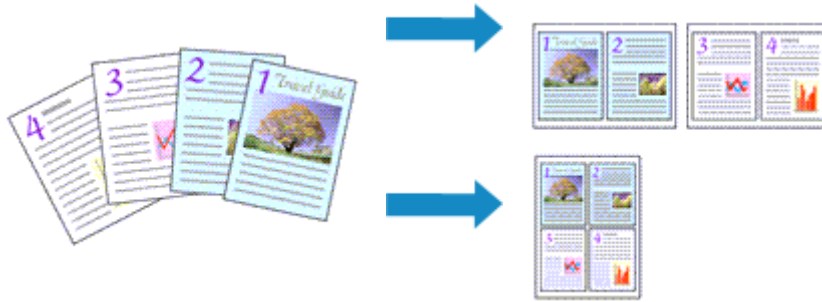

The procedure for performing page layout printing is as follows:

1. Select **Layout** from the pop-up menu in the [Print Dialog](#)

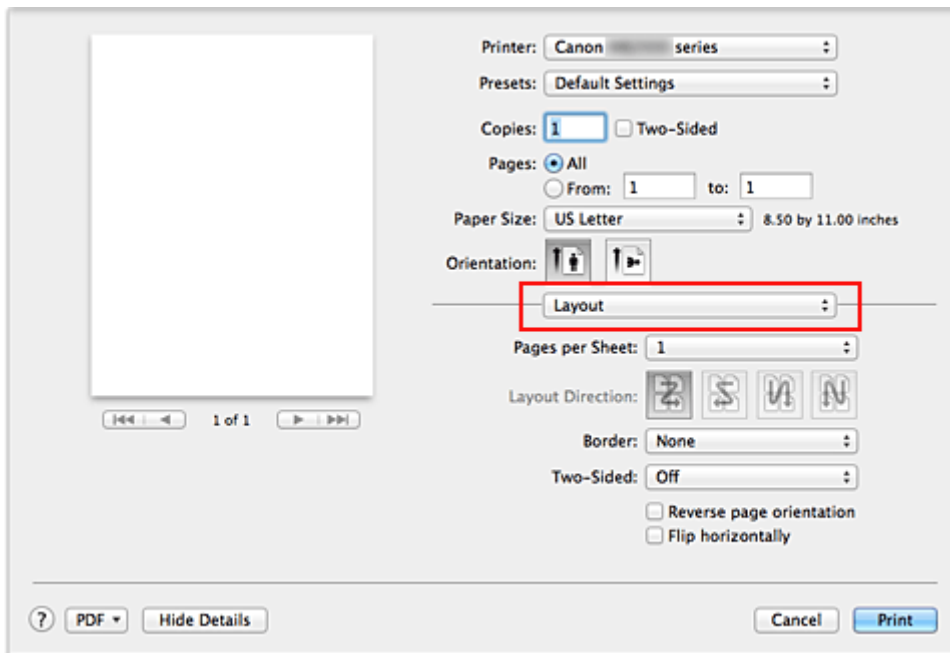

2. Set the number of original you print on one page

In **Pages per Sheet**, specify the number of page you print on one page.

3. If necessary, set the following items

Layout Direction

To change the page placement order, select an icon from the list.

Border

To print a page border around each document page, select a type of page border.

Reverse page orientation

Select this check box to change the paper orientation.

Flip horizontally

Select this check box to reverse left and right of the document.

4. Complete the setup

Click **Print**.

When you execute print, the specified number of pages will be arranged on each sheet of paper in the specified order.

Duplex Printing

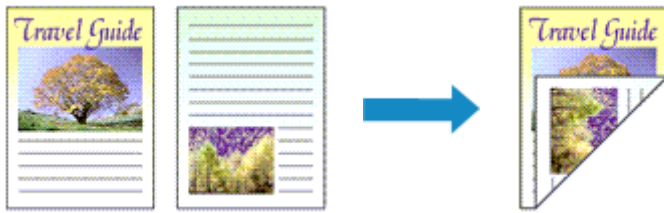

The procedure for printing data on both sides of one sheet of paper is as follows:

1. Set duplex printing

Check the **Two-Sided** check box in the [Print Dialog](#).

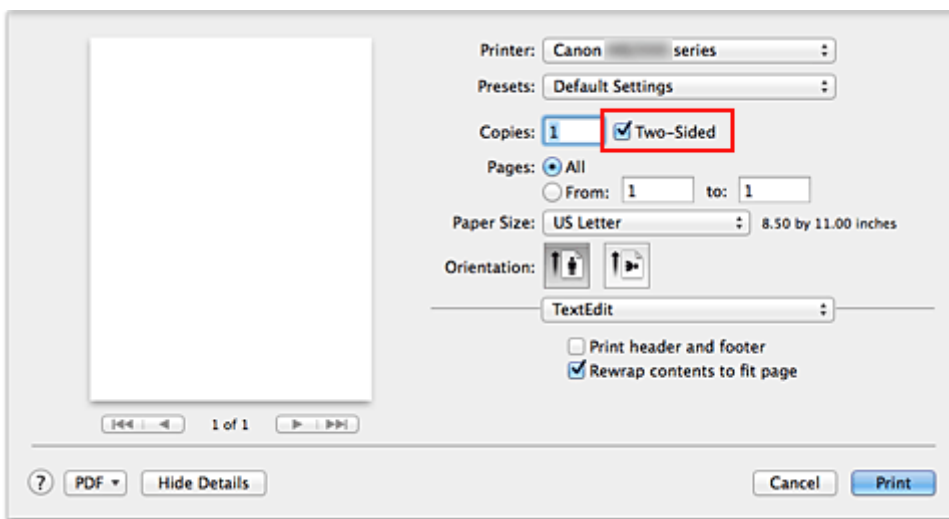

2. Select **Layout** from the pop-up menu on the Print Dialog

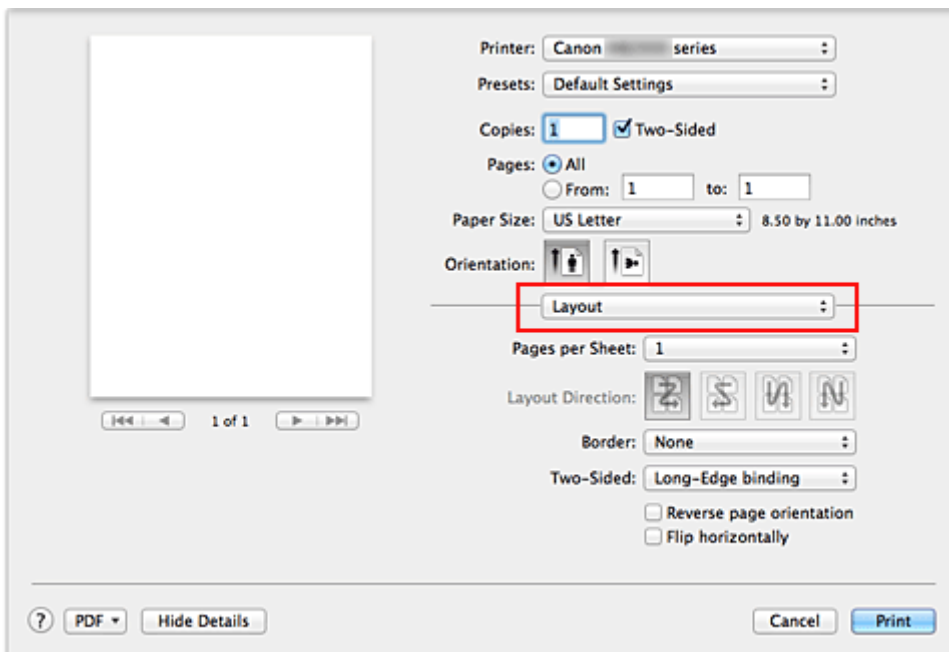

3. Set the stapling side

For **Two-Sided**, select either **Long-Edge binding** or **Short-Edge binding**.

4. Select **Margin** from the pop-up menu on the Print Dialog

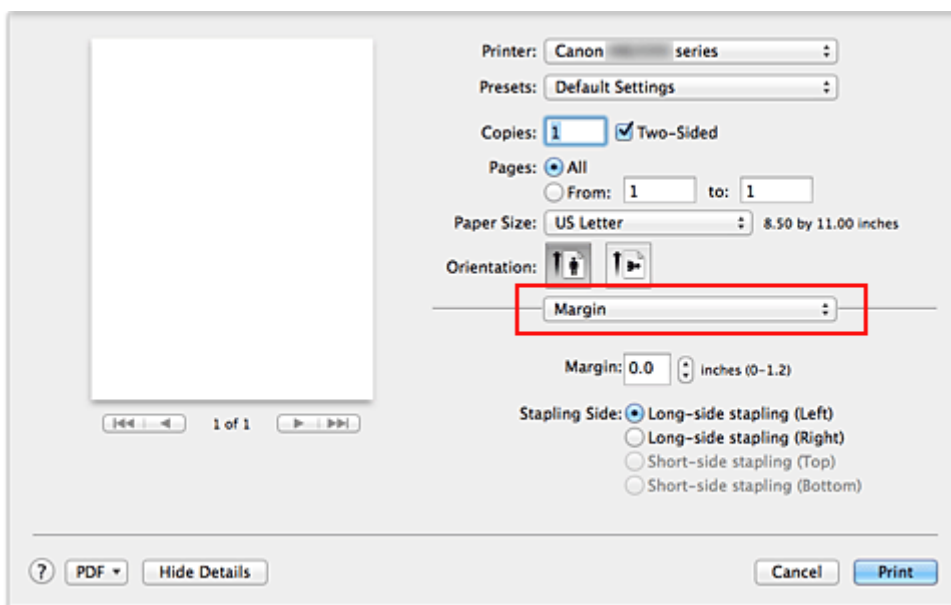

5. Set the stapling margin

If necessary, set the **Margin** width, and to change the **Stapling Side**, select a setting from the list.

▶▶▶ **Note**

- Depending on the **Two-Sided** setting in the **Layout** pop-up menu, the **Stapling Side** that can be selected differs.

6. Complete the setup

Click **Print**.

When you execute print, duplex printing will be started.

▶▶▶ **Important**

- When a media type other than **Plain Paper** is selected from **Media Type** menu of **Quality & Media**, duplex printing cannot be executed.
- Duplex printing can be performed only when one of the following paper sizes is selected from **Paper Size**.
 - **US Letter, A4**
- After printing the front page, there is an ink drying wait time before starting to print the back page (Operation stops temporarily). Do not touch the paper during this time. You can change the ink drying wait time from **Custom Settings** in the Canon IJ Printer Utility.

▶▶▶ **Note**

- When you use duplex printing, the print area becomes slightly smaller than the normal print area.

Related Topic

- [Changing the Printer Operation Mode](#)

Printing on Postcards

This section describes the procedure for postcard printing.

1. [Load postcard](#) on the printer
2. Select paper size in the [Print Dialog](#)

Select **Postcard** or **Postcard Double** from the **Paper Size** menu.

▶▶▶ Important

- Return postcards can be used only when you print them from the computer.
- When printing a return postcard, always set the paper size to **Postcard Double** from your application software or the printer driver.
- Do not fold the return postcard. If a crease is formed, the printer will not be able to feed the postcard properly, and this condition will cause line shifts or a paper jam.

3. Select **Quality & Media** from the pop-up menu
4. Select the media type

For **Media Type**, select the same paper type loaded in the printer.

▶▶▶ Important

- This printer cannot print on postcards that have photos or stickers attached.
- When printing on each side of a postcard separately, you will get cleaner printing if you print the message side first and then print the address side.
- The paper settings on the printer driver and the cassette paper information to register on the printer are different, depending on whether you are printing on the address side or the message side. For details about the cassette paper information to be registered on the printer, see the following:
 - [Paper Settings on the Printer Driver and the Printer \(Media Type\)](#)
 - [Paper Settings on the Printer Driver and the Printer \(Paper Size\)](#)

5. Complete the setup

Click **Print**.

When you execute printing, the data will be printed onto the postcard.

Displaying the Print Results before Printing

If you are using Mac OS X v10.6.8, you can display and check the print result before printing.

To display the print result before printing, click **Preview** on the [Print Dialog](#).

»» Note

- When you click  (the disclosure triangle) in the Print dialog and switch to the detailed display, **Preview** is not displayed.
For detailed display, a preview is displayed on the left side of the Print dialog.

Setting Paper Dimensions (Custom Size)

You can specify the height and width of paper when its size cannot be selected from the **Paper Size** menu. Such a paper size is called "custom size."

The procedure for specifying a custom size is as follows:

1. Creating a new custom paper size

In the [Print Dialog](#), select **Manage Custom Sizes...** from **Paper Size**.

In the **Custom Paper Sizes** dialog, click +.

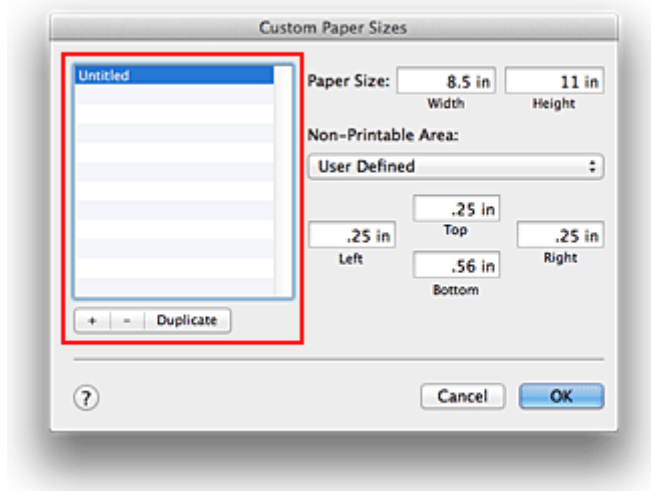

Untitled will be added to the list.

2. Setting details about the custom paper size

Double-click **Untitled**, enter the name of the paper size you want to register, and specify the **Width** and **Height** of the paper for **Paper Size**.

Select **User Defined** or your model for **Non-Printable Area**, and enter the margins.

3. Registering the custom paper size

Click **OK**.

The custom size is registered.

►► Important

- If the application software that created the document has a function for specifying height and width values, use the application software to set the values. If the application software does not have such a function or if the document does not print correctly, perform the above procedure from the printer driver to set the values.

►► Note

- To duplicate the registered paper size, select the paper size that you want to duplicate from the **Custom Paper Sizes** list, and click **Duplicate**.
- To delete a registered paper size, select the paper size that you want to delete from the **Custom Paper Sizes** list, and click -.
- If the paper settings on the print dialog differ from the cassette paper information registered on the printer, an error may occur. For instructions on what to do if an error occurs, see "[Paper setting for](#)"

[Printing.](#)"

For details about the cassette paper information to be registered on the printer, see the following:

- [Paper Settings on the Printer Driver and the Printer \(Media Type\)](#)
- [Paper Settings on the Printer Driver and the Printer \(Paper Size\)](#)

Changing the Print Quality and Correcting Image Data

- ▶ **Printing a Color Document in Monochrome**
- ▶ **Specifying Color Correction**
- ▶ **Optimal Photo Printing of Image Data**
- ▶ **Adjusting Colors with the Printer Driver**
- ▶ **Printing with ICC Profiles (Specifying an ICC Profile from the Application Software)**
- ▶ **Printing with ICC Profiles (Specifying an ICC Profile from the Printer Driver)**
- ▶ **Adjusting Color Balance**
- ▶ **Adjusting Brightness**
- ▶ **Adjusting Intensity**
- ▶ **Adjusting Contrast**

Printing a Color Document in Monochrome

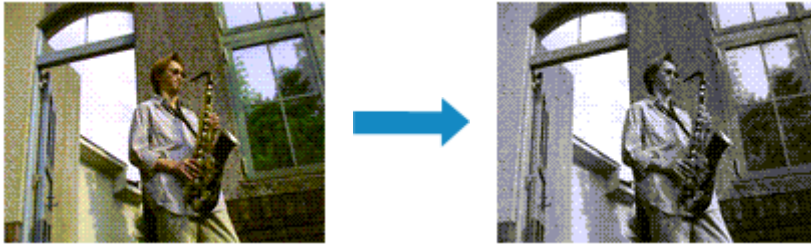

The procedure for printing a color document in monochrome is as follows:

1. Select **Quality & Media** from the pop-up menu on the [Print Dialog](#)
2. Set grayscale printing

Check the **Grayscale Printing** check box.

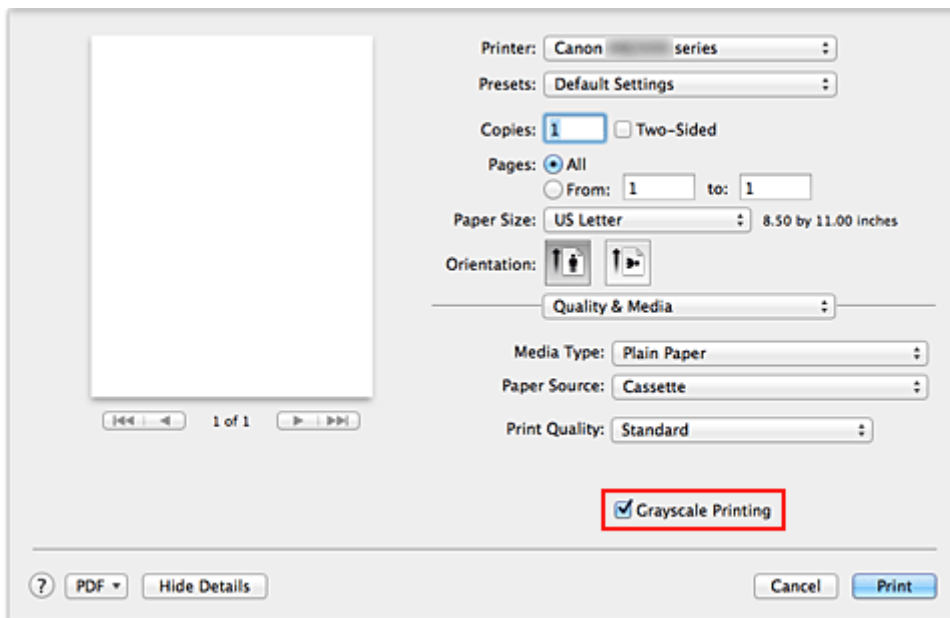

3. Complete the setup

Click **Print**.

When you execute print, the document is converted to grayscale data. It allows you to print the color document in monochrome.

►► Note

- During **Grayscale Printing**, inks other than black ink may be used as well.

Specifying Color Correction

You can specify the color correction method suited to the type of document to be printed.

Normally, the printer driver adjusts the colors by using Canon Digital Photo Color so that data is printed with color tints that most people prefer.

When you want to print by using the color space (Adobe RGB or sRGB) of the image data effectively or by specifying a printing ICC profile from your application software, select **ColorSync**. When you want to print by having the printer driver correct the colors, select **Canon Color Matching**.

The procedure for specifying color correction is as follows:

1. Select **Color Matching** from the pop-up menu of the [Print Dialog](#)

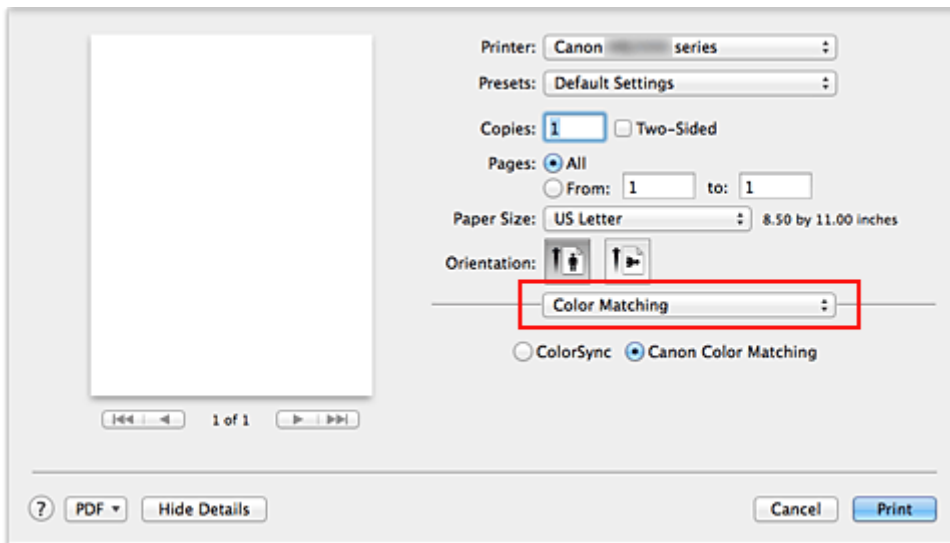

2. Select color correction

Select the item below that matches your purpose.

ColorSync

Perform color correction using ColorSync.

Canon Color Matching

With Canon Digital Photo Color, you can print with color tints that most people prefer.

3. Complete the setup

Click **Print**.

When you execute print, the document data is printed with the specified color correction.

»» Important

- Depending on the application software, when a printing ICC profile is specified from that application software, **Canon Color Matching** cannot be selected because **ColorSync** is selected automatically.
- The **Quality & Media** setting is necessary even when **ColorSync** or **Canon Color Matching** is selected.

Related Topics

- [Optimal Photo Printing of Image Data](#)
- [Adjusting Colors with the Printer Driver](#)

- [Printing with ICC Profiles \(Specifying an ICC Profile from the Application Software\)](#)
- [Printing with ICC Profiles \(Specifying an ICC Profile from the Printer Driver\)](#)

Optimal Photo Printing of Image Data

When people print images taken with digital cameras, they sometimes feel that the printed color tones differ from those of actual image or those displayed on the monitor.

To get the print results as close as possible to the desired color tones, you must select a printing method that is best suited to the application software used or to your purpose.

Color Management

Devices such as digital cameras, scanners, monitors, and printers handle color differently. Color management (color matching) is a method that manages device-dependent "colors" as a common color space.

For Mac OS, a color management system called "ColorSync" is built into the operating system. Adobe RGB and sRGB are popularly used as common color spaces. Adobe RGB has a wider color space than sRGB.

ICC profiles convert device-dependent "colors" into a common color space. By using an ICC profile and carrying out color management, you can draw out the color space of the image data within the color reproduction area that the printer can express.

Selecting a Printing Method Suited to the Image Data

The recommended printing method depends on the color space (Adobe RGB or sRGB) of the image data or the application software to be used.

There are two typical printing methods.

Check the color space (Adobe RGB or sRGB) of the image data and the application software to be used, and then select the printing method suited to your purpose.

Adjusting Colors with the Printer Driver

Describes the procedure for printing by using the color correction function of the printer driver.

- To print using Canon Digital Photo Color

The printer prints data with color tints that most people prefer, reproducing colors of the original image data and producing three-dimensional effects and high, sharp contrasts.

- To print by directly applying editing and touch-up results of an application software

When printing the data, the printer brings out subtle color difference between dark and light areas, while leaving the darkest and lightest areas intact.

When printing the data, the printer applies fine adjustment results, such as brightness adjustments made with an application software.

Printing with ICC Profiles (Specifying an ICC Profile from the Application Software)

Describes the procedure for printing by using the color space of Adobe RGB or sRGB effectively.

You can print with a common color space by setting up the application software and the printer driver so that the color management matches the input ICC profile of the image data.

The method for setting up the printer driver differs depending on the application software to be used.

Adjusting Colors with the Printer Driver

You can specify the color correction function of the printer driver to print with color tints that most people prefer through the use of Canon Digital Photo Color.

When printing from an application software that can identify ICC profiles and allows you to specify them, use a printing ICC profile in the application software, and select settings for color management.

The procedure for adjusting colors with the printer driver is as follows:

1. Select **Color Matching** from the pop-up menu of the [Print Dialog](#)

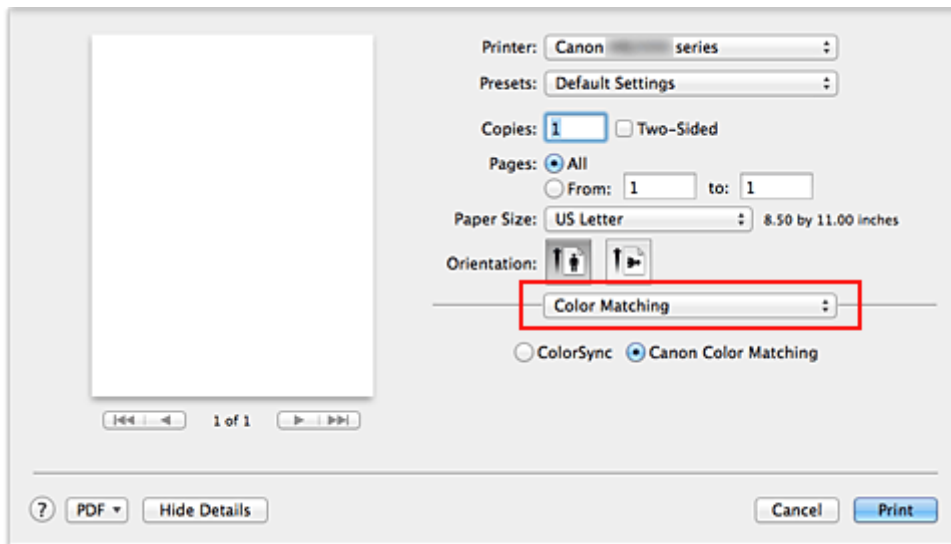

2. Select color correction

Select **Canon Color Matching**.

3. Set the other items

From the pop-up menu, select **Color Options**. If necessary, adjust the color balance (**Cyan, Magenta, Yellow**) and adjust **Brightness, Intensity, and Contrast** settings.

4. Complete the setup

Click **Print**.

When you execute print, the printer driver adjusts the colors when printing the data.

Related Topics

- [Specifying Color Correction](#)
- [Adjusting Color Balance](#)
- [Adjusting Brightness](#)
- [Adjusting Intensity](#)
- [Adjusting Contrast](#)

Printing with ICC Profiles (Specifying an ICC Profile from the Application Software)

When you print from Adobe Photoshop, Canon Digital Photo Professional, or any application software that can identify input ICC profiles and allows you to specify such profiles, printer uses the color management system (ColorSync) built-into Mac OS when printing. The printer prints the editing and touch-up results of the application software and effectively uses the color space of the input ICC profile specified in the image data.

To use this printing method, use your application software to select color management items and specify an input ICC profile and a printing ICC profile in the image data.

Even if you print using a printing ICC profile that you created yourself from your application software, be sure to select color management items from your application software.

For instructions, refer to the manual of the application software you are using.

1. Select **Color Matching** from the pop-up menu of the [Print Dialog](#)

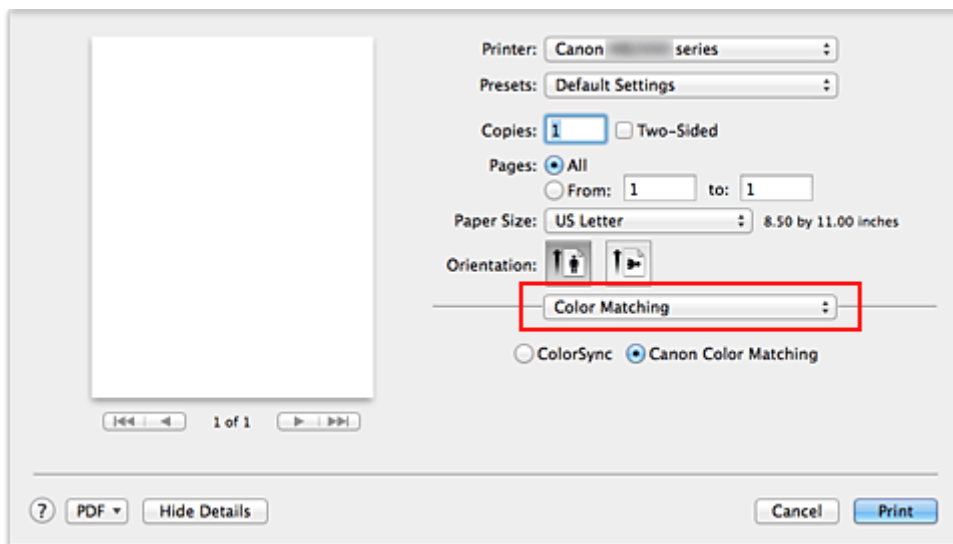

2. Select color correction

Select **ColorSync**.

You can leave **Profile** set to **Automatic**.

»»» Important

- Depending on the application software you use, you may not be able to select setting items other than **ColorSync**.
- If you choose a **Profile** setting other than **Automatic**, the printer will not be able to print with the correct colors.

3. Complete the setup

Click **Print**.

When you execute print, the printer uses the color space of the image data.

Related Topics

- [Specifying Color Correction](#)
- [Adjusting Color Balance](#)

- [Adjusting Brightness](#)
- [Adjusting Intensity](#)
- [Adjusting Contrast](#)

Printing with ICC Profiles (Specifying an ICC Profile from the Printer Driver)

Print from an application software that cannot identify or specify input ICC profiles by using the color space of the input ICC profile (sRGB) found in the data.

1. Select **Color Matching** from the pop-up menu of the [Print Dialog](#)

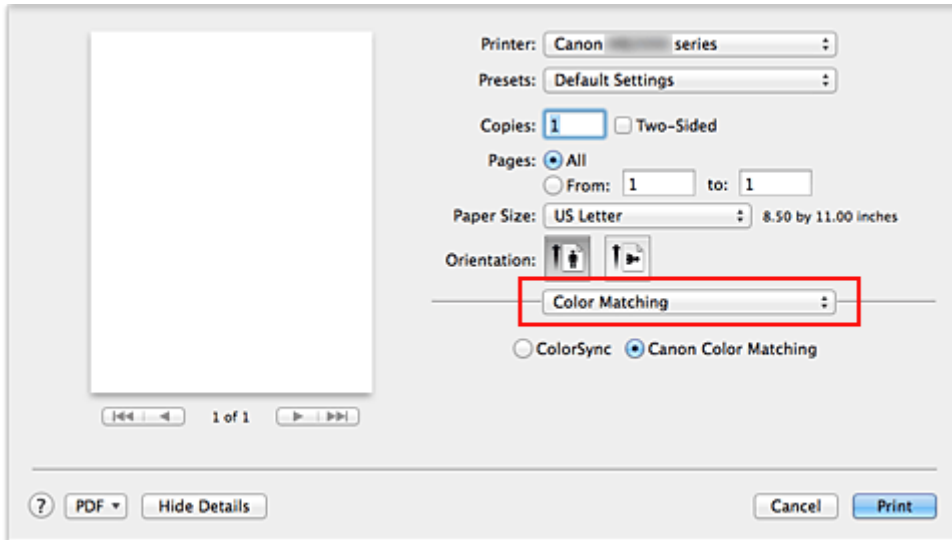

2. Select color correction

Select **ColorSync**.

You can leave **Profile** set to **Automatic**.

»»» Important

- If you choose a **Profile** setting other than **Automatic**, the printer will not be able to print with the correct colors.

3. Complete the setup

Click **Print**.

When you execute print, the printer uses the color space of the image data.

»»» Important

- You cannot specify an input ICC profile from the printer driver.

Related Topics

- [Specifying Color Correction](#)
- [Adjusting Color Balance](#)
- [Adjusting Brightness](#)
- [Adjusting Intensity](#)
- [Adjusting Contrast](#)

Adjusting Color Balance

You can adjust the color tints when printing.

Since this function adjusts color balance of the output by changing the ink ratios of each color, it changes the total color balance of the document. Use the application software when you want to change the color balance significantly. Use the printer driver only when you want to adjust the color balance slightly.

The following sample shows the case when color balance is used to intensify cyan and to diminish yellow so that the overall colors are more uniform.



No adjustment Adjust color balance

The procedure for adjusting color balance is as follows:

1. Select **Color Options** from the pop-up menu of the [Print Dialog](#)
2. Adjust color balance

There are individual sliders for **Cyan**, **Magenta**, and **Yellow**. Each color becomes stronger when the corresponding slider is moved to the right, and becomes weaker when the corresponding slider is moved to the left. For example, when cyan becomes weaker, the color red becomes stronger.

You can also directly enter a value linked to the slider. Enter a value in the range from -50 to 50. The current settings are displayed in the settings preview on the left side of the printer driver.

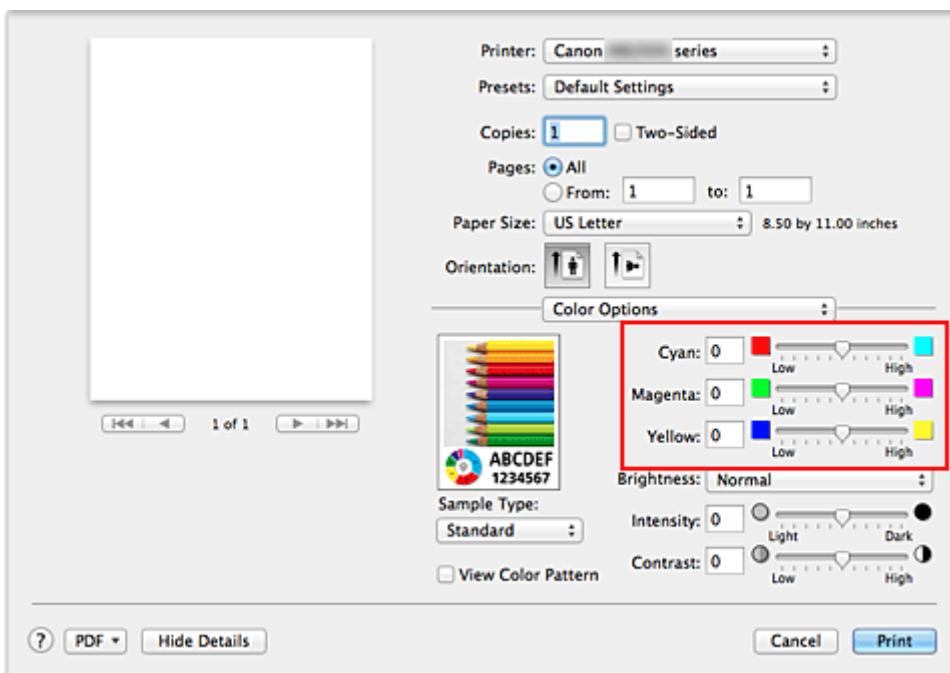

3. Complete the setup

Click **Print**.

When you execute print, the document is printed with the adjusted color balance.

»» Important

- When the **Grayscale Printing** check box is checked for **Quality & Media**, the color balance (**Cyan, Magenta, Yellow**) appear grayed out and are unavailable.
- If you select **ColorSync** for **Color Matching**, then the color balance (**Cyan, Magenta, Yellow**) appear grayed out and are unavailable.

Related Topics

- [Specifying Color Correction](#)
- [Adjusting Brightness](#)
- [Adjusting Intensity](#)
- [Adjusting Contrast](#)

Adjusting Brightness

You can change the brightness of the overall image data during printing.

This function does not change pure white or pure black but it changes the brightness of the intermediate colors.

The following sample shows the print result when the brightness setting is changed.



Light is selected

Normal is selected

Dark is selected

The procedure for adjusting brightness is as follows:

1. Select **Color Options** from the pop-up menu of the [Print Dialog](#)
2. Specify the brightness

Select **Light**, **Normal**, or **Dark** for **Brightness**. The current settings are displayed in the settings preview on the left side of the printer driver.

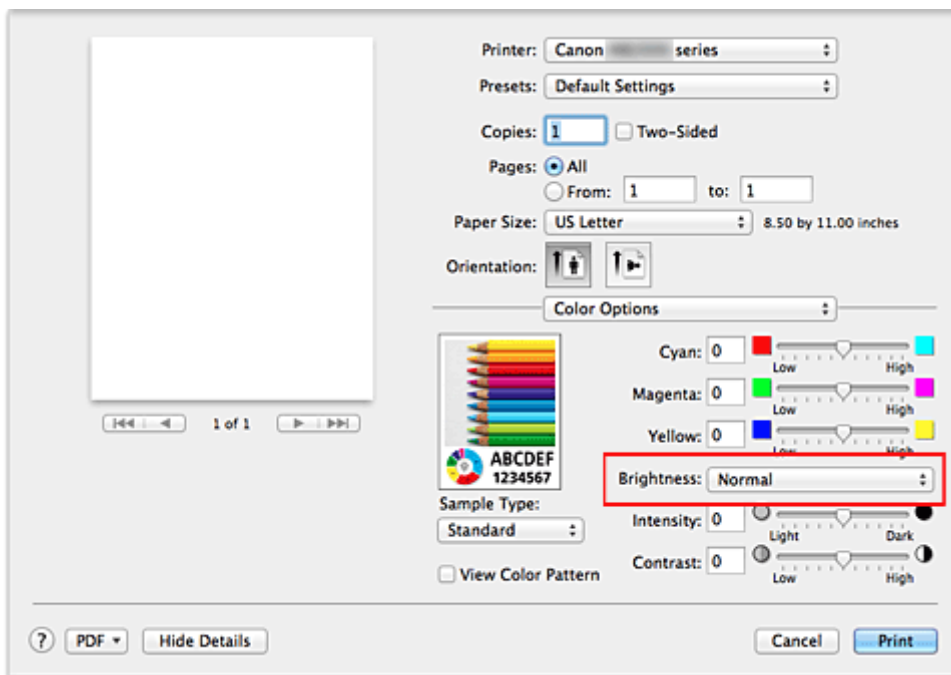

3. Complete the setup

Click **Print**.

When you execute print, the data is printed at the specified brightness.

▶▶▶ Important

- If you select **ColorSync** for **Color Matching**, then the **Brightness** appears grayed out and is unavailable.

Related Topics

- [Specifying Color Correction](#)
- [Adjusting Color Balance](#)
- [Adjusting Intensity](#)
- [Adjusting Contrast](#)

Adjusting Intensity

You can dilute (brighten) or intensify (darken) the colors of the overall image data during printing. The following sample shows the case when the intensity is increased so that all colors become more intense when the image data is printed.



No adjustment

Higher intensity

The procedure for adjusting intensity is as follows:

1. Select **Color Options** from the pop-up menu of the [Print Dialog](#)
2. Adjust intensity

Moving the **Intensity** slider to the right intensifies (darkens) the colors, and moving the slider to the left dilutes (brightens) the colors.

You can also directly enter a value linked to the slider. Enter a value in the range from -50 to 50. The current settings are displayed in the settings preview on the left side of the printer driver.

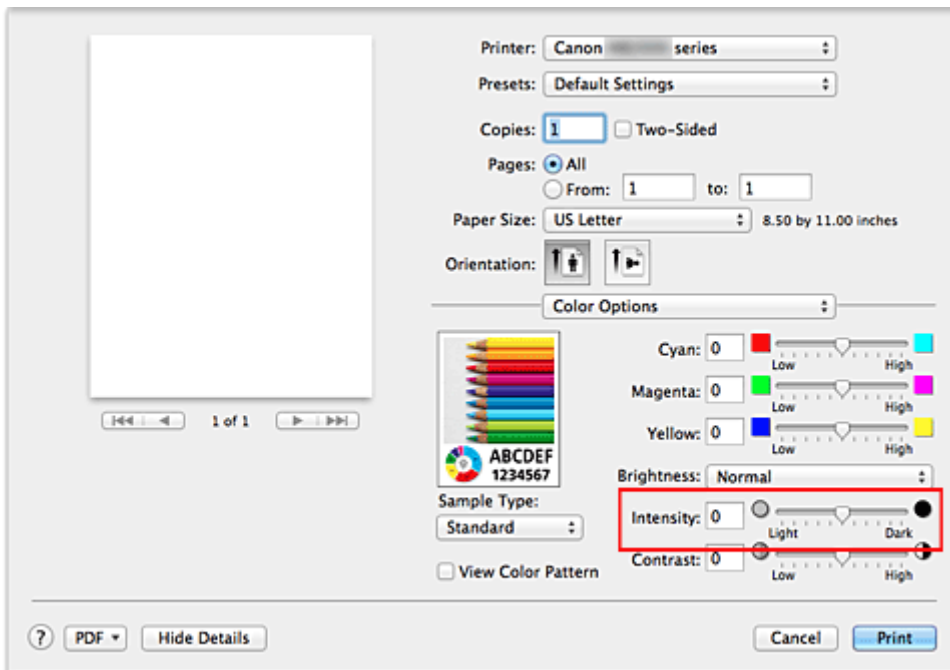

3. Complete the setup

Click **Print**.

When you execute print, the image data is printed with the adjusted intensity.

▶▶▶ Important

- If you select **ColorSync** for **Color Matching**, then the **Intensity** appears grayed out and is unavailable.

Related Topics

- [Specifying Color Correction](#)
- [Adjusting Color Balance](#)
- [Adjusting Brightness](#)
- [Adjusting Contrast](#)

Adjusting Contrast

You can adjust the image contrast during printing.

To make the differences between the light and dark portions of images greater and more distinct, increase the contrast. On the other hand, to make the differences between the light and dark portions of images smaller and less distinct, reduce the contrast.



No adjustment

Adjust the contrast

The procedure for adjusting contrast is as follows:

1. Select **Color Options** from the pop-up menu of the [Print Dialog](#)
2. Adjust the contrast

Moving the **Contrast** slider to the right increases the contrast, and moving the slider to the left decreases the contrast.

You can also directly enter a value linked to the slider. Enter a value in the range from -50 to 50. The current settings are displayed in the settings preview on the left side of the printer driver.

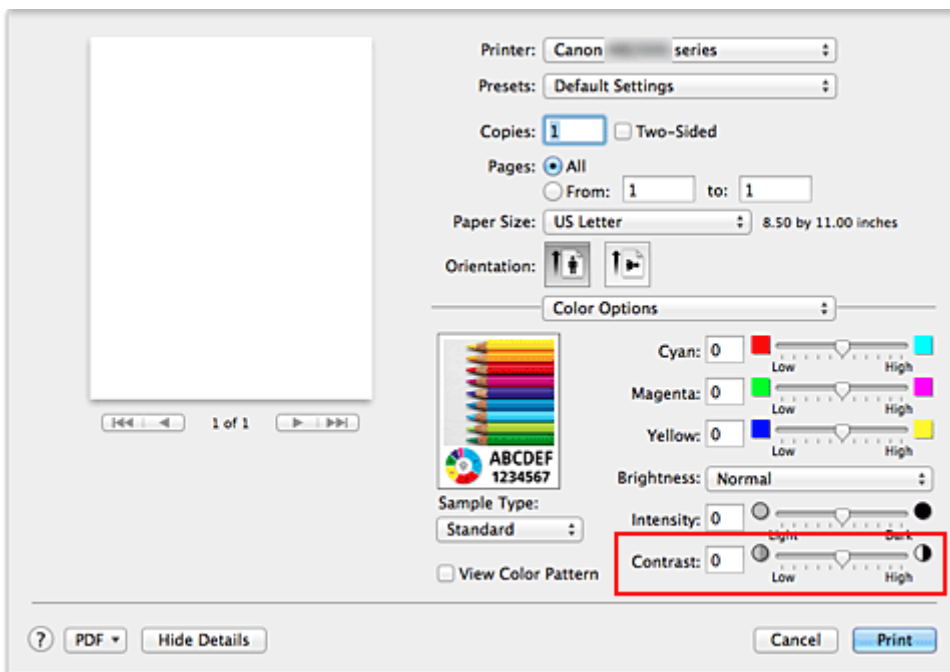

3. Complete the setup

Click **Print**.

When you execute print, the image is printed with the adjusted contrast.

Important

- If you select **ColorSync** for **Color Matching**, then the **Contrast** appears grayed out and is unavailable.

Related Topics

- [Specifying Color Correction](#)
- [Adjusting Color Balance](#)
- [Adjusting Brightness](#)
- [Adjusting Intensity](#)

Overview of the Printer Driver

- **Canon IJ Printer Driver**
- **How to Open the Printer Driver Setup Window**
- **Page Setup Dialog**
- **Print Dialog**
- **Quality & Media**
- **Color Options**
- **Margin**
- **Canon IJ Printer Utility**
- **Opening the Canon IJ Printer Utility**
- **Maintenance of this Printer**
- **Display the Printing Status Screen**
- **Deleting the Undesired Print Job**
- **Instructions for Use (Printer Driver)**

Canon IJ Printer Driver

The Canon IJ printer driver (called printer driver below) is a software that is installed on your computer for printing data with this printer.

The printer driver converts the print data created by your application software into data that your printer can understand, and sends the converted data to the printer.

Because different models support different print data formats, you need a printer driver for the specific model you are using.

Using Help of the Printer Driver

You can display Help function from the [Print Dialog](#).

Select a setup item from the pop-up menu in the Print dialog. Then click  at the bottom left of the screen to display an explanation of the item.

Help for the printer driver is displayed when the following pop-up menu item is selected:

- **Quality & Media**
- **Color Options**
- **Margin**

How to Open the Printer Driver Setup Window

You can display the printer driver setup window from the application software you are using.

Opening the Page Setup Dialog

Use this procedure to set the page (paper) settings before printing.

1. Select **Page Setup...** from the **File** menu of the application software

The [Page Setup Dialog](#) opens.

Opening the Print Dialog

Use this procedure to set the print settings before printing.

1. Select **Print...** from the **File** menu of the application software

The [Print Dialog](#) opens.

Page Setup Dialog

In the Page Setup dialog, you configure the basic print settings such as the size of paper loaded in the printer or the scaling ratio.

To open the Page Setup dialog, you typically select **Page Setup...** from the **File** menu of your application software.

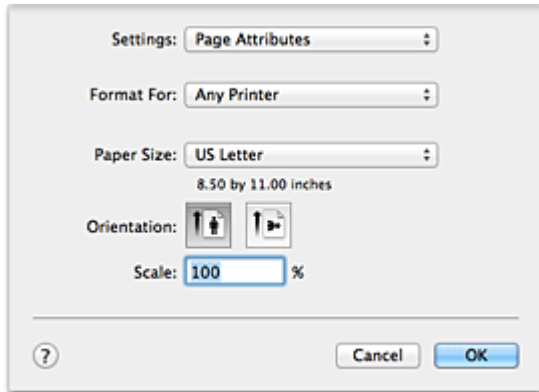

Settings

Click the pop-up menu, and then select the following items:

Page Attributes

Set the paper size or scaled printing.

Save as Default

You can save the attributes of the displayed page as the default settings.

Format For

Select the model to be used for printing.

Paper Size

Select the size of the paper to be used for printing.

To set a non-standard size, select **Manage Custom Sizes....**

Orientation

Select the print orientation.

Scale

Set the scaling percentage.

You can expand or reduce the size of the document when printing.

Print Dialog

In the Print dialog, you can set paper type and print quality to start printing.

To open the Print dialog, you typically select **Print...** from the **File** menu of your application software.

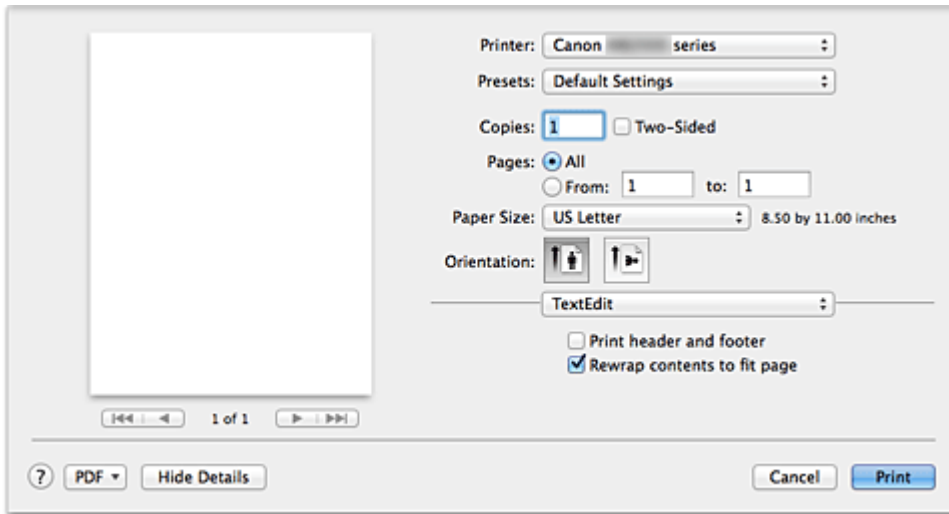

Printer

Select the model to be used for printing.

When you click **Add Printer...**, a dialog for specifying the printer opens.

Presets

You can save or delete the settings of the Print dialog.

»» Note

- If you are using OS X Mavericks v10.9, OS X Mountain Lion v10.8, or OS X Lion v10.7, you can select **Show Presets...** to check the print settings that are set in the Print dialog.

Copies

You can set the number of copies to be printed.

»» Note

- If you are using Mac OS X v10.6.8, you can also set collate printing.
- If you are using OS X Mavericks v10.9, OS X Mountain Lion v10.8, or OS X Lion v10.7, you can set collated printing by choosing **Paper Handling** from the pop-up menu.

Two-Sided

You can set duplex printing.

Pages

You can set the range of pages to be printed.

Paper Size

Select the size of the paper to be used for printing.

To set a non-standard size, select **Manage Custom Sizes...**

Orientation

Select the print orientation.

Pop-up Menu

You can switch between pages in the Print dialog by the pop-up menu. The first menu to appear differs depending on the application software that opened the Print dialog.

You can choose one of the following items from the pop-up menu.

Layout

You can set page layout printing.

Use **Reverse page orientation** to change the paper orientation, and use **Flip horizontally** to print a mirror image of the document. You can also set duplex printing.

Color Matching

You can select the color correction method.

Paper Handling

You can set the pages to be printed on paper and the print order.

Cover Page

You can output cover pages both before and after a document.

Scheduler

You can set the print start time and print priorities.

Quality & Media

You can set basic print settings that match the printer.

Color Options

You can adjust the print colors as you desire.

Margin

You can set the stapling side and the stapling margin.

Supply Levels

A rough indication of the remaining ink level is displayed.

Summary

The selected items in the Print dialog are displayed.

»» Important

- If you are using OS X Mavericks v10.9, OS X Mountain Lion v10.8, or OS X Lion v10.7, you cannot use **Scheduler** and **Summary**.

PDF

You can save a document in PDF (Portable Document Format) format.

Preview

If you are using Mac OS X v10.6.8, when you click  (the disclosure triangle) on the side of **Printer** and switch to the simple display, **Preview** is displayed.

This button allows you to check the print results on the screen before printing.

Quality & Media

This dialog allows you to create a basic print setup in accordance with the paper type. Unless special printing is required, normal printing can be performed just by setting the items in this dialog.

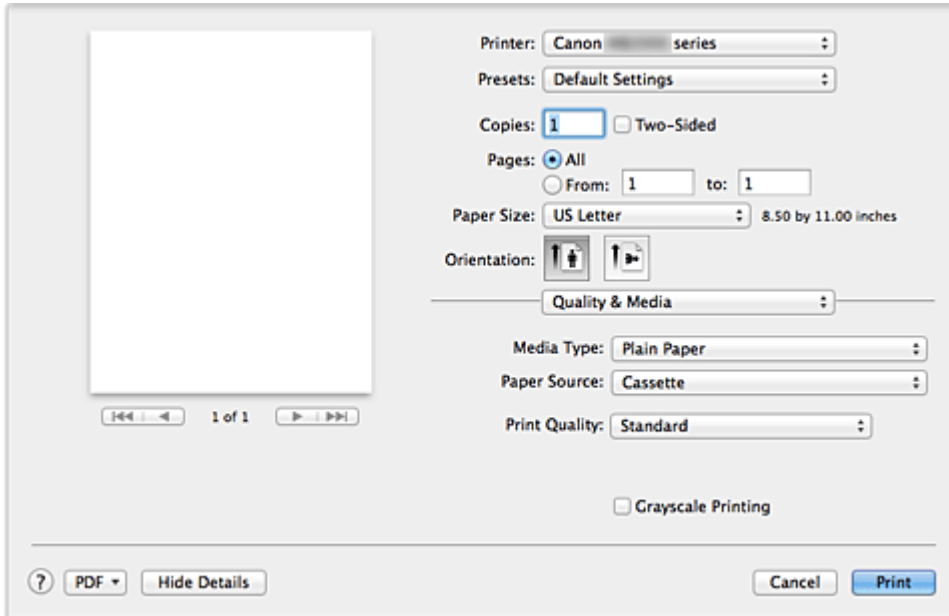

Media Type

Select the type of media to be used.

You must select the type of media actually loaded in the printer. This selection enables the printer to carry out printing properly for the material of the media used.

Paper Source

Shows the source from which paper is supplied.

Print Quality

Select the one that is closest to the original document type and the purpose.

When one of the radio buttons is selected, the appropriate quality will be set automatically.

High

Gives priority to print quality over printing speed.

Standard

Prints with average speed and quality.

Grayscale Printing

Set grayscale printing. Grayscale printing refers to the function of converting your document to grayscale data in the printer to print it in monochrome.

When you check the check box, both monochrome and color documents will be printed in monochrome.

When printing a color document, be sure to uncheck the check box.

Related Topic

- [Printing a Color Document in Monochrome](#)

Color Options

This dialog allows you to adjust the print color as you like. If the color of the printed image is not as expected, adjust the properties in the dialog and retry printing.

The adjustments made here do not affect the colors of the original print data unlike application software dedicated to image processing. Use this dialog just to make fine adjustments.

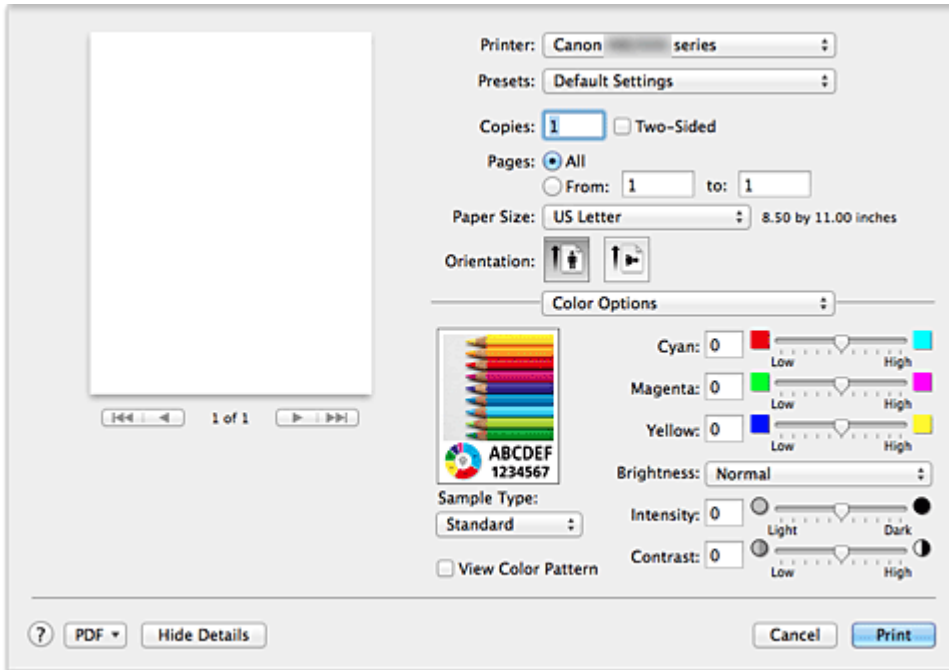

Preview

Shows the effect of color adjustment.

As you adjust each item, the effects are reflected in the color and brightness.

Sample Type

Select an image that you want to display as a sample.

If necessary, select one from **Standard**, **Portrait**, **Landscape**, or **Graphics**, whichever is most similar to the print results.

View Color Pattern

Displays a pattern for checking color changes produced by color adjustment.

When you want to display the sample image with a color pattern, check this check box.

When you want to display the sample image with one that you selected with **Sample Type**, uncheck this check box.

▶▶▶ Note

- When the **Grayscale Printing** check box is checked in the **Quality & Media**, the graphic is displayed in monochrome.

Color balance (Cyan, Magenta, Yellow)

If necessary, adjust the strength of each color. To strengthen a color, drag the slider to the right. To weaken a color, drag the slider to the left.

You can also directly enter a value linked to the slider. Enter a value in the range from -50 to 50.

Adjusting the color balance will result in variations in the balance among the volumes of the individual color inks and hence in the hues of the document as a whole.

Use the printer driver only when adjusting the color balance slightly. To change the color balance significantly, use the application software.

Brightness

Select the brightness of printed images.

You cannot change the levels of pure white and black. You can change the contrast of the colors between white and black.

Intensity

Select this method to adjust the overall density of your print.

To increase the overall intensity, drag the slider to the right. To decrease the overall intensity, drag the slider to the left.

You can also directly enter a value linked to the slider. Enter a value in the range from -50 to 50.

Contrast

The Contrast function changes the differences between light and dark in images during printing.

To make the differences between the light and dark portions of images greater and more distinct, increase the contrast. On the other hand, to make the differences between the light and dark portions of images smaller and less distinct, reduce the contrast.

You can also directly enter a value linked to the slider. Enter a value in the range from -50 to 50.

»» Important

- When the **Grayscale Printing** check box is checked for **Quality & Media**, the color balance (**Cyan, Magenta, Yellow**) appear grayed out and are unavailable.
- If you select **ColorSync** for **Color Matching**, then the color balance (**Cyan, Magenta, Yellow**), **Brightness**, **Intensity**, and **Contrast** appear grayed out and are unavailable.

Related Topics

- [Specifying Color Correction](#)
- [Adjusting Color Balance](#)
- [Adjusting Brightness](#)
- [Adjusting Intensity](#)
- [Adjusting Contrast](#)

Margin

This dialog allows you to set the stapling side and amount of margin for stapling multiple sheets of paper.

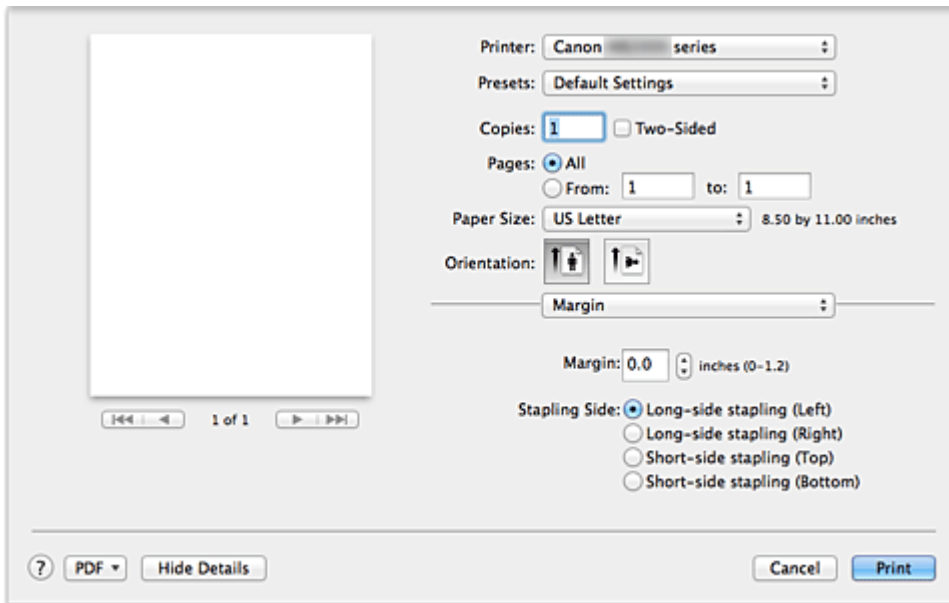

Margin

Specify the amount of margin space for stapling the paper. Enter a value between 0 inches (0 mm) to 1.2 inches (30 mm).

Stapling Side

Specify the stapling side.

Long-side stapling (Left) / Long-side stapling (Right)

Select this option to staple the long side of the paper.

Choose left or right.

Short-side stapling (Top) / Short-side stapling (Bottom)

Select this option to staple the short side of the paper.

Choose top or bottom.

Related Topics

- [Setting the Stapling Margin](#)
- [Duplex Printing](#)

Canon IJ Printer Utility

The Canon IJ Printer Utility allows you to perform printer maintenance or change the settings of the printer.

What You Can Do with the Canon IJ Printer Utility

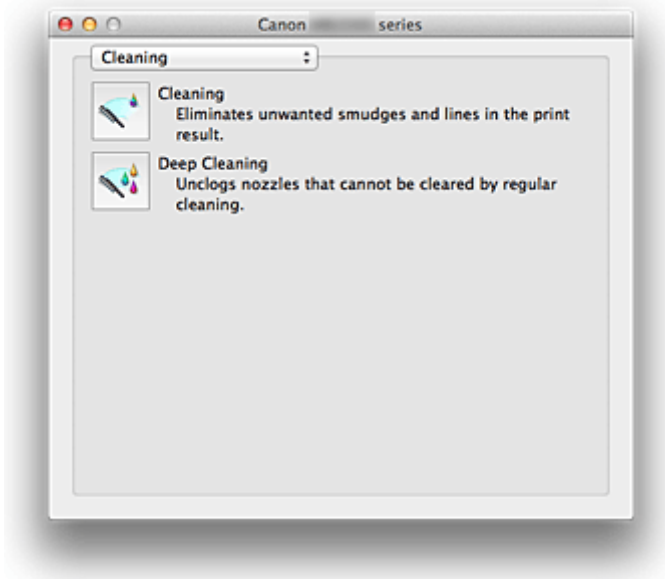

You can switch between pages in Canon IJ Printer Utility by the pop-up menu. You can choose one of the following items from the pop-up menu.

Cleaning

Clean the printer to clear up clogged print head nozzle.

Test Print

Execute a test print to check the condition of the print head nozzle and to adjust the print head position.

Power Settings

Operate the power of this printer from the printer driver.

Ink Level Information

Check the remaining ink levels.

Quiet Settings

You can reduce the operating noise of the printer.

Custom Settings

Change the settings of this printer.

►►► Note

- To operate the Canon IJ Printer Utility, you must first turn on the printer.
- Depending on the items selected, the computer communicates with the printer to obtain information. If the computer is unable to communicate with the printer, an error message may be displayed. If this happens, click **Cancel** to display the most recent settings specified on your computer.

Related Topics

- [Cleaning the Print Heads from Your Computer](#)
- [Use Your Computer to Print a Nozzle Check Pattern](#)

- [Aligning the Print Head Position from Your Computer](#)
- [Checking the Ink Status from Your Computer](#)
- [Managing the Printer Power](#)
- [Reducing the Printer Noise](#)
- [Changing the Printer Operation Mode](#)

Opening the Canon IJ Printer Utility

To open the Canon IJ Printer Utility, follow the steps below.

1. Open **System Preferences**, and select **Printers & Scanners (Print & Scan or Print & Fax)**

2. Start the Canon IJ Printer Utility

Select your model from the printer list, and click **Options & Supplies...**

Click **Open Printer Utility** in **Utility** tab.

Canon IJ Printer Utility is launched.

Maintenance of this Printer

- **Cleaning the Print Heads from Your Computer**
- **Use Your Computer to Print a Nozzle Check Pattern**
- **Aligning the Print Head Position from Your Computer**
- **Checking the Ink Status from Your Computer**
- **Managing the Printer Power**
- **Reducing the Printer Noise**
- **Changing the Printer Operation Mode**

Display the Printing Status Screen

Check the print progress according to the following procedure:

1. Launch the printing status screen

- If the print data has been sent to the printer

The printing status screen opens automatically. To display the printing status screen, click the  (the printer icon) displayed on the Dock.

- If the print data has not been sent to the printer





Open **System Preferences**, and select **Printers & Scanners (Print & Scan or Print & Fax)**. To display the printing status screen, select the name of your printer model from the printer list, and then click **Open Print Queue...**

2. Checking the printing status

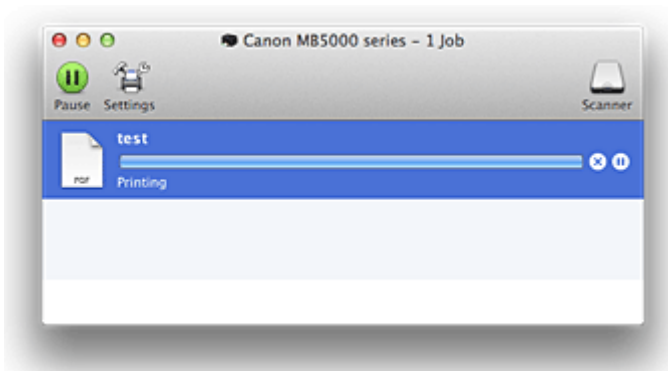
You can check the name of the file being printed or ready for being printed.







- If you are using OS X Mavericks v10.9 or OS X Mountain Lion v10.8

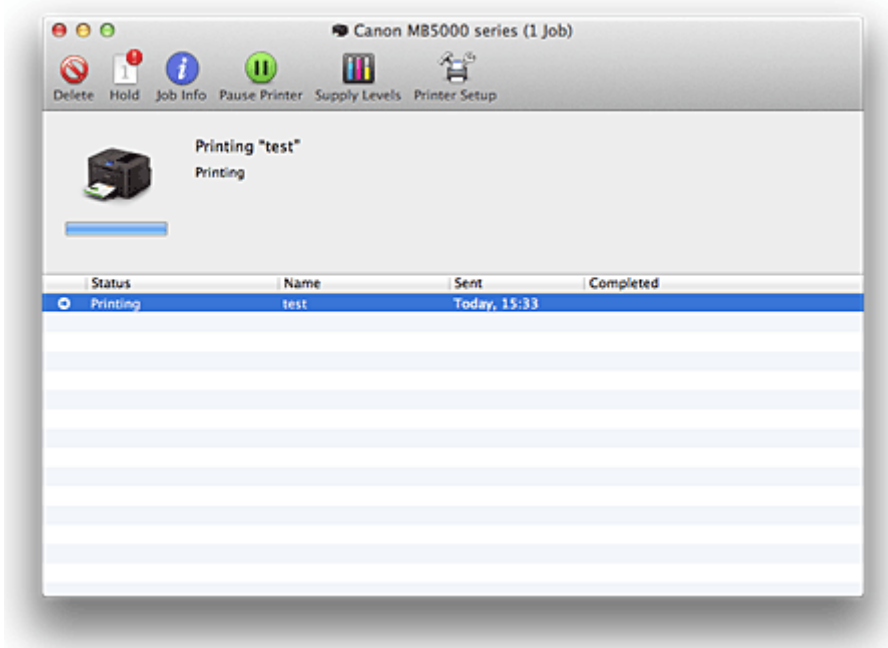

-  Deletes the specified print job.
-  Stops printing the specified document.
-  Resumes printing the specified document.
-  Stops printing all documents.
-  Displayed only when printing of all documents is being stopped, and resumes printing all documents.

- If you are using OS X Lion v10.7 or Mac OS X v10.6.8



-  Deletes the specified print job.
-  Stops printing the specified document.
-  Resumes printing the specified document.
-  Displays the print job information.
-  Stops printing all documents.
-  Displayed only when printing of all documents is being stopped, and resumes printing all documents.

Deleting the Undesired Print Job

If the printer does not start printing, canceled or failed print job data may be remaining. Delete unnecessary print jobs from the print status check screen.

1. Open **System Preferences**, and select **Printers & Scanners (Print & Scan or Print & Fax)**

2. Select your model, and then click **Open Print Queue...**

The print status check screen appears.

3. Select the unnecessary print job and click  ( **Delete**)

The selected print jobs will be deleted.

Instructions for Use (Printer Driver)

This printer driver is subject to the following restrictions. Keep the following points in mind when using the printer driver.

Restrictions on the Printer Driver

- When you set up the Page Setup dialog, be sure to begin by selecting the model you are using from the **Format For** list. If you select another printer, printing may not be performed properly.
- If the Canon IJ Printer Utility does not display the remaining ink level in the **Ink Level Information**, check whether the print head and the ink tank are properly installed.
- When the Canon IJ Printer Utility displays the **Ink Level Information**, close the operation panel of the printer.
- The following functions cannot be used in Mac OS, though they can be used in Windows computers.
 - Duplex Printing (manual)
 - Booklet Printing
 - Tiling/Poster Printing
- Depending on the application software that you are using, a preview may not be displayed on the left side of the Print dialog.
- Do not start up the Canon IJ Network Tool while printing.
- Do not print when the Canon IJ Network Tool is running.
- If you connect this printer and AirPort with a USB cable and print, you must install the latest AirPort firmware.
- If you are using OS X Mavericks v10.9, close the print status check window when you perform printer maintenance from the Canon IJ Printer Utility.

Notes on Adding a Printer

- If you will be installing the Canon printer driver on Mac OS and using the printer through a network connection, you can select **Bonjour** or **Canon IJ Network** in the **Add (Add Printer)** dialog. Canon recommends you to use **Canon IJ Network** for printing. If **Bonjour** is selected, remaining ink level messages may differ from those indicated by **Canon IJ Network**.

Updating the Printer Driver

- **Obtaining the Latest Printer Driver**
- **Delete the Unnecessary Canon IJ Printer from the Printer List**
- **Before Installing the Printer Driver**
- **Installing the Printer Driver**

Obtaining the Latest Printer Driver

By updating the printer driver to the latest version of the printer driver, unresolved problems may be solved.

You can access our website and download the latest printer driver for your model.

»» Important

- You can download the printer driver for free, but any Internet access charges incurred are your responsibility.

Related Topics

- [Before Installing the Printer Driver](#)
- [Installing the Printer Driver](#)

Delete the Unnecessary Canon IJ Printer from the Printer List

A Canon IJ Printer that you no longer use can be deleted from the printer list.

Before deleting the Canon IJ Printer, disconnect the cable that connects the printer to the computer.

The procedure to delete the unnecessary Canon IJ Printer from the printer list is as follows:

You cannot delete the Canon IJ Printer unless you are logged in as a user with the administrative right. For information about an administrative user, refer to the user's manual for the Mac OS.

1. Open **System Preferences**, and select **Printers & Scanners (Print & Scan or Print & Fax)**

2. Delete the Canon IJ Printer from the printer list

From the printer list, select the Canon IJ Printer to be deleted, and then click -.

Click **Delete Printer** when the confirmation message appears.

▶▶ Note

- Even if a Canon IJ Printer is deleted from the printer list, you can re-register it automatically by connecting the printer and your computer with a USB cable.

Before Installing the Printer Driver

This section describes the items that you should check before installing the printer driver. You should also refer to this section if the printer driver cannot be installed.

Checking the Personal Computer Settings

- Terminate all running applications.
- Log on as a user who has the administrator account. The installer will prompt you to enter the name and password of the administrative user. When multiple users are using Mac OS, log on with the account of the administrator who registered first.

»» Important

- When you upgrade Mac OS, all printer drivers that were installed will be deleted. If you plan to continue using this printer, re-install the latest printer driver.

Related Topics

- [Obtaining the Latest Printer Driver](#)
- [Installing the Printer Driver](#)

Installing the Printer Driver

You can access our web site through the Internet and download the latest printer driver for your model.

The procedure for installing the downloaded printer driver is as follows:

1. Mount the disk

Double-click the disk image file you have downloaded.
The file is unpacked, and then the disk is mounted.

2. Start the installer

Double-click "PrinterDriver_XXX_YYY.pkg" (where "XXX" is your model name, and "YYY" is version) contained in the disk.

3. Start the installation

Install the printer driver according to the messages on the screen.

When the Software License Agreement is displayed, check the contents, and click **Continue**. If you do not agree to the terms of the Software License Agreement, you cannot install this software.

4. Selecting the install destination

If necessary, select where you want to install the printer driver, and then click **Continue**.

5. Executing the installation

Click **Install**.

When the authentication screen is displayed, enter the name and password of the administrator, and then click **Install Software (OK)**.

6. Complete the installation

When the completion message appears, click **Close**.

The printer driver is installed successfully.

Important

- If the Installer does not operate properly, select **Quit Installer** from the **Installer** menu of the Finder to quit the Installer. Then start the Installer again.
- You can download the printer driver for free, but you are responsible for paying any connection fees to the Internet.

Related Topics

- [Obtaining the Latest Printer Driver](#)
- [Delete the Unnecessary Canon IJ Printer from the Printer List](#)
- [Before Installing the Printer Driver](#)

Printing Using the Operation Panel of the Machine

- **Printing Photo Data**
- **Printing Documents (PDF File) Saved on a USB Flash Drive**

Printing Photo Data

- **Printing Photographs Saved on a USB Flash Drive**
- **Setting Items for Photo Printing Using the Operation Panel of the Machine**
- **Using Useful Display Functions**

Printing Photographs Saved on a USB Flash Drive

You can print the photograph saved on the USB flash drive easily.

1. [Make sure that the machine is turned on.](#)
2. [Load photo paper.](#)
3. [Insert the USB flash drive into the USB flash drive port.](#)

▶▶▶ Important

- If you already insert the USB flash drive to save the received faxes automatically, you cannot print the photographs even when the USB flash drive which contains the photo data is set.

In this case, set **Auto save setting** in **FAX settings** to **OFF** and remove the USB flash drive for saving faxes, then insert the USB flash drive which contains the photo data.

4. Flick the HOME screen, then tap  **Access medium.**

■ Using the Operation Panel

The photo selection screen is displayed.

▶▶▶ Note

- If both photo files and PDF files are saved on USB flash drive, the confirmation screen to select which file you print is displayed. Tap **Print photos** in the displayed screen.
- If no printable photo data is saved on the USB flash drive, **Data of supported types are not saved.** is displayed on the touch screen.
- If more than 2,000 photo data are saved on the USB flash drive, the photo data is split by group per 2,000 photos in reverse chronological order (date last modified) automatically. Check the message displayed on the touch screen, then tap **OK**.

5. Specify the settings as necessary.

- To select the photo to print:

Flick horizontally to select the photo.

You can also select the photo by tapping "A".

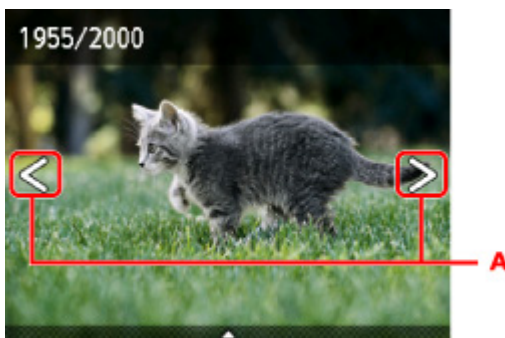

You can print a copy of the displayed photo by pressing the **Color** button.

- To change the display method, the number of copies, or the print settings:

Tap near the center of the displayed photo to display menus.

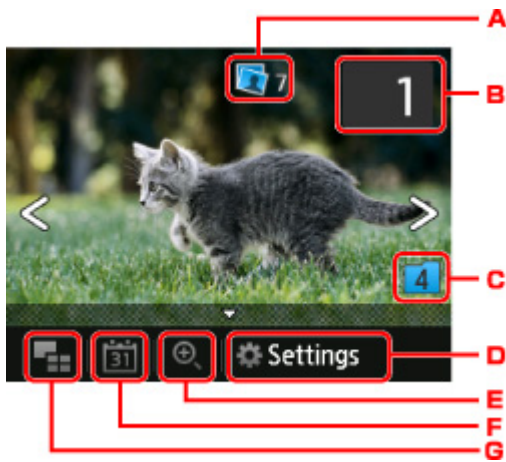

A. Total number of copies

Total number of copies is displayed.

When tapping, the **Check total no. of copies** screen is displayed and you can check the number of copies for each photo. On the **Check total no. of copies** screen, you can change the number of copies for each photo.

B. Number of copies

Tap to specify the number of copies.

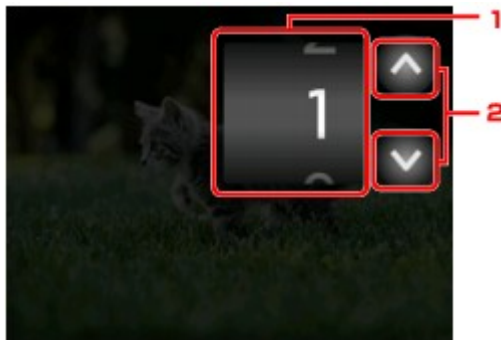

1. Flick vertically to specify the number of copies.

Tap to display the photo selection screen.

2. Tap to specify the number of copies.

Touch and hold to specify the number of copies by 10 copies.

➤➤➤ **Note**

- You can specify the number of copies for each photo. Display the photo you want to print, then specify the number of copies when the desired photo is displayed.

C. Switching group

Tap to switch the photo group.

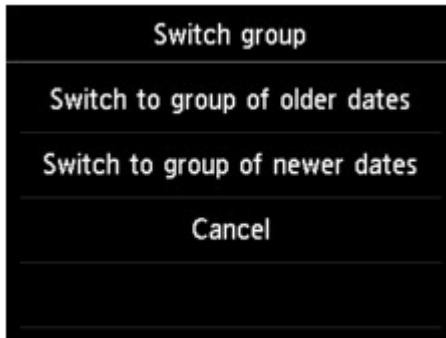

For details:

■ [Using Useful Display Functions](#)

D. Settings

Tap to display the **Settings** screen.

You can change the settings of page size, media type, and print quality and so on.

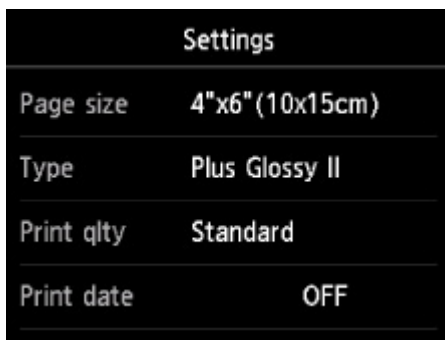

For details on the setting items:

■ [Setting Items for Photo Printing Using the Operation Panel of the Machine](#)

E. Zooming in

Tap to zoom in on the photo.



For details:

■ [Using Useful Display Functions](#)

F. Date specification

Tap to select photo with specifying the date (last modified date of data).



For details:

■ [Using Useful Display Functions](#)

G. Multi display

Tap to display the multiple photos at once.



For details on the display method:

■ [Using Useful Display Functions](#)

6. Press the **Color** button.

The machine starts printing.

▶▶▶ Note

- To cancel printing, press the **Stop** button.
- While processing the print job, you can add the print job (Reserve photo print).

■ [Adding the Print Job](#)

Adding the Print Job

You can add the print job (Reserve photo print) while printing photos.

Follow the procedure below to add the print job.

1. Flick the photo while printing to select the next photo.

▶▶▶ Note

- While you select the photo, the machine prints the reserved photos.

- The  reserved photo icon appears on the photo included in the print job.

2. Specify the number of copies for each photo.

▶▶▶ **Note**

- While processing the print job, you cannot change the setting for **Page size** or **Type** on print settings confirmation screen. The setting is the same as the setting for the photo included in the print job.

3. Press the **Color** button.

The reserved photo is printed next to the photo that has already been started printing.

If you want to print more photos, operate from step 1 again.

▶▶▶ **Note**

- While processing the print job, you cannot display the HOME screen, change the print menu, or print from the computer or other devices.
- While processing the print job, the photo in other group is not selected.
- If you press the **Stop** button while processing the print job, the screen to select a method to cancel reservation is displayed. If you tap **Cancel all reservations**, you can cancel printing all photos. If you tap **Cancel the last reservation**, you can cancel the last printing job.
- If there are many print jobs, **Cannot reserve more print jobs. Please wait a while and redo the operation.** may be displayed on the touch screen. In this case, wait a while, then add the print job.



Setting Items for Photo Printing Using the Operation Panel of the Machine

You can specify the setting of page size, media type, photo fix and so on to print the photos saved on the USB flash drive.

Settings	
Page size	4"x6" (10x15cm) 1
Type	Plus Glossy II 2
Print qlty	Standard 3
Print date	OFF 4

Flick vertically to display setting items, then tap the setting item to display the settings. Tap to specify the setting.

▶▶▶ Note

- Some settings cannot be specified in combination with the other setting items or the print menus. If the setting which cannot be specified in combination is selected,  and **Error details** are displayed on the touch screen. In this case, tap  on the upper left on the touch screen to confirm the message, then change the setting.
- The settings of the page size, media type, etc. are retained even if another print menu is selected or the machine is turned off.

1. Page size

Select the page size of the loaded paper.

2. Type (Media type)

Select the media type of the loaded paper.

3. Print qlty (Print quality)

Select print quality according to the photo.

4. Print date

Activates/deactivates to print the date (shooting date) on a photo.

▶▶▶ Note

- The shooting date is printed according to the settings of **Date display format** in **Device user settings** under **Device settings** under **Setup**.

 [Device user settings](#)

Using Useful Display Functions

You can display the multiple photos at once, specify the date (last modified date of data) to select photos, and switch the photo group.

■ [Viewing Multiple Photos to Select Photo](#)

■ [Specifying Date to Select Photo](#)

■ [Zooming in on the Photo](#)

■ [Switching the Photo Group](#)

Viewing Multiple Photos to Select Photo

The following screen is displayed by tapping  on the photo selection screen.



A. Tap the photo you want to print, the touch screen returns to single photo display.

B. Tap to display photo with specifying the date.

■ [Specifying Date to Select Photo](#)

C. Tap to increase the display photos. (54 photos display)

D. Drag to switch the number of display photos to 6 photos, 15 photos, or 54 photos.

E. Tap to decrease the display photos. (6 photos display)

Specifying Date to Select Photo

The following screen is displayed by tapping  on the photo selection screen.



A. Tap to select the date (last modified date of data).

B. Tap the date to display.

The photos on date specified are displayed.

➤➤ Note

- The date is displayed according to the settings of **Date display format** in **Device user settings** under **Device settings** under **Setup**.

■ [Device user settings](#)

Zooming in on the Photo

The following screen is displayed by tapping  on the photo selection screen.



- A. Tap to switch the display magnification.
- B. Drag to move the display position.

Switching the Photo Group

➤➤ Note

- If more than 2,000 photo data are saved on the USB flash drive, the photo data is split by group per 2,000 photos in reverse chronological order (date last modified) automatically.

The following screen is displayed by tapping  on the photo selection screen.

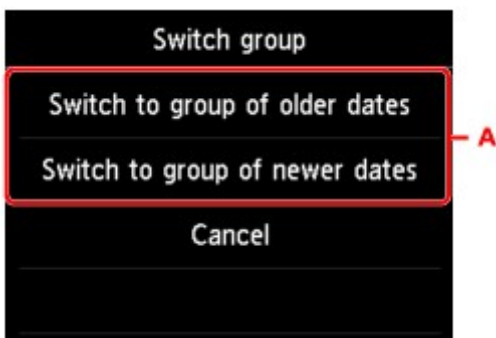

- A. Tap to switch the photo group.

Printing Documents (PDF File) Saved on a USB Flash Drive

You can print PDF files that are scanned using the operation panel of the machine, PDF files that are saved on the USB flash drive when receiving faxes, or PDF files that are made using Canon IJ Scan Utility (application software compatible with the machine) from the USB flash drive.

▶▶▶ Note

- You can print PDF files from a USB flash drive which satisfy the following conditions. Other than the following PDF file cannot be printed even if they appear on the document list.
 - PDF files scanned using the operation panel of the machine and saved on a USB flash drive with **Format** set to **PDF** or **Compact PDF** (Extension: .pdf)
For details on scanning using the operation panel of the machine:
[■ Saving Scanned Data on the USB Flash Drive Using the Operation Panel of the Machine](#)
 - PDF files saved on a USB flash drive when receiving faxes (Extension: .pdf)
For details on how to save the receiving faxes onto a USB flash drive:
[■ Saving a Document in Machine's Memory to a USB Flash Drive](#)
[■ Saving Received Faxes Automatically on a USB Flash Drive](#)
 - PDF files made using Canon IJ Scan Utility (application software compatible with the machine) (Extension: .pdf)
Except for the following data:
 - Encrypted data
 - Data more than 2 GB
 - Data including images scanned at 9601 pixels or more in the vertical and horizontal directionsFor details on making PDF files using Canon IJ Scan Utility (application software compatible with the machine):
[■ Scanning Documents](#)

1. [Make sure that the machine is turned on.](#)
2. [Load A4, Letter, or Legal-sized plain paper.](#)
3. [Insert the USB flash drive into the USB flash drive port.](#)

▶▶▶ Important

- If you already insert the USB flash drive to save the received faxes automatically, you cannot print the documents even when the USB flash drive which contains the document data is set.
In this case, set **Auto save setting** in **FAX settings** to **OFF** and remove the USB flash drive for saving faxes, then insert the USB flash drive which contains the document data.

4. Flick the HOME screen, then tap  **Access medium.**

[■ Using the Operation Panel](#)

The document list is displayed.

▶▶▶ Note

- If both photo files and PDF files are saved on USB flash drive, the confirmation screen to select which file you print is displayed. Tap **Print documents** in the displayed screen.
- If no printable document (PDF files) is saved on the USB flash drive, **Data of supported types are not saved.** is displayed on the touch screen.

5. Select the document to print.

File name list

Preview display

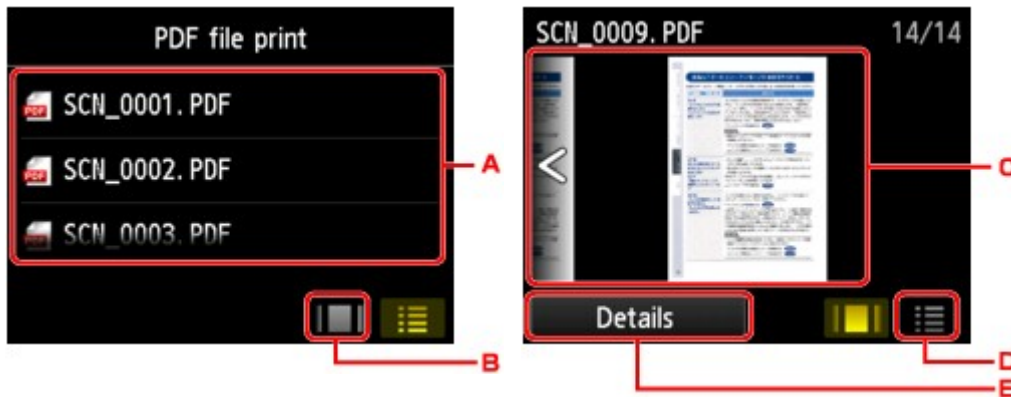

- A. Flick to display the name of documents, then tap document to print.
- B. Tap to switch to the preview display.
- C. Flick to display document preview, then tap document to print.
- D. Tap to switch to the file name list.
- E. Tap to display the **Details** screen.

▶▶▶ Note

- File names may not be displayed properly on the document list if the file name is long or includes incompatible characters.
- On the preview screen, the first page of each PDF file is displayed on the touch screen. In addition, if a document is in landscape format, it will be displayed rotated by 90 degrees.
- For some PDF files, it may take longer to display the preview or part of the preview may be cropped.
- The name of the PDF files is displayed even though the PDF files cannot be printed using the operation panel of the machine. If one of the following conditions is applicable to the PDF files, they are not printable.
 - PDF files saved using application software other than Canon IJ Scan Utility (application software compatible with the machine)
 - PDF files for which the preview screen is not available ("?" is displayed on the preview screen.)
- It is recommended you display the **Details** screen and confirm whether a PDF file is printable. If one of the following conditions is applicable to the PDF file, it is not printable.
 - Information on the **Details** screen cannot be displayed.

- Characters other than the machine name or **IJ Scan Utility** are displayed on **Created with**.
- The PDF files made using application software other than Canon IJ Scan Utility (application software compatible with the machine) are not printable even if they are saved using Canon IJ Scan Utility.

6. Specify the settings as necessary.



1. **Copies**

Specify the number of copies.

2. **Page size**

Select the page size depending on the loaded paper.

3. **Type** (Media type)

The paper type is set to **Plain paper**.

4. **Print qlty** (Print quality)

Specify the print quality.

5. **2-sidedPrintSetting**

Select two-sided printing or single-sided printing.

If you tap **Advanced** with **2-sided** selected, you can specify the orientation and the stapling side of the document.

▶▶▶ **Note**

- When the machine name or **IJ Scan Utility** is displayed in **Created with** on the **Details** screen, you can select **2-sided** to print onto the both sides of a single sheet of paper.

7. Press the **Color** button for color printing, or the **Black** button for black & white printing.

The machine starts printing.

▶▶▶ **Note**

- You can print up to 250 pages at a time. If you try to print more than 250 pages of a PDF file, **The specified PDF file contains too many pages. The pages exceeding the number of printable pages will not be printed. Continue?** is displayed on the touch screen. To start printing, tap **Yes**. If you need to print more than 250 pages of a PDF file, print them from a computer.
- Depending on the PDF file, it may be printed rotated by 90 degrees.
- If the document size is larger than the page size specified on the machine, the document will be printed at a reduced size. In this case, thin lines on the document may not be printed or images may be misaligned.

- For some PDF files, an error message may be displayed before printing starts or while printing is in progress.

For details, see [A Message Is Displayed](#).

Paper setting for Printing

By registering the paper size and the media type loaded in the cassette, you can prevent the machine from misprinting by displaying the message before printing starts when the paper size or the media type of the loaded paper differs from the print settings.

- **When you load paper in the cassette:**



The screen to register the cassette paper information is displayed.

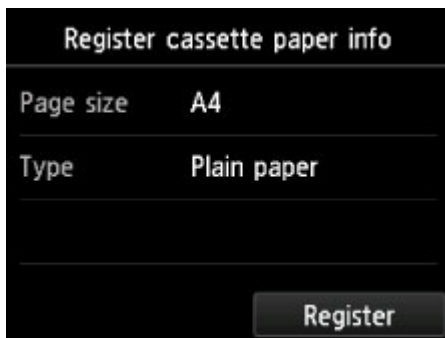

Register the paper size and the media type according to the loaded paper.

▶▶▶ Important

- For details on the proper combination of paper settings you can specify by the printer driver or on the touch screen:
 - [Setting the Media Type with the Printer Driver and on the Printer](#)
 - [Setting the Paper Size with the Printer Driver and on the Printer](#)
- For copying, specify the paper settings for copying so that they match the cassette paper information.

▶▶▶ Note

- Depending on the registered cassette paper information, the screen to confirm if you apply the registered information to the paper settings for copying is displayed. If you tap **Yes**, the information is applied to the paper settings for copying.

- **When the paper settings for printing or copying are different from the cassette paper information registered to the machine:**

Ex:

- Paper setting for printing or copying: B5
- Cassette paper information registered to the machine: A4

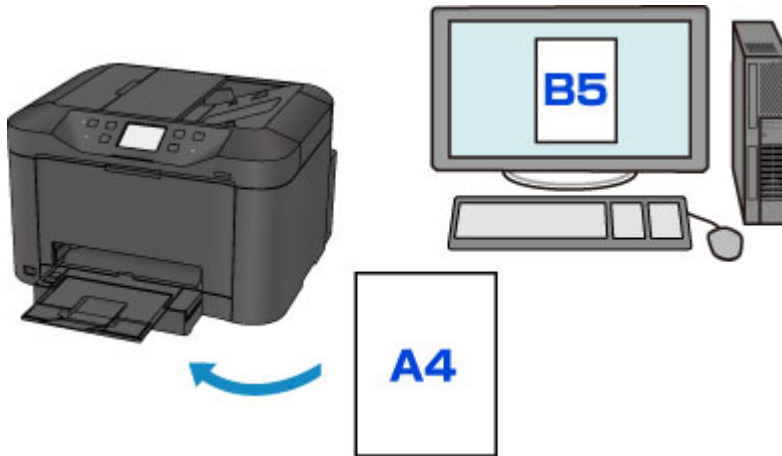

When you start printing or copying, a message is displayed.

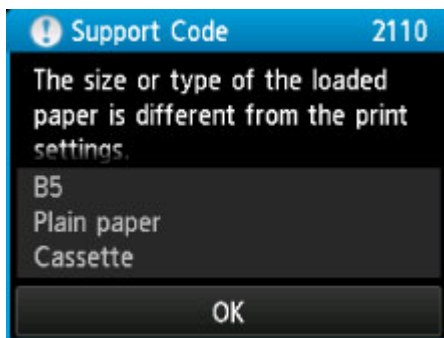

Confirm the message, then tap **OK**. When the screen to select the operation is displayed, select one of the operations below.

►► Note

- Depending on the setting, the choices below may not be displayed.

Print with paper in cass. settings

Select if you want to print on the paper loaded in the cassette without changing the paper settings.

For example, when the paper setting for printing or copying is B5 and the cassette paper information registered to the machine is A4, the machine starts printing or copying with B5 on the paper loaded in the cassette.

Replace the paper and print

Select if you want to print after replacing the paper of the cassette.

For example, when the paper setting for printing or copying is B5 and the cassette paper information registered to the machine is A4, you load B5 sized paper in the cassette before you start printing or copying.

The cassette paper information registration screen is displayed after replacing the paper and inserting the cassette. Register the cassette paper information according to the paper you loaded in the cassette.

►► Note

- If you do not know what paper information to register to the machine, press the **Back** button when the screen to select the operation is displayed. When the previous screen is displayed, confirm the paper size and the media type, then register them to the machine.

- For details on the proper combination of paper settings you can specify by the printer driver or on the touch screen:

- [Setting the Media Type with the Printer Driver and on the Printer](#)

- [Setting the Paper Size with the Printer Driver and on the Printer](#)

Cancel

Cancels printing.

Select when you change the paper settings specified for printing or copying. Change the paper settings, then try printing again.

▶▶▶ Note

- You can disable the message which prevents misprinting. When you disable the message, the machine starts printing or copying even though the paper settings for printing or copying and the cassette paper information registered to the machine are different.
 - To change the setting using the operation panel:
 - [Cassette settings](#)
 - To change the setting using the printer driver:
 - [Changing the Printer Operation Mode](#)

Copying



Making Copies **Basic**



Reducing or Enlarging a Copy



Two-Sided Copying



About Special Copy Menu



Copying Two Pages to Fit onto a Single Page



Copying Four Pages to Fit onto a Single Page



Collated Copying

Making Copies

This section describes the procedure to copy with **Copy**.

1. [Make sure that the machine is turned on.](#)
2. [Load paper.](#)

3. Flick the HOME screen, then tap  **Copy**.

■ Using the Operation Panel

The Copy standby screen is displayed.

4. [Load the original document on the platen glass or in the ADF.](#)
5. Specify the settings as necessary.



- A. The copy layout is displayed.
Switch the layout (single-sided/2-on-1/two-sided).
- B. Tap to specify the number of copies.



1. Tap the numbers to specify the number of copies.
 2. Tap to confirm the number of copies.
- C. Tap to register the current print settings as a custom setting.
[■ Registering the Favorite Settings \(Custom profiles\)](#)
 - D. Tap to display the print setting items.



For details on the setting items:

■ [Setting Items for Copying](#)

E. Tap to preview an image of the printout on the preview screen.

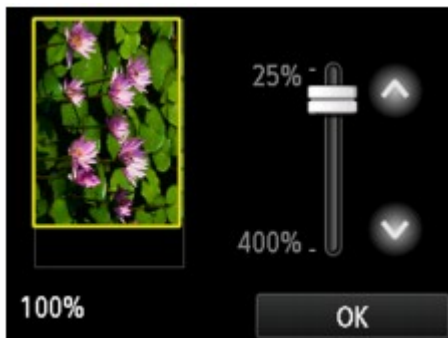

For details:

■ [Displaying the Preview Screen](#)

F. Tap to specify the page size.



6. Press the **Color** button for color copying, or the **Black** button for black & white copying.

The machine starts copying.

Remove the original on the platen glass or from the document output slot after copying is complete.

▶▶ Important

- If you load the original on the platen glass, do not open the document cover or remove the original while **Scanning document...** is displayed on the touch screen.
- If you load the original in the ADF, do not move the original until copying is complete.

▶▶ Note

- To cancel copying, press the **Stop** button.
- If you load the original on the platen glass, you can add the copying job while printing.

■ [Adding the Copying Job \(Reserve copy\)](#)

- When the message informing you that the operation restriction is enabled, ask the administrator of the machine you are using.

For details on the operation restriction of the machine:

■ [About the Machine Administration](#)

Adding the Copying Job (Reserve copy)

If you load the original on the platen glass, you can add the copying job while printing (Reserve copy).

The screen below is displayed when you can add the copying job.

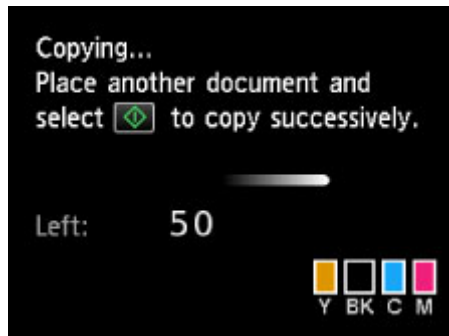

Load the original on the platen glass and press the same button (the **Color** button or the **Black** button) as the one which you previously pressed.



▶▶▶ Important

- When you load the original on the platen glass, move the document cover gently.

▶▶▶ Note

- When **Print qlty** (print quality) is set **High**, or you load the original in the ADF, you cannot add the copying job.
- When you add the copying job, the number of copies or the settings such as the page size or media type cannot be changed.
- If you press the **Stop** button while reserve copying is in progress, the screen to select the method to cancel copying is displayed. If you tap **Cancel all reservations**, you can cancel copying all scanned data. If you tap **Cancel the last reservation**, you can cancel the last copying job.
- If you set a document of too many pages to add the copying job, **Cannot add more copy jobs. Please wait a while and redo the operation.** may appear on the touch screen. Tap **OK** and wait a while, then try copying again.
- If **Failed to reserve the copy job. Start over from the beginning.** appears on the touch screen when scanning, tap **OK**, then press the **Stop** button to cancel copying. After that, copy the documents that have not been finished copying.

Displaying the Preview Screen

When  is displayed on the Copy standby screen, tapping  allows you to preview an image of the printout on the preview screen.

▶▶▶ Important

- The preview screen is not available when you load the original in the ADF.
- In the following conditions,  is not displayed when the Copy standby screen is displayed.
 - **2-sided** is selected for **2-sidedPrintSetting**.
 - **2-on-1 copy** or **4-on-1 copy** is selected for **Layout**.
 - **ON** is selected for **Collate**.

When either of the conditions above is selected, you can set to display the preview screen after scanning the original is finished.

When **2-sided**, **2-on-1 copy**, or **4-on-1 copy** is selected and the original is loaded on the platen glass, you can set to display the preview screen after scanning the original is finished.

[Two-Sided Copying](#)

[Copying Two Pages to Fit onto a Single Page](#)

[Copying Four Pages to Fit onto a Single Page](#)

[Collated Copying](#)

- The original will be scanned to display the preview image. Therefore, do not open the document cover until the preview screen is displayed.
- Originals are rescanned after displaying the preview screen and before copying starts. Therefore, do not open the document cover or remove the original from the platen glass while **Scanning document...** is displayed.

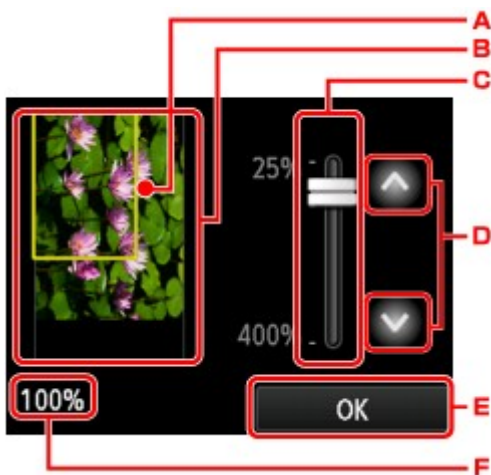

- A. A frame showing the selected page size appears over the image. The inside of the frame will be printed.
- B. The original that is set on the platen glass is displayed. Tap to select **Fit to page**. If the displayed image is skewed, refer to [Loading Originals](#) and reset the original properly, then display the preview screen again and preview the original.
- C. The magnification setting, which was set when the preview screen was displayed, is displayed. If the setting other than **Fit to page** is selected, you can change the magnification setting by dragging the bar on the touch screen.

D. Tap to specify the magnification.

If you keep touching, the magnification is changed by 10 %.

E. Tap to return to the Copy standby screen.

F. The magnification currently specified is displayed. Tap to select **Fit to page**.



Setting Items for Copying

The following screen is displayed by tapping **Settings** on the Copy standby screen.

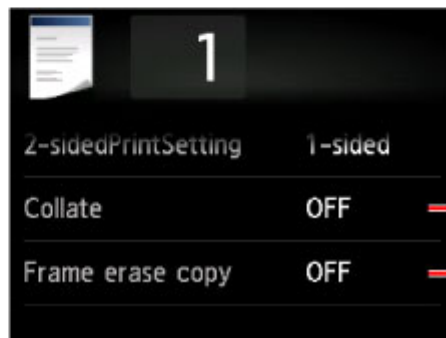
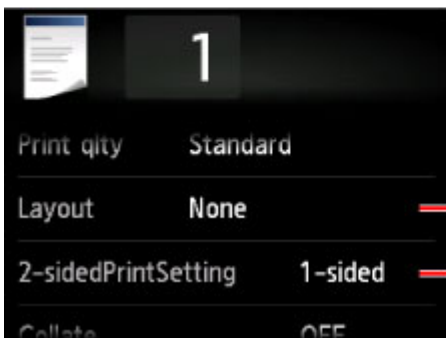
Flick to display setting items, then tap the setting item to display the settings. Tap to specify the setting.



▶▶▶ Note

- Some settings cannot be specified in combination with the setting of other setting item or the copy menu. If the setting which cannot be specified in combination is selected,  and **Error details** are displayed on the touch screen. In this case, tap  on the upper left on the touch screen to confirm the message, then change the setting.
- The settings of the page size, media type, etc. are retained even if the machine is turned off.
- When copying starts in the copy menu that is not available with the specified setting, **The specified function is not available with current settings.** is displayed on the touch screen. Change the setting, following the on-screen instructions.

1. **Magnif.** (Magnification)

Specify the reduction/enlargement method.

 [Reducing or Enlarging a Copy](#)

2. **Intensity**

Specify the intensity.



A. Tap to activate/deactivate automatic intensity adjustment.

When **ON** is selected, the intensity is adjusted automatically according to the originals loaded on the platen glass.

B. Drag to specify the intensity.

C. Tap to confirm the intensity setting.

▶▶▶ Note

- When **Auto** is selected, load the original on the platen glass.

3. Page size

Select the page size of the loaded paper.

4. Type (Media type)

Select the media type of the loaded paper.

5. Print qlty (Print quality)

Adjust print quality according to the original.

▶▶▶ Important

- If you use **Standard** with **Type** set to **Plain paper** and the quality is not as good as expected, select **High** for **Print qlty** and try copying again.
- Select **High** for **Print qlty** to copy in grayscale. Grayscale renders tones in a range of grays instead of black or white.

6. Layout

Select the layout.

■ [Copying Two Pages to Fit onto a Single Page](#)

■ [Copying Four Pages to Fit onto a Single Page](#)

7. 2-sidedPrintSetting

Select whether to perform two-sided copying.

■ [Two-Sided Copying](#)

8. Collate

Select whether to obtain sorted printouts when making multiple copies of a multi-paged original.

■ [Collated Copying](#)

9. **Frame erase copy**

When copying thick originals such as books, you can make a copy without black margins around the image and gutter shadows.

■ [Copying Thick Originals Such as Books](#)

Reducing or Enlarging a Copy

You can specify the magnification optionally or select the preset-ratio copying or fit-to-page copying.

The screen below is displayed when you tap **Settings** in the Copy standby screen and tap **Magnif.** to select the reduction/enlargement method.

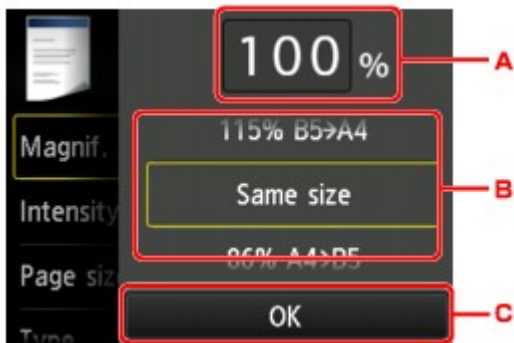

A. Tap to display the screen below.



1. Tap the numbers to specify the magnification.

2. Tap to confirm the magnification.

B. Flick to specify the magnification.

C. Tap to confirm the magnification.

Reduction/enlargement Method

▶▶▶ Note

- Some of the reduction/enlargement methods are not available depending on the copy menu.

- Fit to page

The machine automatically reduces or enlarges the image to fit the page size.



The setting in **Magnif.:** **Fit to page**

▶▶▶ Note

- When you select **Fit to page**, the page size may not be detected correctly depending on the original. In this case, select the setting other than **Fit to page**.

- Preset ratio

You can select one of the preset ratios to reduce or enlarge copies.

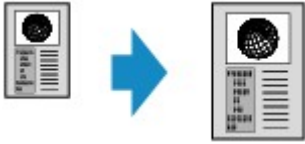

Select the appropriate ratio for size of original and page size.

The setting in **Magnif.:** 70% A4->A5/86% A4->B5/94% A4->LTR/115% B5->A4/141% A5->A4/156%
5x7->LTR/183% 4x6->LTR

▶▶ Note

- Some of the preset ratios are not available depending on the country or region of purchase.

• Ratio specified copy

You can specify the copy ratio as a percentage to reduce or enlarge copies.

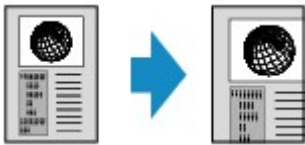

▶▶ Note

- **400% MAX** (maximum copy ratio) and **25% MIN** (minimum copy ratio) are selectable.
- If you make a copy at the same size as the original, select **Same size**.

Two-Sided Copying

When you select **2-sided** for **2-sidedPrintSetting** in **Copy**, you can copy two original pages onto the both sides of a single sheet of paper.

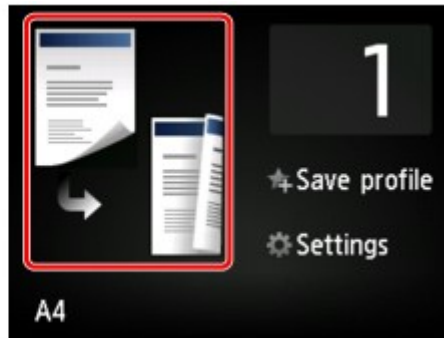

Select **2-sided**, then tap **OK**.

If you tap **Advanced** with **2-sided** selected, you can specify the orientation and the stapling side of the original.

- When you select **Orientation: Portrait** and **Output: Long side bind**:



- When you select **Orientation: Portrait** and **Output: Short side bind**:



- When you select **Orientation: Landscape** and **Output: Long side bind**:



- When you select **Orientation: Landscape** and **Output: Short side bind**:



After selecting the stapling side, you can select whether you use the preview screen. If you tap **ON**, the preview screen is displayed so that you can check the orientation.

▶▶▶ Note

- Two-sided copy setting can be used in combination with **2-on-1 copy** or **4-on-1 copy**.

■ [Copying Two Pages to Fit onto a Single Page](#)

■ [Copying Four Pages to Fit onto a Single Page](#)

- If you are copying in black & white, print intensity of the Two-sided copy may differ from that of a single-sided copy.

When Loading the Original on the platen glass:

- **Before scanning:**

When you select **2-sided** for **2-sidedPrintSetting** and the preview function is activated, the machine starts pre-scanning before scanning the original. When pre-scanning is finished, the screen below (preview screen) is displayed on the LCD.

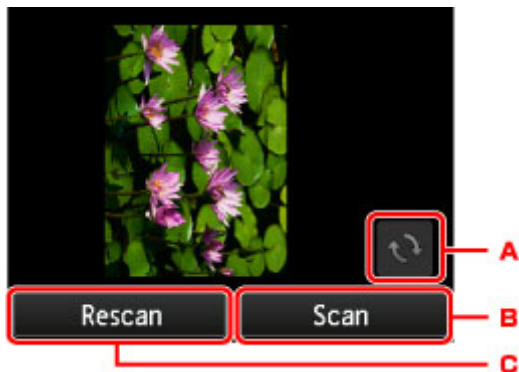

- A. Tap to rotate the original by 180 degrees.
- B. Tap to start scanning the original.
- C. Tap to rescan the original.

- **After scanning:**

The screen below appears after scanning each sheet of original.

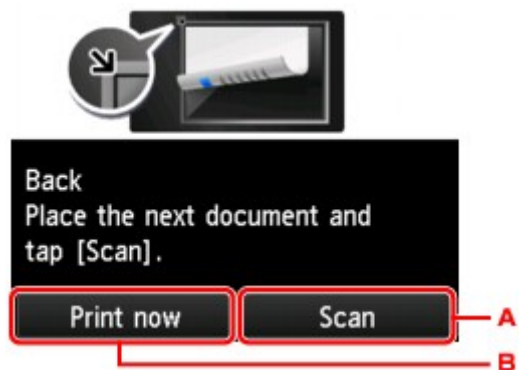

- A. Tap to start scanning the original.

Remove the sheet of original from the platen glass after scanning and load the next sheet on the platen glass, then tap **Scan**.

- B. Tap to start copying the original already scanned.

▶▶▶ Note

- You can add the copying job while printing.

■ [Adding the Copying Job \(Reserve copy\)](#)

About Special Copy Menu

- ▶ [Copying Thick Originals Such as Books](#)

Copying Thick Originals Such as Books

When **ON** is selected for **Frame erase copy** in **Copy**, you can make a copy without black margins around the image and gutter shadows in copying thick originals such as books. Using this function, you can reduce unnecessary ink consumption.



▶▶ Note

- When you use this function, load the original on the platen glass and close the document cover.
- When the Copy standby screen is displayed, tapping  allows you to preview an image of the printout on the preview screen.

■ [Displaying the Preview Screen](#)

- There may be a narrow black margin that appears around the image. This function removes the dark margins only. If a scanned book is too thin or when the machine is used near a window or in a bright environment, a faint black frame may remain. Also, if the color of an original is dark, the machine cannot distinguish the document color from the shadow and this may cause slight cropping or a shadow on the crease.

Copying Two Pages to Fit onto a Single Page

When you select **2-on-1 copy** for **Layout** in **Copy**, you can copy two original pages onto a single sheet of paper by reducing each image.

Tap **Settings** on the Copy standby screen to display the print settings screen, then select **2-on-1 copy** for **Layout**.

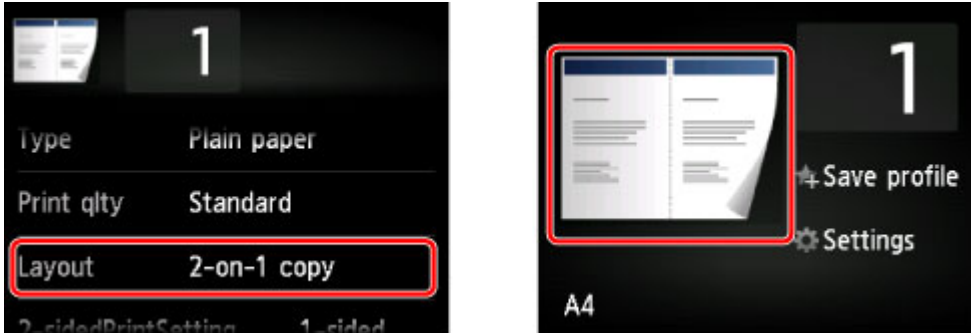

Select **2-on-1 copy**, then tap **OK**.

If you tap **Advanced** with **2-on-1 copy** selected, you can specify the orientation and the order of the original.

- When you select **Orientation: Portrait** and **Left to right**:



- When you select **Orientation: Portrait** and **Right to left**:



- When you select **Orientation: Landscape** and **Top to bottom**:



- When you select **Orientation: Landscape** and **Bottom to top**:



After selecting the order, you can select whether you use the preview screen. If you tap **ON**, the preview screen is displayed so that you can check the orientation.

▶▶▶ Note

- This function can be used in combination with Two-sided copy.

If you use this function in combination, you can copy four original pages on one sheet of paper. In this case, two original pages are copied on each side of paper.

If you use this function in combination, select **2-sided** for **2-sidedPrintSetting**, then select the orientation and the stapling side of print paper on the Print settings screen.

For details on two-sided copy function:

When Loading the Original on the platen glass:

• Before scanning:

When the preview function is activated, the machine starts pre-scanning before scanning the original. When pre-scanning is finished, the screen below (preview screen) is displayed on the LCD.

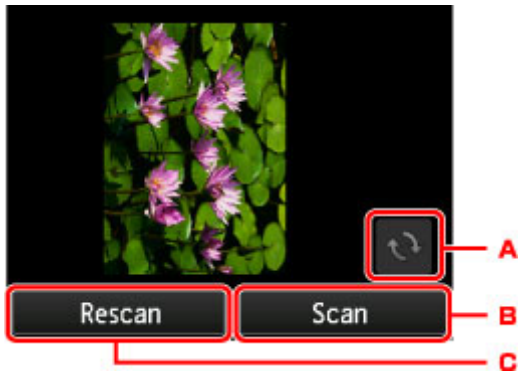

- A. Tap to rotate the original by 180 degrees.
- B. Tap to start scanning the original.
- C. Tap to rescan the original.

• After scanning:

The screen below appears after scanning each sheet of original.

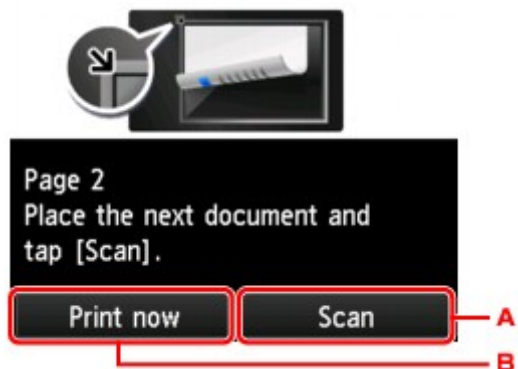

- A. Tap to start scanning the original.

Remove the sheet of original from the platen glass after scanning and load the next sheet on the platen glass, then tap **Scan**.

- B. Tap to start copying the original already scanned.

▶▶ Note

- You can add the copying job while printing.

■ [Adding the Copying Job \(Reserve copy\)](#)

- If you use this function in combination with Two-sided copy, the screen above is displayed after scanning the second sheet of original is complete. Follow the on-screen instructions to scan the third and fourth sheet of original.

Copying Four Pages to Fit onto a Single Page

When you select **4-on-1 copy** for **Layout** in **Copy**, you can copy four original pages onto a single sheet of paper by reducing each image. Four different layouts are available.

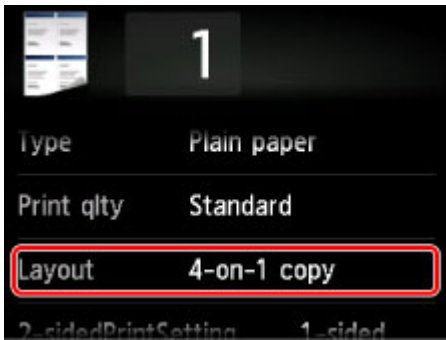

Select **4-on-1 copy**, then tap **OK**.

If you tap **Advanced** with **4-on-1 copy** selected, you can specify the orientation and the order of the original.

»» Note

- The order is the same regardless of the orientation.

- When you select **Upper-left to right**

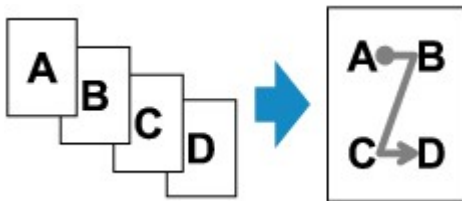

- When you select **Upper-right to left**

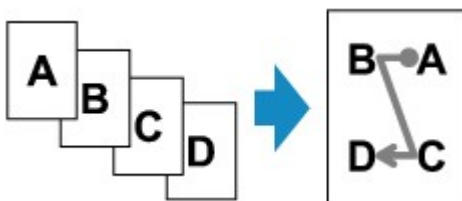

- When you select **Upper-left to bottom**

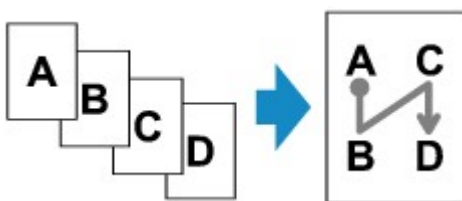

- When you select **Upper-right to bottom**

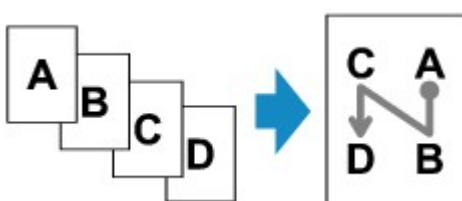

After selecting the order, you can select whether you use the preview screen. If you tap **ON**, the preview screen is displayed so that you can check the orientation.

▶▶▶ Note

- This function can be used in combination with Two-sided copy.

If you use this function in combination, you can copy eight original pages on one sheet of paper. In this case, four original pages are copied on each side of paper.

If you use this function in combination, select **2-sided** for **2-sidedPrintSetting**, then select the orientation and the stapling side of print paper on the Print settings screen.

For details on two-sided copy function:

■ [Two-Sided Copying](#)

When Loading the Original on the platen glass:

- **Before scanning:**

When the preview function is activated, the machine starts pre-scanning before scanning the original. When pre-scanning is finished, the screen below (preview screen) is displayed on the LCD.

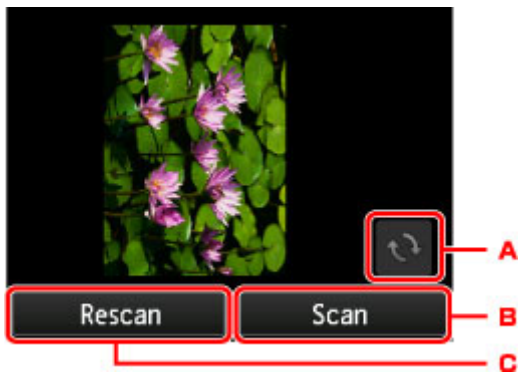

A. Tap to rotate the original by 180 degrees.

B. Tap to start scanning the original.

C. Tap to rescan the original.

- **After scanning:**

The screen below appears after scanning each sheet of original.

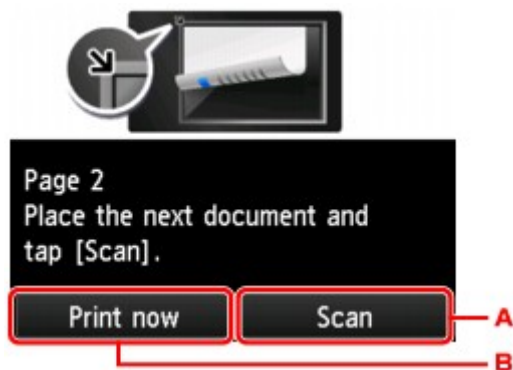

A. Tap to start scanning the original.

Remove the sheet of original from the platen glass after scanning and load the next sheet on the platen glass, then tap **Scan**.

B. Tap to start copying the original already scanned.

▶▶ Note

- You can add the copying job while printing.

■ [Adding the Copying Job \(Reserve copy\)](#)

- If you use this function in combination with Two-sided copy, the screen above is displayed after scanning the fourth sheet of original is complete. Follow the on-screen instructions to scan the rest of originals.

Collated Copying

You can obtain sorted printouts when making multiple copies of a multi-paged original.

When you select **ON** for **Collate** in **Copy**, you can obtain sorted printouts when making multiple copies of a multi-paged original. In addition, you can copy originals on both sides of paper.



- When **ON** is selected:

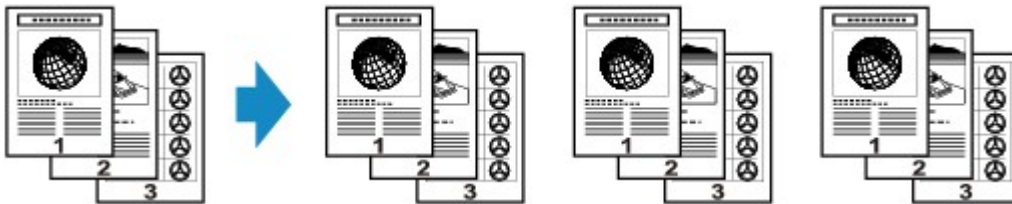

- When **OFF** is selected:



▶▶▶ Note

- When you use this function, load the original in the ADF.
- This function can be used in combination with Two-sided copy.
If you use this function in combination, select the two-sided copy setting for **2-sidedPrintSetting** and the stapling side of print paper on the Print settings screen.
For details on two-sided copy function:
[■Two-Sided Copying](#)
- The number of pages the machine can read varies with the document. If **Device memory is full**, **Cannot continue process** appears on the LCD when scanning, reduce the number of document pages to scan and try copying again.

Collated Copying in Combination with Two-Sided Copying

Collated copying is also available when two-sided copying is selected.



See [Two-Sided Copying](#) for two-sided copying.

Scanning



Scanning from a Computer



Scanning from the Operation Panel of the
Machine

Scanning from a Computer

- ▶ [Scanning with IJ Scan Utility](#)
- ▶ [Scanning with Scanner Driver](#)
- ▶ [Useful Information on Scanning](#)
- ▶ [Placing Items \(When Scanning from a Computer\)](#)

Scanning with IJ Scan Utility

- ▶ **What Is IJ Scan Utility (Scanner Software)?**
- ▶ **Starting IJ Scan Utility**
- ▶ **Scanning Documents** 📄 **Basic**
- ▶ **Scanning Photos**
- ▶ **Scanning with Favorite Settings**
- ▶ **Scanning Items Larger than the Platen (Image Stitch)**
- ▶ **Extracting Text from Scanned Images (OCR)**
- ▶ **Sending Scanned Images via E-mail**
- ▶ **Scanning Multiple Items at One Time**
- ▶ **Scanning Multiple Documents at One Time from the ADF (Auto Document Feeder)**
- ▶ **Saving after Checking Scan Results**
- ▶ **IJ Scan Utility Screens**

What Is IJ Scan Utility (Scanner Software)?

IJ Scan Utility is an application that allows you to easily scan documents, photos, etc.

You can complete from scanning to saving at one time by simply clicking the corresponding icon in the IJ Scan Utility main screen.

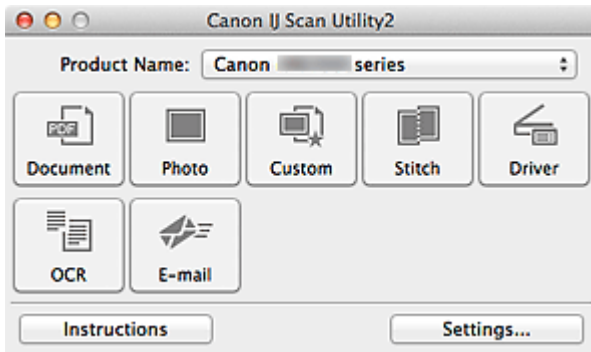

What You Can Do with IJ Scan Utility

Scan Easily according to Purposes

You can scan by simply clicking an icon such as **Document** to sharpen text in a document or magazine for better readability, or **Photo** to scan with settings suitable for photos, according to the item type or your purpose.

►►► Note

- Refer to "[IJ Scan Utility Main Screen](#)" for details on the IJ Scan Utility main screen.

Save Scanned Images Automatically

Scanned images are automatically saved in a preset folder. You can change the folder as required.

►►► Note

- The default save folder is the **Pictures** folder.
- Refer to "[Settings Dialog](#)" for how to specify a folder.

Integrate with Applications

You can utilize scanned images through integration with other applications; display scanned images in your favorite application, attach them to e-mails, extract text from images, and more.

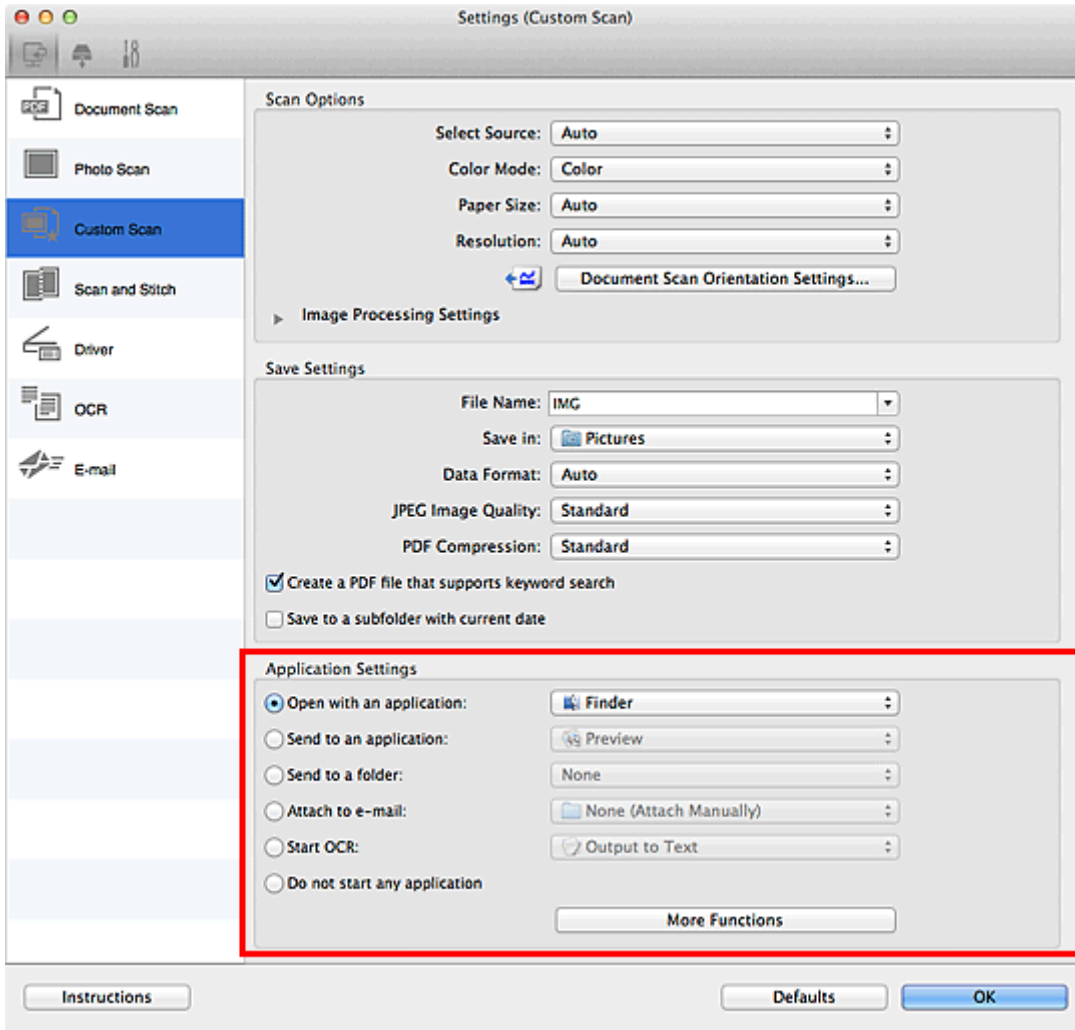

►►► Note

- Refer to "[Settings Dialog](#)" for how to set the applications to integrate with.

Starting IJ Scan Utility

▶▶▶ Note

- If you have more than one scanner or have changed the connection from USB connection to network connection, set up the network environment from IJ Scan Utility.

■ [Network Scan Settings](#)

From the **Go** menu of Finder, select **Applications**, then double-click the **Canon Utilities** folder, **IJ Scan Utility** folder, and then **Canon IJ Scan Utility2** icon to start IJ Scan Utility.

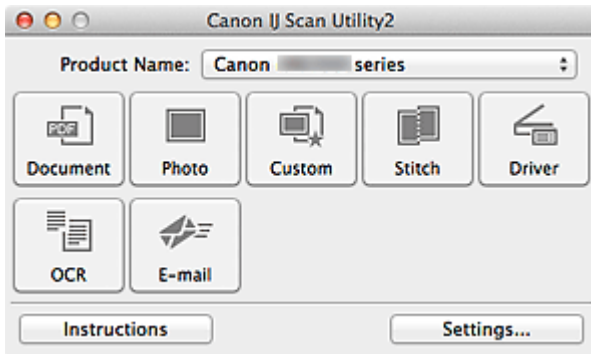

Scanning Documents

You can scan items placed on the platen with settings suitable for documents.

1. Place the item on the platen.

■ [Placing Items \(When Scanning from a Computer\)](#)

2. [Start IJ Scan Utility.](#)

3. Click **Settings...**, then set the paper size, resolution, etc. in the [Settings \(Document Scan\) dialog](#) as required.

When setting is completed, click **OK**.

4. Click **Document**.

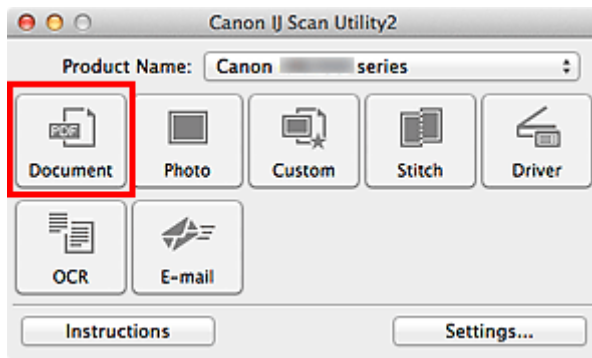

Scanning starts.

▶▶▶ Note

- Click **Cancel** to cancel the scan.
- Scanned images are saved in the folder set for **Save in** in the [Settings \(Document Scan\) dialog](#) displayed by clicking **Settings...**. In the **Settings (Document Scan)** dialog, you can also make advanced scan settings.

Scanning Photos

You can scan photos placed on the platen with settings suitable for photos.

1. Place the photo on the platen.

■ [Placing Items \(When Scanning from a Computer\)](#)

2. [Start IJ Scan Utility.](#)

3. Click **Settings...**, then set the paper size, resolution, etc. in the [Settings \(Photo Scan\) dialog](#) as required.

When setting is completed, click **OK**.

4. Click **Photo**.

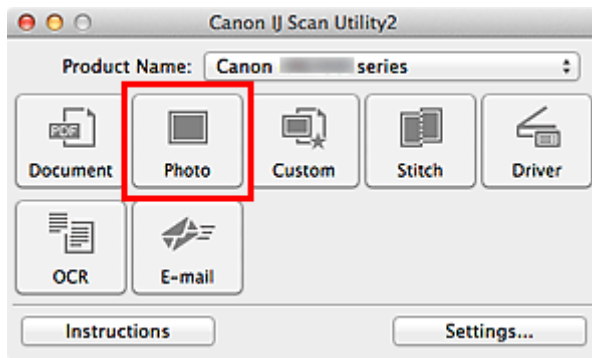

Scanning starts.

▶▶▶ Note

- Click **Cancel** to cancel the scan.
- Scanned images are saved in the folder set for **Save in** in the [Settings \(Photo Scan\) dialog](#) displayed by clicking **Settings...**. In the **Settings (Photo Scan)** dialog, you can also make advanced scan settings.

Scanning with Favorite Settings

You can scan items placed on the platen with your favorite settings saved beforehand.

This is convenient for saving frequently used settings or when specifying scan settings in detail.

1. [Start IJ Scan Utility](#).
2. Click **Settings...**, then set the item type, resolution, etc. in the [Settings \(Custom Scan\) dialog](#) as required.

When setting is completed, click **OK**.

▶▶▶ Note

- Once the settings are made, you can scan with the same settings from the next time.

3. Place the item on the platen.

■ [Placing Items \(When Scanning from a Computer\)](#)

4. Click **Custom**.

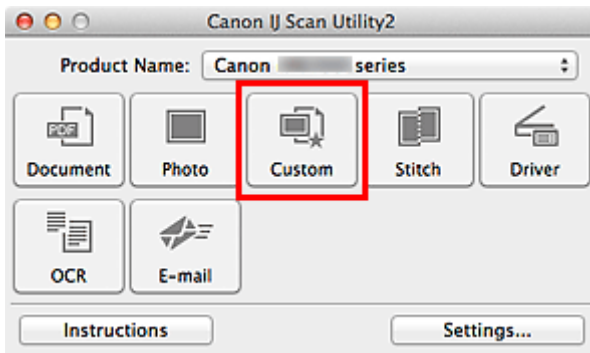

Scanning starts.

▶▶▶ Note

- Click **Cancel** to cancel the scan.
- Scanned images are saved in the folder set for **Save in** in the [Settings \(Custom Scan\) dialog](#) displayed by clicking **Settings...**. In the **Settings (Custom Scan)** dialog, you can also make advanced scan settings.

Scanning Items Larger than the Platen (Image Stitch)

You can scan the left and right halves of an item larger than the platen and combine them back into one image. Items up to approximately twice as large as the platen are supported.

▶▶▶ Note

- The following explains how to scan from the item to be placed on the left side.

1. [Start IJ Scan Utility](#).
2. Click **Settings...**, then set the item type, resolution, etc. in the [Settings \(Scan and Stitch\) dialog](#) as required.

When setting is completed, click **OK**.

3. Click **Stitch**.

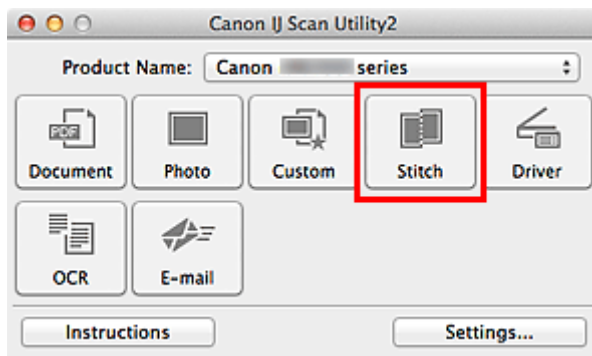

The **Image Stitch** window appears.

4. In **Select Output Size**, select an output size according to the paper size.

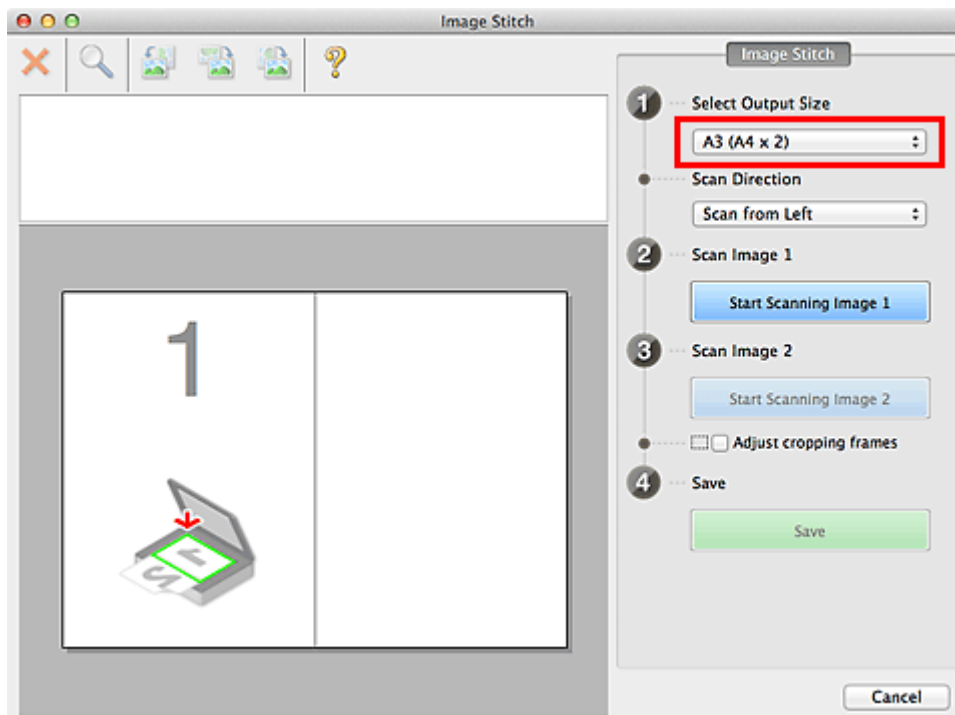

5. Make sure that **Scan from Left** is selected in **Scan Direction**.

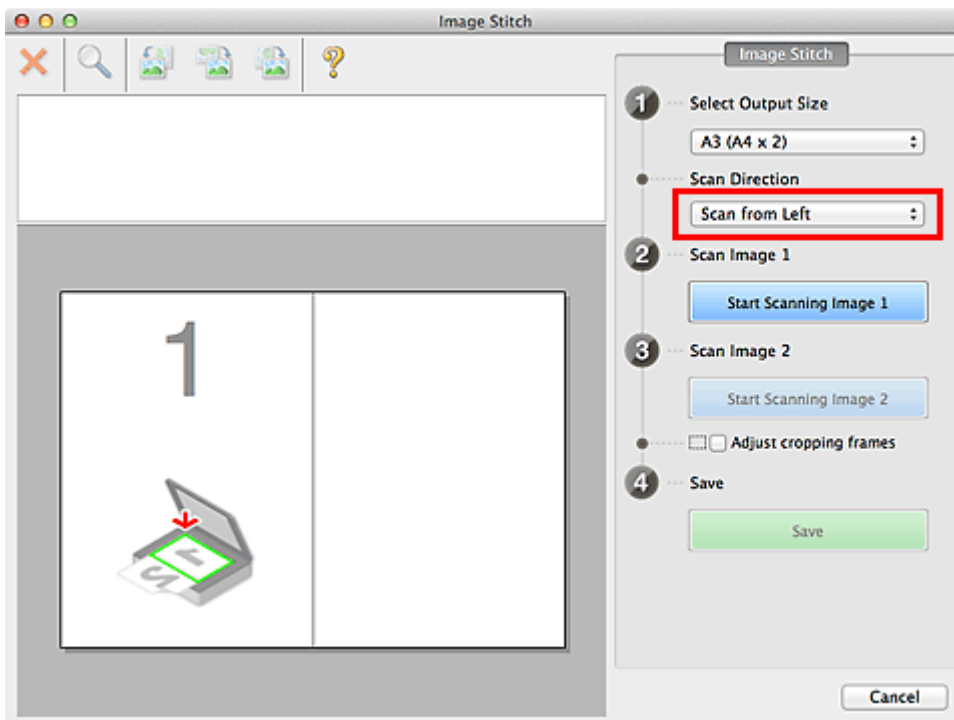

6. Place the item that is to be displayed on the left side of the screen face-down on the platen.

7. Click **Start Scanning Image 1**.

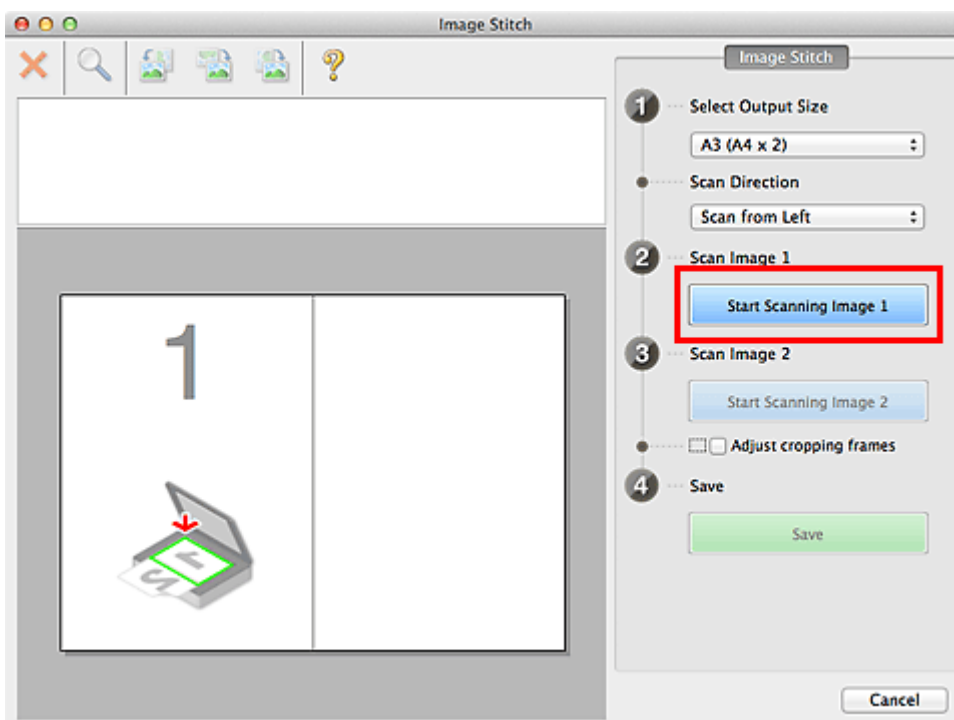

The first item is scanned and appears in 1.

▶▶▶ Note

- Click **Cancel** to cancel the scan.

8. Place the item that is to be displayed on the right side of the screen face-down on the platen.
9. Click **Start Scanning Image 2**.

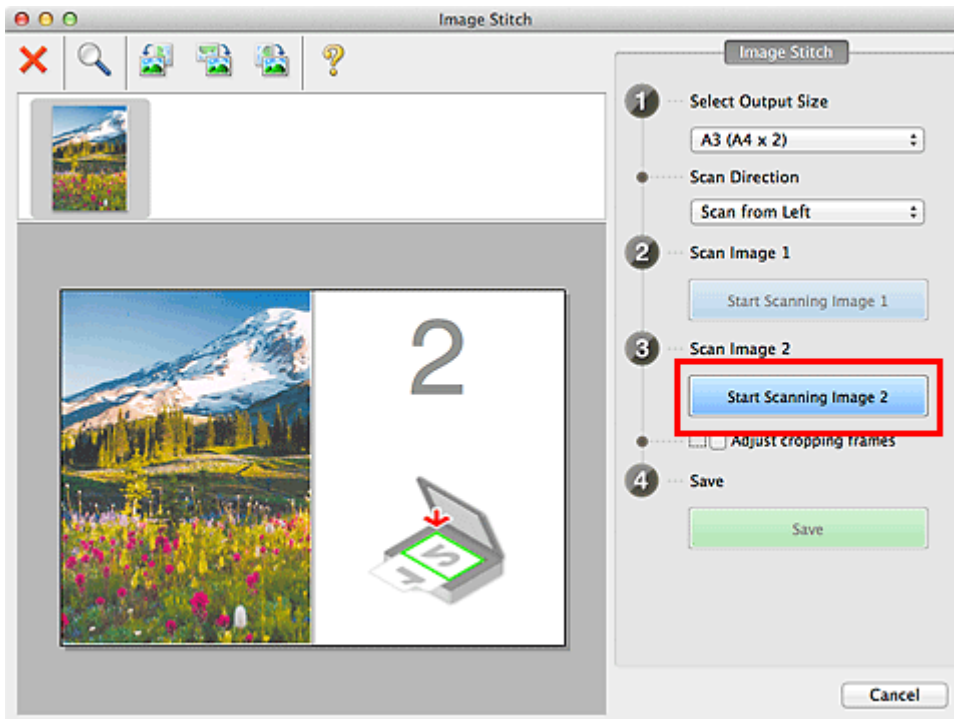

The second item is scanned and appears in 2.

Note

- Click **Cancel** to cancel the scan.

10. Adjust the scanned images as required.

Use the Toolbar to rotate or zoom in/out, or drag the images to adjust their positions.

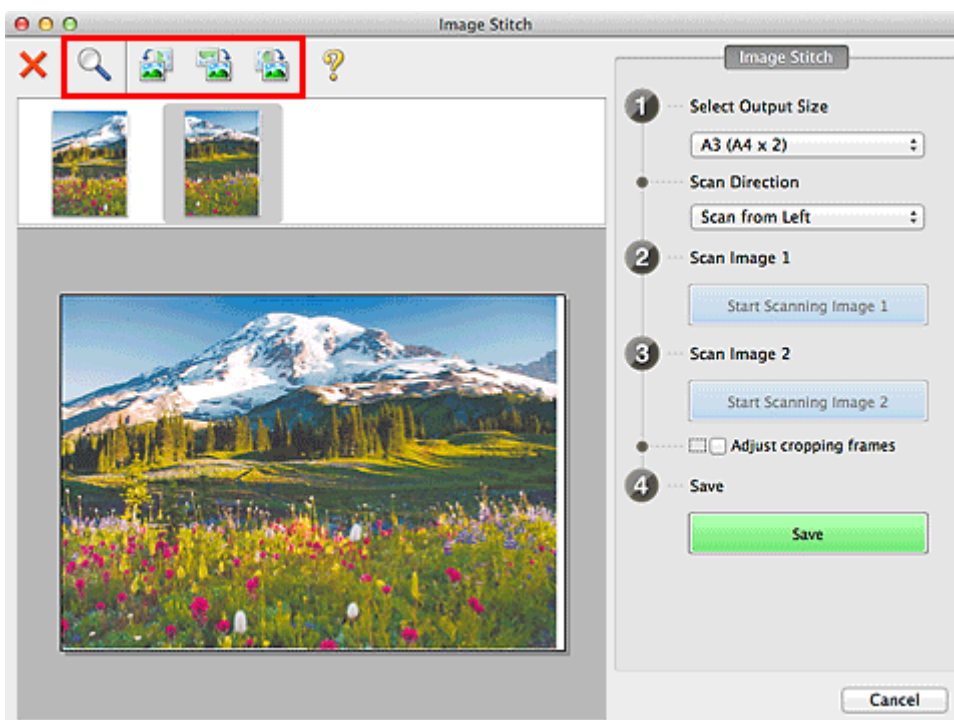

»» Note

- Select the **Adjust cropping frames** checkbox to specify the area to be saved.
 - [Adjusting Cropping Frames in the Image Stitch Window](#)
- To scan an item again, select the image in the Preview area or the thumbnail at the top of the screen, then click  (Delete). The selected image is deleted, allowing you to scan the item again.

11. Click **Save**.

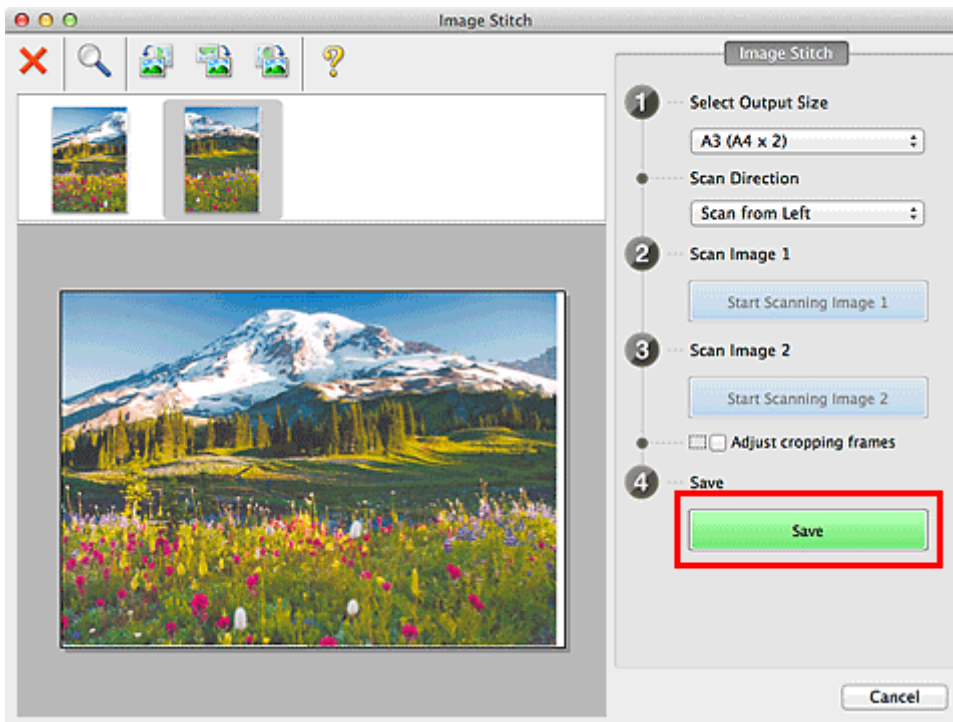

The combined image is saved.

»» Note

- Refer to "[Image Stitch Window](#)" for details on the **Image Stitch** window.
- You can make advanced scan settings in the [Settings \(Scan and Stitch\) dialog](#) displayed by clicking **Settings....**

Extracting Text from Scanned Images (OCR)

Click **OCR** in the IJ Scan Utility main screen to scan text in scanned magazines and newspapers and display it in a specified application.

▶▶▶ Note

- You can also extract text from **Document**, **Custom**, or **Driver**.

1. [Start IJ Scan Utility](#).
2. Click **Settings...**, then set the document type, resolution, etc. in the [Settings \(OCR\) dialog](#), and then select the application in which you want to display the result.

When setting is completed, click **OK**.

▶▶▶ Note

- For **Resolution**, only **300 dpi** or **400 dpi** can be set.
- If a compatible application is not installed, the text in the image is extracted and appears in your text editor.
Text to be displayed is based on **Document Language** in the [Settings \(General Settings\) dialog](#). Select the language you want to extract in **Document Language** and scan.
- You can add the application from the pop-up menu.

3. Click **OCR**.

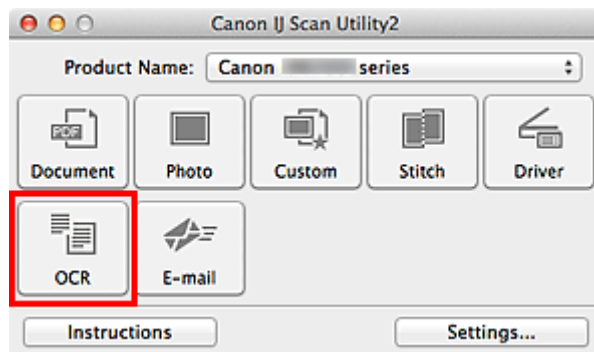

Scanning starts.

When scanning is completed, the scanned images are saved according to the settings, and the extracted text appears in the specified application.

▶▶▶ Note

- Click **Cancel** to cancel the scan.
- Text displayed in your text editor is for guidance only. Text in the image of the following types of documents may not be detected correctly.
 - Documents containing text with font size outside the range of 8 points to 40 points (at 300 dpi)
 - Slanted documents
 - Documents placed upside down or documents with text in the wrong orientation (rotated characters)
 - Documents containing special fonts, effects, italics, or hand-written text
 - Documents with narrow line spacing
 - Documents with colors in the background of text

- Documents containing multiple languages
-

Sending Scanned Images via E-mail

You can send scanned images via e-mail easily by simply clicking **E-mail** in the IJ Scan Utility main screen.

▶▶▶ Note

- You can also send scanned images via e-mail from **Document**, **Photo**, **Custom**, or **Driver**.

1. [Start IJ Scan Utility](#).

2. Click **Settings...**, then set the item type, resolution, etc. in the [Settings \(E-mail\) dialog](#), and then select an e-mail client.

When setting is completed, click **OK**.

3. Place the item on the platen.

■ [Placing Items \(When Scanning from a Computer\)](#)

4. Click **E-mail**.

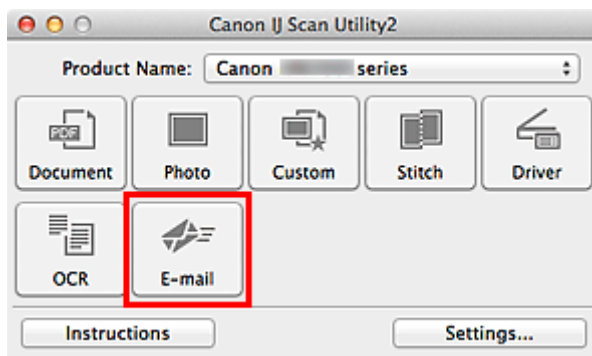

Scanning starts.

When scanning is completed, the specified e-mail client starts and the images will be attached to a new message.

▶▶▶ Note

- Click **Cancel** to cancel the scan.
- The scanned images are saved according to the settings made in the Settings dialog.
- When the **Check scan results** checkbox is selected in the Settings dialog, the [Save Settings dialog](#) appears. After you set the save options and click **OK**, the scanned images are saved and automatically attached to a new message of the specified e-mail client.

5. Specify the recipient, enter the subject and message, then send e-mail.

Refer to the manual of your e-mail client for e-mail settings.

Scanning Multiple Items at One Time

You can scan two or more photos (small items) placed on the platen at one time and save each image individually.

▶▶▶ Important

- The following types of items may not be scanned correctly. In that case, adjust the cropping frames (selection boxes; scan areas) in the screen displayed by clicking **Driver** in the IJ Scan Utility main screen and scan again.
 - Photos that have a whitish background
 - Items printed on white paper, hand-written documents, business cards, etc.
 - Thin items
 - Thick items

▶▶▶ Note

- The screens for scanning with favorite settings are used as examples in the following descriptions.

1. Place the items on the platen.

■ [Placing Items \(When Scanning from a Computer\)](#)

2. [Start IJ Scan Utility.](#)

3. Click **Settings....**

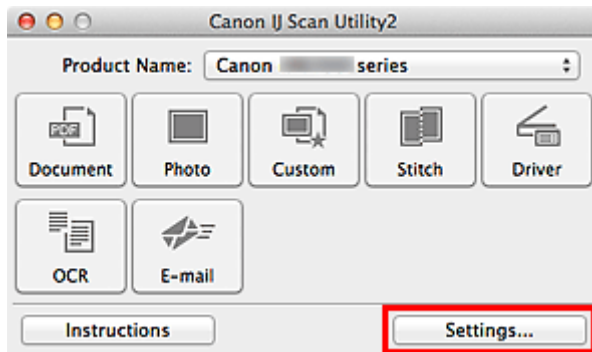

The Settings dialog appears.

4. Click **Custom Scan.**

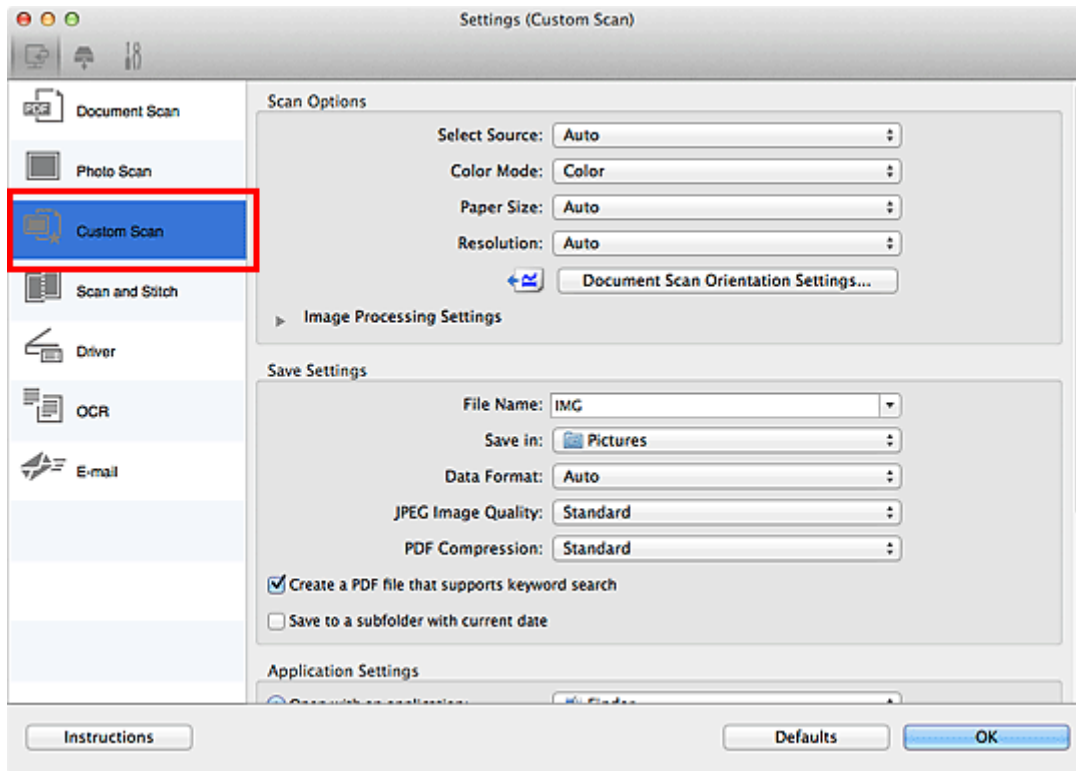

5. Select **Select Source** according to the items to be scanned.

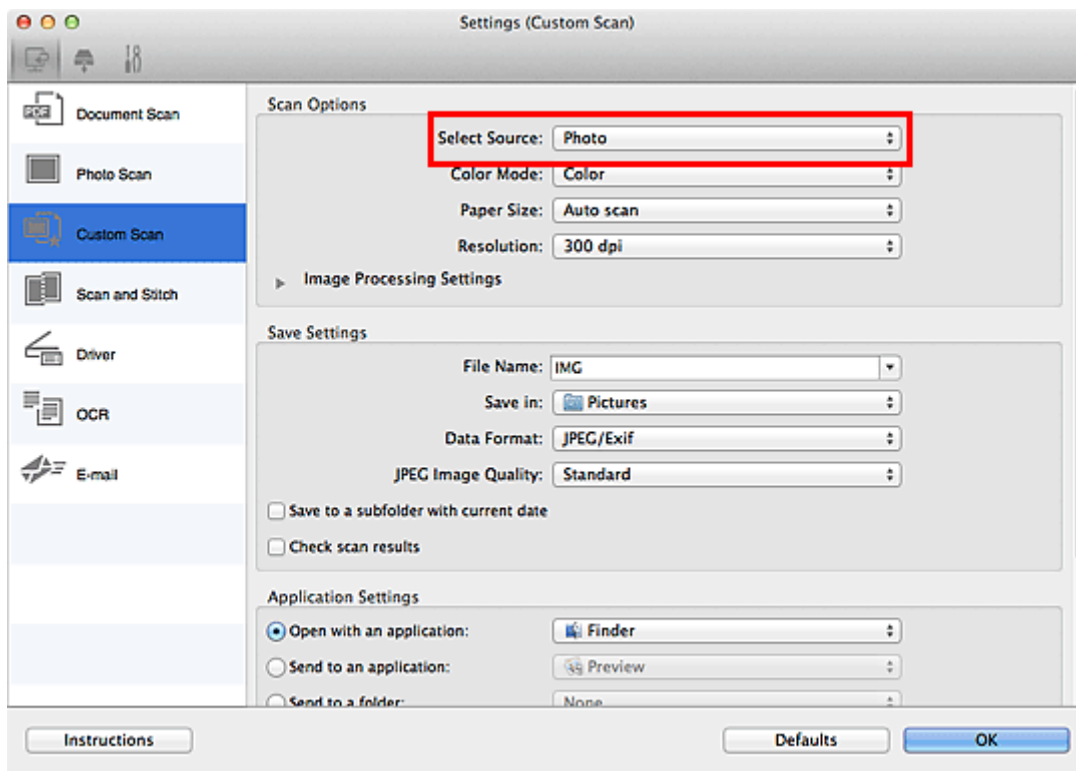

6. Select **Auto scan** for **Paper Size**, then click **OK**.

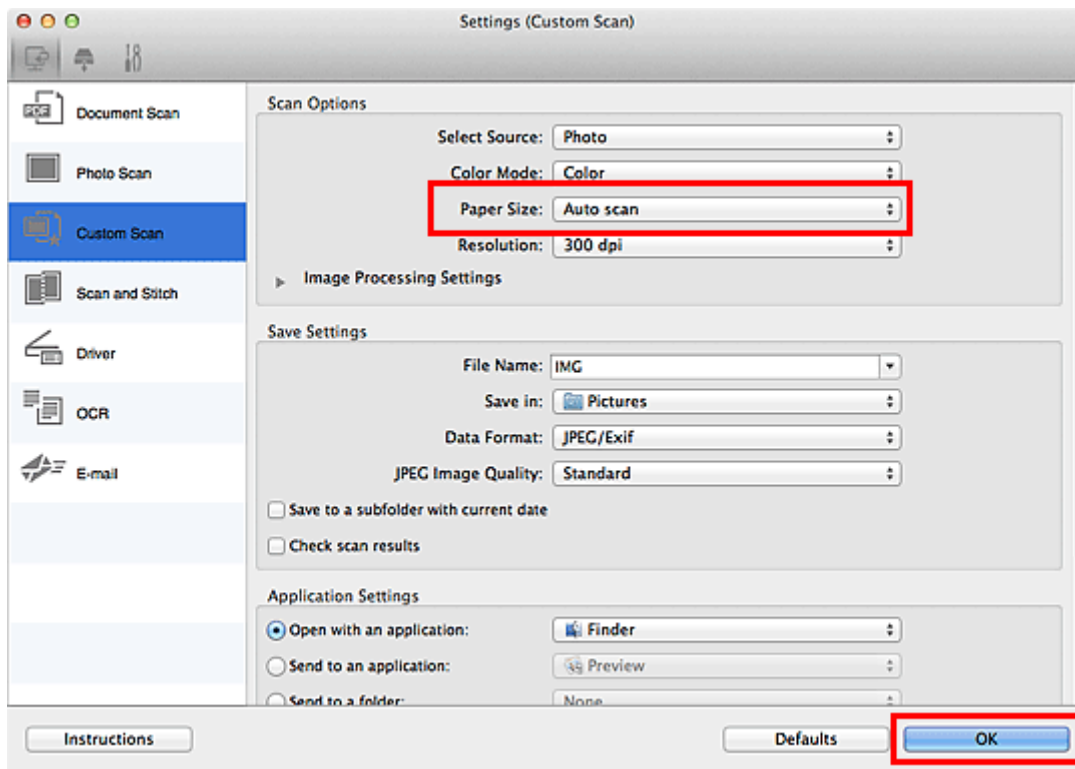

The IJ Scan Utility main screen appears.

▶▶▶ Note

- Refer to the following pages for details on the setting items in the Settings dialog.

- [Settings \(Document Scan\) Dialog](#)
- [Settings \(Photo Scan\) Dialog](#)
- [Settings \(Custom Scan\) Dialog](#)
- [Settings \(OCR\) Dialog](#)
- [Settings \(E-mail\) Dialog](#)

7. Click **Custom**.

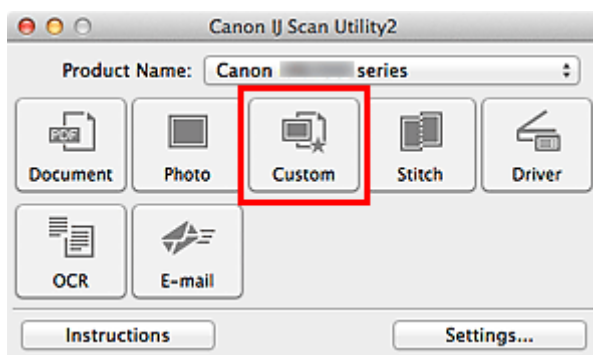

Multiple items are scanned at one time.

▶▶▶ Note

- Click **Cancel** to cancel the scan.
- Scanned images are saved in the folder set for **Save in** in the corresponding Settings dialog displayed by clicking **Settings...**. In each Settings dialog, you can also make advanced scan settings.

Scanning Multiple Documents at One Time from the ADF (Auto Document Feeder)

Place multiple documents on the ADF (Auto Document Feeder) and scan at one time.

▶▶▶ Note

- You can scan multiple documents at one time from the ADF when scanning via **Document**, **Custom**, **Driver**, **OCR**, or **E-mail**.
Refer to "[Scanning with Scanner Driver](#)" for how to scan using the scanner driver.
- The screens for scanning documents are used as examples in the following descriptions.

1. Place the documents on the ADF.

■ [Placing Documents \(ADF \(Auto Document Feeder\)\)](#)

2. [Start IJ Scan Utility](#).

3. Click **Settings....**

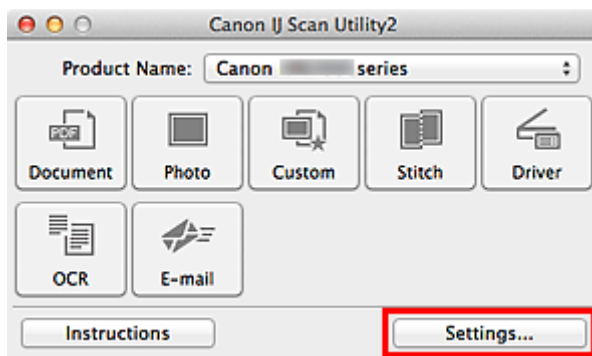

The Settings dialog appears.

4. Click **Document Scan**.

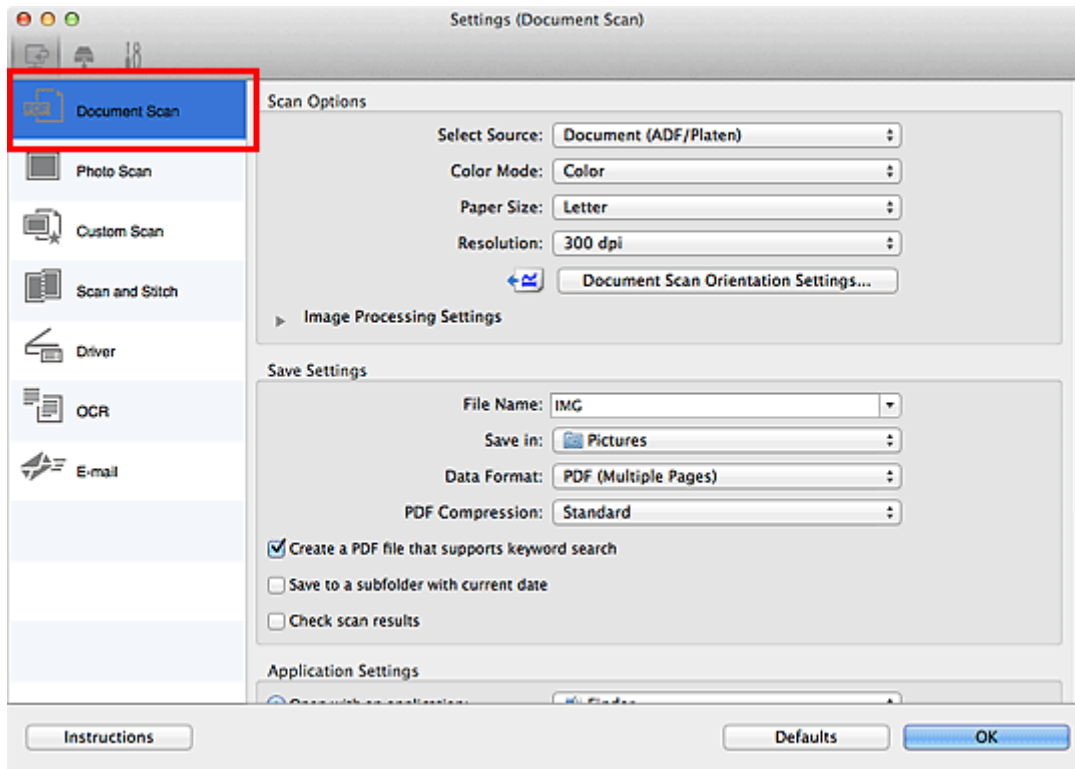

5. Select **Select Source** according to the documents to be scanned.

To scan only the front side of each document, select **Document (ADF/Platen)** or **Document (ADF Simplex)**.

To scan the front side then the back side of each document, select **Document (ADF Manual Duplex)**.

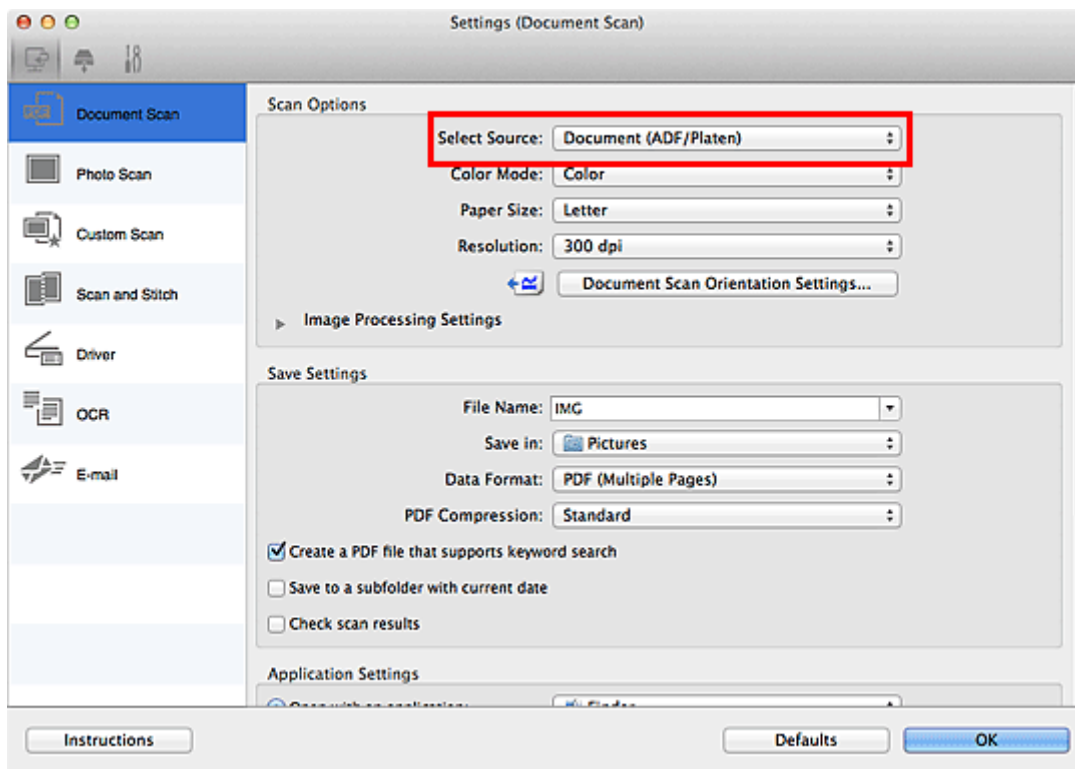

6. Set the color mode, document size, and scanning resolution as required.

Click **Document Scan Orientation Settings...** to specify the orientation of the documents to be scanned. In the displayed dialog, you can specify the **Orientation** and **Binding Side**. How to place the documents when scanning the back sides depends on the **Binding Side**.

When setting is completed, click **OK**.

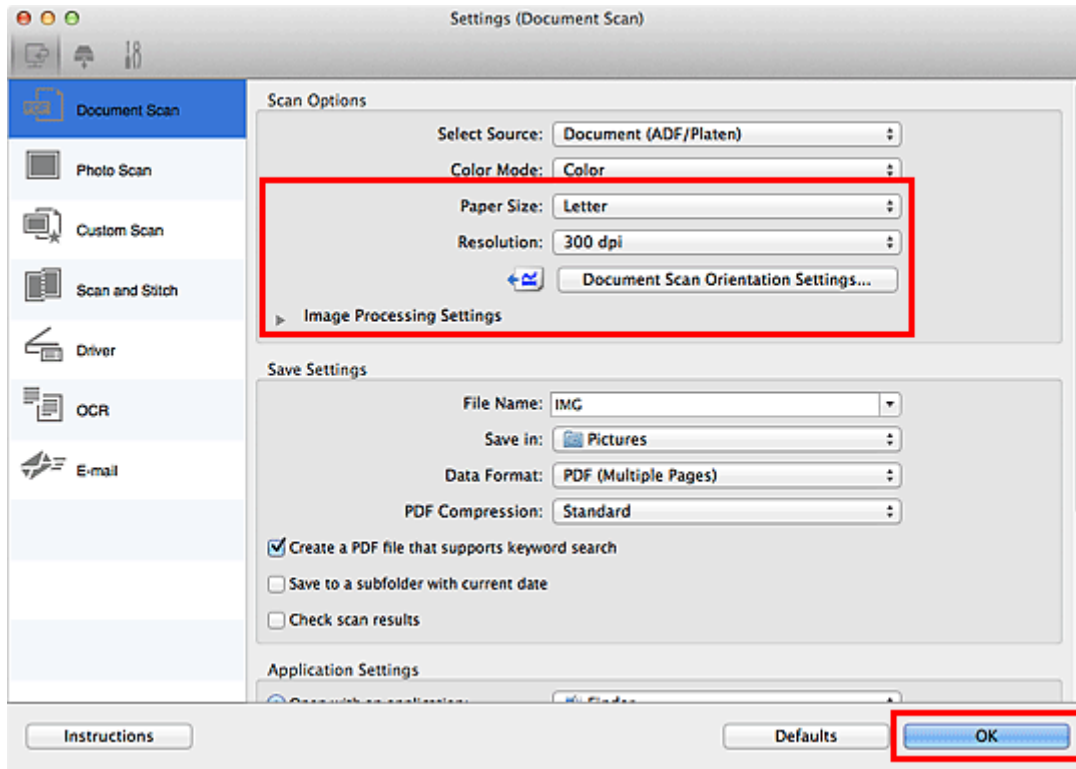

The IJ Scan Utility main screen appears.

▶▶▶ Note

- Refer to the following pages for details on the setting items in the Settings dialog.

- [Settings \(Document Scan\) Dialog](#)
- [Settings \(Custom Scan\) Dialog](#)
- [Settings \(OCR\) Dialog](#)
- [Settings \(E-mail\) Dialog](#)

7. Click **Document**.

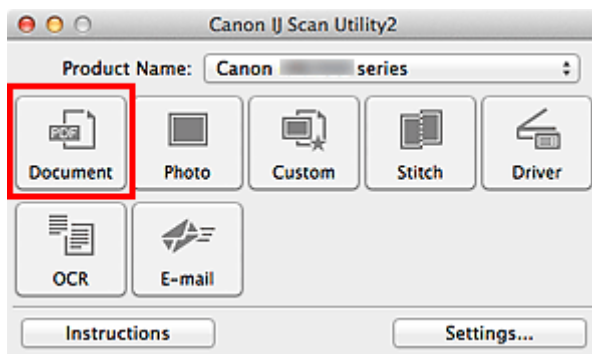

Scanning starts.

▶▶▶ Note

- Click **Cancel** to cancel the scan.

When **Document (ADF Manual Duplex)** is selected for **Select Source**, proceed to Step 8.

8. Follow the on-screen instructions to place the documents.

►► Note

- The screens for scanning with **Orientation** set to **Portrait** are used as examples in the following descriptions.

When Long edge is Selected for Binding Side in Document Scan Orientation Settings...:

Place the documents after rotating the output documents 180 degrees.

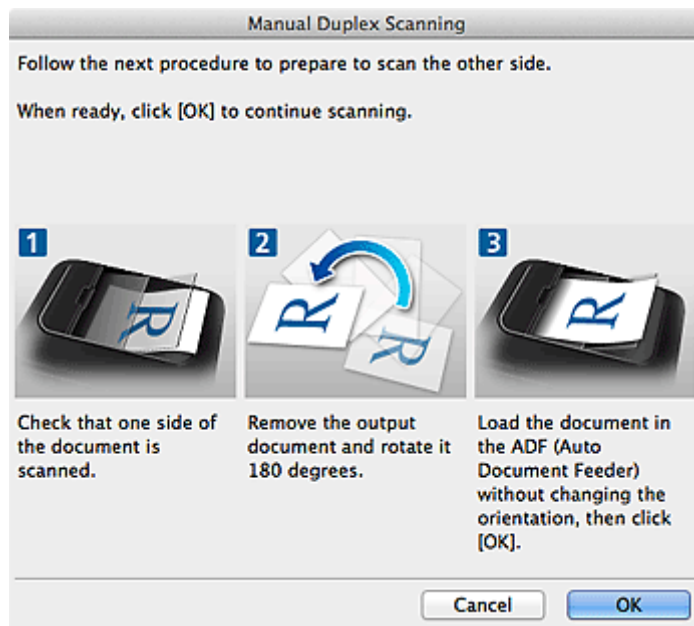

When Short edge is Selected for Binding Side in Document Scan Orientation Settings...:

Place the documents without changing the orientation of the output documents.

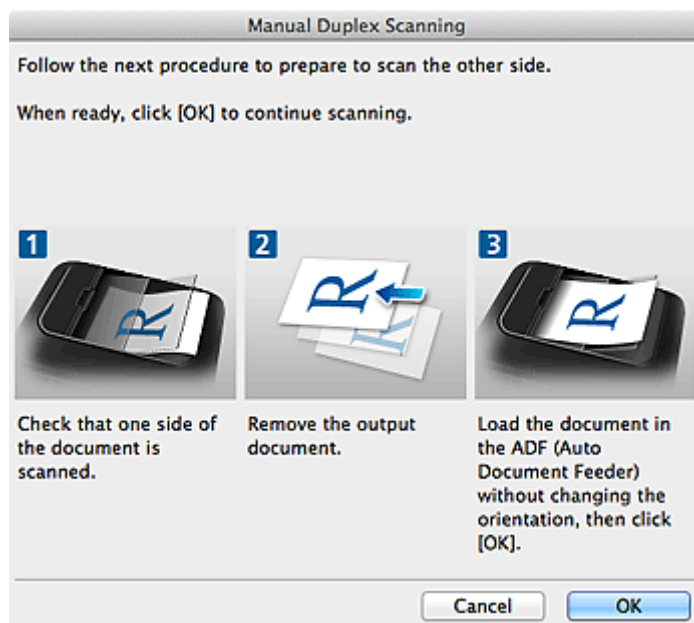

9. Click **OK**.

Scanning starts.

»» Note

- Click **Cancel** to cancel the scan.
- Scanned images are saved in the folder set for **Save in** in the corresponding Settings dialog displayed by clicking **Settings...** In each Settings dialog, you can also make advanced scan settings.

Saving after Checking Scan Results

You can check the scan results, then save the images to a computer.

Important

- You cannot check the scan results before saving when scanned using the operation panel.

Note

- The screens for scanning photos are used as examples in the following descriptions.

1. [Start IJ Scan Utility](#).

2. Click **Settings...**

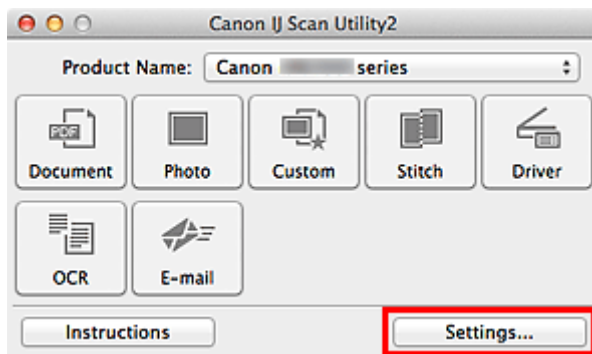

The [Settings dialog](#) appears.

3. Click **Photo Scan**.

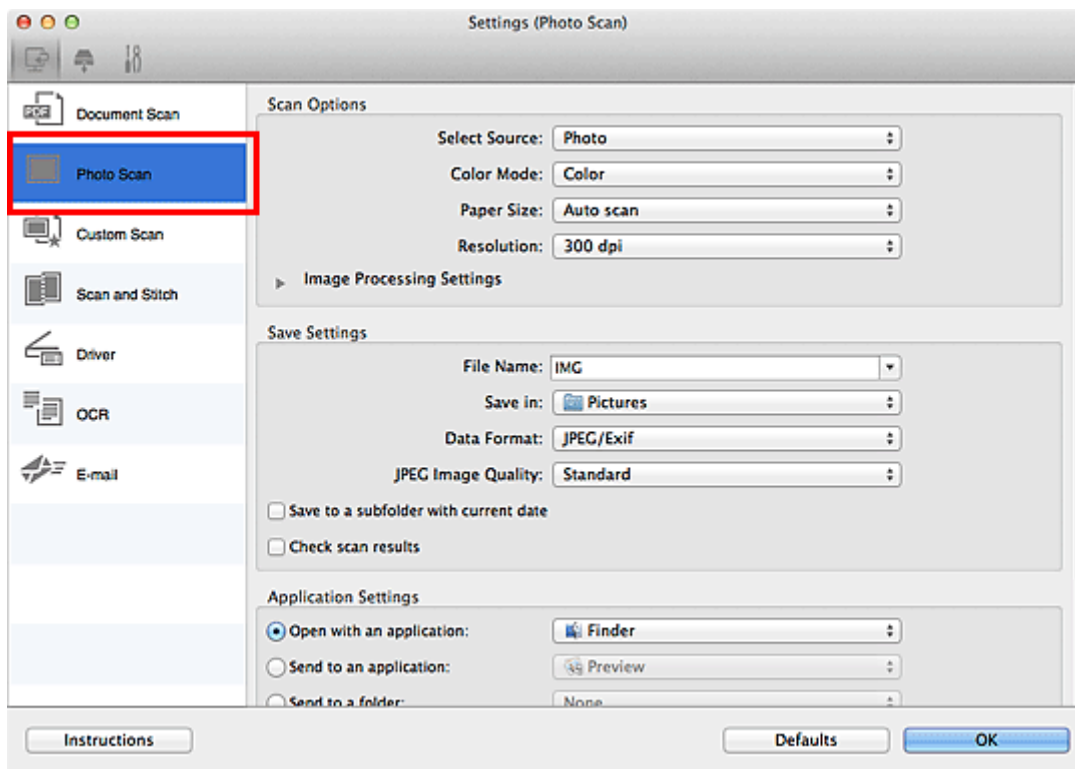

4. Select the **Check scan results** checkbox, then click **OK**.

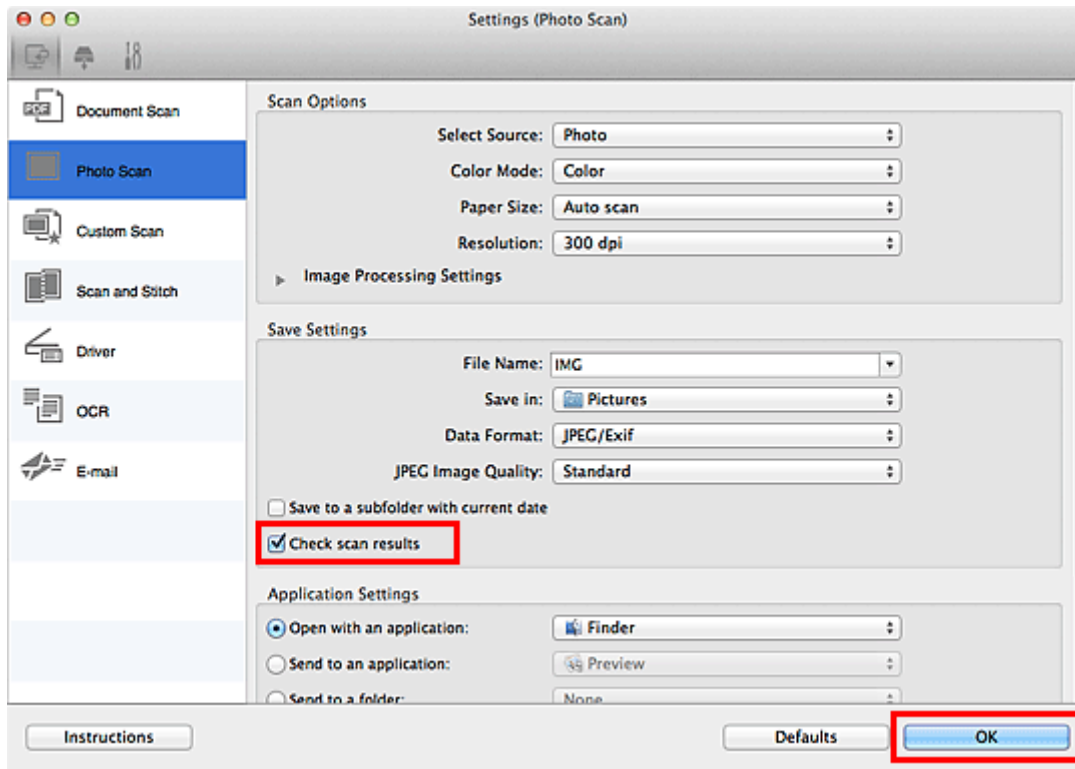

The IJ Scan Utility main screen appears.

▶▶▶ Note

- Refer to the following pages for details on the setting items in the Settings dialog.

- [Settings \(Document Scan\) Dialog](#)
- [Settings \(Photo Scan\) Dialog](#)
- [Settings \(Custom Scan\) Dialog](#)
- [Settings \(Scan and Stitch\) Dialog](#)
- [Settings \(Driver\) Dialog](#)
- [Settings \(OCR\) Dialog](#)
- [Settings \(E-mail\) Dialog](#)

5. Click **Photo**.

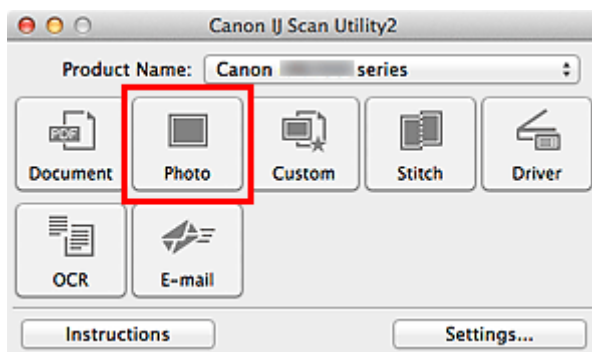

Scanning starts.

When scanning is completed, the **Save Settings** dialog appears.

▶▶▶ Note

- Click **Cancel** to cancel the scan.

6. Change the image order or file save options as required.

You can change the image order or file save options in the [Save Settings dialog](#).

▶▶ Note

- The default save folder is the **Pictures** folder.

7. Click **OK**.

Scanned images are saved according to the settings.

IJ Scan Utility Screens

- ▶ **IJ Scan Utility Main Screen**
- ▶ **Settings Dialog**
 - **Settings (Document Scan) Dialog**
 - **Settings (Photo Scan) Dialog**
 - **Settings (Custom Scan) Dialog**
 - **Settings (Scan and Stitch) Dialog**
 - **Settings (Driver) Dialog**
 - **Settings (OCR) Dialog**
 - **Settings (E-mail) Dialog**
 - **Settings (Save to PC (Photo)) Dialog**
 - **Settings (Save to PC (Document)) Dialog**
 - **Settings (Attach to E-mail (Photo)) Dialog**
 - **Settings (Attach to E-mail (Document)) Dialog**
 - **Settings (General Settings) Dialog**
- ▶ **Network Selection Screen**
- ▶ **Save Settings Dialog**
- ▶ **Image Stitch Window**

IJ Scan Utility Main Screen

From the **Go** menu of Finder, select **Applications**, then double-click the **Canon Utilities** folder, **IJ Scan Utility** folder, and then **Canon IJ Scan Utility2** icon to start IJ Scan Utility.

You can complete from scanning to saving at one time by simply clicking the corresponding icon.

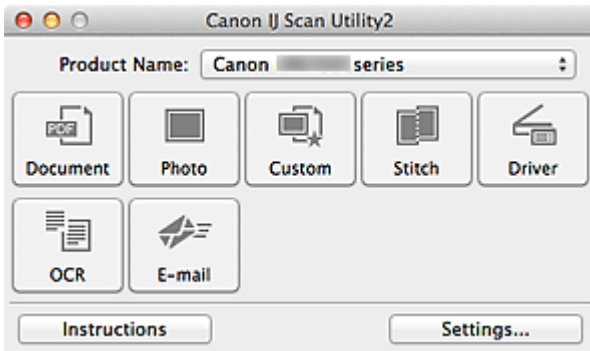

Product Name

Displays the name of the product that IJ Scan Utility is currently set to use.

If the displayed product is not the one you want to use, select the desired product from the list.

In addition, for network connection, select one with "Network" after the product name.

►► Note

- Refer to "[Network Scan Settings](#)" for how to set up a network environment.

Document

Scans items as documents and saves them to a computer.

Scan/save settings and the response after scanning can be specified in the [Settings \(Document Scan\) dialog](#).

Photo

Scans items as photos and saves them to a computer.

Scan/save settings and the response after scanning can be specified in the [Settings \(Photo Scan\) dialog](#).

Custom

Scans items with your favorite settings and saves the images to a computer. The item type can be automatically detected.

Scan/save settings and the response after scanning can be specified in the [Settings \(Custom Scan\) dialog](#).

Stitch

Displays the **Image Stitch** window in which you can scan the left and right halves of an item larger than the platen and combine the scanned images back into one image.

Scan/save settings and the response after scanning can be specified in the [Settings \(Scan and Stitch\) dialog](#).

Driver

Allows you to make image corrections and color adjustments when scanning.

Scan/save settings and the response after scanning can be specified in the [Settings \(Driver\) dialog](#).

OCR

Scan text in scanned magazines and newspapers and display it in a specified application.

Scan/save settings and applications can be specified in the [Settings \(OCR\) dialog](#).

E-mail

You can send scanned images via e-mail.

Scan/save settings and applications can be specified in the [Settings \(E-mail\) dialog](#).



Instructions

Opens this guide.

Settings...

Displays the [Settings dialog](#) in which you can specify the scan/save settings and the response after scanning.

Settings Dialog

There are three tabs in the Settings dialog:  (Scanning from a Computer),  (Scanning from the Operation Panel), and  (General Settings). When you click a tab, the view in the red frame switches and you can make advanced settings to functions on each tab.

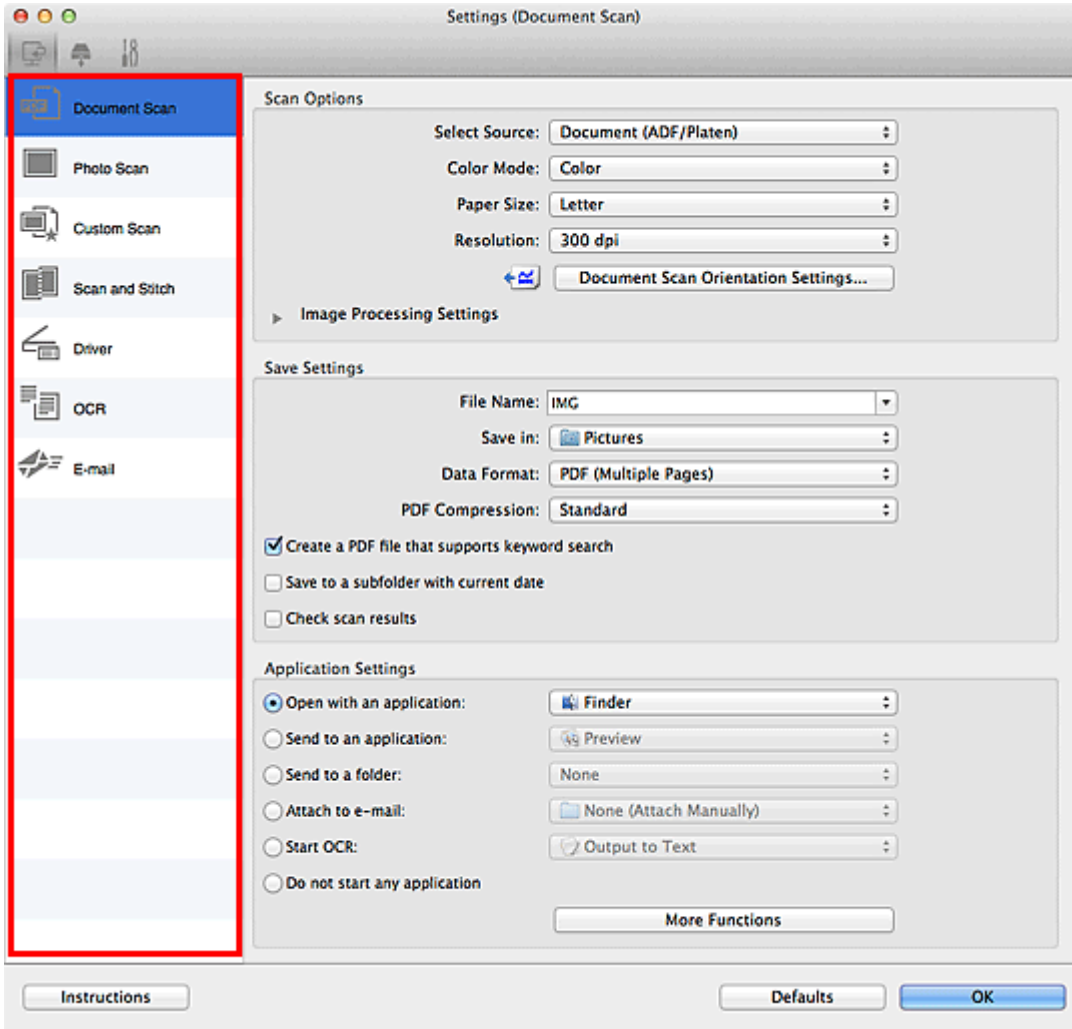

(Scanning from a Computer) Tab

You can specify how to respond when scanning from IJ Scan Utility.

- [Settings \(Document Scan\) Dialog](#)
- [Settings \(Photo Scan\) Dialog](#)
- [Settings \(Custom Scan\) Dialog](#)
- [Settings \(Scan and Stitch\) Dialog](#)
- [Settings \(Driver\) Dialog](#)
- [Settings \(OCR\) Dialog](#)
- [Settings \(E-mail\) Dialog](#)

(Scanning from the Operation Panel) Tab

You can specify how to respond when scanning from the operation panel.

- [Settings \(Save to PC \(Photo\)\) Dialog](#)
- [Settings \(Save to PC \(Document\)\) Dialog](#)
- [Settings \(Attach to E-mail \(Photo\)\) Dialog](#)
- [Settings \(Attach to E-mail \(Document\)\) Dialog](#)



(General Settings) Tab

You can set the product to use, file size restriction on e-mail attachment, language to detect text in images, and folder in which to save images temporarily.

- [Settings \(General Settings\) Dialog](#)

Settings (Document Scan) Dialog

Click **Document Scan** on the  (Scanning from a Computer) tab to display the **Settings (Document Scan)** dialog.

In the **Settings (Document Scan)** dialog, you can make advanced scan settings to scan items as documents.

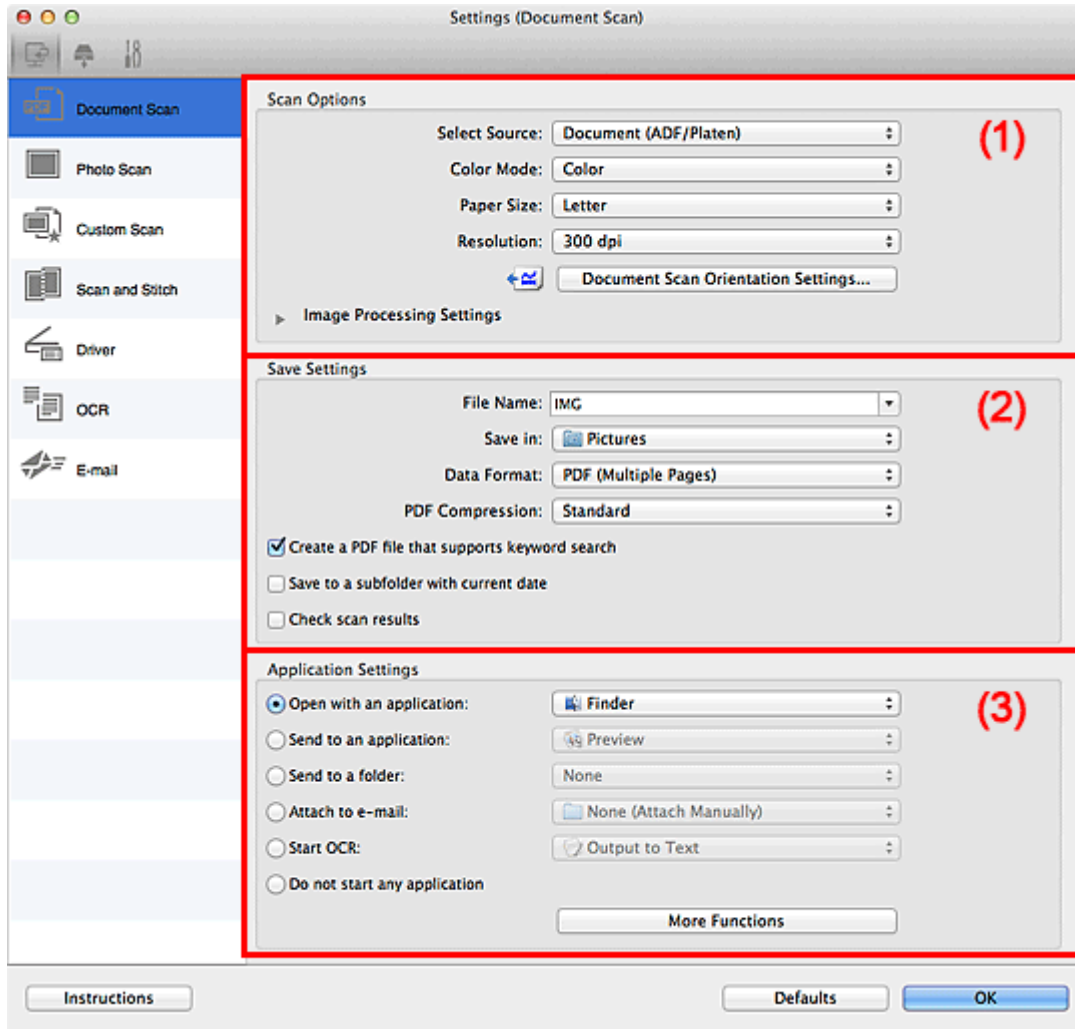

- [\(1\) Scan Options Area](#)
- [\(2\) Save Settings Area](#)
- [\(3\) Application Settings Area](#)

(1) Scan Options Area

Select Source

Select the type of item to be scanned.

- Scanning documents: **Document** or **Document (ADF/Platen)**
- Scanning magazines: **Magazine**
- Scanning documents from the ADF (Auto Document Feeder): **Document (ADF Simplex)**, **Document (ADF Manual Duplex)**, or **Document (ADF/Platen)**

»»» Note

- When **Document (ADF/Platen)** is selected and documents are placed both on the platen and ADF, those placed on the ADF will be scanned.

Color Mode

Select the color mode in which to scan the item.

Paper Size

Select the size of the item to be scanned.

When you select **Custom**, a screen in which you can specify the paper size appears. Select a **Unit**, then enter the **Width** and **Height**, and then click **OK**.

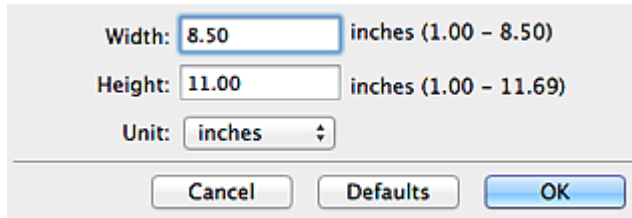

A dialog box for setting paper size. It contains three input fields: 'Width' with the value '8.50' and a range '(1.00 - 8.50) inches', 'Height' with the value '11.00' and a range '(1.00 - 11.69) inches', and 'Unit' with a dropdown menu set to 'inches'. At the bottom are three buttons: 'Cancel', 'Defaults', and 'OK'.

»»» Note

- Click **Defaults** to restore the specified settings to the default settings.

Resolution

Select the resolution of the item to be scanned.

The higher the resolution (value), the more detail in your image.

■ [Resolution](#)

»»» Note

- Only **300 dpi** or **400 dpi** can be set when **Start OCR** is selected in **Application Settings**.

Document Scan Orientation Settings...

This appears when you select ADF for **Select Source**.

Click to display the **Document Scan Orientation Settings** dialog in which you can set the orientation and binding side of the documents to be scanned from the ADF.

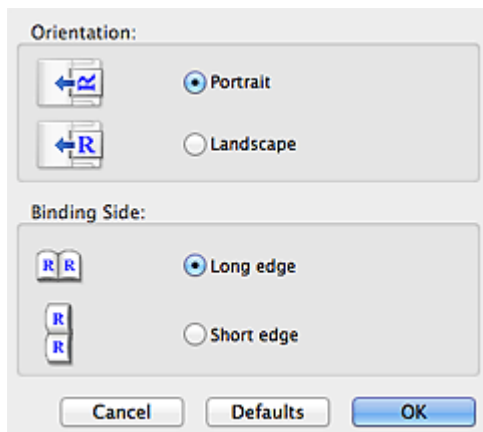

A dialog box for setting document scan orientation. It has two sections: 'Orientation' and 'Binding Side'. 'Orientation' has two radio buttons: 'Portrait' (selected) and 'Landscape'. 'Binding Side' has two radio buttons: 'Long edge' (selected) and 'Short edge'. At the bottom are three buttons: 'Cancel', 'Defaults', and 'OK'.

»»» Important

- **Binding Side** cannot be specified when scanning only the front side of each document.

Image Processing Settings

Click  (Right Arrow) to set the following.

▶▶▶ Note

- The displayed items vary by **Select Source** and **Color Mode**.

Apply Auto Document Fix

Select this checkbox to sharpen text in a document or magazine for better readability.

▶▶▶ Important

- The color tone may differ from the source image due to corrections. In that case, deselect the checkbox and scan.

▶▶▶ Note

- Scanning takes longer than usual when you enable this function.

Sharpen outline

Emphasizes the outline of the subjects to sharpen the image.

Reduce show-through

Sharpens text in an item or reduces show-through in newspapers, etc.

Reduce moire

Reduces moire patterns.

Printed materials are displayed as a collection of fine dots. "Moire" is a phenomenon where uneven gradation or a stripe pattern appears when such photos or pictures printed with fine dots are scanned.

▶▶▶ Note

- Scanning takes longer than usual when you enable **Reduce moire**.

Reduce gutter shadow/Reduce gutter shadow (platen)

Reduces gutter shadows that appear between pages when scanning open booklets.

▶▶▶ Important

- This function is available only when scanning from the platen.

▶▶▶ Note

- Click **Driver** in the IJ Scan Utility main screen and scan to correct gutter shadows when scanning non-standard size items or specified areas.
Refer to "[Gutter Correction](#)" for details.
- When you enable this function, scanning may take longer than usual with network connection.

Correct slanted text document

Detects the scanned text and corrects the angle (within -0.1 to -10 degrees or +0.1 to +10 degrees) of the document.

▶▶▶ Important

- The following types of documents may not be corrected properly since the text cannot be detected correctly.
 - Documents in which the text lines are inclined more than 10 degrees or the angles vary by line
 - Documents containing both vertical and horizontal text
 - Documents with extremely large or small fonts

- Documents with small amount of text
- Documents containing figures/images
- Hand-written text
- Documents containing both vertical and horizontal lines (tables)

▶▶▶ Note

- Scanning takes longer than usual when you enable **Correct slanted text document**.

Detect the orientation of text document and rotate image

Automatically rotates the image to the correct orientation by detecting the orientation of text in the scanned document.

▶▶▶ Important

- Only text documents written in languages that can be selected from **Document Language** in the [Settings \(General Settings\) dialog](#) are supported.
- The orientation may not be detected for the following types of settings or documents since the text cannot be detected correctly.
 - Resolution is outside the range of 300 dpi to 600 dpi
 - Font size is outside the range of 8 points to 48 points
 - Documents containing special fonts, effects, italics, or hand-written text
 - Documents with patterned backgrounds

In that case, select the **Check scan results** checkbox and rotate the image in the [Save Settings dialog](#).

(2) Save Settings Area

File Name

Enter the file name of the image to be saved. When you save a file, the date and four digits are appended to the set file name in the "_20XX0101_0001" format.

▶▶▶ Note

- When you select the **Save to a subfolder with current date** checkbox, the date and four digits are appended to the set file name.

Save in

Displays the folder in which to save the scanned images. To change the folder, specify the destination folder in the dialog displayed by selecting **Add...** from the pop-up menu.

The default save folder is the **Pictures** folder.

Data Format

Select the data format in which to save the scanned images.

You can select **JPEG/Exif**, **TIFF**, **PNG**, **PDF**, or **PDF (Multiple Pages)**.

▶▶▶ Important

- You cannot select **JPEG/Exif** when **Color Mode** is **Black and White**.
- When **Start OCR** is selected in **Application Settings**, you cannot select **PDF** or **PDF (Multiple Pages)**.

»»» Note

- With network connection, scanning may take longer than usual when you set **TIFF** or **PNG** in **Data Format**.

PDF Compression

Select the compression type for saving PDF files.

Standard

It is recommended that you normally select this setting.

High

Compresses the file size when saving, allowing you to reduce the load on your network/server.

»»» Important

- This appears only when **PDF** or **PDF (Multiple Pages)** is selected in **Data Format**.
- When **Black and White** is selected in **Color Mode**, this option does not appear.

JPEG Image Quality

You can specify the image quality of JPEG files.

»»» Important

- This appears only when **JPEG/Exif** is selected in **Data Format**.

Create a PDF file that supports keyword search

Select this checkbox to convert text in images into text data and create PDF files that support keyword search.

»»» Important

- This appears only when **PDF** or **PDF (Multiple Pages)** is selected in **Data Format**.

»»» Note

- PDF files that are searchable in the language selected in **Document Language** on the  (General Settings) tab of the Settings dialog are created.

Save to a subfolder with current date

Select this checkbox to create a current date folder in the folder specified in **Save in** and save scanned images in it. The folder will be created with a name such as "20XX_01_01" (Year_Month_Date).

If this checkbox is not selected, files are saved directly in the folder specified in **Save in**.

Check scan results

Displays the [Save Settings dialog](#) after scanning.

(3) Application Settings Area

Open with an application

Select this when you want to enhance or correct the scanned images.

You can specify the application from the pop-up menu.

Send to an application

Select this when you want to use the scanned images as they are in an application that allows you to browse or organize images.

You can specify the application from the pop-up menu.

Send to a folder

Select this when you also want to save the scanned images to a folder other than the one specified in **Save in**.

You can specify the folder from the pop-up menu.

Attach to e-mail

Select this when you want to send e-mails with the scanned images attached.

You can specify the e-mail client you want to start from the pop-up menu.

Start OCR

Select this when you want to convert text in the scanned image into text data.

You can specify the application from the pop-up menu.

Do not start any application

Saves to the folder specified in **Save in**.

»» Note

- Specify the application or folder in the dialog displayed by selecting **Add...** from the pop-up menu.

Instructions

Opens this guide.

Defaults

You can restore the settings in the displayed screen to the default settings.

Settings (Photo Scan) Dialog

Click **Photo Scan** on the  (Scanning from a Computer) tab to display the **Settings (Photo Scan)** dialog.

In the **Settings (Photo Scan)** dialog, you can make advanced scan settings to scan items as photos.

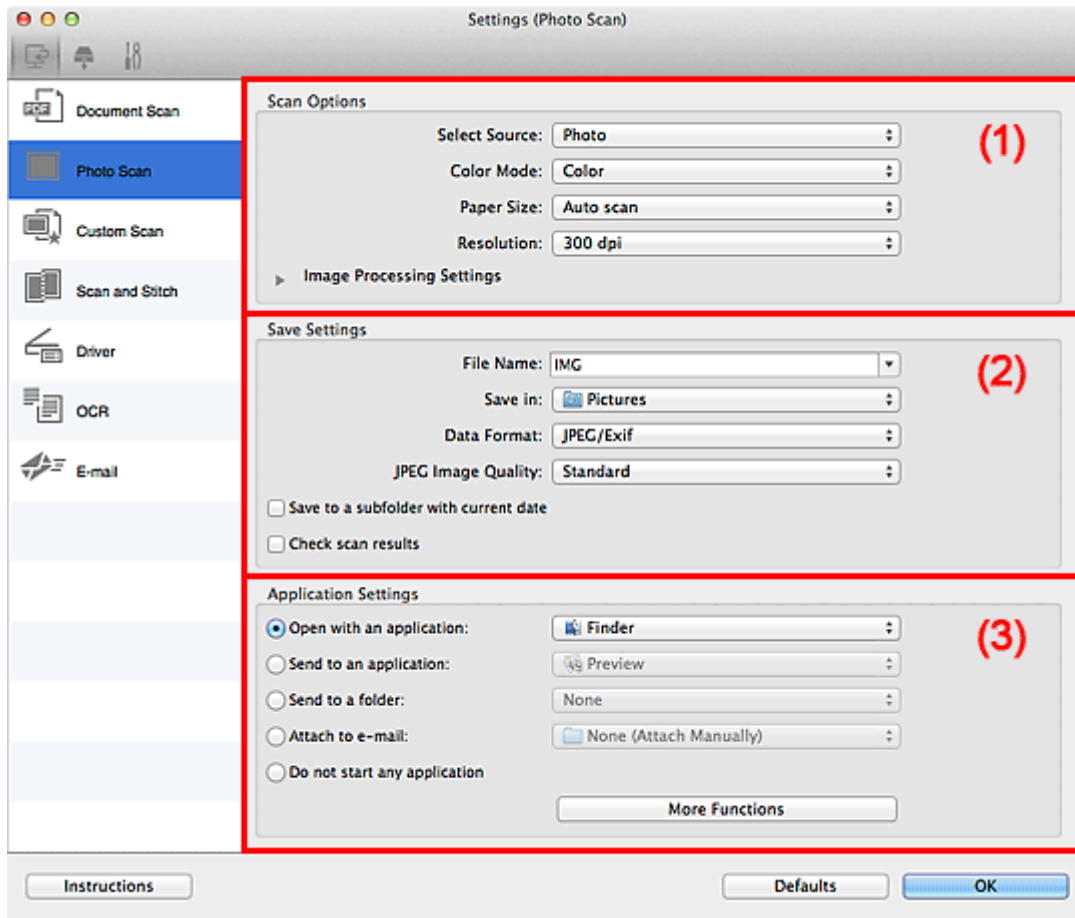

- [\(1\) Scan Options Area](#)
- [\(2\) Save Settings Area](#)
- [\(3\) Application Settings Area](#)

(1) Scan Options Area

Select Source

Photo is selected.

Color Mode

Select the color mode in which to scan the item.

Paper Size

Select the size of the item to be scanned.

When you select **Custom**, a screen in which you can specify the paper size appears. Select a **Unit**, then enter the **Width** and **Height**, and then click **OK**.

»»» Note

- Click **Defaults** to restore the specified settings to the default settings.

Resolution

Select the resolution of the item to be scanned.

The higher the resolution (value), the more detail in your image.

■ Resolution

Image Processing Settings

Click  (Right Arrow) to set the following.

»»» Important

- When **Color Mode** is **Black and White**, **Image Processing Settings** is not available.

Sharpen outline

Emphasizes the outline of the subjects to sharpen the image.

(2) Save Settings Area

File Name

Enter the file name of the image to be saved. When you save a file, the date and four digits are appended to the set file name in the "_20XX0101_0001" format.

»»» Note

- When you select the **Save to a subfolder with current date** checkbox, the date and four digits are appended to the set file name.

Save in

Displays the folder in which to save the scanned images. To change the folder, specify the destination folder in the dialog displayed by selecting **Add...** from the pop-up menu.

The default save folder is the **Pictures** folder.

Data Format

Select the data format in which to save the scanned images.

You can select **JPEG/Exif**, **TIFF**, or **PNG**.

»»» Important

- You cannot select **JPEG/Exif** when **Color Mode** is **Black and White**.

»»» Note

- With network connection, scanning may take longer than usual when you set **TIFF** or **PNG** in **Data Format**.

JPEG Image Quality

You can specify the image quality of JPEG files.

»» Important

- This appears only when **JPEG/Exif** is selected in **Data Format**.

Save to a subfolder with current date

Select this checkbox to create a current date folder in the folder specified in **Save in** and save scanned images in it. The folder will be created with a name such as "20XX_01_01" (Year_Month_Date).

If this checkbox is not selected, files are saved directly in the folder specified in **Save in**.

Check scan results

Displays the [Save Settings dialog](#) after scanning.

(3) Application Settings Area

Open with an application

Select this when you want to enhance or correct the scanned images.

You can specify the application from the pop-up menu.

Send to an application

Select this when you want to use the scanned images as they are in an application that allows you to browse or organize images.

You can specify the application from the pop-up menu.

Send to a folder

Select this when you also want to save the scanned images to a folder other than the one specified in **Save in**.

You can specify the folder from the pop-up menu.

Attach to e-mail

Select this when you want to send e-mails with the scanned images attached.

You can specify the e-mail client you want to start from the pop-up menu.

Do not start any application

Saves to the folder specified in **Save in**.

»» Note

- Specify the application or folder in the dialog displayed by selecting **Add...** from the pop-up menu.

Instructions

Opens this guide.

Defaults

You can restore the settings in the displayed screen to the default settings.

Settings (Custom Scan) Dialog

Click **Custom Scan** on the  (Scanning from a Computer) tab to display the **Settings (Custom Scan)** dialog.

In the **Settings (Custom Scan)** dialog, you can make advanced scan settings to scan according to your preference.

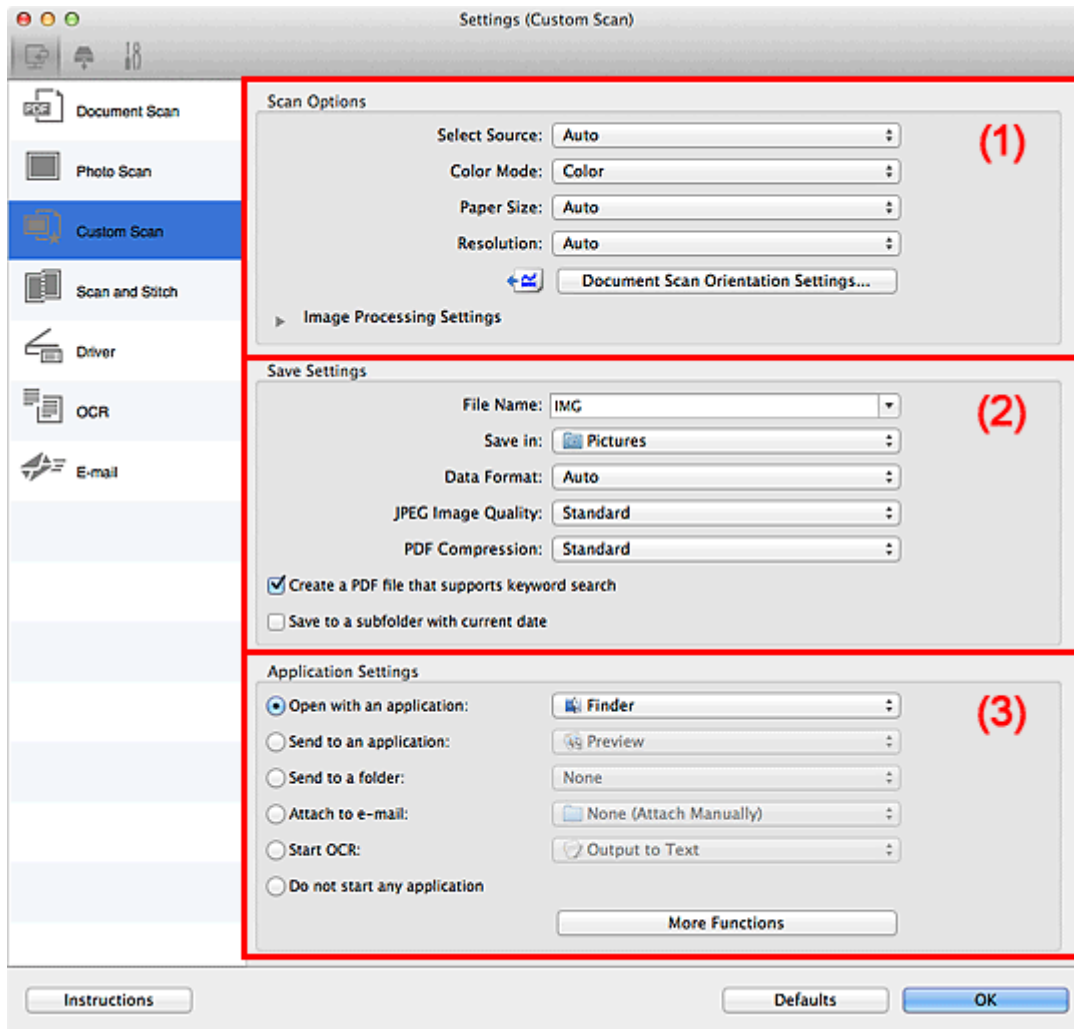

- [\(1\) Scan Options Area](#)
- [\(2\) Save Settings Area](#)
- [\(3\) Application Settings Area](#)

(1) Scan Options Area

Select Source

Select the type of item to be scanned. Select **Auto** to detect the item type automatically and to set **Color Mode**, **Paper Size**, and **Resolution** automatically as well.

►►► Important

- Item types supported by **Auto** are photos, postcards, business cards, magazines, newspapers, documents, and BD/DVD/CD.
- To scan the following types of items, specify the item type or size. You cannot scan correctly with **Auto**.
 - A4 size photos

- Text documents smaller than 2L (5 inches x 7 inches) (127 mm x 178 mm), such as paperback pages with the spine cut off
 - Items printed on thin white paper
 - Long narrow items such as panoramic photos
 - Reflective disc labels may not be scanned as expected.
 - Place items correctly according to the type of item to be scanned. Otherwise, items may not be scanned correctly.
- Refer to "[Placing Items \(When Scanning from a Computer\)](#)" for how to place items.
- When scanning two or more documents from the ADF (Auto Document Feeder), place documents of the same size even if **Auto** is set.

»»» Note

- To convert text in the image into text data after scanning, specify **Select Source** instead of selecting **Auto**.
- To reduce moire, set **Select Source** to **Magazine**.

Color Mode

Select the color mode in which to scan the item.

»»» Note

- Only **Color** is available when **Select Source** is **Auto**.

Paper Size

Select the size of the item to be scanned.

When you select **Custom**, a screen in which you can specify the paper size appears. Select a **Unit**, then enter the **Width** and **Height**, and then click **OK**.

Width: inches (1.00 - 8.50)
 Height: inches (1.00 - 11.69)
 Unit:

»»» Note

- Only **Auto** is available when **Select Source** is **Auto**.
- Click **Defaults** in the screen in which you can specify the paper size to restore the specified settings to the default settings.

Resolution

Select the resolution of the item to be scanned.

The higher the resolution (value), the more detail in your image.

■ [Resolution](#)

»»» Note

- Only **Auto** is available when **Select Source** is **Auto**.
- Only **300 dpi** or **400 dpi** can be set when **Start OCR** is selected in **Application Settings**.

Document Scan Orientation Settings...

This appears when you select ADF or **Auto** for **Select Source**.

Click to display the **Document Scan Orientation Settings** dialog in which you can set the orientation and binding side of the documents to be scanned from the ADF.

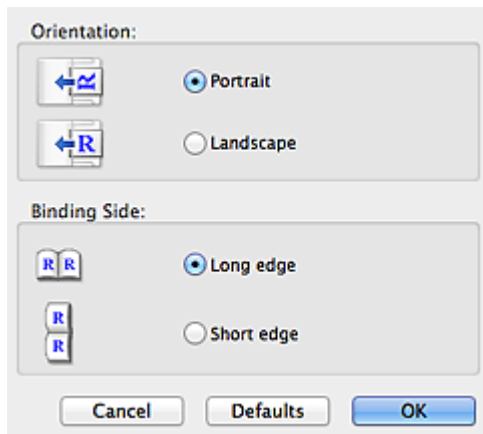

»»» Important

- **Binding Side** cannot be specified when scanning only the front side of each document.

Image Processing Settings

Click  (Right Arrow) to set the following. Available setting items vary by **Select Source**.

- **When Select Source is Auto:**

Apply recommended image correction

Applies suitable corrections automatically based on the item type.

»»» Important

- The color tone may differ from the source image due to corrections. In that case, deselect the checkbox and scan.

»»» Note

- Scanning takes longer than usual when you enable this function.

- **When Select Source is Photo:**

»»» Important

- When **Color Mode** is **Black and White**, **Image Processing Settings** is not available.

Sharpen outline

Emphasizes the outline of the subjects to sharpen the image.

- **When Select Source is Magazine or Document:**

»»» Note

- The displayed items vary by **Select Source** and **Color Mode**.

Apply Auto Document Fix

Select this checkbox to sharpen text in a document or magazine for better readability.

»»» Important

- The color tone may differ from the source image due to corrections. In that case, deselect the checkbox and scan.

▶▶▶ Note

- Scanning takes longer than usual when you enable this function.

Sharpen outline

Emphasizes the outline of the subjects to sharpen the image.

Reduce show-through

Sharpens text in an item or reduces show-through in newspapers, etc.

Reduce moire

Reduces moire patterns.

Printed materials are displayed as a collection of fine dots. "Moire" is a phenomenon where uneven gradation or a stripe pattern appears when such photos or pictures printed with fine dots are scanned.

▶▶▶ Note

- Scanning takes longer than usual when you enable **Reduce moire**.

Reduce gutter shadow

Reduces gutter shadows that appear between pages when scanning open booklets.

▶▶▶ Important

- This function is available only when scanning from the platen.

▶▶▶ Note

- Click **Driver** in the IJ Scan Utility main screen and scan to correct gutter shadows when scanning non-standard size items or specified areas.
Refer to "[Gutter Correction](#)" for details.
- When you enable this function, scanning may take longer than usual with network connection.

Correct slanted text document

Detects the scanned text and corrects the angle (within -0.1 to -10 degrees or +0.1 to +10 degrees) of the document.

▶▶▶ Important

- The following types of documents may not be corrected properly since the text cannot be detected correctly.
 - Documents in which the text lines are inclined more than 10 degrees or the angles vary by line
 - Documents containing both vertical and horizontal text
 - Documents with extremely large or small fonts
 - Documents with small amount of text
 - Documents containing figures/images
 - Hand-written text
 - Documents containing both vertical and horizontal lines (tables)

▶▶▶ Note

- Scanning takes longer than usual when you enable **Correct slanted text document**.

Detect the orientation of text document and rotate image

Automatically rotates the image to the correct orientation by detecting the orientation of text in the scanned document.

»»» Important

- Only text documents written in languages that can be selected from **Document Language** in the [Settings \(General Settings\) dialog](#) are supported.
- The orientation may not be detected for the following types of settings or documents since the text cannot be detected correctly.
 - Resolution is outside the range of 300 dpi to 600 dpi
 - Font size is outside the range of 8 points to 48 points
 - Documents containing special fonts, effects, italics, or hand-written text
 - Documents with patterned backgrounds

In that case, select the **Check scan results** checkbox and rotate the image in the [Save Settings dialog](#).

(2) Save Settings Area

File Name

Enter the file name of the image to be saved. When you save a file, the date and four digits are appended to the set file name in the "_20XX0101_0001" format.

»»» Note

- When you select the **Save to a subfolder with current date** checkbox, the date and four digits are appended to the set file name.

Save in

Displays the folder in which to save the scanned images. To change the folder, specify the destination folder in the dialog displayed by selecting **Add...** from the pop-up menu.

The default save folder is the **Pictures** folder.

Data Format

Select the data format in which to save the scanned images.

You can select **JPEG/Exif**, **TIFF**, **PNG**, **PDF**, **PDF (Multiple Pages)**, or **Auto**.

»»» Important

- You cannot select **JPEG/Exif** when **Color Mode** is **Black and White**.
- When **Start OCR** is selected in **Application Settings**, you cannot select **PDF** or **PDF (Multiple Pages)**.

»»» Note

- **Auto** appears only when **Auto** is selected for **Select Source**.
- With network connection, scanning may take longer than usual when you set **TIFF** or **PNG** in **Data Format**.

JPEG Image Quality

You can specify the image quality of JPEG files.

»»» Important

- This appears only when **JPEG/Exif** or **Auto** is selected in **Data Format**.

PDF Compression

Select the compression type for saving PDF files.

Standard

It is recommended that you normally select this setting.

High

Compresses the file size when saving, allowing you to reduce the load on your network/server.

▶▶▶ Important

- This appears only when **PDF**, **PDF (Multiple Pages)**, or **Auto** is selected in **Data Format**.
- When **Black and White** is selected in **Color Mode**, this option does not appear.

Create a PDF file that supports keyword search

Select this checkbox to convert text in images into text data and create PDF files that support keyword search.

▶▶▶ Important

- This appears only when **PDF**, **PDF (Multiple Pages)**, or **Auto** is selected in **Data Format**.

▶▶▶ Note

- PDF files that are searchable in the language selected in **Document Language** on the  (General Settings) tab of the Settings dialog are created.

Save to a subfolder with current date

Select this checkbox to create a current date folder in the folder specified in **Save in** and save scanned images in it. The folder will be created with a name such as "20XX_01_01" (Year_Month_Date).

If this checkbox is not selected, files are saved directly in the folder specified in **Save in**.

Check scan results

Displays the [Save Settings dialog](#) after scanning.

▶▶▶ Important

- This does not appear when **Select Source** is **Auto**.

(3) Application Settings Area

Open with an application

Select this when you want to enhance or correct the scanned images.

You can specify the application from the pop-up menu.

Send to an application

Select this when you want to use the scanned images as they are in an application that allows you to browse or organize images.

You can specify the application from the pop-up menu.

Send to a folder

Select this when you also want to save the scanned images to a folder other than the one specified in **Save in**.

You can specify the folder from the pop-up menu.

Attach to e-mail

Select this when you want to send e-mails with the scanned images attached.

You can specify the e-mail client you want to start from the pop-up menu.

Start OCR

Select this when you want to convert text in the scanned image into text data.

You can specify the application from the pop-up menu.

Do not start any application

Saves to the folder specified in **Save in**.

»» Note

-
- Specify the application or folder in the dialog displayed by selecting **Add...** from the pop-up menu.

Instructions

Opens this guide.

Defaults

You can restore the settings in the displayed screen to the default settings.

Settings (Scan and Stitch) Dialog

Click **Scan and Stitch** on the  (Scanning from a Computer) tab to display the **Settings (Scan and Stitch)** dialog.

In the **Settings (Scan and Stitch)** dialog, you can make advanced scan settings for scanning items larger than the platen.

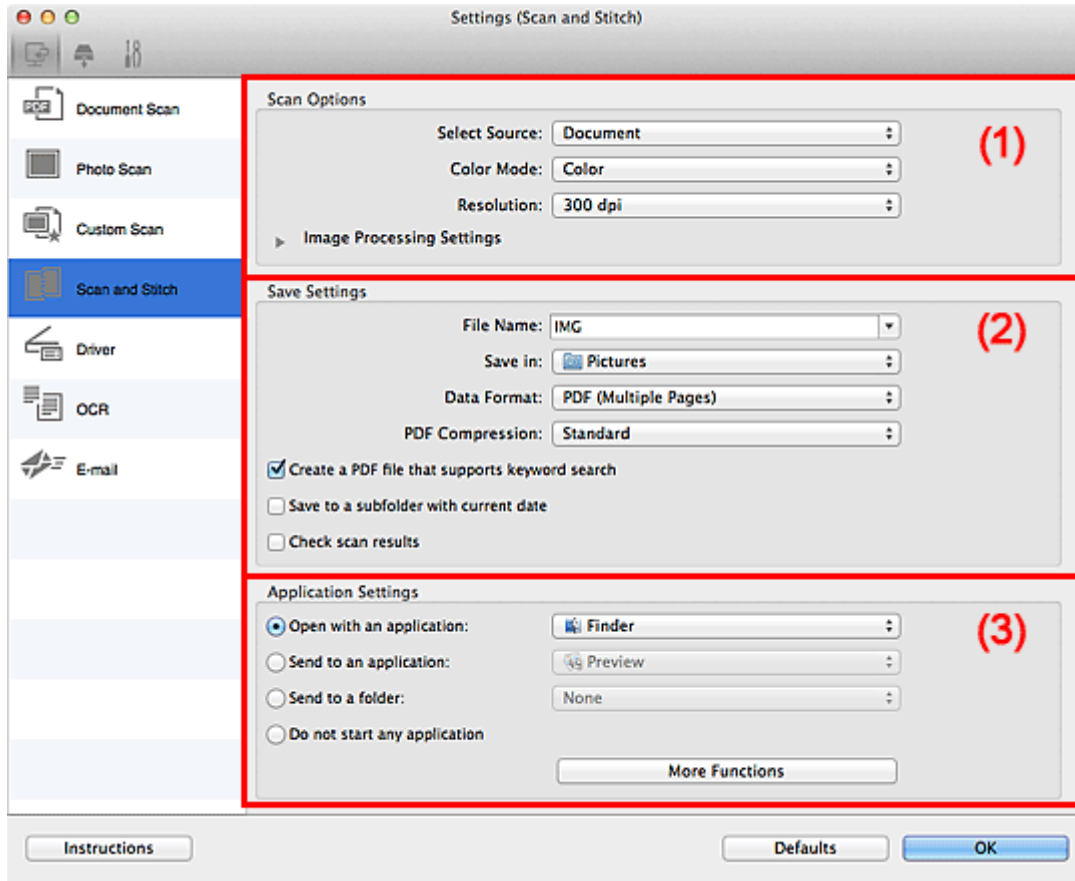

- [\(1\) Scan Options Area](#)
- [\(2\) Save Settings Area](#)
- [\(3\) Application Settings Area](#)

(1) Scan Options Area

Select Source

Select the type of item to be scanned.

- Scanning photos: **Photo**
- Scanning documents: **Document**
- Scanning magazines: **Magazine**

»»» Note

- To reduce moire, set **Select Source** to **Magazine**.

Color Mode

Select the color mode in which to scan the item.

Resolution

Select the resolution of the item to be scanned.

The higher the resolution (value), the more detail in your image.

■ Resolution

Image Processing Settings

Click  (Right Arrow) to set the following. Available setting items vary by **Select Source**.

▶▶▶ Important

- When **Color Mode** is **Black and White**, **Image Processing Settings** is not available.

- **When Select Source is Photo:**

Sharpen outline

Emphasizes the outline of the subjects to sharpen the image.

- **When Select Source is Magazine or Document:**

Sharpen outline

Emphasizes the outline of the subjects to sharpen the image.

Reduce show-through

Sharpens text in an item or reduces show-through in newspapers, etc.

Reduce moire

Reduces moire patterns.

Printed materials are displayed as a collection of fine dots. "Moire" is a phenomenon where uneven gradation or a stripe pattern appears when such photos or pictures printed with fine dots are scanned.

▶▶▶ Note

- Scanning takes longer than usual when you enable **Reduce moire**.

(2) Save Settings Area

File Name

Enter the file name of the image to be saved. When you save a file, the date and four digits are appended to the set file name in the "_20XX0101_0001" format.

▶▶▶ Note

- When you select the **Save to a subfolder with current date** checkbox, the date and four digits are appended to the set file name.

Save in

Displays the folder in which to save the scanned images. To change the folder, specify the destination folder in the dialog displayed by selecting **Add...** from the pop-up menu.

The default save folder is the **Pictures** folder.

Data Format

Select the data format in which to save the scanned images.

You can select **JPEG/Exif**, **TIFF**, **PNG**, **PDF**, or **PDF (Multiple Pages)**.

▶▶▶ Important

- You cannot select **JPEG/Exif** when **Color Mode** is **Black and White**.

»»» Note

- With network connection, scanning may take longer than usual when you set **TIFF** or **PNG** in **Data Format**.

PDF Compression

Select the compression type for saving PDF files.

Standard

It is recommended that you normally select this setting.

High

Compresses the file size when saving, allowing you to reduce the load on your network/server.

»»» Important

- This appears only when **PDF** or **PDF (Multiple Pages)** is selected in **Data Format**.
- When **Black and White** is selected in **Color Mode**, this option does not appear.

Create a PDF file that supports keyword search

Select this checkbox to convert text in images into text data and create PDF files that support keyword search.

»»» Important

- This appears only when **PDF** or **PDF (Multiple Pages)** is selected in **Data Format**.

»»» Note

- PDF files that are searchable in the language selected in **Document Language** on the  (General Settings) tab of the Settings dialog are created.

JPEG Image Quality

You can specify the image quality of JPEG files.

»»» Important

- This appears only when **JPEG/Exif** is selected in **Data Format**.

Save to a subfolder with current date

Select this checkbox to create a current date folder in the folder specified in **Save in** and save scanned images in it. The folder will be created with a name such as "20XX_01_01" (Year_Month_Date).

If this checkbox is not selected, files are saved directly in the folder specified in **Save in**.

Check scan results

Displays the [Save Settings dialog](#) after scanning.

(3) Application Settings Area

Open with an application

Select this when you want to enhance or correct the scanned images.

You can specify the application from the pop-up menu.

Send to an application

Select this when you want to use the scanned images as they are in an application that allows you to browse or organize images.

You can specify the application from the pop-up menu.

Send to a folder

Select this when you also want to save the scanned images to a folder other than the one specified in **Save in**.

You can specify the folder from the pop-up menu.

Do not start any application

Saves to the folder specified in **Save in**.

▶▶▶ Note

- Specify the application or folder in the dialog displayed by selecting **Add...** from the pop-up menu.

Instructions

Opens this guide.

Defaults

You can restore the settings in the displayed screen to the default settings.

Settings (Driver) Dialog

Click **Driver** on the  (Scanning from a Computer) tab to display the **Settings (Driver)** dialog.

In the **Settings (Driver)** dialog, you can specify how to save images when scanning items by starting the scanner driver from IJ Scan Utility and how to respond after saving them.

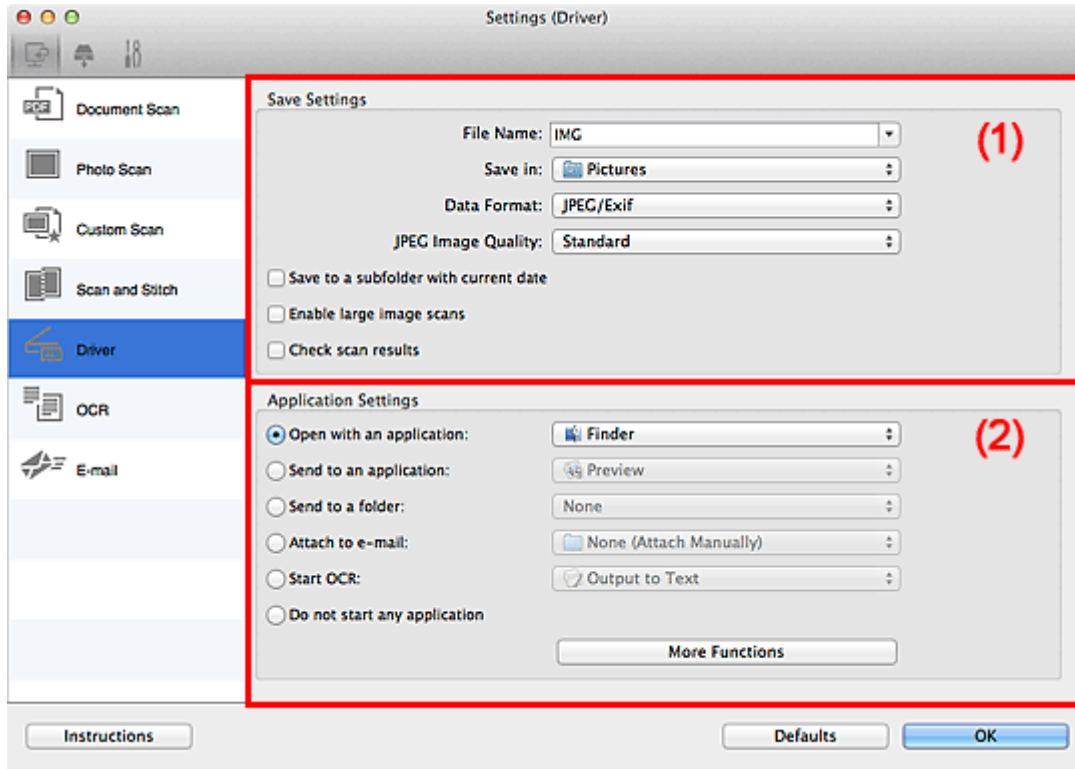

■ (1) Save Settings Area

■ (2) Application Settings Area

(1) Save Settings Area

File Name

Enter the file name of the image to be saved. When you save a file, the date and four digits are appended to the set file name in the "_20XX0101_0001" format.

»»» Note

- When you select the **Save to a subfolder with current date** checkbox, the date and four digits are appended to the set file name.

Save in

Displays the folder in which to save the scanned images. To change the folder, specify the destination folder in the dialog displayed by selecting **Add...** from the pop-up menu.

The default save folder is the **Pictures** folder.

Data Format

Select the data format in which to save the scanned images.

You can select **JPEG/Exif**, **TIFF**, **PNG**, **PDF**, or **PDF (Multiple Pages)**.

»»» Note

- When **PDF** or **PDF (Multiple Pages)** is selected, images up to 9600 pixels x 9600 pixels can be scanned.
- When the **Enable large image scans** checkbox is selected in **Save Settings**, or when **Start OCR** is selected in **Application Settings**, you can select **JPEG/Exif**, **TIFF**, or **PNG**.
- With network connection, scanning may take longer than usual when you set **TIFF** or **PNG** in **Data Format**.

JPEG Image Quality

You can specify the image quality of JPEG files.

»»» Important

- This appears only when **JPEG/Exif** is selected in **Data Format**.

PDF Compression

Select the compression type for saving PDF files.

Standard

It is recommended that you normally select this setting.

High

Compresses the file size when saving, allowing you to reduce the load on your network/server.

»»» Important

- This appears only when **PDF** or **PDF (Multiple Pages)** is selected in **Data Format**.

Create a PDF file that supports keyword search

Select this checkbox to convert text in images into text data and create PDF files that support keyword search.

»»» Important

- This appears only when **PDF** or **PDF (Multiple Pages)** is selected in **Data Format**.

»»» Note

- PDF files that are searchable in the language selected in **Document Language** on the  (General Settings) tab of the Settings dialog are created.

Save to a subfolder with current date

Select this checkbox to create a current date folder in the folder specified in **Save in** and save scanned images in it. The folder will be created with a name such as "20XX_01_01" (Year_Month_Date).

If this checkbox is not selected, files are saved directly in the folder specified in **Save in**.

Enable large image scans

Select this checkbox to scan images up to 21000 pixels x 30000 pixels and 1.8 GB.

»»» Important

- When this checkbox is selected, you cannot select **Send to an application**, **Send to a folder**, **Attach to e-mail**, or **Start OCR**.

»»» Note

- When this checkbox is not selected, images up to 10208 pixels x 14032 pixels can be scanned.

Check scan results

Displays the [Save Settings dialog](#) after scanning.

(2) Application Settings Area

Open with an application

Select this when you want to enhance or correct the scanned images.

You can specify the application from the pop-up menu.

Send to an application

Select this when you want to use the scanned images as they are in an application that allows you to browse or organize images.

You can specify the application from the pop-up menu.

Send to a folder

Select this when you also want to save the scanned images to a folder other than the one specified in **Save in**.

You can specify the folder from the pop-up menu.

Attach to e-mail

Select this when you want to send e-mails with the scanned images attached.

You can specify the e-mail client you want to start from the pop-up menu.

Start OCR

Select this when you want to convert text in the scanned image into text data.

You can specify the application from the pop-up menu.

Do not start any application

Saves to the folder specified in **Save in**.

►► Note

- Specify the application or folder in the dialog displayed by selecting **Add...** from the pop-up menu.

Instructions

Opens this guide.

Defaults

You can restore the settings in the displayed screen to the default settings.

Settings (OCR) Dialog

Click **OCR** on the  (Scanning from a Computer) tab to display the **Settings (OCR)** dialog.

In the **Settings (OCR)** dialog, you can make advanced settings for extracting text from scanned images.

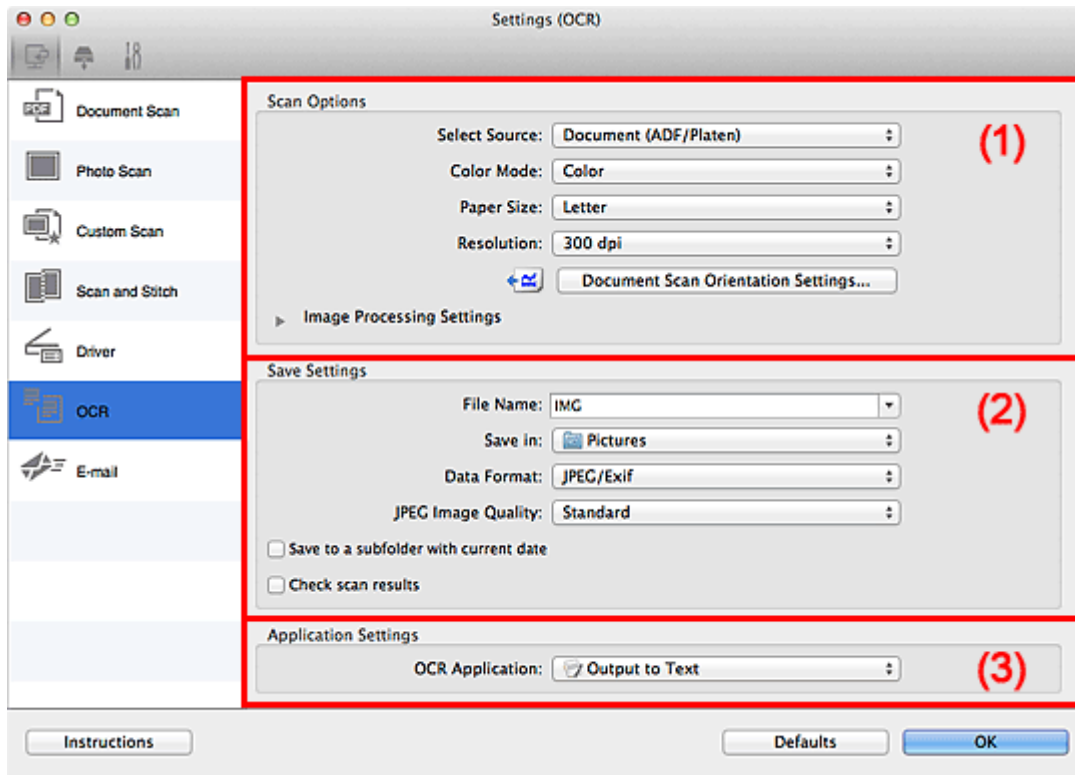

■ (1) Scan Options Area

■ (2) Save Settings Area

■ (3) Application Settings Area

(1) Scan Options Area

Select Source

Select the type of item to be scanned.

- Scanning documents: **Document** or **Document (ADF/Platen)**
- Scanning magazines: **Magazine**
- Scanning documents from the ADF (Auto Document Feeder): **Document (ADF Simplex)**, **Document (ADF Manual Duplex)**, or **Document (ADF/Platen)**

»»» Note

- When **Document (ADF/Platen)** is selected and documents are placed both on the platen and ADF, those placed on the ADF will be scanned.

Color Mode

Select the color mode in which to scan the item.

Paper Size

Select the size of the item to be scanned.

When you select **Custom**, a screen in which you can specify the paper size appears. Select a **Unit**, then enter the **Width** and **Height**, and then click **OK**.

»»» Important

- **Custom** cannot be selected depending on the **Select Source** setting.

»»» Note

- Click **Defaults** to restore the specified settings to the default settings.

Resolution

Select the resolution of the item to be scanned.

The higher the resolution (value), the more detail in your image.

■ Resolution

»»» Note

- For **Resolution**, only **300 dpi** or **400 dpi** can be set.

Document Scan Orientation Settings...

This appears when you select ADF for **Select Source**.

Click to display the **Document Scan Orientation Settings** dialog in which you can set the orientation and binding side of the documents to be scanned from the ADF.

»»» Important

- **Binding Side** cannot be specified when scanning only the front side of each document.

Image Processing Settings

Click  (Right Arrow) to set the following.

»»» Note

- The displayed items vary by **Select Source** and **Color Mode**.

Apply Auto Document Fix

Select this checkbox to sharpen text in a document or magazine for better readability.

»»» Important

- The color tone may differ from the source image due to corrections. In that case, deselect the checkbox and scan.

»»» Note

- Scanning takes longer than usual when you enable this function.

Sharpen outline

Emphasizes the outline of the subjects to sharpen the image.

Reduce show-through

Sharpens text in an item or reduces show-through in newspapers, etc.

Reduce moire

Reduces moire patterns.

Printed materials are displayed as a collection of fine dots. "Moire" is a phenomenon where uneven gradation or a stripe pattern appears when such photos or pictures printed with fine dots are scanned.

»»» Note

- Scanning takes longer than usual when you enable **Reduce moire**.

Reduce gutter shadow/Reduce gutter shadow (platen)

Reduces gutter shadows that appear between pages when scanning open booklets.

»»» Important

- This function is available only when scanning from the platen.

»»» Note

- Click **Driver** in the IJ Scan Utility main screen and scan to correct gutter shadows when scanning non-standard size items or specified areas.
Refer to "[Gutter Correction](#)" for details.
- When you enable this function, scanning may take longer than usual with network connection.

Correct slanted text document

Detects the scanned text and corrects the angle (within -0.1 to -10 degrees or +0.1 to +10 degrees) of the document.

»»» Important

- The following types of documents may not be corrected properly since the text cannot be detected correctly.
 - Documents in which the text lines are inclined more than 10 degrees or the angles vary by line
 - Documents containing both vertical and horizontal text
 - Documents with extremely large or small fonts
 - Documents with small amount of text
 - Documents containing figures/images
 - Hand-written text
 - Documents containing both vertical and horizontal lines (tables)

»»» Note

- Scanning takes longer than usual when you enable **Correct slanted text document**.

Detect the orientation of text document and rotate image

Automatically rotates the image to the correct orientation by detecting the orientation of text in the scanned document.

»»» Important

- Only text documents written in languages that can be selected from **Document Language** in the [Settings \(General Settings\) dialog](#) are supported.
- The orientation may not be detected for the following types of settings or documents since the text cannot be detected correctly.
 - Resolution is outside the range of 300 dpi to 600 dpi
 - Font size is outside the range of 8 points to 48 points
 - Documents containing special fonts, effects, italics, or hand-written text
 - Documents with patterned backgrounds

In that case, select the **Check scan results** checkbox and rotate the image in the [Save Settings dialog](#).

(2) Save Settings Area

File Name

Enter the file name of the image to be saved. When you save a file, the date and four digits are appended to the set file name in the "_20XX0101_0001" format.

»»» Note

- When you select the **Save to a subfolder with current date** checkbox, the date and four digits are appended to the set file name.

Save in

Displays the folder in which to save the scanned images. To change the folder, specify the destination folder in the dialog displayed by selecting **Add...** from the pop-up menu.

The default save folder is the **Pictures** folder.

Data Format

Select the data format in which to save the scanned images.

You can select **JPEG/Exif**, **TIFF**, or **PNG**.

»»» Important

- You cannot select **JPEG/Exif** when **Color Mode** is **Black and White**.

»»» Note

- With network connection, scanning may take longer than usual when you set **TIFF** or **PNG** in **Data Format**.

JPEG Image Quality

You can specify the image quality of JPEG files.

»»» Important

- This appears only when **JPEG/Exif** is selected in **Data Format**.

Save to a subfolder with current date

Select this checkbox to create a current date folder in the folder specified in **Save in** and save scanned images in it. The folder will be created with a name such as "20XX_01_01" (Year_Month_Date).

If this checkbox is not selected, files are saved directly in the folder specified in **Save in**.

Check scan results

Displays the [Save Settings dialog](#) after scanning.

(3) Application Settings Area

OCR Application

Displays the extracted text in a specified application.

▶▶ Note

- You can add applications from **Add** in the dialog displayed by selecting **Add...** from the pop-up menu.

Instructions

Opens this guide.

Defaults

You can restore the settings in the displayed screen to the default settings.

Settings (E-mail) Dialog

Click **E-mail** on the  (Scanning from a Computer) tab to display the **Settings (E-mail)** dialog.

In the **Settings (E-mail)** dialog, you can specify how to respond when attaching images to an e-mail after scanning them using the scanner button.

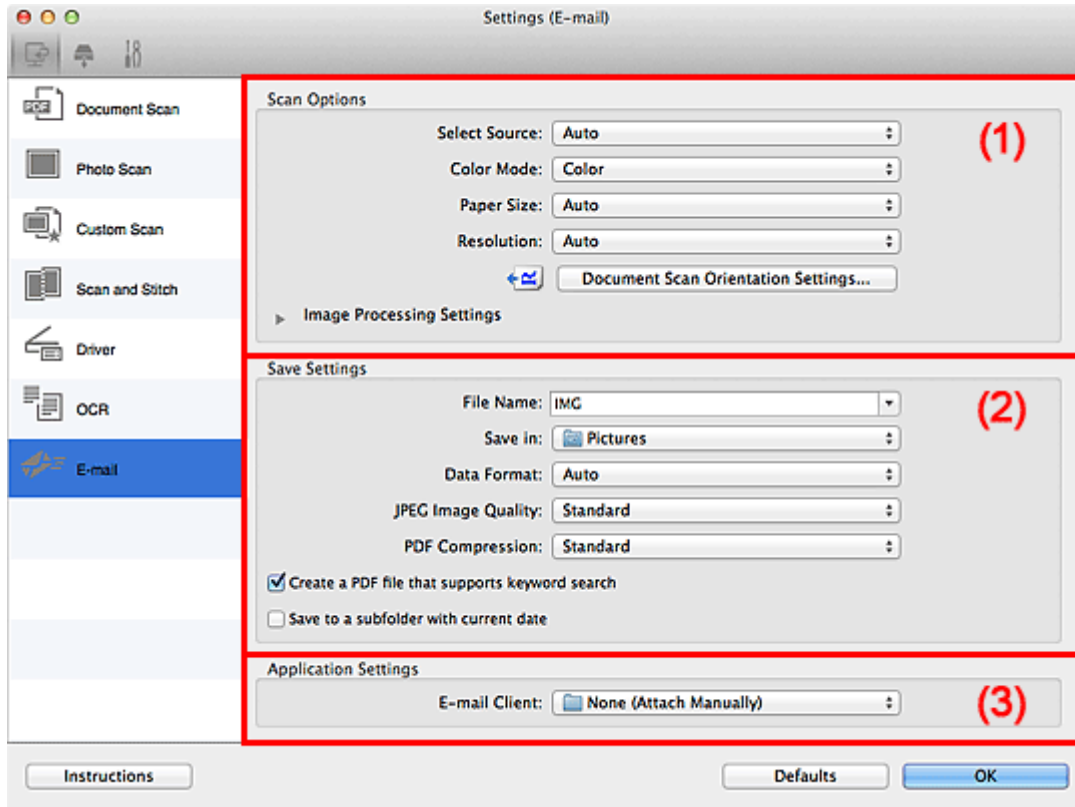

- [\(1\) Scan Options Area](#)
- [\(2\) Save Settings Area](#)
- [\(3\) Application Settings Area](#)

(1) Scan Options Area

Select Source

Select the type of item to be scanned. Select **Auto** to detect the item type automatically and to set **Color Mode**, **Paper Size**, and **Resolution** automatically as well.

►►► Important

- Item types supported by **Auto** are photos, postcards, business cards, magazines, newspapers, documents, and BD/DVD/CD.
- To scan the following types of items, specify the item type or size. You cannot scan correctly with **Auto**.
 - A4 size photos
 - Text documents smaller than 2L (5 inches x 7 inches) (127 mm x 178 mm), such as paperback pages with the spine cut off
 - Items printed on thin white paper
 - Long narrow items such as panoramic photos
- Reflective disc labels may not be scanned as expected.

- Place items correctly according to the type of item to be scanned. Otherwise, items may not be scanned correctly.

Refer to "[Placing Items \(When Scanning from a Computer\)](#)" for how to place items.

- When scanning two or more documents from the ADF (Auto Document Feeder), place documents of the same size even if **Auto** is set.

»»» Note

- To reduce moire, set **Select Source** to **Magazine**.

Color Mode

Select the color mode in which to scan the item.

»»» Note

- Only **Color** is available when **Select Source** is **Auto**.

Paper Size

Select the size of the item to be scanned.

When you select **Custom**, a screen in which you can specify the paper size appears. Select a **Unit**, then enter the **Width** and **Height**, and then click **OK**.

Width: inches (1.00 - 8.50)
Height: inches (1.00 - 11.69)
Unit: ▾

»»» Note

- Only **Auto** is available when **Select Source** is **Auto**.
- Click **Defaults** in the screen in which you can specify the paper size to restore the specified settings to the default settings.

Resolution

Select the resolution of the item to be scanned.

The higher the resolution (value), the more detail in your image.

■ [Resolution](#)

»»» Note

- Only **Auto** is available when **Select Source** is **Auto**.

Document Scan Orientation Settings...

This appears when you select ADF or **Auto** for **Select Source**.

Click to display the **Document Scan Orientation Settings** dialog in which you can set the orientation and binding side of the documents to be scanned from the ADF.

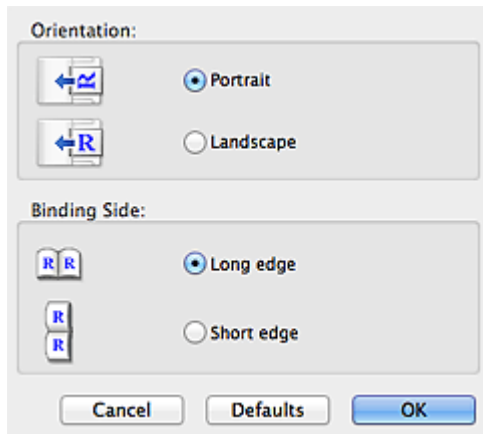

»»» Important

- **Binding Side** cannot be specified when scanning only the front side of each document.

Image Processing Settings

Click (Right Arrow) to set the following. Available setting items vary by **Select Source**.

- **When Select Source is Auto:**

Apply recommended image correction

Applies suitable corrections automatically based on the item type.

»»» Important

- The color tone may differ from the source image due to corrections. In that case, deselect the checkbox and scan.

»»» Note

- Scanning takes longer than usual when you enable this function.

- **When Select Source is Photo:**

»»» Important

- When **Color Mode** is **Black and White**, **Image Processing Settings** is not available.

Sharpen outline

Emphasizes the outline of the subjects to sharpen the image.

- **When Select Source is Magazine or Document:**

»»» Note

- The displayed items vary by **Select Source** and **Color Mode**.

Apply Auto Document Fix

Select this checkbox to sharpen text in a document or magazine for better readability.

»»» Important

- The color tone may differ from the source image due to corrections. In that case, deselect the checkbox and scan.

»»» Note

- Scanning takes longer than usual when you enable this function.

Sharpen outline

Emphasizes the outline of the subjects to sharpen the image.

Reduce show-through

Sharpens text in an item or reduces show-through in newspapers, etc.

Reduce moire

Reduces moire patterns.

Printed materials are displayed as a collection of fine dots. "Moire" is a phenomenon where uneven gradation or a stripe pattern appears when such photos or pictures printed with fine dots are scanned.

▶▶▶ Note

- Scanning takes longer than usual when you enable **Reduce moire**.

Reduce gutter shadow

Reduces gutter shadows that appear between pages when scanning open booklets.

▶▶▶ Important

- This function is available only when scanning from the platen.

▶▶▶ Note

- Click **Driver** in the IJ Scan Utility main screen and scan to correct gutter shadows when scanning non-standard size items or specified areas.
Refer to "[Gutter Correction](#)" for details.
- When you enable this function, scanning may take longer than usual with network connection.

Correct slanted text document

Detects the scanned text and corrects the angle (within -0.1 to -10 degrees or +0.1 to +10 degrees) of the document.

▶▶▶ Important

- The following types of documents may not be corrected properly since the text cannot be detected correctly.
 - Documents in which the text lines are inclined more than 10 degrees or the angles vary by line
 - Documents containing both vertical and horizontal text
 - Documents with extremely large or small fonts
 - Documents with small amount of text
 - Documents containing figures/images
 - Hand-written text
 - Documents containing both vertical and horizontal lines (tables)

▶▶▶ Note

- Scanning takes longer than usual when you enable **Correct slanted text document**.

Detect the orientation of text document and rotate image

Automatically rotates the image to the correct orientation by detecting the orientation of text in the scanned document.

»» Important

- Only text documents written in languages that can be selected from **Document Language** in the [Settings \(General Settings\) dialog](#) are supported.
- The orientation may not be detected for the following types of settings or documents since the text cannot be detected correctly.
 - Resolution is outside the range of 300 dpi to 600 dpi
 - Font size is outside the range of 8 points to 48 points
 - Documents containing special fonts, effects, italics, or hand-written text
 - Documents with patterned backgrounds

In that case, select the **Check scan results** checkbox and rotate the image in the [Save Settings dialog](#).

(2) Save Settings Area

File Name

Enter the file name of the image to be saved. When you save a file, the date and four digits are appended to the set file name in the "_20XX0101_0001" format.

»» Note

- When you select the **Save to a subfolder with current date** checkbox, the date and four digits are appended to the set file name.

Save in

Displays the folder in which to save the scanned images. To change the folder, specify the destination folder in the dialog displayed by selecting **Add...** from the pop-up menu.

The default save folder is the **Pictures** folder.

Data Format

Select the data format in which to save the scanned images.

You can select **JPEG/Exif**, **TIFF**, **PNG**, **PDF**, **PDF (Multiple Pages)**, or **Auto**.

»» Important

- You cannot select **JPEG/Exif** when **Color Mode** is **Black and White**.

»» Note

- **Auto** appears only when **Auto** is selected for **Select Source**.
- With network connection, scanning may take longer than usual when you set **TIFF** or **PNG** in **Data Format**.

JPEG Image Quality

You can specify the image quality of JPEG files.

»» Important

- This appears only when **JPEG/Exif** or **Auto** is selected in **Data Format**.

PDF Compression

Select the compression type for saving PDF files.

Standard

It is recommended that you normally select this setting.

High

Compresses the file size when saving, allowing you to reduce the load on your network/server.

Important

- This appears only when **PDF** or **PDF (Multiple Pages)** is selected in **Data Format**.
- When **Black and White** is selected in **Color Mode**, this option does not appear.

Create a PDF file that supports keyword search

Select this checkbox to convert text in images into text data and create PDF files that support keyword search.

Important

- This appears only when **PDF**, **PDF (Multiple Pages)**, or **Auto** is selected in **Data Format**.

Note

- PDF files that are searchable in the language selected in **Document Language** on the  (General Settings) tab of the Settings dialog are created.

Save to a subfolder with current date

Select this checkbox to create a current date folder in the folder specified in **Save in** and save scanned images in it. The folder will be created with a name such as "20XX_01_01" (Year_Month_Date).

If this checkbox is not selected, files are saved directly in the folder specified in **Save in**.

Check scan results

Displays the [Save Settings dialog](#) after scanning.

Important

- This does not appear when **Select Source** is **Auto**.

(3) Application Settings Area

E-mail Client

Specify the e-mail client to use for attaching scanned images.

Note

- You can add e-mail clients from **Add** in the dialog displayed by selecting **Add...** from the pop-up menu.

Instructions

Opens this guide.

Defaults

You can restore the settings in the displayed screen to the default settings.

Settings (Save to PC (Photo)) Dialog

Click **Save to PC (Photo)** on the  (Scanning from the Operation Panel) tab to display the **Settings (Save to PC (Photo))** dialog.

In the **Settings (Save to PC (Photo))** dialog, you can specify how to respond when saving images to a computer as photos after scanning them from the operation panel.

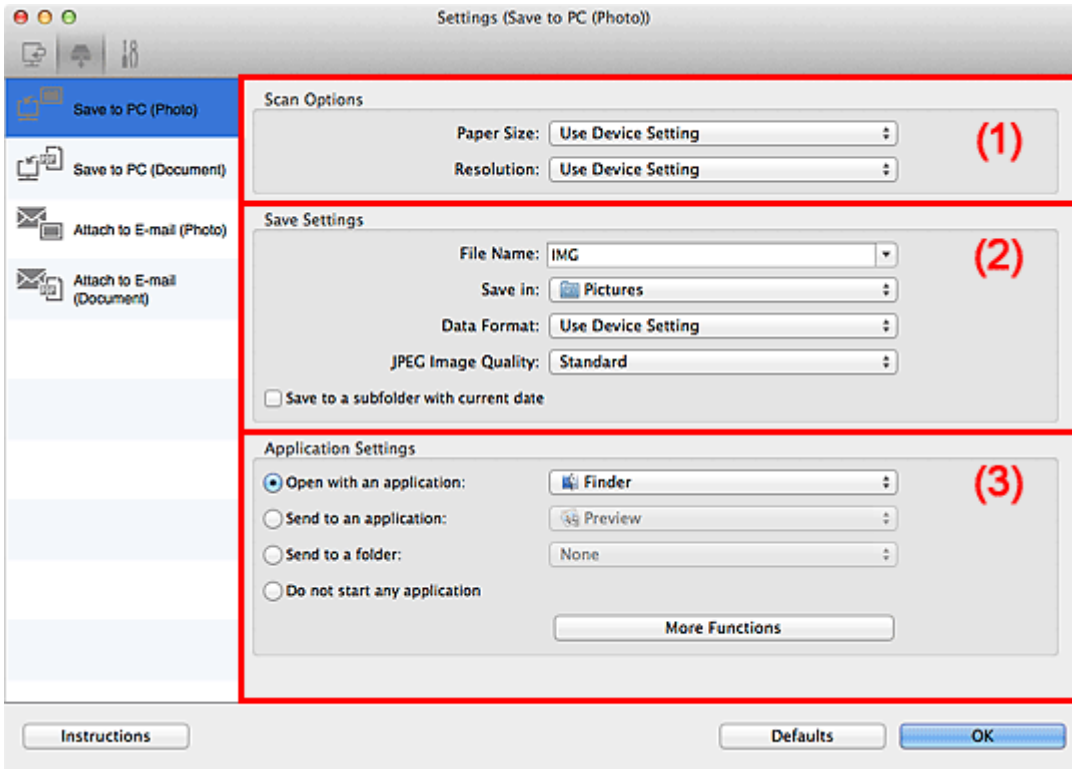

- [\(1\) Scan Options Area](#)
- [\(2\) Save Settings Area](#)
- [\(3\) Application Settings Area](#)

(1) Scan Options Area

Paper Size

Set from the operation panel.

Resolution

Set from the operation panel.

(2) Save Settings Area

File Name

Enter the file name of the image to be saved. When you save a file, the date and four digits are appended to the set file name in the "_20XX0101_0001" format.

▶▶▶ Note

- When you select the **Save to a subfolder with current date** checkbox, the date and four digits are appended to the set file name.

Save in

Displays the folder in which to save the scanned images. To change the folder, specify the destination folder in the dialog displayed by selecting **Add...** from the pop-up menu.

The default save folder is the **Pictures** folder.

Data Format

Set from the operation panel.

JPEG Image Quality

You can specify the image quality of JPEG files.

Save to a subfolder with current date

Select this checkbox to create a current date folder in the folder specified in **Save in** and save scanned images in it. The folder will be created with a name such as "20XX_01_01" (Year_Month_Date).

If this checkbox is not selected, files are saved directly in the folder specified in **Save in**.

(3) Application Settings Area

Open with an application

Select this when you want to enhance or correct the scanned images.

You can specify the application from the pop-up menu.

Send to an application

Select this when you want to use the scanned images as they are in an application that allows you to browse or organize images.

You can specify the application from the pop-up menu.

Send to a folder

Select this when you also want to save the scanned images to a folder other than the one specified in **Save in**.

You can specify the folder from the pop-up menu.

Do not start any application

Saves to the folder specified in **Save in**.

▶▶▶ Note

- Specify the application or folder in the dialog displayed by selecting **Add...** from the pop-up menu.

Instructions

Opens this guide.

Defaults

You can restore the settings in the displayed screen to the default settings.

Settings (Save to PC (Document)) Dialog

Click **Save to PC (Document)** on the  (Scanning from the Operation Panel) tab to display the **Settings (Save to PC (Document))** dialog.

In the **Settings (Save to PC (Document))** dialog, you can specify how to respond when saving images to a computer as documents after scanning them from the operation panel.

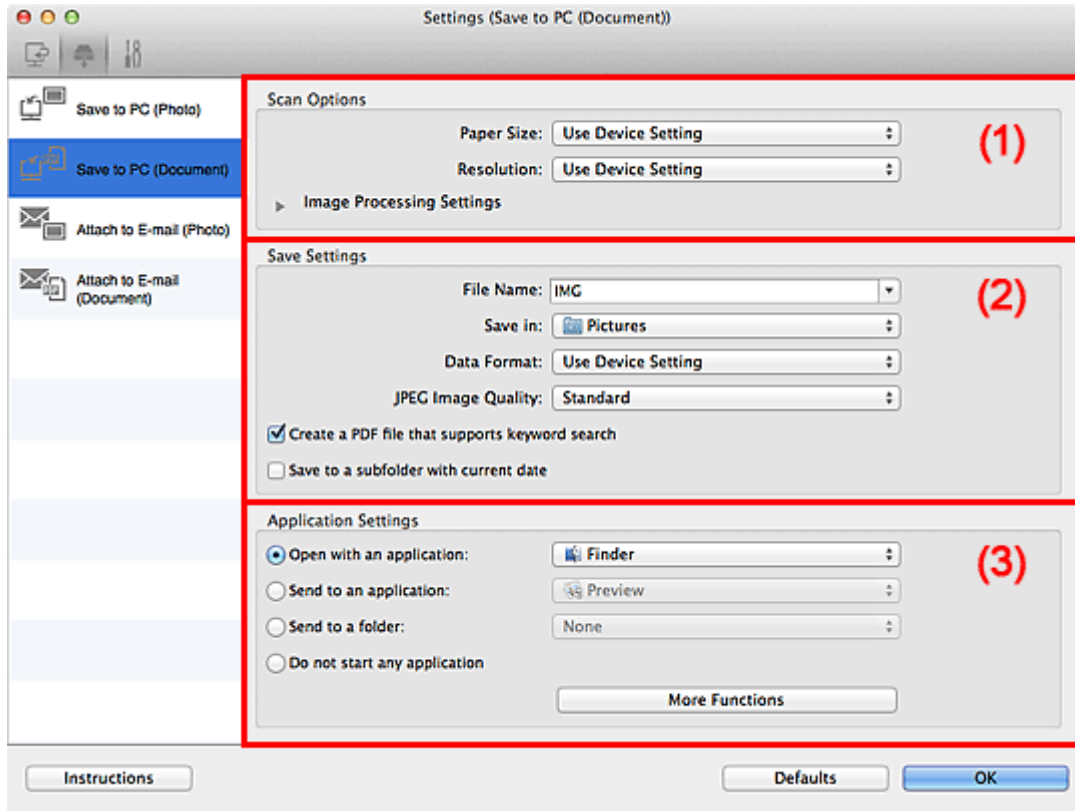

- [\(1\) Scan Options Area](#)
- [\(2\) Save Settings Area](#)
- [\(3\) Application Settings Area](#)

(1) Scan Options Area

Paper Size

Set from the operation panel.

Resolution

Set from the operation panel.

Image Processing Settings

Click  (Right Arrow) to set the following.

Apply Auto Document Fix

Select this checkbox to sharpen text in a document or magazine for better readability.

Important

- The color tone may differ from the source image due to corrections. In that case, deselect the checkbox and scan.

»» Note

- Scanning takes longer than usual when you enable this function.

Reduce gutter shadow (platen)

Reduces gutter shadows that appear between pages when scanning open booklets.

»» Important

- This function is available only when scanning from the platen.

»» Note

- When you enable this function, scanning may take longer than usual with network connection.

Correct slanted text document

Detects the scanned text and corrects the angle (within -0.1 to -10 degrees or +0.1 to +10 degrees) of the document.

»» Important

- The following types of documents may not be corrected properly since the text cannot be detected correctly.
 - Documents in which the text lines are inclined more than 10 degrees or the angles vary by line
 - Documents containing both vertical and horizontal text
 - Documents with extremely large or small fonts
 - Documents with small amount of text
 - Documents containing figures/images
 - Hand-written text
 - Documents containing both vertical and horizontal lines (tables)

»» Note

- Scanning takes longer than usual when you enable **Correct slanted text document**.

Detect the orientation of text document and rotate image

Automatically rotates the image to the correct orientation by detecting the orientation of text in the scanned document.

»» Important

- Only text documents written in languages that can be selected from **Document Language** in the [Settings \(General Settings\) dialog](#) are supported.
- The orientation may not be detected for the following types of settings or documents since the text cannot be detected correctly.
 - Resolution is outside the range of 300 dpi to 600 dpi
 - Font size is outside the range of 8 points to 48 points
 - Documents containing special fonts, effects, italics, or hand-written text
 - Documents with patterned backgrounds

(2) Save Settings Area

File Name

Enter the file name of the image to be saved. When you save a file, the date and four digits are appended to the set file name in the "_20XX0101_0001" format.

▶▶▶ Note

- When you select the **Save to a subfolder with current date** checkbox, the date and four digits are appended to the set file name.

Save in

Displays the folder in which to save the scanned images. To change the folder, specify the destination folder in the dialog displayed by selecting **Add...** from the pop-up menu.

The default save folder is the **Pictures** folder.

Data Format

Set from the operation panel.

JPEG Image Quality

You can specify the image quality of JPEG files.

Create a PDF file that supports keyword search

Select this checkbox to convert text in images into text data and create PDF files that support keyword search.

▶▶▶ Note

- PDF files that are searchable in the language selected in **Document Language** on the  (General Settings) tab of the Settings dialog are created.

Save to a subfolder with current date

Select this checkbox to create a current date folder in the folder specified in **Save in** and save scanned images in it. The folder will be created with a name such as "20XX_01_01" (Year_Month_Date).

If this checkbox is not selected, files are saved directly in the folder specified in **Save in**.

(3) Application Settings Area

Open with an application

Select this when you want to enhance or correct the scanned images.

You can specify the application from the pop-up menu.

Send to an application

Select this when you want to use the scanned images as they are in an application that allows you to browse or organize images.

You can specify the application from the pop-up menu.

Send to a folder

Select this when you also want to save the scanned images to a folder other than the one specified in **Save in**.

You can specify the folder from the pop-up menu.

Do not start any application

Saves to the folder specified in **Save in**.

»» Note

- Specify the application or folder in the dialog displayed by selecting **Add...** from the pop-up menu.

Instructions

Opens this guide.

Defaults

You can restore the settings in the displayed screen to the default settings.

Settings (Attach to E-mail (Photo)) Dialog

Click **Attach to E-mail (Photo)** on the  (Scanning from the Operation Panel) tab to display the **Settings (Attach to E-mail (Photo))** dialog.

In the **Settings (Attach to E-mail (Photo))** dialog, you can specify how to respond when attaching images to an e-mail as photos after scanning them from the operation panel.

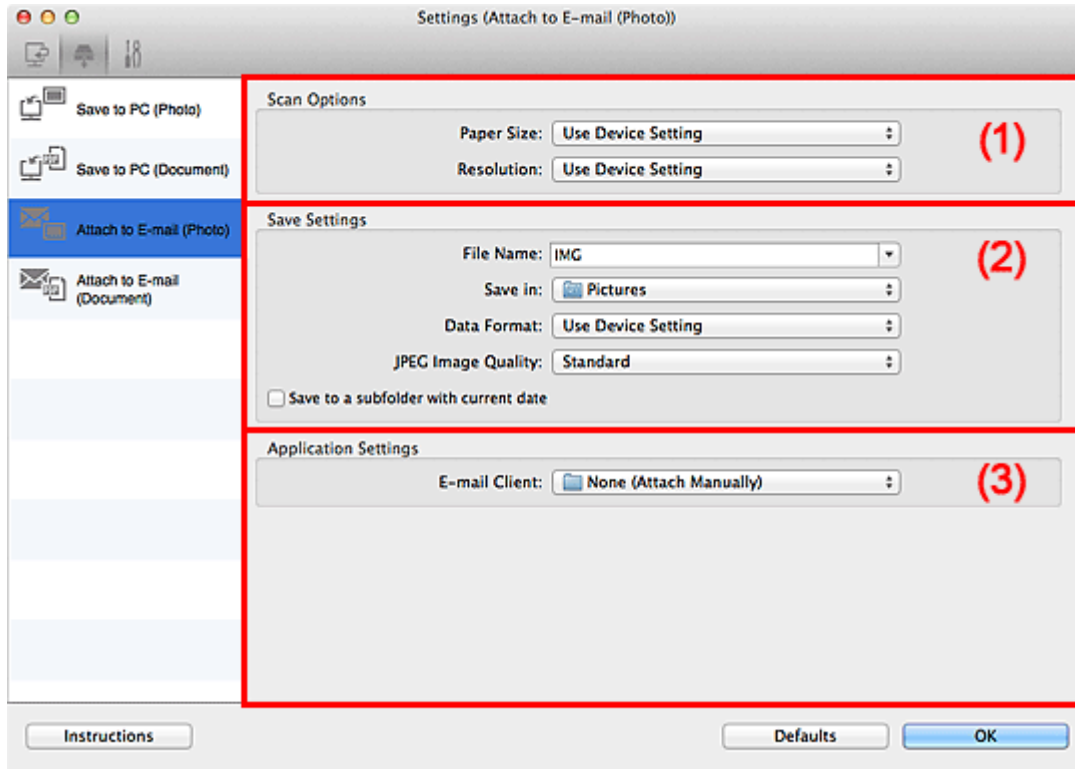

- [\(1\) Scan Options Area](#)
- [\(2\) Save Settings Area](#)
- [\(3\) Application Settings Area](#)

(1) Scan Options Area

Paper Size

Set from the operation panel.

Resolution

Set from the operation panel.

(2) Save Settings Area

File Name

Enter the file name of the image to be saved. When you save a file, the date and four digits are appended to the set file name in the "_20XX0101_0001" format.

▶▶▶ Note

- When you select the **Save to a subfolder with current date** checkbox, the date and four digits are appended to the set file name.

Save in

Displays the folder in which to save the scanned images. To change the folder, specify the destination folder in the dialog displayed by selecting **Add...** from the pop-up menu.

The default save folder is the **Pictures** folder.

Data Format

Set from the operation panel.

JPEG Image Quality

You can specify the image quality of JPEG files.

Save to a subfolder with current date

Select this checkbox to create a current date folder in the folder specified in **Save in** and save scanned images in it. The folder will be created with a name such as "20XX_01_01" (Year_Month_Date).

If this checkbox is not selected, files are saved directly in the folder specified in **Save in**.

(3) Application Settings Area

E-mail Client

Specify the e-mail client to use for attaching scanned images.

You can specify the e-mail client you want to start from the pop-up menu.

▶▶▶ Note

- Specify the e-mail client in the dialog displayed by selecting **Add...** from the pop-up menu.

Instructions

Opens this guide.

Defaults

You can restore the settings in the displayed screen to the default settings.

Settings (Attach to E-mail (Document)) Dialog

Click **Attach to E-mail (Document)** on the  (Scanning from the Operation Panel) tab to display the **Settings (Attach to E-mail (Document))** dialog.

In the **Settings (Attach to E-mail (Document))** dialog, you can specify how to respond when attaching images to an e-mail as documents after scanning them from the operation panel.

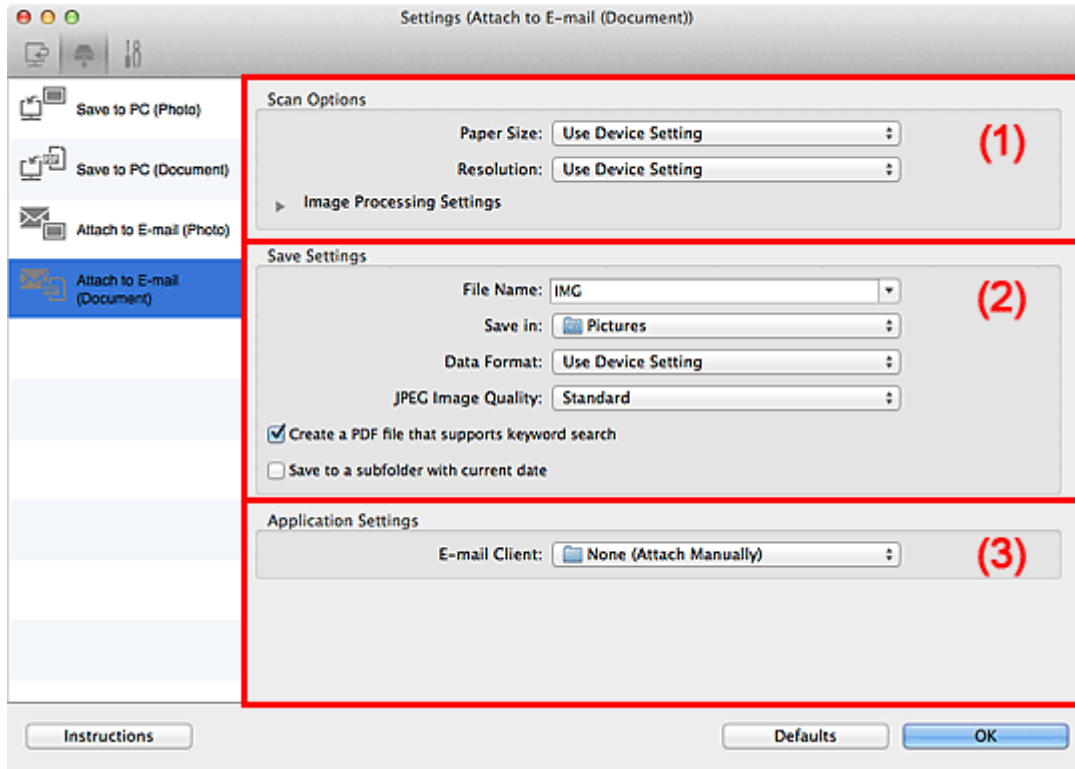

- [\(1\) Scan Options Area](#)
- [\(2\) Save Settings Area](#)
- [\(3\) Application Settings Area](#)

(1) Scan Options Area

Paper Size

Set from the operation panel.

Resolution

Set from the operation panel.

Image Processing Settings

Click  (Right Arrow) to set the following.

Apply Auto Document Fix

Select this checkbox to sharpen text in a document or magazine for better readability.

►►► Important

- The color tone may differ from the source image due to corrections. In that case, deselect the checkbox and scan.

►►► Note

- Scanning takes longer than usual when you enable this function.

Reduce gutter shadow (platen)

Reduces gutter shadows that appear between pages when scanning open booklets.

▶▶▶ Important

- This function is available only when scanning from the platen.

▶▶▶ Note

- When you enable this function, scanning may take longer than usual with network connection.

Correct slanted text document

Detects the scanned text and corrects the angle (within -0.1 to -10 degrees or +0.1 to +10 degrees) of the document.

▶▶▶ Important

- The following types of documents may not be corrected properly since the text cannot be detected correctly.
 - Documents in which the text lines are inclined more than 10 degrees or the angles vary by line
 - Documents containing both vertical and horizontal text
 - Documents with extremely large or small fonts
 - Documents with small amount of text
 - Documents containing figures/images
 - Hand-written text
 - Documents containing both vertical and horizontal lines (tables)

▶▶▶ Note

- Scanning takes longer than usual when you enable **Correct slanted text document**.

Detect the orientation of text document and rotate image

Automatically rotates the image to the correct orientation by detecting the orientation of text in the scanned document.

▶▶▶ Important

- Only text documents written in languages that can be selected from **Document Language** in the [Settings \(General Settings\) dialog](#) are supported.
- The orientation may not be detected for the following types of settings or documents since the text cannot be detected correctly.
 - Resolution is outside the range of 300 dpi to 600 dpi
 - Font size is outside the range of 8 points to 48 points
 - Documents containing special fonts, effects, italics, or hand-written text
 - Documents with patterned backgrounds

(2) Save Settings Area

File Name

Enter the file name of the image to be saved. When you save a file, the date and four digits are appended to the set file name in the "_20XX0101_0001" format.

»»» Note

- When you select the **Save to a subfolder with current date** checkbox, the date and four digits are appended to the set file name.

Save in

Displays the folder in which to save the scanned images. To change the folder, specify the destination folder in the dialog displayed by selecting **Add...** from the pop-up menu.

The default save folder is the **Pictures** folder.

Data Format

Set from the operation panel.

JPEG Image Quality

You can specify the image quality of JPEG files.

Create a PDF file that supports keyword search

Select this checkbox to convert text in images into text data and create PDF files that support keyword search.

»»» Note

- PDF files that are searchable in the language selected in **Document Language** on the  (General Settings) tab of the Settings dialog are created.

Save to a subfolder with current date

Select this checkbox to create a current date folder in the folder specified in **Save in** and save scanned images in it. The folder will be created with a name such as "20XX_01_01" (Year_Month_Date).

If this checkbox is not selected, files are saved directly in the folder specified in **Save in**.

(3) Application Settings Area

E-mail Client

Specify the e-mail client to use for attaching scanned images.

You can specify the e-mail client you want to start from the pop-up menu.

»»» Note

- Specify the e-mail client in the dialog displayed by selecting **Add...** from the pop-up menu.

Instructions

Opens this guide.

Defaults

You can restore the settings in the displayed screen to the default settings.

Settings (General Settings) Dialog

Click the  (General Settings) tab to display the **Settings (General Settings)** dialog.

In the **Settings (General Settings)** dialog, you can set the product to use, file size restriction on e-mail attachment, language to detect text in images, and folder in which to save images temporarily.

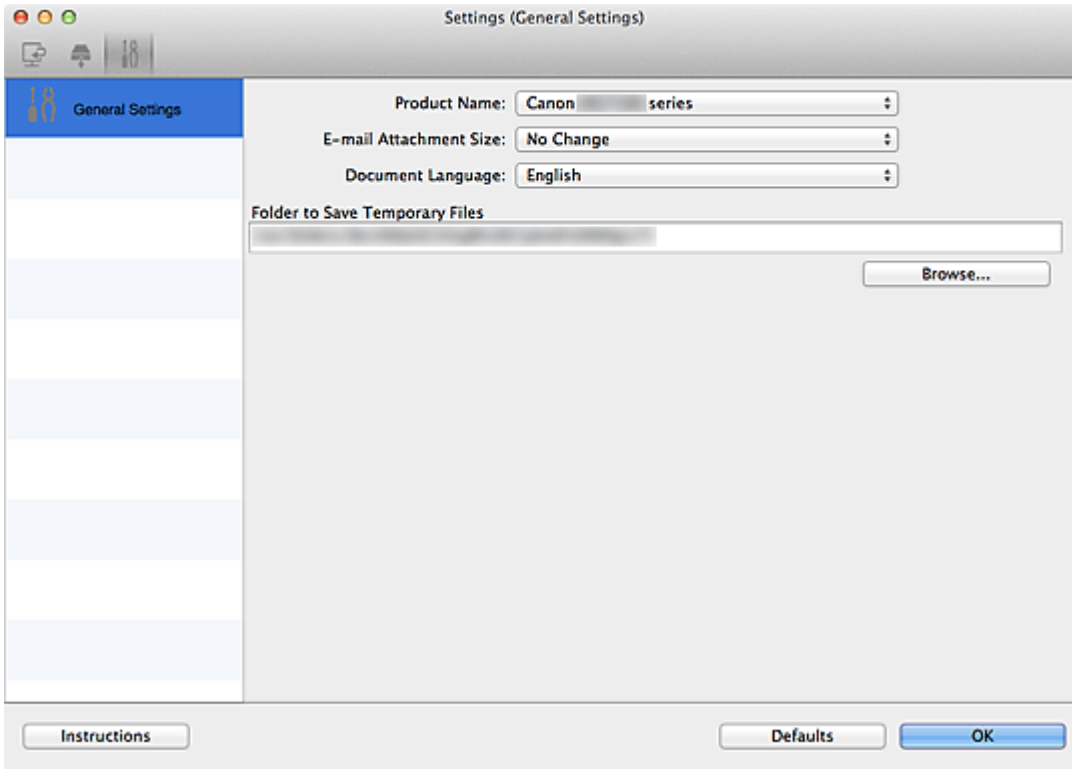

Product Name

Displays the name of the product that IJ Scan Utility is currently set to use.

If the displayed product is not the one you want to use, select the desired product from the list.

In addition, for network connection, select one with "Network" after the product name.

»»» Note

- With network connection, **Select** appears on the right side of the product name. Click **Select** to display the network selection screen in which you can change the scanner to use. Refer to "[Network Scan Settings](#)" for the setting procedure.

E-mail Attachment Size

You can restrict the size of scanned images to be attached to an e-mail.

You can select **Small (Suitable for 640 x 480 Windows)**, **Medium (Suitable for 800 x 600 Windows)**, **Large (Suitable for 1024 x 768 Windows)**, or **No Change**.

Document Language

Select the language for detecting text in images.

Folder to Save Temporary Files

Displays the folder in which to save images temporarily. Click **Browse...** to specify the destination folder.

Instructions

Opens this guide.

Defaults

You can restore the settings in the displayed screen to the default settings.

Network Selection Screen

You can select the scanners or printers to be used for scanning or printing over a network from your computer or the operation panel.

Network Selection Screen

In **Product Name** in the **Settings (General Settings)** dialog, select an item with "Network" after the product name from the list, then click **Select** that appears to the right of the product name to display the network selection screen.

Scanners

The Bonjour service names of the scanners or printers that can be used over the network are displayed.

You can select one scanner or printer per model. Selecting a scanner or printer automatically enables scanning from the operation panel.

»»» Important

- You cannot use over the network if Bonjour is disabled. Enable Bonjour on your scanner or printer.
- If you have changed the Bonjour service name after selecting your scanner or printer by Bonjour service name, reopen the network selection screen and select the new Bonjour service name from **Scanners**.

Instructions

Opens this guide.

Scan-from-Operation-Panel Settings

The Scan-from-Operation-Panel Settings screen appears. You can select up to three scanners and printers in total for scanning from the operation panel. You can scan items using the operation panel of the selected scanner or printer, and send the scanned images to your computer over a network.

»»» Important

- When using a model with which you cannot scan over a network from the operation panel, that model does not appear in **Scanners** and the setting is not available.

Scan-from-Operation-Panel Settings Screen

Click **Scan-from-Operation-Panel Settings** in the network selection screen to display the Scan-from-Operation-Panel Settings screen.

Scanners

The Bonjour service names of the scanners or printers that can be used over the network are displayed.

You can select up to three scanners and printers in total at the same time.

»»» Important

- You cannot use over the network if Bonjour is disabled. Enable Bonjour on your scanner or printer.

- If you have changed the Bonjour service name after selecting your scanner or printer by Bonjour service name, reopen the network selection screen and select the new Bonjour service name from **Scanners**.

»» Note

- If the Bonjour service name of your scanner or printer does not appear or cannot be selected, check the following, click **OK** to close the screen, then reopen it and try selecting again.
 - The scanner driver is installed
 - Network settings of your scanner or printer is completed after installing the scanner driver
 - Network communication between your scanner or printer and computer is enabledIf your scanner or printer still does not appear, refer to "Problems with Network Communication" for your model from Home of the *Online Manual*.

Save Settings Dialog

Select the **Check scan results** checkbox in **Save Settings** of the Settings dialog to display the **Save Settings** dialog after scanning.

You can specify the data format and destination while viewing the thumbnails of scan results.

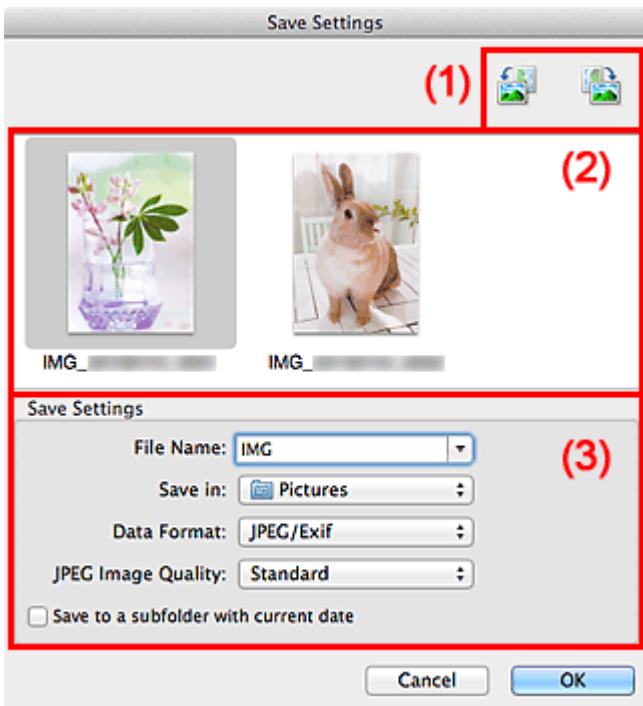

- [\(1\) Preview Operation Buttons](#)
- [\(2\) Scan Results Area](#)
- [\(3\) Save Settings Area](#)

(1) Preview Operation Buttons

 /  (Rotate Left 90°)/(Rotate Right 90°)

Rotates scanned images 90 degrees counter-clockwise or clockwise.

Select the image you want to rotate, then click  (Rotate Left 90°) or  (Rotate Right 90°).

»»» Important

- The preview operation buttons do not appear when the **Enable large image scans** checkbox is selected in the **Settings (Driver)** dialog.

(2) Scan Results Area

Displays the thumbnails of the scanned images. You can change the save order of images via drag-and-drop. The file names for saving appear below the thumbnails.

(3) Save Settings Area

File Name

Enter the file name of the image to be saved. When you save a file, the date and four digits are appended to the set file name in the "_20XX0101_0001" format.

►►► Note

- When you select the **Save to a subfolder with current date** checkbox, the date and four digits are appended to the set file name.

Save in

Displays the folder in which to save the scanned images. To change the folder, specify the destination folder in the dialog displayed by selecting **Add...** from the pop-up menu.

The default save folder is the **Pictures** folder.

Data Format

Select the data format in which to save the scanned images.

You can select **JPEG/Exif**, **TIFF**, **PNG**, **PDF**, or **PDF (Multiple Pages)**.

►►► Important

- You cannot select **PDF** or **PDF (Multiple Pages)** in the following cases.
 - When scanned by clicking **Photo** in the IJ Scan Utility main screen
 - The **Enable large image scans** checkbox is selected in **Save Settings** of the **Settings (Driver)** dialog
 - **Start OCR** is selected in **Application Settings** of the **Settings (Document Scan)**, **Settings (Custom Scan)**, or **Settings (Driver)** dialog
- You cannot select **JPEG/Exif** when **Color Mode** is **Black and White**.

►►► Note

- With network connection, scanning may take longer than usual when you set **TIFF** or **PNG** in **Data Format**.

JPEG Image Quality

You can specify the image quality of JPEG files.

►►► Important

- This appears only when **JPEG/Exif** is selected in **Data Format**.

PDF Compression

Select the compression type for saving PDF files.

Standard

It is recommended that you normally select this setting.

High

Compresses the file size when saving, allowing you to reduce the load on your network/server.

►►► Important

- This appears only when **PDF** or **PDF (Multiple Pages)** is selected in **Data Format**.
- When **Black and White** is selected in **Color Mode**, this option does not appear.

Create a PDF file that supports keyword search

Select this checkbox to convert text in images into text data and create PDF files that support keyword search.

►►► Important

- This appears only when **PDF** or **PDF (Multiple Pages)** is selected in **Data Format**.

»» Note

- PDF files that are searchable in the language selected in **Document Language** on the  (General Settings) tab of the Settings dialog are created.

Save to a subfolder with current date

Select this checkbox to create a current date folder in the folder specified in **Save in** and save scanned images in it. The folder will be created with a name such as "20XX_01_01" (Year_Month_Date).

If this checkbox is not selected, files are saved directly in the folder specified in **Save in**.

Image Stitch Window

Click **Stitch** in the IJ Scan Utility main screen to display the **Image Stitch** window.

You can scan the left and right halves of an item larger than the platen and combine them back into one image. You can scan items up to approximately twice as large as the platen.

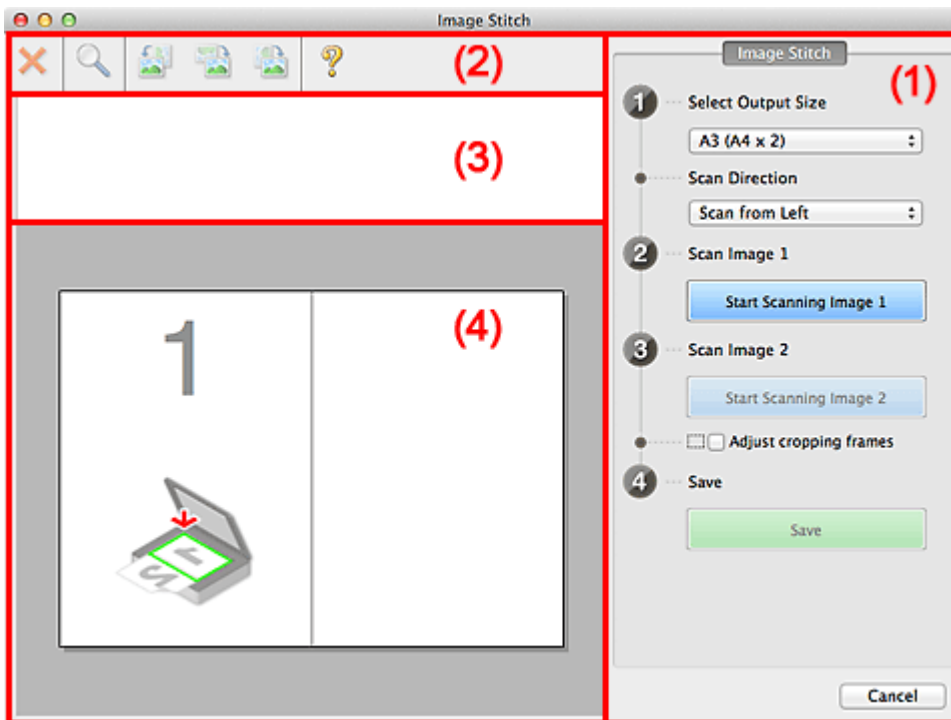

- [\(1\) Settings and Operation Buttons](#)
- [\(2\) Toolbar](#)
- [\(3\) Thumbnail View Area](#)
- [\(4\) Preview Area](#)

►►► Note

- The displayed items vary depending on the select source and view.

(1) Settings and Operation Buttons

Select Output Size

B4 (B5 x 2)

Scans the left and right halves of a B4 size item separately.

A3 (A4 x 2)

Scans the left and right halves of an A3 size item separately.

11 x 17 (Letter x 2)

Scans the left and right halves of an item twice as large as Letter size separately.

Full Platen x 2

Scans the left and right halves of an item twice as large as the platen separately.

Scan Direction

Scan from Left

Displays the first scanned image on the left side.

Scan from Right

Displays the first scanned image on the right side.

Scan Image 1

Start Scanning Image 1

Scans the first item.

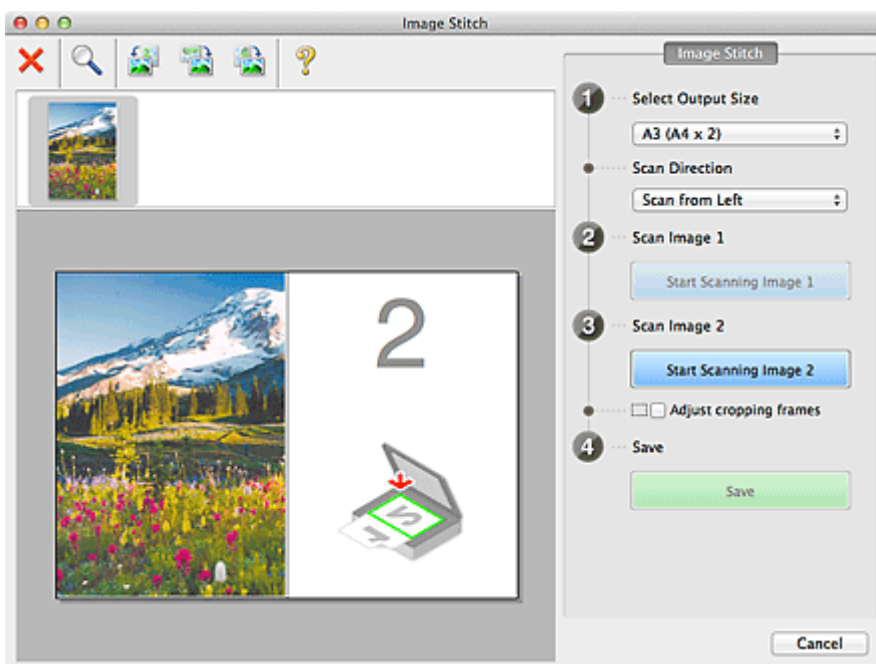

Scan Image 2

Start Scanning Image 2

Scans the second item.

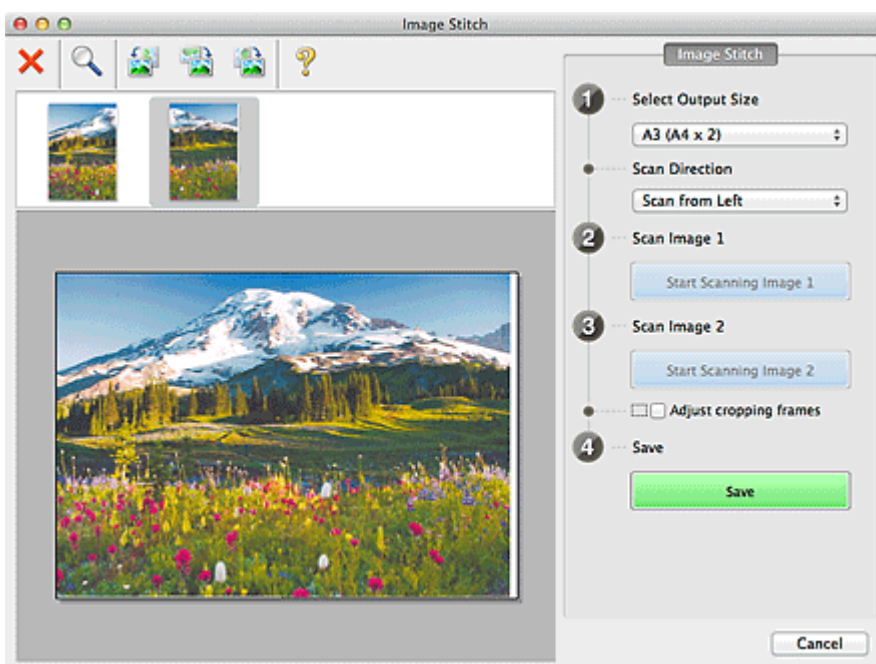

Adjust cropping frames

You can adjust the scan area in preview.

If no area is specified, the image of the size selected in **Select Output Size** will be saved. If an area is specified, only the image in the cropping frame will be scanned and saved.

■ [Adjusting Cropping Frames in the Image Stitch Window](#)

Save

Save

Saves the two scanned images as one image.

Cancel

Cancels **Stitch** scan.

(2) Toolbar

You can delete the scanned images or adjust the previewed images.



(Delete)

Deletes the scanned image.



(Enlarge/Reduce)

Allows you to enlarge or reduce the preview image.

Left-clicking the Preview area enlarges the displayed image.

Control-clicking the Preview area reduces the displayed image.



(Rotate Left)

Rotates the preview image 90 degrees counter-clockwise.



(Invert Vertically)

Rotates the preview image 180 degrees.



(Rotate Right)

Rotates the preview image 90 degrees clockwise.



(Open Guide)

Opens this page.

(3) Thumbnail View Area

Displays the thumbnails of the scanned images. Appears blank if none has been scanned.

(4) Preview Area

Displays the scanned images. You can adjust the layout by dragging the scanned image or check the results of the settings made in "[\(1\) Settings and Operation Buttons.](#)"

When no image has been scanned:

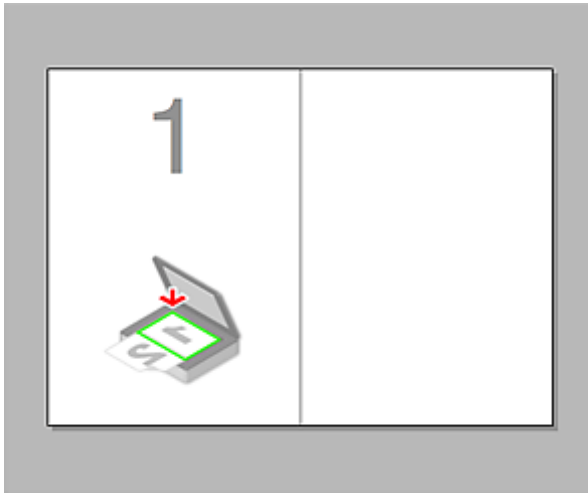

After scanning the first item by clicking Start Scanning Image 1:



The image is scanned in the direction specified in **Scan Direction**, and **2** appears next to it.

After scanning the second item by clicking Start Scanning Image 2:



The two scanned images appear.

Related Topic

- [Scanning Items Larger than the Platen \(Image Stitch\)](#)

Scanning with Scanner Driver

You can scan by starting the scanner driver from various applications.

Refer to Help of Mac OS for how to scan.

▶▶ Important

- When scanning with the scanner driver in Mac OS X v10.6.8, select **JPEG** or **TIFF** in **Format**. Scanned images are saved in the format set in **Data Format** in the [Settings \(Driver\) dialog](#) of IJ Scan Utility.

▶▶ Note

- Refer to "[Image Corrections and Color Adjustments](#)" for details on the setting procedures for image correction and color adjustment.
- Refer to "[General Notes \(Scanner Driver\)](#)" for the scanner driver.
- Refer to "[Updating the Scanner Driver](#)" for the scanner driver.
- In the [Settings \(Driver\) dialog](#) of IJ Scan Utility, you can also make advanced settings for scanning with the scanner driver.

Image Corrections and Color Adjustments

You can correct images and adjust colors using the scanner driver.

Important

- When image correction or color adjustment is applied to items without moire, dust/scratches, or faded colors, the color tone may be adversely affected.
- Image correction results are not reflected in the trial scan screen.

Note

- Screens may vary depending on the application.
- Selectable settings depend on **Kind** settings.
- Scanning may take longer than usual when image correction or color adjustment is applied.

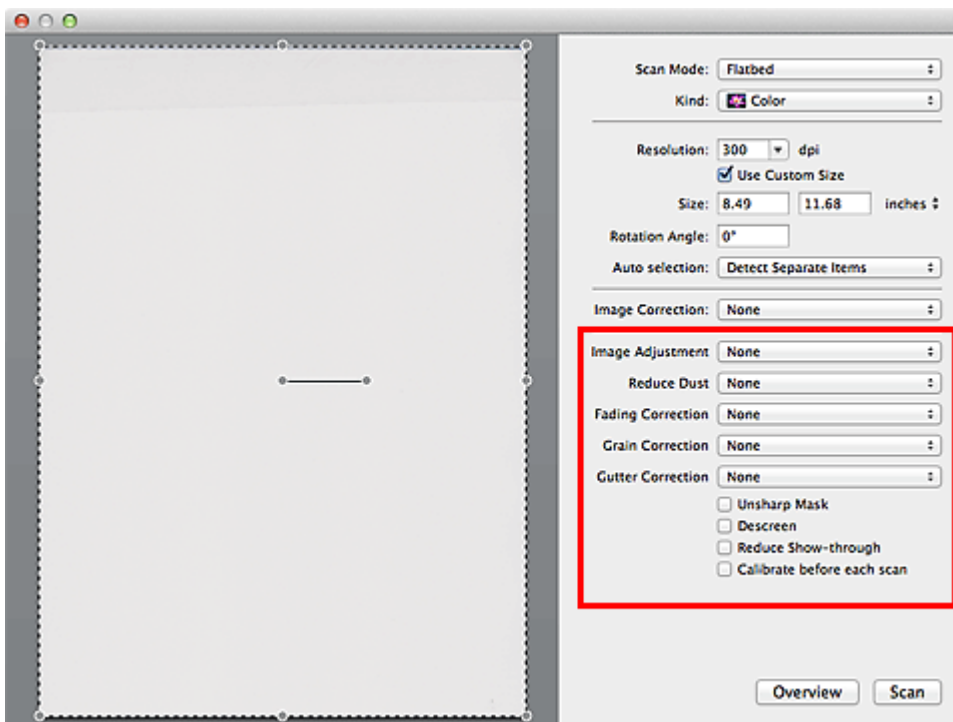

Image Adjustment

When Image Adjustment is set, the brightness of the specified portion of the image is optimized. Images can be adjusted according to the automatically detected item type or the specified item type. The result of the adjustment will be reflected in the entire image.

None

Image Adjustment will not be applied.

Auto

Applies Image Adjustment by automatically detecting the item type. It is recommended that you normally select this setting.

Photo

Applies Image Adjustment suitable for photos.

Magazine

Applies Image Adjustment suitable for magazines.

Document

Applies Image Adjustment suitable for text documents.

»» Note

- If the image is not adjusted properly with **Auto**, specify the item type.
- The color tone may change from the source image due to the Image Adjustment. In that case, set **Image Adjustment** to **None**.

Reduce Dust

Scanned photos may contain white dots caused by dust or scratches. Use this function to reduce such noise.

None

Dust and scratches will not be reduced.

Low

Select this to reduce small dust particles and scratches. Large ones may remain.

Medium

It is recommended that you normally select this setting.

High

Select this to reduce large dust particles and scratches; however, evidence of the reduction process may remain or delicate parts of the image may be removed.

»» Important

- This function may not be effective for some types of photos.

»» Note

- It is recommended that you select **None** when scanning printed materials.

Fading Correction

Use this function to correct photos that have faded with time or have a colorcast. "Colorcast" is a phenomenon where a specific color affects the entire picture due to the weather or ambient strong colors.

None

Fading Correction will not be applied.

Low

Select this to correct a small amount of fading and colorcast.

Medium

It is recommended that you normally select this setting.

High

Select this to correct a large amount of fading and colorcast. This can affect the tone of the image.

»» Important

- Correction may not be applied properly if the scan area is too small.
- Not effective if **Color** is not selected for **Kind**.

Grain Correction

Use this function to reduce graininess (roughness) in photos taken with high-speed or sensitized film, etc.

None

Graininess will not be reduced.

Low

Select this when the photo is slightly grainy.

Medium

It is recommended that you normally select this setting.

High

Select this when the photo is very grainy. This can affect the gradation and sharpness of the image.

»» Important

- Correction may not be applied properly if the scan area is too small.

Gutter Correction

Use this function to correct shadows that appear between pages when scanning open booklets.

Unclear or blurred text/lines caused by curved pages are not corrected.

None

Gutter shadow will not be corrected.

Low

Select this when the effect level is too strong with the medium setting.

Medium

It is recommended that you normally select this setting.

High

Select this when the effect level is too weak with the medium setting.

»» Important

- Do not place objects that weigh 4.4 lbs (2.0 kg) or more on the platen. In addition, do not press on the item with a force exceeding 4.4 lbs (2.0 kg). If you press heavily, the scanner may not work correctly or you might break the glass.
- Align the item with the edge of the platen. If placed slanted, correction will not be applied properly.



- Correction may not be applied properly depending on the item. If the page background is not white, shadows may not be detected correctly or may not be detected at all.
- While scanning, press down on the spine with the same amount of pressure you used to preview the scan. If the binding part is not even, correction will not be applied properly.



- How to place the item depends on your model and the item to be scanned.

Unsharp Mask

Emphasizes the outline of the subjects to sharpen the image.

Descreen

Reduces moire patterns.

Printed materials are displayed as a collection of fine dots. "Moire" is a phenomenon where uneven gradation or a stripe pattern appears when such photos or pictures printed with fine dots are scanned.

►►► Important

- When enabling **Descreen**, disable **Unsharp Mask**. If **Unsharp Mask** is enabled, some moire effects may remain.

►►► Note

- Scanning takes longer than usual when you enable **Descreen**.

Reduce Show-through

Use this function to reduce show-through in duplex documents or lighten the base color in recycled paper and other colored paper when scanning documents.

►►► Important

- **Reduce Show-through** is effective only when **Document** or **Magazine** is selected for **Image Adjustment**.

Calibrate before each scan

Calibrates the scanner every time before trial scanning and scanning, to reproduce correct color tones in scanned images.

►►► Note

- Calibration may take time depending on your computer.

General Notes (Scanner Driver)

The scanner driver is subject to the following restrictions. Keep these points in mind when using the scanner driver.

Scanner Driver Restrictions

- If the computer is shared among multiple users or when you have logged out and back on, a message indicating that the scanner driver is in use may appear. In that case, disconnect the USB cable from the computer, then reconnect it.
- Scanning may fail if the computer has resumed from sleep state with the scanner driver active. In that case, follow these steps and scan again.
 1. Turn off the machine.
 2. Exit the scanner driver, then disconnect the USB cable from the computer and reconnect it.
 3. Turn on the machine.
- Do not connect two or more scanners or multifunction printers with scanner function to the same computer simultaneously. If multiple scanning devices are connected, you cannot scan from the operation panel of the machine and also may experience errors while accessing the devices.
- When using a network compatible model by connecting to a network, the machine cannot be accessed from multiple computers at the same time.
- When using a network compatible model by connecting to a network, scanning takes longer than usual.
- Make sure that you have adequate disk space available when scanning large images at high resolutions. For example, at least 300 MB of free space is required to scan an A4 document at 600 dpi in full-color.
- Do not enter the computer into sleep or hibernate state during scanning.

Updating the Scanner Driver

- **Obtaining the Latest Scanner Driver**
- **Before Installing the Scanner Driver**
- **Installing the Scanner Driver**

Obtaining the Latest Scanner Driver

Upgrading your current scanner driver to the latest scanner driver may solve some problems you have experienced.

To obtain the scanner driver, access our website and download the scanner driver for your model.

Important

- Scanner driver can be downloaded for free; however, Internet connection fees apply.

Related Topic

- [Before Installing the Scanner Driver](#)
- [Installing the Scanner Driver](#)

Before Installing the Scanner Driver

Check the following points before installing the scanner driver. Check these also when you cannot install the scanner driver.

Machine Status

- If the machine and computer are connected with a USB cable, disconnect the USB cable from the computer.

Computer Settings

- Close all running applications.
- Log in as the administrator of the computer. You will be required to enter the name and password of the user with administrator privileges. If you have multiple user accounts on Mac OS X, log in with the first administrator account created.

►► Important

- If you install an older version of the scanner driver after installing a newer one, the scanner driver may not operate properly. In that case, reinstall the newer scanner driver.

►► Note

- When installing multiple versions of the scanner driver, install the older scanner driver first.

Related Topic

- [Obtaining the Latest Scanner Driver](#)
- [Installing the Scanner Driver](#)

Installing the Scanner Driver

Access our website via the Internet to download the latest scanner driver.

Follow these steps to install the downloaded scanner driver.

1. Mount the disk.

Double-click the downloaded disk image file.

The file is decompressed and the disk is mounted.

2. Start the installer.

Double-click the ".pkg" file in the decompressed disk.

Installation starts.

3. Install the driver.

Follow the prompts to install.

When the license agreement screen appears, read the terms and click **Continue**. If you do not accept the license agreement, you cannot install this software.

If an authentication screen appears, enter the administrator's name and password, then click **Install Software**.

4. Complete the installation.

The scanner driver is installed.

Set up the network environment if you have more than one scanner or have a network compatible model and changed the connection from USB connection to network connection.

Refer to "[Network Scan Settings](#)" for the setting procedure.

Important

- Installation may fail if you click **Go Back** during the process. In that case, select **Quit Installer** from the **Installer** menu to exit the installer, then start over the installation.
- Scanner driver can be downloaded for free; however, Internet connection fees apply.

Related Topic

- [Obtaining the Latest Scanner Driver](#)
- [Before Installing the Scanner Driver](#)

Useful Information on Scanning

- ▶ [Adjusting Cropping Frames in the Image Stitch Window](#)
- ▶ [Resolution](#)
- ▶ [Data Formats](#)

Adjusting Cropping Frames in the Image Stitch Window

"Cropping" is the act of selecting the area you want to keep in an image and discarding the rest when scanning it.

In the **Image Stitch** window, you can specify a cropping frame on the image displayed in the Preview area.

▶▶▶ Note

- Refer to Help of Image Capture for how to adjust the cropping frames (selection boxes) in the screen displayed by clicking **Driver** in the IJ Scan Utility main screen.

Initial Cropping Frame

No cropping frame is specified. When you select the **Adjust cropping frames** checkbox, an active cropping frame is automatically specified around the image in the Preview area. You can drag the cropping frame to specify the area.

When you perform a scan, the image in the area specified with the cropping frame will be scanned.

Adjusting a Cropping Frame

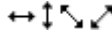
The cursor will change into  (Arrow) when it is positioned over a cropping frame. Click and drag the mouse to expand or contract the cropping frame.



The cursor will change into  (Hand) when it is positioned within a cropping frame. Click and drag the mouse to move the entire cropping frame.



Deleting Cropping Frames

To delete the cropping frame, deselect the **Adjust cropping frames** checkbox.

Resolution

The data in the image you have scanned is a collection of dots carrying information about brightness and color. The density of these dots is called "resolution", and resolution will determine the amount of detail your image contains. The unit of resolution is dots per inch (dpi). Dpi is the number of dots per inch (2.5 cm).

The higher the resolution (value), the more detail in your image; the lower the resolution (value), the less detail.



How to Set the Resolution

You can set the resolution in **Resolution** on the  (Scanning from a Computer) tab of the Settings dialog.

Appropriate Resolution Settings

Set the resolution according to the use of the scanned image.

Item Type	Use	Color Mode	Appropriate Resolution
Color photo	Copying (Printing)	Color	300 dpi
	Creating a postcard	Color	300 dpi
	Saving to a computer	Color	300 dpi
	Using on a website or attaching to e-mail	Color	150 dpi
Black and white photo	Saving to a computer	Grayscale	300 dpi
	Using on a website or attaching to e-mail	Grayscale	150 dpi
Text document (document or magazine)	Copying	Color, Grayscale, or Black and White	300 dpi
	Attaching to e-mail	Color, Grayscale, or Black and White	150 dpi
	Scanning text using OCR	Color or Grayscale	300 dpi

►►► Important

- If you double the resolution, the data size of the scanned image quadruples. If the file is too large, the processing speed will slow down significantly, and you will experience inconvenience such as lack of memory. Set the minimum required resolution according to the use of the image.

»» Note

- When you will be printing the scanned image by enlarging it, scan by setting a higher resolution than the recommended one above.

Data Formats

You can select a data format when saving scanned images. You should specify the most suitable data format according to how you want to use the image on which application.

Available data formats vary by application and operating system (Windows or Mac OS).

See below for the characteristics of each image data format.

PNG (Standard File Extension: .png)

A data format often used on websites.

PNG is suitable for editing saved images.

JPEG (Standard File Extension: .jpg)

A data format often used on websites and for digital camera images.

JPEG features high compression rates. JPEG images slightly degrade every time they are saved, and cannot be returned to their original state.

JPEG is not available for black and white images.

TIFF (Standard File Extension: .tif)

A data format featuring a relatively high compatibility between various computers and applications.

TIFF is suitable for editing saved images.

»» Note

- Some TIFF files are incompatible.
- IJ Scan Utility supports the following TIFF file formats.
 - Uncompressed, black and white binary
 - Uncompressed, RGB (8 bits per channel)
 - Uncompressed, Grayscale

PDF (Standard File Extension: .pdf)

A data format for electronic documents, developed by Adobe Systems Incorporated.

It can be used on various computers and operating systems, and fonts can be embedded as well; therefore, people in different environments can exchange the files without being aware of the differences.

Placing Items (When Scanning from a Computer)

Learn how to place items on the platen or ADF (Auto Document Feeder) of your scanner or printer. Place items correctly according to the type of item to be scanned. Otherwise, items may not be scanned correctly.

▶▶▶ Important

- Do not place objects on the document cover. When you open the document cover, the objects may fall into your scanner or printer, resulting in malfunction.
- Close the document cover when scanning.
- Do not touch the operation panel buttons or LCD (Liquid Crystal Display) monitor when opening/closing the document cover. May result in unintended operation.

■ [Placing Items \(Platen\)](#)

■ [Placing Documents \(ADF \(Auto Document Feeder\)\)](#)

Placing Items (Platen)

Place items as described below to scan by detecting the item type or size automatically.

▶▶▶ Important

- When scanning by specifying the paper size in IJ Scan Utility or the scanner driver, align an upper corner of the item with the corner at the arrow (alignment mark) of the platen.
- Photos that have been cut to various shapes and items smaller than 1.2 inches (3 cm) square cannot be cropped accurately when scanning.
- Reflective disc labels may not be scanned as expected.
- When scanned using the scanner driver, the response may differ. In that case, adjust the cropping frame (selection box) manually.

For Photos, Postcards, Business Cards, or BD/DVD/CD	For Magazines, Newspapers, or Documents
<div data-bbox="220 1301 724 1424"> </div> <p data-bbox="188 1473 440 1507">Placing a Single Item:</p> <p data-bbox="188 1525 807 1659">Place the item face-down on the platen, with 0.4 inch (1 cm) or more space between the edges (diagonally striped area) of the platen and the item. Portions placed on the diagonally striped area cannot be scanned.</p> <div data-bbox="188 1675 695 2047"> </div>	<div data-bbox="927 1301 1305 1424"> </div> <p data-bbox="839 1462 1417 1597">Place the item face-down on the platen and align an upper corner of the item with the corner at the arrow (alignment mark) of the platen. Portions placed on the diagonally striped area cannot be scanned.</p> <div data-bbox="839 1615 1347 1984"> </div>

▶▶▶ Important

- Large items (such as A4 size photos) that cannot be placed away from the edges/arrow (alignment mark) of the platen may be saved as PDF files. To save in a format other than PDF, scan by specifying the data format.

Placing Multiple Items:

Allow 0.4 inch (1 cm) or more space between the edges (diagonally striped area) of the platen and items, and between items. Portions placed on the diagonally striped area cannot be scanned.

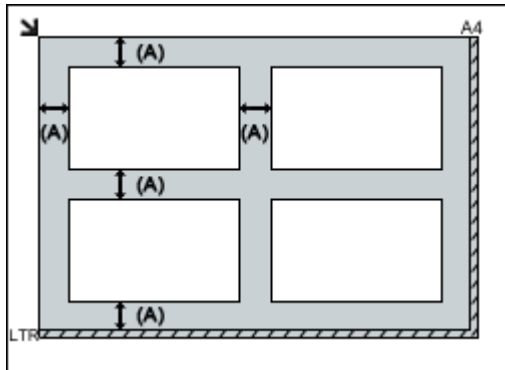

(A) more than 0.4 inch (1 cm)

▶▶▶ Note

- In IJ Scan Utility, you can place up to 12 items.
- Positions of slanted items (10 degrees or less) are corrected automatically.

▶▶▶ Important

- Refer to "Loading Originals" for your model from Home of the *Online Manual* for details on the portions in which items cannot be scanned.

Placing Documents (ADF (Auto Document Feeder))

▶▶▶ Important

- Do not leave thick items on the platen when scanning from the ADF. May result in paper jam.
- Place and align documents of the same size when scanning two or more documents.
- Refer to "Originals You Can Load" for your model from Home of the *Online Manual* for details on supported document sizes when scanning from the ADF.

1. Open the document tray.



2. Place the documents on the ADF, then adjust the document guides to the width of the documents.

Insert the documents face-up until a beep sounds.

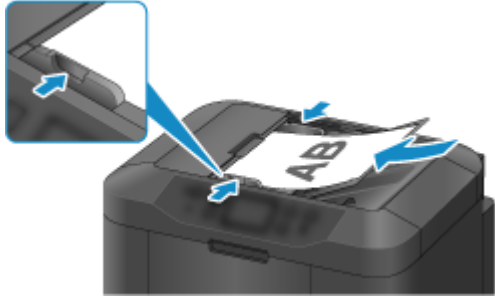

Scanning from the Operation Panel of the Machine

- **Forwarding Scanned Data to the Computer Using the Operation Panel of the Machine** 📄 **Basic**
- **Attaching the Scanned Data to E-mail Using the Operation Panel of the Machine**
- **Saving Scanned Data on the USB Flash Drive Using the Operation Panel of the Machine**
- **Forwarding Scanned Data to Shared Folder on the Computer Using the Operation Panel of the Machine**
- **Deleting Scanned Data on USB Flash Drive**
- **Setting Items for Scanning Using the Operation Panel of the Machine**
- **Network Scan Settings**
- **Selecting a Response to Commands from the Operation Panel Using IJ Scan Utility**

Forwarding Scanned Data to the Computer Using the Operation Panel of the Machine

Before forwarding scanned data to the computer, confirm the following:

- **The scanner driver is installed.**

If the scanner driver is not yet installed, install the scanner driver from our website.

- **The machine is connected to a computer correctly.**

Make sure that the machine is connected to the computer correctly.

Do not plug in or unplug the USB cable or LAN cable while the machine is in operation, or when the computer is in the sleep or standby mode.

If you perform scanning via a network connection, make sure that all the required settings have been specified.

■ [Network Scan Settings](#)

- **The destination and the file name are specified in Canon IJ Scan Utility.**

You can specify the destination and the file name in Canon IJ Scan Utility. For details on settings of Canon IJ Scan Utility:

■ [Settings Dialog](#)

1. [Make sure that the machine is turned on.](#)

2. Flick the HOME screen, then tap  **Scan**.

■ [Using the Operation Panel](#)

The screen for selecting to which you save the data is displayed.

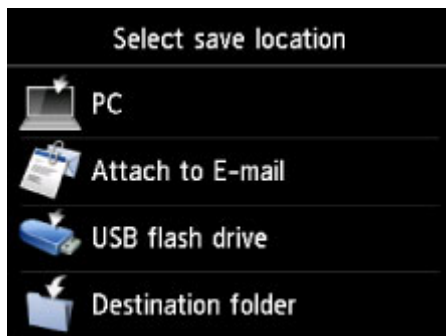

3. Tap  **PC**.

4. Tap the computer to forward the scanned data.

Tap **Local (USB)** for a USB-connected computer, or tap the computer to forward the scanned data for a network-connected computer.



The Scan standby screen is displayed.

▶▶▶ Note

- When you forward the scanned data to the computer using WSD (one of the network protocols supported in Windows 8.1, Windows 8, Windows 7, and Windows Vista), select **Enable** for **WSD scan from this device** on **WSD setting** on **Other settings** in **LAN settings** under **Device settings**.

■ [WSD setting](#)

If you tap **Search again**, the machine starts searching for the connected computers again.

5. Specify the settings as necessary.

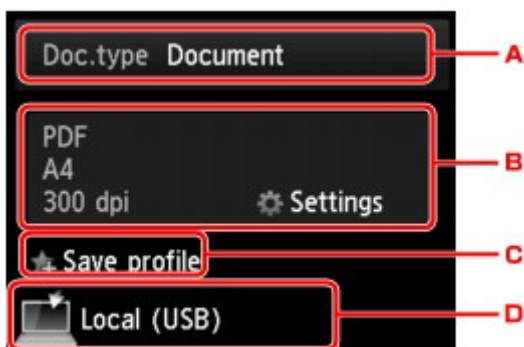

A. Tap to select the document type.

▶▶▶ Note

- When you forward the scanned data to the computer searched using WSD, you cannot select the document type.

Document

Scans the original on the platen glass or in the ADF as a document data applying the settings specified in **Scan settings**.

Photo

Scans the original on the platen glass as a photo data applying the settings specified in **Scan settings**.

B. Tap to display **Scan settings** screen.

For details on the setting items:

■ [Setting Items for Scanning Using the Operation Panel of the Machine](#)

C. Tap to register the current scan settings as a custom setting.

■ [Registering the Favorite Settings \(Custom profiles\)](#)

D. Tap to display the screen to select the destination.

6. [Load the original document on the platen glass or in the ADF.](#)

7. Press the **Color** button for color scanning, or the **Black** button for black & white scanning.

▶▶▶ Note

- When you forward the scanned data to the computer using WSD, press the **Color** button.
- If the original is not loaded properly, a message is displayed on the touch screen. Load the original on the platen glass or in the ADF according to the scan settings.

- **If you load the original in the ADF:**

The machine starts scanning and scanned data is forwarded to the computer.

- **If you load the original on the platen glass:**

- When you select **JPEG** or **TIFF** for **Format** on the scan setting screen, the machine starts scanning and scanned data is forwarded to the computer.
- When you select **PDF** or **Compact PDF** for **Format** on the scan setting screen, the confirmation screen asking you if you continue scanning is displayed after scanning is complete.

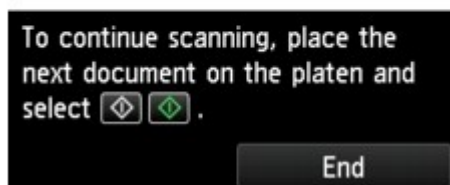

If you continue scanning, load the original on the platen glass and start scanning.

If you do not continue scanning, tap **End**. The scanned data is forwarded to the computer.

Scanned data is forwarded to the computer according to the settings specified in Canon IJ Scan Utility.

Remove the original on the platen glass or from the document output slot after scanning is complete.

If you want to scan originals with advanced settings, or if you want to edit or print the scanned images:

If you scan originals from a computer, you can edit the scanned images, such as optimizing or trimming.

In addition, you can edit or print the scanned images using the compatible application software to make better use of them.

■ [Scanning with IJ Scan Utility](#)

Attaching the Scanned Data to E-mail Using the Operation Panel of the Machine

Before attaching scanned data to an e-mail, confirm the following:

- **The scanner driver is installed.**

If the scanner driver is not yet installed, install the scanner driver from our website.

- **The machine is connected to a computer correctly.**

Make sure that the machine is connected to the computer correctly.

Do not plug in or unplug the USB or LAN cable while the machine is in operation, or when the computer is in the sleep or standby mode.

If you perform scanning via a network connection, make sure that all the required settings have been specified.

■ [Network Scan Settings](#)

- **The mail software and the file name are specified in Canon IJ Scan Utility.**

You can specify the destination and the file name in Canon IJ Scan Utility. For details on settings of Canon IJ Scan Utility:

■ [Settings Dialog](#)

1. [Make sure that the machine is turned on.](#)

2. Flick the HOME screen, then tap  **Scan**.

■ [Using the Operation Panel](#)

The screen for selecting to which you save the data is displayed.

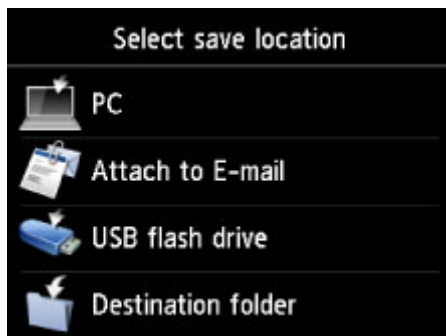

3. Tap  **Attach to E-mail**.

4. Tap the computer to forward the scanned data.

Tap **Local (USB)** for a USB-connected computer, or tap the computer to forward the scanned data for a network-connected computer.



The Scan standby screen is displayed.

5. Specify the settings as necessary.



A. Tap to select the document type.

Document

Scans the original on the platen glass or in the ADF as a document data applying the settings specified in **Scan settings**.

Photo

Scans the original on the platen glass as a photo data applying the settings specified in **Scan settings**.

B. Tap to display **Scan settings** screen.

For details on the setting items:

■ [Setting Items for Scanning Using the Operation Panel of the Machine](#)

C. Tap to register the current scan settings as a custom setting.

■ [Registering the Favorite Settings \(Custom profiles\)](#)

D. Tap to display the screen to select the destination.

6. [Load the original document on the platen glass or in the ADF.](#)

7. Press the **Color** button for color scanning, or the **Black** button for black & white scanning.

▶▶▶ **Note**

- If the original is not loaded properly, a message is displayed on the touch screen. Load the original on the platen glass or in the ADF according to the scan settings.

- **If you load the original in the ADF:**

The machine starts scanning and scanned data is forwarded to the computer and attached to an e-mail.

- **If you load the original on the platen glass:**

- When you select **JPEG** for **Format** on the scan setting screen, the machine starts scanning and scanned data is forwarded to the computer and attached to an e-mail.
- When you select **PDF** or **Compact PDF** for **Format** on the scan setting screen, the confirmation screen asking you if you continue scanning is displayed after scanning is complete.

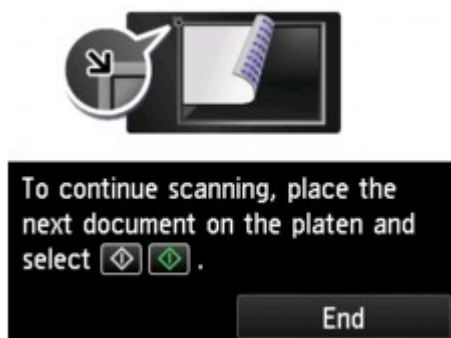

If you continue scanning, load the original on the platen glass and start scanning.

If you do not continue scanning, tap **End**. The scanned data is forwarded to the computer.

Scanned data is forwarded to the computer and attached to an e-mail according to the settings specified in Canon IJ Scan Utility.

For the settings or how to send an e-mail, refer to the mail software's instruction manual.

Remove the original on the platen glass or from the document output slot after scanning is complete.

Saving Scanned Data on the USB Flash Drive Using the Operation Panel of the Machine

You can save scanned data on the USB flash drive directly.

▶▶▶ Important

- Do not remove the USB flash drive from the machine under the following conditions:
 - While scanning is in progress
 - Before saving the scanned data
- For safety reasons, we recommend backing up the scanned data saved on a USB flash drive to another media periodically to avoid unexpected accidents.
- We assume no responsibility for damage to or loss of data for whatever reason even within the warranty period.

1. [Make sure that the machine is turned on.](#)

2. Flick the HOME screen, then tap  **Scan**.

■ ■ [Using the Operation Panel](#)

The screen for selecting to which you save the data is displayed.



3. [Insert the USB flash drive into the USB flash drive port.](#)

4. Tap  **USB flash drive**.

▶▶▶ Note

- When the message informing you that the operation restriction is enabled, ask the administrator of the machine you are using.

For details on the operation restriction of the machine:

■ ■ [About the Machine Administration](#)

5. Tap  **Save to USB flash drive**.

The Scan standby screen is displayed.

6. Adjust the settings as necessary.

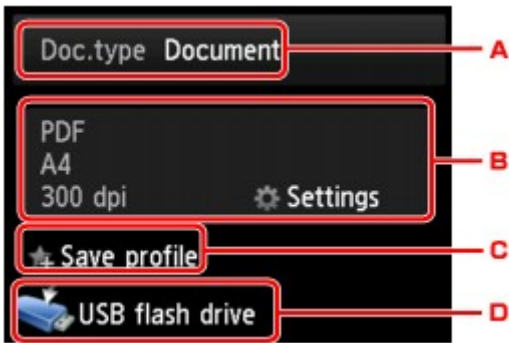

A. Tap to select the document type.

Document

Scans the original on the platen glass or the ADF as a document data applying the settings specified in **Scan settings**.

Photo

Scans the original on the platen glass as a photo data applying the settings specified in **Scan settings**.

B. Tap to display **Scan settings** screen.

For details on the setting items:

■ [Setting Items for Scanning Using the Operation Panel of the Machine](#)

C. Tap to register the current scan settings as a custom setting.

■ [Registering the Favorite Settings \(Custom profiles\)](#)

D. Tap to display the screen to select the destination.

7. [Load the original document on the platen glass or in the ADF.](#)

8. Press the **Color** button for color scanning, or the **Black** button for black & white scanning.

▶▶▶ **Note**

- If the original is not loaded properly, a message is displayed on the touch screen. Load the original on the platen glass or in the ADF according to the scan settings.

• **If you select ON for Preview on the scan setting screen:**

The preview screen is displayed before saving the scanned original on the USB flash drive.

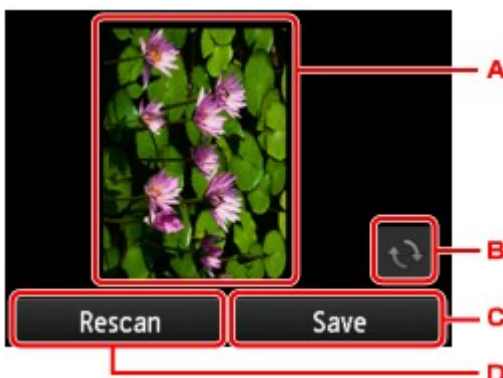

A. The preview screen of the scanning data is displayed.

B. Tap to rotate the preview screen.

Displayed when you select **PDF** or **Compact PDF** for **Format** on the scan setting screen.

C. Tap to save the scanned original on the USB flash drive.

D. Tap to rescan the original.

• **If you load the original in the ADF:**

The machine starts scanning and scanned data is saved on the USB flash drive.

• **If you load the original on the platen glass:**

- When you select **JPEG** for **Format** on the scan settings screen, the machine starts scanning and scanned data is saved on the USB flash drive.
- When you select **PDF** or **Compact PDF** for **Format** on the scan settings screen, the confirmation screen asking you if you continue scanning is displayed after scanning is complete.

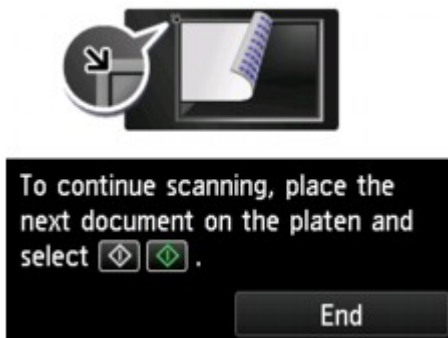

If you continue scanning, load the original on the platen glass and start scanning.

If you do not continue scanning, tap **End**. The scanned data is saved on the USB flash drive in one PDF file.

When you scan the originals continuously, you can save up to 100 pages of images in one PDF file.

Remove the original on the platen glass or from the document output slot after scanning is complete.

▶▶▶ **Note**

- If the USB flash drive becomes full while scanning images is in progress, only the images already scanned can be saved.
- You can save up to 2000 files of scanned data in both PDF and JPEG data format.
- The folder and file name of scanned data saved on the USB flash drive is as follows:
 - Folder name: (file extension: PDF): CANON_SC\DOCUMENT\0001
 - Folder name: (file extension: JPEG): CANON_SC\IMAGE\0001
 - File name: Running numbers, starting from SCN_0001
 - File date: The date and time of saving as set in the machine.

For details on how to set the date and time:

■ [Setting the Sender Information](#)

- Importing the Scanned Data Saved on a USB Flash Drive to the Computer

You can import the scanned data saved on a USB flash drive to the computer. After scanning the data, connect the USB flash drive to the computer, then import the data.

Forwarding Scanned Data to Shared Folder on the Computer Using the Operation Panel of the Machine

Before forwarding scanned data on the shared folder on the computer, confirm the following:

- **The scanner driver and Canon Quick Toolbox are installed.**
If the scanner driver and Canon Quick Toolbox are not yet installed, install them from our website.
- **The machine is connected to a computer via a LAN correctly.**
- **The destination folder is specified in Canon Quick Toolbox.**
You can specify the destination folder in Canon Quick Toolbox. For details on settings of Canon Quick Toolbox:

■ [Destination Folder Settings](#)

Follow the procedure below to forward scanned data to the shared folder on the computer.

1. [Make sure that the machine is turned on.](#)

2. Flick the HOME screen, then tap  **Scan.**

■ [Using the Operation Panel](#)

The screen for selecting to which you save the data is displayed.

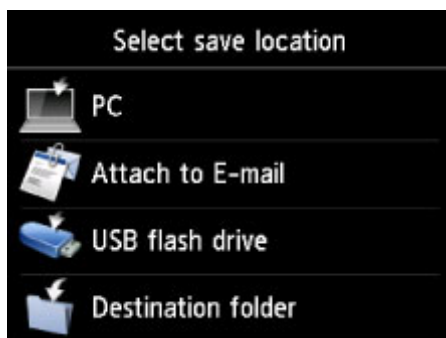

3. Tap  **Destination folder.**

▶▶▶ Note

- When the message informing you that the operation restriction is enabled, ask the administrator of the machine you are using.

For details on the operation restriction of the machine:

■ [About the Machine Administration](#)

4. Tap the folder to save scanned data on the **Select folder** screen.

▶▶▶ Note

- When you specify a PIN code for a registered folder, a screen asking you to enter a PIN code is displayed. Entering the PIN code allows you to assign the shared folder as the destination.

5. Specify the settings as necessary.

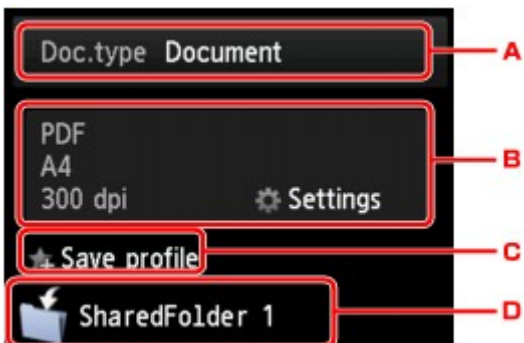

A. Tap to select the document type.

Document

Scans the original on the platen glass or in the ADF as a document data applying the settings specified in **Scan settings**.

Photo

Scans the original on the platen glass as a photo data applying the settings specified in **Scan settings**.

B. Tap to display **Scan settings** screen.

For details on the setting items:

[■Setting Items for Scanning Using the Operation Panel of the Machine](#)

C. Tap to register the current scan settings as a custom setting.

[■Registering the Favorite Settings \(Custom profiles\)](#)

D. Tap to display the screen to select the destination.

6. [Load the original document on the platen glass or in the ADF.](#)

7. Press the **Color** button for color scanning, or the **Black** button for black & white scanning.

▶▶▶ Note

- If the original is not loaded properly, a message is displayed on the touch screen. Load the original on the platen glass or in the ADF according to the scan settings.

• If you select ON for Preview on the scan setting screen:

The preview screen is displayed before forwarding the scanned original to the shared folder on the computer.

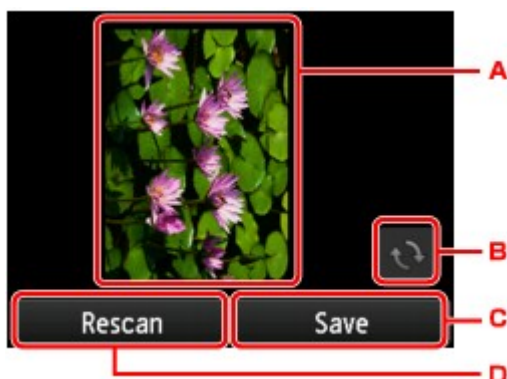

A. The preview screen of the scanning data is displayed.

B. Tap to rotate the preview screen.

Displayed when you select **PDF** or **Compact PDF** for **Format** on the scan setting screen.

C. Tap to forward the scanned original to the shared folder on the computer.

D. Tap to rescan the original.

• **If you load the original in the ADF:**

The machine starts scanning and scanned data is forwarded to the shared folder of the computer.

• **If you load the original on the platen glass:**

◦ When you select **JPEG** for **Format** on the scan setting screen, the machine starts scanning and scanned data is saved on the shared folder of the computer.

◦ When you select **PDF** or **Compact PDF** for **Format** on the scan setting screen, the confirmation screen asking you if you continue scanning is displayed after scanning is complete.

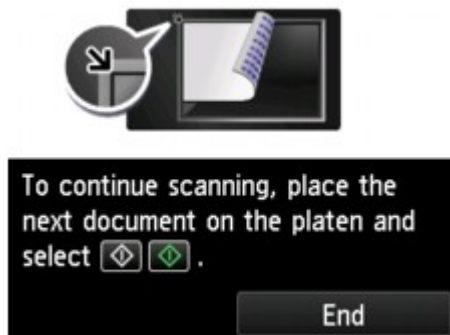

If you continue scanning, load the original on the platen glass and start scanning.

If you do not continue scanning, tap **End**. The scanned data is forwarded to the shared folder on the computer in one PDF file.

Scanned data is forwarded to the shared folder on the computer according to the settings specified in Canon Quick Toolbox.

Remove the original on the platen glass or from the document output slot after scanning is complete.

Deleting Scanned Data on USB Flash Drive

You can delete scanned data on the USB flash drive using the operation panel.

1. [Make sure that the machine is turned on.](#)

2. Flick the HOME screen, then tap  **Scan.**

■ [Using the Operation Panel](#)

The screen for selecting to which you save the data is displayed.

3. [Insert the USB flash drive into the USB flash drive port.](#)

4. Tap  **USB flash drive.**

▶▶ Note

- When the message informing you that the operation restriction is enabled, ask the administrator of the machine you are using.

For details on the operation restriction of the machine:

■ [About the Machine Administration](#)

5. Tap  **Delete saved data.**

The file list is displayed.

6. Select the data to delete.

File name list

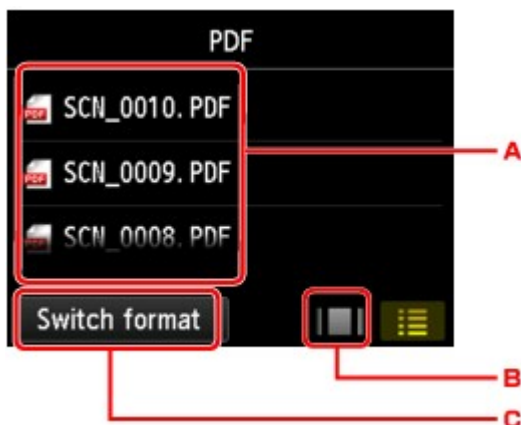

Preview screen

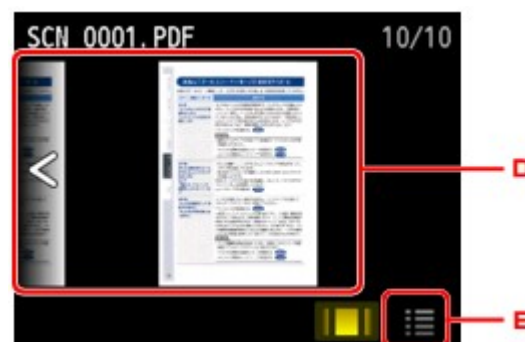

- A. Flick to display the file name, then tap to delete the data.

When the format for PDF data is selected, only the first page of the PDF data is displayed on the touch screen.

- B. Tap to display the preview screen.

When the format for PDF data is selected, only the first page of the PDF data is displayed on the touch screen.

- C. Tap to switch the file type displayed on the touch screen.
- D. Flick to display the data, then tap to delete the data.
- E. Tap to display the file name list.

7. Tap **Yes** on the confirmation screen.



The machine starts deleting the file.

Setting Items for Scanning Using the Operation Panel of the Machine

You can change the scan settings such as the scan size, resolution, or data format.

When the Scan standby screen is displayed, tap **Settings** to select the setting item. Flick to display setting items, then tap the setting item to display the settings. Tap to specify the setting.

▶▶▶ Note

- When you forward the scanned data to the computer using WSD (one of the network protocols supported in Windows 8.1, Windows 8, Windows 7, and Windows Vista), you cannot specify the scan setting.
- Depending on the destination, some setting items cannot be selected. This section describes the setting items when you select **USB flash drive** on the screen for selecting to which you save the data. The setting item which cannot be selected is displayed grayed out.
- Some settings cannot be specified in combination with the setting of other setting item, the document type selected for **Doc.type**, or the scan menu on the screen for selecting to which you save the data. If the setting which cannot be specified in combination is selected,  and **Error details** are displayed on the touch screen. In this case, tap  on the upper left on the touch screen to confirm the message, then change the setting.
- The specified scan settings such as the scan size, resolution, and data format are retained even if the machine is turned off.
- When scanning starts in the scan menu that is not available with the specified setting, **The specified function is not available with current settings.** is displayed on the touch screen. Change the setting, following the on-screen instructions.
- When you forward the scanned data to the computer or attach the data to an e-mail, you can specify the destination and file name using Canon IJ Scan Utility.

■ [Settings Dialog](#)

- If you scan originals from the computer, you can scan with advanced settings. For details on scanning from the computer:

■ [Scanning with IJ Scan Utility](#)

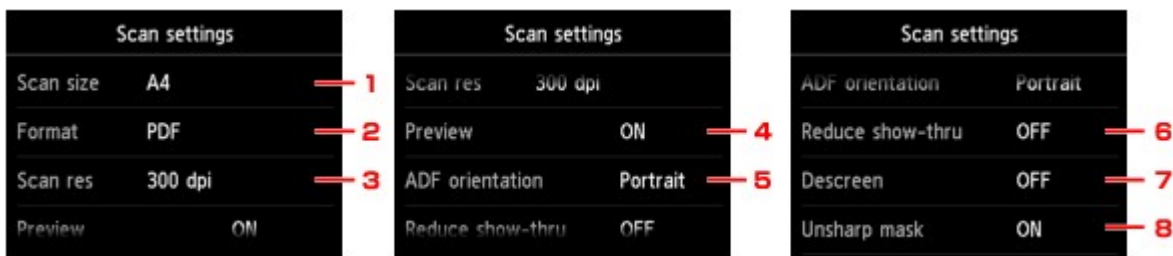

1. Scan size

Select the size of the original.

2. Format

Select the data format of the scanned data.

3. **Scan res** (Scan resolution)

Select the resolution for scanning.

4. **Preview**

Select to preview the scanned data or not when saving the data on a USB flash drive.

5. **ADF orientation**

Select the orientation of the original document.

This setting item is not available when **Photo** is selected for **Doc.type**.

6. **Reduce show-thru** (Reducing show-through)

Characters on the back may show through when scanning a thin document such as a newspaper. Select **ON** if characters seem to show through on the scanned document.

This setting item is not available when **Photo** is selected for **Doc.type**.

7. **Descreen**

A printout consists of minute dots to make characters or graphs. Interfering with each dot may result in uneven shades or a striped pattern. Select **ON** if you notice any uneven shades or a striped pattern on the scanned image.

This setting item is not available when **Photo** is selected for **Doc.type**.

▶▶▶ Note

- Even if **ON** is selected for this setting, some moire effects may remain if **Unsharp mask** is set to **ON**. In that case, select **OFF** for **Unsharp mask**.

8. **Unsharp mask**

The outline of small characters or thin objects such as a hair or leaves on a photo can be accentuated. Select **ON** if you want to accentuate the outline of the scanned data.

Network Scan Settings

You can connect your scanner or printer to a network to share it among multiple computers or scan images into a specified computer.

▶▶▶ Important

- Multiple users cannot scan at the same time.
- To scan over a network, enable Bonjour on your scanner or printer.

▶▶▶ Note

- Complete the network settings of your scanner or printer beforehand by following the instructions on the web page.
- With network connection, scanning takes longer than USB connection.

Setting for Scanning with IJ Scan Utility

In the IJ Scan Utility main screen, select your scanner or printer that is connected to a network.

1. [Start IJ Scan Utility.](#)
2. Select "Canon XXX series Network" (where "XXX" is the model name) for **Product Name**.

You can scan via a network connection.

▶▶▶ Note

- If you cannot scan, check that your scanner or printer is selected in the [network selection screen](#).
- For USB connection, select "Canon XXX series" (where "XXX" is the model name) for **Product Name**.

Setting for Scanning from the Operation Panel

You can make the setting for scanning from the operation panel.

1. [Start IJ Scan Utility.](#)
2. Click **Settings...**

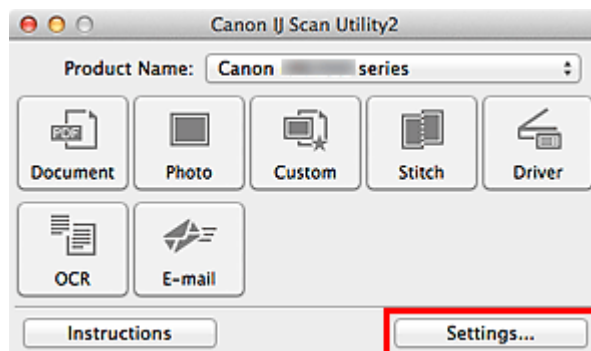

The [Settings dialog](#) appears.

3. Click the  (General Settings) tab.

The **Settings (General Settings)** dialog appears.

4. In **Product Name**, select an item with "Network" after the product name, then click **Select** that appears to its right.

The [network selection screen](#) appears.

5. Click **Scan-from-Operation-Panel Settings**.

The Scan-from-Operation-Panel Settings screen appears.

6. Select your scanner or printer from **Scanners** and click **OK**.

7. Return to the network selection screen, then click **OK**.

The IJ Scan Utility main screen reappears. You can scan from the operation panel.

▶▶▶ Note

- If the Bonjour service name of your scanner or printer does not appear or cannot be selected, check the following, click **OK** to close the screen, then reopen it and try selecting again.
 - The scanner driver is installed
 - Network settings of your scanner or printer is completed after installing the scanner driver
 - Network communication between your scanner or printer and computer is enabled

If your scanner or printer still does not appear, refer to "Problems with Network Communication" for your model from Home of the *Online Manual*.

Selecting a Response to Commands from the Operation Panel Using IJ Scan Utility

IJ Scan Utility allows you to specify how to respond when scanning from the operation panel.

▶▶▶ Note

- The screens for scanning photos from the operation panel are used as examples in the following descriptions.

1. [Start IJ Scan Utility.](#)
2. Click **Settings...**

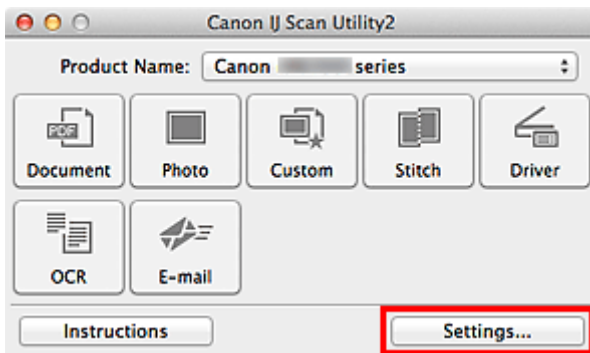

The Settings dialog appears.

3. Select a scan mode on the  (Scanning from the Operation Panel) tab.

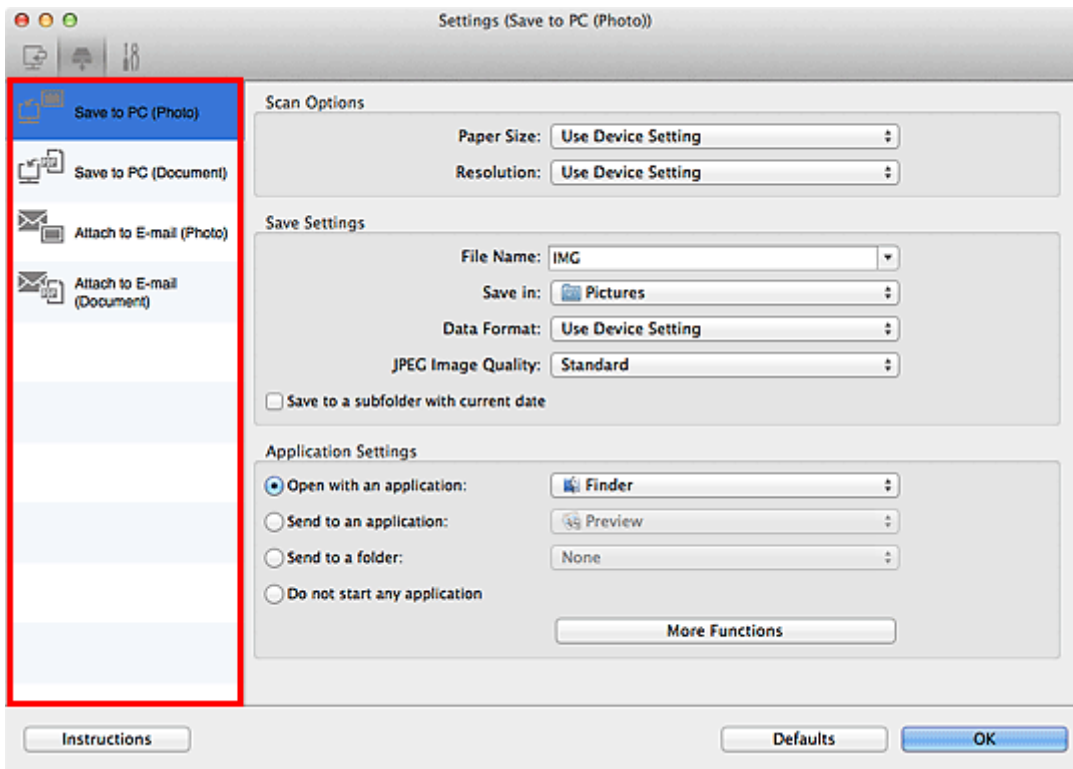

▶▶▶ Note

- Refer to the following for details.

- [Settings \(Save to PC \(Photo\)\) Dialog](#)
- [Settings \(Save to PC \(Document\)\) Dialog](#)
- [Settings \(Attach to E-mail \(Photo\)\) Dialog](#)
- [Settings \(Attach to E-mail \(Document\)\) Dialog](#)

4. Set **Scan Options**.

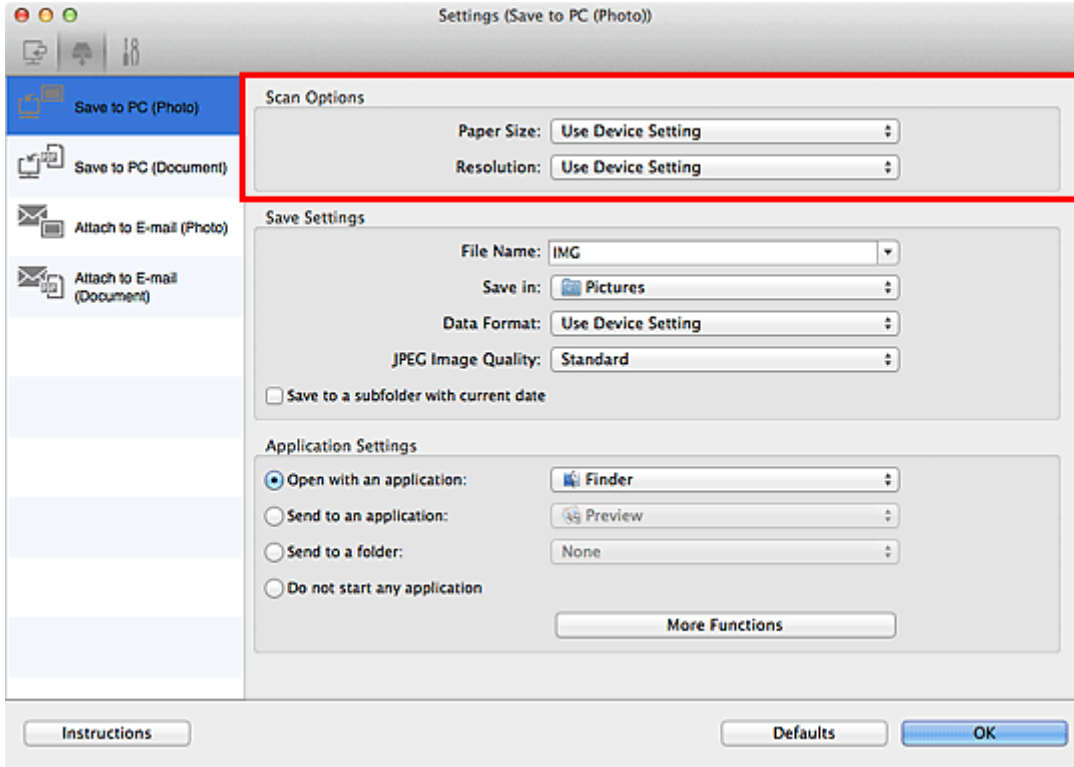

5. Specify the file name and other settings in **Save Settings**.

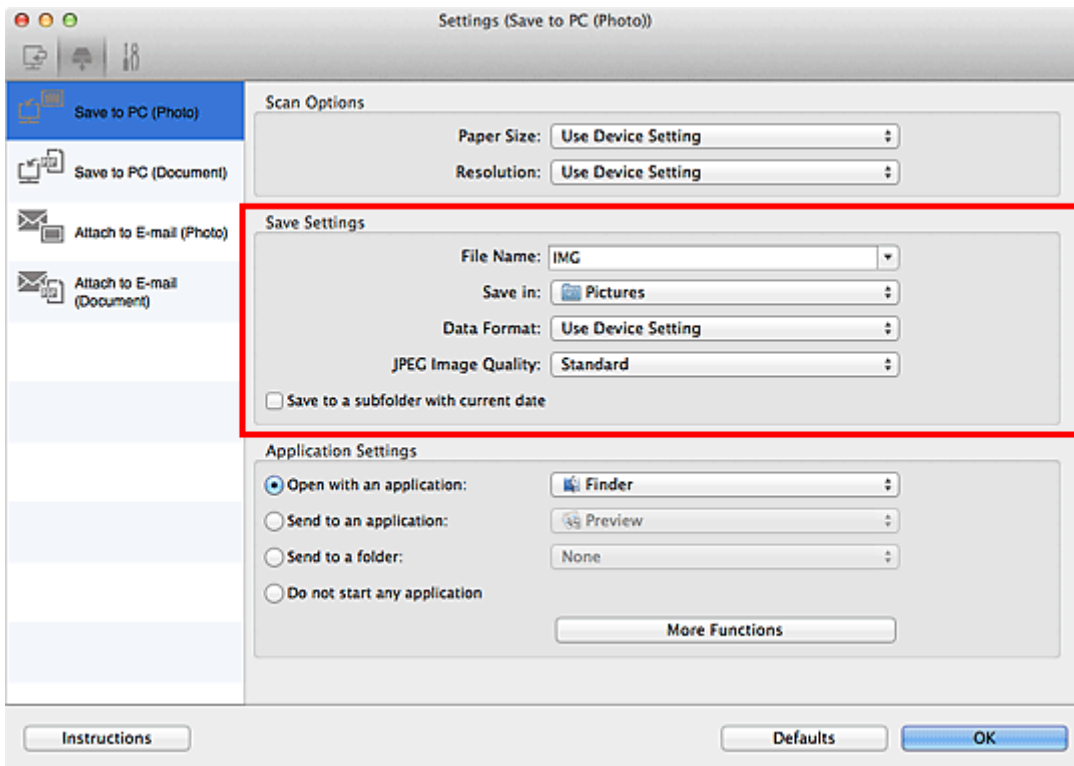

6. Select the application you want to start after scanning in **Application Settings**.

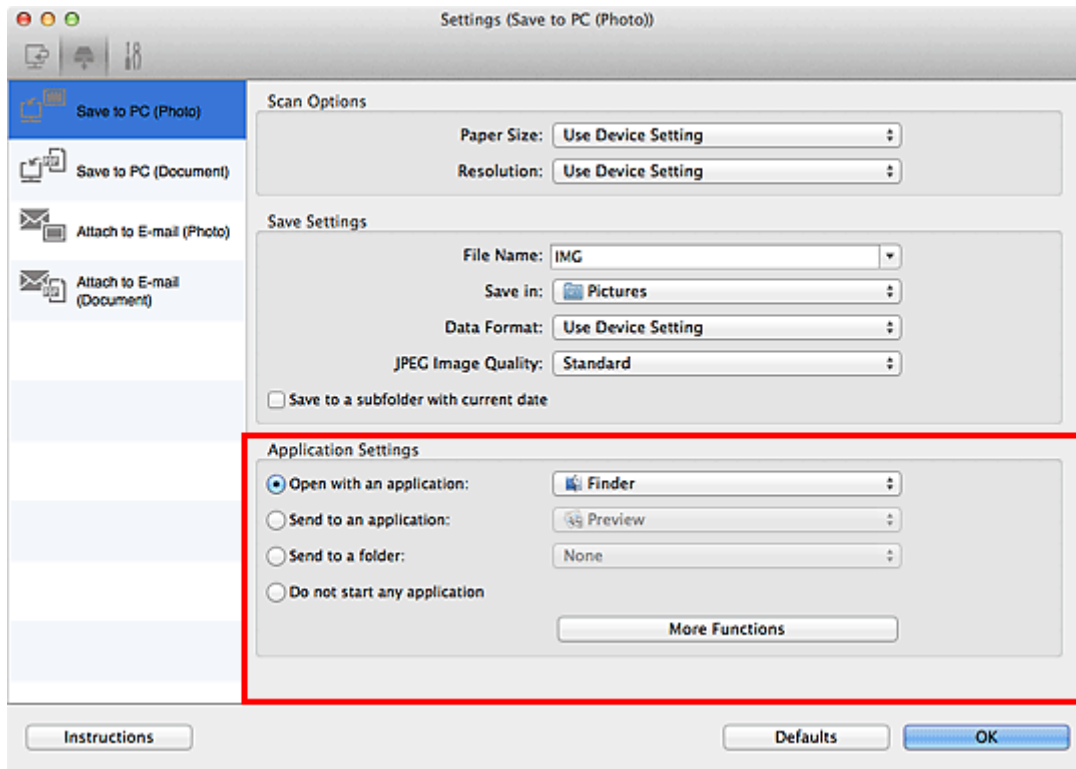

7. Click **OK**.

The responses will be executed according to the specified settings when you start scanning from the operation panel.

Faxing

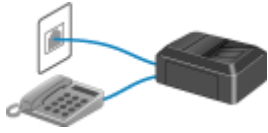

Preparing for Faxing



Sending Faxes Using the Operation Panel of the Machine



Registering Recipients



Receiving Faxes



Other Useful Fax Functions

Preparing for Faxing

Connect the machine to the telephone line and set up the machine before using the faxing functions. Then specify the basic setting such as sender information, date/time, and daylight saving time.

▶▶▶ Important

- If the Power Disconnects Unexpectedly:

If there is a power failure or if you accidentally unplug the power cord, the date/time settings will be reset.

- The settings for user information and directory will be retained.
- All faxes stored in the machine's memory, such as unsent and received faxes, will be lost.

If the power disconnects, the following will apply:

- You will not be able to send or receive faxes, make copies, or scan originals.
- When you are connecting the telephone, whether or not you can use it depends upon your telephone line or telephone.

Setting Up the Machine

The machine must be set up depending on your telephone line and use of the faxing function. Follow the procedure below to set up the machine.

1. [Connecting the Telephone Line](#)

Connect the machine to your telephone line.

2. [Setting the Telephone Line Type](#)

Set the correct telephone line type for your telephone line.

3. [Setting the Receive Mode](#)

Set the receiving operation (receiving mode).

▶▶▶ Note

- You can set the fax setting according to the instruction on the touch screen.

■ [Easy setup](#)

If you set up according to the instruction on the touch screen., the receive mode is set to **TEL priority mode** or **FAX only mode**. To receive faxes with **DRPD** or **Network switch**, change the receive mode.

■ [Setting the Receive Mode](#)

Specifying the Basic Settings for Faxing

You can specify the basic setting such as sender information, date/time, and daylight saving time.

■ [Setting the Sender Information](#)

Connecting the Telephone Line

The connection method differs depending on your telephone line.

- If you connect the machine to wall telephone line directly/If you connect the machine with the xDSL splitter:

■ [Basic Connection](#)

- If you connect the machine to another line such as an xDSL:

■ [Connecting Various Lines](#)

If the connection is incorrect, the machine cannot send/receive faxes. Connect the machine correctly.

▶▶▶ Important

- Do not connect fax machines and/or telephones in parallel (US and Canada only).

If two or more fax machines and/or telephones are connected in parallel, the following problems may occur and the machine may not operate properly.

- If you pick up the handset of the telephone that is connected in parallel during fax transmission or reception, the fax image may be corrupted or a communication error may occur.
- Such services as Caller ID, etc. may not operate properly on the telephone.

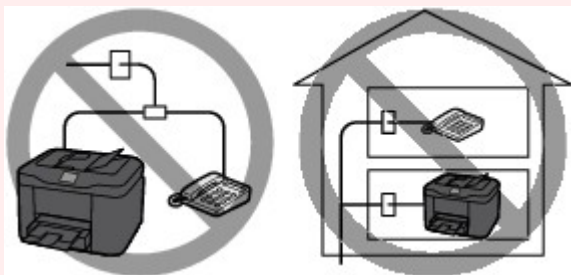

If you cannot avoid parallel connections, set the receive mode to **TEL priority mode**, understanding that the above problems may occur. You will only be able to receive faxes manually.

Basic Connection

Make sure that the machine is turned off, connect one end of supplied telephone line cable to the telephone line jack near the "LINE" mark of the machine, then connect the other end to the telephone line jack on the wall or to the telephone line jack of the xDSL splitter.

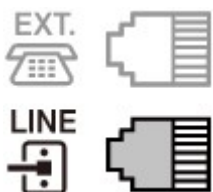

When you connect the telephone to the machine, make sure that the machine is turned off, connect one end of the modular cable to the external device jack near the "EXT." mark of the machine, then connect the other end to the telephone line jack of the telephone.



►► Important

- Be sure to connect the telephone line before the machine is turned on.

If you connect the telephone line when the machine is turned on, turn the machine off and unplug the power cord. Wait for 1 minute then connect the telephone line and power plug.

►► Note

- Refer to [Rear View](#) for the position of the telephone line jack and the external device jack.
- Before connecting a telephone or answering machine, remove the Telephone connector cap.
- **For users in the UK:**

If the connector of the external device cannot be connected to the jack on the machine, you will need to purchase a B.T. adapter to connect as follows:

Attach the B.T. adapter to the modular cable connecting the external device, then connect the B.T. adapter to the external device jack.

Connecting Various Lines

This section introduces how to connect various lines.

These are examples and could not be guaranteed to suit every connecting condition. For details, refer to the instruction manual supplied with the network device (control devices such as an xDSL (Digital Subscriber Line) modem or terminal adapter) you are connecting to this machine.

►► Note

- xDSL is the generic term for the high speed digital communication technology with telephone line such as ADSL/HDSL/SDSL/VDSL.

• Connecting to an Internet Telephone

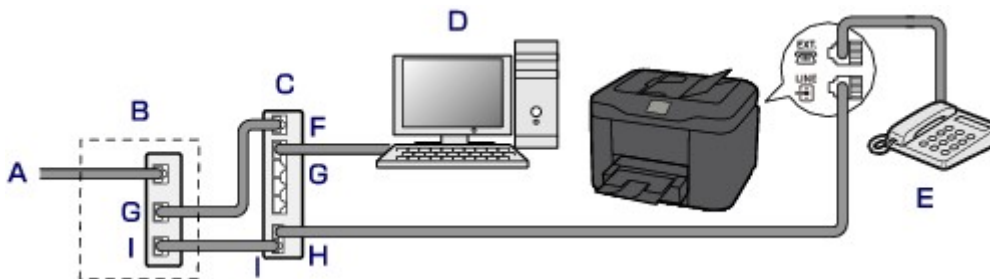

- A. Digital Subscriber Line
- B. xDSL modem (splitter may not be built-in to the modem)
- C. Broadband router compatible with Internet Telephone
- D. Computer
- E. Telephone or answering machine
- F. WAN (Wide Area Network) port
- G. LAN (Local Area Network) port
- H. TEL port
- I. LINE port

* Port configurations and names may vary depending on the product.

►► Note

- When connecting to the xDSL line, select the same line type as you are subscribing to in **Telephone line type**.

■ [Setting the Telephone Line Type](#)

• Connecting to an xDSL

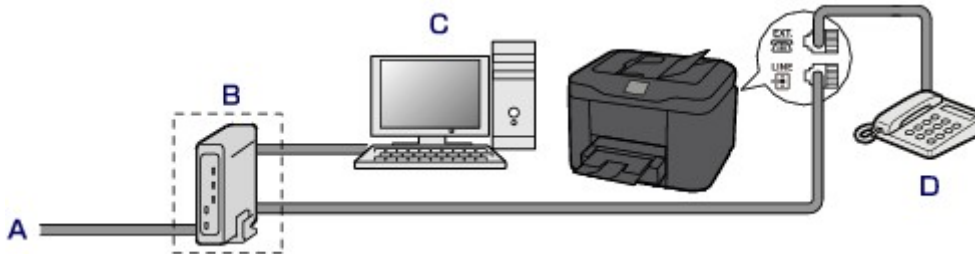

- A. Analog Subscriber Line
- B. xDSL modem (splitter may not be built-in to the modem)
- C. Computer
- D. Telephone or answering machine

►► Important

- When the splitter is not built-in to the modem, do not branch the telephone line before the splitter (wall side). And also, do not connect splitters in parallel. The machine may not be able to operate properly.

►► Note

- When connecting to the xDSL line, select the same line type as you are subscribing to in **Telephone line type**.

■ [Setting the Telephone Line Type](#)

• Connecting to an ISDN Line

For details on ISDN (Integrated Service Digital Network) connection and settings, refer to the manuals supplied with your terminal adapter or dial-up router.

Setting the Telephone Line Type

Before using your machine, make sure you set the correct telephone line type for your telephone line. If you are unsure of your telephone line type, contact your telephone company. For xDSL or ISDN connections, contact the telephone company or service provider to confirm your line type.

»» Important

- **For users in China:**

After plugging the power cord and turning on the machine, the telephone line type is selected automatically. However, if the machine is connected to the control device such as an xDSL modem or terminal adapter, the telephone line type may not be selected correctly.

In this case, set the line type manually.

For details on how to set the Telephone line type manually in China:

■ [Setting the Telephone Line Type Manually in China](#)

»» Note

- **Telephone line type** will not appear in countries or regions where **Rotary pulse** is not supported.
- You can print USER'S DATA LIST to check the current setting.

■ [Summary of Reports and Lists](#)

1. [Make sure that the machine is turned on.](#)

2. Flick the HOME screen, then tap  **Setup**.

■ [Using the Operation Panel](#)

3. Tap  **Device settings**.

4. Tap **FAX settings**.

5. Tap **FAX user settings**.

6. Tap **Telephone line type**.

7. Tap a telephone line type.



Rotary pulse

Select when your telephone line type is pulse dialing.

Touch tone

Select when your telephone line type is tone dialing.

Setting the Telephone Line Type Manually in China

This section describes the procedure to set the telephone line type manually in China.

1. [Make sure that the machine is turned on.](#)

2. Flick the HOME screen, then tap  **Setup**.

■ [Using the Operation Panel](#)

3. Tap  **Device settings**.

4. Tap **FAX settings**.

5. Tap **FAX user settings**.

6. Tap **Telephone line auto selection**.

The current telephone line type is displayed.

7. Check the current telephone line type, then tap **OK**.

▶▶▶ Note

- If you do not need to change the telephone line type, press the **HOME** button to return to the HOME screen.

8. Tap **OFF**.

9. Tap a telephone line type.

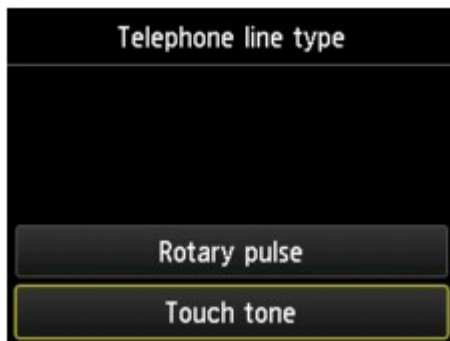

Rotary pulse

Select when your telephone line type is pulse dialing.

Touch tone

Select when your telephone line type is tone dialing.

Setting the Receive Mode

Set the receiving operation (receiving mode).

For details on how to set the receive mode:

■ [Setting the Receive Mode](#)

You can select the appropriate mode.

For details on the selectable receive mode:

■ [About the Receive Mode](#)

For details on the advanced settings of the receive mode:

■ [Advanced Settings of Receive Mode](#)

▶▶▶ Note

- The receiving operation procedure varies depending on the selected receive mode.

For details on receiving method depending on each receive mode:

■ [Receiving Faxes](#)

- If you want to use a single telephone line for faxes and voice calls, you need to connect a telephone or an answering machine to the external device jack of this machine.

For details on how to connect the telephone or the answering machine to the machine:

■ [Basic Connection](#)

Setting the Receive Mode

This section describes the procedure to select the receive mode.

1. [Make sure that the machine is turned on.](#)

2. Flick the HOME screen, then tap  **FAX**.

■ [Using the Operation Panel](#)

3. Tap **Function list**.

The **Function list** screen is displayed.

4. Tap **Receive mode settings**.

5. Tap a receive mode, then tap **OK**.

▶▶▶ Note

- By tapping **Advanced**, you can specify the advanced settings of each receive mode.

For details on the advanced settings of the receive mode:

■ [Advanced Settings of Receive Mode](#)

- For details on the receive mode:

■ [About the Receive Mode](#)

- **DRPD** is available only in the US and Canada.
- **Network switch** may not be available depending on the country or region of purchase.
- Refer to [Receiving Faxes](#) for information on receiving faxes or the procedure for each receive mode.

About the Receive Mode

You can select the receive mode suitable for your fax use conditions: whether you use a dedicated line for fax, etc.

Receive mode	Your fax use condition	Receiving operation
TEL priority mode	When mainly receiving voice calls (with a telephone or answering machine connected to the machine):	<p>When a call incomes, the telephone will ring.</p> <p>Pick up the handset.</p> <p>If the call is a voice call, talk on the telephone.</p> <p>If the call is a fax, hang up the handset after the machine starts receiving the fax.</p> <p>▶▶▶ Note</p> <ul style="list-style-type: none"> • The telephone may not ring when a call incomes even if it is connected to the machine, depending on the type or settings of the telephone.
DRPD or Network switch	When receiving voice calls (with a telephone or answering machine connected to the machine) and subscribing to a ring pattern detection service provided by your telephone company:	<p>When a call incomes, the telephone will ring. The machine detects a fax call by the fax ring pattern.</p> <p>If the call is a fax, the machine will receive the fax automatically.</p> <p>If the machine does not detect the fax ring pattern, the telephone will continue ringing.</p> <p>▶▶▶ Note</p> <ul style="list-style-type: none"> • The telephone may not ring when a call incomes even if it is connected to the machine, depending on the type or settings of the telephone.
FAX only mode	When not receiving voice calls:	When a fax incomes, the machine will receive the fax automatically.

Advanced Settings of Receive Mode

You can specify the advanced settings of each receive mode.

- **Advanced setting in TEL priority mode**

You can specify the following setting items.

- **Manual/auto switch: ON/Manual/auto switch: OFF**

If you select **Manual/auto switch: ON**, the machine automatically receives faxes after the external device rang a specified length of time.

You can specify the length of time until automatic reception is started.

- **RX start time**

You can specify the length of time until automatic reception is started when **Manual/auto switch: ON** is selected. Specify the length of time and tap **OK**.

- **User-friendly RX: ON/User-friendly RX: OFF**

If you select **User-friendly RX: ON**, the machine automatically switches from telephone calling to fax reception by detecting the fax signal (CNG signal) when you lift the handset of the telephone or the answering machine answers. When you have an answering machine connected to the machine, select **User-friendly RX: ON** to switch to fax reception automatically after the answering machine answers.

If you select **User-friendly RX: OFF**, the machine does not switch from telephone calling to fax reception automatically even if the machine detects the fax signal (CNG signal). Select **User-friendly RX: OFF** if you want the machine not to switch automatically during a call.

▶▶▶ Note

- If you subscribe to Duplex Ringing service in Hong Kong, the number of times the external device rings specified with **Ring count** in **FAX only mode** is available in **TEL priority mode**.

If you want to specify the number of times the external device rings in **TEL priority mode**, select **FAX only mode** on the **Receive mode settings** screen, specify the number of times the external device rings with **Ring count**, then switch to **TEL priority mode** in **Receive mode settings**.

- If you subscribe to Duplex Ringing service in Hong Kong, we recommend that you select **Manual/auto switch: OFF**.

- **Advanced setting in FAX only mode**

You can specify the following setting item.

- **Ring count**

You can specify the number of times the external device rings when incoming.

Specify the number of time and tap **OK**.

- **Advanced setting in DRPD**

You can specify the following setting items.

- Ring pattern (**Normal ring/Double ring/Short-short-long/Short-long-short**)

Sets the distinctive ring pattern of a call that the machine assumes is a fax call.

If you subscribe to a DRPD service, set the ring pattern to match the pattern assigned by your telephone company.

■ [Setting the DRPD Ring Pattern \(US and Canada only\)](#)

- **Ring count**

You can specify the number of times the external device rings when incoming.

Specify the number of time and tap **OK**.

- **Advanced setting in Network switch**

You can specify the following setting item.

- **Ring count**

You can specify the number of times the external device rings when incoming.

Specify the number of time and tap **OK**.

Setting the DRPD Ring Pattern (US and Canada only)

If you have subscribed to a Distinctive Ring Pattern Detection (DRPD) service provided by your telephone company, your telephone company will assign two or more telephone numbers with distinctive ring patterns to your single telephone line, allowing you to have different numbers for fax calls and voice calls using only one telephone line. Your machine will automatically monitor the ring pattern, and will automatically receive the fax if the ring pattern is a fax call.

To use DRPD, follow the procedure below to set the fax ring pattern that matches the pattern assigned by your telephone company.

►► Note

- Contact your local telephone company for detailed information on this service.

1. [Make sure that the machine is turned on.](#)

2. Flick the HOME screen, then tap  **FAX**.

■ [Using the Operation Panel](#)

3. Tap **Function list**.

The **Function list** screen is displayed.

4. Tap **Receive mode settings**.

5. Tap **DRPD**.

6. Tap **Advanced**.

7. Select the ring pattern that your telephone company assigned to your fax number.



8. Specify the number of time and tap **OK**.

9. Tap **OK**.

The **Function list** screen is displayed.

Setting the Sender Information

You can set the sender information such as date/time, unit name, and unit fax/telephone number.

■ [About the Sender Information](#)

■ [Setting the Date and Time](#)

■ [Setting Daylight Saving Time \(Summer Time\)](#)

■ [Registering User Information](#)

About the Sender Information

If the unit name and unit fax/telephone number are registered, they are printed with date and time as sender information on the recipient's fax.

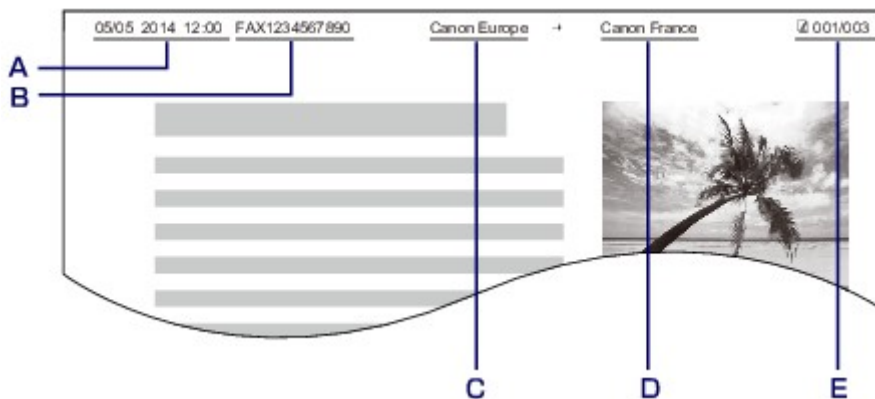

- A. Date and time of transmission
- B. Unit fax/telephone number
- C. Unit name
- D. The registered recipient's name is printed when sending faxes.
- E. Page number

►► Note

- You can print USER'S DATA LIST to confirm the sender information you have registered.

■ [Summary of Reports and Lists](#)

- When sending faxes in black & white, you can select whether to print the sender information inside or outside the image area.

Specify the setting on **TTI position** in **Advanced FAX settings** under **FAX settings**.

■ [Advanced FAX settings](#)

- You can select the date print format from three formats: **YYYY/MM/DD**, **MM/DD/YYYY**, and **DD/MM/YYYY**.

Select the date print format on **Date display format** under **Device user settings**.

■ [Device user settings](#)

Setting the Date and Time

This section describes the procedure to set the date and time.

1. [Make sure that the machine is turned on.](#)

2. Flick the HOME screen, then tap  **Setup**.

[Using the Operation Panel](#)

3. Tap  **Device settings**.

4. Tap **Device user settings**.

5. Tap **Date/time setting**.

6. Set the date.

1. Tap a setting item to change.

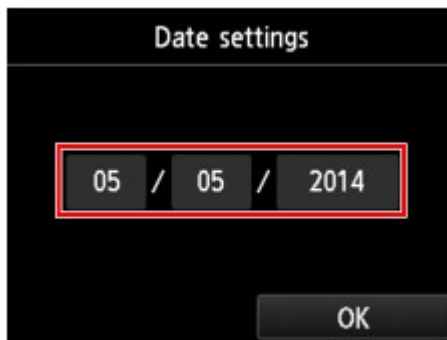

2. Tap the number to enter.



Enter only the last two digits of the year.

3. Tap **OK**.

4. Tap **OK** again when all settings are completed.

7. Set the time.

1. Tap a setting item to change.

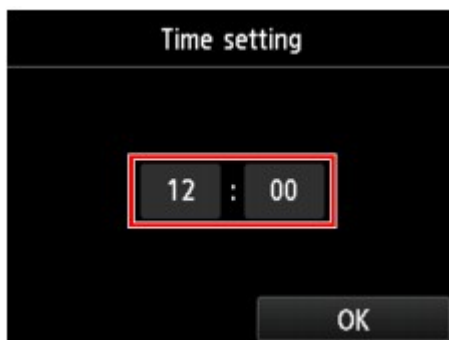

2. Tap the number to enter.



Enter the date and time in 24-hour format.

3. Tap **OK**.
 4. Tap **OK** again when all settings are completed.
-
8. Press the **HOME** button to return to the HOME screen.

Setting Daylight Saving Time (Summer Time)

Some countries adopt the daylight saving time (summer time) system that shifts the clock time forward at certain periods of the year.

You can set your machine to automatically change the time by registering the date and time that daylight saving time (summer time) begins and ends.

▶▶▶ Important

- Not all the latest information of all countries or regions is applied for **Daylight saving time setting** by default. You need to change the default setting according to the latest information of your country or region.

▶▶▶ Note

- This setting may not be available depending on the country or region of purchase.

1. [Make sure that the machine is turned on.](#)

2. Flick the HOME screen, then tap  **Setup**.

[Using the Operation Panel](#)

3. Tap  **Device settings**.

4. Tap **Device user settings**.

5. Tap **Daylight saving time setting**.

6. Tap **ON**.

To disable summer time, tap **OFF**.

7. Set the date and time when summer time starts.

1. Set the date when summer time starts.

Tap a setting item to change then specify the setting. Tap **OK** again when all settings are completed.

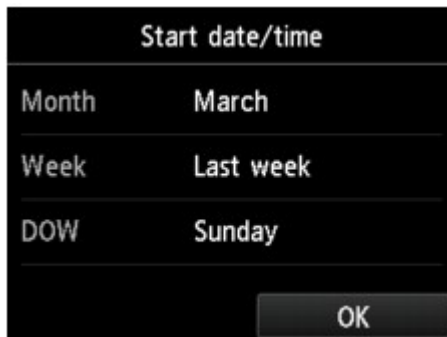

2. Set the time (in 24-hour format) when summer time starts.

Tap a setting item to change then specify the setting. Tap **OK** again when all settings are completed.

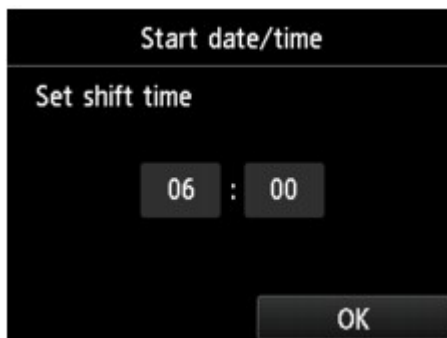

8. Set the date and time when summer time ends.

1. Set the date when summer time ends.

Tap a setting item to change then specify the setting. Tap **OK** again when all settings are completed.

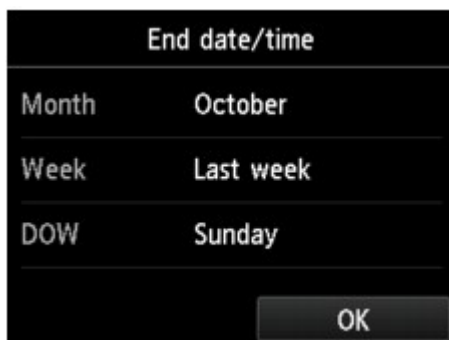

2. Set the time (in 24-hour format) when summer time ends.

Tap a setting item to change then specify the setting. Tap **OK** again when all settings are completed.

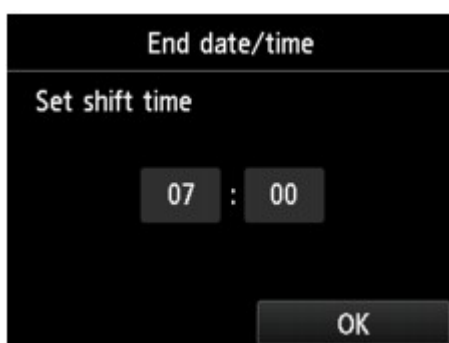

9. Press the **HOME** button to return to the HOME screen.

Registering User Information

This section describes the procedure to register the user information.

▶▶ Note

- Before sending a fax, be sure to enter your name and fax/telephone number in **Unit name** and **Unit TEL** on the **User information settings** screen (for US only).

1. [Make sure that the machine is turned on.](#)

2. Flick the HOME screen, then tap  **Setup**.

■ [Using the Operation Panel](#)

3. Tap  **Device settings**.

4. Tap **FAX settings**.

5. Tap **FAX user settings**.

6. Tap **User information settings**.

The screen to register the unit name and the unit fax/telephone number is displayed.



7. Enter the unit name.

1. Tap the entry field under **Unit name**.
The screen to enter the character is displayed.
2. Enter the unit name.

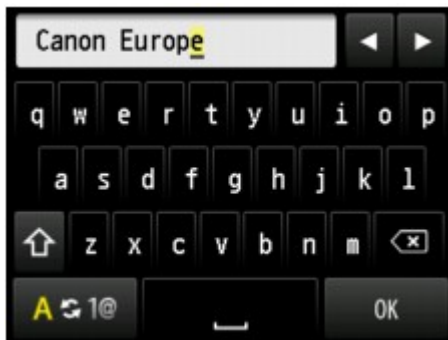

3. Tap **OK**.

»» Note

- You can enter the name up to 24 characters, including spaces.
- For details on how to enter or delete characters:
[■ Entering Numbers, Letters, and Symbols](#)

8. Enter the unit fax/telephone number.

1. Tap the entry field under **Unit TEL**.
The screen to enter the number is displayed.
2. Enter the unit fax/telephone number.



3. Tap **OK**.

»» Note

- You can enter the fax/telephone number up to 20 digits, including spaces.
- For details on how to enter or delete characters:
 - [Entering Numbers, Letters, and Symbols](#)

9. Tap **Register** to finalize registration.

Sending Faxes Using the Operation Panel of the Machine

- ▶ **Sending Faxes by Entering Fax/Telephone Number**  **Basic**
- ▶ **Resending Faxes (Redialing a Busy Number)**
- ▶ **Setting Items for Sending Faxes**
- ▶ **Sending Faxes Using Useful Functions**

Sending Faxes by Entering Fax/Telephone Number

This section describes dialing and sending faxes directly by entering the fax/telephone numbers.

Important

- It may be possible that faxes will reach unintended recipients due to the misdialing or incorrect registration of fax/telephone numbers. When you send important documents, it is recommended that you send them after speaking on the telephone.

■ [Sending a Fax after Speaking on Telephone](#)

- [Make sure that the machine is turned on.](#)
- [Load documents on the platen glass or in the ADF.](#)

Important

- When sending a double-sided document, load the document on the platen glass. Double-sided documents cannot be automatically scanned and sent from the ADF.

Note

- For details on the types, conditions of document, and how to load the document:

■ [Loading Originals](#)

- Flick the HOME screen, then tap  **FAX**.

■ [Using the Operation Panel](#)

The Fax standby screen is displayed.

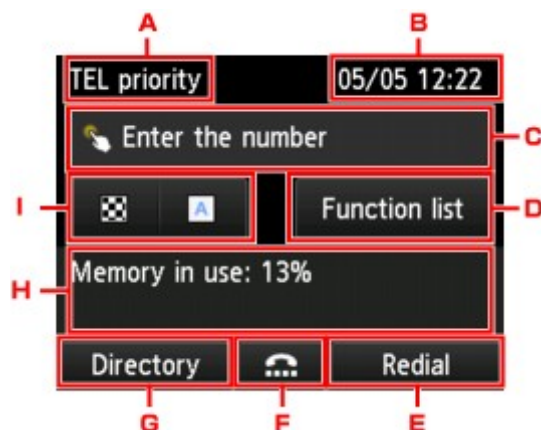

A. Receive mode

The receive mode selected currently is displayed.

B. Date and time

The date and time are displayed.

C. Entry field of fax/telephone numbers

Tap to display the screen to enter the fax/telephone numbers.

D. Function list

You can use the each fax function and change the setting for the fax.

E. Redial

Tap to send faxes with redialing.

■ [Resending Faxes \(Redialing a Busy Number\)](#)

F. On hook dial

Tap to send faxes with the on hook dial function.

■ [Using the On Hook Dial Function](#)

G. Directory

You can select a registered fax/telephone number.

■ [Sending a Fax to the Registered Recipient](#)

H. Current state

The current state is displayed.

I. Scan contrast and resolution

■ [Setting Items for Sending Faxes](#)

▶▶ Note

- If you have not set up the machine for sending/receiving faxes yet, the message for setup is displayed on the touch screen when you tap **FAX** on the HOME screen for the first time. When you set up for faxing, follow the procedure according to the instructions on the touch screen.

4. Dial the recipient's fax/telephone number.

1. Tap the entry field of fax/telephone numbers.

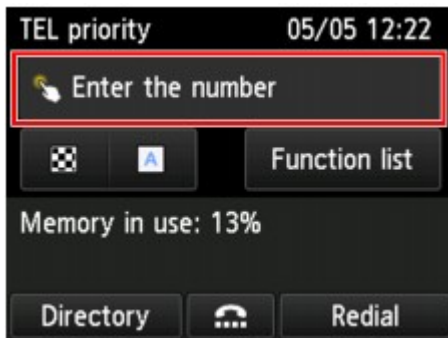

2. Enter the fax/telephone number.



- A. Numeric keys

Enters the number.

B. **Pause**

Enters a pause "P".

C. Delete

Deletes the entered number.

D. Blank space

Enters a blank space.

3. Tap **OK**.



The touch screen returns to the Fax standby screen.

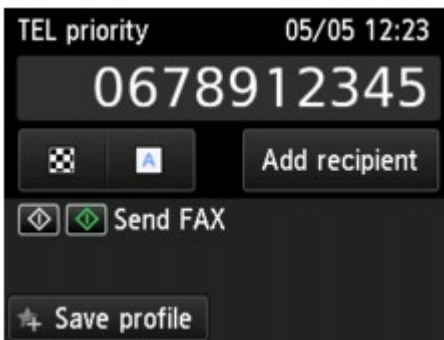

▶▶▶ **Note**

- By tapping **Save profile**, you can register the current print settings as a custom setting.
■ [Registering the Favorite Settings \(Custom profiles\)](#)

5. Press the **Color** button for color transmission, or the **Black** button for black & white transmission.

The machine starts scanning the document.

▶▶▶ **Important**

- Color transmission is available only when the recipient's fax machine supports color faxing.
- Do not open the document cover until scanning is completed.

6. Start sending.

• **If you load the document in the ADF:**

The machine scans the document automatically and starts sending the fax.

▶▶▶ Note

- To cancel a fax transmission, press the **Stop** button. To cancel a fax transmission while it is in progress, press the **Stop** button, then follow the instructions on the touch screen.
- If documents remain in the ADF after the **Stop** button is pressed while scanning is in progress, **Document in ADF. Tap [OK] to eject document.** is displayed on the touch screen. By tapping **OK**, the remaining documents are automatically ejected.

• If you load the document on the platen glass:

After scanning the document, the confirmation screen asking you if you load the next document is displayed.

To send the scanned document, tap **Send now** to start sending it.

To send two or more pages, follow the message to load the next page, and tap **Scan**. After scanning all pages, tap **Send now** to start sending.

▶▶▶ Note

- To cancel sending the fax, press the **Stop** button.

▶▶▶ Note

- When your machine is connected to a PBX (Private Branch Exchange) system, refer to the operating instructions of the system for details on dialing the recipient's fax/telephone number.
- In case the machine was not able to send a fax, such as when the recipient's line was busy, it has the function to automatically redial the number after a specified interval. Automatic redialing is enabled by default.

■ [Automatic Redialing](#)

- Unsent documents, such as those pending redial, are stored in the machine's memory. They are not stored in the case of a sending error.

■ [Document Stored in Machine's Memory](#)

- Do not unplug the power cord until all documents are sent. If you unplug the power cord, all unsent documents stored in the machine's memory are lost.

Resending Faxes (Redialing a Busy Number)

There are two methods of redialing: Automatic redialing and Manual redialing.

- Automatic Redialing

If you send a document and the recipient's line is busy, the machine will redial the number after a specified interval.

■ [Automatic Redialing](#)

- Manual Redialing

You can redial to the recipients dialed by entering the fax/telephone numbers.

■ [Manual Redialing](#)

▶▶▶ Important

- It may be possible that faxes will reach unintended recipients due to the misdialing or incorrect registration of fax/telephone numbers. When you send important documents, it is recommended that you send them after speaking on the telephone.

■ [Sending a Fax after Speaking on Telephone](#)

▶▶▶ Note

- Automatic redialing is enabled by default.
- For details on the basic sending operations:

■ [Sending Faxes by Entering Fax/Telephone Number](#)

Automatic Redialing

You can enable or disable automatic redialing. If you enable automatic redialing, you can specify the maximum number of redial attempts and the length of time the machine waits between redial attempts.

Enable and specify the automatic redialing setting on **Auto redial** in **Advanced FAX settings** under **FAX settings**.

■ [Advanced FAX settings](#)

▶▶▶ Important

- While automatic redialing, the unsent fax is stored in the machine's memory temporarily until the sending fax is complete. If a power failure occurs or you unplug the power cord before automatic redialing is complete, all faxes stored in the machine's memory are deleted and not sent.

▶▶▶ Note

- To cancel automatic redialing, wait until the machine starts redialing, then press the **Stop** button.
- To cancel automatic redialing, delete the unsent fax from the machine's memory while the machine is on-standby for a redial operation. For details, see [Deleting a Document in Machine's Memory](#).

Manual Redialing

Follow the procedure below for manual redialing.

1. [Make sure that the machine is turned on.](#)
2. [Load documents on the platen glass or in the ADF.](#)

3. Flick the HOME screen, then tap  **FAX**.

■ [Using the Operation Panel](#)

The Fax standby screen is displayed.

4. Adjust the scan contrast and resolution as necessary.

■ [Setting Items for Sending Faxes](#)

5. Tap **Redial**.

The **Redial** screen is displayed.



6. Tap a recipient's number to redial.
7. Press the **Color** button for color transmission, or the **Black** button for black & white transmission.

▶▶▶ **Important**

- Color transmission is available only when the recipient's fax machine supports color faxing.

▶▶▶ **Note**

- For manual redialing, the machine memorizes up to 10 recent recipients dialed by entering the fax/ telephone numbers. Note that the machine does not memorize any recipients dialed using the redial function or selecting from the directory.
- To cancel manual redialing, press the **Stop** button. To cancel a fax transmission while it is in progress, press the **Stop** button, then follow the instructions on the touch screen.
- If documents remain in the ADF after the **Stop** button is pressed while scanning is in progress, **Document in ADF. Tap [OK] to eject document.** is displayed on the touch screen. By tapping **OK**, the remaining documents are automatically ejected.

Setting Items for Sending Faxes

You can specify the settings of the scan contrast and the scan resolution on the Fax standby screen.

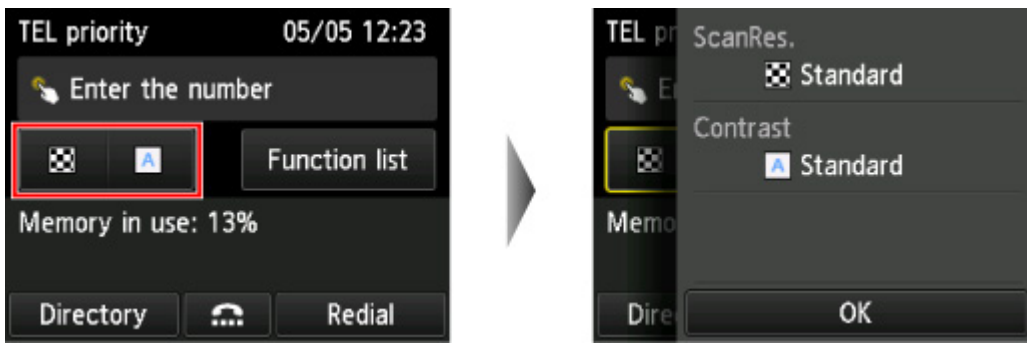

Tap to specify the settings of the scan contrast and the scan resolution.

- **ScanRes.**

The following settings of the scan resolution are selectable.

Standard

Suitable for text-only documents.

Fine

Suitable for fine-print documents.

Extra fine

Suitable for detailed illustration or fine-print quality documents.

If the recipient's fax machine is not compatible with **Extra fine** (300 x 300 dpi), the fax will be sent in the **Standard** or **Fine** resolution.

Photo

Suitable for photographs.

▶▶▶ **Note**

- When sending a color fax, documents are always scanned in the same resolution (200 x 200 dpi). The image quality (compression rate) is determined by which scan resolution is selected, except that **Extra fine** and **Photo** provide the same image quality.

- **Contrast**

You can select a setting of the scan contrast from **Lower**, **Standard**, and **Higher**.

The touch screen returns to the Fax standby screen when you finish specifying the setting and tapping **OK**.

Sending Faxes Using Useful Functions

- ▶ **Sending a Fax after Speaking on Telephone**
- ▶ **Sending a Fax to the Registered Recipient**
- ▶ **Sending the Same Document to Several Recipients (Sequential Broadcasting)**
- ▶ **Preventing Mistransmission of Faxes**
- ▶ **Using the On Hook Dial Function**

Sending a Fax after Speaking on Telephone

If you want to speak to the recipient before sending a fax, or if the recipient does not have a fax machine that can receive faxes automatically, send a fax manually after speaking to the recipient on the telephone to check whether the recipient can receive faxes.

▶▶▶ Important

- It may be possible that faxes will reach unintended recipients due to the misdialing or incorrect registration of fax/telephone numbers. When you send important documents, it is recommended that you send them after speaking on the telephone. See below for the procedure to send a fax manually.
- With manual transmission, you cannot use the platen glass to load documents. Load the documents in the ADF.

When loading document on the platen glass, send a fax with automatic transmission.

■ [Sending Faxes by Entering Fax/Telephone Number](#)

- To speak to the recipient before sending a fax, you need to connect a telephone to the machine.
For details on how to connect the telephone to the machine:

■ [Basic Connection](#)

▶▶▶ Note

- For details on the basic sending operations:
■ [Sending Faxes by Entering Fax/Telephone Number](#)

1. [Make sure that the machine is turned on.](#)

2. Flick the HOME screen, then tap  **FAX**.

■ [Using the Operation Panel](#)

The Fax standby screen is displayed.

3. Adjust the scan contrast and resolution as necessary.

■ [Setting Items for Sending Faxes](#)

4. Lift the handset of the telephone connected to the machine.
5. Use the telephone to dial the recipient's fax/telephone number.
6. Speak to the recipient.

When you hear a high-pitched signal instead of the recipient's voice, you cannot check whether the recipient can receive faxes. If you want to stop sending the fax, replace the handset. If you want to send the fax, go to step 8.

7. Ask the recipient to set the recipient's fax machine to receive faxes.

8. When you hear a high-pitched signal, press the **Color** button or the **Black** button.

Press the **Color** button for color transmission, or the **Black** button for black & white transmission.

▶▶▶ Important

- Color transmission is available only when the recipient's fax machine supports color faxing.

9. Hang up the handset.

▶▶▶ Note

- To cancel a fax transmission, press the **Stop** button. To cancel a fax transmission while it is in progress, press the **Stop** button, then follow the instructions on the touch screen.
- If documents remain in the ADF after the **Stop** button is pressed while scanning is in progress, **Document in ADF. Tap [OK] to eject document.** is displayed on the touch screen. By tapping **OK**, the remaining documents are automatically ejected.

Sending a Fax to the Registered Recipient

Registering recipient's fax/telephone number and name in the machine's directory enables you to send faxes easily.

▶▶▶ Important

- It may be possible that faxes will reach unintended recipients due to the misdialing or incorrect registration of fax/telephone numbers. When you send important documents, it is recommended that you send them after speaking on the telephone.

■ [Sending a Fax after Speaking on Telephone](#)

▶▶▶ Note

- For details on the basic sending operations:

■ [Sending Faxes by Entering Fax/Telephone Number](#)

1. [Make sure that the machine is turned on.](#)
2. [Load documents on the platen glass or in the ADF.](#)

3. Flick the HOME screen, then tap  **FAX**.

■ [Using the Operation Panel](#)

The Fax standby screen is displayed.

4. Adjust the scan contrast and resolution as necessary.

■ [Setting Items for Sending Faxes](#)

5. Tap **Directory**.

The screen to select a registered recipient is displayed.

6. Select a registered recipient.

Display by name

Display by ID number

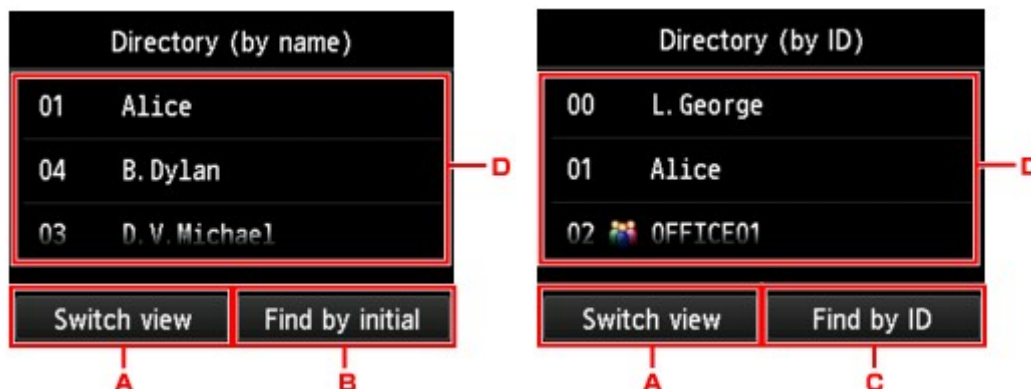

- A. Tap to switch the display by name and by ID number.

- B. Tap to display the screen to select an initial. You can search the registered recipient by initial.



By selecting the initial, the registered recipients are displayed in alphabetical order from the selected character.

- C. Tap to display the screen to select an ID number of the registered recipient. You can search the registered recipient by ID number.



By enter the ID number and tapping **OK**, the registered recipients are displayed in order from the recipient of the ID number selected.

- D. Tap to select a registered recipient.

The touch screen returns to the Fax standby screen.

7. Press the **Color** button for color transmission, or the **Black** button for black & white transmission.

▶▶▶ Important

- Color transmission is available only when the recipient's fax machine supports color faxing.

▶▶▶ Note

- To cancel a fax transmission, press the **Stop** button. To cancel a fax transmission while it is in progress, press the **Stop** button, then follow the instructions on the touch screen.
- If documents remain in the ADF after the **Stop** button is pressed while scanning is in progress, **Document in ADF. Tap [OK] to eject document.** is displayed on the touch screen. By tapping **OK**, the remaining documents are automatically ejected.
- In case the machine was not able to send a fax, such as when the recipient's line was busy, it has the function to automatically redial the number after a specified interval. Automatic redialing is enabled by default.

■ Automatic Redialing

To cancel automatic redialing, wait until the machine starts redialing, then press the **Stop** button.

Sending the Same Document to Several Recipients (Sequential Broadcasting)

This machine allows you to prepare for sending the same document to a maximum of 101 recipients in one operation. The recipients can be specified by entering the fax/telephone numbers and selecting the registered recipients (the particular recipient's number and the group dial) in combination.

The following number of recipients can be specified in combination.

- The recipient registered to the machine:
Up to 100 (total of the particular recipient's number and the group dial)
- Entering the fax/telephone numbers or redialing:
1

▶▶▶ Important

- It may be possible that faxes will reach unintended recipients due to the misdialing or incorrect registration of fax/telephone numbers. When you send important documents, it is recommended that you send them one by one after speaking on the telephone.

■ [Sending a Fax after Speaking on Telephone](#)

▶▶▶ Note

- If you frequently send documents to the same group of recipients, you can group these numbers for group dialing. This will allow you to send documents to all the recipients in the group by simply operation.

■ [Registering Recipients in Group Dial](#)

- For details on the basic sending operations:

■ [Sending Faxes by Entering Fax/Telephone Number](#)

1. [Make sure that the machine is turned on.](#)
2. [Load documents on the platen glass or in the ADF.](#)



3. Flick the HOME screen, then tap **FAX**.

■ [Using the Operation Panel](#)

The Fax standby screen is displayed.

4. Adjust the scan contrast and resolution as necessary.

■ [Setting Items for Sending Faxes](#)

5. Specify the first recipient.

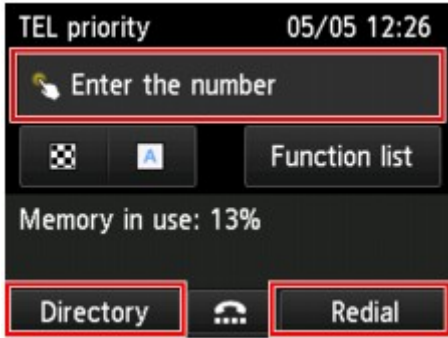

Specify the first recipient with the one of the following methods.

- By specifying with the recipient registered to the machine:
Tap **Directory** and specify the recipient.
[■ Sending a Fax to the Registered Recipient](#)
- By entering the fax/telephone numbers:
Tap the entry field of fax/telephone numbers and enter the number.
[■ Sending Faxes by Entering Fax/Telephone Number](#)

▶▶▶ Note

- If **FAX number re-entry** in **Security control** under **FAX settings** is set to **ON**, enter the number again.

[■ Security control](#)

- By redialing:
Tap **Redial** and select a number in the outgoing call logs.
[■ Manual Redialing](#)

6. Add the recipient.

1. Tap **Add recipient**.

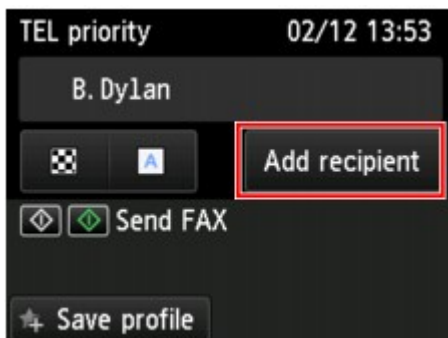

The list of the recipients is displayed.

2. Select a method to add the recipient.

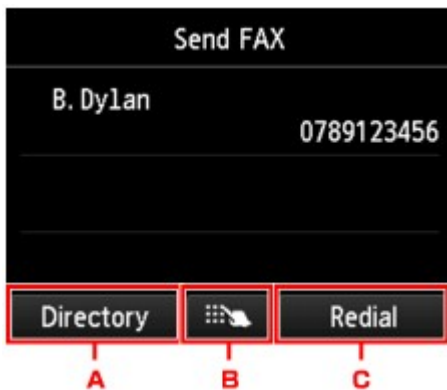

- A. Adds the recipient from the registered recipients.
 - B. Adds the recipient by entering the fax/telephone numbers if you added a first recipient from the registered recipients.
 - C. Adds the recipient by selecting a number from the outgoing call logs if you added a first recipient from the registered recipients.
3. Add a recipient.
- Add a recipient according to the selected method.

The **Sequential broadcasting** screen is displayed after specifying the multiple recipients.

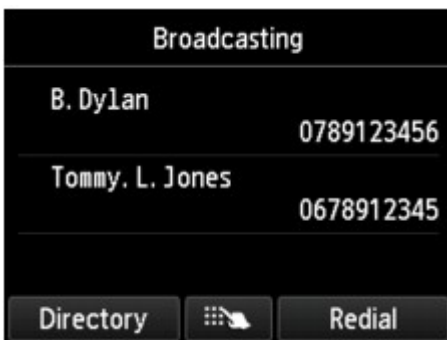

- 4. If you want to add the recipient further, repeat the same procedure.

▶▶▶ Note

- You can specify the recipient either by entering the fax/telephone number or by selecting a number from the outgoing call logs.
- If you want to delete the recipient, tap a recipient that you want to delete from the list. After the confirmation screen is displayed, tap **Yes** to delete the recipient.

- 7. Press the **Color** button for color transmission, or the **Black** button for black & white transmission.

▶▶▶ Important

- Color transmission is available only when the recipient's fax machine supports color faxing.

▶▶▶ Note

- To cancel a fax transmission, press the **Stop** button. To cancel a fax transmission while it is in progress, press the **Stop** button, then follow the instructions on the touch screen.
- When you press the **Stop** button, fax transmission to all the recipients specified will be canceled. You cannot cancel a fax transmission to only one recipient.

- If documents remain in the ADF after the **Stop** button is pressed while scanning is in progress, **Document in ADF. Tap [OK] to eject document.** is displayed on the touch screen. By tapping **OK**, the remaining documents are automatically ejected.
-

Preventing Mistransmission of Faxes

This machine has two functions for preventing the mistransmission of faxes.

- Sending faxes after entering the fax/telephone number twice

This function requires you to re-enter the fax/telephone number after entering the number, so that the machine prevents you from misdialing.

■ [Sending Faxes after Dialing Twice \(Fax Number Re-entry\)](#)

- Sending faxes after the machine checks the recipient's fax machine information

Before sending a fax, the machine checks whether the recipient's fax machine information matches the dialed number.

■ [Sending Faxes after Checking Information \(Checking the Recipient's Information\)](#)

Sending Faxes after Dialing Twice (Fax Number Re-entry)

Set **FAX number re-entry** to **ON** following the procedure below.

1. [Make sure that the machine is turned on.](#)

2. Flick the HOME screen, then tap  **Setup**.

■ [Using the Operation Panel](#)

3. Tap  **Device settings**.

4. Tap **FAX settings**.

5. Tap **Security control**.

6. Tap **FAX number re-entry**.

7. Tap **ON**.

If you send a fax with this function, the following screen is displayed after entering the recipient's fax/telephone number.

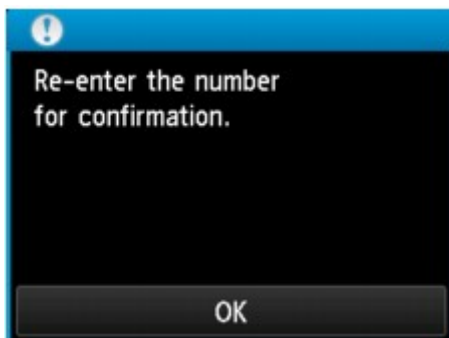

Enter the recipient's fax/telephone number again.

Sending Faxes after Checking Information (Checking the Recipient's Information)

Set **Check RX FAX information** to **ON** following the procedure below.

▶▶ Important

- This function is not available when you send a fax manually.

■ [Sending a Fax after Speaking on Telephone](#)

1. [Make sure that the machine is turned on.](#)

2. Flick the HOME screen, then tap  **Setup**.

■ [Using the Operation Panel](#)

3. Tap  **Device settings**.

4. Tap **FAX settings**.

5. Tap **Security control**.

6. Tap **Check RX FAX information**.

7. Tap **ON**.

▶▶ Important

- Transmission will be canceled if the machine fails to receive the recipient's fax information or if the received information does not match the fax/telephone number.

Using the On Hook Dial Function

Follow the procedure below to send faxes with the on hook dial function.

▶▶▶ Important

- It may be possible that faxes will reach unintended recipients due to the misdialing or incorrect registration of fax/telephone numbers. When you send important documents, it is recommended that you send them after speaking on the telephone.

■ [Sending a Fax after Speaking on Telephone](#)

- With manual transmission, you cannot use the platen glass to load documents. Load the documents in the ADF.

When loading document on the platen glass, send a fax with automatic transmission.

■ [Sending Faxes by Entering Fax/Telephone Number](#)

▶▶▶ Note

- You can use the on hook dial function only when **Hook key setting** in **Security control** under **FAX settings** is set to **Enable**.

■ [Security control](#)

- For details on the basic sending operations:

■ [Sending Faxes by Entering Fax/Telephone Number](#)

1. [Make sure that the machine is turned on.](#)

2. [Load documents in the ADF.](#)

3. Flick the HOME screen, then tap  **FAX**.

■ [Using the Operation Panel](#)

The Fax standby screen is displayed.

4. Adjust the scan contrast and resolution as necessary.

■ [Setting Items for Sending Faxes](#)

5. Tap .

6. Specify the recipient.

Specify the recipient with the one of the following methods.

- By specifying with the recipient registered to the machine:

Select the registered recipient by tapping **Directory**.

■ [Sending a Fax to the Registered Recipient](#)

- By entering the fax/telephone numbers:

Tap the entry field of fax/telephone numbers and enter the number.

■ [Sending Faxes by Entering Fax/Telephone Number](#)

▶▶▶ Note

- If **FAX number re-entry** in **Security control** under **FAX settings** is set to **ON**, enter the number again.

■ [Security control](#)

- Manual redialing:

Tap **Redial** and select a number in the outgoing call logs.

■ [Manual Redialing](#)

7. When you hear a high-pitched signal, press the **Color** button or the **Black** button.

Press the **Color** button for color transmission, or the **Black** button for black & white transmission.

▶▶▶ Important

- Color transmission is available only when the recipient's fax machine supports color faxing.

▶▶▶ Note

- To cancel a fax transmission, press the **Stop** button. To cancel a fax transmission while it is in progress, press the **Stop** button, then follow the instructions on the touch screen.
- If documents remain in the ADF after the **Stop** button is pressed while scanning is in progress, **Document in ADF. Tap [OK] to eject document.** is displayed on the touch screen. By tapping **OK**, the remaining documents are automatically ejected.

Registering Recipients

- ▶ **Registering Recipients Using the Operation Panel of the Machine**
- ▶ **Registering Recipients Using Speed Dial Utility**

Registering Recipients Using the Operation Panel of the Machine

Registering recipients in the machine's directory in advance allows you to dial fax/telephone numbers simply.

The following methods to register are available:

- Recipient registration

Registering the recipient's fax/telephone number and name allows you to send a fax by selecting a registered recipient in the machine directory.

■ [Registering the Fax/Telephone Number of Recipients](#)

- Group dial registration

You can combine two or more recipients registered in advance into a group. You can send the same document to all the registered recipients in the group.

■ [Registering Recipients in Group Dial](#)

You can register up to 100 recipients in total of individual recipients and group dials.

▶▶ Note

- To change the registered information of the recipient or the group dial, see [Changing Registered Information](#).
- To delete the registered information of the recipient or the group dial, see [Deleting Registered Information](#).
- To print a list of the recipient's fax/telephone numbers and names registered, see [Printing a List of the Registered Destinations](#).
- You can register, change, or delete the registered information of the recipient or the group dial using Speed Dial Utility on the computer.

■ [Registering Recipients Using Speed Dial Utility](#)

Registering the Fax/Telephone Number of Recipients

Before you can use the machine's directory, you need to register the recipients' fax/telephone numbers. Follow the procedure below to register the recipients' fax/telephone numbers.

1. [Make sure that the machine is turned on.](#)

2. Flick the HOME screen, then tap  **FAX**.

■ [Using the Operation Panel](#)

The Fax standby screen is displayed.

3. Tap **Function list**.

The **Function list** screen is displayed.

4. Tap **TEL number registration**.

5. Tap **Directory registration**.

The screen to select an ID number is displayed.



▶▶ Note

- If you already registered the recipients, the recipients' name is displayed next to the ID number. If you already registered the group dial, the  icon and the group name are displayed next to the ID number.

6. Select an unregistered ID number.
7. Tap **Register recipient**.
8. Select a registration method.
9. Register the recipients' fax/telephone number.

Register the recipients' fax/telephone number depending on the registration method selected.

- **By entering the number**

The screen to register the recipient's fax/telephone number and name is displayed. Go to next step.

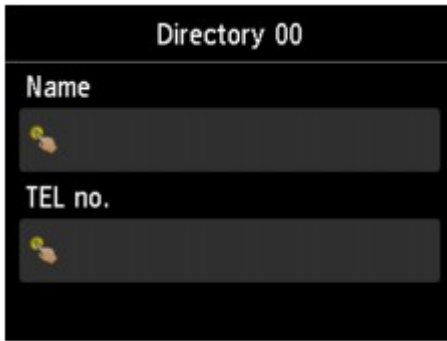

- **From outgoing call log**

When you select this registration method, the screen to select the fax/telephone number from the outgoing call logs is displayed.



Selecting a fax/telephone number from the outgoing call logs, the screen to register the recipient's fax/telephone number and name is displayed. Go to next step.

- **From incoming call log**

When you select this registration method, the screen to select the fax/telephone number or the name from the incoming call logs is displayed.



Select a fax/telephone number or name from the incoming call logs, the screen to register the recipient's fax/telephone number and name is displayed. Go to next step.

▶▶▶ Note

- This registration method may not be available depending on the country or region of purchase.

10. Enter the recipient's name.

If you select **From incoming call log** as a registration method, the recipient's name may be already entered. If you do not change the name, go to next step.

1. Tap the entry field of name.

The screen to enter the character is displayed.

2. Enter the recipient's name.

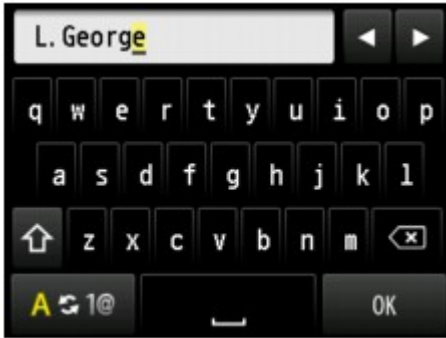

3. Tap **OK**.

▶▶▶ Note

- You can enter the name up to 16 characters, including spaces.

■ [Entering Numbers, Letters, and Symbols](#)

11. Enter the recipient's fax/telephone number.

If you select a fax/telephone number on **From outgoing call log** or **From incoming call log**, the fax/telephone number is already entered. If you do not change the fax/telephone number, go to next step.

1. Tap the entry field of fax/telephone numbers.

The screen to enter the number is displayed.

2. Enter the recipient's fax/telephone number.



3. Tap **OK**.

▶▶▶ Note

- You can enter the fax/telephone number up to 60 digits (40 digits for the US, Canada, Korea and some regions of Latin America), including spaces.

■ [Entering Numbers, Letters, and Symbols](#)

- When **Telephone line type** in **FAX user settings** under **FAX settings** is set to **Rotary pulse**, you can enter a tone ("T") by tapping the Tone key.

12. Tap **Register** to finalize registration.

»» Note

- To register another recipient's number and name, select an unregistered ID number and operate in the same procedure.
- You can check the recipient's numbers and names you have registered by printing RECIPIENT TELEPHONE NUMBER LIST.

■ [Printing a List of the Registered Destinations](#)

Registering Recipients in Group Dial

If you register two or more registered recipients to a group dial, you can send the same document successively to all recipients registered to the group dial.

1. [Make sure that the machine is turned on.](#)

2. Flick the HOME screen, then tap  **FAX**.

■ [Using the Operation Panel](#)

The Fax standby screen is displayed.

3. Tap **Function list**.

The **Function list** screen is displayed.

4. Tap **TEL number registration**.

5. Tap **Directory registration**.

The screen to select an ID number is displayed.



▶▶ Note

- If you already registered the recipients, the recipients' name is displayed next to the ID number. If you already registered the group dial, the  icon and the group name are displayed next to the ID number.

6. Select an unregistered ID number.

7. Tap **Group dial registration**.

The screen to register the group name and the member of the group is displayed.

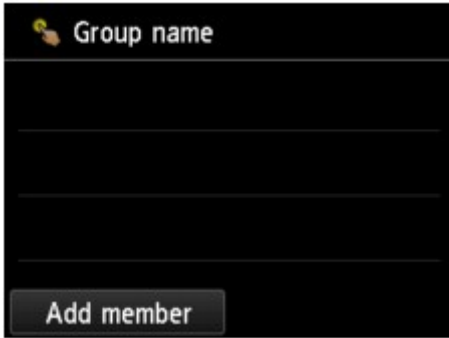

8. Enter the group name.

1. Tap the entry field of group name.
The screen to enter the character is displayed.
2. Enter the group name.



3. Tap OK.

►► Note

- You can enter the name up to 16 characters, including spaces.

■ [Entering Numbers, Letters, and Symbols](#)

9. Register the members.

1. Tap **Add member**.
The machine's directory is displayed.

Display by name

Display by ID number

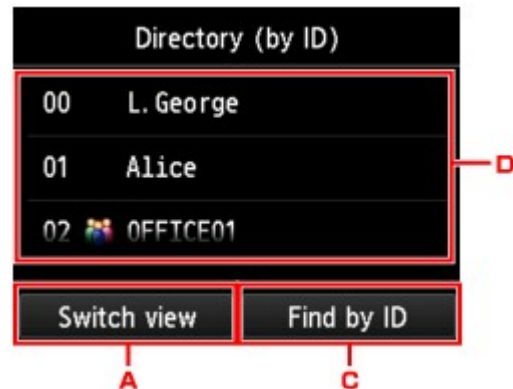
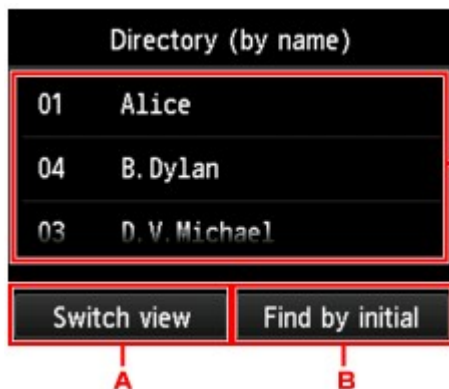

- A. Tap to switch the display by name and by ID number.

B. Tap to display the screen to select an initial. You can search the registered recipient by initial.



By selecting the initial, the registered recipients are displayed in alphabetical order from the selected character.

C. Tap to display the screen to select an ID number of the registered recipient. You can search the registered recipient by ID number.

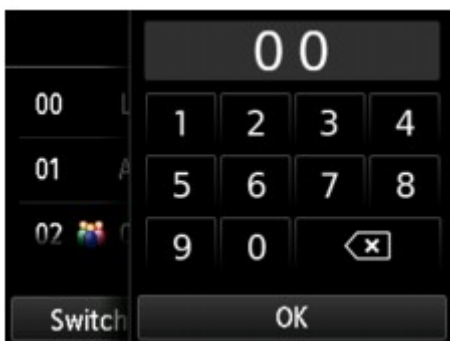

By enter the ID number and tapping **OK**, the registered recipients are displayed in order from the recipient of the ID number selected.

D. The recipients that can be registered are displayed.

2. Tap a recipient to register as group member.

The member to register is displayed on the list.



»» Note

- To delete the recipient from the group dial, tap a recipient that you want to delete from the list. After the confirmation screen is displayed, tap **Yes** to delete the recipient from the group dial.

3. To add another member, tap **Add member** again.

The machine's directory is displayed.

4. Tap a recipient to register as group member.

The member to register is displayed on the list.



Repeat the procedure to register another member to the same group dial.

10. Tap **Complete** to finalize registration.

▶▶ **Note**

- To register another group, select an unregistered ID number and operate in the same procedure.
- You can check the recipients you have registered to the group dial by printing GROUP DIAL TELEPHONE NO. LIST.

■ [Printing a List of the Registered Destinations](#)

Changing Registered Information

To change information registered for recipient and group dial, follow the procedure below.

1. [Make sure that the machine is turned on.](#)



2. Flick the HOME screen, then tap **FAX**.

■ [Using the Operation Panel](#)

The Fax standby screen is displayed.

3. Tap **Function list**.

The **Function list** screen is displayed.

4. Tap **TEL number registration**.

5. Tap **Directory registration**.

6. Tap a recipient or a group dial to change.

7. Change the registered information.

- To change an individual recipient:

1. Tap **Edit recipient**.

The registered information screen of the selected recipient is displayed.

2. Tap the entry field of name or the entry field of fax/telephone numbers.

The each edit screen is displayed.

3. Change the name or the fax/telephone numbers.

4. Tap **OK**.

The touch screen returns to the registered information screen.

5. Tap **Register**.

- To change a group dial:

1. Tap **Edit group dial**.

The registered information screen of the group dial is displayed.

2. To change the group name, tap the entry field of name.

When edit screen of group name is displayed, change the group name then tap **OK**.

3. To add the member, tap **Add member**.

When the machine's directory is displayed, tap the recipient you want to add.

4. To delete the member, tap the recipient on the list.

When the confirmation screen is displayed, tap **Yes** to delete the recipient from the group dial.

5. Tap **Complete** to finalize changing.

Deleting Registered Information

To delete information registered for recipient and group dial, follow the procedure below.

1. [Make sure that the machine is turned on.](#)



2. Flick the HOME screen, then tap **FAX**.

■ [Using the Operation Panel](#)

The Fax standby screen is displayed.

3. Tap **Function list**.

The **Function list** screen is displayed.

4. Tap **TEL number registration**.

5. Tap **Directory registration**.

6. Tap a recipient or a group dial to delete.

7. Delete the registered information.

- To delete an individual recipient:
 1. Tap **Delete recipient**.
 2. When the confirmation screen is displayed, tap **Yes** to delete.
- To delete a group dial:
 1. Tap **Delete group dial**.
 2. When the confirmation screen is displayed, tap **Yes** to delete.

Printing a List of the Registered Destinations

You can print a list of the fax/telephone numbers and can keep it near the machine to refer to when dialing.

1. [Make sure that the machine is turned on.](#)
2. [Load paper.](#)



3. Flick the HOME screen, then tap **FAX**.

■ [Using the Operation Panel](#)

The Fax standby screen is displayed.

4. Tap **Function list**.

The **Function list** screen is displayed.

5. Tap **Print reports/lists**.

6. Tap **Directory list**.

7. Tap an item to print.

- If you selected **Recipient**:

The confirmation screen to select whether to print the list in alphabetical order of the registered names is displayed.

If you tap **Yes**: Prints RECIPIENT TELEPHONE NUMBER LIST with the destination names in alphabetical order.

If you tap **No**: Prints RECIPIENT TELEPHONE NUMBER LIST in the order of the ID number.

- If you selected **Group dial**:

The printing confirmation screen is displayed. Tap **Yes** to print GROUP DIAL TELEPHONE NO. LIST.

Registering Recipients Using Speed Dial Utility

About Speed Dial Utility

Speed Dial Utility is a utility for forwarding the fax/telephone numbers registered on the machine to a computer and registering/changing them on the computer. In addition, you can register the fax/telephone number, user's name, user's fax/telephone number, and rejected numbers edited on the computer to the machine. You can also save them on the computer as a backup.

For safety reasons, it is recommended that you backup the registered data on the computer using Speed Dial Utility.

■ [Starting Up Speed Dial Utility](#)

■ [Speed Dial Utility Dialog](#)

■ [Saving Registered Information on the Machine to Your Computer](#)

■ [Registering a Fax/telephone Number Using Speed Dial Utility](#)

■ [Changing a Fax/telephone Number Using Speed Dial Utility](#)

■ [Deleting a Fax/telephone Number Using Speed Dial Utility](#)

■ [Changing Sender Information Using Speed Dial Utility](#)

■ [Registering/Changing Rejected Number Using Speed Dial Utility](#)

■ [Calling the Registered Information Up from Your Computer and Registering the Information to the Machine](#)

■ [Uninstalling Speed Dial Utility](#)

Starting Up Speed Dial Utility

Before starting up Speed Dial Utility, confirm the following:

- **The necessary application software (printer driver and Speed Dial Utility) is installed.**

If the printer driver or Speed Dial Utility is not yet installed, install them from our website.

- **The machine is connected to a computer correctly.**

Make sure that the machine is connected to the computer correctly.

Do not plug in or unplug any cables while the machine is in operation, or when the computer is in sleep or standby mode.

If your machine is compatible with LAN connection, make sure that the machine is connected to the computer with LAN connection to use Speed Dial Utility via LAN connection.

Follow the procedure below to start up Speed Dial Utility.

1. Make sure that the machine is turned on.
2. Select **Applications** on the **Go** menu of Finder.
3. Double-click the **Canon Utilities** folder.
4. Double-click the **Speed Dial Utility** folder.
5. Double-click **Speed Dial Utility**.

Speed Dial Utility starts up.

Note

- You can also start up Speed Dial Utility from Quick Menu or Quick Toolbox.

Speed Dial Utility Dialog

The following items are on the **Speed Dial Utility** dialog.

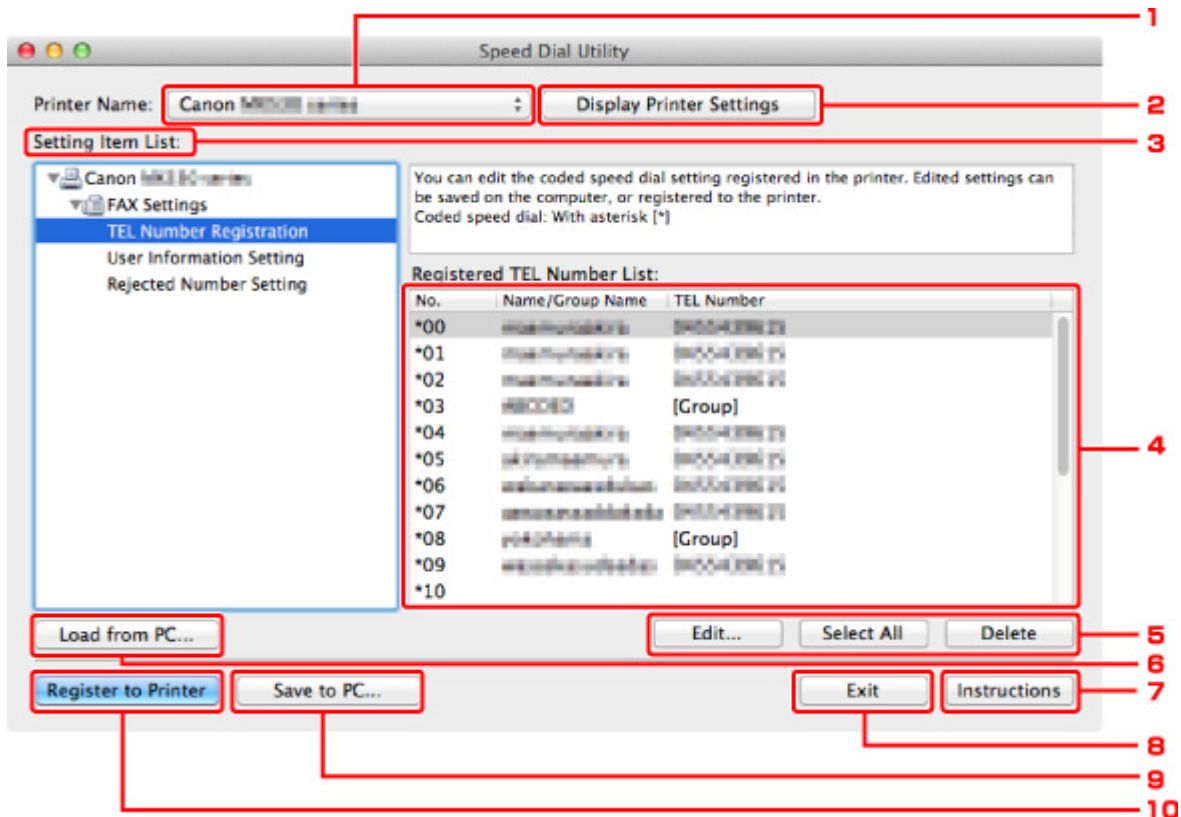

1. Printer Name:

Selects the machine for editing the registered information using Speed Dial Utility.

2. Display Printer Settings

Loads the registered information on the machine selected for **Printer Name**: into Speed Dial Utility.

3. Setting Item List:

Selects the registered information for editing. Choose one item from **TEL Number Registration**, **User Information Setting**, and **Rejected Number Setting**.

4. Registered information list

Displays the registered information selected for **Setting Item List**.

5. Edit.../Select All/Delete

Edits/deletes the registered information or selects all the registered information selected for **Setting Item List**.

When multiple items on the registered information list are selected, you cannot use the **Edit...** button.

6. Load from PC...

Displays the registered information saved on the computer.

7. **Instructions**

Displays this guide.

8. **Exit**

Quits Speed Dial Utility. Information registered or edited using Speed Dial Utility is neither saved on the computer nor registered on the machine.

9. **Save to PC...**

Saves information edited using Speed Dial Utility on the computer.

10. **Register to Printer**

Registers information edited using Speed Dial Utility to the machine.

Saving Registered Information on the Machine to Your Computer

Follow the procedure below to save the recipients' name, recipients' fax/telephone number, group dial, user's name, user's fax/telephone number, or rejected numbers that registered on the machine to the computer.

1. [Start up Speed Dial Utility.](#)
2. Select the machine from the **Printer Name:** list box, then click **Display Printer Settings.**
3. Click **Save to PC....**
4. Enter the file name on the displayed screen, then click **Save.**

Registering a Fax/telephone Number Using Speed Dial Utility

Follow the procedure below to register fax/telephone numbers.

►►► Note

- Before you register fax/telephone numbers using Speed Dial Utility, make sure that no fax operations are in progress.

1. [Start up Speed Dial Utility.](#)
2. Select the machine from the **Printer Name:** list box, then click **Display Printer Settings.**
3. Click **TEL Number Registration** from **Setting Item List:**.
The list of registered fax/telephone numbers is displayed.
4. Select an unoccupied code from the list, then click **Edit....**
The **Individual or Group Selection** dialog is displayed.
5. Click **Register individual TEL number** or **Register group dial**, then click **Next....**

- If **Register individual TEL number** is selected:

Individual TEL Number Registration

No.: *00

Name:

TEL Number:

OK Cancel

1. Enter the name.
2. Enter the fax/telephone number.

- If **Register group dial** is selected:

Group Dial Registration

No.: *00

Group Name:

Registered TEL Number List:

No.	Name/Group Name	TEL Number
*01	masamurabira	0811409805
*02	masamurabira	0811409805
*03	ABCDEF	[Group]
*04	masamurabira	0811409805
*05	masamurabira	0811409805
*06	masamurabira	0811409805
*07	masamurabira	0811409805
*08		

Group Dial List:

No.	Member	TEL Number
-----	--------	------------

Add >> << Delete

OK Cancel

1. Enter the group name.
2. Select the code you want to add to the group dial, then click **Add >>**.

»» **Note**

- You can only enter numbers that have already been registered.

6. Click **OK**.

To continue registering fax/telephone numbers or a group dial, repeat steps 4 to 6.

- To save the registered information on the computer.
 1. Click **Save to PC...**
 2. Enter the file name on the displayed screen, then click **Save**.
- To register the registered information to the machine:
 1. Click **Register to Printer**.
 2. Confirm the message on the display, then click **OK**.

The information is registered to the machine.

Changing a Fax/telephone Number Using Speed Dial Utility

Follow the procedure below to change fax/telephone numbers.

►► Note

- Before you change fax/telephone numbers using Speed Dial Utility, make sure that no fax operations are in progress.

1. [Start up Speed Dial Utility.](#)
2. Select the machine from the **Printer Name:** list box, then click **Display Printer Settings.**
3. Click **TEL Number Registration** from **Setting Item List:**.
The list of registered fax/telephone numbers is displayed.
4. Select a code to change from the list, then click **Edit...**

- If an individual fax/telephone number is selected:

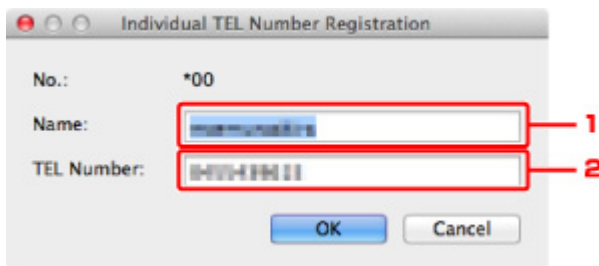

1. Enter the new name.
2. Enter the new fax/telephone number.

- If a group dial is selected:

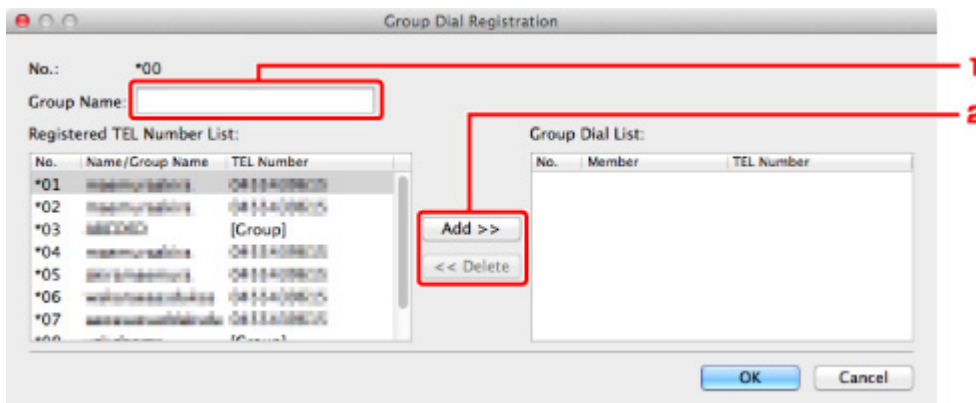

1. Enter the new group name.
2. Add or delete a member to/from the group dial.

To add a member:

Select the code to add to the group dial, then click **Add >>**.

To delete a member:

Select the code to delete from the group dial, then click **<< Delete**.

5. Click **OK**.

To continue changing fax/telephone numbers or group dials, repeat steps 4 and 5.

- To save the edited information on the computer.
 1. Click **Save to PC....**
 2. Enter the file name on the displayed screen, then click **Save**.
- To register the edited information to the machine:
 1. Click **Register to Printer**.
 2. Confirm the message on the display, then click **OK**.

The information is registered to the machine.

Deleting a Fax/telephone Number Using Speed Dial Utility

Follow the procedure below to delete fax/telephone numbers.

»» Note

- Before you delete fax/telephone numbers using Speed Dial Utility, make sure that no fax operations are in progress.

1. [Start up Speed Dial Utility.](#)
2. Select the machine from the **Printer Name:** list box, then click **Display Printer Settings.**
3. Click **TEL Number Registration** from **Setting Item List:**
The list of registered fax/telephone numbers is displayed.
4. Select a code to delete from the list, then click **Delete.**

The selected fax/telephone number is deleted.

To continue deleting fax/telephone numbers, repeat step 4.

»» Note

- To delete all fax/telephone numbers on the list, click **Select All**, then **Delete.**

- To save the edited information on the computer.

1. Click **Save to PC....**
2. Enter the file name on the displayed screen, then click **Save.**

- To register the edited information to the machine:

1. Click **Register to Printer.**
2. Confirm the message on the display, then click **OK.**

The information is registered to the machine.

Changing Sender Information Using Speed Dial Utility

Follow the procedure below to change the user's name or fax/telephone number.

1. [Start up Speed Dial Utility.](#)

2. Select the machine from the **Printer Name:** list box, then click **Display Printer Settings.**

3. Click **User Information Setting** from **Setting Item List:**

The user's information is displayed.

4. Select an item to change, then click **Edit....**

The **User Information** dialog is displayed.

5. Enter the new user's name on **User Name** and new fax/telephone number in **TEL Number**, then click **OK.**

- To save the edited information on the computer:

1. Click **Save to PC....**

2. Enter the file name on the displayed screen, then click **Save.**

- To register the edited information to the machine:

1. Click **Register to Printer.**

2. Confirm the message on the display, then click **OK.**

The information is registered to the machine.

Registering/Changing Rejected Number Using Speed Dial Utility

Follow the procedure below to register, change, or delete rejected numbers.

1. [Start up Speed Dial Utility.](#)
2. Select the machine from the **Printer Name:** list box, then click **Display Printer Settings.**
3. Click **Rejected Number Setting** from **Setting Item List:**.

The list of rejected numbers is displayed.

- To register a rejected number:
 1. Select an unoccupied code from the list, then click **Edit....**
 2. Enter the fax/telephone number in the **Rejected Number** dialog, then click **OK.**
- To change a rejected number:
 1. Select a code to change from the list, then click **Edit....**
 2. Enter the fax/telephone number in the **Rejected Number** dialog, then click **OK.**
- To delete a rejected number:
 1. Select a code to delete from the list, then click **Delete.**

The selected fax/telephone number is deleted.

Note

- To delete all fax/telephone numbers on the list, click **Select All**, then **Delete.**

Calling the Registered Information Up from Your Computer and Registering the Information to the Machine

You can register the fax/telephone numbers, user's name, user's fax/telephone number, and rejected numbers saved on the computer to the machine.

1. [Start up Speed Dial Utility.](#)
2. Select the machine from the **Printer Name:** list box, then click **Display Printer Settings.**
3. Click **Load from PC....**
4. Select the RSD file (*.rsd) to register to the machine.
5. Click **Open** on the dialog.
6. Click **Register to Printer.**

The registered information on the computer is registered to the machine.

Uninstalling Speed Dial Utility

Follow the procedure below to uninstall Speed Dial Utility.

1. Select **Applications** from the **Go** menu of Finder, double-click **Canon Utilities > Speed Dial Utility**, then drag the **Speed Dial Utility** icon into the trash.

Note

- To reinstall Speed Dial Utility, uninstall Speed Dial Utility, then install it again from our website.

Receiving Faxes

- ▶ **Receiving Faxes**
- ▶ **Changing the Paper Settings**
- ▶ **Memory Reception**
- ▶ **Receiving Faxes Using Useful Functions**

Receiving Faxes

This section describes the preparation necessary for receiving a fax and how to receive a fax.

Preparing for Receiving a Fax

Prepare for receiving a fax according to the following procedure.

1. [Make sure that the machine is turned on.](#)

2. Flick the HOME screen, then tap  **FAX**.

■ [Using the Operation Panel](#)

The Fax standby screen is displayed.

3. Make sure of the receive mode setting.

Make sure of the receive mode setting displayed on the Fax standby screen.

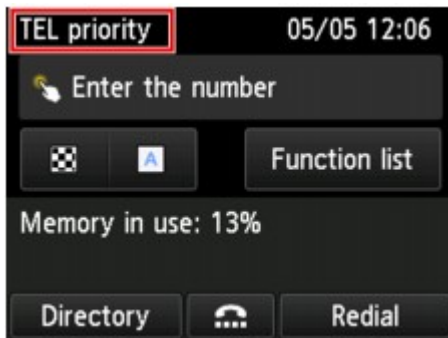

▶▶▶ Note

- For details on how to change the receive mode:

■ [Setting the Receive Mode](#)

4. [Load paper.](#)

Load the sheets of plain paper.

5. Specify the paper settings as necessary.

■ [Changing the Paper Settings](#)

This completes the preparation for receiving fax.

When a fax is received, it is printed on the loaded paper automatically.

Receiving a Fax

Depending on the selected receive mode, the receive operation varies.

▶▶▶ Note

- For details on the receive mode:

■ [Setting the Receive Mode](#)

- You can specify the advanced settings of each receive mode.

For details on the advanced settings of the receive mode:

■ [Advanced Settings of Receive Mode](#)

- If the machine was not able to print a received fax, the machine stores the unprinted fax temporarily in its memory (memory receiving).

■ [Memory Reception](#)

- When receiving a fax, you can save received faxes on a USB flash drive as PDF files automatically or forward received faxes to the shared folder on the computer as PDF files automatically.

■ [Saving Received Faxes Automatically on a USB Flash Drive](#)

■ [Forwarding Received Faxes Automatically to Shared Folder on the Computer](#)

When TEL priority mode is selected:

- **When the call is a fax:**

The telephone will ring when a call comes.

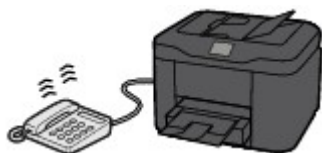

Pick up the handset. If you hear the fax tone, wait for at least 5 seconds after it stops, then hang up the handset.



The machine will receive the fax.



▶▶ Note

- If the machine will not switch to fax reception, select **FAX** again on the HOME screen, then the **Color** or **Black** button to receive the fax.
- To receive a fax without picking up the handset, select **Manual/auto switch: ON** in **Advanced**. **RX start time** allows you to specify the number of seconds until the machine switches to fax reception.
- If you have subscribed to Duplex Ringing service in Hong Kong, the telephone will ring a specified number of times when there is an incoming call with a fax distinctive ring pattern. Then, the machine will switch to fax reception automatically without the handset being picked up.
The number of times to ring the telephone until switching to fax reception can be changed.

- Set the machine to enable you to initiate fax reception from a connected telephone (remote reception).

■ [Remote Reception](#)

- **When the answering machine is connected to the machine:**

- If the answering machine is set to the answering mode, select **User-friendly RX: ON** in **Advanced**. If the call is a fax, the machine will receive the fax automatically.
- If the answering mode is turned off on the answering machine, pick up the handset. If you hear the fax tone, wait for at least 5 seconds after it stops, then hang up the handset.
- If **Manual/auto switch: ON** is selected in **Advanced**, set **RX start time** to longer than the time before the answering machine starts playing the answering message. After making this setting, we recommend that you call the answering machine using a mobile phone, etc. to confirm that messages are recorded successfully in the answering machine.
- Set your answering machine to answering mode and adjust it as follows:
 - The entire message should be no longer than 15 seconds.
 - In the message, tell your callers how to send a fax.

- **When the call is a voice call:**

The telephone will ring when a call comes in.

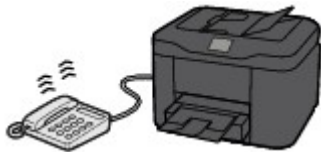

Pick up the handset, and talk on the telephone.



▶▶▶ **Note**

- If the machine unexpectedly switches to fax reception during telephone calls, select **User-friendly RX: OFF** in **Advanced**.
- If **Manual/auto switch: ON** is selected in **Advanced**, you must answer an incoming call by picking up the handset within the time specified in **RX start time**. Otherwise the machine will switch to fax reception.

When FAX only mode is selected:

- **When the call is a fax:**

The machine will receive the fax automatically.



►► Note

- If a telephone is connected to the machine, the telephone will ring when a call comes.
- You can change the number of times to ring the telephone with **Ring count** in **Advanced**.

When DRPD or Network switch is selected:

- **When the call is a fax:**

The telephone will ring when a call comes.

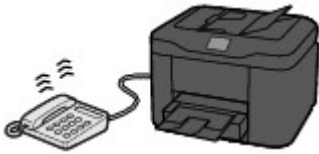

The machine will receive the fax automatically when the fax ring pattern is detected.



►► Note

- You can change the number of times to ring the telephone.
■ [Advanced Settings of Receive Mode](#)

- **When the call is a voice call:**

The telephone will ring when a call comes.

When the machine does not detect the fax ring pattern, the telephone will continue ringing.

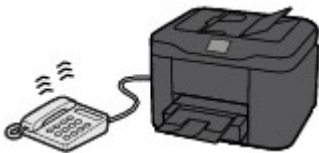

Pick up the handset, and talk on the telephone.

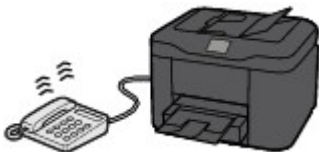

►► Note

- To use this feature, you need to subscribe to a compatible service provided by your telephone company.
- **For DRPD**
You need to select the appropriate ring pattern on the machine.
■ [Setting the DRPD Ring Pattern \(US and Canada only\)](#)
- **For Network switch**

The name of this service varies depending on the country or region of purchase. This setting may not be also available depending on the country or region of purchase.

Changing the Paper Settings

This machine prints received faxes to paper loaded in the machine beforehand. You can use the operation panel to change the paper settings for printing faxes. Make sure that the settings are appropriate for the loaded paper.

▶▶ Important

- If the size of loaded paper is different from that specified in the paper size setting, the received faxes are stored in the machine's memory and **Check the page size and tap [OK]**. is displayed on the touch screen. In this case, load the same size of paper as that specified in the paper size setting, then tap **OK**.

You can also press the **Stop** button to close the message and print the stored documents in the machine's memory later.

■ [Printing a Document in Machine's Memory](#)

- If no paper is loaded, or paper has run out while printing is in progress, the received faxes are stored in the machine's memory and the error message for no paper is displayed on the touch screen. In this case, load paper and tap **OK**.

You can also press the **Stop** button to close the message and print the stored documents in the machine's memory later.

■ [Printing a Document in Machine's Memory](#)

▶▶ Note

- If the sender sends a document that is larger than Letter-size or Legal-size, such as 11 x 17 inches, the sender's machine may send the fax automatically reduced in size or divided, or send only a part of the original.

1. [Make sure that the machine is turned on.](#)

2. Flick the HOME screen, then tap  **FAX**.

■ [Using the Operation Panel](#)

The Fax standby screen is displayed.

3. Tap **Function list**.

The **Function list** screen is displayed.

4. Tap **FAX paper settings**.

The **FAX paper settings** screen is displayed.

5. Specify the settings.

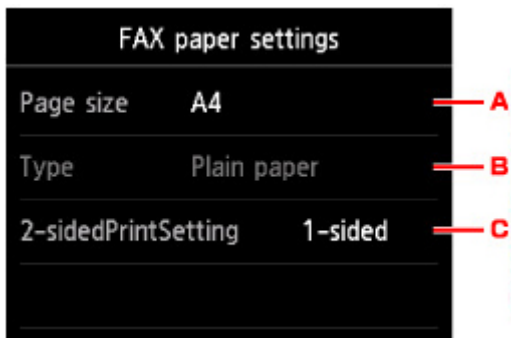

A. **Page size**

Select the page size from **A4**, **Letter**, or **Legal**.

B. **Type** (Media type)

The paper type is set to **Plain paper**.

C. **2-sidedPrintSetting**

Select two-sided printing or single-sided printing.

Two sided printing is available for black & white faxes. Color faxes are printed on the single-side of paper regardless of this setting.

After **2-sided** is selected for **2-sidedPrintSetting**, tap **Advanced** to specify the stapling side.

▶▶ **Note**

- When **Page size** is set to **A4** or **Letter**, the received faxes are printed on the two-sides of paper.

6. Press the **Back** button twice to return to the Fax standby screen.

Memory Reception

If the machine was not able to print the received fax, the received fax is stored in the machine's memory. The **FAX Memory** lamp is lit and **Received in memory.** is displayed at the Fax standby screen.

►►► Important

- If you unplug the power cord, all faxes stored in the machine's memory are deleted. The next time you turn the machine on, tap **OK** after a confirmation screen is displayed. The list of the faxes deleted from the machine's memory (MEMORY CLEAR REPORT) will be printed.

If the machine receives a fax under one of the following conditions, the received fax will be automatically stored in the machine's memory.

- **The machine is set to store received faxes in its memory:**

When **Do not print** is selected for **Received documents** in **Auto print settings** under **FAX settings**, the received faxes are stored in the machine's memory.

You can print the faxes stored in the machine's memory from the **Memory reference** screen in the Fax menu.

■ [Printing a Document in Machine's Memory](#)

►►► Note

- To print the received faxes automatically, select **Print** for **Received documents** in **Auto print settings** under **FAX settings**.

■ [Auto print settings](#)

- **An error has occurred on the machine:**

If you select **Print** for **Received documents** in **Auto print settings** under **FAX settings**, a received fax will be printed automatically. However, if any of the following errors occurs, the received fax will not be printed. It will instead be stored in the machine's memory.

When the error is resolved, the fax stored in the machine's memory is printed automatically.

- The amount of remaining ink is insufficient to print a fax:

Replace the ink tank.

■ [Replacing an Ink Tank](#)

►►► Note

- You can set the machine to forcibly print a received fax even if the ink has run out.

Set **Print when out of ink** in **Auto print settings** under **FAX settings** to **Print**.

However, part or all of the fax may not be printed since the ink has run out.

Also, the contents of the fax will not be stored in the machine's memory.

If the ink has already run out, we recommend that **Do not print** be selected for **Received documents** in **Auto print settings** under **FAX settings** to store the received fax in the machine's memory. After you replace the ink tank and select **Print** for **Received documents** in **Auto print settings**, the fax stored in the machine's memory will be printed automatically.

■ [Auto print settings](#)

- Paper has run out:

Load the paper and tap **OK** on the touch screen.

- A different size of paper from that specified by **Page size** in **FAX paper settings** is loaded:

Load the same size of paper as that specified by **Page size** in **FAX paper settings**, then tap **OK** on the touch screen.

- **You pressed the Stop button to cancel printing of a fax:**

Press the **HOME** button and tap **FAX** to resume printing of the fax.

▶▶▶ Note

- The machine can store up to max. 250 pages* (max. 30 documents) of faxes in the machine's memory.
 - * When using ITU-T No.1 chart (Standard mode)
- If the machine's memory becomes full during memory reception, only pages which already have been received are stored in the memory. Print the received faxes stored in the machine's memory, save them on the USB flash drive, or forward received faxes to the shared folder on the computer, then delete them from the machine's memory and have the sender resend the faxes.

■ [Document Stored in Machine's Memory](#)

Receiving Faxes Using Useful Functions

- **Saving Received Faxes Automatically on a USB Flash Drive**
- **Forwarding Received Faxes Automatically to Shared Folder on the Computer**
- **Remote Reception**
- **Rejecting Fax Reception**
- **Using the Caller ID Service to Reject Calls**

Saving Received Faxes Automatically on a USB Flash Drive

You can save received faxes on a USB flash drive as PDF files automatically when receiving a fax.

This section describes the procedure to enable the machine to save received faxes on a USB flash drive automatically.

▶▶▶ Important

- Do not remove the USB flash drive from the machine when the machine is set to save received faxes on a USB flash drive automatically.
- For safety reasons, we recommend backing up faxes saved on a USB flash drive to another media periodically to avoid unexpected accidents.
- We assume no responsibility for damage to or loss of data for whatever reason even within the warranty period.
- **Awaiting document processing.** is displayed on the Fax standby screen and the faxes are stored in the machine's memory when the received faxes are not saved on the USB flash drive because the USB flash drive is not inserted or because it is not writable.

You can save the faxes stored in the machine's memory to the USB flash drive manually. Delete the unnecessary fax from machine's memory after saving to the USB flash drive.

■ [Saving a Document in Machine's Memory to USB Flash Drive](#)

■ [Deleting a Document in Machine's Memory](#)

1. [Make sure that the machine is turned on.](#)
2. [Insert the USB flash drive into the USB flash drive port.](#)

3. Flick the HOME screen, then tap  **Setup**.

■ [Using the Operation Panel](#)

4. Tap  **Device settings**.

5. Tap **FAX settings**.

6. Tap **Auto save setting**.

7. Tap **ON**.

8. Tap **USB flash drive**.

▶▶▶ Note

- You can save up to 250 pages of fax as one PDF file.
- You can save up to 2000 PDF files on a USB flash drive.

- If the USB flash drive is removed or becomes full while saving faxes is in progress, the error message is displayed on the touch screen. Tap **OK** to dismiss the error.
 - The folder and file name of faxes saved on the USB flash drive is as follows:
 - Folder name: CANON_SC\FAXDOC\0001
 - File name (file extension: PDF): Running numbers, starting from FAX_0001
 - File date: The date and time of saving as set in the machine.For details on how to set the date and time:
[■ ■ Setting the Date and Time](#)
 - When removing the USB flash drive, set **Auto save setting** to **OFF**.
-

Forwarding Received Faxes Automatically to Shared Folder on the Computer

You can forward received faxes to the shared folder on the computer as PDF files automatically.

This section describes the procedure to enable the machine to forward received faxes to the shared folder on the computer automatically.

▶▶▶ Important

- Do not disconnect the machine with the computer when the machine is set to forward received faxes to the shared folder on the computer automatically.
- We assume no responsibility for damage to or loss of data for whatever reason even within the warranty period.
- **Awaiting document processing.** is displayed on the Fax standby screen and the faxes are stored in the machine's memory when the received faxes are not forward to the shared folder because the machine is not connected with the computer or because the shared folder setting is changed.

You can forward the faxes stored in the machine's memory to the shared folder on the computer manually. Delete the unnecessary fax from machine's memory after forwarding to the shared folder.

■ [Forwarding a Document in Machine's Memory to Shared Folder on the Computer](#)

■ [Deleting a Document in Machine's Memory](#)

▶▶▶ Note

- Register the destination folder using Canon Quick Toolbox in advance.

For details on how to register the destination folder:

■ [Destination Folder Settings](#)

1. [Make sure that the machine is turned on.](#)
2. Make sure that the machine is connected with the destination computer.

3. Flick the HOME screen, then tap  **Setup.**

■ [Using the Operation Panel](#)

4. Tap  **Device settings.**

5. Tap **FAX settings.**

6. Tap **Auto save setting.**

7. Tap **ON.**

8. Tap **Destination folder.**

9. Select a shared folder.

»» Note

- When you specify a PIN code for a registered folder, a screen asking you to enter a PIN code is displayed. Entering the PIN code allows you to assign the shared folder as the destination.

»» Note

- You can forward up to 250 pages of fax as one PDF file.
- You can forward up to 2000 PDF files to the shared folder on the computer.
- If the machine is disconnected with the computer or if the writing error occurs on the computer while saving faxes is in progress, the error message is displayed on the touch screen. Tap **OK** to dismiss the error.
- The faxes forwarded to the shared folder are named with the serial number from FAX_0001 (file extension: PDF).
- When disconnecting the machine with the computer, set **Auto save setting** to **OFF**.

Remote Reception

If the machine is located away from the telephone, pick up the handset of the telephone connected to the machine and dial 25 (the remote reception ID) to receive faxes (remote reception).

- If you use a rotary pulse line, temporarily switch your telephone to tone dialing. For details on how to switch to tone dialing, refer to your telephone's instruction manual.
- If you have an answering machine connected to the machine that can carry out remote control operations, the security code for this function may be the same as the remote reception ID. In this case, change the remote reception ID in **Remote RX ID** in **Remote RX** in **Advanced FAX settings** under **FAX settings**.

■ [Advanced FAX settings](#)

Remote reception can be disabled.

Rejecting Fax Reception

You can set the machine to reject faxes with no sender information or those from specific senders.

Select one of the following conditions to reject faxes.

- Faxes with no caller identification.
- Faxes from senders not registered in the machine's directory.
- Faxes from senders registered in the machine as rejected numbers.

Select a fax rejection condition following the procedure below.

1. [Make sure that the machine is turned on.](#)

2. Flick the HOME screen, then tap  **Setup**.

■ [Using the Operation Panel](#)

3. Tap  **Device settings**.

4. Tap **FAX settings**.

5. Tap **Security control**.

6. Tap **FAX reception reject**.

7. Tap **ON**.

8. Select a condition of rejecting fax reception.

No sender info.

Rejects faxes with no caller identification.

Not in directory

Rejects faxes from the senders not registered in the machine's directory.

Rejected numbers

Rejects faxes from the senders registered in the machine as rejected numbers.

For details on how to register the rejected number, see [Registering the Rejected Number](#).

▶▶▶ Note

- When the machine rejects reception, **Reception rejected.** is displayed on The Fax standby screen.
- Faxes with no caller identification are also rejected when the setting other than **No sender info.** is selected.

Registering the Rejected Number

Register the rejected number following the procedure below.

1. When the confirmation screen to register the rejected number is displayed, tap **Yes**.
2. Select a registration number.
3. Select a registration method.

Register the rejected number depending on the registration method.

- **By entering the number**

When you select this registration method, the screen to register the fax/telephone number is displayed.

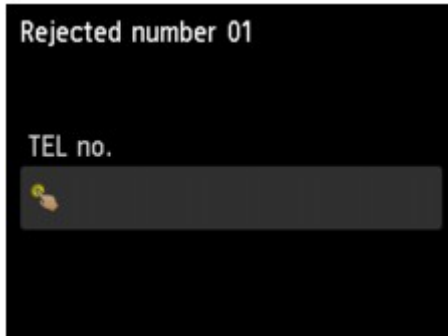

Tap the entry field of fax/telephone numbers to display the screen to enter the fax/telephone number. Enter the fax/telephone number you want to register, then tap **OK**.

- **From outgoing call log**

When you select this registration method, the screen to select the fax/telephone number from the outgoing call logs is displayed.



Tap a fax/telephone number you want to register.

- **From incoming call log**

When you select this registration method, the screen to select the fax/telephone number or the name from the incoming call logs is displayed.



Tap a fax/telephone number or a name you want to register.

»» Note

- This registration method may not be available depending on the country or region of purchase.

4. Tap **Register** to finalize registration.

»» Note

- To register another rejected number, select another registration number, then register the rejected number.

You can register up to 10 rejected numbers.

- You can print the list of rejected numbers (REJECTED NUMBER LIST).

■ [Summary of Reports and Lists](#)

- To change the registered rejected number:

1. Select a registered rejected number you want to change.
2. Tap **Edit**.
3. Tap the entry field of fax/telephone numbers.

The screen to change the registered rejected number is displayed.

4. Change the registered rejected number in the same procedure when you register.
 5. Finalize registration in the same procedure when you register.
- To delete the registered rejected number:
 1. Select a registered rejected number you want to delete.
 2. Tap **Delete**.The confirmation screen is displayed.
 3. Tap **Yes**.
 - You can also register the rejected number by tapping **Function list** on the Fax standby screen then selecting **Rejected numbers** under **TEL number registration**.

Using the Caller ID Service to Reject Calls

If you subscribe to the Caller ID service, the machine detects the sender's Caller ID. If the sender's ID matches the condition specified in this setting, the machine rejects the phone call or fax reception from the sender.

»» Note

- This setting may not be supported depending on the country or region of purchase.
Contact your telephone company to confirm whether it provides this service.

Specify the setting following the procedure below.

1. [Make sure that the machine is turned on.](#)

2. Flick the HOME screen, then tap  **Setup**.

■ [Using the Operation Panel](#)

3. Tap  **Device settings**.

4. Tap **FAX settings**.

5. Tap **Security control**.

6. Tap **Caller rejection**.

7. Tap **Yes**.

The **Caller rejection conditions** screen is displayed.

8. Specify the rejection conditions.

Tap a setting item and select **Accept** or **Reject**.

Anonymous no.

Selects whether to reject a phone call or fax reception from an anonymous number.

Out of area no.

Selects whether to reject a phone call or fax reception out of the subscribed service area.

Rejected numbers

Selects whether to reject a phone call or fax reception from the specified numbers.

9. Tap **OK** to finish specifying the rejection conditions.

If you select **Reject** for **Rejected numbers**, **Register rejected numbers?** is displayed on the touch screen. Tap **Yes**, then register the rejected number.

For details on how to register the rejected number, see [Registering the Rejected Number](#).

»» Note

- Even if you select **Reject**, the machine rings once.
(The machine may not ring depending on the country or region of purchase.)

Other Useful Fax Functions

- ▶ **Using the Information Services**
- ▶ **Transmission/Reception of Faxes Using ECM**
- ▶ **Document Stored in Machine's Memory**
- ▶ **Summary of Reports and Lists**

Using the Information Services

You can use various information services such as provided by banks, and make airline reservations or hotel reservations. Since these services require tone dialing to use their services, you need to temporarily switch to tone dialing if your machine is connected to a rotary pulse line.

■ [Using the Touch Tone Line](#)

■ [Using the Rotary Pulse Line](#)

▶▶ Important

- You may need to contract with the service providers for some information services. For details, contact the service providers.

Using the Touch Tone Line

- **Dialing by Using the On Hook Dial Function**

▶▶ Note

- You can use the on hook dial function only when **Hook key setting** in **Security control** under **FAX settings** is set to **Enable**.

■ [Security control](#)

1. [Make sure that the machine is turned on.](#)

2. Flick the HOME screen, then tap  **FAX**.

■ [Using the Operation Panel](#)

The Fax standby screen is displayed.

3. Tap .

4. Dial the number of the information service.

5. When the recorded message for the information service answers, tap the numbers using the Numeric key in accordance with the message.

6. Tap  to finish using the service.

- **Dialing by Using the Telephone Connected to the Machine**

1. [Make sure that the machine is turned on.](#)

2. Flick the HOME screen, then tap  **FAX**.

■ [Using the Operation Panel](#)

The Fax standby screen is displayed.

3. Lift the handset of the telephone.
4. Use the telephone to dial the number of the information service.
5. When the recorded message for the information service answers, use the telephone to press the numbers in accordance with the message.
6. Hang up the handset to finish using the service.

Using the Rotary Pulse Line

• Dialing by Using the On Hook Dial Function

▶▶▶ Note

- You can use the on hook dial function only when **Hook key setting** in **Security control** under **FAX settings** is set to **Enable**.

■ [Security control](#)

1. [Make sure that the machine is turned on.](#)

2. Flick the HOME screen, then tap  **FAX**.

■ [Using the Operation Panel](#)

The Fax standby screen is displayed.

3. Tap .

4. Dial the number of the information service.

5. When the recorded message for the information service answers, tap the Tone key to switch to tone dialing.

6. Tap the numbers using the Numeric key in accordance with the message.

7. Tap  to finish using the service.

• Dialing by Using the Telephone Connected to the Machine

1. [Make sure that the machine is turned on.](#)

2. Flick the HOME screen, then tap  **FAX**.

■ [Using the Operation Panel](#)

The Fax standby screen is displayed.

3. Lift the handset of the telephone.
4. Use the telephone to dial the number of the information service.
5. When the recorded message for the information service answers, use the telephone to switch to tone dialing.

When you dial the number of the information service using the telephone connected to the machine, you cannot use the machine to switch to tone dialing. For instructions on how to switch to tone dialing, refer to your telephone's instruction manual.

6. Use the telephone to press the numbers in accordance with the message.
7. Hang up the handset to finish using the service.

Transmission/Reception of Faxes Using ECM

This machine is set to send/receive faxes in Error Correction Mode (ECM). If the recipient's fax machine is compatible with ECM, ECM automatically corrects errors and resends the fax.

▶▶▶ Note

- If the sender's or recipient's fax machine is not compatible with ECM, the fax will be sent/received without automatic error correction.
- To receive color faxes, make sure that **ECM RX** in **Adv. communication settings** in **Advanced FAX settings** under **FAX settings** is set to **ON**.

■ [Advanced FAX settings](#)

To disable ECM transmission/reception, set **ECM TX** and **ECM RX** in **Adv. communication settings** to **OFF**.

- Transmission may take longer when ECM is enabled.

Document Stored in Machine's Memory

If the sending faxes is not complete or the machine was not able to print the received faxes, these faxes are stored in the machine's memory.

If an error occurred during a fax transmission, the document is not stored in the machine's memory.

In the following cases, the machine is not able to print the received fax and will automatically store the fax in its memory.

- **The amount of remaining ink is insufficient to print a fax.**
- **Paper has run out.**
- **A different size of paper from that specified by Page size in FAX paper settings is loaded.**
- **Do not print is selected for Received documents in Auto print settings under FAX settings.**
- **You pressed the Stop button to cancel printing of a received fax.**

▶▶▶ Important

- If you unplug the power cord of the machine, all faxes stored in the machine's memory are deleted.
For details on how to unplug the power cord, refer to [Notice for Unplugging the Power Cord](#).

You can print or delete the faxes stored in the machine's memory. You can also save the received faxes stored in the machine's memory on the USB flash drive or forward the received faxes stored in the machine's memory to the shared folder on the computer.

- To print a document in the machine's memory:
■ [Printing a Document in Machine's Memory](#)
- To delete a document in the machine's memory:
■ [Deleting a Document in Machine's Memory](#)
- To save a document on a USB flash drive
■ [Saving a Document in Machine's Memory to USB Flash Drive](#)
- To forward a document to the shared folder on the computer
■ [Forwarding a Document in Machine's Memory to Shared Folder on the Computer](#)

▶▶▶ Note

- When confirming, printing, or deleting a document stored in the machine's memory, you specify it by its transaction number. If you do not know the transaction number for your target document, print the list of documents (MEMORY LIST) first.
For details on how to print MEMORY LIST, see [Printing a Document in Machine's Memory](#).

Printing a Document in Machine's Memory

You can print a specified document in the machine's memory or print all the documents in its memory at a time.

When printing a specified document, you specify it by its transaction number. If you do not know the transaction number for your target document, print the list of documents (MEMORY LIST) first.

1. [Make sure that the machine is turned on.](#)
2. [Load paper.](#)

3. Flick the HOME screen, then tap  **FAX**.

■ [Using the Operation Panel](#)

The Fax standby screen is displayed.

4. Tap **Function list**.

The **Function list** screen is displayed.

5. Tap **Memory reference**.

The memory list is displayed.



A. Date and time of transaction and fax/telephone number

B. Transaction number (TX/RX NO.)

A transaction number from "0001" to "4999" indicates a document being sent.

A transaction number from "5001" to "9999" indicates a document being received.

C. Color information

Color is displayed for color transmission/reception. Nothing is displayed for black & white transmission/reception.

▶▶▶ **Note**

- If no document is stored in the machine's memory, **There is no document in memory.** is displayed. Tap **OK** to return to the previous screen.

6. Select a print menu.

- To print the memory list (MEMORY LIST):

You can print a list of the documents in the machine's memory by tapping **Print doc. list**.

When the print confirmation screen is displayed, tap **Yes**. The printing starts.

MEMORY LIST shows the transaction number of the unsent or unprinted fax (TX/RX NO.), transaction mode, recipient's number, and the date and time of the transaction.

A transaction number from "0001" to "4999" on MEMORY LIST indicates a document being sent. A transaction number from "5001" to "9999" on MEMORY LIST indicates a document being received.

- To specify a document to print:

Select a document to print on the **Memory list** screen, tap **Print specified document**.

▶▶▶ Note

- If the specified document is not stored in the machine's memory, **There is no document that can be printed.** is displayed. Tap **OK** to return to the previous screen.

The confirmation screen to select whether to print only the first page of the document is displayed.

If you select **Yes**, only the first page of the document will be printed. The document is still stored in the machine's memory.

If you select **No**, all pages of the document will be printed. The screen to confirm whether to delete the printed document in the machine's memory is displayed after printing.

- To print all the received documents stored in the machine's memory:

Tap **Batch process** then tap **Print all RX documents**.

When the print confirmation screen is displayed, tap **Yes**. All the documents in the machine's memory are printed.

Each time a document is printed, the screen to confirm whether to delete the printed document in the machine's memory is displayed.

If you tap **Yes**, the printed document in the machine's memory is deleted.

Deleting a Document in Machine's Memory

You can delete a specified document in the machine's memory or delete all the documents in its memory at a time.

▶▶▶ Note

- When deleting a specified document, you specify it by its transaction number. If you do not know the transaction number for your target document, print the list of documents (MEMORY LIST) first.

■ [Printing a Document in Machine's Memory](#)

1. [Make sure that the machine is turned on.](#)



2. Flick the HOME screen, then tap **FAX**.

■ [Using the Operation Panel](#)

The Fax standby screen is displayed.

3. Tap **Function list**.

The **Function list** screen is displayed.

4. Tap **Memory reference**.

The memory list is displayed.



A. Date and time of transaction and fax/telephone number

B. Transaction number (TX/RX NO.)

A transaction number from "0001" to "4999" indicates a document being sent.

A transaction number from "5001" to "9999" indicates a document being received.

C. Color information

Color is displayed for color transmission/reception. Nothing is displayed for black & white transmission/reception.

▶▶▶ Note

- If no document is stored in the machine's memory, **There is no document in memory.** is displayed. Tap **OK** to return to the previous screen.

5. Select a delete menu.

- To specify a document to delete:

Select a document to delete on the **Memory list** screen, tap **Delete specified doc..**

▶▶▶ Note

- If the specified document is not stored in the machine's memory, **There is no document that can be deleted.** is displayed. Tap **OK** to return to the previous screen.

The confirmation screen is displayed.

If you select **Yes**, the specified document is deleted from machine's memory.

- To delete all documents stored in the machine's memory:

Tap **Batch process** then tap **Delete all documents.**

The confirmation screen is displayed.

If you select **Yes**, all documents are deleted from machine's memory.

Saving a Document in Machine's Memory to USB Flash Drive

You can save the received faxes stored in the machine's memory to the USB flash drive as PDF files using the operation panel of the machine.

You can save a specified document in the machine's memory to the USB flash drive or save all the documents in its memory to the USB flash drive at a time.

▶▶▶ Important

- Do not remove the USB flash drive from the machine until saving is complete.
- For safety reasons, we recommend backing up faxes saved on a USB flash drive to another media periodically to avoid unexpected accidents.
- We assume no responsibility for damage to or loss of data for whatever reason even within the warranty period.

▶▶▶ Note

- When saving a specified document, you specify it by its transaction number. If you do not know the transaction number for your target document, print the list of documents (MEMORY LIST) first.

■ ■ [Printing a Document in Machine's Memory](#)

- After saving the fax in the machine's memory to the USB flash drive, the fax is still stored in the machine's memory.

For details on how to delete the fax in the machine's memory, see [Deleting a Document in Machine's Memory](#).

1. [Make sure that the machine is turned on.](#)
2. [Insert the USB flash drive into the USB flash drive port.](#)

3. Flick the HOME screen, then tap  **FAX**.

■ ■ [Using the Operation Panel](#)

The Fax standby screen is displayed.

4. Tap **Function list**.

The **Function list** screen is displayed.

5. Tap **Memory reference**.

The memory list is displayed.



A. Date and time of transaction and fax/telephone number

B. Transaction number (TX/RX NO.)

A transaction number from "0001" to "4999" indicates a document being sent.

A transaction number from "5001" to "9999" indicates a document being received.

C. Color information

Color is displayed for color transmission/reception. Nothing is displayed for black & white transmission/reception.

▶▶▶ Note

- If no document is stored in the machine's memory, **There is no document in memory.** is displayed. Tap **OK** to return to the previous screen.

6. Select a save menu.

- To specify a document to save on the USB flash drive:

Select a document to save on the **Memory list** screen, tap **Save specified document**.

▶▶▶ Note

- If the specified document is not stored in the machine's memory, **There is no document that can be saved.** is displayed. Tap **OK** to return to the previous screen.

Tap **USB flash drive** as the destination. The specified document is saved on the USB flash drive.

- To save all the received documents stored in the machine's memory on the USB flash drive:

Tap **Batch process** then tap **Save all RX documents**.

Tap **USB flash drive** as the destination. All documents are saved on the USB flash drive.

▶▶▶ Note

- You can save up to 250 pages of fax as one PDF file.
- You can save up to 2000 PDF files on a USB flash drive.
- Faxes are saved according to the order of the transaction number when **Save all RX documents** is selected.
- If the USB flash drive is removed or becomes full while saving faxes is in progress, the error message is displayed on the touch screen. Tap **OK** to dismiss the error.
- The folder and file name of faxes saved on the USB flash drive is as follows:
 - Folder name: CANON_SC\FAXDOC\0001
 - File name (file extension: PDF): Running numbers, starting from FAX_0001

- File date: The date and time of saving as set in the machine.

For details on how to set the date and time:

■ [Setting the Date and Time](#)

Forwarding a Document in Machine's Memory to Shared Folder on the Computer

You can forward the received faxes stored in the machine's memory to the shared folder on the computer as PDF files using the operation panel of the machine.

You can forward a specified document in the machine's memory to the shared folder on the computer or forward all the documents in its memory to the shared folder on the computer at a time.

▶▶▶ Important

- Do not disconnect the machine with the computer when the machine forwards received faxes to the shared folder on the computer.
- We assume no responsibility for damage to or loss of data for whatever reason even within the warranty period.

▶▶▶ Note

- Register the destination folder using Canon Quick Toolbox in advance.
For details on how to register the destination folder:
 - [Destination Folder Settings](#)
- When forwarding a specified document, you specify it by its transaction number. If you do not know the transaction number for your target document, print the list of documents (MEMORY LIST) first.
 - [Printing a Document in Machine's Memory](#)
- After forwarding the fax in the machine's memory to the shared folder on the computer, the fax is still stored in the machine's memory.
For details on how to delete the fax in the machine's memory, see [Deleting a Document in Machine's Memory](#).

1. [Make sure that the machine is turned on.](#)
2. Make sure that the machine is connected with the destination computer.

3. Flick the HOME screen, then tap  **FAX**.

■ [Using the Operation Panel](#)

The Fax standby screen is displayed.

4. Tap **Function list**.
The **Function list** screen is displayed.
5. Tap **Memory reference**.
The memory list is displayed.



A. Date and time of transaction and fax/telephone number

B. Transaction number (TX/RX NO.)

A transaction number from "0001" to "4999" indicates a document being sent.

A transaction number from "5001" to "9999" indicates a document being received.

C. Color information

Color is displayed for color transmission/reception. Nothing is displayed for black & white transmission/reception.

▶▶▶ Note

- If no document is stored in the machine's memory, **There is no document in memory.** is displayed. Tap **OK** to return to the previous screen.

6. Select a forward menu.

- To specify a document to forward to the shared folder on the computer:

Select a document to forward on the **Memory list** screen, tap **Save specified document**.

▶▶▶ Note

- If the specified document is not stored in the machine's memory, **There is no document that can be forwarded.** is displayed. Tap **OK** to return to the previous screen.

Tap **Destination folder** as the destination.

Tap a destination folder to forward the specified document to the shared folder on the computer.

▶▶▶ Note

- When you specify a PIN code for a registered folder, a screen asking you to enter a PIN code is displayed. Entering the PIN code allows you to assign the shared folder as the destination.

- To forward all the received documents stored in the machine's memory to the shared folder on the computer:

Tap **Batch process** then tap **Save all RX documents**.

Tap **Destination folder** as the destination.

Tap a destination folder to forward all documents to the shared folder on the computer.

▶▶▶ Note

- When you specify a PIN code for a registered folder, a screen asking you to enter a PIN code is displayed. Entering the PIN code allows you to assign the shared folder as the destination.

»» Note

- You can forward up to 250 pages of fax as one PDF file.
- You can forward up to 2000 PDF files on a USB flash drive.
- Faxes are forwarded according to the order of the transaction number when **Save all RX documents** is selected.
- If the machine is disconnected with the computer or if the writing error occurs on the computer while forwarding faxes is in progress, the error message is displayed on the touch screen. Tap **OK** to dismiss the error.
- The faxes forwarded to the shared folder are named with the serial number from FAX_0001 (file extension: PDF).

Summary of Reports and Lists



The machine prints the report of sending or receiving a fax automatically. You can print the list of the fax/ telephone number or the current settings.

■ [Type of Reports and Lists](#)

■ [Printing Report or List](#)

Type of Reports and Lists

Report or List	Description
ACTIVITY REPORT	<p>Shows recent fax transactions at sight.</p> <ul style="list-style-type: none"> You can print ACTIVITY REPORT manually. For details on the procedure to print, see Printing Report or List. The * (asterisk) is appended to the history already printed on ACTIVITY REPORT. If you select Print for Activity report in Auto print settings under FAX settings, the machine prints ACTIVITY REPORT for the 20 histories of sent and received faxes automatically. <p>■ Auto print settings</p>
Directory list <ul style="list-style-type: none"> RECIPIENT TELEPHONE NUMBER LIST GROUP DIAL TELEPHONE NO. LIST 	<p>Lists the numbers and names registered.</p> <p>You can print the lists of the recipient and group dial. For details on the procedure to print, see Printing Report or List.</p>
USER'S DATA LIST	<p>Lists the current settings of the machine and the registered sender information. For details on the procedure to print, see Printing Report or List.</p>
MEMORY LIST	<p>Lists the documents currently stored in the machine's memory. For details on the procedure to print, see Printing Report or List.</p> <p>▶▶▶ Note</p> <ul style="list-style-type: none"> After selecting Memory reference to display the Memory list screen, you can print MEMORY LIST by tapping Print doc. list. <p>■ Printing a Document in Machine's Memory</p>
REJECTED NUMBER LIST	<p>Lists the rejected numbers. For details on the procedure to print, see Printing Report or List.</p>
CALLER HISTORY	<p>Lists the caller history. This list is available when Caller ID service is subscribed. For details on the procedure to print, see Printing Report or List. This list may not be supported depending on the country or region of purchase.</p>
TX REPORT/ERROR TX REPORT	<p>Either of these reports is printed after each fax transmission.</p>

	<ul style="list-style-type: none"> At the time of purchase, ERROR TX REPORT is set to be printed only when a transmission error occurred. <p>You can set the machine to print TX REPORT each time it sends a document, or disable printing of the report by selecting TX report in Auto print settings under FAX settings.</p> <p>You can also specify the print setting so that the first page of the fax is printed along with the report.</p> <p> Auto print settings</p> <p> Note</p> <div style="border: 1px solid black; padding: 5px;"> <ul style="list-style-type: none"> The first page of the fax is not printed in color transmission. </div> <ul style="list-style-type: none"> MULTI TRANSMISSION REPORT is printed after sequential broadcasting of a document. If an error occurs when you send a fax, the error number is printed on ERROR TX REPORT (there are some errors for which the cause is also printed). <p>For details on the error number, see Errors When You Send a Fax.</p>
MULTI TRANSMISSION REPORT	<p>This report is printed after sequential broadcasting of a document.</p> <p>Confirms whether the transmission to all the recipients has been completed successfully.</p> <p>The procedure to print and the error number is same as TX REPORT.</p>
RX REPORT	<p>This report is printed after each fax reception.</p> <ul style="list-style-type: none"> At the time of purchase, the machine is set so that RX REPORT is not printed at all. <p>You can set the machine to print RX REPORT each time it receives a document, or only when an error occurs by selecting RX report in Auto print settings under FAX settings.</p> <p> Auto print settings</p> <ul style="list-style-type: none"> If an error occurs when you receive a fax, the error number is printed on RX REPORT (there are some errors for which the cause is also printed). <p>For details on the error number, see Errors When You Receive a Fax.</p>
MEMORY CLEAR REPORT	<p>Lists the deleted faxes in the machine's memory if the faxes stored in the machine's memory are deleted by a power failure or unplugging the power cord.</p> <p>When the machine is turned on, The power cord has been unplugged and unsent/received docs in memory have been lost. Load paper and tap [OK] to print a list of the lost docs. is displayed on the touch screen. MEMORY CLEAR REPORT is printed by tapping OK on the touch screen.</p>

Printing Report or List

This section describes the procedure to print the report or the list manually.

Print the following report or list manually.

- ACTIVITY REPORT
- Directory list (RECIPIENT TELEPHONE NUMBER LIST/GROUP DIAL TELEPHONE NO. LIST)
- USER'S DATA LIST
- MEMORY LIST
- REJECTED NUMBER LIST

- CALLER HISTORY

▶▶ Note

- CALLER HISTORY may not be supported depending on the country or region of purchase.

1. [Make sure that the machine is turned on.](#)

2. [Load paper.](#)

3. Flick the HOME screen, then tap  **FAX**.

■ Using the Operation Panel

The Fax standby screen is displayed.

4. Tap **Function list**.

The **Function list** screen is displayed.

5. Tap **Print reports/lists**.

6. Select a report or a list you want to print to start printing.

- When you select **Directory list**:

Select **Recipient** or **Group dial**.

If you select **Recipient**, select whether to print RECIPIENT TELEPHONE NUMBER LIST in alphabetical order of the registered names. If you select **Yes**, the machine prints RECIPIENT TELEPHONE NUMBER LIST with the destination names in alphabetical order. If you select **No**, the machine prints RECIPIENT TELEPHONE NUMBER LIST with the registered entries in numerical order.

If you select **Group dial**, the confirmation screen is displayed. Select **Yes**. The machine prints GROUP DIAL TELEPHONE NO. LIST.

- When you select an item other than **Directory list**:

Select **Yes** when the confirmation screen is displayed.

The machine prints the selected report or list.

Errors When You Send a Fax

If an error occurs when you send a fax, the error number is printed on ERROR TX REPORT or ACTIVITY REPORT (there are some errors for which the cause is also printed).

The causes corresponding to the error numbers are as follows.

No.	Cause	Action
#001	Document is jammed in the ADF.	The document is jammed in the ADF. When the error is cleared, redo the operation.
#003	Document is too long.	You attempted to send a document longer than 15.75 inches / 400 mm.

		You cannot send a document longer than 15.75 inches / 400 mm from the ADF. "#003" is also printed if it takes time to send a page. Divide the document or set the image quality (Fax resolution) to a lower setting, then resend it.
#005	No answer.	The recipient's fax machine does not respond. Contact the recipient and have the recipient check that the telephone line is connected correctly.
#012	No paper is in the recipient's fax machine.	There is no paper in the recipient's fax machine. Contact the recipient and have the recipient load paper.
#017	No tone is detected.	The machine could not detect the dial tone. Dial tone detect in Advanced FAX settings under FAX settings is set to ON . Set to OFF . ■ Advanced FAX settings
#018	Line was busy.	The fax/telephone number you dialed is busy. Try dialing again after waiting for a moment.
#022	Number is deleted.	The fax/telephone number registered in the machine's directory is incorrect. Check the recipient's fax/telephone number, correct the fax/telephone number registered in the machine's directory, then send the document again. ■ Changing Registered Information
#037	Memory is full.	The machine could not send a fax because its memory is full. Delete contents in memory, then send a fax again. ■ Document Stored in Machine's Memory
#059	Transmission has been canceled due to a fax information mismatch.	Transmission has been canceled because the machine could not detect the recipient's fax machine information or the information did not match the dialed number. This message is displayed when Check RX FAX information in Security control under FAX settings is set to ON . For details, see Sending Faxes after Checking Information (Checking the Recipient's Information) .
#085	Try again in black & white transmission.	The recipient's fax machine is not color-compatible. Resend the document in black & white.
#099	The Stop button was pressed during transmission.	The Stop button was pressed to cancel transmission of the document. Resend it if necessary.
#412	The fax could not be sent from the computer.	The fax could not be sent from the computer (Windows only). Ensure that the machine is connected with the computer correctly and redo operation.
#995	The unsent fax was deleted while automatic redialing.	While automatic redialing, the unsent fax is stored in the machine's memory temporarily until the sending fax is complete. If a power failure occurs or you unplug the power cord before automatic redialing is complete, all faxes stored in the machine's memory are deleted and not sent. Resend the document.

Errors When You Receive a Fax

If an error occurs when you receive a fax, the error number is printed on RX REPORT or ACTIVITY REPORT (there are some errors for which the cause is also printed).

The causes corresponding to the error numbers are as follows.

No.	Cause	Action
#003	It takes too long to receive a page.	Contact the sender and have the sender divide the fax or set the image quality (Fax resolution) to a lower setting and resend it.
#005	No answer.	When receiving a fax manually, the machine could not detect the signals from the sender's fax machine. Contact the sender and have the sender resend it, or set the machine to receive the fax automatically.
#037	Memory is full.	The machine could not receive a fax because its memory is full. Delete contents in memory, then ask the sender to resend the fax. See Document Stored in Machine's Memory .
#046	Reception has been rejected due to the specified fax rejection condition.	Reception has been rejected because the fax matches the fax rejection condition specified by FAX reception reject in Security control under FAX settings . For details, see Rejecting Fax Reception .
#099	The Stop button was pressed during reception.	The Stop button was pressed to cancel reception of the fax. Contact the sender and have the sender resend it if necessary.
#995	The received fax was deleted.	The received fax was deleted before being saved to the USB flash drive, forwarded to the shared folder on the computer, or printed. Contact the sender and have the sender resend it if necessary.

Troubleshooting

- ▶ **The Machine Cannot Be Powered On**
- ▶ **Printing Does Not Start**
- ▶ **Paper Does Not Feed Properly/"No Paper" Error Occurs**
- ▶ **Print Results Not Satisfactory**
- ▶ **Ink Is Not Ejected**
- ▶ **Paper Jams**
- ▶ **If an Error Occurs**
- ▶ **Problems Sending Faxes**
- ▶ **Problems Receiving Faxes**

Search Each Function

- ▶ **Problems with Network Communication**
- ▶ **Problems with Printing**
- ▶ **Problems with Printing Quality**
- ▶ **Problems with Faxing**
- ▶ **Problems with Scanning**
- ▶ **Problems with the Machine**
- ▶ **Problems with Installation/Downloading**
- ▶ **About Errors/Messages Displayed**
- ▶ **If You Cannot Resolve the Problem**

Problems with Network Communication

- **Problems with the Machine While Using with Network**
- **Cannot Detect a Machine on a Network**
- **Other Problems with Network**

Problems with the Machine While Using with Network

- **The Machine Stopped Working Suddenly**
- **Printing Speed Is Slow**
- **Cannot Use the Machine on Replacing an Access Point or Changing Its settings**

The Machine Stopped Working Suddenly

- [Cannot Communicate with the Machine over the Wireless LAN](#)
- [Cannot Communicate with the Machine Using the Access Point Mode](#)
- [Cannot Communicate with the Machine over the Wired LAN](#)
- [Cannot Print or Scan from a Computer Connected to the Network](#)



Cannot Communicate with the Machine over the Wireless LAN



Check1 Make sure that the machine is turned on.

Check2 Make sure that the network settings in the machine are identical with those of the access point.

Refer to the instruction manual provided with the access point or contact its manufacturer to check the access point settings, and then modify the machine settings.

■ [How to Set an Encryption Key](#)

Check3 Make sure that the machine is not placed far away from the access point.

The access point is located indoors within the effective range for wireless communication. Locate the machine within 164 ft. / 50 m from the access point.

Check4 Make sure that there is no obstruction.

Wireless communication between different rooms or floors is generally poor. Adjust the location of the devices.

Check5 Make sure that there is no source of radio wave interference in your vicinity.

If a device (e.g. microwave oven) using the same frequency bandwidth as the wireless station is placed nearby, the device may cause interference. Place the wireless station as far away from the interference source as possible.

Check6 Make sure that the network settings of the computer are correct.

For the procedures to connect a network device to the computer and set them up, refer to the instruction manual of your network device or contact its manufacturer.

Check7 Make sure that the radio status is good and adjust the installation positions while monitoring the radio status with IJ Network Tool.

■ [Monitoring Wireless Network Status](#)

Check8 Make sure that a valid wireless channel is used.

The wireless channel to be used may be limited depending on wireless network devices installed in the computer. Refer to the instruction manual provided with your computer or your wireless network device to specify the valid wireless channel.

Check9 Make sure that the channel confirmed in Check 8 can communicate with the computer.

If not, change the channel set to the access point.

Check10 Make sure that the firewall of the security software is disabled.

If the firewall function of your security software is turned on, a message may appear warning that Canon software is attempting to access the network. If the warning message appears, set the security software to always allow access.

If using any programs that switch the network environment, check their settings. Some programs will enable a firewall by default.

Check11 When using a router, connect the machine and computer to the LAN side (same network segment).

Check12 When the machine is connected to an AirPort Base Station via a LAN, use alphanumeric characters for the name of the network (SSID).

If the problem is not resolved, perform setup according to the instructions on our website.

- **For placement:**

Make sure that there is no barrier or obstacle between the access point and the machine.

Cannot Communicate with the Machine Using the Access Point Mode

Check1 Make sure that the machine is turned on.

Check2 Is **Change LAN** in **LAN settings** under **Device settings** set to **Disable LAN**, **Wireless LAN active**, or **Wired LAN active**?

Select **Access point mode active**.

Check3 Is the machine selected to connect external communication devices (e.g. computers, smartphones, or tablets)?

Select an access point name (SSID) specified for the machine as a destination for external communication devices.

Check4 Enter a password if you specify it for the machine.

Check5 Make sure that external communication devices are not placed far away from the machine.

Do not locate external communication devices too far away from the machine.

Check6 Make sure that there is no obstruction.

Wireless communication between different rooms or floors is generally poor. Adjust the location of the devices.

Check7 Make sure that there is no source of radio wave interference in your vicinity.

If a device (e.g. microwave oven) using the same frequency bandwidth as the wireless station is placed nearby, the device may cause interference. Place the wireless station as far away from the interference source as possible.

Check8 Are you trying to connect 6 devices or more?

You can connect up to 5 devices using the access point mode.

Cannot Communicate with the Machine over the Wired LAN

A

Check1 Make sure that the machine is turned on.

Check2 Make sure that the LAN cable is connected properly.

Make sure that the machine is connected to the router with the LAN cable. If the LAN cable is loose, connect the cable properly.

If the LAN cable is connected to the WAN side of the router, connect the cable to the LAN side of the router.

If the problem is not resolved, perform setup according to the instructions on our website.

Cannot Print or Scan from a Computer Connected to the Network

A

Check1 Make sure that the network settings of the computer are correct.

For the procedures to set up the computer, refer to the instruction manual of your computer or contact its manufacturer.

Check2 If the MP Drivers are not installed, install them.

Install the MP Drivers from our website.

Check3 When using wireless LAN, make sure that access control is not set to the access point.

For the procedures to connect an access point and set it up, refer to the instruction manual of your access point or contact its manufacturer.

Note

- To check the MAC address or the IP address of the computer, see [Checking the IP Address or the MAC Address of the Computer](#).



Printing Speed Is Slow



Check1 The machine may be printing out a large job issued from another computer.

Check2 When using wireless LAN, make sure that the radio status is good and adjust the installation positions while monitoring the radio status with IJ Network Tool.

■ [Monitoring Wireless Network Status](#)

Make sure that there is no barrier or obstacle between the access point and the machine. Wireless communication between different rooms or floors is generally poor. The metal, concrete, or timber including the metallic material, mud wall, or insulator may interrupt a wireless communication. If the machine cannot communicate with the computer over a wireless LAN for the wall material, place the machine and the computer in the same room or floor.

Check3 Make sure that there is no source of interference in your vicinity.

If a device (e.g. microwave oven) using the same frequency bandwidth as the wireless station is placed nearby, the device may cause interference. Place the wireless station as far away from the interference source as possible.



Cannot Use the Machine on Replacing an Access Point or Changing Its settings



When you replace an access point, perform network setup of the machine again.

Perform network setup again according to the instructions on our website.

If the problem is not resolved, see below.

■ [Cannot Communicate with the Machine After Applying MAC/IP Address Filtering or Entering an Encryption Key to the Access Point](#)

■ [When Encryption Is Enabled, Cannot Communicate With the Machine After the Encryption Type Was Switched on the Access Point](#)



Cannot Communicate with the Machine After Applying MAC/IP Address Filtering or Entering an Encryption Key to the Access Point



Check1 Confirm the access point setting.

Refer to the instruction manual provided with the access point or contact its manufacturer to confirm the access point setting. Make sure that the computer and the access point can communicate with each other under this setting.

Check2 If you are performing MAC address filtering or IP address filtering at the access point, confirm that the MAC address or IP address for both the computer or the network device and the machine are registered.

Check3 If you are using a WEP or WPA/WPA2 key, make sure that the encryption key for the computer or the network device and the machine matches that set to the access point.

Besides the WEP key itself, the key length, key format, the key ID to use, and the authentication method must match among the machine, the access point, and the computer.

Normally, select **Auto** for the authentication method. If you want to specify the method manually, select **Open System** or **Shared Key** according to the setting of the access point.

■ [How to Set an Encryption Key](#)

Q When Encryption Is Enabled, Cannot Communicate With the Machine After the Encryption Type Was Switched on the Access Point

A

If the machine cannot communicate with the computer after the encryption type of the machine was switched, make sure that encryption types for the computer and the access point matches that set to the machine.

■ [Cannot Communicate with the Machine After Applying MAC/IP Address Filtering or Entering an Encryption Key to the Access Point](#)

Cannot Detect a Machine on a Network

- ▶ **Cannot Detect the Machine When Setting up Network Communication**
- ▶ **The Machine Cannot Be Detected in the Wireless LAN**
- ▶ **The Machine Cannot Be Detected in the Wired LAN**

▶▶▶ **Note**

- You cannot use the wireless LAN and the wired LAN at the same time.

Cannot Detect the Machine When Setting up Network Communication

If the machine could not be detected on the network when setting up the network communication, confirm the network settings before redetecting the machine.

■ [Cannot Detect the Machine during Wireless LAN Setup: Check 1](#)

■ [Cannot Detect the Machine during Wired LAN Setup: Check 1](#)

▶▶ Note

- You can set up the network communication via USB. To set up via USB, select the **Set up the network connection via USB** check box on the **Check Printer Settings** screen and click **Next**.



Cannot Detect the Machine during Wireless LAN Setup: Check 1



Are the machine and network device (router, access point, etc.) turned on?

Make sure that the machine is turned on.

■ [Confirming that the Power Is On](#)

Make sure that the network device (router, access point, etc.) is turned on.

If the machine or the network device is turned off:

Turn on the machine or the network device.

After turning on the machine or the network device, it may take some time until ready for use. After a while just turning on the machine or the network device, click **Redetect** on the **Check Printer Settings** screen.

When the machine is detected, follow the instructions on the screen to continue to set up the network communication.

If the machine and the network device are turned on:

If the machine could not be detected after clicking **Redetect** even when the machine and the network device are turned on, or when you have turned them on, go to check 2.

■ [Cannot Detect the Machine during Wireless LAN Setup: Check 2](#)



Cannot Detect the Machine during Wireless LAN Setup: Check 2



Is the wireless LAN setting of the machine enabled?

Make sure that the **Wi-Fi** or **Wi-X** icon below is displayed on the touch screen.

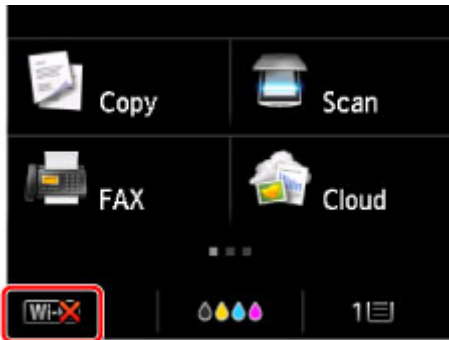

If the icon is not displayed:

The wireless LAN setting of the machine is disabled. Enable the wireless LAN setting of the machine.

After enabling the wireless LAN setting, click **Back to Top** on the **Check Printer Settings** screen to try to set up the network communication from the beginning.

If the icon is displayed:

Go to check 3.

[Cannot Detect the Machine during Wireless LAN Setup: Check 3](#)



Cannot Detect the Machine during Wireless LAN Setup: Check 3



Is the machine connected to the access point?

By using the icon on the touch screen, make sure that the machine is connected to the access point.

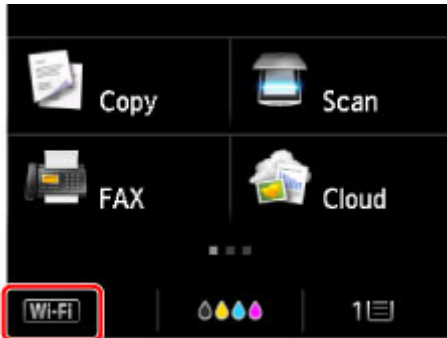

If the icon is displayed:

The machine may be placed far away from the access point. Place the machine near the access point temporarily, then click **Redetect** on the **Check Printer Settings** screen.

When the machine is detected, follow the instructions on the screen to continue to set up the network communication.

If the machine cannot be detected, the machine is not connected to the access point. Connect the machine to the access point.

Click **Back to Top** on the **Check Printer Settings** screen to try to set up the network communication from the beginning.

If the icon is displayed:

Go to check 4.

[Cannot Detect the Machine during Wireless LAN Setup: Check 4](#)



Cannot Detect the Machine during Wireless LAN Setup: Check 4



Are the SSID of the access point connected to your computer and that connected to the machine the same?

You can confirm the SSID of the access point connected to the machine on the touch screen.

Select **Setup** on the HOME screen, then select **Device settings** > **LAN settings** > **Confirm LAN settings** > **WLAN setting list**.

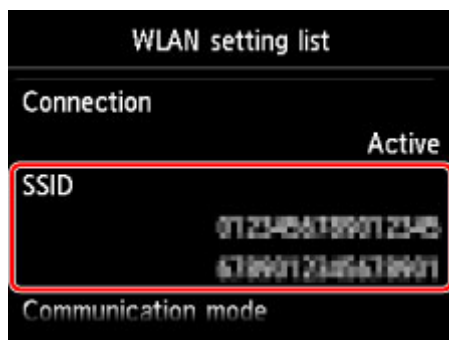

From your computer, you can confirm the SSID of the access point connected to your computer. Confirm the SSID from the AirMac icon of the menu bar.

▶▶ Note

- If the SSID of the access point is not displayed on your computer, check the settings of your computer.

If the SSIDs are different:

Click **Back to Top** on the **Check Printer Settings** screen to try to set up the network communication from the beginning. When you try to set up, specify the same SSID of the access point for the machine and your computer.

If the SSIDs are the same:

Go to check 5.

■ [Cannot Detect the Machine during Wireless LAN Setup: Check 5](#)



Cannot Detect the Machine during Wireless LAN Setup: Check 5



Does the firewall function of your security software or operation system for computer interfere with setting up the network communication?

The firewall function of your security software or operation system for computer may limit communications between the machine and your computer. Confirm the setting of firewall function of your security software or operation system or the message appearing on your computer.

If the firewall function interferes with setting up:

- **When the message appears on your computer:**

If the message warning that Canon software is attempting to access the network appears on the computer, set the security software to allow access.

Then click **Redetect** on the **Check Printer Settings** screen.

When the machine is detected, follow the instructions on the screen to continue to set up the network communication.

- **When the message does not appear on your computer:**

Cancel to set up, then set the security software to allow Canon software* to access the network.

* Set the security software to allow **Setup.app**, **Canon IJ Network Tool.app**, **canonijnetwork.bundle**, **CIJScannerRegister.app**, **Canon IJ Scan Utility2.app**, and **CIJSUAgent.app** to access the network.

After setting the security software, try to set up the network communication from the beginning.

▶▶▶ Note

- For the operation system firewall settings or the security software firewall settings, refer to the instruction manual of the computer or software, or contact its manufacturer.

If there is no problem with the firewall settings:

Go to check 6.

■ [Cannot Detect the Machine during Wireless LAN Setup: Check 6](#)



Cannot Detect the Machine during Wireless LAN Setup: Check 6



Check the settings of the access point.

Check the settings of the access point for the network connection such as IP address filtering, MAC address filtering, or DHCP function.

Make sure that the radio channel of the access point and that assigned to the machine are the same.

For details on how to check the settings of the access point, refer to the instruction manual supplied with the access point or contact its manufacturer.

After checking the settings of the access point, click **Redetect** on the **Check Printer Settings** screen.

When the machine is detected, follow the instructions on the screen to continue to set up the network communication.

If the problem is not resolved, select the **Set up the network connection via USB** check box on the **Check Printer Settings** screen and click **Next** to set up the network communication via USB.



Cannot Detect the Machine during Wired LAN Setup: Check 1



Is the LAN cable connected, and are the machine and the router turned on?

Make sure that the LAN cable is connected.

Make sure that the machine is turned on.

■ [Confirming that the Power Is On](#)

Make sure that the router is turned on.

If the LAN cable is connected and the machine or the network device is turned off:

Turn on the machine or the network device.

After turning on the machine or the network device, it may take some time until ready for use. After a while just turning on the machine or the network device, click **Redetect** on the **Check Printer Settings** screen.

When the machine is detected, follow the instructions on the screen to continue to set up the network communication.

If the LAN cable is connected and the machine and the network device are turned on:

If the machine could not be detected after clicking **Redetect** even when the machine and the network device are turned on, or when you have turned them on, go to check 2.

■ [Cannot Detect the Machine during Wired LAN Setup: Check 2](#)



Cannot Detect the Machine during Wired LAN Setup: Check 2



Are the computer and the router configured and can the computer connect to the network?

Make sure that you can view any web pages on your computer.

If you cannot view any web pages:

Click **Cancel** on the **Check Printer Settings** screen to cancel to set up the network communication. After that, configure the computer and network device.

For the procedures, refer to the instruction manuals supplied with the computer and network device, or contact their manufacturers.

If you can view any web page after configuring the computer and network device, try to set up the network communication from the beginning.

If you can view any web page:

Go to check 3.

■ [Cannot Detect the Machine during Wired LAN Setup: Check 3](#)



Cannot Detect the Machine during Wired LAN Setup: Check 3



Is the wired LAN setting of the machine enabled?

Make sure that the **LAN** icon is displayed on the touch screen.

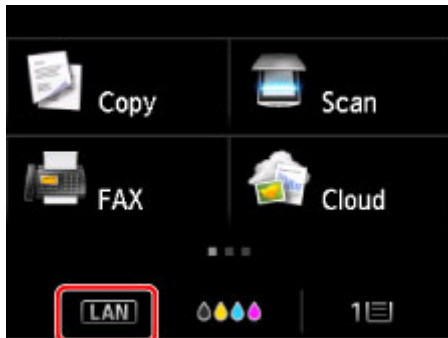

If the icon is not displayed:

The wired LAN setting of the machine is disabled. Enable the wired LAN setting of the machine.

After enabling the wired LAN setting, click **Back to Top** on the **Check Printer Settings** screen to try to set up the network communication from the beginning.

If the icon is displayed:

Go to check 4.

[Cannot Detect the Machine during Wired LAN Setup: Check 4](#)



Cannot Detect the Machine during Wired LAN Setup: Check 4



Is the machine connected to the router?

By using the operation panel of the machine, make sure that the machine is connected to the router.

Select **Setup** on the HOME screen, then select **Device settings** > **LAN settings** > **Confirm LAN settings** > **LAN setting list**.

Make sure that **Connection** on the touch screen is set to **Active**.

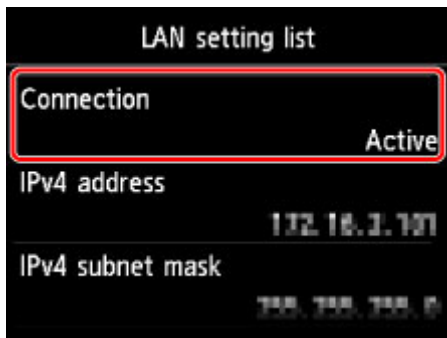

If Connection is set to Inactive:

The machine is not connected to the router. Connect the machine to the router.

Click **Back to Top** on the **Check Printer Settings** screen to try to set up the network communication from the beginning.

If Connection is set to Active:

Go to check 5.

■ [Cannot Detect the Machine during Wired LAN Setup: Check 5](#)



Cannot Detect the Machine during Wired LAN Setup: Check 5



Does the firewall function of your security software or operation system for computer interfere with setting up the network communication?

The firewall function of your security software or operation system for computer may limit communications between the machine and your computer. Confirm the setting of firewall function of your security software or operation system or the message appearing on your computer.

If the firewall function interferes with setting up:

- **When the message appears on your computer:**

If the message warning that Canon software is attempting to access the network appears on the computer, set the security software to allow access.

Then click **Redetect** on the **Check Printer Settings** screen.

When the machine is detected, follow the instructions on the screen to continue to set up the network communication.

- **When the message does not appear on your computer:**

Cancel to set up, then set the security software to allow Canon software* to access the network.

* Set the security software to allow **Setup.app**, **Canon IJ Network Tool.app**, **canonijnetwork.bundle**, **CIJScannerRegister.app**, **Canon IJ Scan Utility2.app**, and **CIJSUAgent.app** to access the network.

After setting the security software, try to set up the network communication from the beginning.

▶▶▶ Note

- For the operation system firewall settings or the security software firewall settings, refer to the instruction manual of the computer or software, or contact its manufacturer.

If there is no problem with the firewall settings:

Go to check 6.

■ [Cannot Detect the Machine during Wired LAN Setup: Check 6](#)



Cannot Detect the Machine during Wired LAN Setup: Check 6



Check the settings of the router.

Check the settings of the router for the network connection such as IP address filtering, MAC address filtering, or DHCP function.

For details on how to check the settings of the router, refer to the instruction manual supplied with the router or contact its manufacturer.

After checking the settings of the router, click **Redetect** on the **Check Printer Settings** screen.

When the machine is detected, follow the instructions on the screen to continue to set up the network communication.

If the problem is not resolved, select the **Set up the network connection via USB** check box on the **Check Printer Settings** screen and click **Next** to set up the network communication via USB.



The Machine Cannot Be Detected in the Wireless LAN



Check1 Make sure that the machine is turned on.

Check2 Is **Change LAN** in **LAN settings** under **Device settings** set to **Disable LAN**?

Check3 When the machine is connected to the computer temporarily using a USB cable, make sure that the USB cable is connected properly.

When you set up the wireless LAN connection or change the wireless LAN settings using IJ Network Tool through USB connection, make sure that the machine is connected to the computer with a USB cable securely.

■ [Connecting the Machine to the Computer Using a USB Cable](#)

Check4 Make sure that the machine setup is completed.

If not, perform setup according to the instructions on our website.

Check5 When using IJ Network Tool, click **Update** to search for the machine again.

■ [Canon IJ Network Tool Screen](#)

Check6 Make sure that the network settings in the machine are identical with those of the access point.

Refer to the instruction manual provided with the access point or contact its manufacturer to check the access point settings, and then modify the machine settings.

■ [How to Set an Encryption Key](#)

Check7 Make sure that there is no obstruction.

Wireless communication between different rooms or floors is generally poor. Adjust the location of the devices.

Check8 Make sure that the machine is not placed far away from the access point.

The access point is located indoors within the effective range for wireless communication. Locate the machine within 164 ft. / 50 m from the access point.

Check9 Make sure that there is no source of radio wave interference in your vicinity.

If a device (e.g. microwave oven) using the same frequency bandwidth as the wireless station is placed nearby, the device may cause interference. Place the wireless station as far away from the interference source as possible.

Check10 Make sure that the network settings of the computer are correct.

Make sure that the computer can communicate with the access point over the wireless LAN.

Check11 Make sure that the firewall of the security software is disabled.

If the firewall function of your security software is turned on, a message may appear warning that Canon software is attempting to access the network. If the warning message appears, set the security software to always allow access.

If using any programs that switch the network environment, check their settings. Some programs will enable a firewall by default.

Check12 When using a router, connect the machine and computer to the LAN side (same network segment).

Check13 When the machine is connected to an AirPort Base Station via a LAN, use alphanumeric characters for the name of the network (SSID).

If the problem is not resolved, perform setup again according to the instructions on our website.



The Machine Cannot Be Detected in the Wired LAN



Check1 Make sure that the machine is turned on.

Check2 Is **Change LAN** in **LAN settings** under **Device settings** set to **Disable LAN**?

 [LAN settings](#)

Check3 Make sure that the LAN cable is connected properly.

Make sure that the machine is connected to the router with the LAN cable. If the LAN cable is loose, connect the cable properly.

If the LAN cable is connected to the WAN side of the router, connect the cable to the LAN side of the router.

Other Problems with Network

- **Forgot an Access Point Name, SSID, or a Network Key**
- **The Message Is Displayed on the Computer Screen During Setup**
- **The Administrator Password Set to the Machine Was Forgotten**
- **Checking Information about the Network**
- **How to Restore the Machine's Network Settings to Factory Default**

Forgot an Access Point Name, SSID, or a Network Key

■ [Cannot Connect with an Access Point to Which a WEP or WPA/WPA2 Key Is Set \(You Forgot the WEP or WPA/WPA2 Key\)](#)

■ [How to Set an Encryption Key](#)

Cannot Connect with an Access Point to Which a WEP or WPA/WPA2 Key Is Set (You Forgot the WEP or WPA/WPA2 Key)

A

For information on how to set up the access point, refer to the instruction manual provided with the access point or contact its manufacturer. Make sure that the computer and the access point can communicate with each other.

After that, set up the machine to match the settings of the access point using IJ Network Tool.

How to Set an Encryption Key

A

For information on how to set up the access point, refer to the instruction manual provided with the access point or contact its manufacturer. Make sure that the computer and the access point can communicate with each other.

After that, set up the machine to match the settings of the access point using IJ Network Tool.

- **When using WEP**

The key length, key format, the key to use (one of 1 to 4), and the authentication method must match among the access point, the machine, and the computer.

In order to communicate with an access point that uses automatically generated WEP keys, you must configure the machine to use the key generated by the access point by entering it in hexadecimal format.

Normally, select **Auto** for the authentication method. Otherwise, select **Open System** or **Shared Key** according to the setting of the access point.

When the **WEP Details** screen appears after clicking **Set** on the **Access Points** screen, follow the on-screen instructions and set the key length, the key format, the key number, and the authentication to enter a WEP key.

For details, see [Changing the WEP Detailed Settings](#).

Note

- When the machine is connected to an AirPort Base Station via a LAN:

When the machine is connected to an AirPort Base Station via a LAN, confirm the settings in **Wireless Security** of **AirPort Utility**.

- Select **64 bit** if **WEP 40 bit** is selected for the key length in the AirPort Base Station.

- Select **1** for **Key ID**:. Otherwise your computer will not be able to communicate with the machine via the access point.

- **When using WPA/WPA2**

The authentication method, passphrase, and dynamic encryption type must match on the access point, the machine, and the computer.

Enter the passphrase configured on the access point (a sequence of between 8 and 63 alphanumeric characters, or a 64-character hexadecimal number).

Either TKIP (basic encryption) or AES (secure encryption) is selected automatically for the dynamic encryption method.

For details, see [Changing the WPA/WPA2 Detailed Settings](#).

▶▶▶ Note

- This machine supports WPA/WPA2-PSK (WPA/WPA2-Personal) and WPA2-PSK (WPA2-Personal).

The Message Is Displayed on the Computer Screen During Setup

■ [The Enter Password Screen Is Displayed During Setup](#)

■ [The Screen for Setting the Encryption Is Displayed After Selecting the Access Point in the Access Points Screen](#)

■ ["You are connecting the machine to the non encrypted wireless network" Is Displayed](#)

Q The Enter Password Screen Is Displayed During Setup

A

The following screen is displayed if an administrator password is set to the machine which has already been set up to use via a network.



Enter the administrator password you have set.

►► Note

- An administrator password is already specified for the machine at the time of purchase.

For details:

■ [About the Administrator Password](#)

For improving security, it is recommended to change the administrator password.

■ [Changing the Settings in the Admin Password Sheet](#)

Q The Screen for Setting the Encryption Is Displayed After Selecting the Access Point in the Access Points Screen

A

This screen is displayed automatically if the selected access point is encrypted. In this case, configure the details to use the same encryption settings set to the access point.

For information on the encryption settings, see [Changing the Settings in the Wireless LAN Sheet](#).

Q "You are connecting the machine to the non encrypted wireless network" Is Displayed

A

Security is not configured on the access point. The machine can still be used, so continue the setup procedure to complete it.

»» Important

- If you connect to a network that is not protected with security measures, there is a risk of disclosing data such as your personal information to a third party.



The Administrator Password Set to the Machine Was Forgotten



Initialize the machine settings.

Select **Reset all**, then the administrator password reverts to the default.

■ [Reset setting](#)

After initializing the machine settings, perform setup according to the instructions on our website.

Checking Information about the Network

■ [Checking the IP Address or the MAC Address of the Machine](#)

■ [Checking the IP Address or the MAC Address of the Computer](#)

■ [Checking If the Computer and the Machine, or Computer and the Access Point Can Communicate](#)

■ [Checking the Network Setting Information](#)

Checking the IP Address or the MAC Address of the Machine

To check the IP address or the MAC address of the machine, display the network setting information using the operation panel of the machine or print out the network setting information of the machine.

■ [LAN settings](#)

■ [Printing Out Network Setting Information](#)

To display the network setting information using IJ Network Tool, select **Network Information** on the **View** menu.

■ [Canon IJ Network Tool Menus](#)

Checking the IP Address or the MAC Address of the Computer

To check the IP address or MAC address assigned to the computer, follow the procedure below.

1. Select **System Preferences** from the Apple menu, then click **Network**.
2. Make sure that the network interface you are using on your computer is selected, then click **Advanced**.
 - In Mac OS X v10.9, Mac OS X v10.8, or Mac OS X v10.7:
When you are using wireless LAN on your computer, make sure that **Wi-Fi** is selected as the network interface. When you are using wired LAN, make sure that **Ethernet** is selected.
 - In Mac OS X v10.6.8:
When you are using wireless LAN on your computer, make sure that **AirMac** is selected as the network interface. When you are using wired LAN, make sure that **Ethernet** is selected.
3. Confirm the IP address or MAC address.
 - In Mac OS X v10.9, Mac OS X v10.8, or Mac OS X v10.7:
Click **TCP/IP** to confirm the IP address.
Click **Hardware** to confirm the MAC address.
 - In Mac OS X v10.6.8:

Click **TCP/IP** to confirm the IP address.

Click **Ethernet**, then see **Ethernet ID** to confirm the MAC address.

Checking If the Computer and the Machine, or Computer and the Access Point Can Communicate

A

To check that communication is available, perform the ping test.

1. Open the **Utilities** folder in the **Applications** folder.
2. Start **Network Utility**.
3. Click the **Ping** button.
4. Make sure that **Send only XX pings** (XX are numbers) is selected.
5. Enter the IP address of the target machine or the target access point in **Enter the network address to ping..**
6. Click **Ping**.

"XXX.XXX.XXX.XXX" is the IP address of the target device.

A message such as the following is displayed.

```
64 bytes from XXX.XXX.XXX.XXX: icmp_seq=0 ttl=64 time=3.394 ms
```

```
64 bytes from XXX.XXX.XXX.XXX: icmp_seq=1 ttl=64 time=1.786 ms
```

```
64 bytes from XXX.XXX.XXX.XXX: icmp_seq=2 ttl=64 time=1.739 ms
```

```
--- XXX.XXX.XXX.XXX ping statistics ---
```

```
3 packets transmitted, 3 packets received, 0% packet loss
```

If the packet loss is 100%, the communication is not available. Otherwise, the computer is communicating with the target device.

Checking the Network Setting Information

A

To check the network setting information of the machine, display the network setting information using the operation panel of the machine or print out the network setting information of the machine.

■ [LAN settings](#)

■ [Printing Out Network Setting Information](#)



How to Restore the Machine's Network Settings to Factory Default



▶▶ Important

- Note that initialization erases all network settings on the machine, and printing or scanning operation from a computer over network may become impossible. To use the machine over network, perform setup according to the instructions on our website.

Initialize the network setting using the operation panel of the machine.

■ [Reset setting](#)

Problems with Printing

- **Printing Does Not Start**
- **Paper Jams**
- **Paper Does Not Feed Properly/"No Paper" Error Occurs**
- **Cannot Print Properly with Automatic Duplex Printing**
- **Copying/Printing Stops Before It Is Completed**



Printing Does Not Start



Check1 Make sure that the power plug is securely plugged in, then press the **ON** button to turn the machine on.

While the **POWER** lamp is flashing, the machine is initializing. Wait until the **POWER** lamp stops flashing and remains lit.

▶▶▶ Note

- When printing large data such as a photo or graphics, it may take longer to start printing. While the **POWER** lamp is flashing, the computer is processing data and sending it to the machine. Wait until printing starts.

Check2 Make sure that the machine is connected to your computer properly.

When the machine is connected to your computer with a USB cable, make sure that the USB cable is securely plugged in to the machine and the computer, then check the followings:

- If you are using a relay device such as a USB hub, disconnect it, connect the machine directly to the computer, and try printing again. If printing starts normally, there is a problem with the relay device. Consult the reseller of the relay device for details.
- There could also be a problem with the USB cable. Replace the USB cable and try printing again.

When you use the machine over LAN, make sure that the machine is connected to the network with a LAN cable or is set up correctly.

Check3 Is the access point mode enabled?

When you print using a mode other than the access point mode, disable the access point mode in advance.

Check4 Are the paper settings identical with those registered to the cassette?

When the paper settings are not identical with those registered to the cassette, an error message is displayed. Resolve the error according to the instructions on the touch screen.

■ [Paper Setting for Printing](#)

▶▶▶ Note

- You can disable the message which prevents misprinting.
 - To change the setting using the operation panel:
 - [Cassette settings](#)
 - To change the setting using the printer driver:
 - [Changing the Printer Operation Mode](#)

Check5 If you are printing from the computer and there are any unnecessary print jobs, delete them.

■ [Deleting the Undesired Print Job](#)

Check6 Make sure that your machine's name is selected in the Print dialog.

The machine will not print properly if you are using a printer driver for a different printer.

Make sure that your machine's name is selected in **Printer** in the Print dialog.

▶▶ **Note**

- To make the machine the one selected by default, select the machine for **Default printer**.

Check7 Restart your computer if you are printing from the computer.



Paper Jams



When paper is jammed, a troubleshooting message is displayed automatically. Take the appropriate action described in the message.

- **When a Support Code and a message are displayed on the computer screen:**

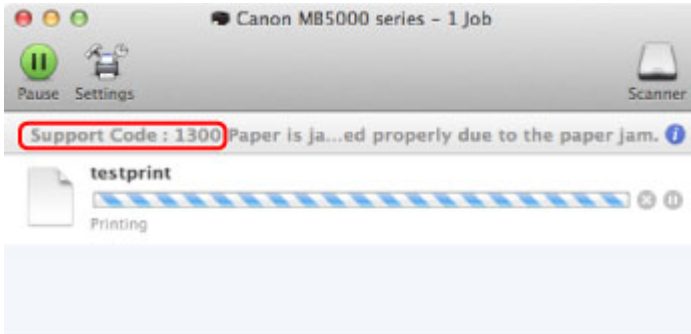

* The screen differs depending on the OS you are using.

- **When a Support Code and a message are displayed on the touch screen:**

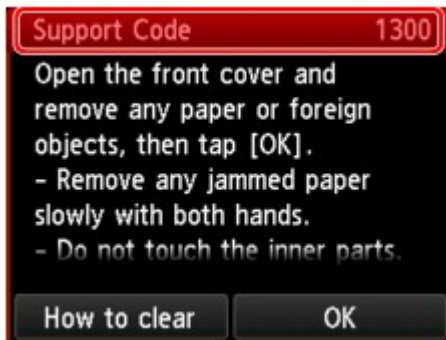

For details on how to remove the jammed paper, refer to [Support Code List \(When Paper Is Jammed\)](#).

▶▶▶ Note

- You can confirm the actions against errors with Support Codes on your computer or on the touch screen by searching a Support Code.

■ [Click Here to Search](#)



Paper Does Not Feed Properly/"No Paper" Error Occurs



Check1 Make sure that paper is loaded.

■ [Loading Paper](#)

Check2 Make sure of the following when you load paper.

- When loading two or more sheets of paper, flip through the paper before loading. In addition, when you load paper with some paper remaining in the cassette, flip through the remaining paper and the newly loaded paper before loading.



- When loading two or more sheets of paper, align the edges of the sheets before loading.
- When loading two or more sheets of paper, make sure that the paper stack does not exceed the paper load limit.

However, proper feeding of paper may not be possible at this maximum capacity depending on the type of paper or environmental conditions (either very high or low temperature and humidity). In such cases, reduce the sheets of paper you load at a time to less than half of the paper load limit.

- Always load the paper in portrait orientation, regardless of the printing orientation.

■ [Loading Paper](#)

▶▶▶ Important

- When loading paper in the cassette, slide the paper guide on the front side to align with the corresponding mark of page size. Load the paper with the print side facing DOWN, load the paper stack in the center of the cassette, then slide the paper guides to align with the both edges of the paper stack.

■ [Loading Paper](#)

Check3 Check to see if the paper you are printing on is not too thick or curled.

■ [Media Types You Cannot Use](#)

Check4 Make sure of the following when you load Hagakis or envelopes.

- If a Hagaki is curled, it may not feed properly even though the paper stack does not exceed the paper load limit.

Load Hagakis with a zip code column toward the far end of the cassette.

- When printing on envelopes, refer to [Loading Paper](#), and prepare the envelopes before printing.

Once you have prepared the envelopes, load them in portrait orientation. If the envelopes are placed in landscape orientation, they will not feed properly.

Check5 Confirm that the media type and the paper size settings correspond with the loaded paper.

Check6 Clean the paper feed roller.

■ [Cleaning the Paper Feed Roller](#)

▶▶ Note

- Cleaning the paper feed roller will wear the roller, so perform this procedure only when necessary.

Check7 If two or more sheets of paper feed from the cassette at once, clean the inside of the cassette.

For information on cleaning the inside of the cassette, refer to [Cleaning the Pad in the Cassette](#).

If you cannot remove the paper or the paper tears inside the machine, or if the paper jam error continues after removing the paper, contact the service center.



Cannot Print Properly with Automatic Duplex Printing



Check1 Is the setting for automatic duplex printing selected?

Make sure that the **Two-Sided** check box is selected on the Print dialog.

 [Duplex Printing](#)

Check2 Make sure that the actual size of the paper is suitable for automatic duplex printing.

The sizes of media suitable for automatic duplex printing are A4 and Letter.

Load paper of suitable size, then tap **OK** on the touch screen.

Check3 Make sure that the paper size setting is correct.

Make sure that the paper size setting matches the actual size of the paper with a size suitable for automatic duplex printing.

First, check the paper size setting in the application software you are printing from.

Then, check the **Paper Size** on the Page Setup dialog.

Note

- Duplex printing may not be available depending on the version of the application software.

Check4 Make sure that the media type setting is correct.

Make sure that the media type setting matches the actual size of the paper with a size suitable for automatic duplex printing.

Make sure that the type of loaded paper is suitable for automatic duplex printing on the **Quality & Media** sheet on the Print dialog.

Note

- Manual duplex printing is not available.



Copying/Printing Stops Before It Is Completed



Check1 Is the paper loaded?

Make sure that paper is loaded.

If the machine has run out of paper, load paper.

Check2 Do the printing documents have lots of photographs or illustrations?

As printing large data such as photos or graphics takes time for the machine and the computer to process, the machine may appear to have stopped operating.

In addition, when printing data that uses a large amount of ink continuously on plain paper, the machine may pause temporarily. In either case, wait until the process is complete.

▶▶▶ Note

- If you are printing a document with a large printing area or printing multiple copies of a document, printing may pause to allow the ink to dry.

Check3 Has the machine been printing continuously for a long period?

If the machine has been printing continuously for a long time, the print head or other parts around it may overheat. The machine may stop printing at a line break for a period of time and then resume printing.

In this case, wait for a while without operation. If the printing still does not resume, interrupt your print session at a convenient time and turn the machine off for at least 15 minutes.

⚠ Caution

- The print head and the surrounding area can become extremely hot inside the machine. Never touch the print head or nearby components.

Problems with Printing Quality

- **Print Results Not Satisfactory**
- **Ink Is Not Ejected**



Print Results Not Satisfactory



If the print result is not satisfactory due to white streaks, misaligned lines, or uneven colors, confirm the paper and print quality settings first.

Check1 Do the page size and media type settings match the size and type of the loaded paper?

When these settings are incorrect, you cannot obtain a proper print result.

If you are printing a photograph or an illustration, incorrect paper type settings may reduce the quality of the printout color.

Also, if you print with an incorrect paper type setting, the printed surface may be scratched.

The method of confirming the paper and print quality settings differs depending on what you do with your machine.

To copy by operating the machine	Confirm by using the operation panel on the machine. ■■Setting Items for Copying
To print from your USB flash drive by operating the machine	Confirm by using the operation panel on the machine. ■■Setting Items for Photo Printing Using the Operation Panel of the Machine
To print from a computer	Confirm by using the printer driver. ■■Printing with Easy Setup

Check2 Make sure that the appropriate print quality is selected referring to the table in Check 1.

Select a print quality option suitable for the paper and image for printing. If you notice blurs or uneven colors, increase the print quality setting and try printing again.

Check3 If the problem is not resolved, there may be other causes.

See also the sections below:

[■■Cannot Print to End of Job](#)

[■■No Printing Results/Printing Is Blurred/Colors Are Wrong/White Streaks](#)

[■■Lines Are Misaligned](#)

[■■Printed Paper Curls or Has Ink Blots](#)

[■■Paper Is Smudged/Printed Surface Is Scratched](#)

[■■Back of the Paper Is Smudged](#)

[■■Colors Are Uneven or Streaked](#)



Cannot Print to End of Job



Check Is the space of your computer's hard disk sufficient?

Delete unnecessary files to free disk space.



No Printing Results/Printing Is Blurred/Colors Are Wrong/White Streaks

❖ No Printing Results



❖ Printing Is Blurred

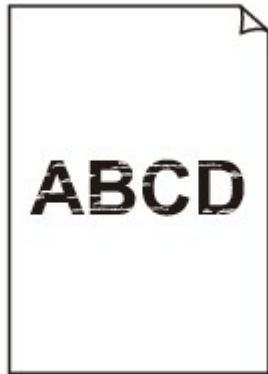

❖ Colors Are Wrong

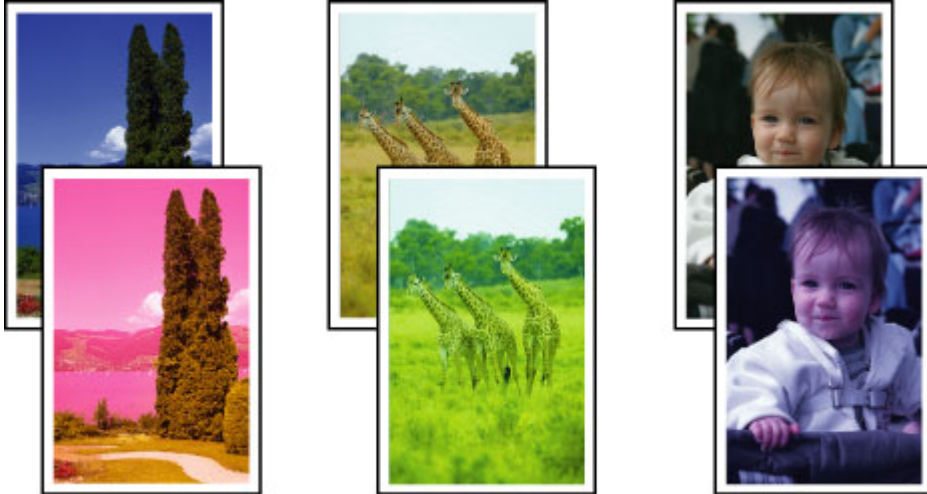

White Streaks

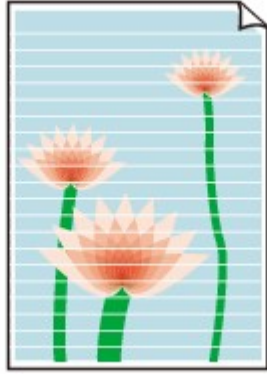

A

Check1 Did you confirm the paper and print quality settings?

■ [Print Results Not Satisfactory](#)

Check2 Check the status of ink tanks. Replace the ink tank if the ink has run out.

■ [Replacing an Ink Tank](#)

Check3 Print the Nozzle Check Pattern and perform any necessary maintenance operations such as Print Head Cleaning.

Print the Nozzle Check Pattern to determine whether the ink ejects properly from the print head nozzles.

Refer to [When Printing Becomes Faint or Colors Are Incorrect](#) for the Nozzle Check Pattern printing, Print Head Cleaning, and Print Head Deep Cleaning.

- If the Nozzle Check Pattern is not printed correctly:

Check to see if a particular color's ink tank is not empty.

If the Nozzle Check Pattern is not printed correctly though ink is sufficient, perform the Print Head Cleaning and try printing the Nozzle Check Pattern again.

- If the problem is not resolved after performing the Print Head Cleaning twice:

Perform the Print Head Deep Cleaning.

If the problem is not resolved after performing the Print Head Deep Cleaning, turn off the machine and perform another Print Head Deep Cleaning after 24 hours. When you turn the machine off, do not unplug it from the power supply.

- If the problem is not resolved after performing the Print Head Deep Cleaning twice:

If Print Head Deep Cleaning does not resolve the problem, the print head may be damaged. Contact the service center.

Check4 When using paper with one printable surface, make sure that the paper is loaded with the printable side facing down.

Printing on the wrong side of such paper may cause unclear prints or prints with reduced quality.

Load paper with the printable side facing down.

Refer to the instruction manual supplied with the paper for detailed information on the printable side.

- **When copying, see also the sections below:**

Check5 Is the platen glass or the glass of ADF dirty?

Clean the platen glass or the glass of ADF.

■ [Cleaning the Platen Glass and Document Cover](#)

▶▶▶ **Note**

- If the glass of ADF is dirty, black streaks appear on the paper as shown below.



Check6 Check that the original is loaded correctly on the platen glass or in the ADF.

■ [Loading Originals](#)

Check7 Is the original document is loaded with the proper side facing up/down?

When loading the original on the platen glass, the side to be copied should be face down. When loading the original in the ADF, the side to be copied should be face up.

Check8 Did you copy a printout done by this machine?

If you use a printout done by this machine as the original, print quality may be reduced depending on the condition of the original.

Print from the machine directly, or reprint from the computer if you can reprint from it.



Lines Are Misaligned



Check1 Did you confirm the paper and print quality settings?

■ [Print Results Not Satisfactory](#)

Check2 Perform Print Head Alignment.

If printed lines are misaligned or print results are otherwise unsatisfactory, adjust the print head position.

■ [Aligning the Print Head](#)

▶▶▶ Note

- If the problem is not resolved after performing the Print Head Alignment, perform Print Head Alignment manually referring to [Aligning the Print Head Manually](#).

Check3 Increase the print quality and try printing again.

Increasing the print quality on the operation panel of the machine or in the printer driver may improve the print result.



Printed Paper Curls or Has Ink Blots

Printed Paper Has Ink Blots



Printed Paper Curls



Check1 Did you confirm the paper and print quality settings?

■ [Print Results Not Satisfactory](#)

Check2 If the intensity is set high, reduce the intensity setting and try printing again.

If you are using plain paper to print images with high intensity, the paper may absorb too much ink and become wavy, causing paper abrasion.

- When printing from your computer
You can confirm the intensity using the printer driver.

■ [Adjusting Intensity](#)

- When copying

■ [Setting Items for Copying](#)

Check3 Is Photo Paper used for printing photographs?

When printing data with high color saturation such as photographs or images in deep color, we recommend using Photo Paper Plus Glossy II or other Canon speciality paper.

■ [Media Types You Can Use](#)



Paper Is Smudged/Printed Surface Is Scratched

Paper Is Smudged

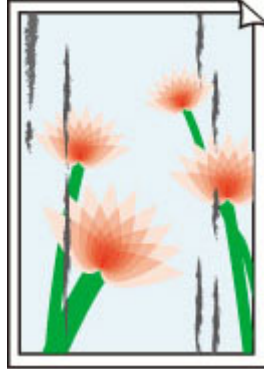
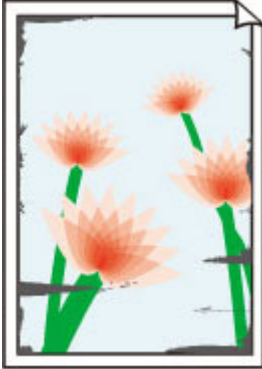

The Edges of Paper Are Smudged Printed Surface Is Smudged



Printed Surface Is Scratched



Check1 Did you confirm the paper and print quality settings?

 [Print Results Not Satisfactory](#)

Check2 Is the appropriate type of paper used?

Check to see if the paper you are printing on is suitable for your printing purpose.

 [Media Types You Can Use](#)

Check3 Load the paper after correcting its curl.

When using Photo Paper Plus Semi-gloss, even if the sheet is curled, load one sheet at a time as it is. If you roll up this paper to flatten, this may cause cracks on the surface of the paper and reduce the print quality.

We recommend putting unused paper back into the package and keeping it on a level surface.

- **For Plain Paper**

Turn the paper over and reload it to print on the other side.

- **For Other Paper**

If the curl on the four corners of the paper is more than 0.1 inch / 3 mm (A) in height, the paper may be smudged or may not be fed properly. In such cases, follow the procedure described below to correct the paper curl.



1. Roll up the paper in the opposite direction to the paper curl as shown below.

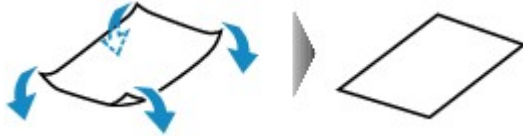

2. Check that the paper is now flat.

We recommend printing curl-corrected paper one sheet at a time.

▶▶▶ Note

- Depending on the media type, the paper may be smudged or may not be fed properly even if it is not curled inward. In such cases, follow the procedure described below to curl the paper outward within 0.1 inch / 3 mm (B) in height before printing. This may improve the print result.

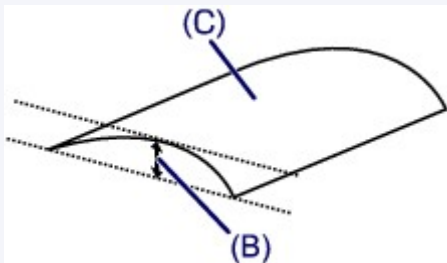

(C) Printing side

We recommend printing paper that has been curled outward one sheet at a time.

Check4 Adjust the setting to prevent paper abrasion.

Adjusting the setting to prevent paper abrasion will widen the clearance between the print head and the loaded paper. If you notice abrasion even with the media type set correctly to match the loaded paper, set the machine to prevent paper abrasion by using the operation panel or the computer.

Print speed may be reduced if you apply the setting to prevent paper abrasion setting.

* Readjust the setting not to prevent paper abrasion once printing is complete. If not, this setting remains enabled for all subsequent print jobs.

• To set by using the operation panel

Press the **HOME** button, select **Setup**, **Device settings**, and **Print settings** in this order, and then set **Prevent paper abrasion** to **ON**.

■ [Changing the Machine Settings Using the Operation Panel](#)

• To set by using your computer

In the Canon IJ Printer Utility, select **Custom Settings** in the pop-up menu, select the **Prevent paper abrasion** check box, and then click **Apply**.

To open the Canon IJ Printer Utility, see [Opening the Canon IJ Printer Utility](#).

Check5 If the intensity is set high, reduce the intensity setting and try printing again.

If you are using plain paper to print images with high intensity, the paper may absorb too much ink and become wavy, causing paper abrasion.

- When printing from your computer

Reduce the intensity setting in the printer driver and try printing again.

1. Open the Print dialog.

■ [How to Open the Printer Driver Setup Window](#)

2. Select **Color Options** in the pop-up menu.

3. Drag the **Intensity** slide bar to set the intensity.

- When copying

■ [Setting Items for Copying](#)

Check6 Is printing performed beyond the recommended printing area?

If you are printing beyond the recommended printing area of your printing paper, the lower edge of the paper may become stained with ink.

Resize your original document in your application software.

■ [Printing Area](#)

Check7 Is the platen glass or the glass of ADF dirty?

Clean the platen glass or the glass of ADF.

■ [Cleaning the Platen Glass and Document Cover](#)

▶▶▶ Note

- If the glass of ADF is dirty, black streaks appear on the paper as shown below.



Check8 Is the paper feed roller dirty?

Clean the paper feed roller.

■ [Cleaning the Paper Feed Roller](#)

▶▶▶ Note

- Cleaning the paper feed roller will wear the roller, so perform this procedure only when necessary.

Check9 Is the inside of the machine dirty?

When performing duplex printing, the inside of the machine may become stained with ink, causing the printout to become smudged.

Perform the Bottom Plate Cleaning to clean the inside of the machine.

■ [Cleaning the Inside of the Machine \(Bottom Plate Cleaning\)](#)

▶▶ Note

- To prevent the inside of the machine from stains, set the paper size correctly.

Check10 Set the time to dry the printed surface longer.

Doing so gives the printed surface enough time to dry so that paper smudged and scratched are prevented.

1. Make sure that the machine is turned on.
2. Open the Canon IJ Printer Utility.
 - [Opening the Canon IJ Printer Utility](#)
3. Select **Custom Settings** in the pop-up menu.
4. Drag the **Ink Drying Wait Time**: slide bar to set the wait time, and then click **Apply**.
5. Confirm the message and click **OK**.



Back of the Paper Is Smudged

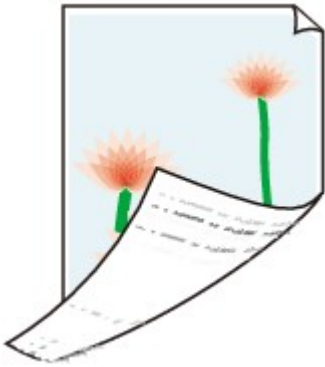

Check1 Did you confirm the paper and print quality settings?

■ [Print Results Not Satisfactory](#)

Check2 Perform the Bottom Plate Cleaning to clean the inside of the machine.

■ [Cleaning the Inside of the Machine \(Bottom Plate Cleaning\)](#)

▶▶ Note

- When performing duplex printing or too much printing, the inside may become stained with ink.



Colors Are Uneven or Streaked

Colors Are Uneven



Colors Are Streaked



Check1 Did you confirm the paper and print quality settings?

■ [Print Results Not Satisfactory](#)

Check2 Print the Nozzle Check Pattern and perform any necessary maintenance operations such as Print Head Cleaning.

Print the Nozzle Check Pattern to determine whether the ink ejects properly from the print head nozzles.

Refer to [When Printing Becomes Faint or Colors Are Incorrect](#) for the Nozzle Check Pattern printing, Print Head Cleaning, and Print Head Deep Cleaning.

- If the Nozzle Check Pattern is not printed correctly:

Check to see if a particular color's ink tank is not empty.

If the Nozzle Check Pattern is not printed correctly though ink is sufficient, perform the Print Head Cleaning and try printing the Nozzle Check Pattern again.

- If the problem is not resolved after performing the Print Head Cleaning twice:

Perform the Print Head Deep Cleaning.

If the problem is not resolved after performing the Print Head Deep Cleaning, turn off the machine and perform another Print Head Deep Cleaning after 24 hours. When you turn the machine off, do not unplug it from the power supply.

- If the problem is not resolved after performing the Print Head Deep Cleaning twice:

If Print Head Deep Cleaning does not resolve the problem, the print head may be damaged. Contact the service center.

Check3 Perform Print Head Alignment.

■ [Aligning the Print Head](#)

▶▶ Note

- If the problem is not resolved after performing the Print Head Alignment, perform Print Head Alignment manually referring to [Aligning the Print Head Manually](#).



Ink Is Not Ejected



Check1 Has the ink run out?

Check the Support Code on the touch screen and take the appropriate action to resolve the error.

■ [Support Code List](#)

Check2 Are the print head nozzles clogged?

Print the Nozzle Check Pattern to determine whether the ink ejects properly from the print head nozzles.

Refer to [When Printing Becomes Faint or Colors Are Incorrect](#) for the Nozzle Check Pattern printing, Print Head Cleaning, and Print Head Deep Cleaning.

- If the Nozzle Check Pattern is not printed correctly:

Check to see if a particular color's ink tank is not empty.

If the Nozzle Check Pattern is not printed correctly though ink is sufficient, perform the Print Head Cleaning and try printing the Nozzle Check Pattern again.

- If the problem is not resolved after performing the Print Head Cleaning twice:

Perform the Print Head Deep Cleaning.

If the problem is not resolved after performing the Print Head Deep Cleaning, turn off the machine and perform another Print Head Deep Cleaning after 24 hours. When you turn the machine off, do not unplug it from the power supply.

- If the problem is not resolved after performing the Print Head Deep Cleaning twice:

If Print Head Deep Cleaning does not resolve the problem, the print head may be damaged. Contact the service center.

Problems with Faxing

- ▶ **Problems Sending Faxes**
- ▶ **Problems Receiving Faxes**
- ▶ **Cannot Send a Fax Clearly**
- ▶ **Telephone Problems**

Problems Sending Faxes

■ [Cannot Send a Fax](#)

■ [Cannot Perform Sequential Broadcasting by Redialing, or Cannot Dial by Entering the Numbers](#)

■ [Errors Often Occur When You Send a Fax](#)



Cannot Send a Fax



Check1 Is the power turned on?

- You cannot send faxes if the power is turned off. Press the **ON** button to turn the power on.
- If you unplugged the power cord without turning off the power (the **POWER** lamp is lit), reconnecting it turns on the power automatically.
- If you unplugged the power cord after pressing the **ON** button to turn off the power (the **POWER** lamp is off), reconnect it, then press the **ON** button to turn on the power.
- If the power was turned off due to power failure, etc., the power is automatically turned on when the power failure is resolved.

►► Important

- Confirm that the **POWER** lamp is off before unplugging the power cord, then unplug the power cord. If a power failure occurs or you unplug the power cord, all faxes stored in the machine's memory are deleted. For details on how to unplug the power cord, refer to [Notice for Unplugging the Power Cord](#).

►► Note

- If the faxes stored in the machine's memory are deleted by a power failure or unplugging the power cord, the list of the faxes deleted from the machine's memory (MEMORY CLEAR REPORT) will be printed after turning the machine on. For details, see [Summary of Reports and Lists](#).

Check2 Is the document being sent from memory or the fax being received into memory?

When the message for the transmission/reception is displayed on the Fax standby screen, a fax is being sent from/received into machine's memory. Wait until the transmission/reception is complete.

Check3 Is the machine's memory full?

Delete contents in memory, then send a fax again.

■ [Document Stored in Machine's Memory](#)

Check4 Is the telephone line type set correctly?

Check the telephone line type setting and change it as necessary.

■ [Setting the Telephone Line Type](#)

Check5 Is Hook key setting set to Disable?

When you send a fax manually, dial the number with **Enable** selected for **Hook key setting** in **Security control** under **FAX settings**, or dial the number using the telephone connected to the machine.

■ [Security control](#)

Check6 Is Dial tone detect set to ON?

Resend the fax after a while.

If you still cannot send the fax, select **OFF** for **Dial tone detect** in **Advanced FAX settings** under **FAX settings**.

■ [Advanced FAX settings](#)

Check7 Is the fax number registered correctly in the machine's directory?

Check the recipient's fax/telephone number, correct the fax/telephone number registered in the machine's directory, then send the document again.

■ [Changing Registered Information](#)

▶▶▶ Note

- You can check the registered information in the machine's directory by printing RECIPIENT TELEPHONE NUMBER LIST.

■ [Summary of Reports and Lists](#)

Check8 Does an error occur during transmission?

- Ensure that a message is displayed on the Fax standby screen. When a message is displayed on the Fax standby screen, check the cause.

■ [A Message for Faxing Is Displayed on the Fax Standby Screen](#)

- Print ACTIVITY REPORT and check for an error.

■ [Summary of Reports and Lists](#)

Check9 Is the document loaded properly?

Remove the document, then reload it on the platen glass or in the ADF.

■ [Loading Originals](#)

Check10 Does a printer error occur?

Ensure that an error message is displayed on the touch screen. When an error message is displayed on the touch screen, check the cause.

When the error message with the support code is displayed, refer to [Support Code List](#).

When the error message without the support code is displayed, refer to [A Message Is Displayed](#).

If you are in a hurry, press the **Stop** button to close the message, then send the fax.

Check11 Is the telephone line connected correctly?

Reconnect the telephone line cable to the telephone line jack.

■ [Basic Connection](#)

If the telephone line is connected correctly, there is a problem with your telephone line. Contact your telephone company and the manufacturer of your terminal adapter or telephone adapter.

Cannot Perform Sequential Broadcasting by Redialing, or Cannot Dial by Entering the Numbers

A

Check Have you already selected the recipient from the redial history, or already dialed a number by entering the fax/telephone numbers?

You can dial one recipient by selecting from the redial history or by entering the fax/telephone numbers as the recipient of sequential broadcasting.

If you already have dialed by selecting from the redial history or by entering the fax/telephone numbers, select the recipient from the machine's directory.

Errors Often Occur When You Send a Fax

A

Check Check the telephone line condition or the connection.

If the telephone line or connection is poor, reducing the transmission start speed may correct the error.

Reduce the transmission start speed on **TX start speed** in **Adv. communication settings** in **Advanced FAX settings** under **FAX settings**.

 [Advanced FAX settings](#)

Problems Receiving Faxes

■ [Cannot Receive a Fax, Cannot Print a Fax](#)

■ [Machine Does Not Switch Automatically between Voice and Fax Calls](#)

■ [Quality of Received Fax is Poor](#)

■ [Cannot Receive a Color Fax](#)

■ [Errors Often Occur When You Receive a Fax](#)



Cannot Receive a Fax, Cannot Print a Fax



Check1 Is the power turned on?

- You cannot receive faxes if the power is turned off. Press the **ON** button to turn the power on.
- If you unplugged the power cord without turning off the power (the **POWER** lamp is lit), reconnecting it turns on the power automatically.
- If you unplugged the power cord after pressing the **ON** button to turn off the power (the **POWER** lamp is off), reconnect it, then press the **ON** button to turn on the power.
- If the power was turned off due to power failure, etc., the power is automatically turned on when the power failure is resolved.

►► Important

- Confirm that the **POWER** lamp is off before unplugging the power cord, then unplug the power cord. If a power failure occurs or you unplug the power cord, all faxes stored in the machine's memory are deleted. For details on how to unplug the power cord, refer to [Notice for Unplugging the Power Cord](#).

►► Note

- If the faxes stored in the machine's memory are deleted by a power failure or unplugging the power cord, the list of the faxes deleted from the machine's memory (MEMORY CLEAR REPORT) will be printed after turning the machine on. For details, see [Summary of Reports and Lists](#).

Check2 Is the machine's memory full?

Print the received faxes stored in the machine's memory, save them on the USB flash drive, or forward them to the shared folder on the computer, then delete them from the machine's memory and have the sender resend the faxes.

■ [Document Stored in Machine's Memory](#)

Check3 Does an error occur during reception?

- Ensure that a message is displayed on the Fax standby screen. When a message is displayed on the Fax standby screen, check the cause.

■ [A Message for Faxing Is Displayed on the Fax Standby Screen](#)

- Print **ACTIVITY REPORT** and check for an error.

■ [Summary of Reports and Lists](#)

Check4 Is the telephone line cable connected to the external device jack?

Reconnect it to the telephone line jack.

■ [Basic Connection](#)

Check5 Is a different size of paper from that specified by **Page size** in **FAX paper settings** loaded?

If a different size of paper from that specified by **Page size** is loaded for printing faxes, the received faxes will not be printed and will be stored in the machine's memory (Memory Reception). Load the same size of paper as that specified by **Page size**, tap **OK** on the touch screen.

Check6 Is paper loaded?

If paper is not loaded, received faxes will be stored in the machine's memory without being printed (Memory Reception). Load paper, then tap **OK** on the touch screen.

Check7 Is the amount of remaining ink sufficient to print a fax?

If the amount of remaining ink is insufficient to print, received faxes will be stored in the machine's memory without being printed (Memory Reception). Replace the ink tank, then print the faxes in the machine's memory.

■ [Document Stored in Machine's Memory](#)

▶▶▶ **Note**

- If the machine was receiving faxes in the fax mode, printing will start automatically after the ink tank is replaced.

■ [Replacing an Ink Tank](#)

- When the machine receives black & white faxes in the machine's memory, if **2-sided** is selected for **2-sidedPrintSetting** in **FAX paper settings**, selecting **1-sided** may print the faxes.
- You can set the machine to forcibly print a received fax even if the ink has run out.

Set **Print when out of ink** in **Auto print settings** under **FAX settings** to **Print**.

However, part or all of the fax may not be printed since the ink has run out.

Also, the contents of the fax will not be stored in the machine's memory.

If the ink has already run out, we recommend that **Do not print** be selected for **Received documents** in **Auto print settings** under **FAX settings** to store the received fax in the machine's memory. After you replace the ink tank and select **Print** for **Received documents** in **Auto print settings**, the fax stored in the machine's memory will be printed automatically.

■ [Auto print settings](#)

Check8 Is the machine set to the appropriate receive mode?

Check the receive mode setting and change it to a mode suited to your connection if necessary.

■ [Setting the Receive Mode](#)

Check9 Is **FAX reception reject** set to **ON**?

Select **OFF** for **FAX reception reject** in **Security control** under **FAX settings**.

For details on how to set, see [Rejecting Fax Reception](#).

Check10 Are there setting items set **Reject** in **Caller rejection**?

If you select **Reject** for any setting items in **Caller rejection** in **Security control** under **FAX settings**, the machine rejects calls for setting item selected **Reject**.

For details on how to set, see [Using the Caller ID Service to Reject Calls](#).

Machine Does Not Switch Automatically between Voice and Fax Calls



Check Is the receive mode set to **FAX only mode**?

If **FAX only mode** is selected for **Receive mode settings**, there will be no automatic switching between voice and fax calls.

Set the receive mode to **TEL priority mode**, **DRPD*1**, or **Network switch*2**.

If the receive mode is **TEL priority mode** and an answering machine is connected to the machine, check whether a proper message is played back when the answering machine answers.

■ [Setting the Receive Mode](#)

*1 This setting is available only in the US and Canada.

*2 This setting may not be available depending on the country or region of purchase.

Quality of Received Fax is Poor



Check1 Check the scan settings of the sender's fax machine.

Ask the sender to adjust the scan settings of the fax machine.

Check2 Is **ECM RX** set to **OFF**?

Select **ON** for **ECM RX** in **Adv. communication settings** in **Advanced FAX settings** under **FAX settings**.

If **ECM RX** is enabled, the sender's fax machine resends the fax after correcting errors automatically.

■ [Advanced FAX settings](#)

Check3 Is the sender's original document or scanning area of the sender's fax machine dirty?

The image quality of the fax is mainly determined by the sender's fax machine. Contact the sender and ask the sender to check whether the scanning area of the fax machine is dirty.

Check4 Is ECM transmission/reception enabled although the line/connection is poor, or is the sender's fax machine compatible with ECM?

- Select **ON** for **ECM RX** in **Adv. communication settings** in **Advanced FAX settings** under **FAX settings**.

■ [Advanced FAX settings](#)

- Contact the sender and ask the sender to check whether the machine is set to enable ECM transmission. If the sender's or recipient's fax machine is not compatible with ECM, the fax will be sent/received without automatic error correction.
- Reduce the reception start speed on **RX start speed** in **Adv. communication settings** in **Advanced FAX settings** under **FAX settings**.

■ [Advanced FAX settings](#)

Check5 Did you confirm the paper and print quality settings?

■ [Print Results Not Satisfactory](#)

Cannot Receive a Color Fax

A

Check Is **ECM RX** set to **OFF**?

If **OFF** is select for **ECM RX** in **Adv. communication settings** in **Advanced FAX settings** under **FAX settings**, the machine cannot receive color faxes. The machine will disconnect the telephone line or receive color faxes in black & white according to the setting of the sender's fax machine.

Set **ECM RX** to **ON**.

■ [Advanced FAX settings](#)

Errors Often Occur When You Receive a Fax

A

Check1 Check the telephone line condition or the connection.

If the telephone line or connection is poor, reducing the reception start speed may correct the error.

Reduce the reception start speed on **RX start speed** in **Adv. communication settings** in **Advanced FAX settings** under **FAX settings**.

■ [Advanced FAX settings](#)

Check2 Is the sender's fax machine operating normally?

Contact the sender and ask the sender to check whether the fax machine is operating normally.



Cannot Send a Fax Clearly



Check1 Is the document loaded correctly?

Remove the document, then reload it on the platen glass or in the ADF.

■ [Loading Originals](#)

Check2 Is the platen glass and/or the inner side of the document cover and/or the glass of ADF dirty?

Clean the platen glass and/or the inner side of the document cover and/or the glass of ADF, then reload the document.

■ [Cleaning the Platen Glass and Document Cover](#)

▶▶▶ Note

- If the glass of ADF is dirty, black streaks appear on the paper as shown below.



Check3 Is the image quality setting or the scan contrast setting suitable for the document?

On the touch screen, select an image quality setting and a scan contrast setting that are suitable for the document.

■ [Setting Items for Sending Faxes](#)

Check4 Is the original document loaded with the wrong side facing upwards or downwards?

When loading a document on the platen glass, the side to be scanned should be face down.

When loading a document in the ADF, the side to be scanned should be face up.

Check5 Are you scanning thick or curled documents?

Thick or curled documents may not be sent as good quality faxes, because of a shadow or distortion caused when such documents are scanned.

When loading a document on the platen glass, press on the document cover with your hand when scanning.

Telephone Problems

■ [Cannot Dial](#)

■ [Telephone Disconnects During a Call](#)

Cannot Dial

A

Check1 Is the telephone line cable connected correctly?

Check that the telephone line cable is connected correctly.

■ [Basic Connection](#)

Check2 Is the telephone line type of the machine or the external device set correctly?

Check the telephone line type setting and change it as necessary.

■ [Setting the Telephone Line Type](#)

Telephone Disconnects During a Call

A

Check Is the telephone line cable or the telephone (or a peripheral device such as an external telephone, an answering machine, or a computer modem) connected correctly?

Check that the telephone line cable and the telephone (or a peripheral device such as an external telephone, an answering machine, or a computer modem) are connected correctly.

■ [Connecting the Telephone Line](#)

Problems with Scanning

- ▶ **Problems with Scanning**
- ▶ **Scan Results Not Satisfactory**

Problems with Scanning

- ▶ **Scanner Does Not Work**
- ▶ **Scanner Driver Does Not Start**
- ▶ **Error Message Appears and the Scanner Driver Screen Does Not Appear**
- ▶ **Cannot Scan Multiple Items at One Time**
- ▶ **Slow Scanning Speed**
- ▶ **"There is not enough memory." Message Is Displayed**
- ▶ **Computer Stops Operating during Scanning**
- ▶ **Scanned Image Does Not Open**



Scanner Does Not Work



Check 1 Make sure that your scanner or printer is turned on.

Check 2 Connect the USB cable to a different USB port on the computer.

Check 3 If the USB cable is connected to a USB hub, remove it from the USB hub and connect it to a USB port on the computer.

Check 4 Restart the computer.



Scanner Driver Does Not Start



Check 1 Make sure that the scanner driver is installed.

If not installed, install the scanner driver from the web page.

Check 2 Select your scanner or printer on the application's menu.

▶▶ Note

- The operation may differ depending on the application.

Check 3 Make sure that the application supports the ICA (Image Capture Architecture) driver.

You cannot start the scanner driver from applications not supporting the ICA driver.

Check 4 Scan and save images with IJ Scan Utility and open the files in your application.



Error Message Appears and the Scanner Driver Screen Does Not Appear



Check 1 Make sure that your scanner or printer is turned on.

Check 2 Turn off your scanner or printer, then reconnect the USB cable and replug the power cord.

Check 3 Connect the USB cable to a different USB port on the computer.

Check 4 If the USB cable is connected to a USB hub, remove it from the USB hub and connect it to a USB port on the computer.

Check 5 Make sure that the scanner driver is installed.

If not installed, install the scanner driver from the web page.

Check 6 Select your scanner or printer on the application's menu.

▶▶▶ Note

- The operation may differ depending on the application.

Check 7 Make sure that the application supports the ICA driver.

You cannot start the scanner driver from applications not supporting the ICA driver.

Check 8 Exit the scanner driver if it is running on another application.



Cannot Scan Multiple Items at One Time



Check 1 Make sure that the items are placed correctly.

■ [Placing Items \(When Scanning from a Computer\)](#)

Check 2 Check if you can properly scan one item.

Some applications do not support multiple image scanning. In that case, scan each item individually.



Slow Scanning Speed



Check 1 To view the image on a monitor, set the output resolution to around 150 dpi. To print, set it to around 300 dpi.

■ [Resolution](#)

Check 2 Set **Fading Correction**, **Grain Correction**, etc. to **None**.

Refer to "[Image Corrections and Color Adjustments](#)" for details.

Check 3 In IJ Scan Utility, deselect the **Correct slanted text document / Detect the orientation of text document and rotate image** checkbox and scan again.

■ [Settings \(Document Scan\) Dialog](#)

■ [Settings \(Custom Scan\) Dialog](#)



"There is not enough memory." Message Is Displayed



Check 1 Exit other applications and try again.

Check 2 Reduce the resolution or output size and scan again.

■ [Resolution](#)



Computer Stops Operating during Scanning



Check 1 Restart the computer, reduce the output resolution and scan again.

■ [Resolution](#)

Check 2 Delete unnecessary files to obtain sufficient free hard disk space, then scan again.

Error message may appear if there is not enough hard disk space to scan and save, when the image size is too large (such as when scanning a large item at high resolution).

Check 3 In **Folder to Save Temporary Files** of IJ Scan Utility, specify a folder on a drive with sufficient free space.

■ [Settings \(General Settings\) Dialog](#)

Check 4 Multiple devices may be connected to USB ports.

Disconnect devices other than your scanner or printer.



Scanned Image Does Not Open



Check If the data format is not supported by the application, scan the image again and select a popular data format such as JPEG when saving it.

Refer to the application's manual for details. If you have any questions, contact the manufacturer of the application.

Scan Results Not Satisfactory

- ▶ **Moire Appears in Scan Results**
- ▶ **Scan Quality (Image Displayed on the Monitor) Is Poor**
- ▶ **Scanned Image Is Surrounded by Extra White Areas**
- ▶ **Cannot Scan at the Correct Size**
- ▶ **Position or Size of the Image Cannot be Detected Correctly When Scanning from the Operation Panel**
- ▶ **Item Is Placed Correctly, but the Scanned Image Is Slanted**
- ▶ **Scanned Image Is Enlarged (Reduced) on the Computer Monitor**



Moire Appears in Scan Results



Check 1 Increase the scanning resolution.

■ [Resolution](#)

Check 2 Take the following measures and scan again.

- Set one of the following settings in the **Settings (Document Scan)** dialog, **Settings (Custom Scan)** dialog, **Settings (Scan and Stitch)** dialog, **Settings (OCR)** dialog or **Settings (E-mail)** dialog of IJ Scan Utility, then scan from the IJ Scan Utility main screen.
 - Set **Select Source** to **Magazine** and set **Color Mode** to **Color**
 - Select the **Reduce moire** checkbox in **Image Processing Settings**
 - [Settings \(Document Scan\) Dialog](#)
 - [Settings \(Custom Scan\) Dialog](#)
 - [Settings \(Scan and Stitch\) Dialog](#)
 - [Settings \(OCR\) Dialog](#)
 - [Settings \(E-mail\) Dialog](#)
- Click **Driver** in the IJ Scan Utility main screen, then set one of the following settings.
 - Select **Magazine** for **Image Adjustment**
 - Select the **Descreen** checkbox

Refer to "[Image Corrections and Color Adjustments](#)" for details.

▶▶▶ Note

- If moire appears when you scan a digital print photo, take the above measures and scan again.



Scan Quality (Image Displayed on the Monitor) Is Poor



Check 1 If the image is jagged, increase the scanning resolution, or select **TIFF** or **PNG** in **Data Format** of the Settings dialog.

- [Resolution](#)
- [Settings Dialog](#)

Check 2 Set the display size to 100 %.

Some applications do not display images clearly if the display size is too small.

Check 3 If moire (stripe pattern) appears, take the following measures and scan again.

- Set one of the following settings in the **Settings (Document Scan)** dialog, **Settings (Custom Scan)** dialog, or **Settings (Scan and Stitch)** dialog of IJ Scan Utility, then scan from the IJ Scan Utility main screen.
 - Set **Select Source** to **Magazine** and set **Color Mode** to **Color**
 - Select the **Reduce moire** checkbox in **Image Processing Settings**
- [Settings \(Document Scan\) Dialog](#)
- [Settings \(Custom Scan\) Dialog](#)
- [Settings \(Scan and Stitch\) Dialog](#)
- Click **Driver** in the IJ Scan Utility main screen, then set one of the following settings.
 - Select **Magazine** for **Image Adjustment**
 - Select the **Descreen** checkbox

Refer to "[Image Corrections and Color Adjustments](#)" for details.

▶▶▶ Note

- If moire appears when you scan a digital print photo, take the above measures and scan again.

Check 4 Clean the platen and document cover.

Check 5 If the item is in poor condition (dirty, faded, etc.), click **Driver** in the IJ Scan Utility main screen, then set **Reduce Dust**, **Fading Correction**, **Grain Correction**, etc.

Refer to "[Image Corrections and Color Adjustments](#)" for details.

Check 6 If the color tone of images is different from the original document, take the following measures and scan again.

Click **Driver** in the IJ Scan Utility main screen, then set **Image Adjustment** to **None**.

Refer to "[Image Corrections and Color Adjustments](#)" for details.



Scanned Image Is Surrounded by Extra White Areas



Check Specify the scan area.

Manually specify the scan area when there are white margins or unwanted areas along the edges of the scanned images in the **Image Stitch** window.

■ [Adjusting Cropping Frames in the Image Stitch Window](#)



Cannot Scan at the Correct Size



Check Make sure that the items are placed correctly.

■ [Placing Items \(When Scanning from a Computer\)](#)



Position or Size of the Image Cannot be Detected Correctly When Scanning from the Operation Panel



Check 1 Make sure that the items are placed correctly.

- [Placing Items \(When Scanning from a Computer\)](#)

Check 2 Check that the settings match the item to be scanned.

If you cannot scan properly by automatically detecting the item type, specify the item type and size.

When Scanning from the Operation Panel:

Refer to "Setting Items for Scanning Using the Operation Panel of the Machine" for your model from Home of the *Online Manual* for details on the setting items when scanning from the operation panel.

When Scanning with IJ Scan Utility:

- [Scanning Documents](#)
- [Scanning Photos](#)
- [Scanning with Favorite Settings](#)



Item Is Placed Correctly, but the Scanned Image Is Slanted



Check When Document or **Magazine** is selected for **Select Source**, deselect the **Correct slanted text document** checkbox and scan the item again.

- [Settings \(Document Scan\) Dialog](#)
- [Settings \(Custom Scan\) Dialog](#)



Scanned Image Is Enlarged (Reduced) on the Computer Monitor



Check 1 Change the display setting in the application.

Refer to the application's manual for details. If you have any questions, contact the manufacturer of the application.

Check 2 Click **Driver** in the IJ Scan Utility main screen, then change the resolution setting and scan again.

The higher the resolution, the larger the resulting image will be.

■ [Resolution](#)

Problems with the Machine

- **The Machine Cannot Be Powered On**
- **Cannot Connect to Computer with a USB Cable Properly**
- **Cannot Communicate with the Machine with USB Connection**
- **The Display on the Touch Screen Cannot Be Seen At All**
- **An Unintended Language Is Displayed on the Touch Screen**
- **Print Head Holder Does Not Move to the Position for Replacing**



The Machine Cannot Be Powered On



Check1 Press the **ON** button.

Check2 Make sure that the power plug is securely plugged into the power cord connector of the machine, then turn it back on.

Check3 Unplug the machine from the power supply, then plug the machine back in and turn the machine back on after leaving it for at least 2 minutes.

If the problem is not resolved, contact the service center.

Cannot Connect to Computer with a USB Cable Properly

Q Printing or Scanning Speed Is Slow/Hi-Speed USB Connection Does Not Work

A

If your system environment is not fully compatible with Hi-Speed USB, the machine will operate at a lower speed provided under USB 1.1. In this case, the machine operates properly but printing or scanning speed may slow down due to communication speed.

Check Check the following to make sure that your system environment supports Hi-Speed USB connection.

- Does the USB port on your computer support Hi-Speed USB connection?
- Does the USB cable or the USB hub support Hi-Speed USB connection?

Be sure to use a certified Hi-Speed USB cable. We recommend that the cable is no longer than around 10 feet / 3 meters.

- Does the operating system of your computer support Hi-Speed USB connection?

Obtain and install the latest update for your computer.

- Does the Hi-Speed USB driver operate properly?

Obtain the latest version of the Hi-Speed USB driver compatible with your hardware and reinstall it on your computer.

»» Important

- For details on Hi-Speed USB of your system environment, contact the manufacturer of your computer, USB cable, or USB hub.



Cannot Communicate with the Machine with USB Connection



Check1 Make sure that the machine is turned on.

Check2 Make sure that the USB cable is connected properly.

See [Connecting the Machine to the Computer Using a USB Cable](#) to connect the USB cable properly.

Check3 Do not start up IJ Network Tool while printing.

Check4 Do not print while IJ Network Tool is running.



The Display on the Touch Screen Cannot Be Seen At All



- **If the POWER lamp is off:**

The machine is not powered on. Connect the power cord and press the **ON** button.

- **If the POWER lamp is lit:**

The touch screen may be in the screen-saver mode. Tap the touch screen.



An Unintended Language Is Displayed on the Touch Screen



Select the language you want to be displayed according to the following procedure.

1. Press the **HOME** button and wait for about 5 seconds.

2. Flick the HOME screen, then tap  **Setup**.

■ [Using the Operation Panel](#)

3. Tap  **Device settings**.

4. Tap the fifth setting item from the top.

5. Tap the language for the touch screen.



Print Head Holder Does Not Move to the Position for Replacing



»» Important

- The print head holder moves to the position for replacing only when an ink tank runs out of ink. If no ink tanks run out of ink, the print head holder does not move even though you open the front cover.

Check1 Is the **POWER** lamp off?

Check if the **POWER** lamp is lit.

The print head holder will not move unless the power is on. If the **POWER** lamp is off, close the front cover and turn the machine on.

While the **POWER** lamp is flashing, the machine is initializing. Wait until the **POWER** lamp stops flashing and remains lit, and then open the front cover again.

Check2 Is an error message displayed on the touch screen?

Close the front cover, follow the Support Code (error number) displayed in the error message to resolve the error, and then reopen it. For details on how to resolve the error, refer to [Support Code List](#).

Check3 Has the front cover been left open for 60 minutes or longer?

If the front cover is left open for more than 60 minutes, the print head holder moves to the position to protect it to prevent the print head from drying out. Close and reopen the front cover to return the print head holder to the position for replacing.

Problems with Installation/Downloading

- **Cannot Install the MP Drivers**
- **Uninstalling IJ Network Tool**



Cannot Install the MP Drivers



Download the driver from the support page of our website, then reinstall it.



Uninstalling IJ Network Tool



Follow the procedure below to uninstall IJ Network Tool from your computer.

▶▶ Important

- Even if IJ Network Tool is uninstalled, you can print over network or scan from the computer. However, you cannot change the network settings over network.

1. Select **Applications** from the **Go** menu of Finder, double-click **Canon Utilities > IJ Network Tool**, drag the **Canon IJ Network Tool** icon into the **Trash**.

2. Restart the computer.

Empty the **Trash** and restart your computer.

▶▶ Note

- To reinstall IJ Network Tool, uninstall IJ Network Tool, then install it again from our website.

About Errors/Messages Displayed

- ▶ **If an Error Occurs**
- ▶ **A Message for Faxing Is Displayed on the Fax Standby Screen**
- ▶ **A Message Is Displayed**

If an Error Occurs

When an error occurs in printing such as the machine is out of paper or paper is jammed, a troubleshooting message is displayed automatically. Take the appropriate action described in the message.

When an error occurs, a Support Code (error number) is displayed on the computer screen or the touch screen.

- **When a Support Code and a message are displayed on the computer screen:**

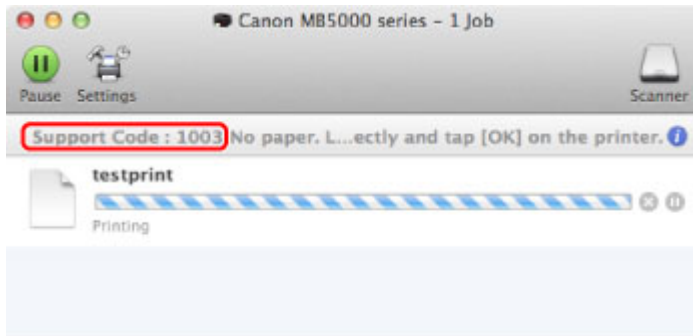

* The screen differs depending on the OS you are using.

- **When a Support Code and a message are displayed on the touch screen:**

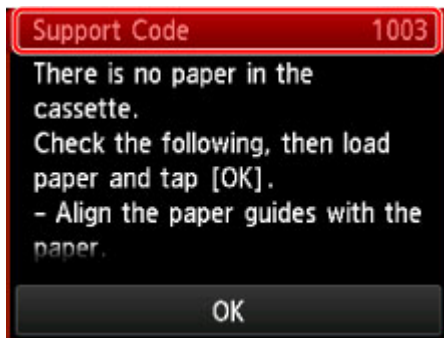

For details on how to resolve errors with Support Codes, refer to [Support Code List](#).

▶▶▶ Note

- You can confirm the actions against errors with Support Codes on your computer or on the touch screen by searching a Support Code.

■ [Click Here to Search](#)

For details on how to resolve errors without Support Codes, see [A Message Is Displayed](#).



A Message for Faxing Is Displayed on the Fax Standby Screen



If a message is displayed on the Fax standby screen, take the corresponding action described below.

Message	Action
Auto redial	<p>The machine is waiting to redial the recipient's number because the line was busy or the recipient did not answer when you tried to send a document. Wait for the machine to automatically redial the number. If you want to cancel automatic redialing, wait until the machine starts dialing the number, then press the Stop button. You can also delete the document from machine's memory to cancel automatic redialing.</p> <p>■ Resending Faxes (Redialing a Busy Number)</p>
This group dial cannot be used. Directory ##	<p>* "##" represents a two-digit number.</p> <p>The group dial cannot be specified in the on hook dial function.</p> <p>Specify the individual recipient.</p>
Replace the receiver.	<p>The handset is not placed in the handset cradle correctly.</p> <p>Replace the handset correctly.</p>
Try again in black & white.	<p>The recipient's fax machine is not color-compatible.</p> <p>Press the Black button to resend the fax.</p> <p>Alternatively, you select Send in black & white for Color transmission in Advanced FAX settings under FAX settings. The machine converts color documents into black & white data if the recipient's fax machine does not support color faxing.</p> <p>■ Advanced FAX settings</p>
Failed to connect.	<p>The telephone line cable with a modular plug may not be plugged in properly.</p> <p>Make sure that the cable is plugged in properly, and resend the fax after a while. If you still cannot send the fax, select OFF for Dial tone detect in Advanced FAX settings under FAX settings.</p> <p>■ Advanced FAX settings</p>
Received in memory.	<p>If the machine receives a fax under one of the following conditions, the machine will not be able to print the received fax and will store it in the machine's memory. When the problem is resolved as described, the fax stored in the machine's memory is printed automatically.</p> <ul style="list-style-type: none"> The amount of remaining ink is insufficient to print a fax: Replace the ink tank. ■ Replacing an Ink Tank <p>▶▶▶ Note</p> <ul style="list-style-type: none"> You can set the machine to forcibly print a received fax even if the ink has run out. Set Print when out of ink in Auto print settings under FAX settings to Print. However, part or all of the fax may not be printed since the ink has run out. Also, the contents of the fax will not be stored in the machine's memory.

If the ink has already run out, we recommend that **Do not print** be selected for **Received documents** in **Auto print settings** under **FAX settings** to store the received fax in the machine's memory. After you replace the ink tank and select **Print** for **Received documents** in **Auto print settings**, the fax stored in the machine's memory will be printed automatically.

[■ Auto print settings](#)

- Paper has run out:
Load the paper and tap **OK** on the touch screen.
- A different size of paper from that specified by **Page size** in **FAX paper settings** is loaded:
Load the same size of paper as that specified by **Page size**, then tap **OK** on the touch screen.
- You pressed the **Stop** button to cancel printing of a fax:
Press the **HOME** button and tap **FAX** to resume printing of the fax.
- **Do not print** is selected for **Received documents** in **Auto print settings** under **FAX settings**:
You can print the faxes stored in the machine's memory from the **Memory reference** screen in the Fax menu.

[■ Printing a Document in Machine's Memory](#)

▶▶ Note

- To print the received faxes automatically, select **Print** for **Received documents** in **Auto print settings** under **FAX settings**.

[■ Auto print settings](#)

- If you did not print the fax stored in the machine's memory (e.g., if you did not resolve the problem by pressing the **Stop** button), you can delete or print the fax stored in the machine's memory later.

[■ Document Stored in Machine's Memory](#)

Busy/no signal

- The recipient's number you dialed is busy.
Try dialing again after waiting for a moment.
[■ Resending Faxes \(Redialing a Busy Number\)](#)
- The fax/telephone number dialed is incorrect.
Check the fax/telephone number and dial again.
- The recipient's fax machine did not respond (after all automatic redialing attempts).
Contact the recipient and have the recipient check the fax machine. For an overseas call, add pauses to the registered number.
- The recipient is not using a G3 machine.
The machine cannot send or receive documents to/from a fax machine that is incompatible with the G3 standard. Contact the recipient and ask the recipient to check whether the fax machine is G3 compatible.
- The touch tone/rotary pulse setting on the machine is incorrect.
Set the machine to match the telephone line you are using.

[■ Setting the Telephone Line Type](#)

Memory is full.

The machine's memory is full because it has sent/received too many documents, or a detailed document.
Print the faxes stored in the machine's memory or save them on the USB flash drive, and delete them from the machine's memory.

	<p>■ Document Stored in Machine's Memory</p> <p>When sending a fax, resend it. If this message still appears, delete the faxes stored in the machine's memory, divide the faxes for sending, and send them again.</p> <p>When receiving a fax, have the sender resend the faxes.</p>
<p>Awaiting document processing.</p>	<ul style="list-style-type: none"> • The received faxes were not saved on the USB flash drive automatically because the USB flash drive was not inserted or because it was not writable. <p>The received faxes are stored in the machine's memory. Insert the writable USB flash drive, then save the received faxes to the USB flash drive manually.</p> <p>■ Saving a Document in Machine's Memory to USB Flash Drive</p> <ul style="list-style-type: none"> • The received faxes were not forward to the shared folder on the computer because the machine is not connected with the computer or because the shared folder setting is changed. <p>The received faxes are stored in the machine's memory. Connect the machine with the computer, then forward the received faxes to the shared folder on the computer manually.</p> <p>■ Forwarding a Document in Machine's Memory to Shared Folder on the Computer</p> <p>Delete the unnecessary fax from machine's memory after saving to the USB flash drive, forwarding to the shared folder on the computer, or printing.</p> <p>■ Deleting a Document in Machine's Memory</p>
<p>FAX info does not match.</p>	<p>Transmission has been canceled because the machine could not detect the recipient's fax machine information or the information did not match the dialed number. This message is displayed when Check RX FAX information in Security control under FAX settings is set to ON.</p> <p>For details, see Sending Faxes after Checking Information (Checking the Recipient's Information).</p>
<p>Reception rejected.</p>	<p>Reception has been rejected because the fax matches the fax rejection condition specified by FAX reception reject in Security control under FAX settings.</p> <p>For details, see Rejecting Fax Reception.</p>
<p>Waiting for report output...</p>	<p>If the machine receives a fax under one of the following conditions, the machine will not be able to print the reports. When the problem is resolved as described, the reports are printed automatically.</p> <ul style="list-style-type: none"> • The amount of remaining ink is insufficient to print a report: <ul style="list-style-type: none"> Replace the ink tank. ■ Replacing an Ink Tank • Paper has run out: <ul style="list-style-type: none"> Load the paper and tap OK on the touch screen. • A different size of paper from that specified by Page size in FAX paper settings is loaded: <ul style="list-style-type: none"> Load the same size of paper as that specified by Page size, then tap OK on the touch screen. • You pressed the Stop button to cancel printing of a report: <ul style="list-style-type: none"> Press the HOME button and tap FAX to resume printing of the report.

A Message Is Displayed

This section describes some of the errors or messages.

►► Note

- A Support Code (error number) is displayed on the computer or on the touch screen for some error or message. For details on errors with Support Codes, refer to [Support Code List](#).

If a message is displayed on the touch screen, see below.

- [A Message Is Displayed on the touch screen](#)

If a message is displayed on the computer, see below.

- [Error Regarding Automatic Duplex Printing Is Displayed](#)
- [The Inkjet Printer/Scanner/Fax Extended Survey Program Icon Appears](#)



A Message Is Displayed on the touch screen



Confirm the message and take an appropriate action.

- **Data of supported types are not saved.**
 - There is no image data or document saved on the USB flash drive that can be read by this machine.
 - The machine may not recognize the file if the file name or folder path contain certain characters. Use only alphanumeric characters.
 - Photo data edited or processed on a computer must be printed from the computer.

►► Note

- When a photo which has been processed on a computer is selected, "?" is displayed on the touch screen.

- **Cannot print the specified PDF file. An error has occurred while scanning the file, or the format is not supported, or the file is too large.**

- Make sure the PDF file is printable from a USB flash drive. See [Printing Documents \(PDF File\) Saved on a USB Flash Drive](#) for more information.

►► Note

- The names of the PDF files are displayed even though they cannot be printed from the USB flash drive. It is recommended you confirm whether they are printable. If one of the following conditions applies to the PDF files, they are not printable.
 - The **Details** screen is not displayed for the PDF file you want to print.
 - Characters other than machine name or **IJ Scan Utility** are displayed on **Created with** on the **Details** screen.
 - "?" is displayed on the preview screen.

- Data edited or processed on a computer must be printed from the computer.

- **The specified PDF file contains unprintable data. Some portions may not be printed.**

PDF file which contain lot of graphics or hi-resolution images may lose that data or stop before printing is completed. In this case, print from the computer.

- **Check the page size and tap [OK].**

The size of the loaded paper is different from that specified in the paper size setting.

Load the same size of paper as that specified in the paper size setting, then tap **OK**.

- **Power was not turned off correctly the last time. Press the  button when turning power off.**

The power cord may have been unplugged last while the machine was still on.

Tap **OK** on the touch screen to dismiss the error.

▶▶▶ Note

- See [Notice for Unplugging the Power Cord](#) for unplugging the power cord.

- **The power cord has been unplugged and unsent/received docs in memory have been lost.**

A power failure has occurred or the power cord has been unplugged when the faxes are stored in the machine's memory.

▶▶▶ Important

- If a power failure occurs or you unplug the power cord, all faxes stored in the machine's memory are deleted.
- For details on how to unplug the power cord, see [Notice for Unplugging the Power Cord](#).

Tap **OK** on the touch screen.

After tapping **OK**, the list of the faxes deleted from the machine's memory (MEMORY CLEAR REPORT) will be printed.

For details, refer to [Summary of Reports and Lists](#).

- **Cannot connect to the server. Please wait a while and try again.**

You cannot connect to the server due to some communication error. When you have tried to access a photo sharing site, it is possible that your photos have been deleted.

Tap **OK** on the touch screen to dismiss the error, then try again after a while.

Error Regarding Automatic Duplex Printing Is Displayed

Check See [Cannot Print Properly with Automatic Duplex Printing](#) and take the appropriate action.

The Inkjet Printer/Scanner/Fax Extended Survey Program Icon Appears

If the Inkjet Printer/Scanner/Fax Extended Survey Program is installed, the printer and application software usage information is scheduled to be sent every month for about ten years. The **Inkjet Printer/Scanner/Fax Extended Survey Program** icon appears in the Dock when it is time to send the printer usage information.

Read the instructions on the screen after clicking the icon, then follow the procedure below.

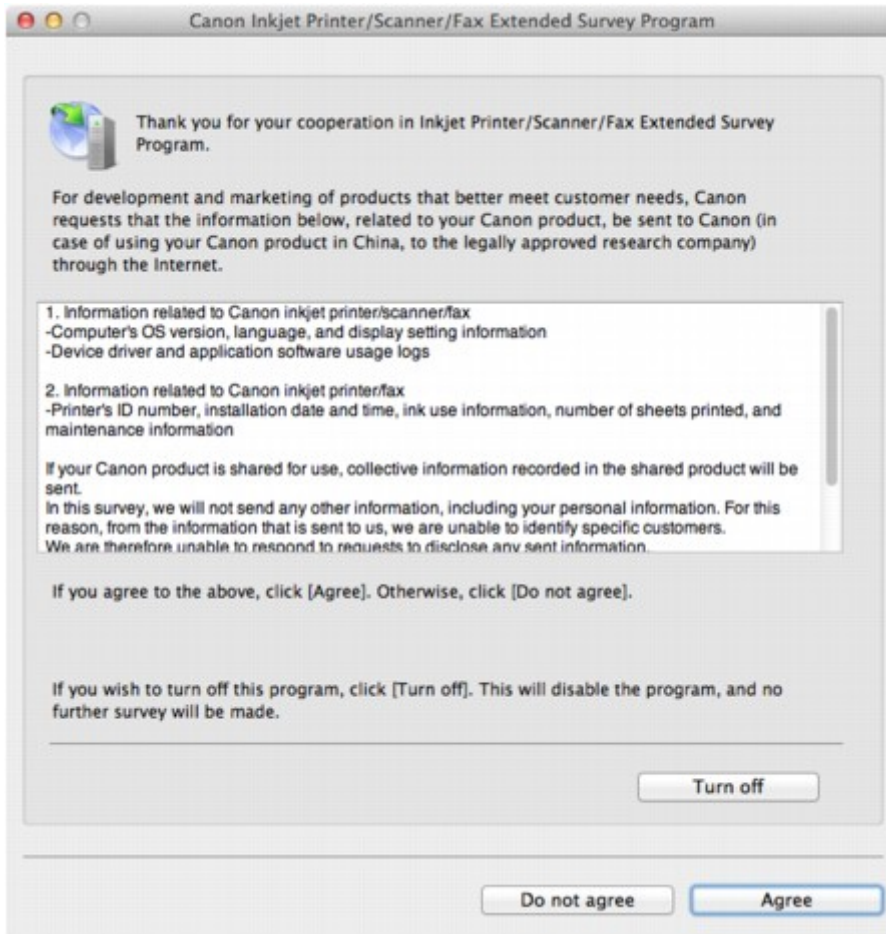

- **If you agree to participate in the survey program:**

Click **Agree**, then follow the on-screen instructions. The printer usage information will be sent via the Internet. If you have followed the on-screen instructions, the information will be sent automatically from the second time onward and the confirmation screen will not be displayed again.

Note

- If you deselect the **Send automatically from the next time** check box, the information will not be sent automatically from the second time onward and the **Inkjet Printer/Scanner/Fax Extended Survey Program** icon will appear in the Dock at the time of the next survey.

- **If you do not agree to participate in the survey program:**

Click **Do not agree**. The confirmation screen will be closed, and the survey at that time is skipped. The confirmation screen will be displayed again one month later.

- **To stop sending the information:**

Click **Turn off**. The Inkjet Printer/Scanner/Fax Extended Survey Program is stopped, and the information will not be sent. To resume the survey, see [Changing the setting:](#).

- **To uninstall the Inkjet Printer/Scanner/Fax Extended Survey Program:**

1. Stop the Inkjet Printer/Scanner/Fax Extended Survey Program.

- **Changing the setting:**

2. Select **Applications** from the **Go** menu of Finder, and double-click the **Canon Utilities** folder, then the **Inkjet Extended Survey Program** folder.

3. Place the **Canon Inkjet Printer/Scanner/Fax Extended Survey Program.app** file into the **Trash**.

4. Restart the computer.

Empty the **Trash** and restart your computer.

- **Changing the setting:**

To display the confirmation screen every time the printer usage information is sent or to resume surveying, follow the procedure below.

1. Select **Applications** from the **Go** menu of Finder, and double-click the **Canon Utilities** folder, then the **Inkjet Extended Survey Program** folder.

2. Double-click the **Canon Inkjet Printer/Scanner/Fax Extended Survey Program** icon.

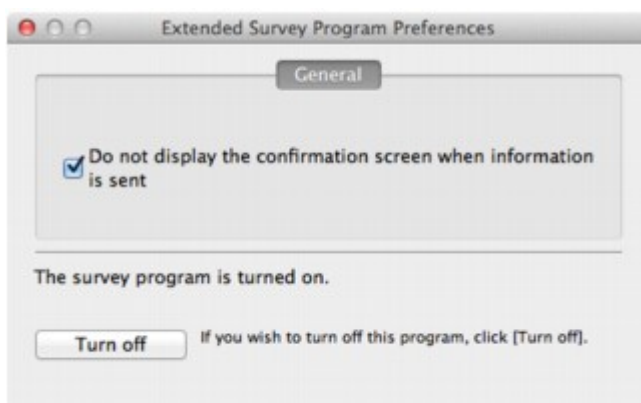

- **Do not display the confirmation screen when information is sent:**

If the check box is selected, the information will be sent automatically.

If the check box is not selected, the **Inkjet Printer/Scanner/Fax Extended Survey Program** icon will appear in the Dock at the time of the next survey. Click the icon, then follow the on-screen instructions.

- **Turn off/Turn on** button:

Click the **Turn off** button to stop the Inkjet Printer/Scanner/Fax Extended Survey Program.

Click the **Turn on** button to restart the Inkjet Printer/Scanner/Fax Extended Survey Program.

If You Cannot Resolve the Problem

If you cannot resolve the problem with any of the workarounds in this chapter, please contact the seller of the machine or the service center.

Canon support staff are trained to be able to provide technical support to satisfy customers.

Caution

- If the machine emits any unusual sound, smoke, or odor, turn it off immediately. Unplug the power cord from the outlet and contact the seller or the service center. Never attempt to repair or disassemble the machine yourself.
- Attempts by customers to repair or take apart the machine will invalidate any warranty regardless of whether the warranty has expired.

Before contacting the service center, confirm the following:

- Product name:
 - * Your machine's name is located on the front cover of the setup manual.
- Serial number: please refer to the setup manual
- Details of the problem
- What you tried to solve the problem, and what happened

Support Code List

The support code appears on the touch screen and the computer screen when an error occurs.

"Support Code" means the error number and appears with an error message.

When an error occurs, check the support code displayed on the touch screen or the computer screen and take the appropriate action.

Support Code Appears on the Touch Screen and the Computer Screen

- **1000 to 1ZZZ**

[1003](#) [1200](#) [1300](#) [1303](#) [1310](#) [1313](#)

[1314](#) [1575](#) [1600](#) [1660](#) [1688](#) [1700](#)

[1701](#) [1754](#) [1755](#) [1871](#) [1890](#)

- **2000 to 2ZZZ**

[2001](#) [2002](#) [2110](#) [2120](#) [2500](#) [2700](#)

[2801](#) [2802](#) [2803](#)

- **4000 to 4ZZZ**

[4100](#) [4103](#)

- **5000 to 5ZZZ**

[5011](#) [5012](#) [5040](#) [5100](#) [5102](#) [5103](#)

[5104](#) [5105](#) [5200](#) [5203](#) [5204](#) [5205](#)

[5206](#) [5207](#) [5208](#) [5209](#) [5400](#) [5500](#)

[5501](#) [5B00](#) [5B01](#) [5C01](#)

- **6000 to 6ZZZ**

[6000](#) [6500](#) [6502](#) [6700](#) [6800](#) [6801](#)

[6900](#) [6901](#) [6902](#) [6910](#) [6911](#) [6920](#)

[6921](#) [6930](#) [6931](#) [6932](#) [6933](#) [6936](#)

[6937](#) [6938](#) [6939](#) [693A](#) [6940](#) [6941](#)

[6942](#) [6943](#) [6944](#) [6945](#) [6946](#)

- **7000 to ZZZZ**

[7100](#) [7200](#) [7201](#) [7202](#) [7203](#) [7204](#)

[7205](#) [7300](#)

- **9000 to ZZZZ**

[9000](#) [9500](#)

- **A000 to ZZZZ**

[B202](#) [B203](#) [B204](#) [B502](#) [B503](#) [B504](#)

[C000](#)

About the support code for paper jam, you can also refer to [Support Code List \(When Paper Is Jammed\)](#).

Support Code List (When Paper Is Jammed)

If the paper is jammed, remove it following the procedure appropriate for each case.

- If the paper is jammed inside the front cover:

■ [1300](#)

- If the paper is jammed inside the rear cover:

■ [1303](#)

- If the paper is jammed inside the rear cover as the machine pulled in the printed paper:

■ [1313](#)

- If the paper is jammed inside the rear cover when automatic duplex printing:

■ [1314](#)

- If the document is jammed in the ADF:

■ [2801](#)

- Cases other than above:

■ [In Other Cases](#)

1300

Cause

Paper is jammed inside the front cover.

Action

If the paper is jammed inside the front cover, remove the paper following the procedure below.

▶▶▶ Important

- The power cannot be turned off while the machine is sending or receiving a fax, or when the received fax or the unsend fax are stored in the machine's memory.

Make sure that the machine has completed sending or receiving all the faxes before unplugging the power cord.

If you unplug the power cord, all the faxes stored in the machine's memory are deleted.

▶▶▶ Note

- If you need to turn off the machine to remove jammed paper during printing, press the **Stop** button to cancel print jobs before turning off the machine.

1. Open the front cover.

▶▶▶ Important

- Do not touch the clear film (A) or the white belt (B).

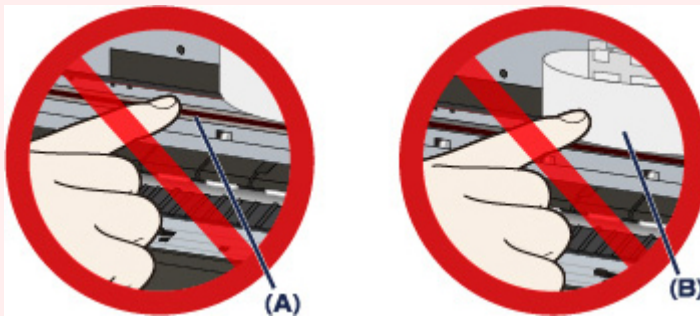

If the paper or your hands touch these parts and blot or scratch them, the machine can be damaged.

2. Make sure that the jammed paper is not under the print head holder.

If the jammed paper is under the print head holder, move the print head holder to the right edge or the left edge whichever is easier to remove the paper.

When you move the print head holder, press either the right side or the left side of the print head holder with your fingertips and slide the print head holder slowly to the right edge or the left edge.

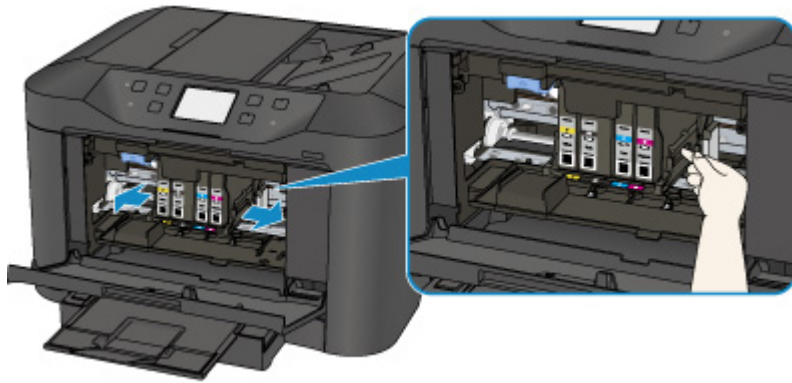

3. Hold the jammed paper with your hands.

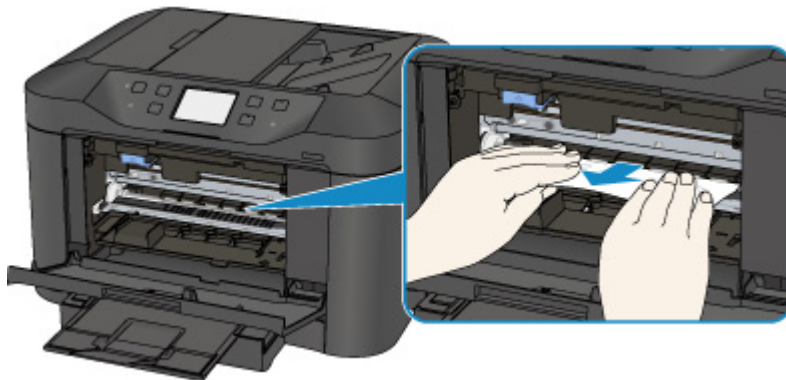

If the paper is rolled up, pull it out.

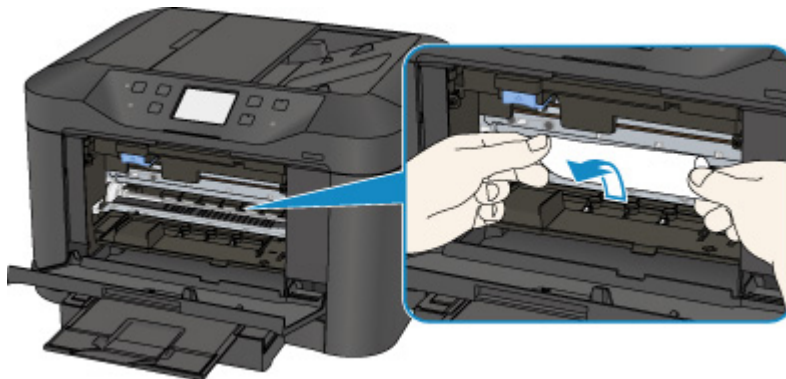

4. Pull the paper slowly not to tear it, then pull the paper out.

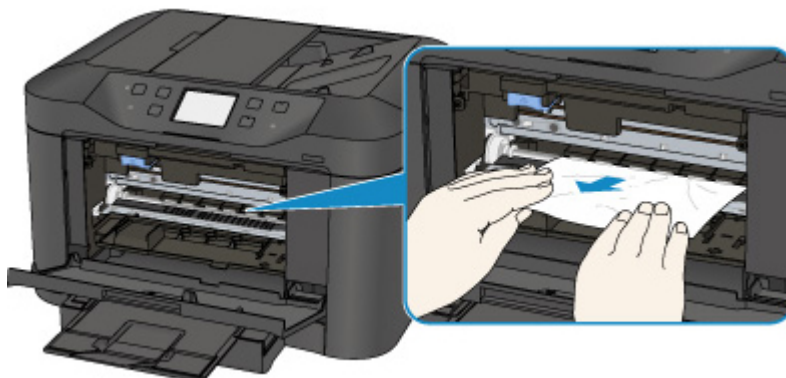

5. Make sure that all the jammed paper is removed.

If the paper is torn, a piece of paper may remain inside the machine. Check the following and remove the piece of paper if it remains.

- Does the piece of paper remain under the print head holder?
- Does the little piece of paper remain inside the machine?
- Does the piece of paper remain in the right side or the left side space (C) inside the machine?

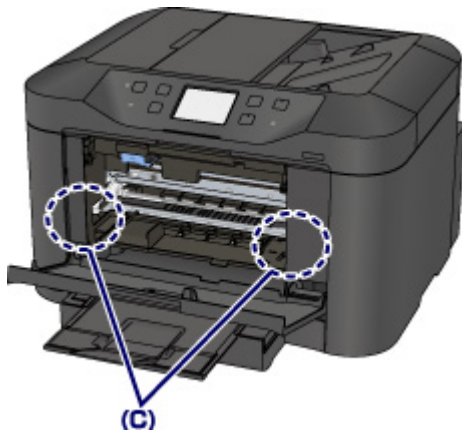

6. Close the front cover.

7. Reload the paper, and tap **OK** on the touch screen of the machine.

- If the paper is jammed while printing the faxes or the fax report in progress:
After clearing the paper jam error and tapping **OK** on the touch screen of the machine, the machine resumes printing from the page where the paper was jammed.
- If the paper is jammed while printing from a computer or copying in progress:
After clearing the paper jam error and tapping **OK** on the touch screen of the machine, then the machine resumes printing from the next page where the paper was jammed.
As the page where the paper was jammed is not printed, reprint if necessary.
When the paper is jammed while duplex printing or duplex copying is in progress, it is possible that the printing or copying order is not as you expect if you resume printing after clearing the paper jam error. In this case, cancel printing and reprint from the beginning.
When the paper is jammed while layout printing, 2 on 1 copying, or 4 on 1 copying is in progress, it is possible that some pages are not printed if you resume printing after clearing the paper jam error. In this case, cancel printing and reprint from the beginning.
- If you turned off the machine while taking the appropriate action of the paper jam error:
All print jobs in the queue are canceled. Reprint if necessary.

▶▶▶ Note

- When reloading the paper, confirm that you are using the paper suited for printing and are loading it correctly.
Align the paper guides with the both edges of the paper when you load paper.
- If the message about paper jam is displayed on the touch screen of the machine or on the computer screen when you resume printing after removing all the jammed paper, a piece of paper may remain inside the machine. In this case, confirm that no piece of paper remains inside the machine.

- We recommend you use paper other than A5 sized one to print documents with photos or graphics; otherwise, the printout may curl and cause paper exit jams.

If you cannot remove the paper or the paper tears inside the machine, or if the paper jam error continues after removing the paper, contact the service center.

1303

Cause

Paper is jammed inside the rear cover.

Action

If the paper is jammed inside the rear cover, remove the paper following the procedure below.

►► Important

- The power cannot be turned off while the machine is sending or receiving a fax, or when the received fax or the unsent fax are stored in the machine's memory.

Make sure that the machine has completed sending or receiving all the faxes before unplugging the power cord.

If you unplug the power cord, all the faxes stored in the machine's memory are deleted.

►► Note

- If you need to turn off the machine to remove jammed paper during printing, press the **Stop** button to cancel print jobs before turning off the machine.

1. Rotate the machine so that the rear side of the machine faces toward you.

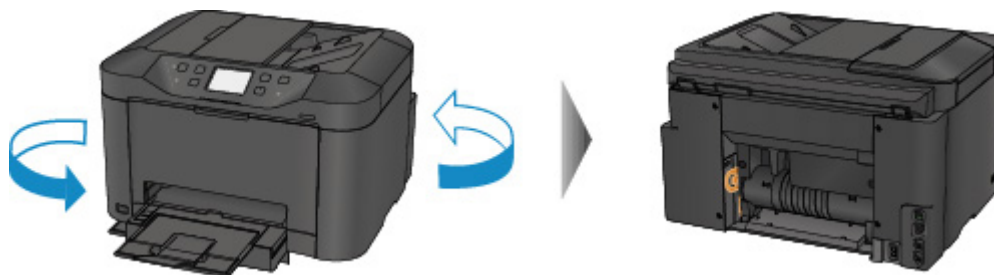

2. If the protective material for the rear cover remains attached, remove it.

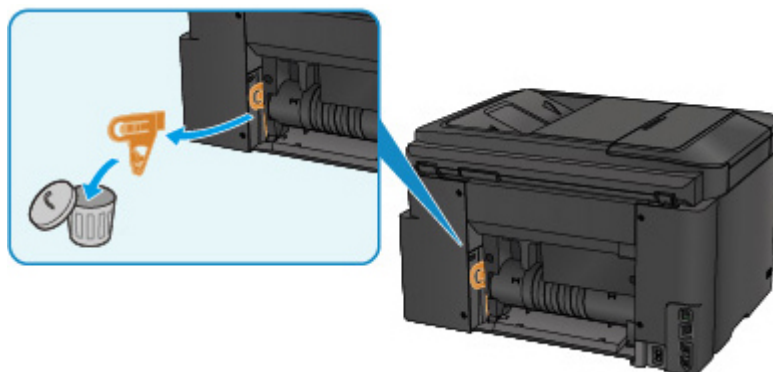

3. Open the rear cover.

Slide the rear cover to the left then open it.

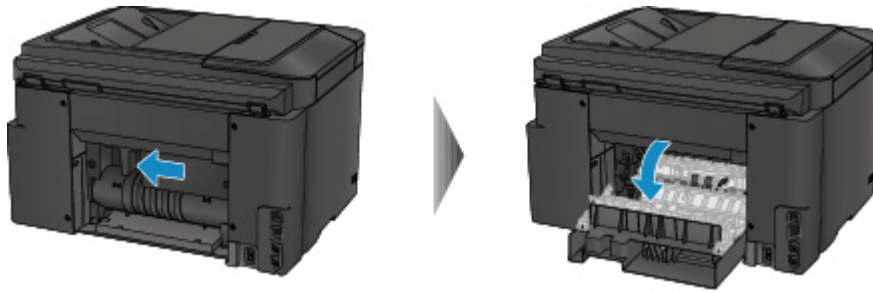

4. Pull out the paper slowly.

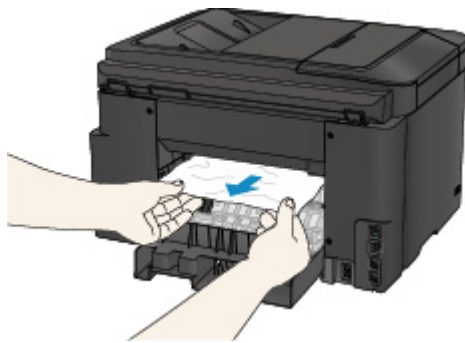

»» Note

- Do not touch the inner parts of the machine.
- If you cannot pull the paper out, try the following.
 - Turn the machine off and turn it back on.
The paper may be ejected automatically.
 - Pull out the paper output tray.
It becomes easy to pull out the paper.

5. Close the rear cover slowly.

Close the rear cover then slide it to the right.

Slide the rear cover so that the Δ mark on the rear cover aligns with the ∇ mark on the machine.

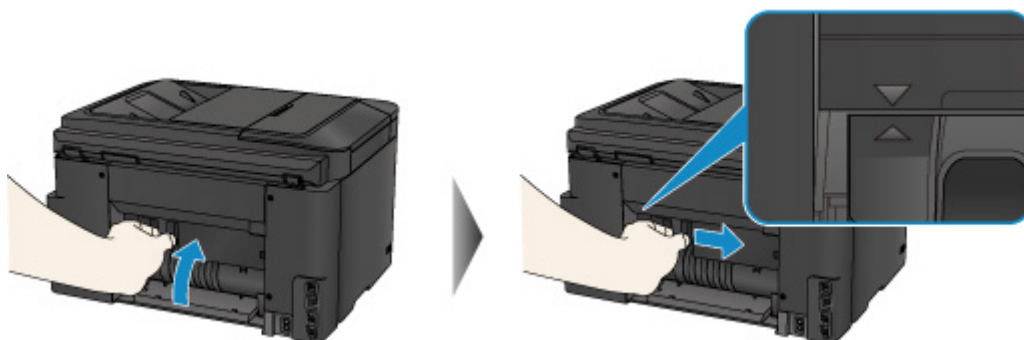

6. Reload the paper, and tap **OK** on the touch screen of the machine.

- If the paper is jammed while printing the faxes or the fax report in progress:
After clearing the paper jam error and tapping **OK** on the touch screen of the machine, the machine resumes printing from the page where the paper was jammed.
- If the paper is jammed while printing from a computer or copying in progress:

After clearing the paper jam error and tapping **OK** on the touch screen of the machine, then the machine resumes printing from the next page where the paper was jammed.

As the page where the paper was jammed is not printed, reprint if necessary.

When the paper is jammed while duplex printing or duplex copying is in progress, it is possible that the printing or copying order is not as you expect if you resume printing after clearing the paper jam error. In this case, cancel printing and reprint from the beginning.

When the paper is jammed while layout printing, 2 on 1 copying, or 4 on 1 copying is in progress, it is possible that some pages are not printed if you resume printing after clearing the paper jam error. In this case, cancel printing and reprint from the beginning.

- If you turned off the machine while taking the appropriate action of the paper jam error:

All print jobs in the queue are canceled. Reprint if necessary.

Note

- When reloading the paper, confirm that you are using the paper suited for printing and are loading it correctly.

Align the paper guides with the both edges of the paper when you load paper.

- We recommend you use paper other than A5 sized one to print documents with photos or graphics; otherwise, the printout may curl and cause paper exit jams.

If you cannot remove the paper or the paper tears inside the machine, or if the paper jam error continues after removing the paper, contact the service center.

1313

Cause

The paper is jammed inside the rear cover as the machine pulled in the printed paper.

Action

If the paper is jammed inside the rear cover as the machine pulled in the printed paper, remove the paper following the procedure below.

►► Important

- If the printed paper piles up on the paper output slot, the machine may pull it in and the paper is jammed inside the machine. Remove the printed paper from the paper output tray before it amounts to 75 sheets.
- The power cannot be turned off while the machine is sending or receiving a fax, or when the received fax or the unsent fax are stored in the machine's memory.

Make sure that the machine has completed sending or receiving all the faxes before unplugging the power cord.

If you unplug the power cord, all the faxes stored in the machine's memory are deleted.

►► Note

- If you need to turn off the machine to remove jammed paper during printing, press the **Stop** button to cancel print jobs before turning off the machine.

1. Rotate the machine so that the rear side of the machine faces toward you.

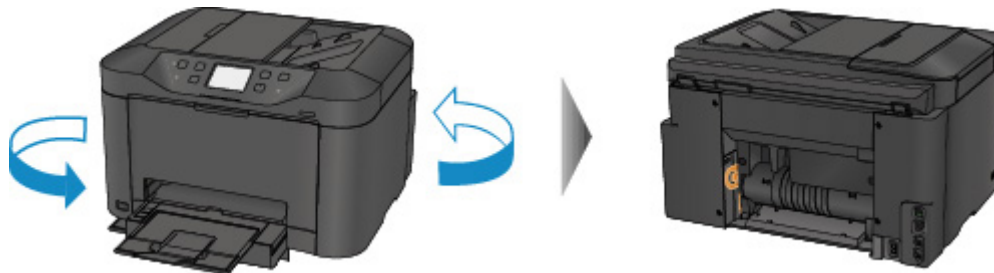

2. If the protective material for the rear cover remains attached, remove it.

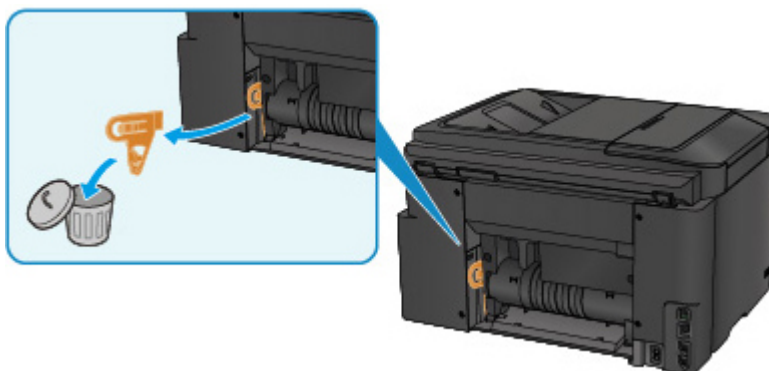

3. Open the rear cover.

Slide the rear cover to the left then open it.

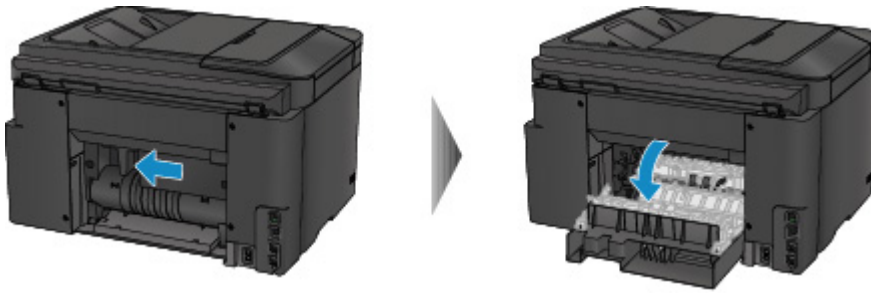

4. Pull out the paper slowly.

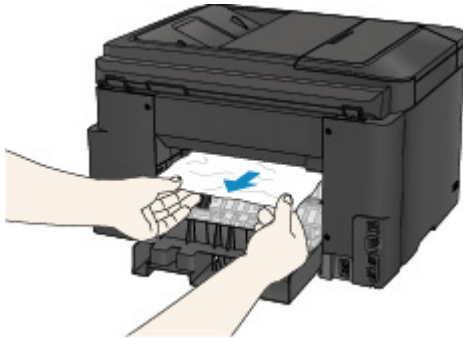

▶▶▶ Note

- Do not touch the inner parts of the machine.
- If you cannot pull the paper out, try the following.
 - Turn the machine off and turn it back on.
The paper may be ejected automatically.
 - Pull out the paper output tray.
It becomes easy to pull out the paper.

5. Close the rear cover slowly.

Close the rear cover then slide it to the right.

Slide the rear cover so that the \triangle mark on the rear cover aligns with the ∇ mark on the machine.

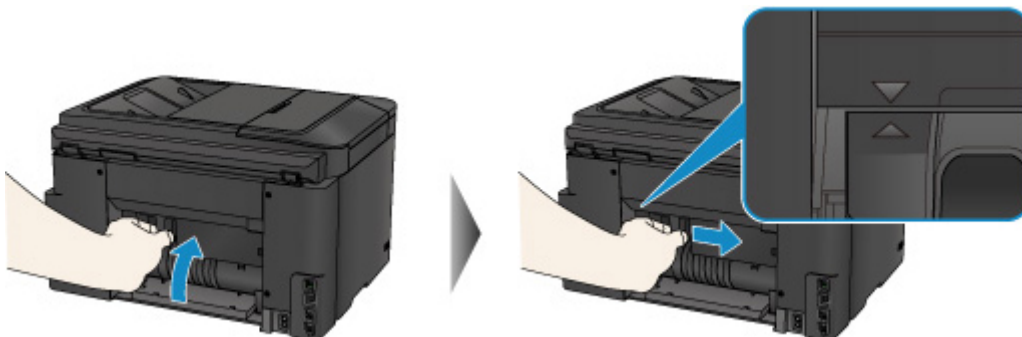

6. Reload the paper, and tap **OK** on the touch screen of the machine.

- If the paper is jammed while printing the faxes or the fax report in progress:
After clearing the paper jam error and tapping **OK** on the touch screen of the machine, the machine resumes printing from the page where the paper was jammed.

- If the paper is jammed while printing from a computer or copying in progress:

After clearing the paper jam error and tapping **OK** on the touch screen of the machine, then the machine resumes printing from the next page where the paper was jammed.

As the page where the paper was jammed is not printed, reprint if necessary.

When the paper is jammed while duplex printing or duplex copying is in progress, it is possible that the printing or copying order is not as you expect if you resume printing after clearing the paper jam error. In this case, cancel printing and reprint from the beginning.

When the paper is jammed while layout printing, 2 on 1 copying, or 4 on 1 copying is in progress, it is possible that some pages are not printed if you resume printing after clearing the paper jam error. In this case, cancel printing and reprint from the beginning.

- If you turned off the machine while taking the appropriate action of the paper jam error:

All print jobs in the queue are canceled. Reprint if necessary.

Note

- When reloading the paper, confirm that you are using the paper suited for printing and are loading it correctly.

Align the paper guides with the both edges of the paper when you load paper.

If you cannot remove the paper or the paper tears inside the machine, or if the paper jam error continues after removing the paper, contact the service center.

1314

Cause

Paper is jammed inside the rear cover when performing automatic duplex printing.

Action

If the paper is jammed inside the rear cover when performing automatic duplex printing, remove the paper following the procedure below.

►► Important

- The power cannot be turned off while the machine is sending or receiving a fax, or when the received fax or the unsent fax are stored in the machine's memory.

Make sure that the machine has completed sending or receiving all the faxes before unplugging the power cord.

If you unplug the power cord, all the faxes stored in the machine's memory are deleted.

►► Note

- If you need to turn off the machine to remove jammed paper during printing, press the **Stop** button to cancel print jobs before turning off the machine.

1. Rotate the machine so that the rear side of the machine faces toward you.

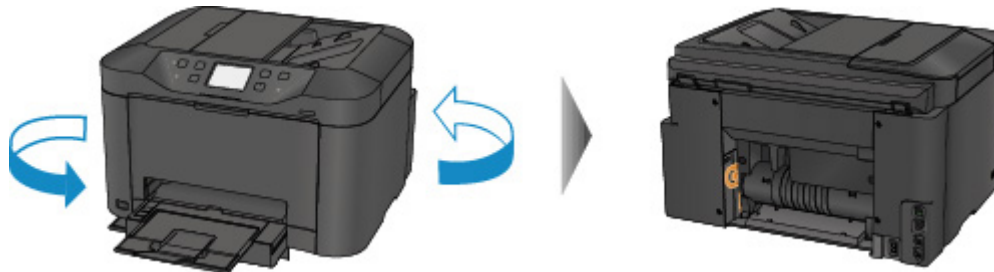

2. If the protective material for the rear cover remains attached, remove it.

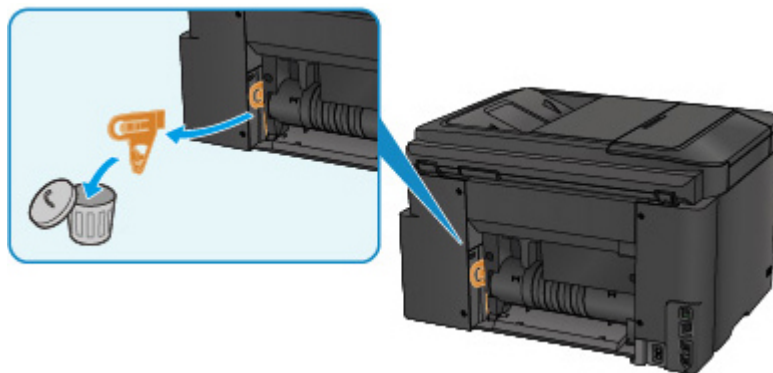

3. Open the rear cover.

Slide the rear cover to the left then open it.

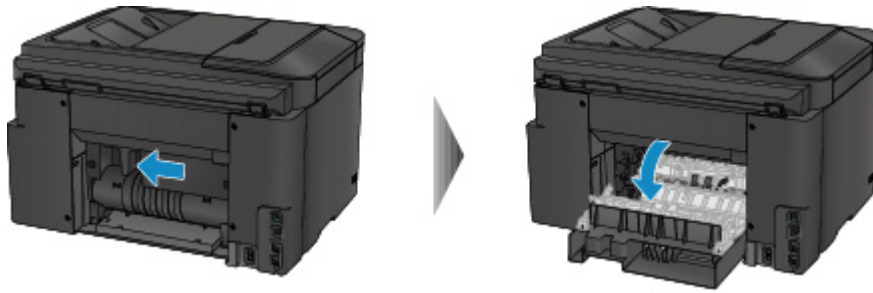

4. Pull out the paper slowly.

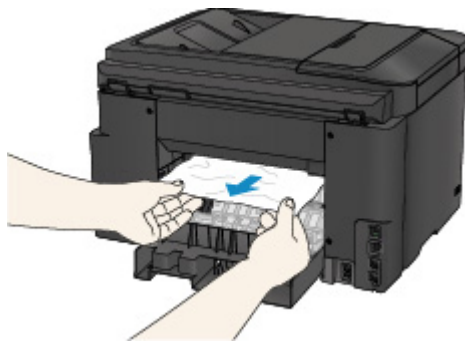

▶▶ Note

- Do not touch the inner parts of the machine.
- If you cannot pull the paper out, try the following.
 - Turn the machine off and turn it back on.
The paper may be ejected automatically.
 - Pull out the paper output tray.
It becomes easy to pull out the paper.

5. Close the rear cover slowly.

Close the rear cover then slide it to the right.

Slide the rear cover so that the \triangle mark on the rear cover aligns with the ∇ mark on the machine.

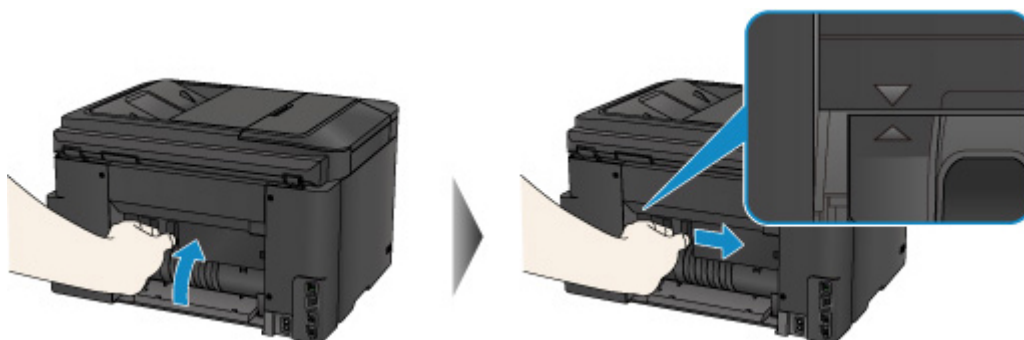

6. Reload the paper, and tap **OK** on the touch screen of the machine.

- If the paper is jammed while printing the faxes or the fax report in progress:
After clearing the paper jam error and tapping **OK** on the touch screen of the machine, the machine resumes printing from the page where the paper was jammed.
- If the paper is jammed while printing from a computer or copying in progress:

After clearing the paper jam error and tapping **OK** on the touch screen of the machine, then the machine resumes printing from the next page where the paper was jammed.

As the page where the paper was jammed is not printed, reprint if necessary.

When the paper is jammed while duplex printing or duplex copying is in progress, it is possible that the printing or copying order is not as you expect if you resume printing after clearing the paper jam error. In this case, cancel printing and reprint from the beginning.

When the paper is jammed while layout printing, 2 on 1 copying, or 4 on 1 copying is in progress, it is possible that some pages are not printed if you resume printing after clearing the paper jam error. In this case, cancel printing and reprint from the beginning.

- If you turned off the machine while taking the appropriate action of the paper jam error:

All print jobs in the queue are canceled. Reprint if necessary.

Note

- When reloading the paper, confirm that you are using the paper suited for printing and are loading it correctly.

Align the paper guides with the both edges of the paper when you load paper.

If you cannot remove the paper or the paper tears inside the machine, or if the paper jam error continues after removing the paper, contact the service center.

2801

Cause

The document is jammed in the ADF.

Action

Remove the document following the procedure below.

»» Important

- The power cannot be turned off while the machine is sending or receiving a fax, or when the received fax or the unsent fax are stored in the machine's memory.

Make sure that the machine has completed sending or receiving all the faxes before unplugging the power cord.

If you unplug the power cord, all the faxes stored in the machine's memory are deleted.

- **If the original remains in the ADF by pressing the Stop button while the machine is scanning the document:**

If you press the **Stop** button during scanning then the document remained in the ADF, the message about the paper remained in the ADF appears on the touch screen. Tap **OK** so that the remaining document is automatically fed out.

- **If the original is jammed in the ADF:**

Remove the document following the procedure below.

1. If printing is in progress, press the **Stop** button.
2. Turn off the machine.
3. If a multi-page document is loaded, remove any pages other than the jammed page from the ADF, then open the document feeder cover.



4. Pull out the jammed document from the ADF.



5. Close the document feeder cover, then turn on the machine.

When rescanning the document after clearing the error, rescan it from the first page.

If you cannot remove the document or the document tears inside the machine, or if the document jam error continues after removing the document, contact the service center.

▶▶▶ Note

- The document may not feed properly depending on the media type, or your environment, such as when the temperature and humidity are either too high or too low.

In this case, reduce the number of document pages to approximately half of the loading capacity.

If the document still jams, use the platen glass instead.

• If the original is jammed in the ADF (from the paper feed side):

If the document is jammed in the document output slot, close the document tray as shown in the figure below and pull out the document.



When rescanning the document after clearing the error, rescan it from the first page.

If you cannot remove the document or the document tears inside the machine, or if the document jam error continues after removing the document, contact the service center.

In Other Cases

Make sure of the following:

Check1 Are there any foreign objects around the paper output slot?

Check2 Are the rear cover attached properly?

Check3 Is the paper curled?

Load the paper after correcting its curl.

1003

Cause

Possible causes include the following.

- There is no paper in the cassette.
- Paper is not loaded in the cassette properly.

Action

Take the corresponding actions below.

- Load paper in the cassette.
- Align the paper guides with the both edges of the paper when you load paper in the cassette.

After carrying out the above measures, tap **OK** on the touch screen to dismiss the error.

▶▶ Note

- If you want to cancel printing, press the machine's **Stop** button.

1200

Cause

The front cover is open.

Action

Close the front cover and wait for a while.

Do not close it while you are replacing an ink tank.

1310

Cause

The size of paper may not be compatible with automatic duplex printing.

Action

The sizes of media suitable for auto duplex printing are A4 and Letter. Make sure that the size of the paper loaded in the machine is correct. Tapping **OK** on the touch screen will eject the paper and restart printing from the front side of the next paper. The reverse side of the ejected sheet will not be printed.

1575

Cause

Ink cannot be correctly detected.

Action

If an ink tank becomes empty, replace it.

An ink tank cannot be replaced until it becomes empty.

Please be advised that Canon shall not be liable for any malfunction or trouble caused by continuation of printing under the ink out condition.

1600

Cause

Ink may have run out.

Action

Replacing the ink tank is recommended.

If printing is in progress and you want to continue printing, tap **OK** on the machine with the ink tank installed. Then printing can continue. Replacing the ink tank is recommended after the printing. The machine may be damaged if printing is continued under the ink out condition.

Since the information contained in the fax may be lost if it is printed in this condition, the received fax will not be printed and will be stored in the machine's memory until the ink is replaced. You must manually print out faxes that were stored in the memory. You can change the setting so that the received fax is forcibly printed out instead of being stored in the memory, but all or part of the fax information may not be printed because of the ink out condition.

Important

- Do not remove an ink tank until a new one is prepared to be installed.
 - Once you remove an ink tank, the machine will not operate until a new one is installed.
 - Once you remove an ink tank, the machine will not operate even if the removed ink tank is just reinstalled.

1660

Cause

The ink tank is not installed.

Action

Install the ink tank.

1688

Cause

The ink has run out.

Action

Replace the ink tank and close the front cover.

Printing under the current condition may damage the machine.

If you want to continue printing in this condition, you need to release the function for detecting the remaining ink level. Press and hold the machine's **Stop** button for at least 5 seconds, and then release it.

With this operation, releasing the function for detecting the remaining ink level is memorized. Please be advised that Canon shall not be liable for any malfunction or trouble caused by continuation of printing under the ink out condition.

▶▶ Important

- Do not remove an ink tank until a new one is prepared to be installed.
 - Once you remove an ink tank, the machine will not operate until a new one is installed.
 - Once you remove an ink tank, the machine will not operate even if the removed ink tank is just reinstalled.

▶▶ Note

- Since the information contained in the fax may be lost if it is printed in this condition, the received fax will not be printed and will be stored in the machine's memory until the ink is replaced. You must manually print out faxes that were stored in the memory. You can change the setting so that the received fax is forcibly printed out instead of being stored in the memory, but all or part of the fax information may not be printed because of the ink out condition.

1700

Cause

The ink absorber is almost full.

Action

Tap **OK** on the touch screen to continue printing. Contact the service center.

1701

Cause

The ink absorber is almost full.

Action

Tap **OK** on the touch screen to continue printing. Contact the service center.

1754

Cause

The ink tank is not installed properly.

Action

Open the front cover.

Then push the ink tank.

After installing the ink tank properly, close the front cover.

If the problem is not resolved, contact the service center.

►► Important

- The ink tank that was once installed cannot be removed until the ink runs out.

1755

Cause

The ink has run out.

Action

To maintain both machine and print quality, the machine cannot continue printing under the ink out condition.

Cancel printing and replace the ink tank before printing again.

▶▶ Important

- Do not remove an ink tank until a new one is prepared to be installed.
 - Once you remove an ink tank, the machine will not operate until a new one is installed.
 - Once you remove an ink tank, the machine will not operate even if the removed ink tank is just reinstalled.

▶▶ Note

- Since the information contained in the fax may be lost if it is printed in this condition, the received fax will not be printed and will be stored in the machine's memory until the ink is replaced. You must manually print out faxes that were stored in the memory.

1871

Cause

The cassette is not inserted.

Action

Insert the cassette.

▶▶ Note

- The cassette paper information registration screen is displayed after inserting the cassette. Register the cassette paper information according to the paper you loaded in the cassette.
- If you want to cancel printing, press the machine's **Stop** button.

1890

Cause

The protective material for the print head holder or the tape may remain attached to the holder.

Action

Open the front cover, then confirm that the protective material or the tape does not remain attached to the print head holder.

If you find the protective material or the tape remains attached, remove it, then close the front cover.

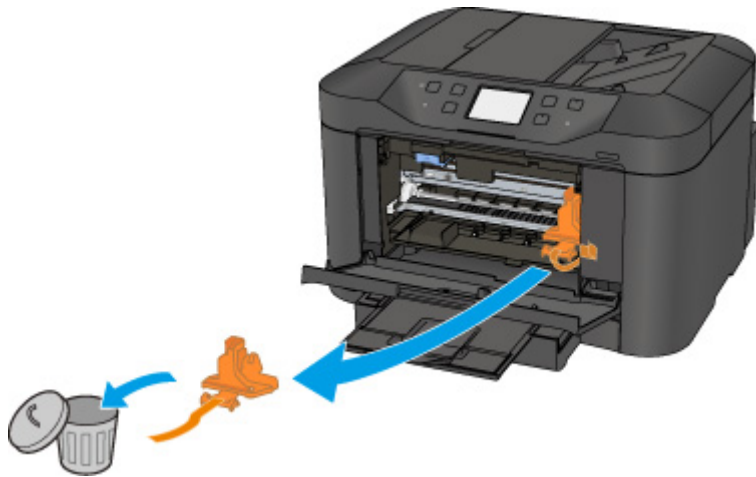

If the problem is not resolved, contact the service center.

2001

Cause

The device incompatible with the machine is connected.

Action

Check the device connected to the USB flash drive port. Printing photos directly is possible with a USB flash drive.

2002

Cause

An unsupported USB hub is connected.

Action

If a USB flash drive is connected to the machine through the USB hub, disconnect the hub from the machine.

Connect a USB flash drive directly to the machine.

2110

Cause

The paper settings for printing or copying are different from the cassette paper information registered to the machine.

▶▶▶ Note

- For details on the proper combination of paper settings you can specify by the printer driver or on the touch screen:
 - [Setting the Media Type with the Printer Driver and on the Printer](#) (Windows)
 - [Setting the Media Type with the Printer Driver and on the Printer](#) (Mac)
 - [Setting the Paper Size with the Printer Driver and on the Printer](#) (Windows)
 - [Setting the Paper Size with the Printer Driver and on the Printer](#) (Mac)
- For copying, specify the paper settings for copying so that they match the cassette paper information.
- For details on the cassette paper information registering to the machine:
 - [Paper setting for Printing](#) (Windows)
 - [Paper setting for Printing](#) (Mac)
 - [Paper setting for Printing](#) (Smartphone and so on)

If the paper settings for printing or copying are different from the cassette paper information registered to the machine as the following, a message is displayed on the touch screen.

- Print settings specified on the printer driver:
 - Paper size: B5
 - Media type: Plain paper
- Cassette paper information registered to the machine:
 - Paper size: A4
 - Media type: Plain paper

Print settings specified for printing or copying is displayed below the message.

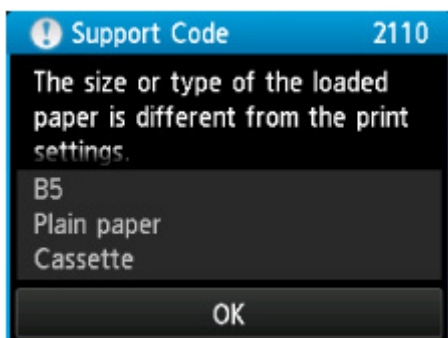

Action

Tapping **OK** on the touch screen, the following screen is displayed.

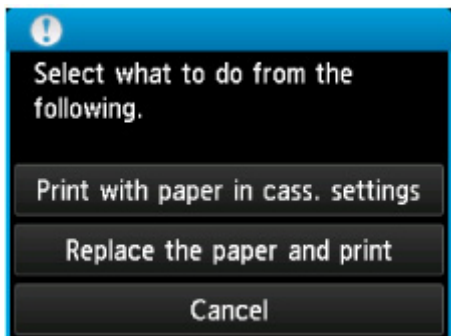

Select what to do as necessary.

»» Note

- Depending on the setting, the choices below may not be displayed.

Print with paper in cass. settings

Select if you want to print on the paper loaded in the cassette without changing the paper settings.

For example, when the paper setting for printing or copying is B5 and the cassette paper information registered to the machine is A4, the machine starts printing or copying with B5 on the paper loaded in the cassette.

Replace the paper and print

Select if you want to print after replacing the paper of the cassette.

For example, when the paper setting for printing or copying is B5 and the cassette paper information registered to the machine is A4, you load B5 sized paper in the cassette before you start printing or copying.

The cassette paper information registration screen is displayed after replacing the paper and inserting the cassette. Register the cassette paper information according to the paper you loaded in the cassette.

»» Note

- If you do not know what paper information to register to the machine, press the **Back** button when the screen to select the operation is displayed. When the previous screen is displayed, confirm the paper size and the media type, then register them to the machine.
- For details on the proper combination of paper settings you can specify by the printer driver or on the touch screen:
 - [Setting the Media Type with the Printer Driver and on the Printer](#) (Windows)
 - [Setting the Media Type with the Printer Driver and on the Printer](#) (Mac)
 - [Setting the Paper Size with the Printer Driver and on the Printer](#) (Windows)
 - [Setting the Paper Size with the Printer Driver and on the Printer](#) (Mac)

Cancel

Cancels printing.

Select when you change the paper settings specified for printing or copying. Change the paper settings, then try printing again.

▶▶ Note

- You can disable the message which prevents misprinting. When you disable the message, the machine starts printing or copying even though the paper settings for printing or copying and the cassette paper information registered to the machine are different.
 - To change the setting using the operation panel:
 - [Cassette settings](#) (Windows)
 - [Cassette settings](#) (Mac)
 - [Cassette settings](#) (Smartphone and so on)
 - To change the setting using the printer driver:
 - [Changing the Printer Operation Mode](#) (Windows)
 - [Changing the Printer Operation Mode](#) (Mac)

2120

Cause

The paper settings of the cassette is not complete.

Action

If the following screen is displayed, the paper settings of the cassette is not complete.

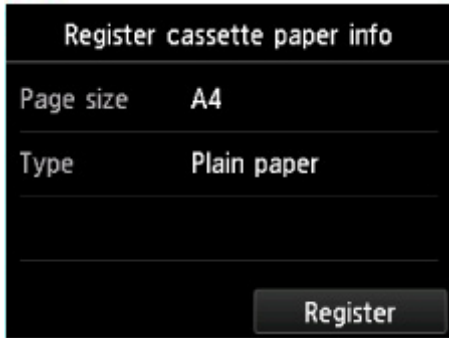

Tap **Register** on the touch screen of the machine to terminate the paper settings of the cassette.

2500

Cause

The cause of following may have occurred the failure of Automatic Print Head Alignment.

- Print head nozzles are clogged.
- The paper of size other than A4 or Letter is loaded.
- The paper output slot is exposed to strong light.

Action

Tap **OK** on the touch screen to dismiss the error, then take the actions described below.

- Print the nozzle check pattern to check the status of the print head.
- Load one sheet of A4/Letter-sized plain paper and perform Automatic Print Head Alignment again.
- Adjust your operating environment and/or the position of the machine so that the paper output slot is not exposed directly to strong light.

After carrying out the above measures, if the problem continues after aligning the print head again, tap **OK** on the touch screen to dismiss the error, and then perform Manual Print Head Alignment.

2700

Cause

Possible causes include the following.

- Some errors occurred while copying and a certain time passed.
- Document is remained in the ADF.
- Some errors occurred while scanning and the document is remained in the ADF.

Action

Take the corresponding actions below.

- When you copy, tap **OK** on the touch screen to dismiss the error, and try to copy again.
- When the document is remained in the ADF, tap **OK** on the touch screen to feed out the document.
- When you scan, press the **Stop** button to cancel the scanning, and try to scan again.

2802

Cause

No document in the ADF.

Action

Tap **OK** on the touch screen to resolve the error, then operate again after loading documents.

2803

Cause

The document is too long or is jammed in the ADF.

Action

Tap **OK** on the touch screen to dismiss the error. Then make sure that the document you are loading meets the machine's requirements before redoing the operation.

If the document is jammed, remove the jammed document following the procedure below.

- **If the original is jammed in the ADF:**

Remove the document following the procedure below.

1. If printing is in progress, press the **Stop** button.
2. Turn off the machine.
3. If a multi-page document is loaded, remove any pages other than the jammed page from the ADF, then open the document feeder cover.



4. Pull out the jammed document from the ADF.

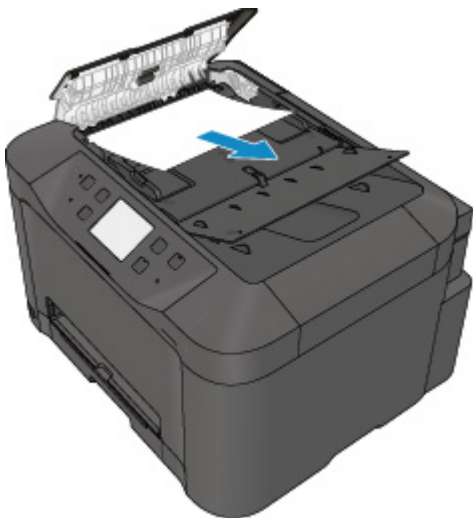

5. Close the document feeder cover, then turn on the machine.

When rescanning the document after clearing the error, rescan it from the first page.

If you cannot remove the document or the document tears inside the machine, or if the document jam error continues after removing the document, contact the service center.

▶▶▶ Note

- The document may not feed properly depending on the media type, or your environment, such as when the temperature and humidity are either too high or too low.

In this case, reduce the number of document pages to approximately half of the loading capacity.

If the document still jams, use the platen glass instead.

- **If the original is jammed in the ADF (from the paper feed side):**

If the document is jammed in the document output slot, close the document tray as shown in the figure below and pull out the document.

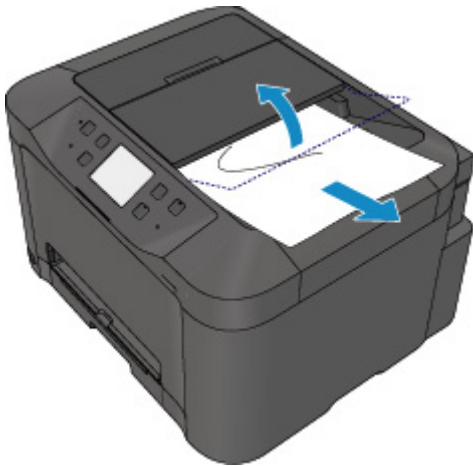

When rescanning the document after clearing the error, rescan it from the first page.

If you cannot remove the document or the document tears inside the machine, or if the document jam error continues after removing the document, contact the service center.

4100

Cause

The specified data cannot be printed.

Action

When you print the contents on CREATIVE PARK PREMIUM, confirm the message on the computer screen, make sure that genuine Canon ink tanks are installed properly for all colors, then start printing again.

4103

Cause

Cannot perform printing with the current print settings.

Action

Press the machine's **Stop** button to cancel printing.

Then change the print settings and print again.

5011

Cause

Printer error has occurred.

Action

Turn off the machine, and unplug the power cord of the machine from the power supply.

Plug the machine back in and turn the machine back on.

If the problem is not resolved, contact the service center.

►► Important

- If you unplug the power cord, all the faxes stored in the machine's memory are deleted.

5012

Cause

Printer error has occurred.

Action

Turn off the machine, and unplug the power cord of the machine from the power supply.

Plug the machine back in and turn the machine back on.

If the problem is not resolved, contact the service center.

►► Important

- If you unplug the power cord, all the faxes stored in the machine's memory are deleted.

5040

Cause

Printer error has occurred.

Action

Turn off the machine, and unplug the power cord of the machine from the power supply.

Plug the machine back in and turn the machine back on.

If the problem is not resolved, contact the service center.

►► Important

- If you unplug the power cord, all the faxes stored in the machine's memory are deleted.

5100

Cause

Printer error has occurred.

Action

Cancel printing and turn off the machine.

Then confirm the following.

- Confirm that there are no materials (e.g. the protective material or jammed paper) that is preventing the print head holder from moving.

If any, remove the materials.

- Confirm that the ink tanks are installed properly.

Push an ink tank until it clicks into place.

After confirming the conditions above, turn on the machine again.

If the problem is not resolved, contact the service center.

▶▶ Important

- When you clear the jammed paper or protective material that is preventing the print head holder from moving, be careful not to touch the clear film (A) or the white belt (B).



If the paper or your hands touch these parts and blot or scratch them, the machine can be damaged.

- If you unplug the power cord, all the faxes stored in the machine's memory are deleted.

5102

Cause

Printer error has occurred.

Action

Cancel printing and turn off the machine.

Then confirm the following.

- Confirm that there are no materials (e.g. the protective material or jammed paper) that is preventing the print head holder from moving.

If any, remove the materials.

- Confirm that the ink tanks are installed properly.

Push an ink tank until it clicks into place.

After confirming the conditions above, turn on the machine again.

If the problem is not resolved, contact the service center.

▶▶▶ Important

- When you clear the jammed paper or protective material that is preventing the print head holder from moving, be careful not to touch the clear film (A) or the white belt (B).

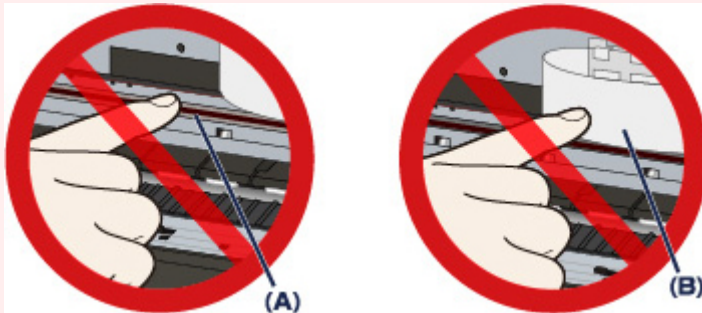

If the paper or your hands touch these parts and blot or scratch them, the machine can be damaged.

- If you unplug the power cord, all the faxes stored in the machine's memory are deleted.

5103

Cause

Printer error has occurred.

Action

Cancel printing and turn off the machine.

Then confirm the following.

- Confirm that there are no materials (e.g. the protective material or jammed paper) that is preventing the print head holder from moving.

If any, remove the materials.

- Confirm that the ink tanks are installed properly.

Push an ink tank until it clicks into place.

After confirming the conditions above, turn on the machine again.

If the problem is not resolved, contact the service center.

▶▶▶ Important

- When you clear the jammed paper or protective material that is preventing the print head holder from moving, be careful not to touch the clear film (A) or the white belt (B).



If the paper or your hands touch these parts and blot or scratch them, the machine can be damaged.

- If you unplug the power cord, all the faxes stored in the machine's memory are deleted.

5104

Cause

Printer error has occurred.

Action

Cancel printing and turn off the machine.

Then confirm the following.

- Confirm that there are no materials (e.g. the protective material or jammed paper) that is preventing the print head holder from moving.

If any, remove the materials.

- Confirm that the ink tanks are installed properly.

Push an ink tank until it clicks into place.

After confirming the conditions above, turn on the machine again.

If the problem is not resolved, contact the service center.

▶▶▶ Important

- When you clear the jammed paper or protective material that is preventing the print head holder from moving, be careful not to touch the clear film (A) or the white belt (B).

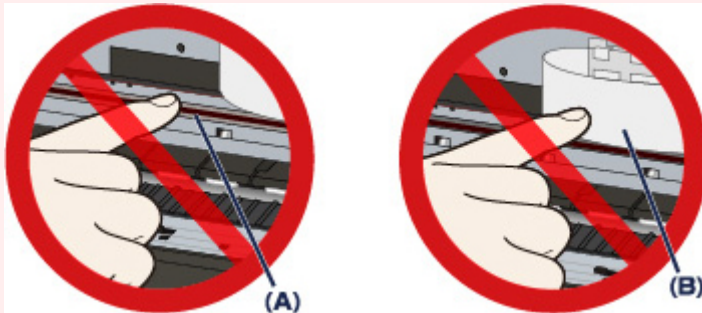

If the paper or your hands touch these parts and blot or scratch them, the machine can be damaged.

- If you unplug the power cord, all the faxes stored in the machine's memory are deleted.

5105

Cause

Printer error has occurred.

Action

Cancel printing and turn off the machine.

Then confirm the following.

- Confirm that there are no materials (e.g. the protective material or jammed paper) that is preventing the print head holder from moving.

If any, remove the materials.

- Confirm that the ink tanks are installed properly.

Push an ink tank until it clicks into place.

After confirming the conditions above, turn on the machine again.

If the problem is not resolved, contact the service center.

▶▶▶ Important

- When you clear the jammed paper or protective material that is preventing the print head holder from moving, be careful not to touch the clear film (A) or the white belt (B).

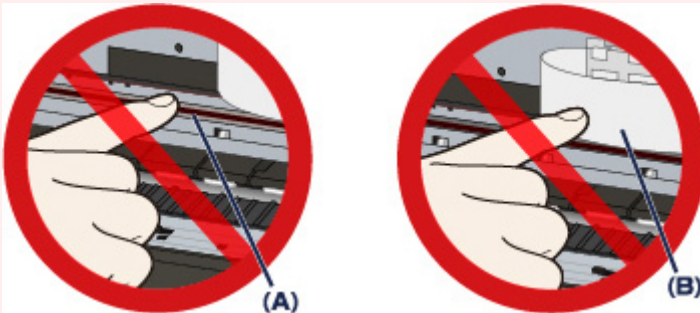

If the paper or your hands touch these parts and blot or scratch them, the machine can be damaged.

- If you unplug the power cord, all the faxes stored in the machine's memory are deleted.

5200

Cause

Printer error has occurred.

Action

Turn off the machine, and unplug the power cord of the machine from the power supply.

Plug the machine back in and turn the machine back on.

If the problem is not resolved, contact the service center.

►► Important

- If you unplug the power cord, all the faxes stored in the machine's memory are deleted.

5203

Cause

Printer error has occurred.

Action

Turn off the machine, and unplug the power cord of the machine from the power supply.

Plug the machine back in and turn the machine back on.

If the problem is not resolved, contact the service center.

►► Important

- If you unplug the power cord, all the faxes stored in the machine's memory are deleted.

5204

Cause

Printer error has occurred.

Action

Turn off the machine, and unplug the power cord of the machine from the power supply.

Plug the machine back in and turn the machine back on.

If the problem is not resolved, contact the service center.

►► Important

- If you unplug the power cord, all the faxes stored in the machine's memory are deleted.

5205

Cause

Printer error has occurred.

Action

Turn off the machine, and unplug the power cord of the machine from the power supply.

Plug the machine back in and turn the machine back on.

If the problem is not resolved, contact the service center.

►► Important

- If you unplug the power cord, all the faxes stored in the machine's memory are deleted.

5206

Cause

Printer error has occurred.

Action

Turn off the machine, and unplug the power cord of the machine from the power supply.

Plug the machine back in and turn the machine back on.

If the problem is not resolved, contact the service center.

►► Important

- If you unplug the power cord, all the faxes stored in the machine's memory are deleted.

5207

Cause

Printer error has occurred.

Action

Turn off the machine, and unplug the power cord of the machine from the power supply.

Plug the machine back in and turn the machine back on.

If the problem is not resolved, contact the service center.

►► Important

- If you unplug the power cord, all the faxes stored in the machine's memory are deleted.

5208

Cause

Printer error has occurred.

Action

Turn off the machine, and unplug the power cord of the machine from the power supply.

Plug the machine back in and turn the machine back on.

If the problem is not resolved, contact the service center.

►► Important

- If you unplug the power cord, all the faxes stored in the machine's memory are deleted.

5209

Cause

Printer error has occurred.

Action

Turn off the machine, and unplug the power cord of the machine from the power supply.

Plug the machine back in and turn the machine back on.

If the problem is not resolved, contact the service center.

►► Important

- If you unplug the power cord, all the faxes stored in the machine's memory are deleted.

5400

Cause

Printer error has occurred.

Action

Turn off the machine, and unplug the power cord of the machine from the power supply.

Plug the machine back in and turn the machine back on.

If the problem is not resolved, contact the service center.

►► Important

- If you unplug the power cord, all the faxes stored in the machine's memory are deleted.

5500

Cause

Ink tank has not been properly recognized.

Action

Contact the service center.

5501

Cause

Ink tank has not been properly recognized.

Action

Contact the service center.

5B00

Cause

Printer error has occurred.

Action

Contact the service center.

5B01

Cause

Printer error has occurred.

Action

Contact the service center.

5C01

Cause

Printer error has occurred.

Action

Turn off the machine, and unplug the power cord of the machine from the power supply.

Plug the machine back in and turn the machine back on.

If the problem is not resolved, contact the service center.

►► Important

- If you unplug the power cord, all the faxes stored in the machine's memory are deleted.

6000

Cause

Printer error has occurred.

Action

Turn off the machine, and unplug the power cord of the machine from the power supply.

Plug the machine back in and turn the machine back on.

If the problem is not resolved, contact the service center.

Important

- If you unplug the power cord, all the faxes stored in the machine's memory are deleted.

6500

Cause

Printer error has occurred.

Action

Turn off the machine, and unplug the power cord of the machine from the power supply.

Plug the machine back in and turn the machine back on.

If the problem is not resolved, contact the service center.

►► Important

- If you unplug the power cord, all the faxes stored in the machine's memory are deleted.

6502

Cause

Printer error has occurred.

Action

Turn off the machine, and unplug the power cord of the machine from the power supply.

Plug the machine back in and turn the machine back on.

If the problem is not resolved, contact the service center.

►► Important

- If you unplug the power cord, all the faxes stored in the machine's memory are deleted.

6700

Cause

Printer error has occurred.

Action

Turn off the machine, and unplug the power cord of the machine from the power supply.

Plug the machine back in and turn the machine back on.

If the problem is not resolved, contact the service center.

Important

- If you unplug the power cord, all the faxes stored in the machine's memory are deleted.

6800

Cause

Printer error has occurred.

Action

Turn off the machine, and unplug the power cord of the machine from the power supply.

Plug the machine back in and turn the machine back on.

If the problem is not resolved, contact the service center.

►► Important

- If you unplug the power cord, all the faxes stored in the machine's memory are deleted.

6801

Cause

Printer error has occurred.

Action

Turn off the machine, and unplug the power cord of the machine from the power supply.

Plug the machine back in and turn the machine back on.

If the problem is not resolved, contact the service center.

►► Important

- If you unplug the power cord, all the faxes stored in the machine's memory are deleted.

6900

Cause

Printer error has occurred.

Action

Turn off the machine, and unplug the power cord of the machine from the power supply.

Plug the machine back in and turn the machine back on.

If the problem is not resolved, contact the service center.

►► Important

- If you unplug the power cord, all the faxes stored in the machine's memory are deleted.

6901

Cause

Printer error has occurred.

Action

Turn off the machine, and unplug the power cord of the machine from the power supply.

Plug the machine back in and turn the machine back on.

If the problem is not resolved, contact the service center.

►► Important

- If you unplug the power cord, all the faxes stored in the machine's memory are deleted.

6902

Cause

Printer error has occurred.

Action

Turn off the machine, and unplug the power cord of the machine from the power supply.

Plug the machine back in and turn the machine back on.

If the problem is not resolved, contact the service center.

►► Important

- If you unplug the power cord, all the faxes stored in the machine's memory are deleted.

6910

Cause

Printer error has occurred.

Action

Turn off the machine, and unplug the power cord of the machine from the power supply.

Plug the machine back in and turn the machine back on.

If the problem is not resolved, contact the service center.

►► Important

- If you unplug the power cord, all the faxes stored in the machine's memory are deleted.

6911

Cause

Printer error has occurred.

Action

Turn off the machine, and unplug the power cord of the machine from the power supply.

Plug the machine back in and turn the machine back on.

If the problem is not resolved, contact the service center.

►► Important

- If you unplug the power cord, all the faxes stored in the machine's memory are deleted.

6920

Cause

Printer error has occurred.

Action

Turn off the machine, and unplug the power cord of the machine from the power supply.

Plug the machine back in and turn the machine back on.

If the problem is not resolved, contact the service center.

►► Important

- If you unplug the power cord, all the faxes stored in the machine's memory are deleted.

6921

Cause

Printer error has occurred.

Action

Turn off the machine, and unplug the power cord of the machine from the power supply.

Plug the machine back in and turn the machine back on.

If the problem is not resolved, contact the service center.

►► Important

- If you unplug the power cord, all the faxes stored in the machine's memory are deleted.

6930

Cause

Printer error has occurred.

Action

Turn off the machine, and unplug the power cord of the machine from the power supply.

Plug the machine back in and turn the machine back on.

If the problem is not resolved, contact the service center.

►► Important

- If you unplug the power cord, all the faxes stored in the machine's memory are deleted.

6931

Cause

Printer error has occurred.

Action

Turn off the machine, and unplug the power cord of the machine from the power supply.

Plug the machine back in and turn the machine back on.

If the problem is not resolved, contact the service center.

►► Important

- If you unplug the power cord, all the faxes stored in the machine's memory are deleted.

6932

Cause

Printer error has occurred.

Action

Turn off the machine, and unplug the power cord of the machine from the power supply.

Plug the machine back in and turn the machine back on.

If the problem is not resolved, contact the service center.

►► Important

- If you unplug the power cord, all the faxes stored in the machine's memory are deleted.

6933

Cause

Printer error has occurred.

Action

Turn off the machine, and unplug the power cord of the machine from the power supply.

Plug the machine back in and turn the machine back on.

If the problem is not resolved, contact the service center.

►► Important

- If you unplug the power cord, all the faxes stored in the machine's memory are deleted.

6936

Cause

Printer error has occurred.

Action

Turn off the machine, and unplug the power cord of the machine from the power supply.

Plug the machine back in and turn the machine back on.

If the problem is not resolved, contact the service center.

Important

- If you unplug the power cord, all the faxes stored in the machine's memory are deleted.

6937

Cause

Printer error has occurred.

Action

Turn off the machine, and unplug the power cord of the machine from the power supply.

Plug the machine back in and turn the machine back on.

If the problem is not resolved, contact the service center.

Important

- If you unplug the power cord, all the faxes stored in the machine's memory are deleted.

6938

Cause

Printer error has occurred.

Action

Turn off the machine, and unplug the power cord of the machine from the power supply.

Plug the machine back in and turn the machine back on.

If the problem is not resolved, contact the service center.

►► Important

- If you unplug the power cord, all the faxes stored in the machine's memory are deleted.

6939

Cause

Printer error has occurred.

Action

Turn off the machine, and unplug the power cord of the machine from the power supply.

Plug the machine back in and turn the machine back on.

If the problem is not resolved, contact the service center.

Important

- If you unplug the power cord, all the faxes stored in the machine's memory are deleted.

693A

Cause

Printer error has occurred.

Action

Turn off the machine, and unplug the power cord of the machine from the power supply.

Plug the machine back in and turn the machine back on.

If the problem is not resolved, contact the service center.

►► Important

- If you unplug the power cord, all the faxes stored in the machine's memory are deleted.

6940

Cause

Printer error has occurred.

Action

Turn off the machine, and unplug the power cord of the machine from the power supply.

Plug the machine back in and turn the machine back on.

If the problem is not resolved, contact the service center.

►► Important

- If you unplug the power cord, all the faxes stored in the machine's memory are deleted.

6941

Cause

Printer error has occurred.

Action

Turn off the machine, and unplug the power cord of the machine from the power supply.

Plug the machine back in and turn the machine back on.

If the problem is not resolved, contact the service center.

►► Important

- If you unplug the power cord, all the faxes stored in the machine's memory are deleted.

6942

Cause

Printer error has occurred.

Action

Turn off the machine, and unplug the power cord of the machine from the power supply.

Plug the machine back in and turn the machine back on.

If the problem is not resolved, contact the service center.

►► Important

- If you unplug the power cord, all the faxes stored in the machine's memory are deleted.

6943

Cause

Printer error has occurred.

Action

Turn off the machine, and unplug the power cord of the machine from the power supply.

Plug the machine back in and turn the machine back on.

If the problem is not resolved, contact the service center.

►► Important

- If you unplug the power cord, all the faxes stored in the machine's memory are deleted.

6944

Cause

Printer error has occurred.

Action

Turn off the machine, and unplug the power cord of the machine from the power supply.

Plug the machine back in and turn the machine back on.

If the problem is not resolved, contact the service center.

►► Important

- If you unplug the power cord, all the faxes stored in the machine's memory are deleted.

6945

Cause

Printer error has occurred.

Action

Turn off the machine, and unplug the power cord of the machine from the power supply.

Plug the machine back in and turn the machine back on.

If the problem is not resolved, contact the service center.

►► Important

- If you unplug the power cord, all the faxes stored in the machine's memory are deleted.

6946

Cause

Printer error has occurred.

Action

Turn off the machine, and unplug the power cord of the machine from the power supply.

Plug the machine back in and turn the machine back on.

If the problem is not resolved, contact the service center.

►► Important

- If you unplug the power cord, all the faxes stored in the machine's memory are deleted.

7100

Cause

Printer error has occurred.

Action

Turn off the machine, and unplug the power cord of the machine from the power supply.

Plug the machine back in and turn the machine back on.

If the problem is not resolved, contact the service center.

Important

- If you unplug the power cord, all the faxes stored in the machine's memory are deleted.

7200

Cause

Printer error has occurred.

Action

Turn off the machine, and unplug the power cord of the machine from the power supply.

Plug the machine back in and turn the machine back on.

If the problem is not resolved, contact the service center.

►► Important

- If you unplug the power cord, all the faxes stored in the machine's memory are deleted.

7201

Cause

Printer error has occurred.

Action

Turn off the machine, and unplug the power cord of the machine from the power supply.

Plug the machine back in and turn the machine back on.

If the problem is not resolved, contact the service center.

►► Important

- If you unplug the power cord, all the faxes stored in the machine's memory are deleted.

7202

Cause

Printer error has occurred.

Action

Turn off the machine, and unplug the power cord of the machine from the power supply.

Plug the machine back in and turn the machine back on.

If the problem is not resolved, contact the service center.

►► Important

- If you unplug the power cord, all the faxes stored in the machine's memory are deleted.

7203

Cause

Printer error has occurred.

Action

Turn off the machine, and unplug the power cord of the machine from the power supply.

Plug the machine back in and turn the machine back on.

If the problem is not resolved, contact the service center.

►► Important

- If you unplug the power cord, all the faxes stored in the machine's memory are deleted.

7204

Cause

Printer error has occurred.

Action

Turn off the machine, and unplug the power cord of the machine from the power supply.

Plug the machine back in and turn the machine back on.

If the problem is not resolved, contact the service center.

►► Important

- If you unplug the power cord, all the faxes stored in the machine's memory are deleted.

7205

Cause

Printer error has occurred.

Action

Turn off the machine, and unplug the power cord of the machine from the power supply.

Plug the machine back in and turn the machine back on.

If the problem is not resolved, contact the service center.

►► Important

- If you unplug the power cord, all the faxes stored in the machine's memory are deleted.

7300

Cause

Printer error has occurred.

Action

Turn off the machine, and unplug the power cord of the machine from the power supply.

Plug the machine back in and turn the machine back on.

If the problem is not resolved, contact the service center.

►► Important

- If you unplug the power cord, all the faxes stored in the machine's memory are deleted.

9000

Cause

Printer error has occurred.

Action

Turn off the machine, and unplug the power cord of the machine from the power supply.

Plug the machine back in and turn the machine back on.

If the problem is not resolved, contact the service center.

►► Important

- If you unplug the power cord, all the faxes stored in the machine's memory are deleted.

9500

Cause

Printer error has occurred.

Action

Turn off the machine, and unplug the power cord of the machine from the power supply.

Plug the machine back in and turn the machine back on.

If the problem is not resolved, contact the service center.

►► Important

- If you unplug the power cord, all the faxes stored in the machine's memory are deleted.

B202

Cause

An error requiring you to contact the service center has occurred.

Action

Turn off the machine, and unplug the power cord of the machine from the power supply.

Contact the service center.

►► Important

- If you unplug the power cord, all the faxes stored in the machine's memory are deleted.

B203

Cause

An error requiring you to contact the service center has occurred.

Action

Turn off the machine, and unplug the power cord of the machine from the power supply.

Contact the service center.

►► Important

- If you unplug the power cord, all the faxes stored in the machine's memory are deleted.

B204

Cause

An error requiring you to contact the service center has occurred.

Action

Turn off the machine, and unplug the power cord of the machine from the power supply.

Contact the service center.

►► Important

- If you unplug the power cord, all the faxes stored in the machine's memory are deleted.

B502

Cause

Printer error has occurred.

Action

Turn off the machine, and unplug the power cord of the machine from the power supply.

Plug the machine back in and turn the machine back on.

If the problem is not resolved, contact the service center.

►► Important

- If you unplug the power cord, all the faxes stored in the machine's memory are deleted.

B503

Cause

Printer error has occurred.

Action

Turn off the machine, and unplug the power cord of the machine from the power supply.

Plug the machine back in and turn the machine back on.

If the problem is not resolved, contact the service center.

►► Important

- If you unplug the power cord, all the faxes stored in the machine's memory are deleted.

B504

Cause

Printer error has occurred.

Action

Turn off the machine, and unplug the power cord of the machine from the power supply.

Plug the machine back in and turn the machine back on.

If the problem is not resolved, contact the service center.

►► Important

- If you unplug the power cord, all the faxes stored in the machine's memory are deleted.

C000

Cause

Printer error has occurred.

Action

Cancel printing and turn off the machine.

Then confirm the following.

- Confirm that there are no materials (e.g. the protective material or jammed paper) that is preventing the print head holder from moving.

If any, remove the materials.

- Confirm that the ink tanks are installed properly.

Push an ink tank until it clicks into place.

After confirming the conditions above, turn on the machine again.

If the problem is not resolved, contact the service center.

▶▶ Important

- When you clear the jammed paper or protective material that is preventing the print head holder from moving, be careful not to touch the clear film (A) or the white belt (B).



If the paper or your hands touch these parts and blot or scratch them, the machine can be damaged.

- If you unplug the power cord, all the faxes stored in the machine's memory are deleted.