

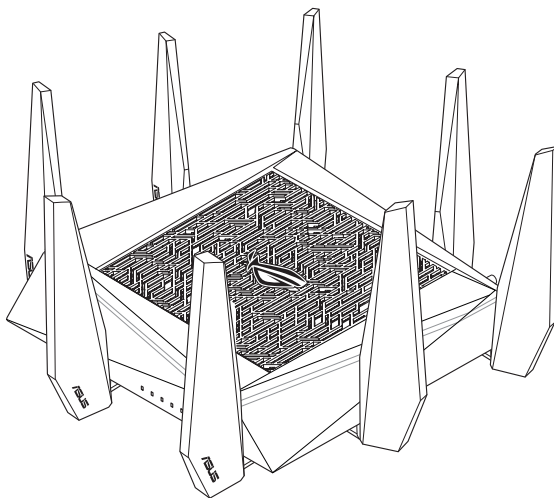

ROG Rapture GT-AC5300

Wireless-AC5300 Tri-Band Gaming Router



Quick Start Guide

WEU15859 / Revised Edition V6 / August 2019

Table of contents

Package contents	3
A quick look at your ROG router	3
Preparing your modem	4
Setting up your ROG router	5
A. Wired connection	5
B. Wireless connection	6
Remembering your wireless router settings	7
FAQ	7
Networks Global Hotline Information	68

This QSG contains these languages:

English
Français
Deutsch
Italiano
Dansk
Nederlands
Suomi
Ελληνικά
Norsk
Português
Español
Svenska

Package contents

- ☑️ ROG GT-AC5300 Wireless Router
- ☑️ AC adapter
- ☑️ Quick Start Guide
- ☑️ 8 * wireless antennas
- ☑️ Network cable (RJ-45)



NOTE: If any of the items is damaged or missing, contact your retailer.

A quick look at your ROG router

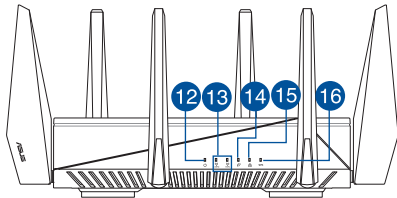
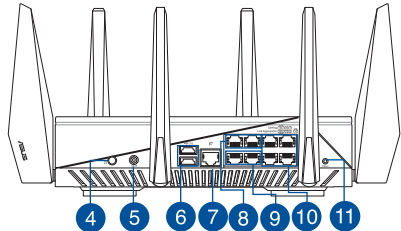
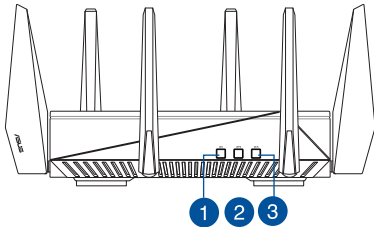

1. LED On/Off button	9. Link Aggregation (LAN 5~6)
2. WPS button	10. LAN ports
3. Wi-Fi On/Off button	11. Reset button
4. Power button	12. Power LED
5. Power (DC-IN) port	13. 2.4GHz / 5GHz Wi-Fi LED
6. USB 3.0 ports	14. WAN (Internet) LED
7. WAN (Internet) port	15. LAN LED
8. Gaming ports (LAN1~2)	16. WPS LED

Preparing your modem

1. **Unplug the power cable/DSL modem. If it has a battery backup, remove the battery.**

NOTE: If you are using DSL for Internet, you will need your username/password from your Internet Service Provider (ISP) to properly configure the router.

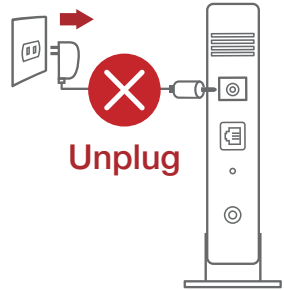

2. **Connect your modem to the router with the bundled network cable.**

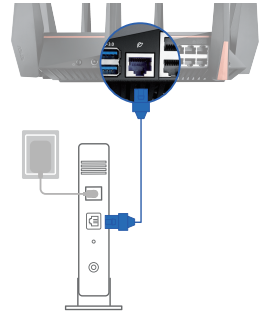

3. **Power on your cable/DSL modem.**
4. **Check your cable/DSL modem LED lights to ensure the connection is active.**

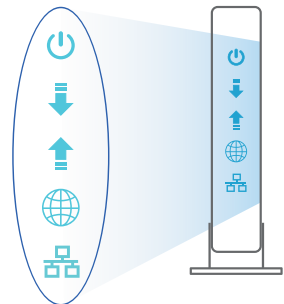

Setting up your ROG router

You can set up your ROG router via wired or wireless connection.

A. Wired connection

1. Plug your router into a power outlet and power it on. Connect the network cable from your computer to a LAN port on your router.

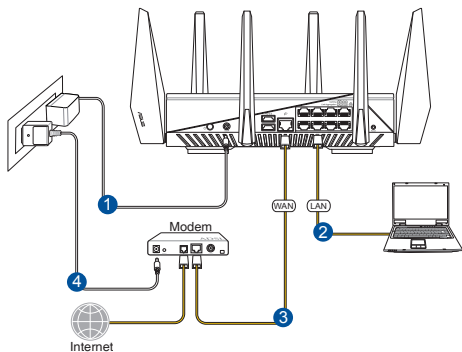

2. The web GUI launches automatically when you open a web browser. If it does not auto-launch, enter <http://router.asus.com>
3. Set up a password for your router to prevent unauthorized access.

Login Information Setup

Change the router password to prevent unauthorized access to your ASUS wireless router.

Router Login Name	<input type="text" value="admin"/>
New Password	<input type="password"/>
Retype Password	<input type="password"/>

Show password

B. Wireless connection

1. Plug your router into a power outlet and power it on.

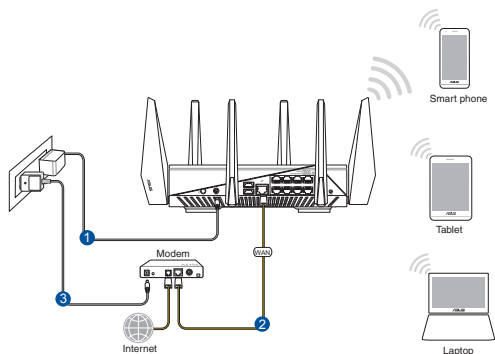

2. Connect to the network name (SSID) shown on the product label on the back side of the router. For better network security, change to a unique SSID and assign a password.



2.4G Wi-Fi Name (SSID):	ASUS_XX_2G
-------------------------	------------

5G-1 Wi-Fi Name (SSID):	ASUS_XX_5G
-------------------------	------------

5G-2 Wi-Fi Name (SSID):	ASUS_XX_5G_Gaming
-------------------------	-------------------

* **XX** refers to the last two digits of 2.4GHz MAC address. You can find it on the label on the back of your ROG router.

3. **Once connected, the web GUI launches automatically when you open a web browser. If it does not auto-launch, enter <http://router.asus.com>.**
4. **Set up a password for your router to prevent unauthorized access.**

Login Information Setup

Change the router password to prevent unauthorized access to your ASUS wireless router.

Router Login Name:

New Password:

Retype Password: Show password

Remembering your wireless router settings

- **Remember your wireless settings as you complete the router setup.**

Router Name:	Password:
2.4 GHz network SSID:	Password:
5GHz-1 network SSID:	Password:
5GHz-2 network SSID:	Password:

FAQ

1. Where can I find more information about the wireless router?
 - Online FAQ site: <http://support.asus.com/faq>
 - Technical support site: <http://support.asus.com>
 - Customer hotline: refer to the Support Hotline section in this Quick Start Guide

Pakkens indhold

- ☑ GT-AC5300
- ☑ vekselstrømsadapteren
- ☑ Kvikstartguide
- ☑ 8 * trådløse antenner
- ☑ Netværkskabel (RJ-45)



BEMÆRK: Du bedes venligst kontakte din forhandler, hvis nogen af delene mangler eller er beskadiget.

Et hurtigt kik på din router

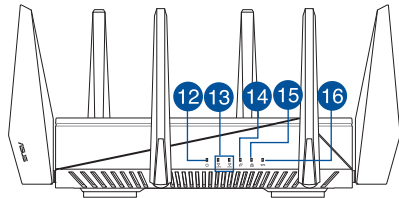
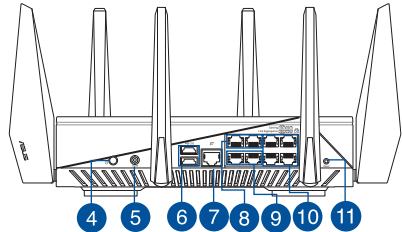
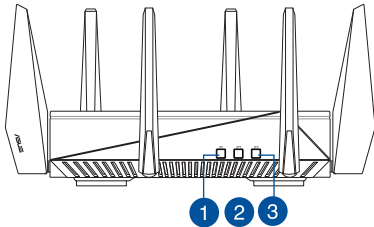

1. LED til/fra-knap	9. Link Aggregation (LAN 5-6)
2. WPS knap	10. LAN porte
3. Wi-Fi til/fra-knap	11. Nulstillingsknap
4. Strøm knap	12. Strøm LED
5. Strøm (DC-IN) port	13. Wi-Fi-indikator for 2,4 GHz/5 GHz
6. USB 3.0 porte	14. WAN-indikator (Internet)
7. WAN-port (Internet)	15. LAN LED
8. Gamingporte (LAN1-2)	16. WPS LED

Forberedelse af dit modem

1. Afbryd ledningen/DSL-modemmet. Hvis enheden indeholder et batteri, skal dette tages ud.

BEMÆRK: Hvis du bruger DSL til dit internet, skal du bruge dit brugernavn/adgangskode fra din internetudbyder (ISP) for at konfigurere routeren.

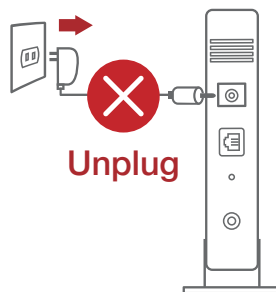

2. Tilslut modemmet til routeren med den medfølgende netværkskabel.

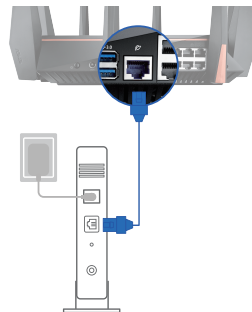

3. Tænd din kabel/DSL-modem.
4. Hold øje med lysindikatorerne på dit kabel/DSL-modem, for at sikre at forbindelsen er aktiv.

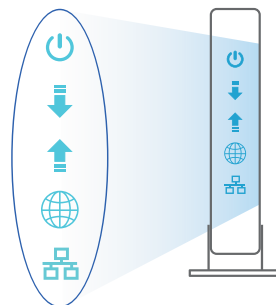

Sådan indstilles din router

Du kan konfigurere din router via en kabelforbundet eller trådløs forbindelse.

A. Kableforbundet forbindelse:

1. Slut din router til en stikkontakt og tænd den. Tilslut netværkskablet fra din computer til en LAN-port på din router.

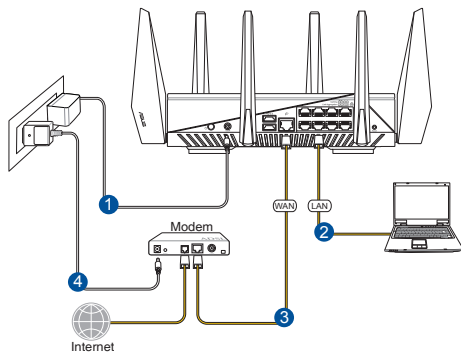

2. Når du åbner en webbrowser, åbnes brugergrænsefladen automatisk. Hvis siden ikke åbner automatisk, skal du indtaste <http://router.asus.com>.
3. Opret en adgangskode til din router, så du forhindrer uautoriseret adgang.

Login Information Setup

Change the router password to prevent unauthorized access to your ASUS wireless router.

Router Login Name	<input type="text" value="admin"/>	
New Password	<input type="password"/>	
Retype Password	<input type="password"/>	<input type="checkbox"/> Show password

B. Trådløs forbindelse

1. Slut din router til en stikkontakt og tænd den.

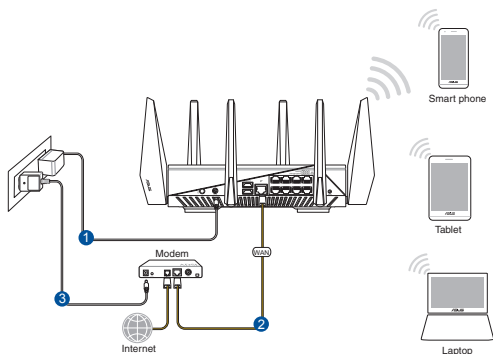

2. Opret forbindelse til netværksnavnet (SSID), der står på etiketten bag på routeren. For bedre netværkssikkerhed, bedes du skifte til et unikt SSID og oprette en adgangskode.



Navn på 2,4 G Wi-Fi (SSID):	ASUS_XX_2G
Navn på 5 G-1 Wi-Fi (SSID):	ASUS_XX_5G
Navn på 5 G-2 Wi-Fi (SSID):	ASUS_XX_5G_Gaming

* **XX** referer til de sidste to cifre i 2,4 GHz MAC-adressen. Du kan finde den på etiketten på bagsiden af din router.

3. Når du åbner en webbrowser, åbnes brugergrænsefladen automatisk. Hvis siden ikke åbner automatisk, skal du indtaste <http://router.asus.com>.
4. Opret en adgangskode til din router, så du forhindrer uautoriseret adgang.

Sådan husker du dine trådløse routerindstillinger

- Husk dine trådløse indstillinger, når du konfigurerer routeren.

Navn på router:	Adgangskode:
2,4 GHz netværk SSID:	Adgangskode:
5 GHz-1 netværk SSID:	Adgangskode:
5 GHz-2 netværk SSID:	Adgangskode:

Ofte stillede spørgsmål (FAQ)

1. Hvor kan jeg finde yderligere oplysninger om min trådløs router?
 - Ofte stillede spørgsmål på nettet: <http://support.asus.com/faq>
 - Teknisk support: <http://support.asus.com/>
 - Kunde hotline: Se venligst Kunde hotline i den medfølgende vejledning

Inhoud verpakking

- ☑ GT-AC5300
- ☑ Wisselstroomadapter
- ☑ Beknopte handleiding
- ☑ 8* draadloze antennes
- ☑ Netwerkkabel(RJ-45)



OPMERKING: Als een van de items beschadigd is of ontbreekt, moet u contact opnemen met uw leverancier.

Een snelle blik op uw router

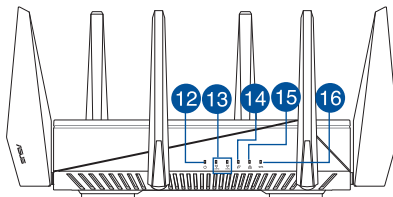
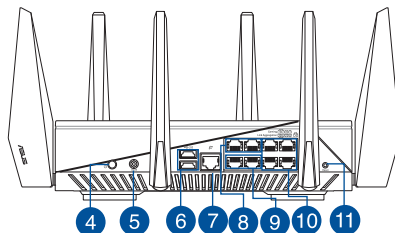
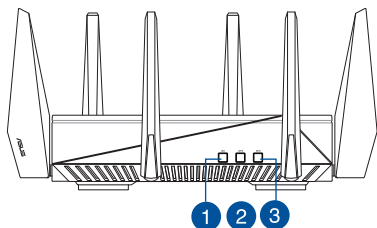

1. Knop LED aan/uit	9. Linkaggregatie (LAN 5~6)
2. WPS-knop	10. LAN poorten
3. Knop Wifi aan/uit	11. Reset-knop
4. Knop voeding	12. Voedings-LED
5. Netstroomaansluiting (DC-In)	13. 2.4GHz / 5GHz Wi-Fi LED
6. USB 3.0-poorten	14. WAN-LED (internet)
7. WAN-poort (internet)	15. LAN LED
8. Gamingpoorten (LAN1~2)	16. WPS LED

Uw modem voorbereiden

1. **Koppel de voedingskabel/DSL-modem los. Als er een back-upbatterij in het apparaat zit, moet u deze verwijderen.**

OPMERKING: Ials u DSL voor internet gebruikt, zult u uw gebruikersnaam/wachtwoord van uw internetprovider nodig hebben om de router correct te configureren.

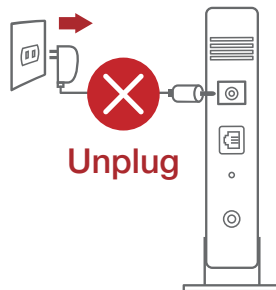

2. **Sluit uw modem aan op de router met de meegeleverde netwerkkabel.**

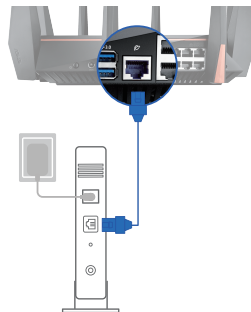

3. **Schakel uw kabel/DSL-modem in.**
4. **Controleer of de LED van de kabel/DSL-modem oplicht om zeker te zijn dat de verbinding actief is.**

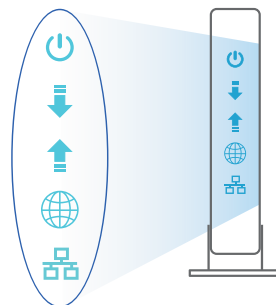

De router installeren

U kunt uw router instellen via een bekabelde of een draadloze verbinding.

A. Bekabelde aansluiting

1. Sluit uw router aan op een stopcontact en schakel deze in. Sluit de netwerkkabel van uw computer aan op een LAN-poort op uw router.

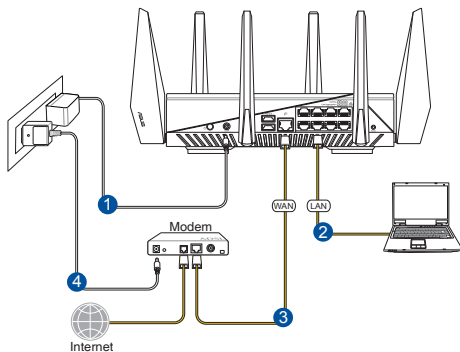

2. De grafische webinterface start automatisch wanneer u een webbrowser opent. Als deze niet automatisch start, voert u <http://router.asus.com> in.
3. Stel een wachtwoord voor uw router in om onbevoegde toegang te voorkomen.

Login Information Setup

Change the router password to prevent unauthorized access to your ASUS wireless router.

Router Login Name	<input type="text" value="admin"/>
New Password	<input type="password"/>
Retype Password	<input type="password"/> <input type="checkbox"/> Show password

B. Draadloze verbinding

1. Sluit uw router aan op een stopcontact en schakel deze in.

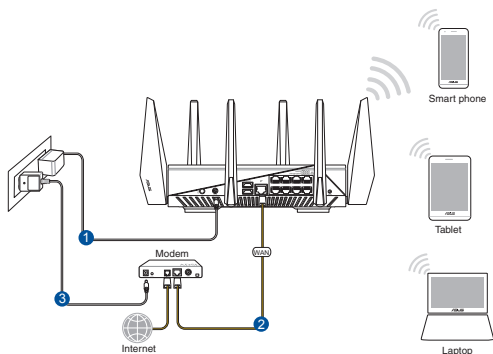

2. Maak verbinding met de netwerknaam (SSID) die op het productlabel op de achterkant van de router is vermeld. Wijzig voor een betere netwerkbeveiliging naar een unieke SSID en wijs een wachtwoord toe.



2.4 G wifi-naam (SSID):	ASUS_XX_2G
5 G-1 wifi-naam (SSID):	ASUS_XX_5G
5 G-2 wifi-naam (SSID):	ASUS_XX_5G_Gaming

* **XX** staat voor de laatste twee cijfers van het 2.4GHz MAC-adres. U kunt dit vinden op het label op de achterkant van uw router.

- De grafische webinterface start automatisch wanneer u een webbrowser opent. Als deze niet automatisch start, voert u <http://router.asus.com> in.
- Stel een wachtwoord voor uw router in om ongevoegde toegang te voorkomen.

Login Information Setup

Change the router password to prevent unauthorized access to your ASUS wireless router.

Router Login Name

New Password

Retype Password Show password

De instellingen van uw draadloze router onthouden

- Onthoud uw draadloze instellingen wanneer u de routerinstelling voltooit.

Routernaam:	wachtwoord:
SSID 2.4 GHz-netwerk:	wachtwoord:
SSID 5 GHz-1-netwerk:	wachtwoord:
SSID 5 GHz-2-netwerk:	wachtwoord:

Veelgestelde vragen (FAQ's)

- Waar kan ik meer informatie vinden over de draadloze router?
 - Online site voor veelgestelde vragen (FAQ): <http://support.asus.com/faq>
 - Site voor technische ondersteuning: <http://support.asus.com>
 - Hotline klantendienst: raadpleeg de nummers voor de ondersteuningshotline in de Aanvullende handleiding

Contenu de la boîte

- ☑ Routeur Wi-Fi ROG GT-AC5300
- ☑ Adaptateur secteur
- ☑ Guide de démarrage rapide
- ☑ 8 * Antennes Wi-Fi
- ☑ Câble réseau (RJ-45)



REMARQUE : Si l'un des éléments est endommagé ou manquant, veuillez contacter votre revendeur.

Aperçu rapide de votre routeur ROG

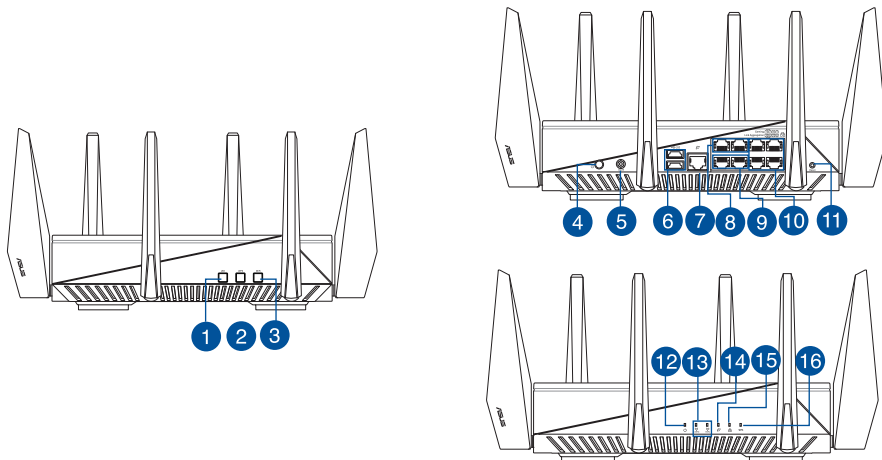

1. Bouton voyant allumé/éteint	9. Agrégation de lien (LAN 5-6)
2. Bouton WPS	10. Ports réseau local (LAN)
3. Bouton Wi-Fi activé/désactivé	11. Bouton de réinitialisation
4. Bouton d'alimentation	12. Voyant d'alimentation
5. Prise d'alimentation (CC)	13. Voyant Wi-Fi de bande 2,4 GHz / 5 GHz
6. Ports USB 3.0	14. Voyant réseau étendu (WAN) (Internet)
7. Port réseau étendu (WAN) (Internet)	15. Voyant réseau local (LAN)
8. Ports de jeu (LAN1-2)	16. Voyant WPS

Préparer votre modem

1. **Débranchez le câble d'alimentation / le modem DSL. Si votre modem possède une batterie de secours, retirez-la.**

REMARQUE : Si vous utilisez le DSL pour accéder à Internet, vous aurez besoin du nom d'utilisateur et du mot de passe fournis par votre fournisseur d'accès internet pour configurer votre routeur.



2. **Raccordez votre modem au routeur à l'aide du câble réseau fourni.**

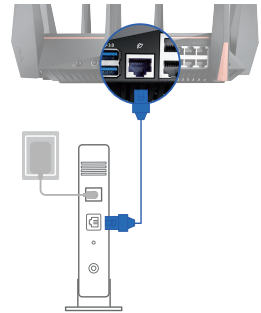

3. **Allumez votre modem câble/DSL.**
4. **Vérifiez les voyants lumineux de votre modem câble/DSL pour vous assurer que la connexion est établie.**

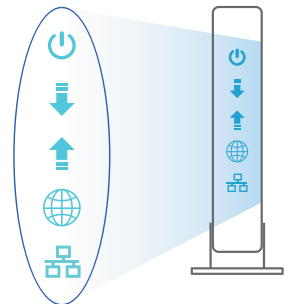

Configurer votre routeur ROG

Vous pouvez configurer votre routeur ROG via une connexion filaire ou Wi-Fi.

A. Connexion filaire

1. Branchez le routeur sur une prise électrique, puis allumez-le. Utilisez le câble réseau pour relier votre ordinateur au port réseau local (LAN) du routeur.

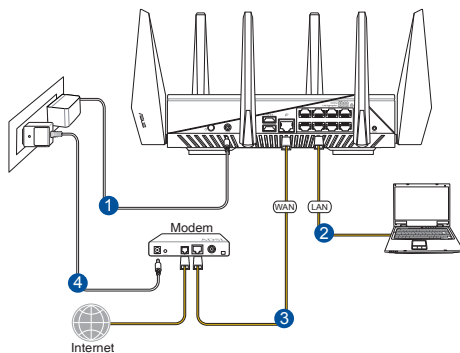

2. L'interface de gestion du routeur s'affiche automatiquement lors de l'ouverture de votre navigateur internet. Si ce n'est pas le cas, entrez <http://router.asus.com> dans la barre d'adresse.
3. Définissez un mot de passe afin d'éviter les accès non autorisés au routeur.

Login Information Setup

Change the router password to prevent unauthorized access to your ASUS wireless router.

Router Login Name	<input type="text" value="admin"/>
New Password	<input type="password"/>
Retype Password	<input type="password"/> <input type="checkbox"/> Show password

B. Connexion Wi-Fi

1. Branchez le routeur sur une prise électrique, puis allumez-le.

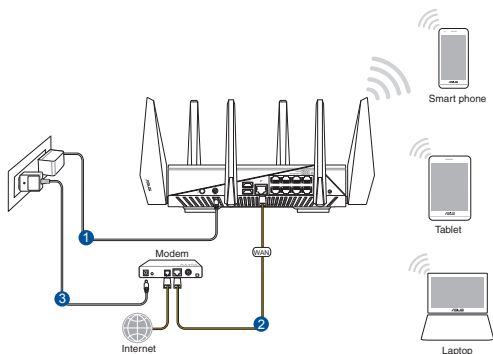

2. Connectez-vous au réseau dont le nom (SSID) est affiché sur l'étiquette du produit située à l'arrière du routeur. Pour garantir une plus grande sécurité, modifiez le nom du réseau et le mot de passe.



Nom du réseau Wi-Fi de 2,4 G (SSID) :	ASUS_XX_2G
---------------------------------------	------------

Nom du réseau Wi-Fi de 5 G-1 (SSID) :	ASUS_XX_5G
---------------------------------------	------------

Nom du réseau Wi-Fi de 5 G-2 (SSID) :	ASUS_XX_5G_Gaming
---------------------------------------	-------------------

* **XX** correspond aux deux derniers chiffres de l'adresse MAC 2,4 GHz. Vous pouvez les trouver sur l'étiquette située à l'arrière de votre routeur ROG.

3. Une fois connecté, l'interface de gestion du routeur s'affiche automatiquement lors de l'ouverture de votre navigateur internet. Si ce n'est pas le cas, entrez <http://router.asus.com> dans la barre d'adresse.
4. Définissez un mot de passe afin d'éviter les accès non autorisés au routeur.

Login Information Setup

Change the router password to prevent unauthorized access to your ASUS wireless router.

Router Login Name: admin

New Password: [Empty field]

Retype Password: [Empty field] Show password

Se rappeler des paramètres de votre routeur Wi-Fi

- Notez les paramètres Wi-Fi choisis lors de la configuration de votre routeur.

Nom du routeur :	Mot de passe :
Nom du réseau de 2,4 GHz (SSID) :	Mot de passe :
Nom du réseau de 5 GHz-1 (SSID) :	Mot de passe :
Nom du réseau de 5 GHz-2 (SSID) :	Mot de passe :

FAQ

1. Où puis-je obtenir plus d'informations sur le routeur Wi-Fi ?
 - FAQ en ligne : <http://support.asus.com/faq>
 - Site de support technique : <http://support.asus.com>
 - Service clientèle : Consultez la liste des centres d'appel ASUS en fin de guide

Pakkauksen sisältö

- ☑ ROG GT-AC5300
- ☑ Verkkolaite
- ☑ Pikaopas
- ☑ 8* langaton antenni
- ☑ Verkkoakapeli (RJ-45)



HUOMAA: Jos jokin nimike puuttuu tai on vahingoittunut, ota yhteys jälleenmyyjään.

Katsaus sovellukseen

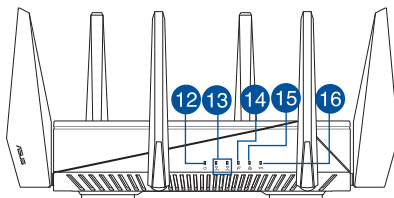
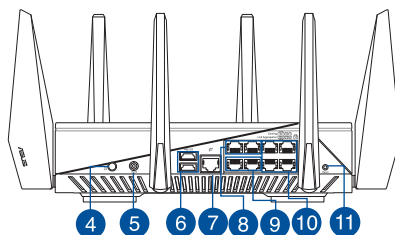
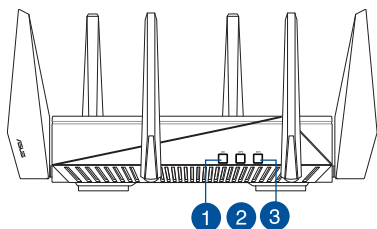

1. LED päälle/pois -painike	9. Linkkikooste (LAN 5-6)
2. WPS-painike	10. LAN portit
3. Wi-Fi päälle/pois -painike	11. Nollauspainike
4. Virta painike	12. Virran LED-valo
5. Virta (DC-In)-portti	13. 2,4 GHz / 5 GHz Wi-Fi-LED
6. USB 3.0 -portti	14. WAN (internet)-LED
7. WAN (internet) -portti	15. LAN-LED
8. Pelaamisportit (LAN1-2)	16. WPS-LED

Modeemin valmistelu

1. Irrota virtakaapeli/DSL-modeemi. Jos sillä on akkuvarmistus, irrota akku.

HUOMAUTUS: Jos käytät internet-yhteyteen DSL:ää, tarvitset käyttäjätunnuksen/salasanan internet-palveluntarjoajaltasi (ISP) määrittääksesi reitittimen oikein.

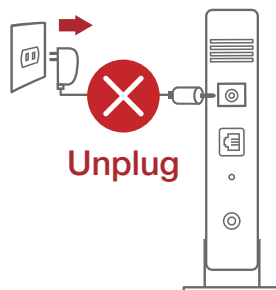

2. Liitä modeemi reitittimeen toimitukseen kuuluvalla verkkokaapelilla.

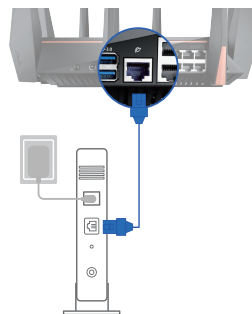

3. Kytke virta päälle virtakaapeliin/DSL-modeemiin.
4. Tarkista kaapelin/DSL-modeemin LED-valot varmistaaksesi, että yhteys on aktiivinen.

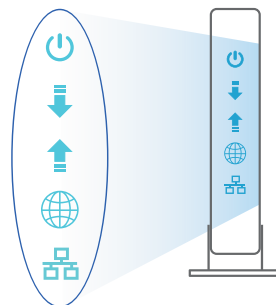

GT-AC5300 :n asettaminen

Voit asettaa reitittimen langallisen tai langattoman yhteyden kautta.

A. Langallinen yhteys

1. Liitä reititin virtalähteeseen ja kytke sen virta päälle. Liitä verkkokaapeli tietokoneesta reitittimen LAN-porttiin.

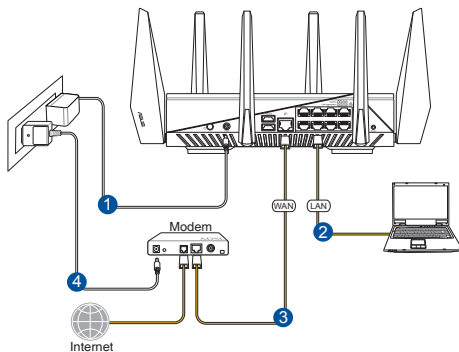

2. Graafinen web-käyttöliittymä käynnistyy automaattisesti, kun avaat web-selaimen. Jolle se käynnistyy automaattisesti, siirry osoitteeseen <http://router.asus.com>.
3. Aseta reitittimen salasana estääksesi valtuuttamattoman käytön.

Login Information Setup

Change the router password to prevent unauthorized access to your ASUS wireless router.

Router Login Name	admin
New Password	
Retype Password	

Show password

B. Langaton yhteys

1. Liitä reititin virtalähteeseen ja kytke sen virta päälle.

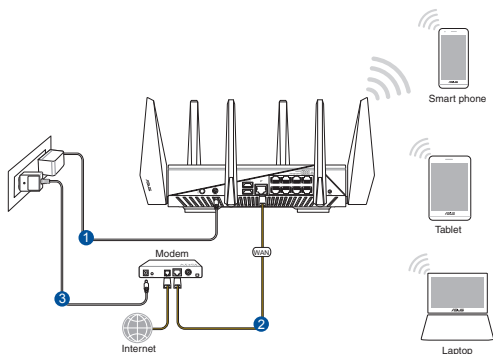

2. Koble til nettverksnavnet (SSID) som står etiketten på baksiden av ruter. Nettverkssikkerheten kan forbedres ved at du bytter SSID og velger et passord.



2,4 G Wi-Fi-nimi (SSID):	ASUS_XX_2G
5 G-1 Wi-Fi-nimi (SSID):	ASUS_XX_5G
5 G-2 Wi-Fi-nimi (SSID):	ASUS_XX_5G_Gaming

* **XX** viittaa 2,4 GHz:in MAC-osoitteen kahteen viimeiseen numeroon. Se on merkitty tarraan GT-AC5300:n takana.

- Kun liitäntä on tehty, graafinen web-käyttöliittymä käynnistyy automaattisesti, kun avaat web-selaimen. Jos se ei käynnisty automaattisesti, siirry osoitteeseen <http://router.asus.com>.**
- Aseta reitittimelle salasana valtuuttamattoman käytön estämiseksi.**

Login Information Setup

Change the router password to prevent unauthorized access to your ASUS wireless router.

Router Login Name:

New Password:

Retype Password: Show password

Langattoman reitittimen asetusten muistaminen

- Muista langattomat asetukset, kun suoritat reitittimen asetuksen loppuun.**

Reitittimen nimi:	Salasana:
2.4GHz verkko SSID:	Salasana:
5GHz-1 verkko SSID:	Salasana:
5GHz-2 verkko SSID:	Salasana:

Usein kysyttyä (FAQ)

- Mistä saan lisätietoja langattomasta reitittimestä?
 - Online-usein kysyttyä-sivusto: <http://support-org.asus.com/faq>
 - Teknisen tuen sivusto: <http://support-org.asus.com/>
 - Tukipalvelunumero: Katso tukipalvelunumero kohdasta Supplementary Guide (Lisäopas).

Verpackungsinhalt

- ☑ ROG GT-AC5300 WLAN-Router
- ☑ Netzteil
- ☑ Schnellstartanleitung
- ☑ 8 x WLAN-Antennen
- ☑ Netzwerkkabel (RJ-45)



HINWEIS: Falls ein Teil fehlt oder beschädigt ist, kontaktieren Sie bitte umgehend Ihren Händler.

Ihr ROG Router auf einen Blick

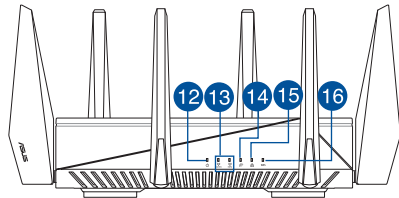
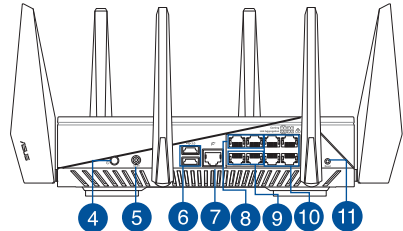
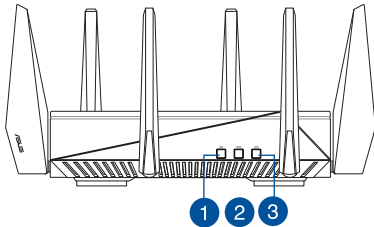

1. LED Ein-/Austaste	9. Ethernet-Kanal-Bündelung (LAN 5~6)
2. WPS-Taste	10. LAN-Anschlüsse
3. WLAN Ein-/Austaste	11. Reset-Taste
4. Ein-/Austaste	12. Betriebs-LED
5. Netzanschluss (DC-In)	13. 2,4 GHz / 5 GHz WLAN-LED
6. USB 3.0-Ports	14. WAN-LED (Internet)
7. WAN-Anschluss (Internet)	15. LAN-LED
8. Gaming-Ports (LAN 1~2)	16. WPS-LED

Ihr Modem vorbereiten

1. **Trennen Sie das Netzkabel von der Steckdose und dem Kabel-/DSL-Modem. Falls Ihr Modem über einen Backup-Akku verfügt, entfernen Sie diesen ebenfalls.**

HINWEIS: Falls Sie für Ihre Internetverbindung DSL benutzen, benötigen Sie Ihren Benutzernamen/Kennwort von Ihrem Internetanbieter, um den Router richtig konfigurieren zu können.

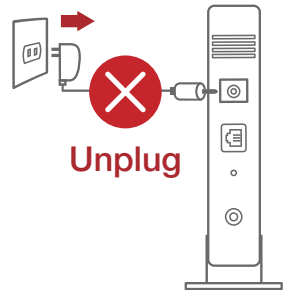

2. **Schließen Sie Ihr Modem mit dem mitgelieferten Netzkabel an den Router an.**

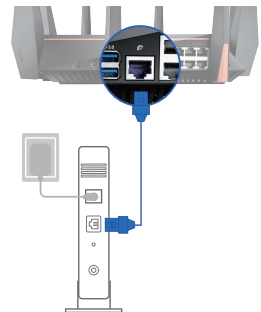

3. **Versorgen Sie Ihr Kabel-/DSL-Modem mit Strom und schalten es ein.**
4. **Überprüfen Sie die LED-Anzeigen Ihres Kabel-/DSL-Modems, um sicherzustellen, dass die Verbindung aktiv ist.**

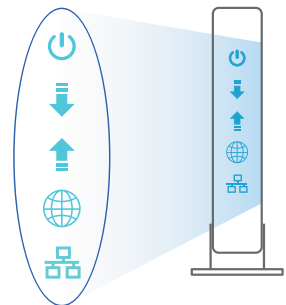

Ihren ROG Router einrichten

Sie können Ihren ROG Router über eine Kabelverbindung oder drahtlose Verbindung einrichten.

A. Kabelverbindung

1. Schließen Sie Ihren Router an eine Steckdose an und schalten Sie ihn ein. Schließen Sie das Netzwerkkabel von Ihrem Computer an einem LAN-Anschluss Ihres Routers an.

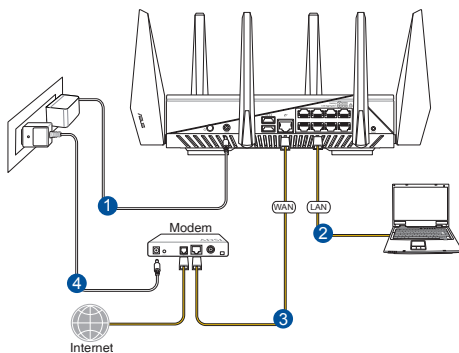

2. Die Web-Benutzeroberfläche wird automatisch gestartet, wenn Sie einen Webbrowser öffnen. Falls sie nicht automatisch geöffnet wird, geben Sie <http://router.asus.com> in den Webbrowser ein.
3. Richten Sie ein Kennwort für Ihren Router ein, um unbefugten Zugriff zu verhindern.

Login Information Setup

Change the router password to prevent unauthorized access to your ASUS wireless router.

Router Login Name	<input type="text" value="admin"/>	
New Password	<input type="password"/>	
Retype Password	<input type="password"/>	<input type="checkbox"/> Show password

B. Drahtlosverbindung

1. Schließen Sie Ihren Router an eine Steckdose an und schalten Sie ihn ein.

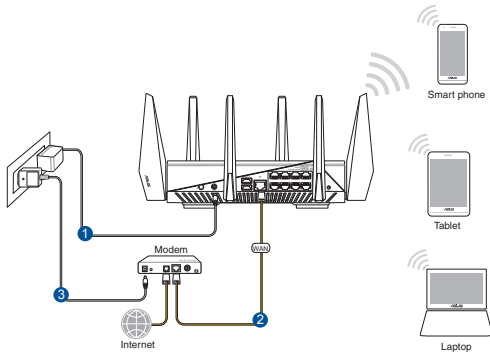

2. Verbinden Sie sich mit dem Netzwerknamen (SSID), der auf dem Produktaufkleber auf der Rückseite des Routers angegeben ist. Ändern Sie zur Erhöhung der Netzwerksicherheit den Netzwerknamen in eine eindeutige SSID um und weisen Sie ein Kennwort zu.



2,4G WLAN-Name (SSID):	ASUS_XX_2G
5G-1 WLAN-Name (SSID):	ASUS_XX_5G
5G-2 WLAN-Name (SSID):	ASUS_XX_5G_Gaming

* **XX** bezieht sich auf die letzten zwei Ziffern der 2,4-GHz-MAC-Adresse. Sie finden sie auf dem Etikett auf der Rückseite Ihres ROG Routers.

3. Sobald die Verbindung hergestellt ist, wird die Web-Benutzeroberfläche automatisch gestartet, wenn Sie einen Webbrowser öffnen. Falls sie nicht automatisch geöffnet wird, geben Sie <http://router.asus.com> in den Webbrowser ein.
4. Richten Sie ein Kennwort für Ihren Router ein, um unbefugten Zugriff zu verhindern.

Login Information Setup

Change the router password to prevent unauthorized access to your ASUS wireless router.

Router Login Name

New Password

Retype Password Show password

Notieren der WLAN-Einstellungen Ihres Routers

- Notieren Sie Ihre WLAN-Einstellungen, nachdem Sie die Einrichtung des Routers fertiggestellt haben.

Router-Name:	Kennwort:
2,4 GHz Netzwerk SSID:	Kennwort:
5 GHz-1 Netzwerk SSID:	Kennwort:
5 GHz-2 Netzwerk SSID:	Kennwort:

FAQ (Häufig gestellte Fragen)

1. Wo finde ich weitere Informationen zum WLAN-Router?
 - Webseite für häufig gestellte Fragen: <http://support.asus.com/faq>
 - Webseite für technischen Support: <http://support.asus.com>
 - Kunden-Hotline: Schauen Sie im Abschnitt über die Support-Hotline in dieser Schnellstartanleitung

Περιεχόμενα συσκευασίας

- ☑️ ROG GT-AC5300
- ☑️ 8 * ασύρματες κεραίες
- ☑️ Μετασχηματιστής ρεύματος
- ☑️ Καλωδιακού δικτύου (RJ-45)
- ☑️ Οδηγός Γρήγορης Έναρξης



ΣΗΜΕΙΩΣΕΙΣ: Εάν απουσιάζει ή εμφανίζεται βλάβη οποιοδήποτε από τα στοιχεία, επικοινωνήστε με το κατάστημα λιανικής πώλησης.

Μια γρήγορη ματιά στο

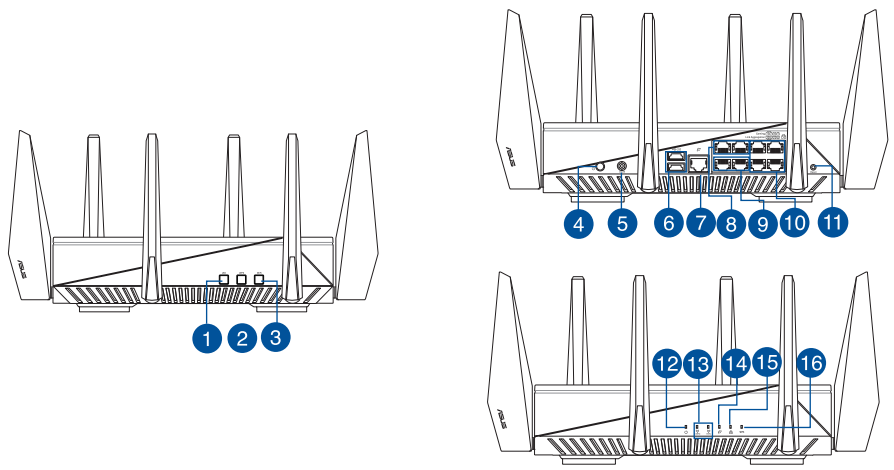

1. Πλήκτρο ενεργ./ απενεργ. LED	9. Ομαδοποίηση συνδέσμων (LAN 5~6)
2. WPS κουμπί	10. LAN Θύρες
3. Πλήκτρο ενεργ./ απενεργ. Wi-Fi	11. Κουμπί επαναφοράς
4. Πλήκτρο ισχύος	12. Λυχνία LED Τροφοδοσίας
5. Είσοδος τροφοδοσίας ρεύματος (DC-IN)	13. Λυχνία LED 2,4GHz / 5GHz Wi-Fi
6. Θύρες USB 3.0	14. WAN (Internet) LED
7. Θύρα WAN (Internet)	15. LAN LED
8. Θύρες παιχνιδιών (LAN1~2)	16. WPS LED

Προετοιμάστε το μόντεμ σας

1. Αποσυνδέστε το καλώδιο τροφοδοσίας/μόντεμ DSL. Αν διαθέτει εφεδρική μπαταρία, αφαιρέστε τη μπαταρία.

ΣΗΜΕΙΩΣΗ: Αν χρησιμοποιείτε DSL για το Internet, θα χρειαστείτε το όνομα χρήστη/κωδικό πρόσβασης από τον πάροχο υπηρεσιών Internet (ISP) για τη σωστή διαμόρφωση του δρομολογητή.

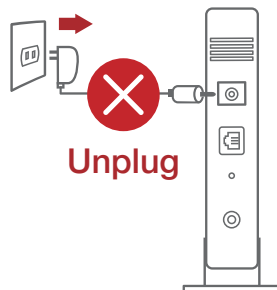

2. Συνδέστε το μόντεμ στον δρομολογητή με το παρεχόμενο καλώδιο δικτύου.

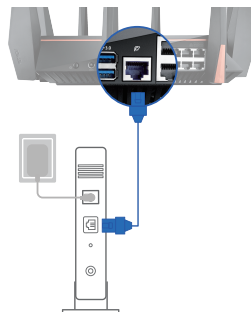

3. Ενεργοποιήστε το καλώδιο/μόντεμ DSL.
4. Ελέγξτε τις λυχνίες LED του καλωδίου/μόντεμ DSL για να βεβαιωθείτε ότι η σύνδεση είναι ενεργή.

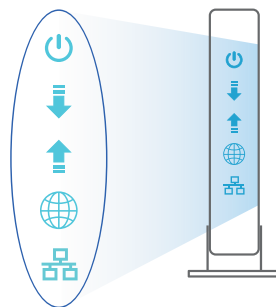

Εγκατάσταση του

Μπορείτε να ρυθμίσετε το δρομολογητή μέσω ενσύρματης ή ασύρματης σύνδεσης.

A. Ενσύρματη σύνδεση:

1. Συνδέστε τον δρομολογητή σας σε μια πρίζα και ενεργοποιήστε τον. Συνδέστε το καλώδιο δικτύου του υπολογιστή σας σε μία θύρα LAN του δρομολογητή.

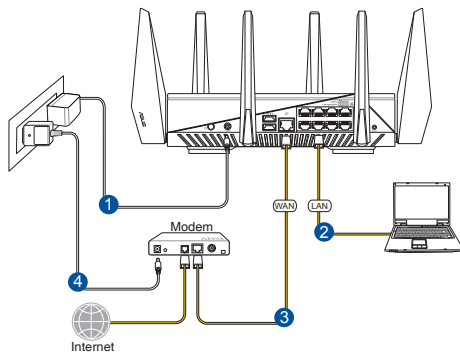

2. Η διεπαφή μέσω διαδικτύου (GUI) εκκινεί αυτόματα όταν ανοίξετε την εφαρμογή περιήγησης στο διαδίκτυο. Σε περίπτωση που δεν εκκινήσει αυτόματα, πληκτρολογήστε <http://router.asus.com>.
3. Ορίστε έναν κωδικό πρόσβασης για το δρομολογητή για πρόληψη από μη εξουσιοδοτημένη πρόσβαση.

Login Information Setup

Change the router password to prevent unauthorized access to your ASUS wireless router.

Router Login Name	<input type="text" value="admin"/>
New Password	<input type="password"/>
Retype Password	<input type="password"/>

Show password

B. Ασύρματη σύνδεση

1. Συνδέστε τον δρομολογητή σας σε μια πρίζα και ενεργοποιήστε τον.

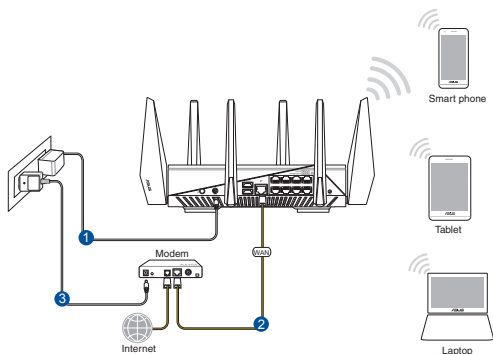

2. Συνδεθείτε στο όνομα δικτύου (SSID) που εμφανίζεται στην ετικέτα προϊόντος στην πίσω πλευρά του δρομολογητή. Για μεγαλύτερη ασφάλεια δικτύου, αλλάξτε σε ένα μοναδικό SSID και εκχωρήστε έναν κωδικό πρόσβασης.



2,4G Wi-Fi Όνομα (SSID):	ASUS_XX_2G
5G-1 Wi-Fi Όνομα (SSID):	ASUS_XX_5G
5G-2 Wi-Fi Όνομα (SSID):	ASUS_XX_5G_Gaming

* Το **XX** αναφέρεται στα δυο τελευταία ψηφία μιας διεύθυνσης 2,4GHz MAC. Μπορείτε να το βρείτε στην ετικέτα στο πίσω μέρος του.

- Μόλις συνδεθείτε η διεπαφή μέσω διαδικτύου (GUI) εκκινεί αυτόματα όταν ανοίξετε την εφαρμογή περιήγησης στο διαδίκτυο. Σε περίπτωση που δεν εκκινήσει αυτόματα, πληκτρολογήστε <http://router.asus.com>.
- Ορίστε έναν κωδικό πρόσβασης για το δρομολογητή για πρόληψη από μη εξουσιοδοτημένη πρόσβαση.

Login Information Setup

Change the router password to prevent unauthorized access to your ASUS wireless router.

Router Login Name:

New Password:

Retype Password: Show password

Πώς να θυμάστε τις ρυθμίσεις του ασύρματου δρομολογητή

- Σημειώστε τις ασύρματες ρυθμίσεις όταν ολοκληρώσετε την εγκατάσταση του δρομολογητή.

Όνομα δρομολογητή:	Κωδικός πρόσβασης:
2.4GHz δίκτυο SSID:	Κωδικός πρόσβασης:
5GHz-1 δίκτυο SSID:	Κωδικός πρόσβασης:
5GHz-2 δίκτυο SSID:	Κωδικός πρόσβασης:

Συχνές ερωτήσεις (FAQ)

- Πού μπορώ να βρω περισσότερες πληροφορίες για τον ασύρματο δρομολογητή;
 - Ιστότοπος συχνών ερωτήσεων/απαντήσεων: <http://support.asus.com/faq>
 - Ιστότοπος τεχνικής υποστήριξης: <http://support.asus.com>
 - Γραμμή άμεσης υποστήριξης πελατών: Ανατρέξτε στην ενότητα Γραμμή άμεσης υποστήριξης σε αυτόν τον Οδηγό Γρήγορης Έναρξης.

Contenuto della confezione

- ☑ Router wireless ROG GT-AC5300
- ☑ Adattatore AC
- ☑ Guida rapida
- ☑ 8 x Antenne wireless
- ☑ Cavo di rete Ethernet (RJ-45)



NOTA: Contatta il tuo rivenditore nel caso in cui uno di questi articoli sia danneggiato o mancante.

Aspetto del router ROG

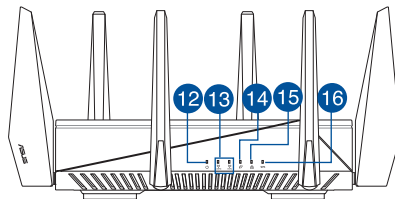
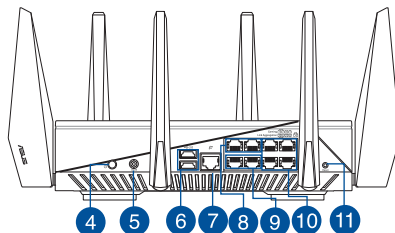
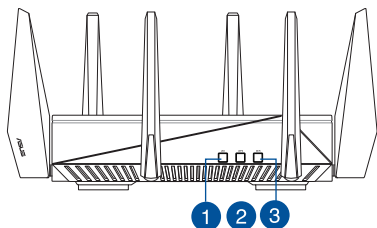

1. Pulsante retroilluminazione	9. Link aggregation (LAN 5~6)
2. Pulsante WPS	10. Porte LAN
3. Pulsante Wi-Fi	11. Pulsante di reset
4. Pulsante di accensione/spengimento	12. LED alimentazione
5. Porta ingresso alimentazione (DC-IN)	13. LED Wi-Fi 2.4GHz / 5GHz
6. Porte USB 3.0	14. LED Internet (WAN)
7. Porta Internet (WAN)	15. LED LAN
8. Porte gaming (LAN 1~2)	16. LED WPS

Preparazione del modem

1. **Scollega il cavo di alimentazione/modem DSL. Se è presente una batteria di backup, rimuovila.**

NOTA: Se usi la linea DSL per Internet hai bisogno di nome utente e password forniti dal tuo ISP (Internet Service Provider) per configurare il router correttamente.

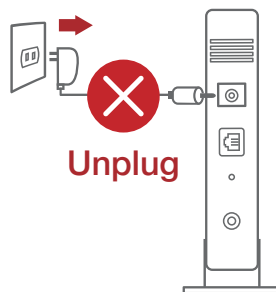

2. **Collega il tuo modem al router usando il cavo di rete in dotazione.**

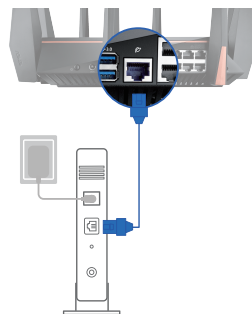

3. **Accendi il tuo modem DSL/cavo.**
4. **Controlla i LED sul tuo model DSL/cavo per verificare che la connessione sia attiva.**

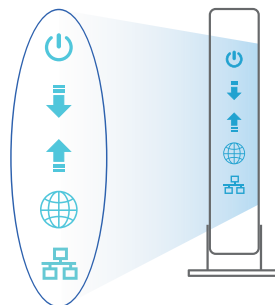

Configurazione del router ROG

Puoi configurare il router ROG tramite connessione cablata o senza fili.

A. Connessione a reti cablate

1. Collega il router ad una presa di corrente e accendilo. Collega un cavo di rete dal tuo computer ad una porta LAN del router.

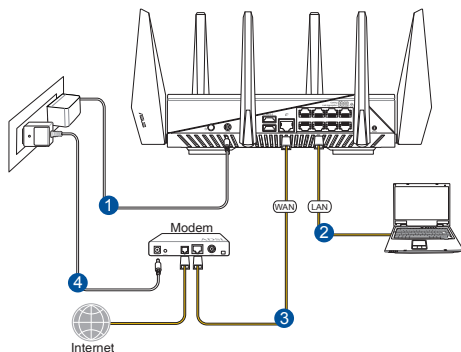

2. L'interfaccia web (GUI) si avvia automaticamente quando apri un browser web. In caso contrario inserisci <http://router.asus.com> nella barra degli indirizzi
3. Imposta una password per il tuo router per prevenire accessi non autorizzati.

Login Information Setup

Change the router password to prevent unauthorized access to your ASUS wireless router.

Router Login Name	<input type="text" value="admin"/>
New Password	<input type="password"/>
Retype Password	<input type="password"/> <input type="checkbox"/> Show password

B. Connessione a reti senza fili

1. Collega il router ad una presa di corrente e accendilo.

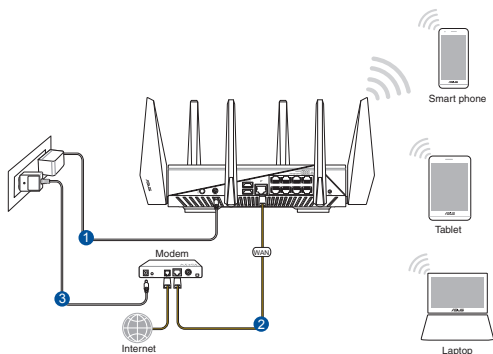

2. Stabilisci la connessione alla rete senza fili con il nome (SSID) che trovi sull'etichetta nella parte posteriore del router. Per una migliore sicurezza di rete modifica il SSID inserendo un nome unico e assegna una password.



Nome Wi-Fi 2.4G (SSID):	ASUS_XX_2G
Nome Wi-Fi 5G-1 (SSID):	ASUS_XX_5G
Nome Wi-Fi 5G-2 (SSID):	ASUS_XX_5G_Gaming

* **XX** corrisponde alle ultime due cifre dell'indirizzo MAC 2.4GHz. Puoi trovare l'indirizzo sull'etichetta nel retro del router ROG.

3. Una volta eseguita la connessione l'interfaccia web (GUI) si avvia automaticamente quando apri un browser web. In caso contrario inserisci <http://router.asus.com> nella barra degli indirizzi.
4. Imposta una password per il tuo router per prevenire accessi non autorizzati.

Login Information Setup

Change the router password to prevent unauthorized access to your ASUS wireless router.

Router Login Name:

New Password:

Retype Password: Show password

Prendi nota delle impostazioni del router wireless

- Prendi nota delle impostazioni wireless dopo aver completato la configurazione.

Nome router:	Password:
SSID rete 2.4 GHz:	Password:
SSID rete 5GHz-1:	Password:
SSID rete 5GHz-2:	Password:

FAQ

1. Dove posso trovare ulteriori informazioni sul mio router wireless?
 - Sito web delle FAQ: <http://support.asus.com/faq>
 - Sito del supporto tecnico: <http://www.asus.com/it/support>
 - Hotline del servizio clienti: fai riferimento alla sezione Supporto Hotline di questa guida rapida

Innhold i pakken

- ☑ GT-AC5300
- ☑ AC-adapter
- ☑ Hurtigstartguide
- ☑ 8 stk. trådløse antenner
- ☑ Nettverkskabel (RJ-45)



MERK: Hvis noen av elementene mangler eller er skadet, kontakt forhandleren din.

En rask kikk på GT-AC5300

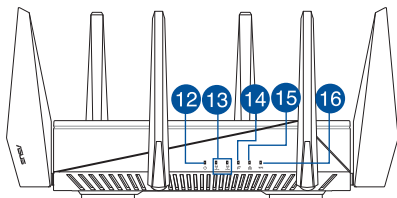
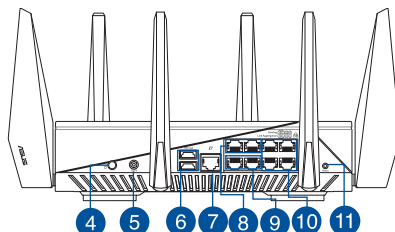
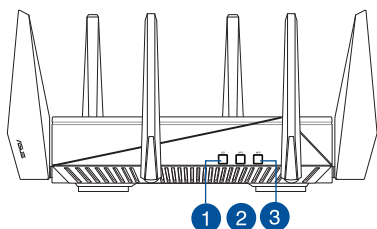

1. LED av/på-knapp	9. Link Aggregation (LAN 5–6)
2. WPS-knapp	10. LAN porter
3. Wi-Fi av/på-knapp	11. Reset (Nullstill)-knapp
4. Strømbryter	12. Strøm LED
5. Strømport (DC)	13. 2,4 GHz / 5 GHz Wi-Fi-LED-lampe
6. USB 3.0-porter	14. LED-lampe for WAN (Internett)
7. WAN-port (Internett)	15. LAN LED
8. Spillporter (LAN 1–2)	16. WPS LED

Forbereder modemmet

1. Koble kabel-/DSL-modemet fra strømmen. Hvis det har et reservebatteri, tar du det ut.

MERK: Hvis du bruker DSL-Internett, trenger du brukernavn/passord fra Internettleverandøren for å konfigurere ruterens.

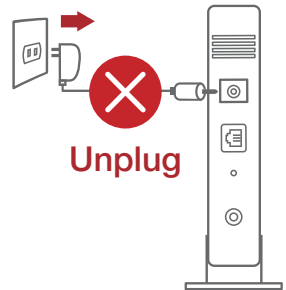

2. Koble modemmet til ruterens med den medfølgende nettverkskabelen.

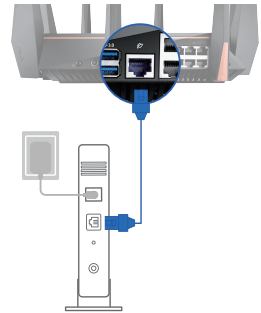

3. Slå på kabel-/DSL-modemet.
4. Se LED-lampen på kabel-/DSL-modemet for å kontrollere at forbindelsen er aktiv.

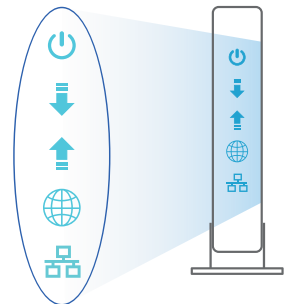

Sette opp GT-AC5300

Du kan sette opp ruteren via kablet eller trådløs tilkobling.

A. Kablet tilkobling

1. Koble ruterens stikkontakt til stikkontakt, og slå den på. Koble nettverkskabelen fra datamaskinen til en LAN-port på ruterens.

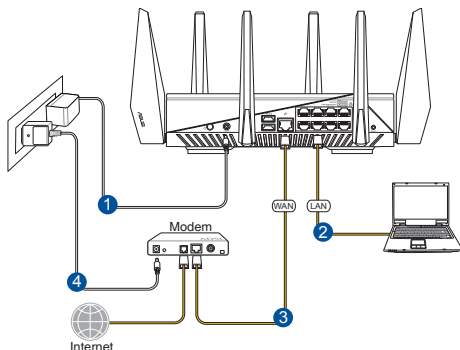

2. Web-grensesnittet startes automatisk når du åpner en nettleser. Hvis ikke, kan du gå til <http://router.asus.com>.
3. Sett opp et passord på ruterens for å hindre uautorisert tilgang.

Login Information Setup

Change the router password to prevent unauthorized access to your ASUS wireless router.

Router Login Name	<input type="text" value="admin"/>
New Password	<input type="password"/>
Retype Password	<input type="password"/>

Show password

B. Trådløs tilkobling

1. Koble ruterer til stikkontakt, og slå den på.

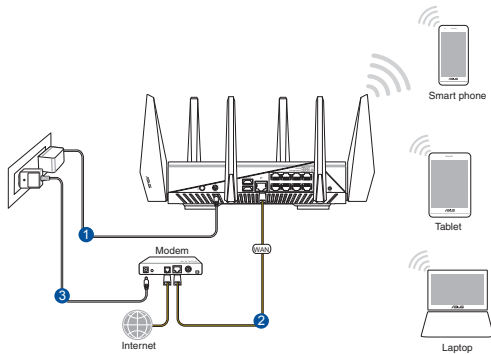

2. Koble til nettverksnavnet (SSID) som står etiketten på baksiden av ruterer. Nettverkssikkerheten kan forbedres ved at du bytter SSID og velger et passord.



2,4 GHz Wi-Fi-navn (SSID):	ASUS_XX_2G
5GHz-1 Wi-Fi-navn (SSID):	ASUS_XX_5G
5GHz-2 Wi-Fi-navn (SSID):	ASUS_XX_5G_Gaming

* **XX** refererer til de to siste sifrene i 2,4 GHz-MAC-adressen. Du finner det på etiketten på baksiden av GT-AC5300.

3. Når du er tilkoblet, startes web-grensesnittet automatisk når du åpner en nettleser. Hvis ikke, kan du gå til <http://router.asus.com>.
4. Sett opp et passord på ruterer for å hindre uautorisert tilgang.

Login Information Setup

Change the router password to prevent unauthorized access to your ASUS wireless router.

Router Login Name:

New Password:

Retype Password: Show password

Huske innstillinger for den trådløse ruterer

- Husk de trådløse innstillingene du har utfører ruteroppsettet.

Ruternavn:	Passord:
2,4 GHz-nettverks-SSID:	Passord:
5GHz-1-nettverks-SSID:	Passord:
5GHz-2-nettverks-SSID:	Passord:

Spørsmål og svar

1. Hvor kan jeg finne mer informasjon om den trådløse ruterer?
 - Online side med spørsmål og svar: <http://support.asus.com/faq>
 - Side for teknisk støtte: <http://support.asus.com>
 - Kundehjelp: Henviss til støttetelefonnummeret i tilleggsguiden.

Conteúdo da embalagem

- ☑️ ROG GT-AC5300
- ☑️ Transformador
- ☑️ Guia de consulta rápida
- ☑️ 8 x antenas sem fios
- ☑️ Cabo de rede (RJ-45)



NOTA: Caso algum item esteja danificado ou em falta, contacte o seu revendedor.

Visão geral do seu router ROG

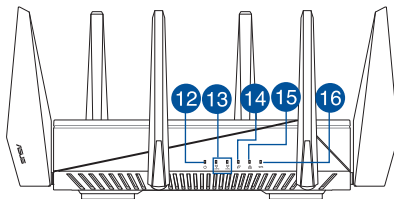
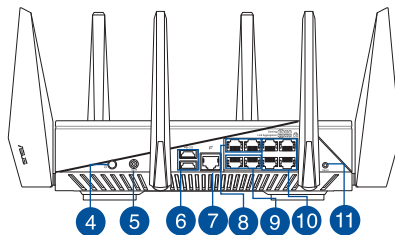
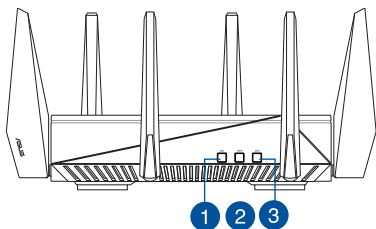

1. Botão Ligar/Desligar LED	9. Agregação de Ligações (LAN 5-6)
2. Botão WPS	10. Portas da LAN
3. Botão Ligar/Desligar Wi-Fi	11. Vypínaè
4. Botão Alimentação	12. LED de Alimentação
5. Porta de alimentação (Entrada DC)	13. LED 2.4GHz / 5GHz
6. Portas USB 3.0	14. Portas WAN (Internet)
7. Portas WAN (Internet)	15. LED da LAN
8. Portas de Jogo (LAN 1-2)	16. LED WPS

Preparar o modem

1. **Desligue o modem por cabo/DSL. Se o mesmo tiver uma bateria de reserva, remova-a.**

NOTE: Se estiver a utilizar uma ligação DSL para aceder à Internet, precisará dos dados de nome de utilizador/palavra-passe fornecidos pelo seu fornecedor de serviços de Internet (ISP) para configurar corretamente o seu router.

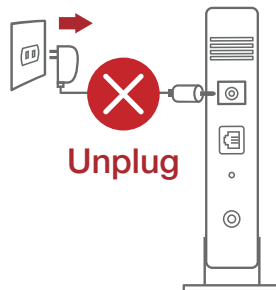

2. **Ligue o seu modem ao router com o cabo de rede fornecido.**

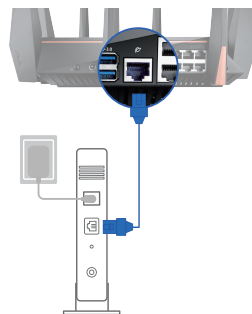

3. **Ligue o seu modem por cabo/DSL.**
4. **Verifique as luzes LED do modem por cabo/DSL para se certificar que a ligação está ativa.**

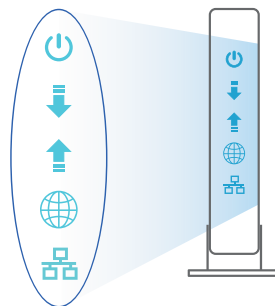

Configurar o router ROG

É possível configurar o router ROG através de uma ligação com ou sem fios.

A. Ligação com fios

1. Ligue o router a uma tomada elétrica e prima o botão de energia. Ligue o cabo de rede do computador a uma porta LAN do router.

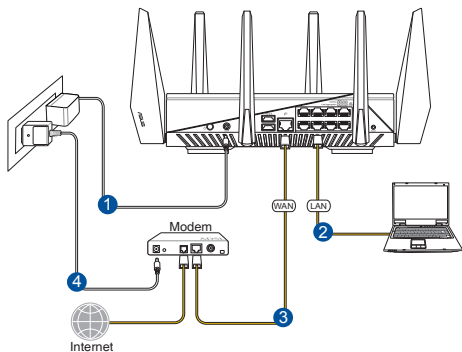

2. A interface web abre automaticamente quando abrir um navegador web. Se não abrir automaticamente, introduza <http://router.asus.com>
3. Configure uma palavra-passe para o seu router para impedir o acesso não autorizado.

Login Information Setup

Change the router password to prevent unauthorized access to your ASUS wireless router.

Router Login Name	<input type="text" value="admin"/>
New Password	<input type="password"/>
Retype Password	<input type="password"/>

Show password

B. Ligação sem fios

1. Ligue o router a uma tomada elétrica e prima o botão de energia.

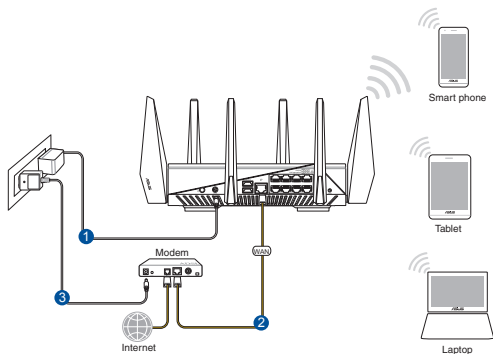

2. Connect to the network name(SSID) shown on the product label on the back side of the router. For better network security, change to a unique SSID and assign a password.



Nome da rede Wi-Fi 2,4G (SSID):	ASUS_XX_2G
Nome da rede Wi-Fi 5G-1 (SSID):	ASUS_XX_5G
Nome da rede Wi-Fi 5G-2 (SSID):	ASUS_XX_5G_Gaming

* **XX** refere-se aos dois últimos dígitos do endereço MAC 2,4GHz. Pode encontrar esse endereço na etiqueta na traseira do router ROG.

3. Após a ligação, a interface web irá abrir automaticamente quando abrir um navegador web. Se não abrir automaticamente, introduza <http://router.asus.com>.
4. Configure uma palavra-passe para o seu router para impedir o acesso não autorizado.

Login Information Setup

Change the router password to prevent unauthorized access to your ASUS wireless router.

Router Login Name:

New Password:

Retype Password: Show password

Memorizar as definições do seu router sem fios

- **Memorize as suas definições de ligação sem fios quando terminar a configuração do router.**

Nome do router::	palavra-passe:
SSID da rede 2,4 GHz:	palavra-passe:
SSID da rede 5GHz-1:	palavra-passe:
SSID da rede 5GHz-2:	palavra-passe:

Perguntas Frequentes

1. Onde posso encontrar mais informações acerca do router sem fios?
 - Site de Perguntas Frequentes Online: <http://support.asus.com/faq>
 - Site de Apoio Técnico: <http://support.asus.com>
 - Linha de Apoio ao Cliente: Consulte a Linha de Apoio ao Cliente no Guia suplementar

Contenido del paquete

- ☑️ ROG GT-AC5300
- ☑️ AC adapter
- ☑️ Guía de inicio rápido
- ☑️ 8*antenas inalámbricas
- ☑️ Cable de red (RJ-45)



NOTA: Si alguno de los artículos falta o se encuentra dañado, póngase en contacto con su distribuidor.

Un vistazo rápido a su GT-AC5300

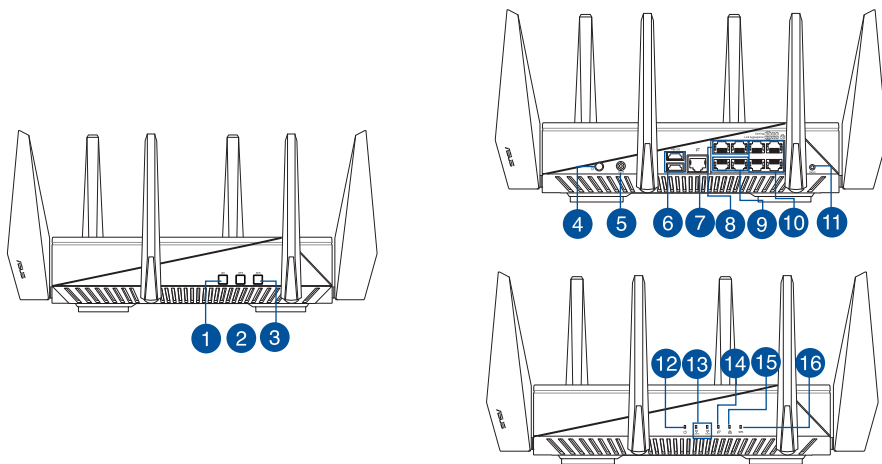

1. Botón Activar/Desactivar LED	9. Agregación de enlaces (LAN 5~6)
2. Botón WPS	10. LAN puertos
3. Botón Activar/Desactivar Wi-Fi	11. Botón Restablecer
4. Vypínaè	12. LED de alimentación
5. Puerto de alimentación (DC-IN)	13. LED de 2.4 GHz / 5GHz
6. USB 3.0 Puertos	14. WAN LED (Internet)
7. WAN (Internet) puertos	15. LED LAN
8. Puertos para juegos (LAN1~2)	16. LED WPS

Preparar el módem

1. **Desenchufe la alimentación del módem de cable o DSL. Si tiene una batería de reserva, quítela.**

NOTA: Si utiliza DSL para Internet, necesitará el nombre de usuario y la contraseña de su proveedor de servicio de Internet (ISP) para configurar adecuadamente el router.

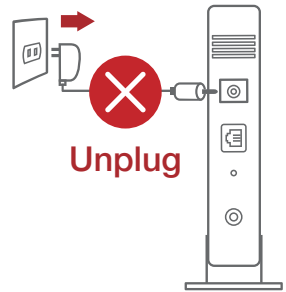

2. **Conecte el módem al router con el cable de red proporcionado.**

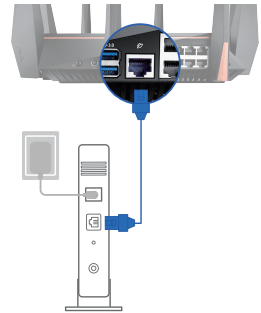

3. **Encienda su módem de cable o DSL.**
4. **Compruebe las luces de los LED del módem de cable o DLS para asegurarse de que la conexión está activa.**

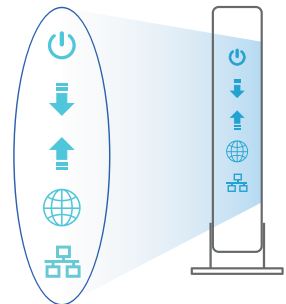

Configurar el router ROG

Puede configurar el router ROG a través de la conexión cableada o inalámbrica.

A. Conexión cableada

1. Enchufe el router a una toma de corriente eléctrica y enciéndalo. Conecte el cable de red desde el equipo a un puerto LAN del router.

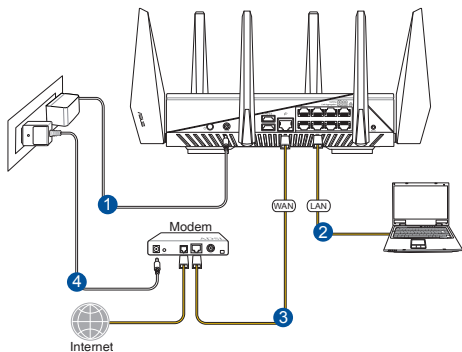

2. La GUI Web se inicia automáticamente cuando abre un explorador Web. Si no se inicia automáticamente, escriba <http://router.asus.com>.
3. Configure una contraseña para el router para evitar el acceso no autorizado.

Login Information Setup

Change the router password to prevent unauthorized access to your ASUS wireless router.

Router Login Name	<input type="text" value="admin"/>
New Password	<input type="password"/>
Retype Password	<input type="password"/>

Show password

B. Conexión inalámbrica

1. Enchufe el router a una toma de corriente eléctrica y enciéndalo.

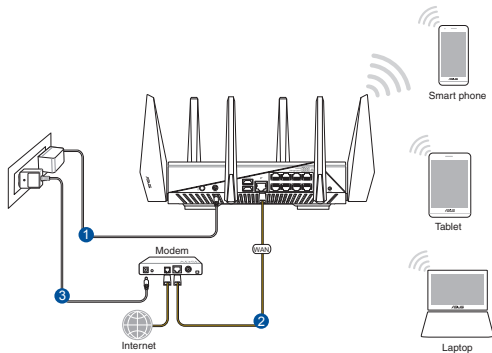

2. Conéctese al nombre de red (SSID) mostrado en la etiqueta del producto que se encuentra en la parte posterior del router. Para mejorar la seguridad de la red, cambie a un SSID único y asigne una contraseña.



Nombre Wi-Fi 2,4 GHz (SSID):	ASUS_XX_2G
Nombre Wi-Fi 5GHz-1 (SSID):	ASUS_XX_5G
Nombre Wi-Fi 5GHz-2 (SSID):	ASUS_XX_5G_Gaming

- * **XX** y hace referencia a los dos últimos dígitos de la dirección MAC de 2,4 GHz. Puede encontrarlo en la etiqueta situada en la parte posterior del router ROG.

3. La GUI Web se inicia automáticamente cuando abre un explorador Web. Si no se inicia automáticamente, escriba <http://router.asus.com>.
4. Configure una contraseña para el router para evitar el acceso no autorizado.

Login Information Setup

Change the router password to prevent unauthorized access to your ASUS wireless router.

Router Login Name:

New Password:

Retype Password: Show password

Recordar la configuración del router inalámbrico

- Recuerde la configuración inalámbrica cuando complete la configuración del router.

Nombre del router:	Contraseña:
SSID de red de 2,4 GHz:	Contraseña:
SSID de red de 5 GHz - 1:	Contraseña:
SSID de red de 5 GHz - 2:	Contraseña:

FAQ

1. ¿De qué otros recursos dispongo para obtener más información acerca del router inalámbrico?
 - El sitio web de preguntas más frecuentes: <http://support.asus.com/faq>
 - El sitio web de soporte técnico: <http://support.asus.com/>
 - Línea Directa: Consulte el número de la línea telefónica de soporte técnico en esta Guía de inicio rápido.

Förpackningens innehåll

- ☑ ROG GT-AC5300
- ☑ Nätadapter
- ☑ Snabbstartguide
- ☑ 8 * trådlösa antenner
- ☑ Nätverkskabel (RJ-45)



OBS: Om någon av posterna är skadade eller saknas, kontakta din återförsäljare.

En snabbtitt på din router

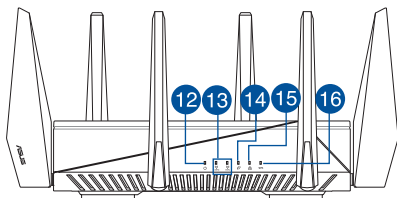
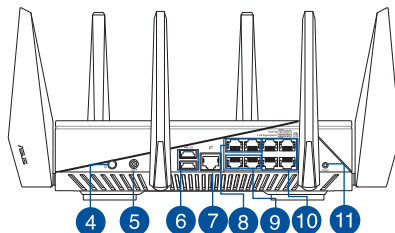
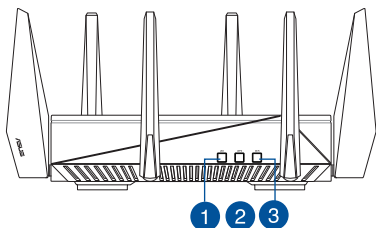

1. LED On/Off button	9. Länkkaggregering (LAN 5~6)
2. WPS knapp	10. LAN Portar
3. Wi-Fi-strömbrytare	11. Återställningsknapp
4. Strömbrytare	12. Strömlampa
5. Strömingång (DC-IN)	13. 2,4 GHz/5 GHz Wi-Fi-LED
6. USB 3.0-portar	14. WAN-LED (Internet)
7. WAN-port (Internet)	15. LAN LED
8. Spelportar (LAN1~2)	16. WPS LED

Förbered ditt modem

1. Koppla ur strömkabeln/DSL-modemet. Om den har ett reservbatteri, ta bort batteriet.

OBS: Om du använder DSL för Internet, kommer du att behöva ett användarnamn/lösenord från din Internet-leverantör (ISP) för att kunna konfigurera routern korrekt.

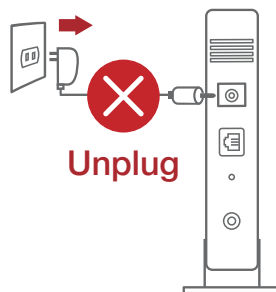

2. Anslut ditt modem till routern med den medföljande nätverkskabeln.

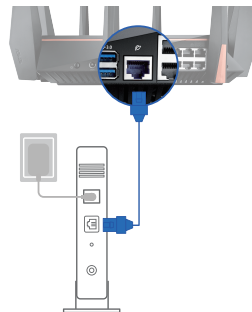

3. Slå på strömkabeln/DSL-modemet.
4. Kontrollera kabelns/DSL-modemets lysdioder för att försäkra dig om att anslutningen är aktiv.

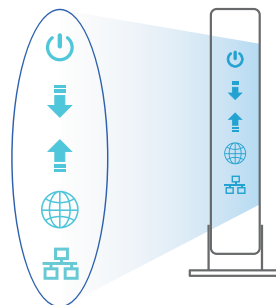

Inställning av router

Du kan ställa in din router via kabelanslutningen eller trådlös anslutning.

A. Kabelanslutning

1. Smerovač zapojte do elektrické zásuvky a zapnete ho. Sieťový kábel z počítača zapojte do portu LAN v smerovači.

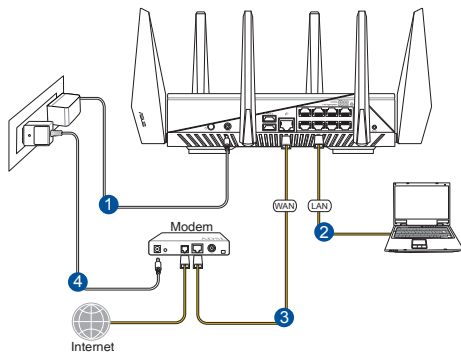

2. Webb GUI startar automatiskt när du öppnar en webbläsare. Om den inte startar automatiskt, öppna <http://router.asus.com>.
3. Ställ in ett lösenord för din router för att undvika obehörig åtkomst.

Login Information Setup

Change the router password to prevent unauthorized access to your ASUS wireless router.

Router Login Name	<input type="text" value="admin"/>
New Password	<input type="password"/>
Retype Password	<input type="password"/> <input type="checkbox"/> Show password

B. Trådlös anslutning

1. Smerovač zapojte do elektrickéj zásuvky a zapnite ho.

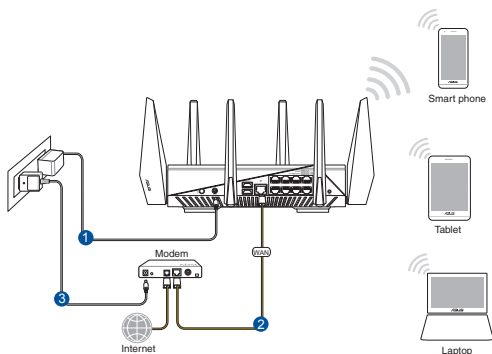

2. Anslut till nätverkets namn (SSID) som står på produktens etikett på baksidan av routern. För bättre nätverkssäkerhet, byt till ett unikt SSID och tilldela ett lösenord.



2,4 G Wi-Fi-namn (SSID):	ASUS_XX_2G
5 G-1 Wi-Fi-namn (SSID):	ASUS_XX_5G
5 G-2 Wi-Fi-namn (SSID):	ASUS_XX_5G_Gaming

* **XX** syftar på de två sista siffrorna på 2,4 GHz MAC-adress. Du kan hitta den på etiketten på baksidan av din ROG

3. När du är ansluten startar webb GUI automatiskt när du öppnar en webbläsare. Om den inte startar automatiskt, öppna <http://router.asus.com>.
4. Ställ in ett lösenord för din router för att undvika obehörig åtkomst.

Login Information Setup

Change the router password to prevent unauthorized access to your ASUS wireless router.

Router Login Name

New Password

Retype Password Show password

Kom ihåg dina trådlösa routerinställningar

- Kom ihåg dina trådlösa inställningar när du är klar med routerinställningen.

Routernamn:	lösenord:
2,4 GHz-nätverk SSID:	lösenord:
5 GHz-1-nätverk SSID:	lösenord:
5 GHz-2-nätverk SSID:	lösenord:

Vanliga frågor

1. Var kan jag hitta ytterligare information om den trådlösa routern?
 - Online FAQ webbplatsen: <http://support.asus.com/faq>
 - Teknisk support: <http://support.asus.com>
 - Kundhotline: Se support hotlineskärm bilderna i Supplementguiden.

ASUS Recycling/Takeback Services

ASUS recycling and takeback programs come from our commitment to the highest standards for protecting our environment. We believe in providing solutions for you to be able to responsibly recycle our products, batteries, other components, as well as the packaging materials. Please go to <http://csr.asus.com/english/Takeback.htm> for the detailed recycling information in different regions.

REACH

Complying with the REACH (Registration, Evaluation, Authorisation, and Restriction of Chemicals) regulatory framework, we published the chemical substances in our products at ASUS REACH website at <http://csr.asus.com/english/REACH.htm>

Federal Communications Commission Statement

This device complies with Part 15 of the FCC Rules. Operation is subject to the following two conditions:

- This device may not cause harmful interference.
- This device must accept any interference received, including interference that may cause undesired operation.

This equipment has been tested and found to comply with the limits for a class B digital device, pursuant to part 15 of the FCC Rules. These limits are designed to provide reasonable protection against harmful interference in a residential installation. This equipment generates, uses and can radiate radio frequency energy and, if not installed and used in accordance with the instructions, may cause harmful interference to radio communications. However, there is no guarantee that interference will not occur in a particular installation. If this equipment does cause harmful interference to radio or television reception, which can be determined by turning the equipment off and on, the user is encouraged to try to correct the interference by one or more of the following measures:

- Reorient or relocate the receiving antenna.
- Increase the separation between the equipment and receiver.
- Connect the equipment into an outlet on a circuit different from that to which the receiver is connected.
- Consult the dealer or an experienced radio/TV technician for help.



WARNING! Any changes or modifications not expressly approved by the party responsible for compliance could void the user's authority to operate the equipment.

Prohibition of Co-location

This device and its antenna(s) must not be co-located or operating in conjunction with any other antenna or transmitter.

IMPORTANT NOTE:

Radiation Exposure Statement: This equipment complies with FCC radiation exposure limits set forth for an uncontrolled environment. End users must follow the specific operating instructions for satisfying RF exposure compliance. To maintain compliance with FCC exposure compliance requirement, please follow operation instruction as documented in this manual.



WARNING! This equipment must be installed and operated in accordance with provided instructions and the antenna(s) used for this transmitter must be installed to provide a separation distance of at least 20 cm from all persons and must not be co-located or operating in conjunction with any other antenna or transmitter.

Compliance Statement of Innovation, Science and Economic Development Canada (ISED)

This device complies with Innovation, Science and Economic Development Canada licence exempt RSS standard(s). Operation is subject to the following two conditions: (1) this device may not cause interference, and (2) this device must accept any interference, including interference that may cause undesired operation of the device.

Operation in the band 5150–5250 MHz is only for indoor use to reduce the potential for harmful interference to co-channel mobile satellite systems.

CAN ICES-3(B)/NMB-3(B)

Radio Frequency (RF) Exposure Information

The radiated output power of the ASUS Wireless Device is below the Innovation, Science and Economic Development Canada radio frequency exposure limits. The ASUS Wireless Device should be used in such a manner such that the potential for human contact during normal operation is minimized.

This equipment should be installed and operated with a minimum distance of 20 cm between the radiator any part of your body.

This device has been certified for use in Canada. Status of the listing in the Innovation, Science and Economic Development Canada's REL (Radio Equipment List) can be found at the following web address:

http://www.ic.gc.ca/eic/site/ceb-bhst.nsf/eng/h_tt00020.html

Additional Canadian information on RF exposure also can be found at the following web:

<https://www.ic.gc.ca/eic/site/smt-gst.nsf/eng/sf08792.html>

Déclaration de conformité de Innovation, Sciences et Développement économique Canada (ISED)

Le présent appareil est conforme aux CNR d'Innovation, Sciences et Développement économique Canada applicables aux appareils radio exempts de licence. L'exploitation est autorisée aux deux conditions suivantes : (1) l'appareil ne doit pas produire de brouillage, et (2) l'utilisateur de l'appareil doit accepter tout brouillage radioélectrique subi, même si le brouillage est susceptible d'en compromettre le fonctionnement.

La bande 5150 – 5250 MHz est réservée uniquement pour une utilisation à l'intérieur afin de réduire les risques de brouillage préjudiciable aux systèmes de satellites mobiles utilisant les mêmes canaux.

CAN ICES-3(B)/NMB-3(B)

Informations concernant l'exposition aux fréquences radio (RF)

La puissance de sortie émise par cet appareil sans fil est inférieure à la limite d'exposition aux fréquences radio d'Innovation, Sciences et Développement économique du Canada (ISED). Utilisez l'appareil sans fil de façon à minimiser les contacts humains lors d'un fonctionnement normal.

Cet équipement doit être installé et utilisé avec un minimum de 20 cm de distance entre la source de rayonnement et votre corps.

L'utilisation de cet appareil est autorisée au Canada. Pour consulter l'entrée correspondant à l'appareil dans la liste d'équipement radio (REL - Radio Equipment List) d'Innovation, Sciences et Développement économique du Canada, rendez-vous sur :

http://www.ic.gc.ca/eic/site/ceb-bhst.nsf/eng/h_tt00020.html

Pour des informations supplémentaires concernant l'exposition aux fréquences radio au Canada, rendez-vous sur : <https://www.ic.gc.ca/eic/site/smt-gst.nsf/eng/sf08792.html>



Precautions for the use of the device

- a. Pay particular attention to the personal safety when use this device in airports, hospitals, gas stations and professional garages.
- b. Medical device interference: Maintain a minimum distance of at least 15 cm (6 inches) between implanted medical devices and ASUS products in order to reduce the risk of interference.
- c. Kindly use ASUS products in good reception conditions in order to minimize the radiation's level.
- d. Keep the device away from pregnant women and the lower abdomen of the teenager.

Précautions d'emploi de l'appareil

- a. Soyez particulièrement vigilant quant à votre sécurité lors de l'utilisation de cet appareil dans certains lieux (les avions, les aéroports, les hôpitaux, les stations-service et les garages professionnels).
- b. Évitez d'utiliser cet appareil à proximité de dispositifs médicaux implantés. Si vous portez un implant électronique (stimulateurs cardiaques, pompes à insuline, neurostimulateurs...), veuillez impérativement respecter une distance minimale de 15 centimètres entre cet appareil et votre corps pour réduire les risques d'interférence.
- c. Utilisez cet appareil dans de bonnes conditions de réception pour minimiser le niveau de rayonnement. Ce n'est pas toujours le cas dans certaines zones ou situations, notamment dans les parkings souterrains, dans les ascenseurs, en train ou en voiture ou tout simplement dans un secteur mal couvert par le réseau.
- d. Tenez cet appareil à distance des femmes enceintes et du bas-ventre des adolescents.

Условия эксплуатации:

- Температура эксплуатации устройства: 0-40 °С. Не используйте устройство в условиях экстремально высоких или низких температур.
- Не размещайте устройство вблизи источников тепла, например, рядом с микроволновой печью, духовым шкафом или радиатором.
- Использование несовместимого или несертифицированного адаптера питания может привести к возгоранию, взрыву и прочим опасным последствиям.
- При подключении к сети электропитания устройство следует располагать близко к розетке, к ней должен осуществляться беспрепятственный доступ.
- Утилизация устройства осуществляется в соответствии с местными законами и положениями. Устройство по окончании срока службы должны быть переданы в сертифицированный пункт сбора для вторичной переработки или правильной утилизации.
- Данное устройство не предназначено для детей. Дети могут пользоваться устройством только в присутствии взрослых.
- Не выбрасывайте устройство и его комплектующие вместе с обычными бытовыми отходами.



AEEE Yönetmeliğine Uygundur. IEEE Yönetmeliğine Uygundur.



- Bu Cihaz Türkiye analog şebekelerde çalışabilecek şekilde tasarlanmıştır.
- Cihazın ayrıntılı kurulum rehberi kutu içeriğinden çıkan CD içerisinde yer almaktadır. Cihazın kullanıcı arayüzü Türkçe'dir.
- Cihazın kullanılması planlanan ülkelerde herhangi bir kısıtlaması yoktur. Ülkeler simgeler halinde kutu üzerinde belirtilmiştir.

Manufacturer	ASUSTeK Computer Inc. Tel: +886-2-2894-3447 Address: 4F, No. 150, LI-TE RD., PEITOU, TAIPEI 112, TAIWAN
Authorised representative in Europe	ASUS Computer GmbH Address: HARKORT STR. 21-23, 40880 RATINGEN, GERMANY
Authorised distributors in Turkey	BOGAZICI BILGISAYAR TICARET VE SANAYI A.S. Tel./FAX No.: +90 212 331 10 00 / +90 212 332 28 90 Address: ESENTEPE MAH. BUYUKDERE CAD. ERCAN HAN B BLOK NO.121 SISLI, ISTANBUL 34394
	CIZGI Elektronik San. Tic. Ltd. Sti. Tel./FAX No.: +90 212 356 70 70 / +90 212 356 70 69 Address: GURSEL MAH. AKMAN SK.47B 1 KAGITHANE/ISTANBUL
	KOYUNCU ELEKTRONİK BİLGİ İŞLEM SİST. SAN. VE DİŞ TIC. A.S. Tel. No.: +90 216 5288888 Address: EMEK MAH.ORDU CAD. NO:18, SARIGAZI, SANCAKTEPE ISTANBUL
	ENDEKS BİLİŞİM SAN VE DİŞ TIC LTD ŞTİ Tel./FAX No.: +90 216 523 35 70 / +90 216 523 35 71 Address: NECİP FAZİL BULVARI, KEYAP CARSI SITESİ, G1 BLOK, NO:115 Y.DUDULLU, UMRANIYE, ISTANBUL
	PENTA TEKNOLOJİ URUNLERİ DAGITIM TICARET A.S Tel./FAX No.: +90 216 528 0000 Address: ORGANİZE SANAYİ BOLGESİ NATO YOLU 4.CADDE NO:1 UMRANIYE, ISTANBUL 34775

Networks Global Hotline Information

Area	Country/ Region	Hotline Number	Service Hours	
Europe	Cyprus	800-92491	09:00-13:00 ; 14:00-18:00 Mon-Fri	
	France	0033-170949400	09:00-18:00 Mon-Fri	
	Germany	0049-1805010920		
		0049-1805010923 (component support)		09:00-18:00 Mon-Fri 10:00-17:00 Mon-Fri
		0049-2102959911 (Fax)		
	Hungary	0036-15054561	09:00-17:30 Mon-Fri	
	Italy	199-400089	09:00-13:00 ; 14:00-18:00 Mon-Fri	
	Greece	00800-44142044	09:00-13:00 ; 14:00-18:00 Mon-Fri	
	Austria	0043-820240513	09:00-18:00 Mon-Fri	
	Netherlands/ Luxembourg	0031-591570290	09:00-17:00 Mon-Fri	
	Belgium	0032-78150231	09:00-17:00 Mon-Fri	
	Norway	0047-2316-2682	09:00-18:00 Mon-Fri	
	Sweden	0046-858769407	09:00-18:00 Mon-Fri	
	Finland	00358-969379690	10:00-19:00 Mon-Fri	
	Denmark	0045-38322943	09:00-18:00 Mon-Fri	
	Poland	0048-225718040	08:30-17:30 Mon-Fri	
	Spain	0034-902889688	09:00-18:00 Mon-Fri	
	Portugal	00351-707500310	09:00-18:00 Mon-Fri	
	Slovak Republic	00421-232162621	08:00-17:00 Mon-Fri	
	Czech Republic	00420-596766888	08:00-17:00 Mon-Fri	
	Switzerland-German	0041-848111010	09:00-18:00 Mon-Fri	
	Switzerland-French	0041-848111014	09:00-18:00 Mon-Fri	
	Switzerland-Italian	0041-848111012	09:00-18:00 Mon-Fri	
United Kingdom	0044-1442265548	09:00-17:00 Mon-Fri		
Ireland	0035-31890719918	09:00-17:00 Mon-Fri		
Russia and CIS	008-800-100-ASUS	09:00-18:00 Mon-Fri		
Ukraine	0038-0445457727	09:00-18:00 Mon-Fri		

Networks Global Hotline Information

Area	Country/ Region	Hotline Numbers	Service Hours
Asia-Pacific	Australia	1300-278788	09:00-18:00 Mon-Fri
	New Zealand	0800-278788	09:00-18:00 Mon-Fri
	Japan	0800-1232787	09:00-18:00 Mon-Fri
			09:00-17:00 Sat-Sun
		0081-570783886 (Non-Toll Free)	09:00-18:00 Mon-Fri
			09:00-17:00 Sat-Sun
	Korea	0082-215666868	09:30-17:00 Mon-Fri
	Thailand	0066-24011717 1800-8525201	09:00-18:00 Mon-Fri
	Singapore	0065-64157917 0065-67203835 (Repair Status Only)	11:00-19:00 Mon-Fri
			11:00-13:00 Sat
	Malaysia	1300-88-3495	9:00-18:00 Mon-Fri
	Philippine	1800-18550163	09:00-18:00 Mon-Fri
	India	1800-2090365	09:00-18:00 Mon-Sat
			09:00-21:00 Mon-Sun
	Indonesia	0062-2129495000 500128 (Local Only)	09:30-17:00 Mon-Fri
9:30 – 12:00 Sat			
Vietnam	1900-555581	08:00-12:00	
		13:30-17:30 Mon-Sat	
Hong Kong	00852-35824770	10:00-19:00 Mon-Sat	
Taiwan	0800-093-456; 02-81439000	9:00-12:00 Mon-Fri;	
		13:30-18:00 Mon-Fri	
Americas	USA		8:30-12:00 EST Mon-Fri
	Canada	1-812-282-2787	9:00-18:00 EST Sat-Sun
	Mexico	001-8008367847	08:00-20:00 CST Mon-Fri
			08:00-15:00 CST Sat
Brazil	4003 0988 (Capital) 0800 880 0988 (demais localidades)	9:00am-18:00 Mon-Fri	

Networks Global Hotline Information

Area	Country/ Region	Hotline Numbers	Service Hours
Middle East + Africa	Egypt	800-2787349	09:00-18:00 Sun-Thu
	Saudi Arabia	800-1212787	09:00-18:00 Sat-Wed
	UAE	00971-42958941	09:00-18:00 Sun-Thu
	Turkey	0090-2165243000	09:00-18:00 Mon-Fri
	South Africa	0861-278772	08:00-17:00 Mon-Fri
	Israel	*6557/00972-39142800 *9770/00972-35598555	08:00-17:00 Sun-Thu 08:30-17:30 Sun-Thu
Balkan Countries	Romania	0040-213301786	09:00-18:30 Mon-Fri
	Bosnia Herzegovina	00387-33773163	09:00-17:00 Mon-Fri
	Bulgaria	00359-70014411	09:30-18:30 Mon-Fri
		00359-29889170	09:30-18:00 Mon-Fri
	Croatia	00385-16401111	09:00-17:00 Mon-Fri
	Montenegro	00382-20608251	09:00-17:00 Mon-Fri
	Serbia	00381-112070677	09:00-17:00 Mon-Fri
		00368-59045400 00368-59045401	08:00-16:00 Mon-Fri
Baltic Countries	Estonia	00372-6671796	09:00-18:00 Mon-Fri
	Latvia	00371-67408838	09:00-18:00 Mon-Fri
	Lithuania-Kaunas	00370-37329000	09:00-18:00 Mon-Fri
	Lithuania-Vilnius	00370-522101160	09:00-18:00 Mon-Fri



NOTES:

- UK support e-mail: network_support_uk@asus.com
- For more information, visit the ASUS support site at: <https://www.asus.com/support/>

English

CE statement

Simplified EU Declaration of Conformity

ASUSTek Computer Inc. hereby declares that this device is in compliance with the essential requirements and other relevant provisions of Directive 2014/53/EU. Full text of EU declaration of conformity is available at https://www.asus.com/Networking/ROG-Rapture-GT-AC5300/HelpDesk_Declaration/.

Declaration of Conformity for Ecodesign directive 2009/125/EC

Testing for eco-design requirements according to (EC) No 1275/2008 and (EU) No 801/2013 has been conducted. When the device is in Networked Standby Mode, its I/O and network interface are in sleep mode and may not work properly. To wake up the device, press the Wi-Fi on/off, LED on/off, reset, or WPS button. This equipment complies with EU radiation exposure limits set forth for an uncontrolled environment. This equipment should be installed and operated with minimum distance 20 cm between the radiator & your body. All operational modes:

2.4GHz: 802.11b, 802.11g, 802.11n (HT20), 802.11n (HT40), 802.11ac (VHT20), 802.11ac (VHT40)
5GHz: 802.11a, 802.11n (HT20), 802.11n (HT40), 802.11ac (VHT20), 802.11ac (VHT40), 802.11ac (VHT80)

The frequency, mode and the maximum transmitted power in EU are listed below:

2412-2472MHz (802.11g 6 Mbps): 19.96 dBm
5180-5240MHz (802.11ac VHT20 MCS0): 22.97 dBm
5260-5320MHz (802.11ac VHT40 MCS0): 22.97 dBm
5500-5700MHz (802.11ac VHT80 MCS0): 29.98 dBm

The device is restricted to indoor use only when operating in the 5150 to 5350 MHz frequency range. The adapter shall be installed near the equipment and shall be easily accessible.

	AT	BE	BG	CZ	DK	EE	FR
	DE	IS	IE	IT	EL	ES	CY
	LV	LI	LT	LU	HU	MT	NL
	NO	PL	PT	RO	SI	SK	TR
	FI	SE	CH	UK	HR	UA	

Safety Notices

- Use this product in environments with ambient temperatures between 0°C(32°F) and 40°C(104°F).
- Refer to the rating label on the bottom of your product and ensure your power adapter complies with this rating.
- DO NOT place on uneven or unstable work surfaces. Seek servicing if the casing has been damaged.
- DO NOT place or drop objects on top and do not shove any foreign objects into the product.
- DO NOT expose to or use near liquids, rain, or moisture. DO NOT use the modem during electrical storms.
- DO NOT cover the vents on the product to prevent the system from getting overheated.
- DO NOT use damaged power cords, accessories, or other peripherals.
- If the Adapter is broken, do not try to fix it by yourself. Contact a qualified service technician or your retailer.
- To prevent electrical shock hazard, disconnect the power cable from the electrical outlet before relocating the system.

Danish CE statement

Forenklet EU-overensstemmelseserklæringen

ASUSTek Computer Inc. erklærer herved, at denne enhed er i overensstemmelse med hovedkravene og øvrige relevante bestemmelser i direktiv 2014/53/EU. Hele EU-overensstemmelseserklæringen kan findes på https://www.asus.com/Networking/ROG-Rapture-GT-AC5300/HelpDesk_Declaration/.

Overensstemmelseserklæring for miljøvenligt design i direktiv 2009/125/EC

Vedrørende testkrav af øko-design i henhold til (EC) nr. 1275/2008 og (EU) nr. 801/2013 er blevet gennemført. Når enheden er på netværk-standby, er dens I/O og netværksgrænseflade i dvale, og vil muligvis ikke virke ordentligt. For at aktivere enheden, skal du trykke på trådløs til/fra, LED til/fra, nulstil eller WPS-knappen. Dette udstyr er i overensstemmelse med EU's grænser, der er gældende i et ukontrolleret miljø. Dette udstyr skal installeres og bruges mindst 20 cm mellem radiatoren og din krop.

Alle driftsfunktioner:

2.4GHz: 802.11b, 802.11g, 802.11n (HT20), 802.11n (HT40), 802.11ac (VHT20), 802.11ac (VHT40)

5GHz: 802.11a, 802.11n (HT20), 802.11n (HT40), 802.11ac (VHT20), 802.11ac (VHT40), 802.11ac (VHT80)

Frekvensen, indstillingen og den maksimale overførte effekt i EU er anført på listen nedenfor:

2412-2472MHz (802.11g 6 Mbps): 19.96 dBm

5180-5240MHz (802.11ac VHT20 MCS0): 22.97 dBm

5260-5320MHz (802.11ac VHT40 MCS0): 22.97 dBm

5500-5700MHz (802.11ac VHT80 MCS0): 29.98 dBm

Denne enhed er begrænset til indendørs brug, hvis den bruges på frekvensområdet 5150-5350 MHz.

Adapteren skal bruges i nærheden af udstyret, og skal være let tilgængelig.

	AT	BE	BG	CZ	DK	EE	FR
	DE	IS	IE	IT	EL	ES	CY
	LV	LI	LT	LU	HU	MT	NL
	NO	PL	PT	RO	SI	SK	TR
	FI	SE	CH	UK	HR	UA	

Safety Notices

- Anvend produktet i omgivelser med temperaturer på mellem 0°C(32°F) og 40°C(104°F).
- Sørg for, at din strømadapter passer til strømoplysninger, der findes på bunden af dit produkt.
- Anbring IKKE på ujævne eller ustabile arbejdsoverflader. Send til reparation, hvis kabinettet er blevet beskadiget.
- Der må IKKE placeres eller tabes genstande på produktet. Og der må IKKE stikkes fremmedlegemer ind i produktet.
- Udsæt og brug den IKKE i nærheden af væsker, regn eller fugt. Brug IKKE modemmet under uvejr.
- Tildæk IKKE ventilationshullerne på produktet, da system ellers kan overophede.
- Brug IKKE beskadigede el-ledninger, perifere enheder og beskadiget tilbehør.
- Hvis strømforsyningen går i stykker, må du ikke prøve på selv at reparere den. Kontakt en autoriseret servicetekniker eller forhandleren.
- For at undgå faren for elektrisk stød, skal du fjerne netledningen fra stikkontakten, inden du flytter systemet til et andet sted.

Dutch CE statement

Vereenvoudigde EU-conformiteitsverklaring

ASUSTek Computer Inc. verklaart dat dit apparaat in overeenstemming is met de essentiële vereisten en andere relevante bepalingen van Richtlijn 2014/53/EU. Volledige tekst EU-conformiteitsverklaring is beschikbaar op https://www.asus.com/Networking/ROG-Rapture-GT-AC5300/HelpDesk_Declaration/.

Conformiteitsverklaring voor Ecodesign Richtlijn 2009/125/EG

Testen van vereisten van ecodesign overeenkomstig (EG) nr. 1275/2008 en (EU) nr. 801/2013 zijn uitgevoerd. Wanneer het apparaat in de modus Stand-by in netwerk staat, staan de I/O en netwerkinterface in de slaapstand en werken wellicht niet goed. Om het apparaat uit de slaapstand te halen, drukt u op de knop Wi-Fi aan/uit, LED aan/uit, reset of WPS.

Deze apparatuur voldoet aan EU-limieten voor blootstelling aan straling als uiteengezet voor een onbeheerste omgeving. Deze apparatuur moet worden geïnstalleerd en bediend met een minimumafstand van 20 cm tussen de radiator en uw lichaam.

Alle bedrijfsmodi:

2.4GHz: 802.11b, 802.11g, 802.11n (HT20), 802.11n (HT40), 802.11ac (VHT20), 802.11ac (VHT40)
5GHz: 802.11a, 802.11n (HT20), 802.11n (HT40), 802.11ac (VHT20), 802.11ac (VHT40), 802.11ac (VHT80)

De frequentie, modus en het afgegeven maximumvermogen in de EU wordt hieronder vermeld:

2412-2472MHz (802.11g 6 Mbps): 19.96 dBm
5180-5240MHz (802.11ac VHT20 MCS0): 22.97 dBm
5260-5320MHz (802.11ac VHT40 MCS0): 22.97 dBm
5500-5700MHz (802.11ac VHT80 MCS0): 29.98 dBm

Het apparaat is beperkt tot alleen binnengebruik bij werking in het frequentiebereik van 5150 tot 5350 MHz. De adapter moet zich in de buurt van het apparaat bevinden en moet gemakkelijk toegankelijk zijn.

	AT	BE	BG	CZ	DK	EE	FR
	DE	IS	IE	IT	EL	ES	CY
	LV	LI	LT	LU	HU	MT	NL
	NO	PL	PT	RO	SI	SK	TR
	FI	SE	CH	UK	HR	UA	

Safety Notices

- Gebruik dit product in omgevingen met omgevingstemperaturen tussen 0°C (32°F) en 40°C (104°F).
- Raadpleeg het typeplaatje op de onderkant van uw product en controleer of uw voedingsadapter voldoet aan dit type.
- NIET op onegale of instabiele werkoppervlakken plaatsen. Als de behuizing beschadigd is geraakt, dient u hulp bij onderhoud hulp te zoeken.
- Plaats of laat GEEN objecten vallen bovenop het product en schuif geen vreemde objecten in het product.
- NIET in de buurt van vloeistoffen, regen of vocht blootstellen of gebruiken. NIET de modem tijdens onweer gebruiken.
- Dek de uitlaatopeningen van het product NIET AF zodat het systeem niet oververhit raakt.
- NIET de ventilatieopeningen van de Desktop PC afdekken, om oververhitting van het systeem te voorkomen.
- Als de netvoeding is beschadigd, mag u niet proberen het zelf te repareren. Neem contact op met een bevoegde servicemonteur of uw handelaar.
- Verwijder, voordat u het systeem verplaatst, de stroomkabel uit de contactdoos om elektrische schok te vermijden.

French

CE statement

Déclaration simplifiée de conformité de l'UE

ASUSTek Computer Inc. déclare par la présente que cet appareil est conforme aux critères essentiels et autres clauses pertinentes de la directive 2014/53/UE. La déclaration de conformité de l'UE peut être téléchargée à partir du site internet suivant: <https://www.asus.com/Networking/ROG-Rapture-GT-AC5300/HelpDesk/Declaration/>.

Déclaration de conformité (Directive sur l'écoconception 2009/125/CE)

Test de la conformité aux exigences d'écoconception selon [CE 1275/2008] et [UE 801/2013]. Lorsque l'appareil est en mode Networked Standby, son panneau d'E/S et son interface réseau sont en mode veille et peuvent ne pas fonctionner correctement. Pour sortir l'appareil du mode veille, appuyez sur le bouton Wi-Fi, LED, de réinitialisation ou WPS.

Cet appareil a été testé et s'est avéré conforme aux limites établies par l'UE en terme d'exposition aux radiations dans un environnement non contrôlé. Cet équipement doit être installé et utilisé avec un minimum de 20 cm de distance entre la source de rayonnement et votre corps.

Tous les modes de fonctionnement:

2.4GHz: 802.11b, 802.11g, 802.11n (HT20), 802.11n (HT40), 802.11ac (VHT20), 802.11ac (VHT40)

5GHz: 802.11a, 802.11n (HT20), 802.11n (HT40), 802.11ac (VHT20), 802.11ac (VHT40), 802.11ac (VHT80)

La fréquence, le mode et la puissance maximale transmise de l'UE sont listés ci-dessous:

2412-2472MHz (802.11g 6 Mbps): 19.96 dBm

5180-5240MHz (802.11ac VHT20 MCS0): 22.97 dBm

5260-5320MHz (802.11ac VHT40 MCS0): 22.97 dBm

5500-5700MHz (802.11ac VHT80 MCS0): 29.98 dBm

Cet appareil est restreint à une utilisation en intérieur lors d'un fonctionnement dans la plage de fréquence de 5150 à 5350 MHz.

L'adaptateur doit être installé à proximité de l'équipement et être aisément accessible.

	AT	BE	BG	CZ	DK	EE	FR
	DE	IS	IE	IT	EL	ES	CY
	LV	LI	LT	LU	HU	MT	NL
	NO	PL	PT	RO	SI	SK	TR
	FI	SE	CH	UK	HR	UA	

Safety Notices

- Utilisez ce produit dans un environnement dont la température ambiante est comprise entre 0°C (32°F) et 40°C (104°F).
- Référez-vous à l'étiquette située au dessous du produit pour vérifier que l'adaptateur secteur répond aux exigences de tension.
- NE PAS placer sur une surface irrégulière ou instable. Contactez le service après-vente si le châssis a été endommagé.
- NE PAS placer, faire tomber ou insérer d'objets sur/dans le produit.
- NE PAS exposer l'appareil à la pluie ou à l'humidité, tenez-le à distance des liquides. NE PAS utiliser le modem lors d'un orage.
- NE PAS bloquer les ouvertures destinées à la ventilation du système pour éviter que celui-ci ne surchauffe.
- NE PAS utiliser de cordons d'alimentation, d'accessoires ou autres périphériques endommagés.
- Si l'adaptateur est endommagé, n'essayez pas de le réparer vous-même. Contactez un technicien électrique qualifié ou votre revendeur.
- Pour éviter tout risque de choc électrique, débranchez le câble d'alimentation de la prise électrique avant de toucher au système.

Finnish

CE statement

Yksinkertaistettu EU-vaatimustenmukaisuusvakuutus

ASUSTek Computer Inc. vakuuttaa täten, että tämä laite on 2014/53/EU-direktiivin olennaisten vaatimusten ja muiden asiaan kuuluvien lisäysten mukainen. Koko EU-vaatimustenmukaisuusvakuutuksen teksti on nähtävissä osoitteessa https://www.asus.com/Networking/ROG-Rapture-GT-AC5300/HelpDesk_Declaration/.

Ekologisen suunnittelun direktiivin 2009/125/EY-vaatimustenmukaisuusvakuutus

Testaus (EY) N:o 1275/2008:n ja (EU) N:o 801/2013:n mukaisista ekologisista suunnitteluvaatimuksista on suoritettu. Kun laite on verkossa valmiustilassa, sen I/O- ja verkkoliittymä ovat lepotilassa eivätkä toimi oikein. Herättääksesi laitteen, paina Wi-Fi päälle/pois -, LED päälle/pois -, nollaa- tai WPS-painiketta.

Tämä laite täyttää EU-säteilyrajoitukset, jotka on asetettu hallitsemattomaan ympäristöön. Tämä laitteisto tulee asentaa ja sitä tulee käyttää siten, että säteilijän ja kehosi välinen etäisyys on vähintään 20 cm.

Kaikki käyttötilat:

2.4GHz: 802.11b, 802.11g, 802.11n (HT20), 802.11n (HT40), 802.11ac (VHT20), 802.11ac (VHT40)

5GHz: 802.11a, 802.11n (HT20), 802.11n (HT40), 802.11ac (VHT20), 802.11ac (VHT40), 802.11ac (VHT80)

Taajuus, tila maksimi lähetetty teho EU:ssa on listattu alla:

2412-2472MHz (802.11g 6 Mbps): 19.96 dBm

5180-5240MHz (802.11ac VHT20 MCS0): 22.97 dBm

5260-5320MHz (802.11ac VHT40 MCS0): 22.97 dBm

5500-5700MHz (802.11ac VHT80 MCS0): 29.98 dBm

Tämän laitteen käyttö on rajoitettu sisätiloihin 5 150 - 5 350 MHz:in-taajuusalueella.

Verkkolaite tulee liittää lähelle laitetta helposti tavoitettavissa olevaan paikkaan.

	AT	BE	BG	CZ	DK	EE	FR
	DE	IS	IE	IT	EL	ES	CY
	LV	LI	LT	LU	HU	MT	NL
	NO	PL	PT	RO	SI	SK	TR
	FI	SE	CH	UK	HR	UA	

Safety Notices

- Käytä tätä tuotetta ympäristöissä, joissa ympäristölämpötila on välillä 0°C (32°F) ja 40°C (104°F).
- Varmista tuotteen pohjassa sijaitsevasta arvokilvestä vastaako verkkolaite tätä nimellisarvoa.
- ÄLÄ aseta epätasaisille tai epävakaille pinnoille. Ota yhteys huoltoon, jos kotelo on vahingoittunut.
- ÄLÄ aseta tai pudota esineitä laitteen päälle äläkä anna minkään vieraiden esineiden joutua tuotteen sisään.
- ÄLÄ altista nesteille, sateelle tai kosteudelle tai käytä niiden lähellä. ÄLÄ käytä modeemia ukkosmyrskyn aikana.
- ÄLÄ peitä tuotteen tuuletusaukkoja estääksesi tuotteen ylikuumenemisen.
- ÄLÄ käytä vahingoittuneita virtajohtoja, lisävarusteita tai muita oheislaitteita.
- Jos virtalähde on rikkoutunut, älä itse yritä sitä korjata. Ota yhteys ammattimaiseen huoltohenkilöön tai jälleenmyyjäsi.
- Estääksesi sähköiskun vaaran irrota virtakaapeli pistorasiasta ennen järjestelmän paikan muuttamista.

German

CE statement

Vereinfachte EU-Konformitätserklärung

ASUSTeK Computer Inc. erklärt hiermit, dass dieses Gerät mit den grundlegenden Anforderungen und anderen relevanten Bestimmungen der Richtlinie 2014/53/EU übereinstimmt. Der gesamte Text der EU-Konformitätserklärung ist verfügbar unter: https://www.asus.com/Networking/ROG-Rapture-GT-AC5300/HelpDesk_Declaration/.

Konformitätserklärung für Ökodesign-Richtlinie 2009/125/EC

Die Überprüfung der Ökodesign-Anforderungen nach (EC) Nr. 1275/2008 und (EU) Nr. 801/2013 wurde durchgeführt. Wenn sich das Gerät im Netzwerkbereitschaftsmodus befindet, werden die E/A- und Netzwerkschnittstellen in den Ruhezustand versetzt und arbeiten nicht wie gewöhnlich. Um das Gerät aufzuwecken, drücken Sie die WLAN Ein/Aus-, LED Ein/Aus-, Reset- oder WPS-Taste.

Dieses Gerät erfüllt die EU-Strahlenbelastungsgrenzwerte, die für ein unbeaufsichtigtes Umfeld festgelegt wurden. Dieses Gerät sollte mit einem Mindestabstand von 20 cm zwischen der Strahlungsquelle und Ihrem Körper installiert und betrieben werden.

Alle Betriebsarten:

2.4GHz: 802.11b, 802.11g, 802.11n (HT20), 802.11n (HT40), 802.11ac (VHT20), 802.11ac (VHT40)

5GHz: 802.11a, 802.11n (HT20), 802.11n (HT40), 802.11ac (VHT20), 802.11ac (VHT40), 802.11ac (VHT80)

Die Frequenz, der Modus und die maximale Sendeleistung in der EU sind nachfolgend aufgeführt:

2412-2472MHz (802.11g 6 Mbps): 19.96 dBm

5180-5240MHz (802.11ac VHT20 MCS0): 22.97 dBm

5260-5320MHz (802.11ac VHT40 MCS0): 22.97 dBm

5500-5700MHz (802.11ac VHT80 MCS0): 29.98 dBm

Das Gerät ist auf den Innenbereich beschränkt, wenn es im Frequenzbereich von 5150 MHz bis 5350 MHz betrieben wird. Das Netzteil muss sich in der Nähe des Geräts befinden und leicht zugänglich sein.

	AT	BE	BG	CZ	DK	EE	FR
	DE	IS	IE	IT	EL	ES	CY
	LV	LI	LT	LU	HU	MT	NL
	NO	PL	PT	RO	SI	SK	TR
	FI	SE	CH	UK	HR	UA	

Safety Notices

- Benutzen Sie das Gerät nur in Umgebungen, die eine Temperatur von 0 °C (32 °F) bis 40 °C (104 °F) aufweisen.
- Prüfen Sie am Aufkleber an der Geräteunterseite, ob Ihr Netzteil den Stromversorgungsanforderungen entspricht.
- Stellen Sie das Gerät NICHT auf schräge oder instabile Arbeitsflächen. Wenden Sie sich an das Wartungspersonal, wenn das Gehäuse beschädigt wurde.
- Legen Sie KEINE Gegenstände auf das Gerät, lassen Sie keine Gegenstände darauf fallen und schieben Sie keine Fremdkörper in das Gerät.
- Setzen Sie das Gerät KEINESFALLS Flüssigkeiten, Regen oder Feuchtigkeit aus, verwenden Sie es nicht in der Nähe derartiger Gefahrenquellen. Verwenden Sie das Modem nicht während eines Gewitters.
- Decken Sie die Lüftungsöffnungen am Gerät NICHT ab, um eine Überhitzung des Systems zu vermeiden.
- Benutzen Sie KEINE beschädigten Netzkabel, Zubehörteile oder sonstigen Peripheriegeräte.
- Falls das Netzteil defekt ist, versuchen Sie nicht, es selbst zu reparieren. Wenden Sie sich an den qualifizierten Kundendienst oder Ihre Verkaufsstelle.
- Um die Gefahr eines Stromschlags zu verhindern, ziehen Sie das Netzkabel aus der Steckdose, bevor Sie das System an einem anderen Ort aufstellen.

Greek

CE statement

Απλουστευμένη δήλωση συμμόρφωσης της ΕΕ

Με το παρόν, η ASUSTek Computer Inc. δηλώνει πως αυτή η συσκευή συμμορφώνεται με τις θεμελιώδεις απαιτήσεις και άλλες σχετικές διατάξεις της Οδηγίας 2014/53/ΕΕ. Το πλήρες κείμενο της δήλωσης συμμόρφωσης της ΕΕ είναι διαθέσιμο στη διεύθυνση https://www.asus.com/Networking/ROG-Rapture-GT-AC5300/HelpDesk_Declaration/.

Δήλωση συμμόρφωσης για την οδηγία Ecodesign (Οικολογικός σχεδιασμός) 2009/125/ΕΚ

Έχει διενεργηθεί δοκιμή για τις απαιτήσεις οικολογικού σχεδιασμού σύμφωνα με τους κανονισμούς (ΕΚ) αριθ. 1275/2008 και (ΕΕ) αριθ. 801/2013. Όταν η συσκευή βρίσκεται σε λειτουργία Αναμονή δικτύου, η διασύνδεση I/O και δικτύου βρίσκονται σε κατάσταση αναμονής και ενδέχεται να μην λειτουργούν σωστά. Για να ενεργοποιήσετε τη συσκευή, πατήστε το πλήκτρο ενεργοποίησης/απενεργοποίησης Wi-Fi, ενεργοποίησης/απενεργοποίησης λυχνίας LED, επαναφοράς ή το πλήκτρο WPS.

Ο παρόν εξοπλισμός συμμορφώνεται με τα όρια έκθεσης σε ακτινοβολία της ΕΕ που έχουν διατυπωθεί για μη ελεγχόμενο περιβάλλον. Ο συγκεκριμένος εξοπλισμός πρέπει να εγκατασταθεί και να λειτουργεί με ελάχιστη απόσταση 20 εκ μεταξύ της συσκευής ακτινοβολίας και του σώματός σας.

Όλοι οι τρόποι λειτουργίας:

2.4GHz: 802.11b, 802.11g, 802.11n (HT20), 802.11n (HT40), 802.11ac (VHT20), 802.11ac (VHT40)

5GHz: 802.11a, 802.11n (HT20), 802.11n (HT40), 802.11ac (VHT20), 802.11ac (VHT40), 802.11ac (VHT80)

Η συχνότητα, ο τρόπος λειτουργίας και η μέγιστη μεταδιδόμενη ισχύς στην ΕΕ αναφέρονται παρακάτω:

2412-2472MHz (802.11g 6 Mbps): 19.96 dBm

5180-5240MHz (802.11ac VHT20 MCS0): 22.97 dBm

5260-5320MHz (802.11ac VHT40 MCS0): 22.97 dBm

5500-5700MHz (802.11ac VHT80 MCS0): 29.98 dBm

Η συσκευή περιορίζεται σε χρήση σε εσωτερικούς χώρους όταν λειτουργεί στη ζώνη συχνότητων 5150 έως 5350 MHz.

Η προσαρμογέας θα πρέπει να εγκατασταθεί κοντά στον εξοπλισμό και να είναι εύκολα προσβάσιμος.

	AT	BE	BG	CZ	DK	EE	FR
	DE	IS	IE	IT	EL	ES	CY
	LV	LI	LT	LU	HU	MT	NL
	NO	PL	PT	RO	SI	SK	TR
	FI	SE	CH	UK	HR	UA	

Safety Notices

- Να χρησιμοποιείτε το προϊόν σε χώρους με θερμοκρασίες περιβάλλοντος από 0°C έως 40°C.
- Ανατρέξτε στην ετικέτα χαρακτηριστικών στο κάτω μέρος του προϊόντος σας και βεβαιωθείτε ότι ο προσαρμογέας τροφοδοσίας σας συμμορφώνεται με την αναγραφόμενη τιμή.
- ΜΗΝ τοποθετείτε τη συσκευή σε ανώμαλη ή ασταθή επιφάνεια εργασίας. Πηγαίνετε τη συσκευή για σέρβις αν το περίβλημα έχει πάθει βλάβη.
- ΜΗΝ τοποθετείτε αντικείμενα επάνω και μην σπρώχνετε αντικείμενα μέσα στο προϊόν.
- ΜΗΝ την εκθέτετε ή τη χρησιμοποιείτε κοντά σε υγρά, βροχή, ή υγρασία. ΜΗΝ χρησιμοποιείτε το μόντεμ κατά τη διάρκεια ηλεκτρικής καταιγίδας.
- ΜΗΝ καλύπτετε τα ανοίγματα εξαερισμού στο προϊόν για να αποφύγετε τυχόν υπερθέρμανση του συστήματος.
- ΜΗΝ καλύπτετε τα ανοίγματα εξαερισμού στο Desktop PC για να αποφύγετε τυχόν υπερθέρμανση του συστήματος.
- Αν το καλώδιο παροχής ρεύματος πάθει βλάβη, μην προσπαθήσετε να το επιδιορθώσετε μόνοι σας. Επικοινωνήστε με κατάλληλα εκπαιδευμένο τεχνικό επισκευών ή με τον μεταπωλητή σας.
- Για να αποφύγετε τον κίνδυνο ηλεκτροπληξίας, αποσυνδέστε το καλώδιο παροχής ρεύματος από την πρίζα πριν αλλάξετε θέση στο σύστημα.

Italian CE statement

Dichiarazione di conformità UE semplificata

ASUSTek Computer Inc. con la presente dichiara che questo dispositivo è conforme ai requisiti essenziali e alle altre disposizioni pertinenti con la direttiva 2014/53/EU. Il testo completo della dichiarazione di conformità UE è disponibile all'indirizzo https://www.asus.com/Networking/ROG-Rapture-GT-AC5300/HelpDesk_Declaration/.

Dichiarazione di conformità con la direttiva Ecodesign 2009/125/EC

I test per i requisiti eco-design (EC) N. 1275/2008 e (EU) N. 801/2013 sono stati eseguiti. Quando il dispositivo si trova nella modalità Standby di rete le sue interfacce di rete e I/O sono in sospensione e potrebbero non funzionare correttamente. Per riattivare il dispositivo premete uno tra i pulsanti Wi-Fi on/off, LED on/off, reset o WPS.

Questo apparecchio è conforme ai limiti UE, per l'esposizione a radiazioni, stabiliti per un ambiente non controllato. Questo apparecchio deve essere installato e utilizzato ad una distanza di almeno 20 cm dal corpo. Tutte le modalità operative:

2.4GHz: 802.11b, 802.11g, 802.11n (HT20), 802.11n (HT40), 802.11ac (VHT20), 802.11ac (VHT40)
5GHz: 802.11a, 802.11n (HT20), 802.11n (HT40), 802.11ac (VHT20), 802.11ac (VHT40), 802.11ac (VHT80)
I valori di frequenza, modalità e massima potenza di trasmissione per l'UE sono elencati di seguito:

2412-2472MHz (802.11g 6 Mbps): 19.96 dBm
5180-5240MHz (802.11ac VHT20 MCS0): 22.97 dBm
5260-5320MHz (802.11ac VHT40 MCS0): 22.97 dBm
5500-5700MHz (802.11ac VHT80 MCS0): 29.98 dBm

L'utilizzo di questo dispositivo è limitato agli ambienti interni quando si sta utilizzando la banda di frequenze compresa tra i 5150 e i 5350 MHz.

L'adattatore deve essere installato vicino al dispositivo e facilmente accessibile.

	AT	BE	BG	CZ	DK	EE	FR
	DE	IS	IE	IT	EL	ES	CY
	LV	LI	LT	LU	HU	MT	NL
	NO	PL	PT	RO	SI	SK	TR
	FI	SE	CH	UK	HR	UA	

Safety Notices

- Usa questo prodotto in ambienti la cui temperatura sia compresa tra 0°C(32°F) e 40°C(104°F).
- Consulta l'etichetta indicante la potenza posta sul fondo del prodotto e assicurati che l'adattatore di alimentazione sia compatibile con tali valori.
- Non collocare il dispositivo su superfici irregolari o instabili. Contatta il servizio clienti se lo chassis è stato danneggiato.
- NON riporre oggetti sopra il dispositivo e non infilare alcun oggetto all'interno del dispositivo.
- NON esporre a liquidi, pioggia o umidità. NON usare il modem durante i temporali.
- NON coprire le prese d'aria del prodotto per evitare che il sistema si surriscaldi.
- NON utilizzare cavi di alimentazione, accessori o periferiche danneggiate.
- Se l'adattatore è danneggiato non provare a ripararlo. Contatta un tecnico qualificato o il rivenditore.
- Per prevenire il rischio di scosse elettriche scollega il cavo di alimentazione dalla presa di corrente prima di spostare il sistema.

Norwegian CE statement

Forenklet EU-samsvarserklæring

ASUSTek Computer Inc. erklærer herved at denne enheten er i samsvar med hovedsaklige krav og andre relevante forskrifter i direktivet 2014/53/EU. Fullstendig tekst for EU-samsvarserklæringen finnes på https://www.asus.com/Networking/ROG-Rapture-GT-AC5300/HelpDesk_Declaration/.

Samsvarserklæring for direktiv om miljøvennlig design 2009/125/EF

Testing for miljøutformingskrav i henhold til (EF) nr. 1275/2008 og (EU) nr. 801/2013 er utført. Når enheten er i nettverksventemodus, er I/O- og nettverksgrensesnittet i hvilemodus og fungerer kanskje ikke som det skal. Trykk Wi-Fi på/av-, LED på/av-, tilbakestill- eller WPS-knappen for å vekke enheten.

Dette utstyret samsvarer med FCC-grensene for strålingseksponering for et ukontrollert miljø. Dette utstyret bør installeres og brukes med en minimumsavstand på 20 cm mellom radiatoren og kroppen din.

Alle operasjonsmoduser:

2.4GHz: 802.11b, 802.11g, 802.11n (HT20), 802.11n (HT40), 802.11ac (VHT20), 802.11ac (VHT40)

5GHz: 802.11a, 802.11n (HT20), 802.11n (HT40), 802.11ac (VHT20), 802.11ac (VHT40), 802.11ac (VHT80)

Frekvens, modus og maksimal overføringskraft i EU er oppført nedenfor:

2412-2472MHz (802.11g 6 Mbps): 19.96 dBm

5180-5240MHz (802.11ac VHT20 MCS0): 22.97 dBm

5260-5320MHz (802.11ac VHT40 MCS0): 22.97 dBm

5500-5700MHz (802.11ac VHT80 MCS0): 29.98 dBm

Enheten er begrenset til innendørs bruk når den brukes i frekvensområdet 5150 til 5350 MHz.

Adapteren skal plasseres nært utstyret og være lett tilgjengelig.

	AT	BE	BG	CZ	DK	EE	FR
	DE	IS	IE	IT	EL	ES	CY
	LV	LI	LT	LU	HU	MT	NL
	NO	PL	PT	RO	SI	SK	TR
	FI	SE	CH	UK	HR	UA	

Safety Notices

- Bruk dette produktet i miljø med en romtemperatur mellom 0°C(32°F) og 40°C(104°F).
- Se etiketten på undersiden av produktet, og sørg for strømforsyningen er i samsvar med denne klassifiseringen.
- Må IKKE plasseres på ujevne eller ustabile overflater. Oppsøk service dersom kassen har blitt skadet.
- IKKE plasser eller slipp gjenstander på, eller skyv gjenstander inn i, produktet.
- Må IKKE eksponeres for eller brukes i nærheten av væsker, regn eller fuktighet. Modemet skal IKKE brukes under elektrisk storm.
- IKKE dekk til ventilene på produktet for å forhindre at systemet blir for varmt.
- Skadede strømledninger, tilleggsutstyr eller annet periferiutstyr skal IKKE brukes.
- Hvis strømforsyningen er ødelagt, må du ikke prøve å reparere det selv. Kontakt en kvalifisert servicetekniker eller forhandleren.
- For å forhindre elektrisk sjokk, koble strømkabelen fra det elektriske uttaket før du flytter systemet.

Portuguese

CE statement

Declaração de conformidade simplificada da UE

A ASUSTek Computer Inc. declara que este dispositivo está em conformidade com os requisitos essenciais e outras disposições relevantes da Diretiva 2014/53/CE. O texto integral da declaração de conformidade da UE está disponível em https://www.asus.com/Networking/ROG-Rapture-GT-AC5300/HelpDesk_Declaration/.

Declaração de conformidade para a Diretiva Conção Ecológica 2009/125/CE

Foram realizados testes de requisitos de conceção ecológica de acordo com o N° 1275/2008 (CE) e N° 801/2013 (UE). Quando o dispositivo se encontra no modo de espera em rede, a interface de E/S e de rede encontram-se no modo de suspensão e poderão não funcionar corretamente. Para ativar o dispositivo, prima o botão para ativar/desativar Wi-Fi, ativar/desativar o LED, repor ou WPS.

Este equipamento cumpre os limites de exposição à radiação estabelecidos pela UE para um ambiente não controlado. Este equipamento deve ser instalado e utilizado a uma distância mínima de 20 cm entre o transmissor e o seu corpo.

Todos os modos operacionais:

2.4GHz: 802.11b, 802.11g, 802.11n (HT20), 802.11n (HT40), 802.11ac (VHT20), 802.11ac (VHT40)

5GHz: 802.11a, 802.11n (HT20), 802.11n (HT40), 802.11ac (VHT20), 802.11ac (VHT40), 802.11ac (VHT80)

A frequência, o modo e a potência máxima na UE são apresentados abaixo:

2412-2472MHz (802.11g 6 Mbps): 19.96 dBm

5180-5240MHz (802.11ac VHT20 MCS0): 22.97 dBm

5260-5320MHz (802.11ac VHT40 MCS0): 22.97 dBm

5500-5700MHz (802.11ac VHT80 MCS0): 29.98 dBm

Este dispositivo está restrito a utilização no interior quando utilizado na banda de frequências 5.150 a 5.350 MHz.

O adaptador deverá ser instalado próximo do equipamento e estar facilmente acessível.

	AT	BE	BG	CZ	DK	EE	FR
	DE	IS	IE	IT	EL	ES	CY
	LV	LI	LT	LU	HU	MT	NL
	NO	PL	PT	RO	SI	SK	TR
	FI	SE	CH	UK	HR	UA	

Safety Notices

- Utilize este equipamento em ambientes com temperaturas entre 0°C (32°F) e 40°C (104°F).
- Verifique a etiqueta relativa à tensão na parte inferior do seu dispositivo e assegure-se de que o seu transformador corresponde a essa tensão.
- NÃO coloque o computador em superfícies irregulares ou instáveis. Envie para reparação se a caixa se encontrar danificada.
- NÃO coloque nem deixe cair objetos em cima do aparelho e não introduza quaisquer objetos estranhos no produto.
- NÃO exponha o equipamento nem o utilize próximo de líquidos, chuva ou humidade. NÃO utilize o modem durante tempestades eléctricas.
- NÃO tape os orifícios de ventilação do produto para impedir o sobreaquecimento do sistema.
- NÃO utilize cabos de alimentação, acessórios ou outros periféricos danificados.
- Se a fonte de alimentação estiver avariada, não tente repará-la por si próprio. Contacte um técnico qualificado ou o seu revendedor.
- Para evitar o risco de choque eléctrico, desligue o cabo de alimentação da tomada eléctrica antes de deslocar o sistema.

Spanish

CE statement

Declaración de conformidad simplificada para la UE

Por el presente documento, ASUSTek Computer Inc. declara que este dispositivo cumple con los requisitos esenciales y otras disposiciones pertinentes de la Directiva 2014/53/UE. En https://www.asus.com/Networking/ROG-Rapture-GT-AC5300/HelpDesk_Declaration/ está disponible el texto completo de la declaración de conformidad para la UE.

Declaración de conformidad para la directiva de ecodiseño 2009/125/CE

Se han realizado pruebas para cumplir los requisitos de ecodiseño conforme a las directivas (CE) nº 1275/2008 y (UE) nº 801/2013. Cuando el dispositivo está en modo de espera y conectado en red, su interfaz de E/S y de red se encuentran en el modo de suspensión y pueden no funcionar correctamente. Para reactivar el dispositivo, presione el botón de activación y desactivación de la funcionalidad Wi-Fi, el botón de encendido y apagado de LED, el botón de restablecimiento o el botón WPS.

El equipo cumple los límites de exposición de radiación de la UE fijados para un entorno no controlado. Este equipo se debe instalar y utilizar a una distancia mínima de 20 cm entre el dispositivo radiante y su cuerpo.

Todos los modos operativos:

2.4GHz: 802.11b, 802.11g, 802.11n (HT20), 802.11n (HT40), 802.11ac (VHT20), 802.11ac (VHT40)

5GHz: 802.11a, 802.11n (HT20), 802.11n (HT40), 802.11ac (VHT20), 802.11ac (VHT40), 802.11ac (VHT80)

A continuación figuran la frecuencia, el modo y la potencia máxima de transmisión en la UE:

2412-2472MHz (802.11g 6 Mbps): 19.96 dBm

5180-5240MHz (802.11ac VHT20 MCS0): 22.97 dBm

5260-5320MHz (802.11ac VHT40 MCS0): 22.97 dBm

5500-5700MHz (802.11ac VHT80 MCS0): 29.98 dBm

El dispositivo solamente debe utilizarse en interiores cuando opera en el intervalo de frecuencias de 5150 a 5350 MHz.

El adaptador debe estar instalado cerca del equipo y debe disponer de un acceso fácil.

	AT	BE	BG	CZ	DK	EE	FR
	DE	IS	IE	IT	EL	ES	CY
	LV	LI	LT	LU	HU	MT	NL
	NO	PL	PT	RO	SI	SK	TR
	FI	SE	CH	UK	HR	UA	

Safety Notices

- Use este producto en entornos sometidos a una temperatura ambiente comprendida entre 0 °C (32 °F) y 40 °C (104 °F).
- Consulte la etiqueta de valores nominales situada en la parte inferior del producto y asegúrese de que su adaptador de alimentación cumple con dichos valores.
- NO coloque el equipo sobre una superficie irregular o inestable. Solicite asistencia técnica si la carcasa resulta dañada.
- NO coloque ni deje caer objetos en la parte superior del producto y no introduzca objetos extraños dentro de él.
- NO exponga el equipo a líquidos, lluvia o humedad, ni lo use cerca de ninguno de tales elementos. NO use el módem durante tormentas eléctricas.
- Para evitar que el sistema se sobrecaliente, no cubra las ranuras de ventilación del producto.
- NO cubra los orificios de ventilación del equipo de sobremesa para evitar que el sistema se caliente en exceso.
- NO intente reparar la fuente de alimentación personalmente si se avería. Póngase en contacto con un técnico de mantenimiento autorizado o con su distribuidor.
- A fin de evitar posibles descargas eléctricas, desconecte el cable de alimentación de la toma de suministro eléctrico antes de cambiar la posición del sistema.

Swedish CE statement

Förenklad EU-försäkran om överensstämmelse

ASUSTek Computer Inc. deklarerar härmed att denna enhet uppfyller väsentliga krav och andra relevanta bestämmelser i direktiv 2014/53/EU. Hela texten i EU-försäkran om överensstämmelse finns på https://www.asus.com/Networking/ROG-Rapture-GT-AC5300/HelpDesk_Declaration/.

Försäkran om överensstämmelse för Ecodesign-direktivet 2009/125/EC

Test för ekodesingkrav i enlighet med (EC) nr 1275/2008 och (EU) nr 801/2013 har utförts. När enheten är i standby-läge för nätverk, är gränssnitten för I/O och nätverk försatta i viloläge och fungerar kanske inte ordentligt. För att väcka enheten, tryck på knappen för att slå på/stänga av Wi-Fi, slå på/stänga av LED, återställa eller WPS-knappen.

Denna utrustning uppfyller EU:s strålningsexponeringsgräns för en okontrollerad miljö. Denna utrustning skall installeras och hanteras på minst 20 cm avstånd mellan strålkällan och din kropp.

Alla funktionslägen:

2.4GHz: 802.11b, 802.11g, 802.11n (HT20), 802.11n (HT40), 802.11ac (VHT20), 802.11ac (VHT40)

5GHz: 802.11a, 802.11n (HT20), 802.11n (HT40), 802.11ac (VHT20), 802.11ac (VHT40), 802.11ac (VHT80)

Frekvens, läge och maximalt överförd ström i EU anges nedan:

2412-2472MHz (802.11g 6 Mbps): 19.96 dBm

5180-5240MHz (802.11ac VHT20 MCS0): 22.97 dBm

5260-5320MHz (802.11ac VHT40 MCS0): 22.97 dBm

5500-5700MHz (802.11ac VHT80 MCS0): 29.98 dBm

Enheten är begränsad till användning inomhus enbart vid användning inom 5 150 till 5 350 MHz frekvensområdet.

Adaptorn ska installeras nära utrustningen och ska vara lätt att komma åt.

	AT	BE	BG	CZ	DK	EE	FR
	DE	IS	IE	IT	EL	ES	CY
	LV	LI	LT	LU	HU	MT	NL
	NO	PL	PT	RO	SI	SK	TR
	FI	SE	CH	UK	HR	UA	

Safety Notices

- Använd denna produkt i en miljö med en omgivande temperatur mellan 0°C(32°F) och 40°C(104°F).
- Läs märketiketten på produktens undersida, och kontrollera att strömadaptorn uppfyller dessa märkdata.
- Placera den INTE på en ojämn eller instabil arbetsyta. Sök service om höljet har skadats.
- Placera och tappa INTE föremål ovanpå, och skjut inte in främmande föremål i produkten.
- Utsätt den INTE för eller använd i närheten av vätskor, i regn eller fukt. ANVÄND INTE modemmet under åskväder.
- Täck INTE över ventilationsöppningarna på produkten för att förhindra att systemet överhettas.
- ANVÄND INTE skadade strömsladdar, tillbehör eller annan kringutrustning.
- Om strömförsörjningen avbryts försök inte att laga det själv. Kontakta en kvalificerad servicetekniker eller din återförsäljare.
- För att förhindra elektriska stötar, koppla bort elkabeln från elnätet innan systemet flyttas.

