

ēlo



USER MANUAL

Elo Touch Solutions

15.6" Widescreen E-Series RevC All-in-One Touchcomputer

SW602266 Rev B

Copyright © 2017 Elo Touch Solutions, Inc. All Rights Reserved.

No part of this publication may be reproduced, transmitted, transcribed, stored in a retrieval system, or translated into any language or computer language, in any form or by any means, including, but not limited to, electronic, magnetic, optical, chemical, manual, or otherwise without prior written permission of Elo Touch Solutions, Inc.

Disclaimer

The information in this document is subject to change without notice. Elo Touch Solutions, Inc. and its Affiliates (collectively "Elo") makes no representations or warranties with respect to the contents herein, and specifically disclaims any implied warranties of merchantability or fitness for a particular purpose. Elo reserves the right to revise this publication and to make changes from time to time in the content hereof without obligation of Elo to notify any person of such revisions or changes.

Trademark Acknowledgments

AccuTouch, CarrollTouch, Elo, Elo (logo), Elo Touch, Elo Touch Solutions, Elo TouchSystems, IntelliTouch, iTouch, SecureTouch, TouchTools and VuPoint are trademarks of Elo and its Affiliates. Windows is a trademark of Microsoft Corporation.

Table of Contents

Chapter 1: Setup	4
Unpacking Your Touchcomputer	4
Adjusting the Display	5
Calibrating the Touchscreen	6
Additional Extended Cable Cover for Your System.....	7
Additional Mounting Option for Your System.....	8
Chapter 2: Operation	9
Elo Touch Solutions – E-Series Hardware Monitoring Utility	9
LED Functionality	10
Accessing the Input/Output Panel	11
Setting Up the Operating System	12
Creating the Recovery Flash Drive	16
Recovering the Operating System	19
Chapter 3: Safety and Maintenance	23
Safety	23
Care and Handling	24
Chapter 4: Technical Support	26
Technical Assistance	26
Chapter 5: REGULATORY INFORMATION	27
I. Electrical Safety Information	27
II. Emissions and Immunity Information.....	27
III. Agency Certifications	29
IV. China RoHS.....	30
Chapter 6: WARRANTY INFORMATION	31

SETUP

This chapter discusses how to set up and test your touchcomputer.

Unpacking Your Touchcomputer

Check that the following items are present and in good condition:



Touchcomputer



Power cable US/Canada

← AND →



Power cable Europe



Quick Install Guide

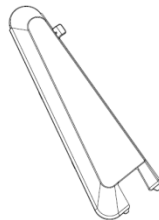

Extended Cable Cover



Power Adapter

Adjusting the Display

The display screen can be adjusted from -17 to +75 degrees, as shown below.

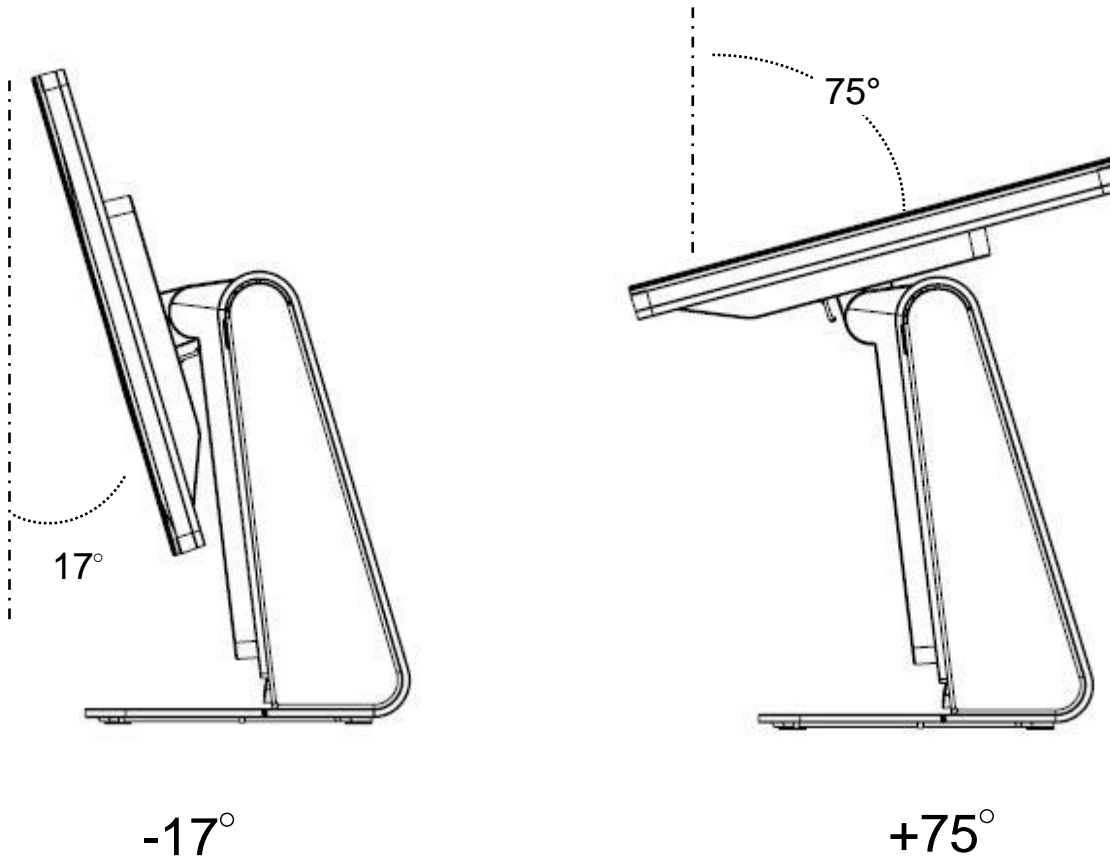

CAUTION: To prevent tipping or dropping, be sure to hold the base when adjusting the display.

Calibrating the Touchscreen

The touchscreen is pre-calibrated for accurate touch response.

If for any reason the touchscreen needs to be recalibrated, please double-click the EloConfig shortcut on the system desktop (for Windows 7 & 8.1) and then click **“Calibrate Touch Screens”**.

This launches the calibration program. The window shown below opens. Follow the instructions to calibrate the touchscreen.

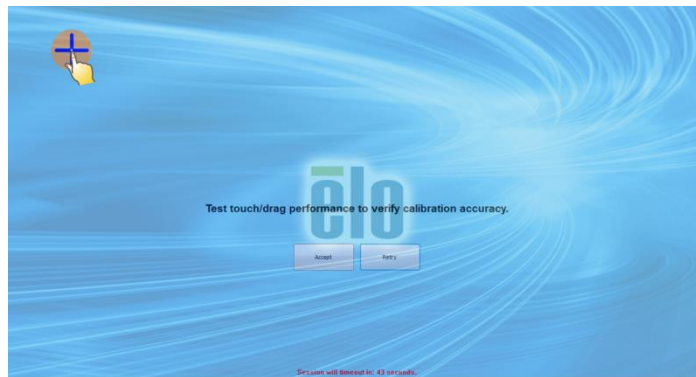

Additional Extended Cable Cover for Your System

E-Series RevC provides an additional extended cable cover in the accessory box. You may need to replace the original cable cover to the extended cable cover if most of I/O ports have been connected.

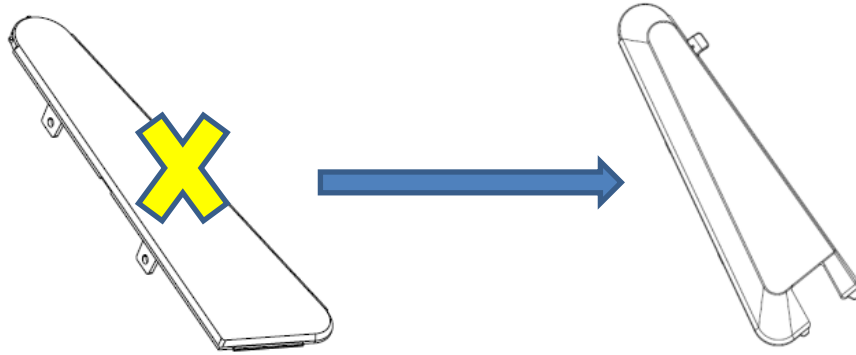

Additional Mounting Option for Your System

1) Mounting on the wall

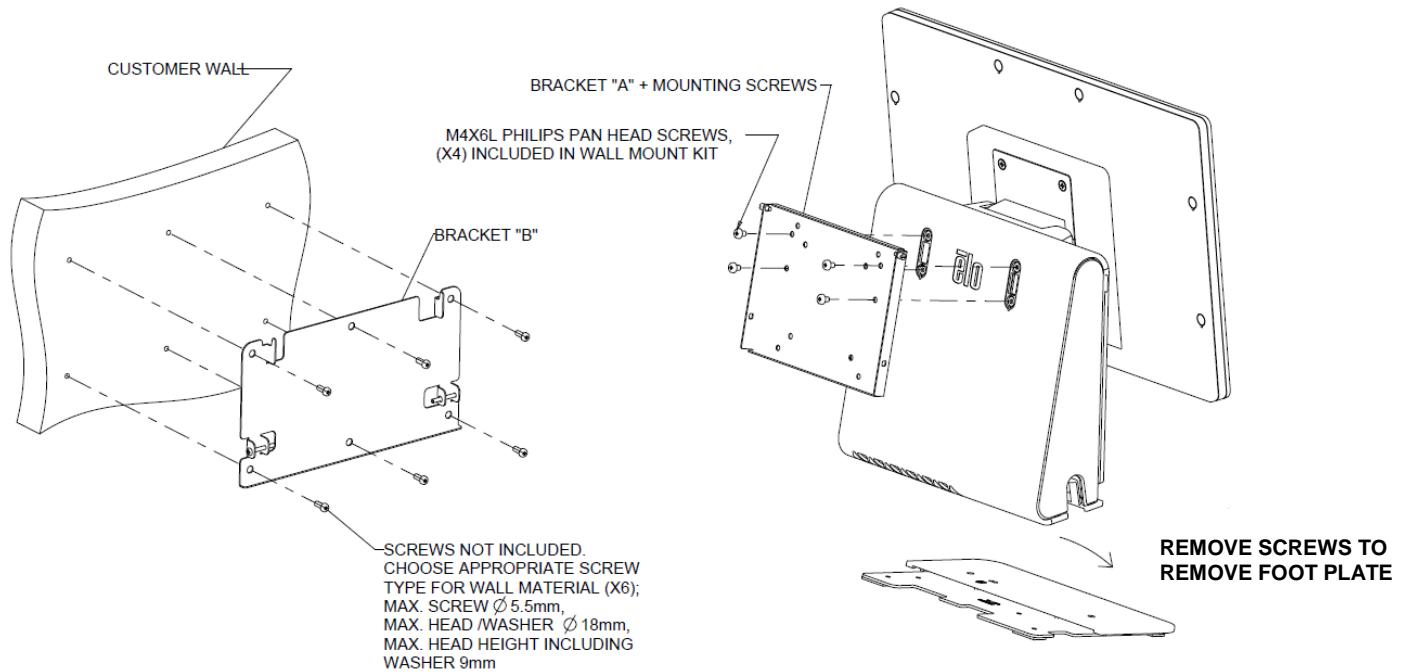

2) Second monitor mount onto your system (any monitor under 2.5 Kg with 75mm VESA mount)

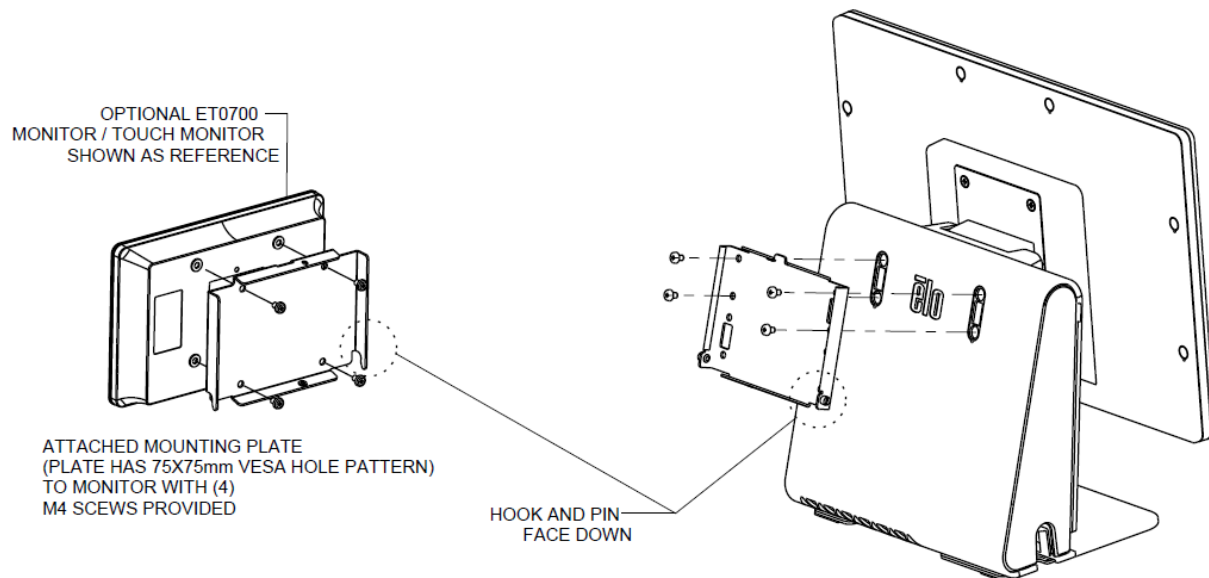

OPERATION

This chapter describes how to interact with the Elo Touch Solutions diagnostic tool, power LED, and input/output panel.

Elo Touch Solutions – E-Series Hardware Monitoring Utility

E-Series Hardware Monitor Menu

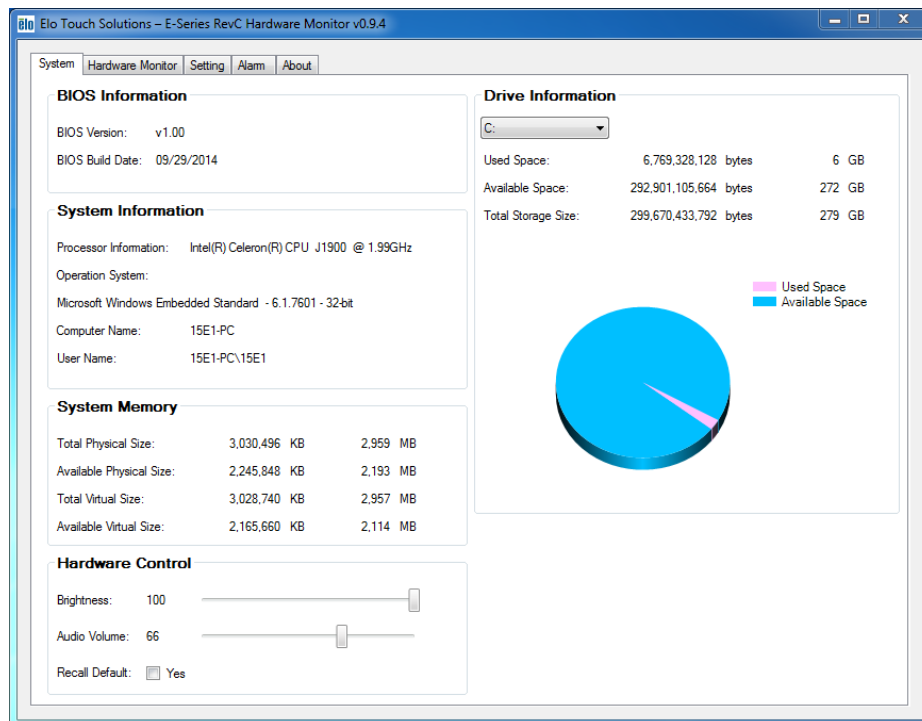

The Hardware Monitor tool provides the following features.

Feature	Description
System	Display the BIOS version, operating system version, Hardware Control (Volume & Brightness), memory information, and drive information.
Hardware Monitor	Monitor the CPU temperature, system temperature, and system output voltages.
Setting	Set alarms when the CPU temperature, system temperature, and output voltages that meet the setting criterion.
Alarm	Display the record of all alarms.
About	General information for the E-Series diagnostic tool.

LED Functionality

The E-Series base has a LED indicating the state of the touchcomputer. The table below shows LED state and corresponding color.

LED Color to Observer	State
Off	No input power — Off mode
Red	Input power present – Off or Hibernation mode
Orange	Input power present — Standby mode S3
Green	Input power present — Power on

Accessing the Input/Output Panel

To access the input/output (I/O) ports, remove the I/O cover at the left of the unit. A security screw is included and may be used to secure the front cover to the touchcomputer. Below are the I/O descriptions:

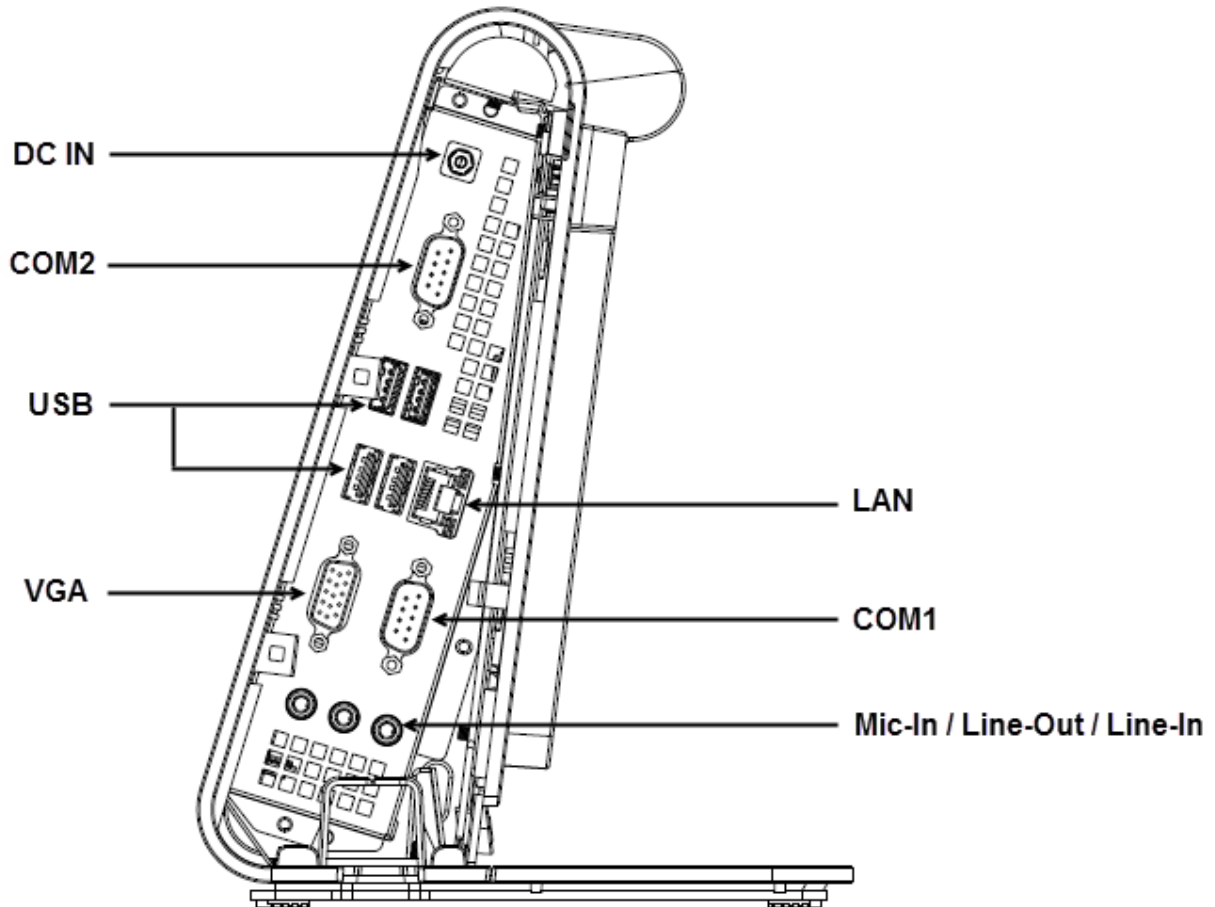

Note: As a safety precaution, always leave the I/O cover attached when the system is powered on.

Setting Up the Operating System

If configured with an operating system, the initial setup of the operating system takes approximately 5-10 minutes. Additional time may be needed depending on touchcomputer hardware configurations and connected devices.

To set up the Microsoft® Windows® Operating System for the touchcomputer, turn on the touchcomputer by pressing the power button, and then follow the on-screen instructions.

Injecting a new language (For Windows POSReady 7 Only)

Windows POSReady 7 only allows the use of only one language at one time. But you can use the Elo Touch Solutions language injection feature to modify your language preference. English is set as the default language, but you can change this language to suit your preferences.

1. Power off your system completely.
2. Power on your system.
3. After the Elo splash screen (shown below), press “↑” or “↓” repeatedly to pause on Windows Boot Manager.



4. Select either **Restore OS 32bit** or **Restore OS 64bit** depending on your OS environment.

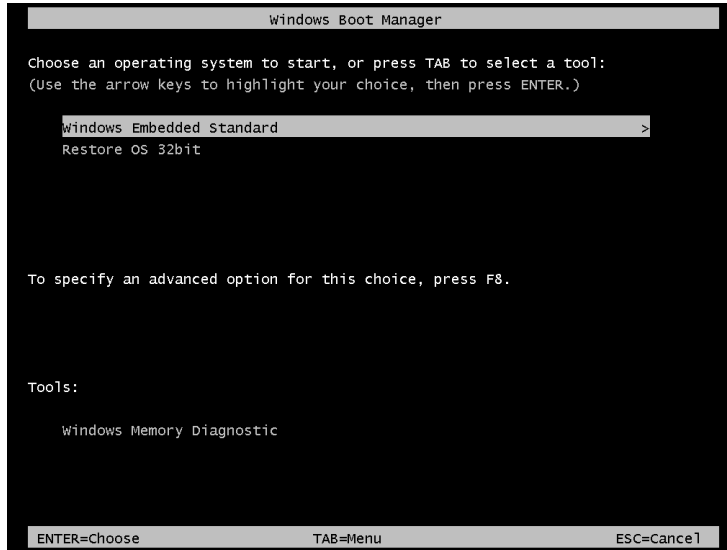

5. The following User Interface (UI) will be presented:

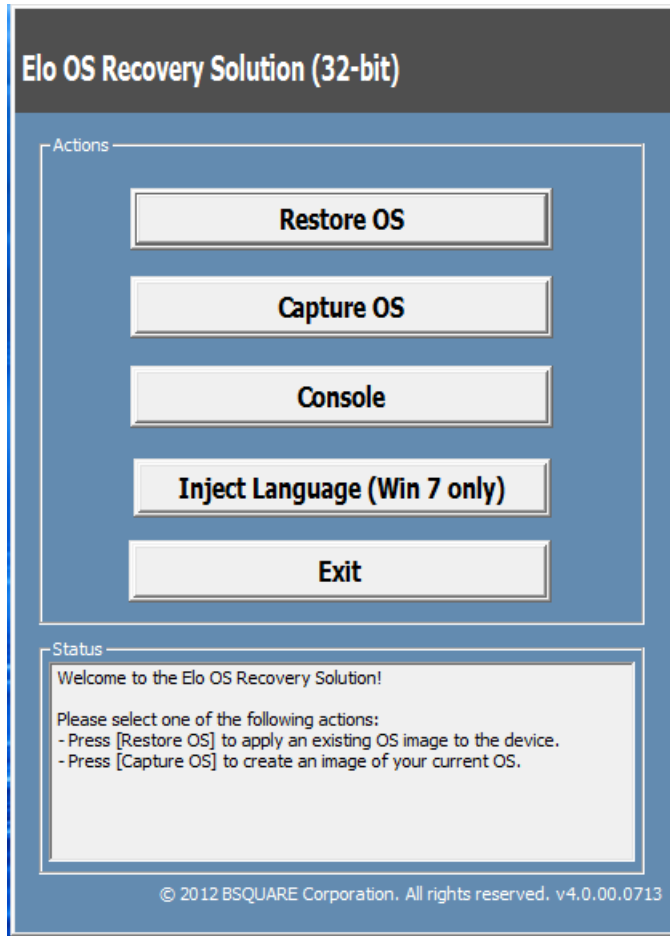

6. Select **Inject Language**, and the following UI will be presented.

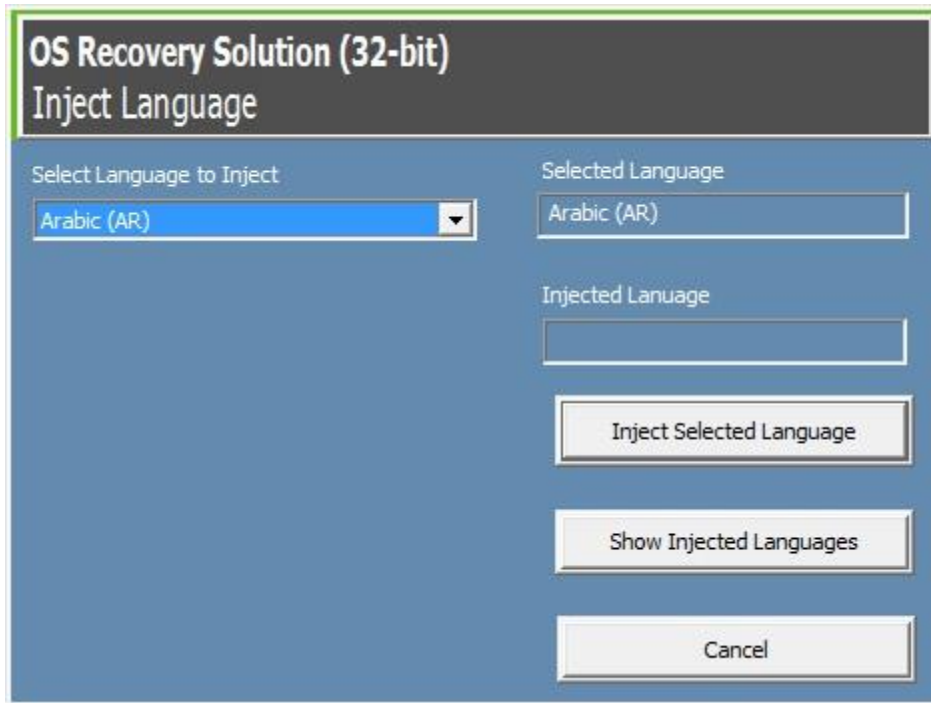

6. Click the drop-down list and select the preference language.
7. Click **Inject Selected Language**
8. While the injecting process is performing, **DO NOT** use your keyboard or mouse during this time. It may cause an error in the language injection process.

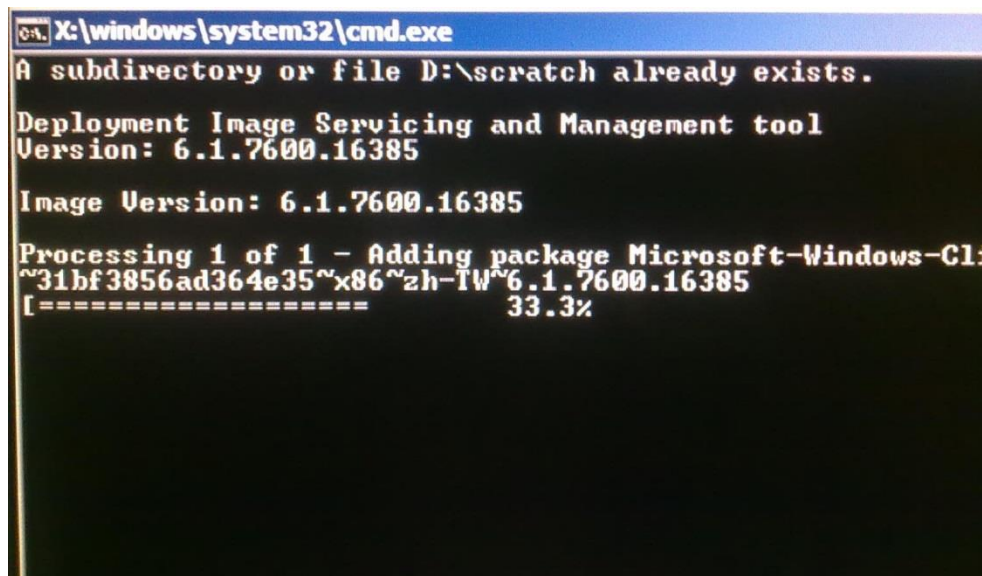

9. After the language package is installed correctly, press any key to exit the window.

10. You should see the new injected language in both “**Selected Language**” and “**Injected Language**”.
11. Click **Cancel** → **Exit**. The system will reboot and new language UI should be presented when the system enters the Desktop.

Creating the Recovery Flash Drive

All POSReady 7 and Windows 8.1 touchcomputers come with the built-in Elo Restore Utility on the Windows Desktop. The utility is able to create a recovery flash drive based on the operating system you purchased. **Please create your recovery flash drive immediately.** In the event the HDD/SSD recovery partition is accidentally deleted or becomes inaccessible, you will need to use the recovery flash drive to recover your system.

The following procedures demonstrate how to use the utility to create a recovery flash drive.

1. Right-click the EloRestoreUtility icon on the Desktop and select “**Run as administrator**”.
2. Click “Start” button to begin the process.

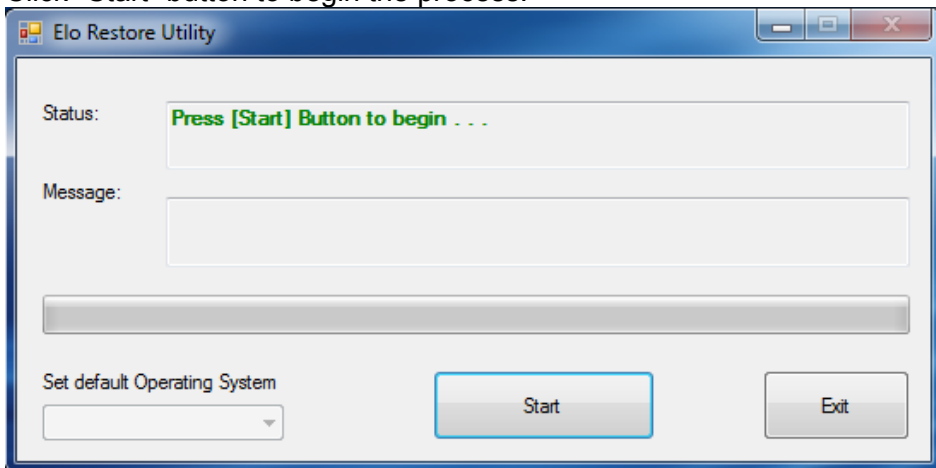

3. Once completed, you shall see a pop-up window to ask to insert a blank flash drive to any of available USB ports on your system.

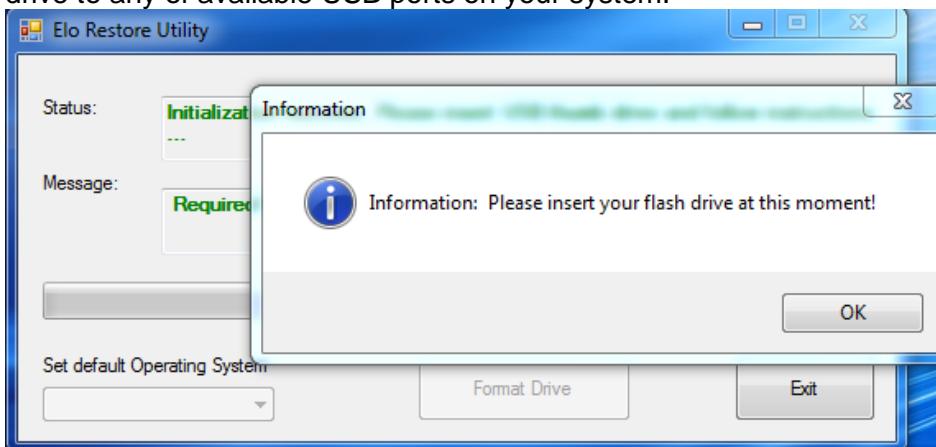

4. After the flash drive is inserted, you shall see a window as shown below. Click “Format Drive” to continue the process. **PLEASE NOTE THAT ALL**

DATA WILL BE LOST DURING THIS PROCESS.

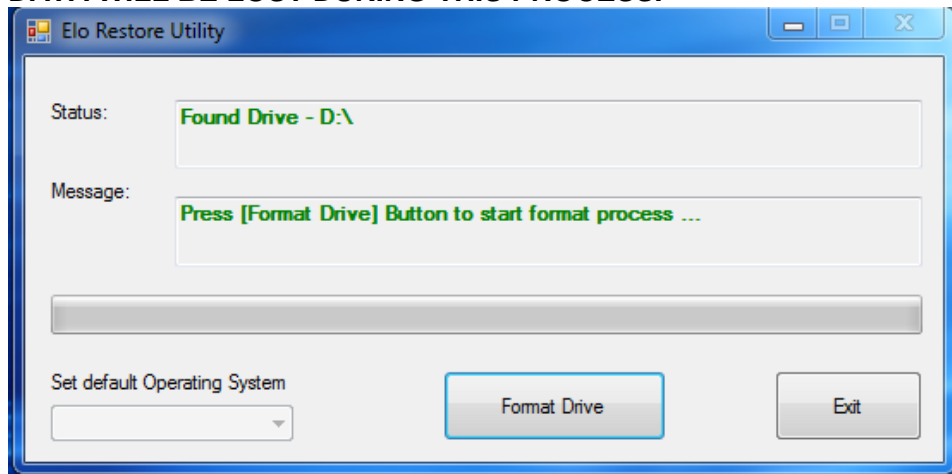

5. Click "Create Restore Media" to proceed. This step will take 10-20 minutes depending on your system configurations and flash drive performance.

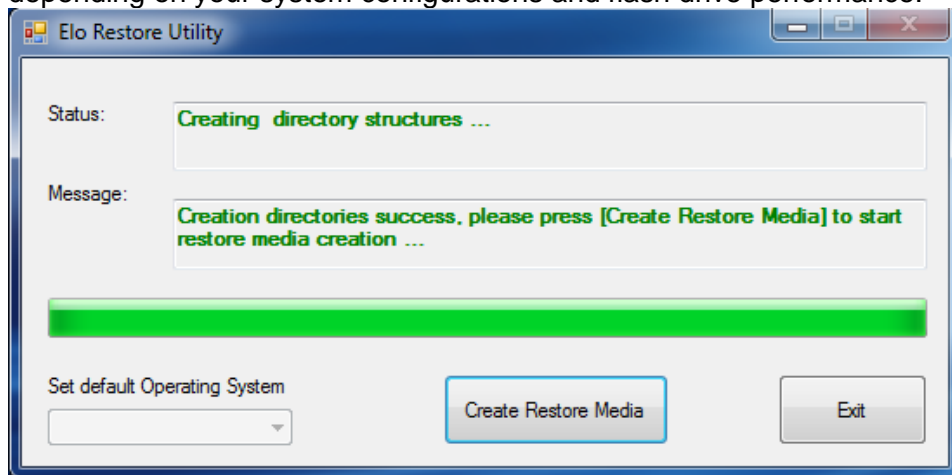

6. Once the message says "Creation Restore Media success...", please remove the flash drive and click "Exit" to exit the program.

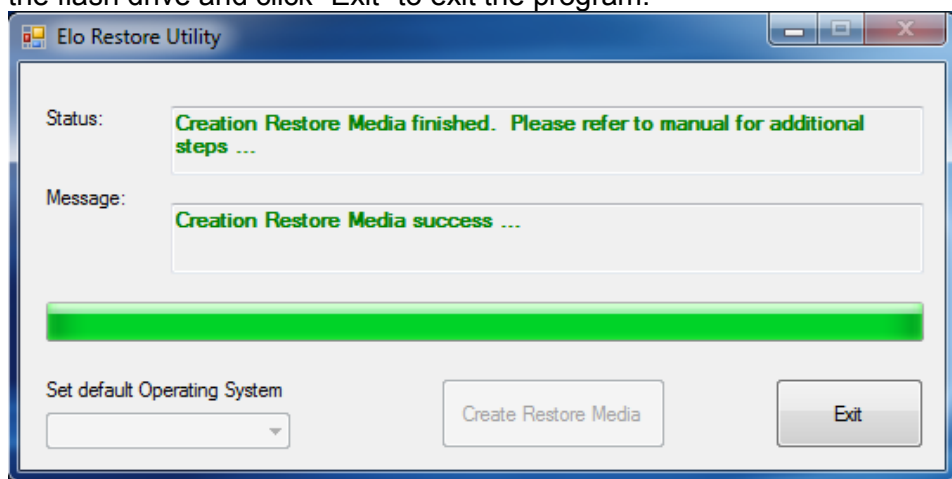

7. In case the system is crashed and you have to use the recovery flash drive, reboot the system and press **F11** several times to enter **Device Boot Menu**. Then, choose boot from flash drive.
8. When the following UI is presented, click “Install Recovery Solution” button.

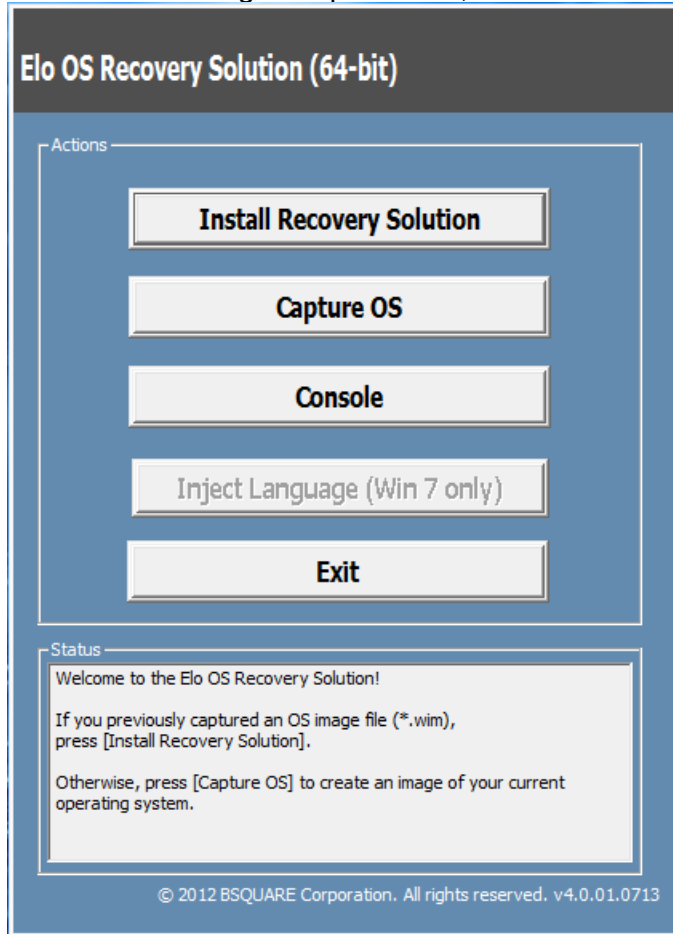

9. Follow the on-screen instructions to complete the installation process and then exit the program.

Note: All data is deleted during the recovery process. The user must back up files when necessary. Elo Touch Solutions does not accept liability for lost data or software.

Note: The end user must adhere to Microsoft's Licensing Agreement

Recovering the Operating System

If for any reason the touchcomputer's operating system needs to be recovered TO FACTORY SETTINGS, you can recover your system by following procedures below. **PLEASE NOTE THAT ALL CUSTOMER SETTINGS AND DATA WILL BE LOST DURING THIS PROCESS.** Please be sure to completely backup all of your data, settings, and customer-installed software before proceeding.

1. Power off your system completely.
2. Power on your system.
3. After the Elo splash screen (shown below), press “↑” or “↓” repeatedly to pause on Windows Boot Manager.



4. Select either **Restore OS 32bit** or **Restore OS 64bit** depending on your OS environment.

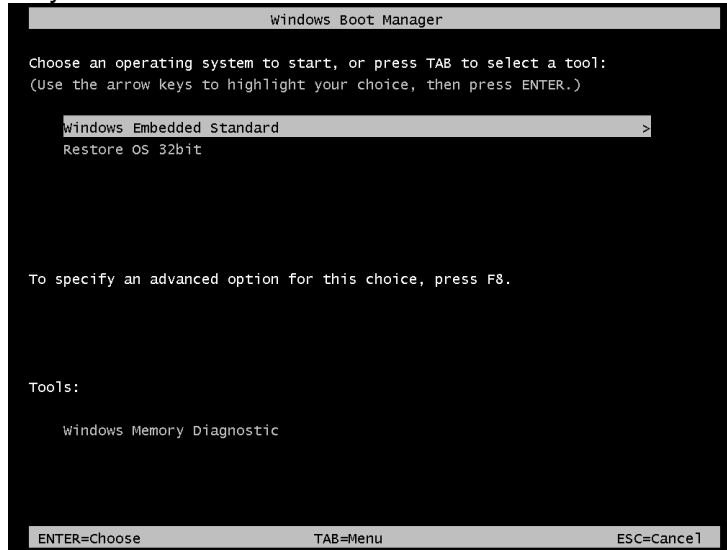

5. The following User Interface (UI) will be presented:

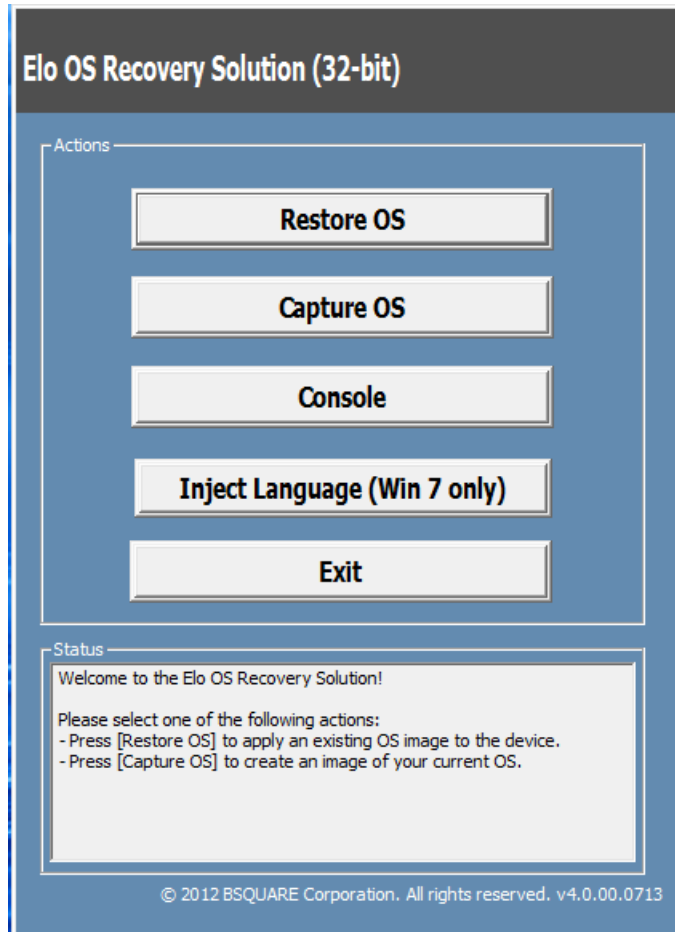

6. Select **Restore OS**. System will test your hardware automatically. Once the process completes, click **Start** button to perform the system recovery

function.

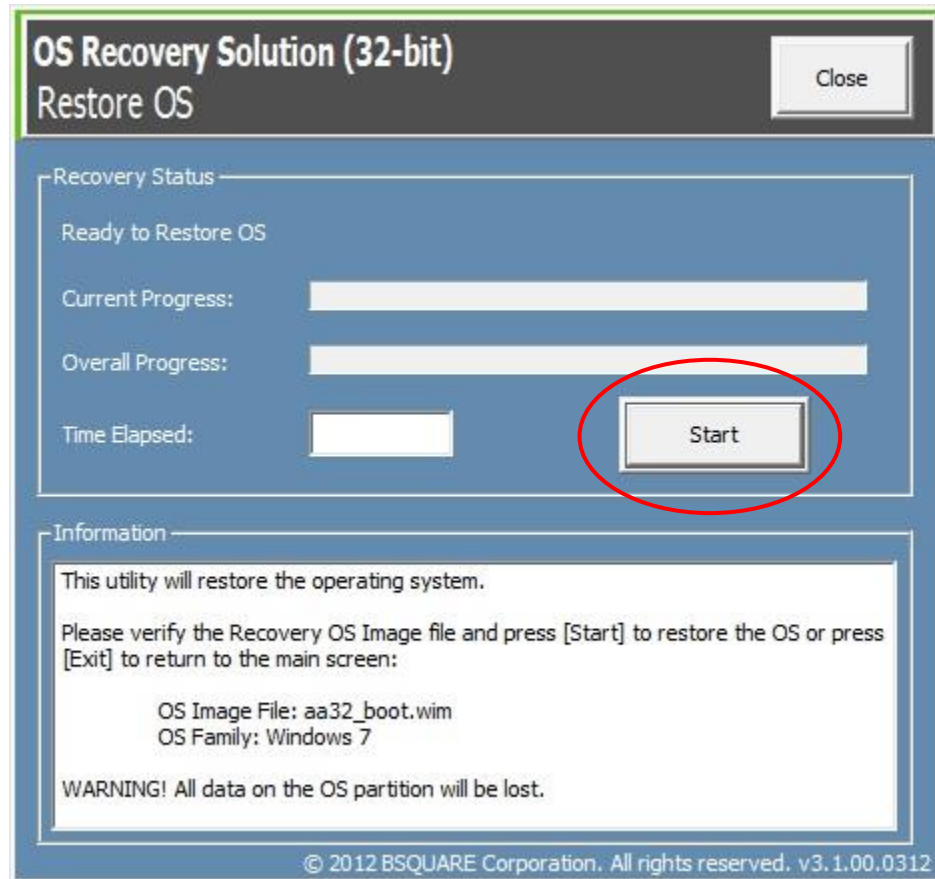

7. The following process will reformat the primary hard drive. **Please back up your data before performing the recovery process.**

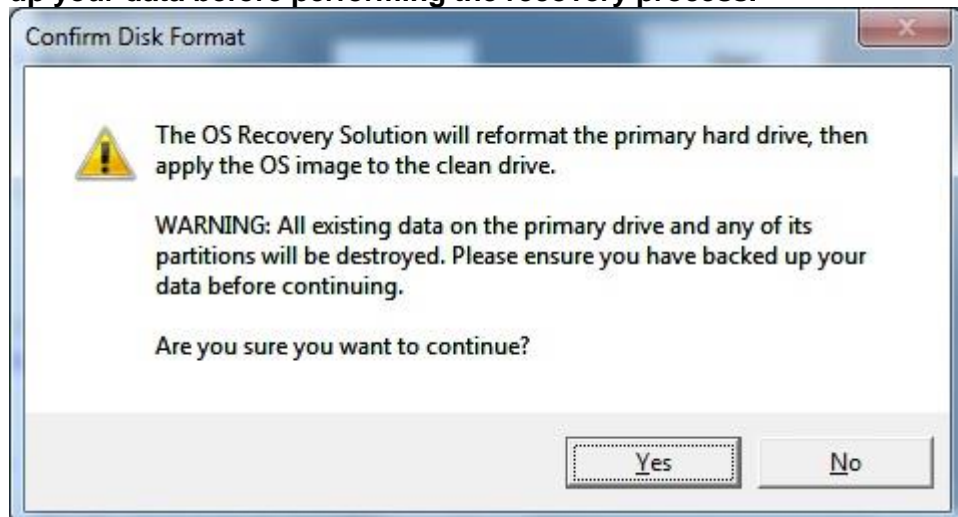

8. Once completed, click the **Close** button. The system will return to the main menu of the Elo Recovery Solution. Then click the **Exit** button to restart your system.

NOTE: All data is deleted during the recovery process. The user must back up files when necessary. Elo Touch Solutions does not accept liability for lost data or software.

NOTE: The end user must adhere to Microsoft's Licensing Agreement.

SAFETY AND MAINTENANCE

Safety

Important information regarding the proper setup and maintenance of your touchcomputer:

- To reduce the risk of electric shock, follow all safety notices and do not disassemble the touchcomputer.
- Turn off touchcomputer before cleaning (refer to “Care and Handling” for proper cleaning methods).
- Your touch computer is equipped with a 3-wire, grounding power cord. The power cord plug only fits into a grounded outlet. Do not attempt to fit the plug into an outlet that has not been configured for this purpose. Do not use a damaged power cord. Only use the power cord that comes with your Elo Touch Solutions touchcomputer. Use of an unauthorized power cord might invalidate your warranty.
- The slots located on the sides and top of the touchcomputer case are designed to allow for ventilation. Do not block or insert anything inside these ventilation slots.
- It is important that your touchcomputer remains dry. Do not pour liquid into or onto your touchcomputer. If your touchcomputer becomes wet, do not attempt to repair it yourself. Contact Elo Customer Service for assistance.

Care and Handling

The following tips will help maintain optimal performance of your touchcomputer.

- To avoid risk of electric shock, do not disassemble the power adapter or display. The unit is not user serviceable. Remember to unplug the touch computer from the power outlet prior to cleaning.
- To clean the touch monitor (except touchscreen), use a cloth lightly dampened with a mild detergent.
- Do not wipe the screen with a cloth or sponge that could scratch the surface.
- To clean the touchscreen, use window or glass cleaner. Put the cleaner on the rag and wipe the touchscreen. Never apply the cleaner directly on the touchscreen.
- Do not use alcohol (methyl, ethyl, or isopropyl) or any strong solvent to clean your touchcomputer. Do not use thinner or benzene, abrasive cleaners, or compressed air.
- Avoid getting liquids inside your touchcomputer. If liquid does get inside, have a qualified service technician inspect the unit before you power it on again.



WEEE Directive



This product should not be disposed of with household waste. It should be deposited at a facility that enables recovery and recycling. Ensure that product is disposed at the end of its useful life according to local laws and regulations.

Elo has put in place recycling arrangements in certain parts of the world. For information on how you can access these arrangements, please visit <http://www.elotouch.com/AboutElo/ewaste-program/>.

Battery Notice

E-Series touch computer comes with a lithium coin cell battery, which is located in the motherboard. Take caution to not replace this battery with an unsuitable replacement as that may result in explosion hazard. Discard battery at the end of its useful life according to local laws and regulations.

4

TECHNICAL SUPPORT**Technical Assistance**

There are two methods to obtain contact information for technical assistance on the touchcomputer:

- The web
- The phone

Using the Web

For online self-help, go to www.elotouch.com/go/websupport.

For technical support, go to www.elotouch.com/go/contactsupport.

For current Elo news, product updates, and announcements, or to register to receive our Touchcomputer newsletter, go to www.elotouch.com/go/news.

Using the Phone

For technical support, see the table at the end of the user guide for contact information.

REGULATORY INFORMATION

I. Electrical Safety Information

A) Compliance is required with respect to the voltage, frequency, and current requirements indicated on the manufacturer's label. Connection to a different power source than those specified herein may result in improper operation, damage to the equipment, invalidation of warranty, or a fire hazard if the requirements are not followed.

B) There are no operator-serviceable parts inside this equipment. There are hazardous voltages generated by this equipment which constitute a safety hazard. Service should be provided only by a qualified service technician.

C) This equipment is provided with a detachable power cord which has an integral safety ground wire intended for connection to a grounded safety outlet.

1) Do not substitute the cord with other than the provided approved type. Under no circumstances use an adapter plug to connect to a 2-wire outlet as this defeats the continuity of the grounding wire.

2) The equipment requires the use of the ground wire as a part of the safety certification. Modification or misuse can provide a shock hazard that can result in serious injury or death.

3) Contact a qualified electrician or the manufacturer if there are questions about the installation prior to connecting the equipment to main power.

II. Emissions and Immunity Information

A) Notice to Users in the United States: This equipment has been tested and found to comply with the limits for a Class A digital device, pursuant to Part 15 of FCC Rules. These limits are designed to provide reasonable protection against harmful interference in a residential or commercial installation. This equipment generates, uses, and can

radiate radio frequency energy, and if not installed and used in accordance with the instructions, may cause harmful interference to radio communications.

B) Notice to Users in Canada: This equipment complies with the Class A limits for radio noise emissions from digital apparatus as established by the Radio Interference Regulations of Industry Canada.

C) Notice to Users in the European Union: Use only the provided power cords and interconnecting cabling provided with the equipment. Substitution of provided cords and cabling may compromise electrical safety or CE Mark Certification for emissions or immunity as required by the following standards: This Information Technology Equipment (ITE) is required to have a CE Mark on the manufacturer's label which means that the equipment has been tested to the following Directives and Standards:

This equipment has been tested to the requirements for the CE Mark as required by EMC Directive 2014/30/EC indicated in European Standard EN 55032 Class A and the Low Voltage Directive 2014/35/EC as indicated in European Standard EN 60950-1.

D) General Information to all Users: This equipment generates, uses, and can radiate radio frequency energy. If not installed and used according to this manual, the equipment may cause interference with radio and television communications. There is, however, no guarantee that interference will not occur in any particular installation due to site-specific factors.

1) In order to meet emission and immunity requirements, the user must observe the following:

- a) Use only the provided cables to connect the Elo touchcomputer.
- b) To ensure compliance, use only the provided manufacturer's approved power cord.
- c) The user is cautioned that changes or modifications to the equipment not expressly approved by the party responsible for compliance could void the user's authority to operate the equipment.

2) If this equipment appears to cause interference with radio or television reception, or any other device:

- a) Verify as an emission source by turning the equipment off and on.
- b) If you determine that this equipment is causing the interference, try to correct the interference by using one or more of the following measures:
 - i) Move the digital device away from the affected receiver.
 - ii) Reposition (turn) the digital device with respect to the affected receiver.
 - iii) Reorient the affected receiver's antenna.
 - iv) Plug the digital device into a different AC outlet so the digital device and the receiver are on different branch circuits.

- v) Disconnect and remove any I/O cables that the digital device does not use. (Unterminated I/O cables are a potential source of high RF emission levels.)
- vi) Plug the digital device into only a grounded outlet receptacle. Do not use AC adapter plugs. (Removing or cutting the line cord ground may increase RF emission levels and may also present a lethal shock hazard to the user.)
- vii) If you need additional help, consult your dealer, manufacturer, or an experienced radio or television technician.

Warning

This is a class A product. In a domestic environment this product may cause radio interference in which case the user may be required to take adequate measures

III. Agency Certifications

The following certifications have been issued for the touchcomputer:

UL/CUL	FCC	TUV
CB	CE	Mexico COC
S-Mark	Australia (RCM)	Japan (VCCI)
China (CCC)	Korea (KC)	Taiwan (BSMI)
Ukraine (UKSERTCOMPUTER)		

IV. China RoHS

In accordance to Chinese law (Administration on the Control of Pollution Caused by Electronic Information Products), the section below lists out the name and amount of the toxic and/or hazardous materials that this product may contain.

Component Name	Toxic or Hazardous Substances and Elements					
	Lead (Pb)	Mercury (Hg)	Cadmium (Cd)	Hexavalent Chromium (Cr6+)	Polybrominated Biphenyls (PBB)	Polybrominated Diphenyl Ethers (PBDE)
Plastic Parts	O	O	O	O	O	O
Metal Parts	X	O	O	O	O	O
Wire and Cable Assembly	X	O	O	O	O	O
LCD Panel	X	O	O	O	O	O
Touch Screen Panel	X	O	O	O	O	O
PCBA	X	O	O	O	O	O
CD	O	O	O	O	O	O

O: Indicates that this toxic or hazardous substance contained in all of the homogeneous materials for this component is below the limit requirement in SJ/T11363-2006.
X: Indicates that this toxic or hazardous substance contained in at least one of the homogeneous materials used for this component is above the limit requirement in SJ/T11363-2006. For items marked with X, exemptions were taken according to EU RoHS.

Explanation of Markings

(1). In accordance with the SJ/T11364-2006 requirement, the electronic information products are marked with the following pollution control logo.



The Environment-Friendly Use Period for this product is 10 years. The product will not leak or mutate under normal operating conditions listed below, so that the use of this electronic information product will not result in any severe environmental pollution, any bodily injury, or damage to any assets.

Operating Temperature: 0-35°C / Humidity: 20%-80% (non-condensing).

Storage Temperature: -30~60 °C / Humidity: 5%~95% (non-condensing).

(2). It is encouraged and recommended that this product be recycled and reused according to local laws. The product should not be thrown away casually.

6

WARRANTY INFORMATION

For warranty information, go to <http://www.elotouch.com/Support/warranty.asp>

Check out our website

www.elotouch.com

Get the latest...

- ***Product information***
- ***Specifications***
- ***News on upcoming events***
- ***Press release***
- ***Software drivers***

Getting in Touch with Us

To find out more about the extensive range of Elo touch solutions, visit our website at www.elotouch.com, or simply call the office nearest you:

North America	Tel 800-ELO-TOUCH	Europe	Asia-Pacific	Latin America
Elo Touch Solutions	Tel + 1 408 597 8000	Tel +32 (0) 16 70 45 00	Tel +86 (21) 3329 1385	Tel 786-923-0251
1033 McCarthy Blvd	Fax +1 408 597 8050	Fax +32 (0)16 70 45 49	Fax +86 (21) 3329 1400	Fax 305-931-0124
Milpitas, CA 95035	customerservice@elotouch.com	elosales@elotouch.com	www.elotouch.com.cn	www.elotouch.com

Copyright 2017 Elo Touch Solutions, Inc. All rights reserved.