

Windows help system

The Windows help system provides you with detailed information about using the Windows operating system.

To access the Windows help system, do the following:

Open the Start menu and then click or tap **Get Started** to get more details. You also can enter **Get Started** or what you're looking for in the search box on the taskbar. You'll get suggestions and answers to your questions about Windows and the best search results available from your PC and the Internet.

To perform system recovery after a serious error in Windows 10, click or tap the Start button and select **Settings** → **Update & security** → **Recovery**. Then, follow the instructions on the screen for system recovery.

ATTENTION: The Windows operating system is provided by Microsoft Corporation. Please use it in accordance with the **END USER LICENSE AGREEMENT (EULA)** between you and Microsoft. For any question related to the operating system, please contact Microsoft directly.

Service and Support information

The following information describes the technical support that is available for your product, during the warranty period or throughout the life of your product. Refer to the Lenovo Limited Warranty for a full explanation of Lenovo warranty terms. See "Lenovo Limited Warranty notice" later in this document for details on accessing the full warranty. If you purchased Lenovo services, refer to the following terms and conditions for detailed information:

- For Lenovo Warranty Service Upgrades or Extensions, go to: <http://support.lenovo.com/lwsu>
- For Lenovo Accidental Damage Protection Services, go to: <http://support.lenovo.com/ladps>
- Online technical support is available during the lifetime of a product at: <http://www.lenovo.com/support>

Accessing other manuals

The *Important Product Information Guide* has been preloaded onto your computer. To access this guide, do the following:

For models come with Lenovo companion:

1. Open the Start menu and then click or tap **Lenovo Companion**. If Lenovo Companion is not displayed on the Start menu, click or tap **All apps** to display all programs, and then click or tap **Lenovo Companion**.
2. Click or tap **Support** → **User Guide**.

For models without Lenovo companion:

Open the Start menu and then click or tap **Manual** to access this guide.

For models without preinstalled operating systems:

Go to the Lenovo Support Web site to access your manuals. See "Downloading manuals" for additional information.

Downloading manuals

The latest electronic publications for your computer are available from the Lenovo Support Web site. To download the publications, go to: www.lenovo.com/UserManuals.

Carry the computer

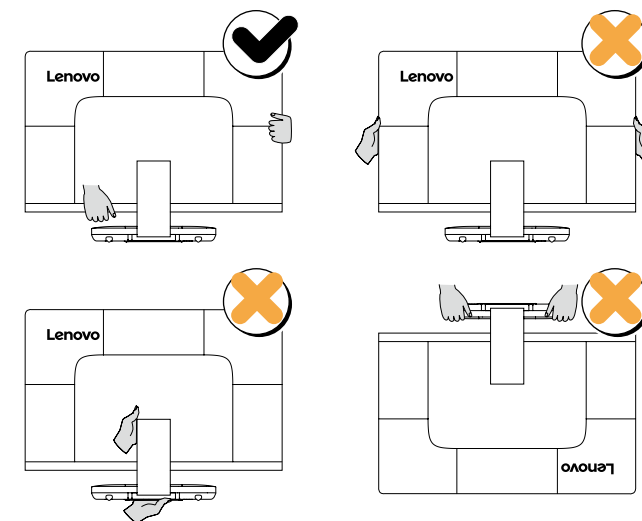

Replacing or upgrading hardware

Safety information for replacing CRUs

Do not open your computer or attempt any repairs before reading the "Important safety information" in the *Safety, Warranty, Environment, Recycling Information Guide* and *Important Product Information Guide* that was included with your computer.

If you no longer have this copy of the *Safety, Warranty, Environment, Recycling Information Guide* and *Important Product Information Guide*, you can obtain one online from the website at <http://www.lenovo.com/UserManuals>.

Pre-disassembly instructions

Before proceeding with the disassembly procedure, make sure that you do the following:

1. Turn off the power to the system and all peripherals.
2. Unplug all power and signal cables from the computer.
3. Place the system on a flat, stable surface.

CRUs for your computer include:

- keyboard
- mouse
- adapter
- Hard disk drive

This part contains instructions for replacing the following part:

- Hard disk drive (Follow below steps)

Replacing or upgrading hardware

Replacing the hard disk drive

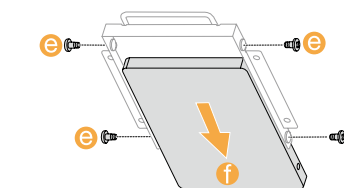
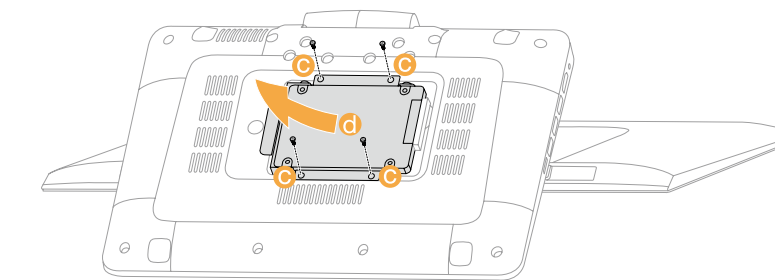
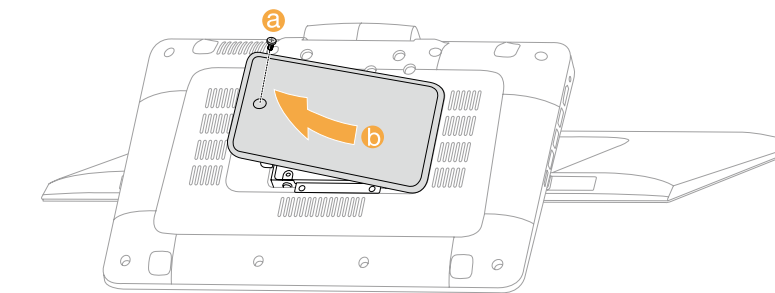

ideacentre AIO 910 Quick Start Guide

The following information refers to ideacentre AIO 910 machine type:
FOC2 [AIO 910-27ISH / Energy Star]

Lenovo, the Lenovo logo and ideacentre are trademarks of Lenovo in the United States, other countries, or both.
Windows is a trademark of the Microsoft group of companies.
Other company, product, or service names may be trademarks or service marks of others.

© Copyright Lenovo 2016. LIMITED AND RESTRICTED RIGHTS NOTICE: If data or software is delivered pursuant to a General Services Administration "GSA" contract, use, reproduction, or disclosure is subject to restrictions set forth in Contract No. GS-35F-05925.



1 Unpack

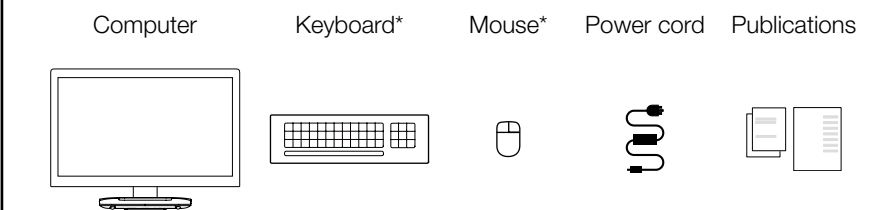

- * Selected models only.
1. Some models may contain items that are not listed.
 2. The descriptions in this guide might be different from what you see on your computer, depending on the computer model and configuration.
 3. Product design and specifications may be changed without notice.

2 Adjust the computer stand

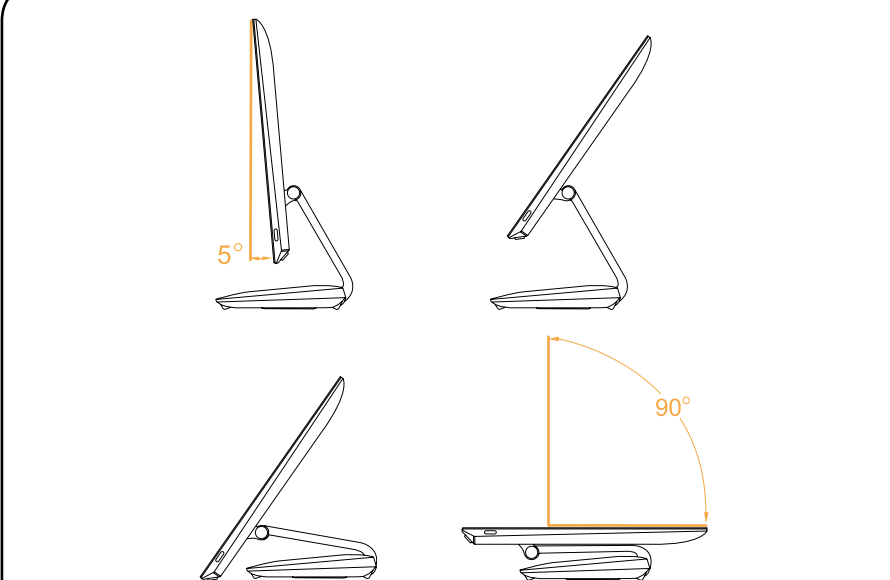

3 Connect the keyboard and mouse

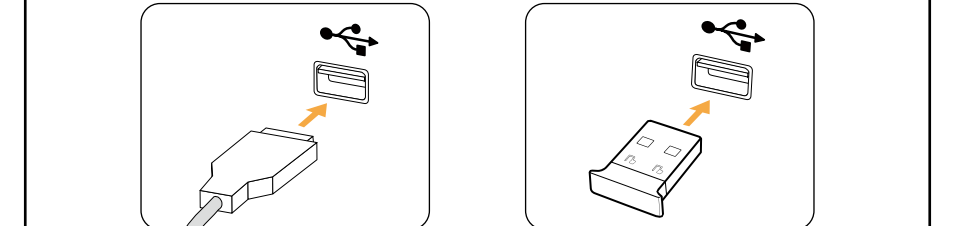

NOTE: If your computer is equipped with a wireless keyboard or mouse, follow the installation instructions for those devices.

4 Connect the power cable

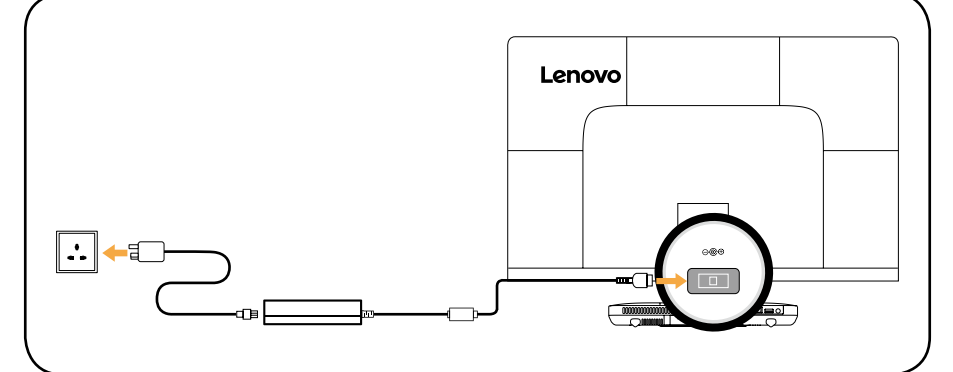

5 Turn on the computer

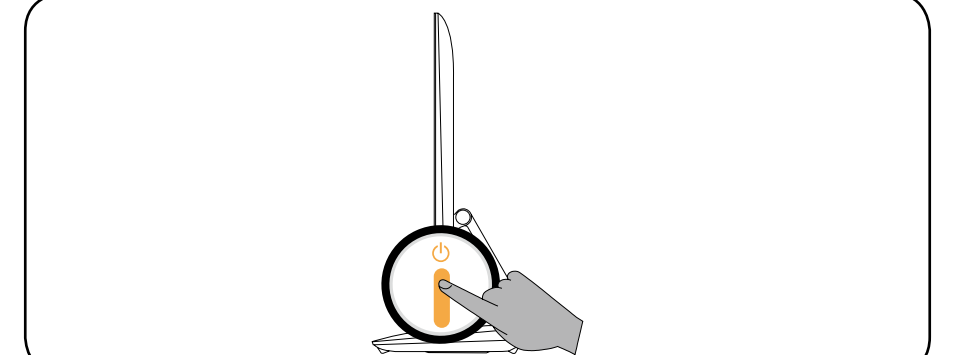

Front view of the computer

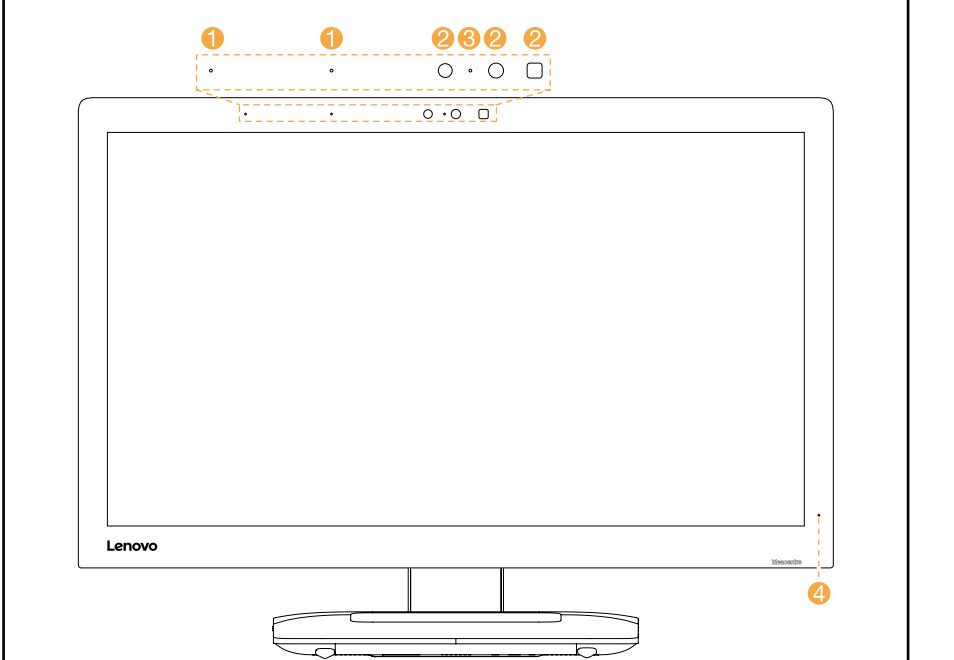

- 1 Built-in microphone
- 2 Built-in camera
- 3 Camera LED indicator
- 4 Power LED indicator

ATTENTION: Be sure not to block any air vents on the computer. Blocked air vents may cause thermal problems.
ATTENTION: If your computer is equipped with an infrared (IR) remote control, do not put the USB IR receiver on the same plane as the screen.

Left and right view of the computer

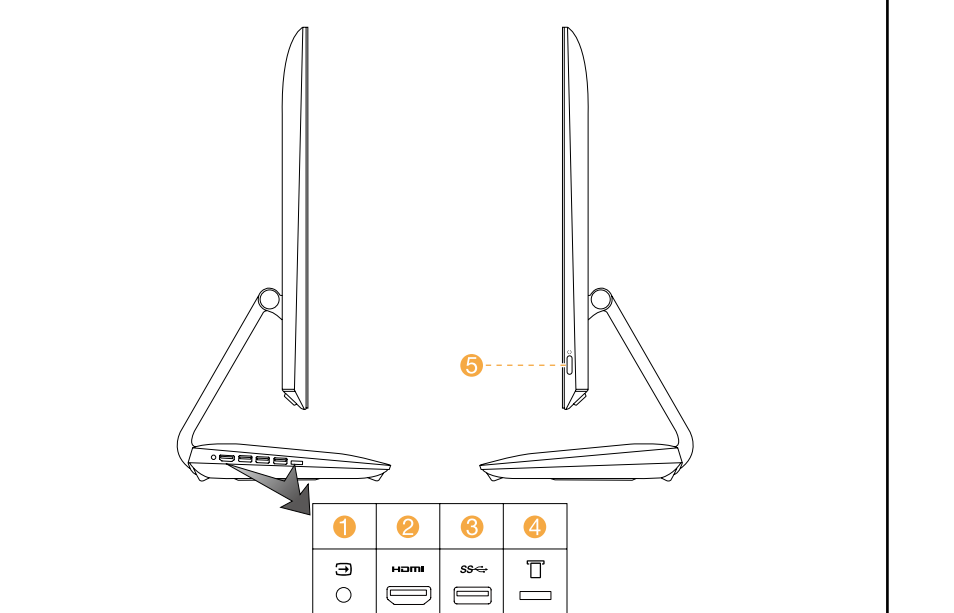

- 1 HDMI in/out switch
- 2 HDMI in/out connector
- 3 USB 3.0 connector
- 4 Memory card reader
- 5 Power button

Rear view of the computer

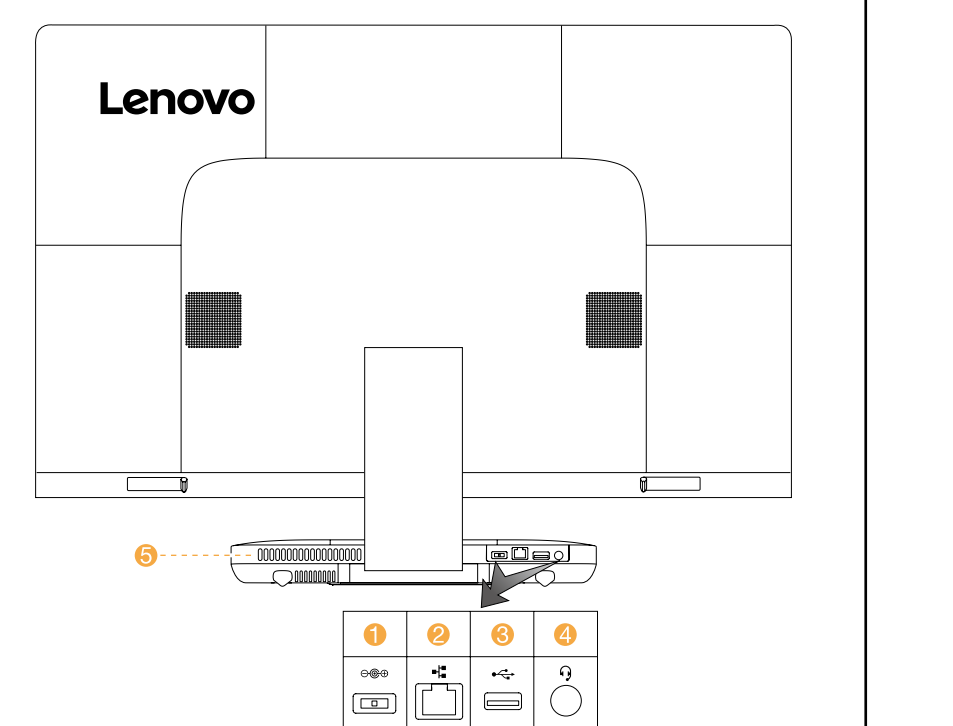

- 1 Power connector
- 2 Ethernet connector
- 3 USB 2.0 connector
- 4 Combo audio jack ¹
- 5 Air vents

¹ Combo audio jack: Used to connect headsets.

NOTES:

- The combo audio jack does not support conventional microphones.
- Different industry standards may lead to the recording function not being supported if third-party headphones or headsets are connected.

Connecting to the Internet

You need a contract with an Internet Service Provider (ISP) and some hardware in order to connect to the Internet. ISPs and the services they offer vary by country. Contact your ISP for services available in your country. Your computer supports wireless (selected models only) or wired networks that connect your computer to other devices.

Wired network connection
For wired networks, connect one end of an Ethernet cable (purchased separately) to the Ethernet connector on your computer, and then connect the other end to the network router or broadband modem. Consult your ISP for detailed setup instructions.

NOTE: Broadband modem and router installation procedures vary depending on the manufacturer. Follow the manufacturer's instructions.

Wireless network connection
For wireless networks, you can use the built-in Wi-Fi antenna to access your wireless home network.
To connect your computer to the wireless network:
Click or tap the network icon on the taskbar, then select the name of your router. Click or tap **Connect**, then follow the steps on the screen.
Test the wireless network by opening your Web browser and accessing any Web site.