

User's Guide

VMG4005-B50A/B60A

VDSL2 17a Bonding and 35b Single Line Bridge

Default Login Details

LAN IP Address	http://192.168.1.1
Login	admin
Password	See the device label

Version 5.15 Ed 1, 9/2019



IMPORTANT!

READ CAREFULLY BEFORE USE.

KEEP THIS GUIDE FOR FUTURE REFERENCE.

Screenshots and graphics in this book may differ slightly from what you see due to differences in your product firmware or your computer operating system. Every effort has been made to ensure that the information in this manual is accurate.

Related Documentation

- Quick Start Guide

The Quick Start Guide shows how to connect the VMG.

- More Information

Go to **support.zyxel.com** to find other information on the VMG.



Document Conventions

Warnings and Notes

These are how warnings and notes are shown in this guide.

Warnings tell you about things that could harm you or your device.

Note: Notes tell you other important information (for example, other things you may need to configure or helpful tips) or recommendations.

Syntax Conventions

- The VMG4005-B50A/B60A may be referred to as the "VMG" in this guide.
- Product labels, screen names, field labels and field choices are all in **bold** font.
- A right angle bracket (>) within a screen name denotes a mouse click. For example, **System Monitor > Traffic Status > LAN** means you first click **System Monitor** in the navigation panel, then the **Traffic Status** sub menu and finally the **LAN** tab to get to that screen.

Icons Used in Figures

Figures in this user guide may use the following generic icons. The VMG icon is not an exact representation of your device.









VMG 	Generic Router 	Laptop Computer 
Switch 	Firewall 	Server 
Internet 	User 	Wireless Device 

Table of Contents

Document Conventions	3
Table of Contents	4
Part I: User's Guide.....	8
Chapter 1	
Introducing the VMG	9
1.1 Overview	9
1.2 Example Applications	9
1.2.1 Internet Access	9
1.3 Manage the VMG	11
1.4 Good Habits for Managing the VMG	11
1.5 Hardware	12
1.5.1 Front Panel	12
1.5.2 LEDs (Lights)	12
1.5.3 Bottom Panel	13
1.5.4 RESET Button	13
Chapter 2	
The Web Configurator.....	14
2.1 Overview	14
2.1.1 Accessing the Web Configurator	14
2.2 Web Configurator Layout	16
2.2.1 Menu Icon	16
Chapter 3	
Quick Start Wizard.....	19
3.1 Overview	19
3.2 Quick Start Wizard Setup	19
3.2.1 Time Zone	19
3.2.2 Internet	20
Part II: Technical Reference.....	22
Chapter 4	
Status.....	23

4.1 Status Overview	23
4.2 System Info	23
Chapter 5	
Log	26
5.1 Log Overview	26
5.1.1 What You Can Do in this Chapter	26
5.1.2 What You Need To Know	26
5.2 System Log	27
5.3 Security Log	27
Chapter 6	
Traffic Status	29
6.1 Traffic Status Overview	29
6.1.1 What You Can Do in this Chapter	29
6.2 WAN Status	29
6.3 LAN Status	30
Chapter 7	
ARP Table	32
7.1 ARP Table Overview	32
7.1.1 How ARP Works	32
7.2 ARP Table Settings	33
Chapter 8	
MAC Address Table	34
8.1 MAC Address Table Overview	34
8.2 MAC Address Table Settings	34
Chapter 9	
xDSL Statistics	35
9.1 xDSL Statistics Overview	35
Chapter 10	
System	38
10.1 System Overview	38
10.2 System Settings	38
Chapter 11	
User Account	39
11.1 User Account Overview	39
11.2 User Account Settings	39
11.2.1 User Account Add/Edit	40

Chapter 12	
Remote Management	42
12.1 Remote Management Overview	42
12.1.1 What You Can Do in this Chapter	42
12.2 MGMT Services	42
12.3 Trust Domain	43
12.3.1 Add Trust Domain	44
Chapter 13	
Time Settings	45
13.1 Time Settings Overview	45
13.2 Time Setup	45
Chapter 14	
Log Setting	48
14.1 Logs Setting Overview	48
14.2 Log Setup	48
Chapter 15	
Firmware Upgrade	51
15.1 Firmware Upgrade Overview	51
15.2 Firmware Settings	51
Chapter 16	
Backup/Restore	54
16.1 Backup/Restore Overview	54
16.2 Backup/Restore Settings	54
16.3 Reboot	56
Chapter 17	
Diagnostic	58
17.1 Diagnostic Overview	58
17.1.1 What You Can Do in this Chapter	58
17.2 What You Need to Know	58
17.3 Ping & TraceRoute & Nslookup	59
17.4 802.1ag (CFM)	60
17.5 802.3ah (OAM)	61
17.6 OAM Ping	62
Part III: Troubleshooting and Appendices	65

Chapter 18
Troubleshooting.....66

- 18.1 Power, Hardware Connections, and LEDs 66
- 18.2 VMG Access and Login 67
- 18.3 Internet Access 68
- 18.4 IP Address Setup 69

Appendix A Customer Support 73

Appendix B Legal Information 79

Index84

PART I

User's Guide

CHAPTER 1

Introducing the VMG

1.1 Overview

The following table describes the feature difference of the VMG by model.

Table 1 VMG Comparison Table

	VMG4005-B50A	VMG4005-B60A	DESCRIPTION
Annex A (ADSL over POTS)	V	-	The telephone line carries voice and ADSL. If you have standard analog lines (POTS) and your ADSL is coming over POTS, you need to use Annex A.
Annex B (ADSL over ISDN, can be used on normal POTS lines as well)	-	V	Voice, ISDN (Integrated Services Digital Network) and ADSL are on the same line. If you have ISDN line or telephone and your ADSL is coming over ISDN, you need to use Annex B.

The VMG is a VDSL modem, which provides fast Internet access over a plain telephone wire. After you make the connections and turn it on, the VMG can automatically access the Internet. Refer to [Section 18.3 on page 68](#) if you cannot access the Internet.

It also supports VDSL bonding that allows the combining of DSL connections for even faster speeds. Universal Plug and Play (UPnP) where UPnP devices can dynamically join the VMG network is also supported.

You can use the Web Configurator to view traffic statistics, upload firmware and allow external management of the VMG.

1.2 Example Applications

This section shows a few examples of using the VMG in various network environments. Note that the VMG in the figure is just an example VMG and not your actual VMG.

1.2.1 Internet Access

Your VMG provides shared Internet access by connecting the DSL port to the **DSL** or **MODEM** jack on a splitter or your telephone jack. You can have multiple WAN services over one ADSL or VDSL. The VMG cannot work in ADSL and VDSL mode at the same time.

A computer, gateway, or router can connect to the VMG's LAN port.

Figure 1 VMG's Internet Access Application

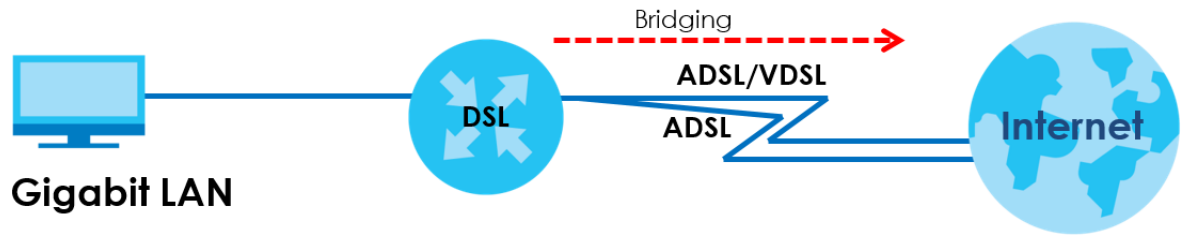

DSL Bonding

DSL bonding allows the VMG to aggregate two DSL lines into a virtual connection. The VMG will have higher bandwidth and faster transmission speed at longer distances. Note that the two DSL lines must come from the same ISP, and they both need to support DSL bonding. Also, only DSL 1 supports telephone service.

To set up your network for DSL bonding:

Example 1

- 1 Connect a two-line splitter to the VMG (DSL in the figure).
- 2 Connect two DSL lines to the two-line splitter.
- 3 Connect the two DSL lines to two separate telephone jacks (Wall).

Figure 2 VMG's Internet Access Application: DSL Bonding (Example 1)

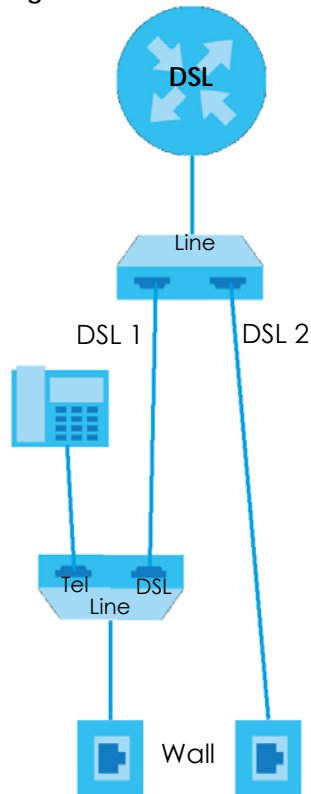

Example 2

Connect the DSL port on the VMG (**DSL** in the figure) to a telephone jack.

The ISP will split the DSL connection at their end for DSL 1 and DSL 2 bonding.

Figure 3 VMG's Internet Access Application: DSL Bonding (Example 2)

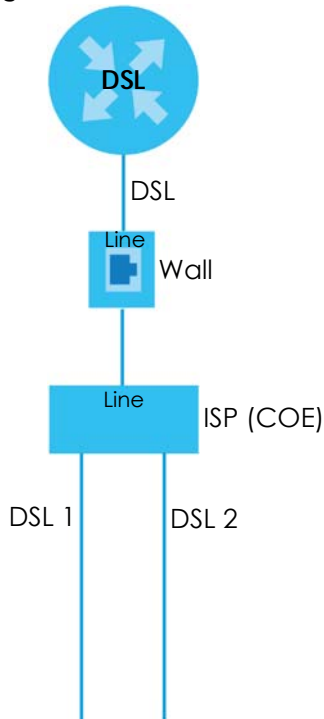

1.3 Manage the VMG

Use the Web Configurator for management of the VMG using a (supported) web browser.

1.4 Good Habits for Managing the VMG

Do the following things regularly to make the VMG more secure and to manage the VMG more effectively.

- Change the Web Configurator password. Use a password that is not easy to guess and that consists of different types of characters, such as numbers and letters.
- Write down the password and put it in a safe place.
- Back up the configuration (and make sure you know how to restore it). Restoring an earlier working configuration may be useful if the device becomes unstable or even crashes. If you forget your password, you will have to reset the VMG to its factory default settings. If you backed up an earlier configuration file, you would not have to totally re-configure the VMG. You could simply restore your last configuration.

1.5 Hardware

This section describes the front and rear panels for each model. Refer to the VMG's Quick Start Guides to see the product drawings and how to make the hardware connections.

1.5.1 Front Panel

The LED indicators are located on the front panel.

Figure 4 Front Panel

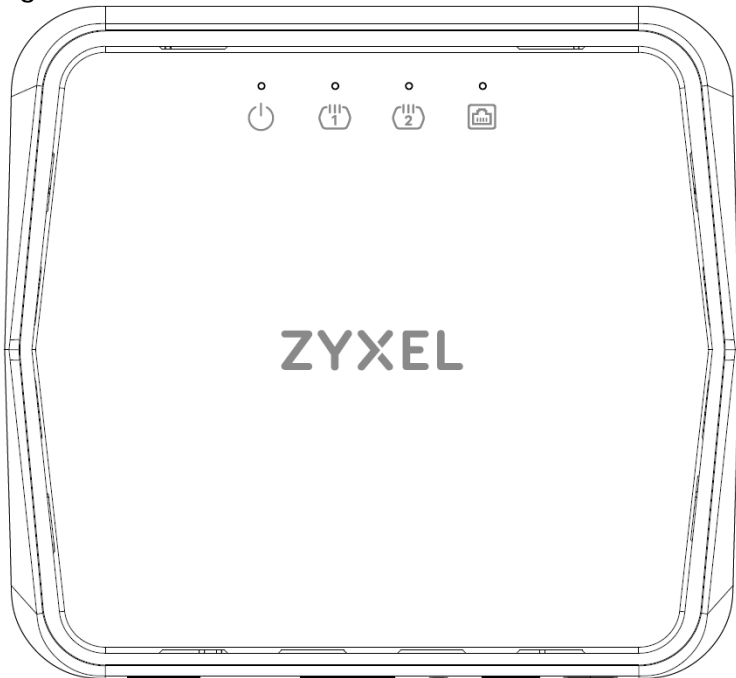

1.5.2 LEDs (Lights)

None of the LEDs are on if the VMG is not receiving power.

Table 2 LED Descriptions





LED	COLOR	STATUS	DESCRIPTION
 Power	Green	On	The VMG is receiving power and ready for use.
		Blinking	The VMG is in the booting state and getting ready for use.
	Red	On	The VMG detected an error while self-testing, or there is a device malfunction.
		Blinking	The VMG is uploading firmware.
		Off	The VMG is not receiving power.
  DSL1 DSL2	Green	On	The ADSL/VDSL line is up.
		Blinking	The VMG is initializing the ADSL/VDSL line.
		Off	The DSL line is down.

Table 2 LED Descriptions (continued)

LED	COLOR	STATUS	DESCRIPTION
 Ethernet	Green	On	The VMG has a successful 10/100/1000 Mbps Ethernet connection with a device on the Local Area Network (LAN).
		Blinking	The VMG is sending or receiving data to/from the LAN at 10/100/1000 Mbps.
		Off	The VMG does not have an Ethernet connection with the LAN.

1.5.3 Bottom Panel

The connection ports are located on the bottom panel.

Figure 5 Bottom Panel

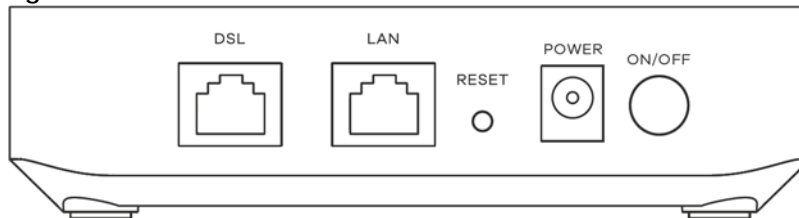

The following table describes the items on the bottom panel.

Rear Panel Ports

LABEL	DESCRIPTION
DSL	Connect a RJ-45 cable to the DSL port for Internet access.
LAN	Connect a router/gateway to the Ethernet port for Internet access.
Reset	Press the button to return the VMG to the factory defaults.
Power	Connect the power adapter and then can press the power button to start the VMG.

1.5.4 RESET Button

If you forget your password or cannot access the Web Configurator, you will need to use the **RESET** button to reload the factory-default configuration file. This means that you will lose all configurations that you had previously. The password will be reset to the factory default (see the device label), and the LAN IP address will be "192.168.1.1".

- 1 Make sure the **POWER** LED is on (not blinking).
- 2 To set the device back to the factory default settings, press the **RESET** button for more than 5 seconds or until the **POWER** LED begins to blink and then release it. When the **POWER** LED begins to blink, the defaults have been restored and the device restarts.

CHAPTER 2

The Web Configurator

2.1 Overview

The Web Configurator is an HTML-based management interface that allows easy VMG setup and management via Internet browser. Use Internet Explorer 11 and later versions or Mozilla Firefox 67.0.2 and later versions or Safari 5.0 and later versions. The recommended screen resolution is 1024 by 768 pixels.

In order to use the Web Configurator you need to allow:

- Web browser pop-up windows from your VMG. Web pop-up blocking is enabled by default in Windows 10.
- JavaScript (enabled by default).
- Java permissions (enabled by default).

2.1.1 Accessing the Web Configurator

- 1 Make sure your VMG hardware is properly connected (refer to the Quick Start Guide).
- 2 Make sure your computer has an IP address in the same subnet as the VMG. Your computer should have an IP address from 192.168.1.2 to 192.168.1.254. See [Section 18.4 on page 69](#) for details.
- 3 Launch your web browser. If the VMG does not automatically re-direct you to the login screen, go to <http://192.168.1.1>.
- 4 A login screen displays. Select a language you prefer.
- 5 To access the administrative Web Configurator and manage the VMG, type the default username **admin** and the randomly assigned default password (see the device label) in the login screen and click **Login**. If you have changed the password, enter your password and click **Login**.

Figure 6 Login Screen

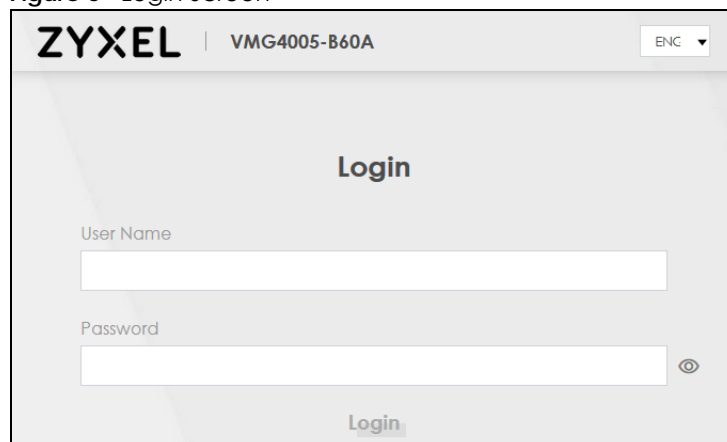

The screenshot shows a web browser window with the title "ZYXEL | VMG4005-B60A" and a language dropdown menu set to "ENG". The main heading is "Login". Below the heading are two input fields: "User Name" and "Password". The "Password" field has a small eye icon to its right, indicating a toggle for password visibility. At the bottom center of the form is a "Login" button.

Note: The default allowable times that you can enter the **Password** is 3. If you entered the wrong password for the fourth time, by default the Web Configurator will lock itself for 5 minutes before you can try entering the correct **Password** again. You can change these settings in **Maintenance > User Account > Add New / Edit Account** (see [Section 11.2.1 on page 40](#)).

- 6 The following screen may display when you log into the Web Configurator for the first time. Enter a new password, retype it to confirm, and click **Change password**. If you prefer to use the default password, click **Skip**.

Figure 7 Change Password Screen

The screenshot shows a 'Password Reset' screen with the following elements:

- Title:** Password Reset
- Input Fields:**
 - New Password: A text input field with a toggle icon (eye) to its right.
 - Password: A text input field with a toggle icon (eye) to its right.
- Buttons:**
 - Change password: A button with a light blue background.
 - Skip: A button with a light blue background, positioned below the 'Change password' button.

- 7 The **Connection Status** page appears. See [Chapter 4 on page 23](#) for details.

Figure 8 Connection Status

The screenshot shows the 'Connection Status' page with the following sections:

- ZYXEL | VMG4005-B60A**
- Management Service**

HTTP	Disable
HTTPS	LAN/WAN
FTP	Disable
TELNET	Disable
SSH	WAN
PING	LAN/WAN
- System Info**

Model Name	VMG4005-B60A
Firmware Version	V5.15(ABQA.0)b4_20190812
System Uptime	0 days 2 hours 13 mins 27 secs
LAN MAC Address	CC:D4:A1:AF:88:98
DSL1 Status	Connection down
DSL2 Status	Connection down
- Ethernet UNI**

Administrative status of UNI	Up
Link State of UNI	Up
Speed State	100 (Mbps)
Duplex State	Full

2.2 Web Configurator Layout

Figure 9 Screen Layout

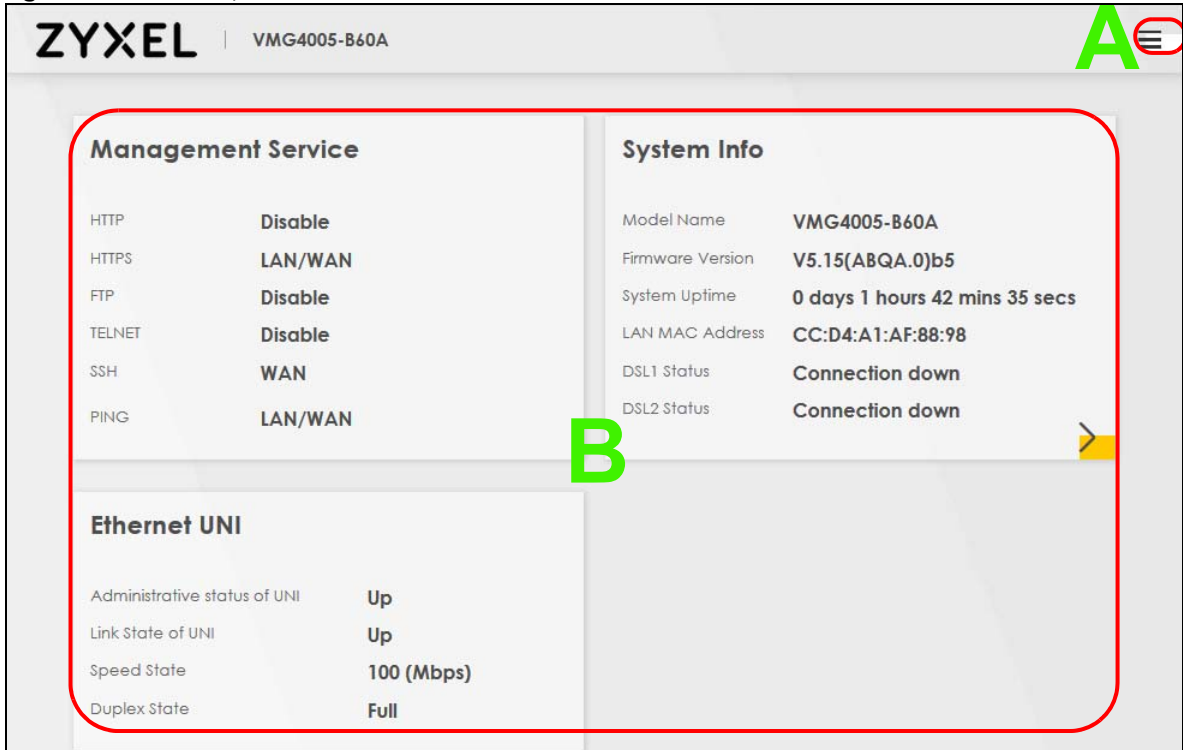

As illustrated above, the main screen is divided into these parts:

- A - Menu Icon (Navigation Panel)
- B - Main Window

2.2.1 Menu Icon

Click this icon (☰) to display the navigation panel that contains configuration menus and quick links.







2.2.1.1 Quick Links

The quick links provides some icons on the right hand side.

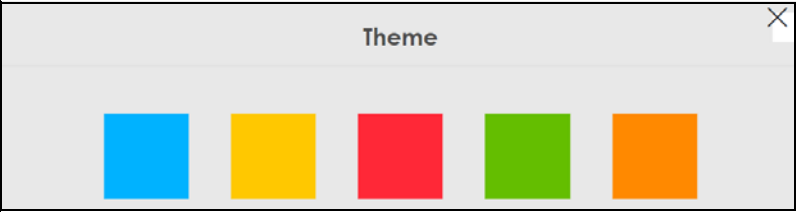

The icons provide the following functions.

Table 3 Quick Link Icons

ICON	DESCRIPTION
 Wizard	Wizard: Click this icon to open screens where you can configure the VMG's time zone Internet access, and wireless settings. See Chapter 3 on page 19 for more information about the Wizard screens.
 Theme	Theme: Click this icon to select a color that you prefer and apply it to the Web Configurator. 
 Language	Language: Select the language you prefer.
 Restart	Restart: Click this icon to reboot the VMG without turning the power off.
 Logout	Logout: Click this icon to log out of the Web Configurator.

2.2.1.2 Navigation Panel

Use the menu items on the navigation panel to open screens to configure VMG features. The following tables describe each menu item.

Note: The menu items on the navigation panel vary among the models. See [Section 1.1 on page 9](#) for more information about the feature differences of the VMG.

Table 4 Navigation Panel Summary

LINK	TAB	FUNCTION
Connection Status		Use this screen to view the network status of the VMG and computers/devices connected to it.
System Monitor		
Log	System Log	Use this screen to view the status of events that occurred to the VMG. You can export or email the logs.
	Security Log	Use this screen to view all security related events. You can select level and category of the security events in their proper drop-down list window.
Traffic Status	WAN	Use this screen to view the status of all network traffic going through the WAN port of the VMG.
	LAN	Use this screen to view the status of all network traffic going through the LAN ports of the VMG.
ARP Table	ARP Table	Use this screen to view the ARP table. It displays the IP and MAC address of each DHCP connection.
MAC Address Table	MAC Address Table	Use this screen to view the MAC address table. It displays the MAC address of each client device and the VLAN group of each associated wired client.
xDSL Statistics	xDSL Statistics	Use this screen to view the VMG's xDSL traffic statistics.
Maintenance		
System	System	Use this screen to set VMG name and Domain name.
User Account	User Account	Use this screen to change user password on the VMG.
Remote Management	MGMT Services	Use this screen to enable specific traffic directions for network services.
	Trust Domain	Use this screen to view a list of public IP addresses which are allowed to access the VMG through the services configured in the Maintenance > Remote Management > MGMT Services screen.
Time	Time	Use this screen to change your VMG's time and date.
Log Settings	Log Setting	Use this screen to change your VMG's log settings.
Firmware Upgrade	Firmware Upgrade	Use this screen to upload firmware to your VMG.
Backup/Restore	Backup/Restore	Use this screen to backup and restore your VMG's configuration (settings) or reset the factory default settings.
Reboot	Reboot	Use this screen to reboot the VMG without turning the power off.
Diagnostic	Ping&Traceroute &Nslookup	Use this screen to identify problems with the VMG. You can use Ping, TraceRoute, or Nslookup to help you identify problems.
	802.1ag	Use this screen to configure CFM (Connectivity Fault Management) MD (maintenance domain) and MA (maintenance association), perform connectivity tests and view test reports.
	802.3ah	Use this screen to configure link OAM port parameters,
	OAM Ping	Use this screen to view information to help you identify problems with the DSL connection.

CHAPTER 3

Quick Start Wizard

3.1 Overview

Use the **Wizard** screens to configure the VMG's time zone and check Internet access.

3.2 Quick Start Wizard Setup

You can click the **Wizard** icon in the navigation panel to open the **Wizard** screens. See [Section 2.2.1.1 on page 17](#) for more information about the navigation panel. After you click the **Wizard** icon, the following screen appears. Click **Let's go** to proceed with settings on time zone, basic Internet access, and wireless networks. It will take you a few minutes to complete the settings on the **Wizard** screens. You can also click **Skip** to leave the **Wizard** screens.

Figure 10 Wizard - Home

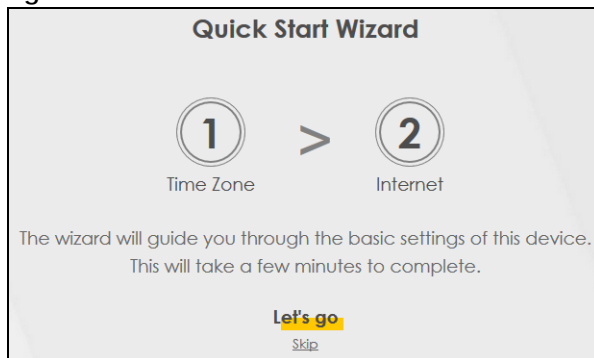

3.2.1 Time Zone

Select the time zone of your location. Click **Next**.

Figure 11 Wizard - Time Zone

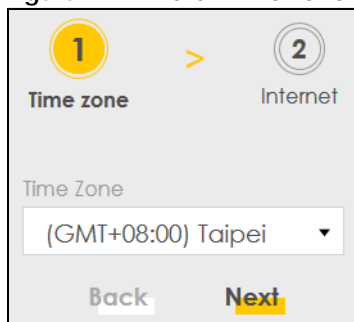

3.2.2 Internet

The VMG will check the Internet status automatically. Click **Next** to proceed. You can also click **Skip** to pass checking of Internet connectivity in the **Wizard**.

Figure 12 Wizard - Internet

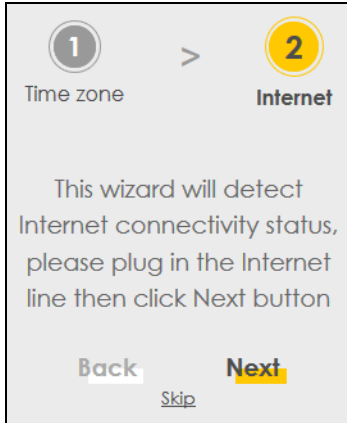

Internet Status

The VMG is checking the Internet status.

Figure 13 Wizard - Internet Check

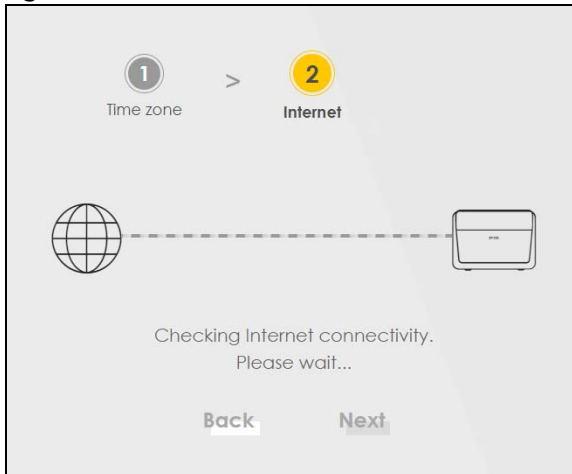

Internet Connection

The VMG has Internet access. Click **Next** to return to the **Status** screen.

Figure 14 Wizard - Successful WAN Connection

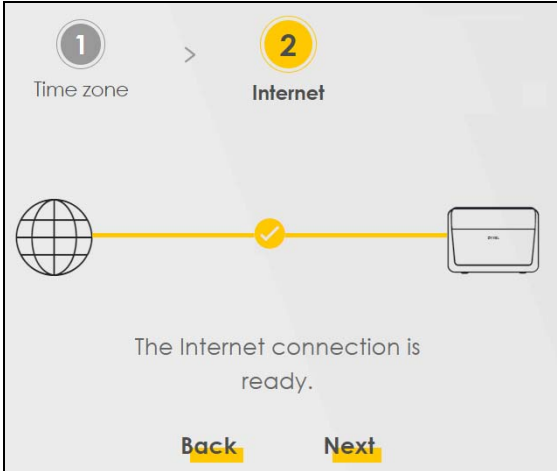

If the VMG did not detect a WAN connection, connect a DSL cable for Internet access if you have not connected any.

Figure 15 Wizard - WAN Connection is Down

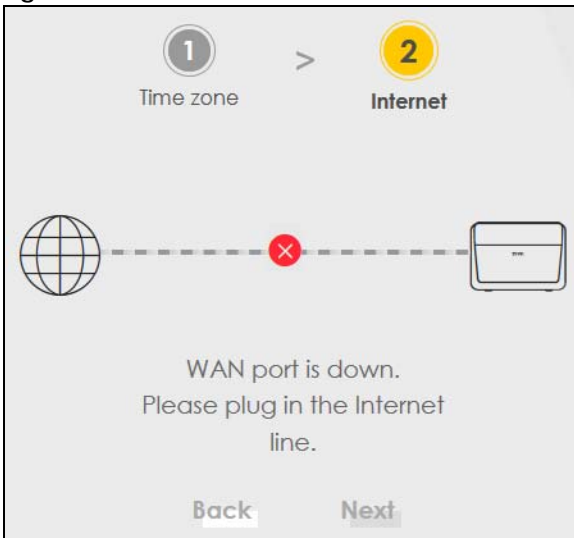

PART II

Technical Reference

CHAPTER 4

Status

4.1 Status Overview

After you log into the Web Configurator, the **Status** screen appears. It shows the **Management Service**, **System Info**, and **Ethernet UNI** of the VMG.

4.2 System Info

Use this screen to view the basic system information of the VMG.

Figure 16 System Info

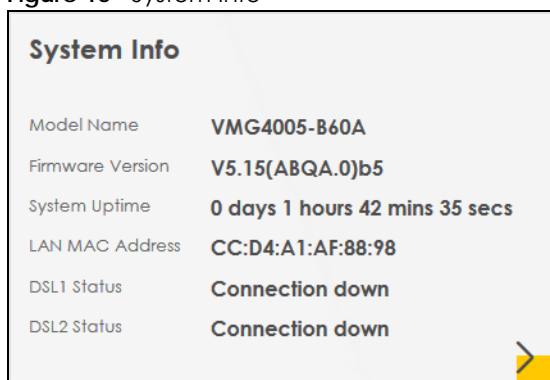

System Info	
Model Name	VMG4005-B60A
Firmware Version	V5.15(ABQA.0)b5
System Uptime	0 days 1 hours 42 mins 35 secs
LAN MAC Address	CC:D4:A1:AF:88:98
DSL1 Status	Connection down
DSL2 Status	Connection down

Click the Arrow icon () to open the following screen. Use this screen to view more system information, WAN/LAN/Firewall information, interface status (LAN and DSL), and usage of system resource.

Figure 17 System Info: Detailed Information



Each field is described in the following table.

Table 5 System Info: Detailed Information

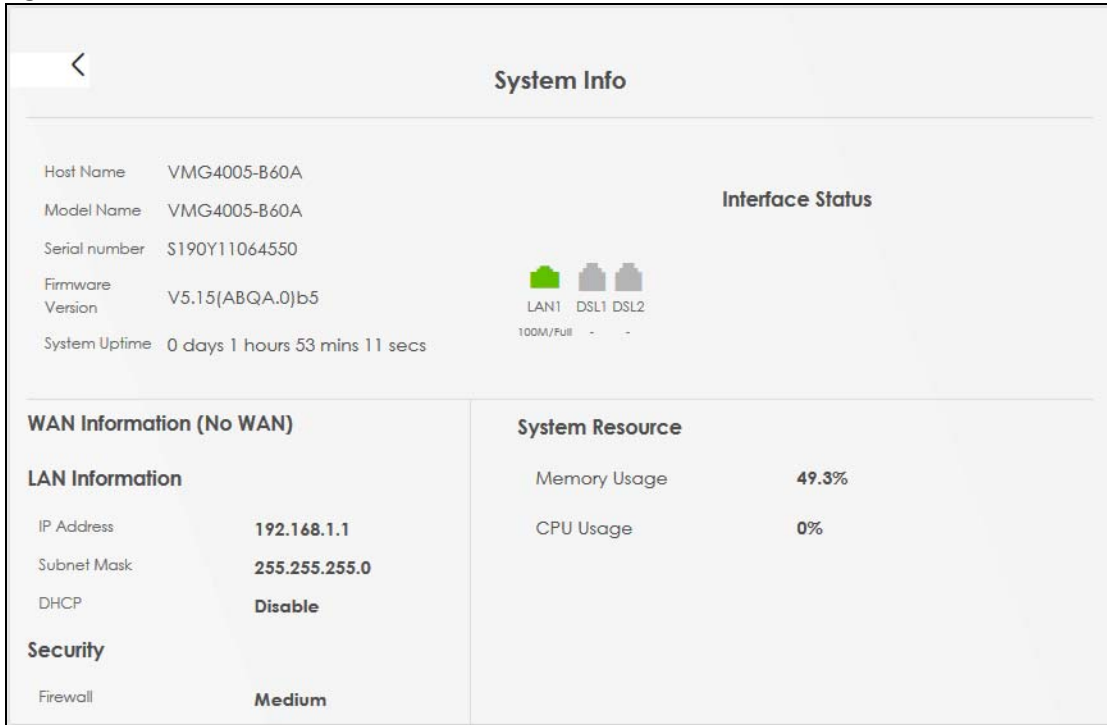
LABEL	DESCRIPTION
Host Name	This field displays the VMG system name. It is used for identification.
Model Name	This shows the model number of your VMG.
Serial Number	This field displays the serial number of the VMG.
Firmware Version	This is the current version of the firmware on the VMG.
System Up Time	This field displays how long the VMG has been running since it last started up. The VMG starts up when you plug it in, when you restart it (Maintenance > Reboot), or when you reset it.
Interface Status	
Virtual ports are shown here. You can see whether the ports are in use and their transmission rate.	
WAN Information (These fields display when you have an Internet connection.)	
Encapsulation	This field displays the current encapsulation method.
IP Address	This field displays the current IPv4 address of the VMG in the WAN.
IP Subnet Mask	This field displays the current subnet mask in the WAN.
IPv6 Address	This field displays the current IPv6 address of the VMG in the WAN.
MAC Address	This shows the WAN Ethernet adapter MAC (Media Access Control) address of your VMG.
Primary DNS server	This field displays the first DNS server address assigned by the ISP.
Secondary DNS server	This field displays the second DNS server address assigned by the ISP.
Primary DNSv6 server	This field displays the first DNS server IPv6 address assigned by the ISP.
Secondary DNSv6 server	This field displays the second DNS server IPv6 address assigned by the ISP.

Table 5 System Info: Detailed Information (continued)

LABEL	DESCRIPTION
LAN Information (These fields display information about the LAN port.)	
IP Address	This is the current IPv4 address of the VMG.
Subnet Mask	This is the current subnet mask.
DHCP	<p>This field displays what DHCP services the VMG is providing to the LAN. The possible values are:</p> <p>Server - The VMG is a DHCP server in the LAN. It assigns IP addresses to other computers in the LAN.</p> <p>Relay - The VMG acts as a surrogate DHCP server and relays DHCP requests and responses between the remote server and the clients.</p> <p>None - The VMG is not providing any DHCP services to the LAN.</p>
Security	
Firewall	This displays the firewall's current security level.
System Resource	
Memory Usage	This field displays what percentage of the VMG's memory is currently used. Usually, this percentage should not increase much. If memory usage does get close to 100%, the VMG is probably becoming unstable, and you should restart the device.
CPU Usage	This field displays what percentage of the VMG's processing ability is currently used. When this percentage is close to 100%, the VMG is running at full load, and the throughput is not going to improve anymore. If you want some applications to have more throughput, you should turn off other applications (for example, using QoS).

CHAPTER 5

Log

5.1 Log Overview

These screens allow you to determine the categories of events that the VMG logs and then display these logs or have the VMG send them to an administrator (through email) or to a syslog server.

5.1.1 What You Can Do in this Chapter

- Use the **System Log** screen to see the system logs ([Section 5.2 on page 27](#)).
- Use the **Security Log** screen to see the security-related logs for the categories that you select ([Section 5.3 on page 27](#)).

5.1.2 What You Need To Know

The following terms and concepts may help as you read this chapter.

Alerts and Logs

An alert is a type of log that warrants more serious attention. They include system errors, attacks (access control) and attempted access to blocked web sites. Some categories such as **System Errors** consist of both logs and alerts. You may differentiate them by their color in the **View Log** screen. Alerts display in red and logs display in black.

Syslog Overview

The syslog protocol allows devices to send event notification messages across an IP network to syslog servers that collect the event messages. A syslog-enabled device can generate a syslog message and send it to a syslog server.

Syslog is defined in RFC 3164. The RFC defines the packet format, content and system log related information of syslog messages. Each syslog message has a facility and severity level. The syslog facility identifies a file in the syslog server. Refer to the documentation of your syslog program for details. The following table describes the syslog severity levels.

Table 6 Syslog Severity Levels

CODE	SEVERITY
0	Emergency: The system is unusable.
1	Alert: Action must be taken immediately.
2	Critical: The system condition is critical.
3	Error: There is an error condition on the system.
4	Warning: There is a warning condition on the system.
5	Notice: There is a normal but significant condition on the system.

Table 6 Syslog Severity Levels

CODE	SEVERITY
6	Informational: The syslog contains an informational message.
7	Debug: The message is intended for debug-level purposes.

5.2 System Log

Use the **System Log** screen to see the system logs. You can filter the entries by clicking on the **Level** and/or **Category** drop-down list boxes. Click **System Monitor > Log** to open the **System Log** screen.

Figure 18 System Monitor > Log > System Log

All system events will be logged and displayed in the following table. Select a level from the pull-down menu to show filtered results.

Level: Category: [Clear Log](#) [Refresh](#) [Export Log](#)

#	Time	Facility	Level	Category	Messages
---	------	----------	-------	----------	----------

The following table describes the fields in this screen.

Table 7 System Monitor > Log > System Log

LABEL	DESCRIPTION
Level	Select a severity level from the drop-down list box. This filters search results according to the severity level you have selected. When you select a severity, the VMG searches through all logs of that severity or higher.
Category	Select the type of logs to display.
Clear Log	Click this to delete all the logs.
Refresh	Click this to renew the log screen.
Export Log	Click this to export the selected log(s).
#	This field is a sequential value and is not associated with a specific entry.
Time	This field displays the time the log was recorded.
Facility	The log facility allows you to send logs to different files in the syslog server. Refer to the documentation of your syslog program for more details.
Level	This field displays the severity level of the log that the device is to send to this syslog server.
Category	This field displays the type of the log.
Messages	This field states the reason for the log.

5.3 Security Log

Use the **Security Log** screen to see the security-related logs for the categories that you select. You can filter the entries by clicking on the **Level** and/or **Category** drop-down list boxes. Click **System Monitor > Log > Security Log** to open the following screen.

Figure 19 System Monitor > Log > Security Log

All security events will be logged and displayed in the following table. Select a level from the pull-down menu to show filtered results.

Level Category [Clear Log](#) [Refresh](#) [Export Log](#)

#	Time	Facility	Level	Category	Messages
---	------	----------	-------	----------	----------

The following table describes the fields in this screen.

Table 8 System Monitor > Log > Security Log

LABEL	DESCRIPTION
Level	Select a severity level from the drop-down list box. This filters search results according to the severity level you have selected. When you select a severity, the VMG searches through all logs of that severity or higher.
Category	Select the type of logs to display.
Clear Log	Click this to delete all the logs.
Refresh	Click this to renew the log screen.
Export Log	Click this to export the selected log(s).
#	This field is a sequential value and is not associated with a specific entry.
Time	This field displays the time the log was recorded.
Facility	The log facility allows you to send logs to different files in the syslog server. Refer to the documentation of your syslog program for more details.
Level	This field displays the severity level of the log that the device is to send to this syslog server.
Category	This field displays the type of the log.
Messages	This field states the reason for the log.

CHAPTER 6

Traffic Status

6.1 Traffic Status Overview

Use the **Traffic Status** screens to look at the network traffic status and statistics of the DSL and LAN interfaces.

6.1.1 What You Can Do in this Chapter

- Use the **WAN** screen to view the DSL traffic statistics ([Section 6.2 on page 29](#)).
- Use the **LAN** screen to view the LAN traffic statistics ([Section 6.3 on page 30](#)).

6.2 WAN Status

Click **System Monitor > Traffic Status** to open the **WAN** screen. The figures in this screen show the number of bytes received and sent through the VMG. Detailed information about each interface are listed in the tables below.

Figure 20 System Monitor > Traffic Status > WAN

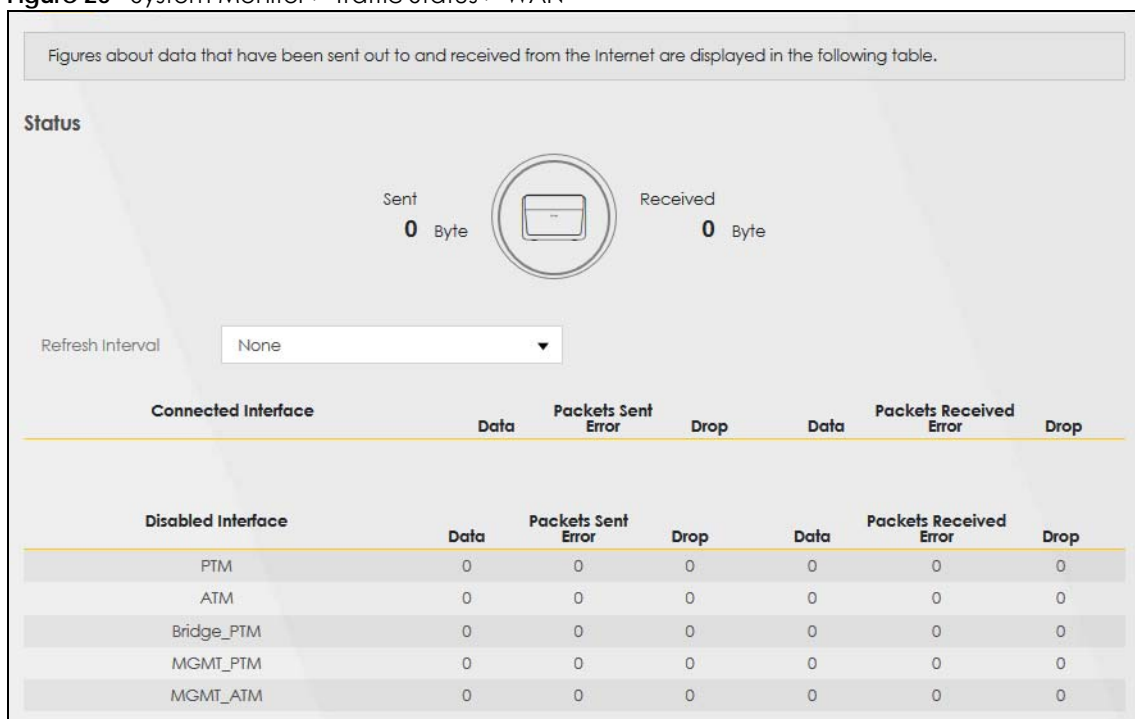

The following table describes the fields in this screen.

Table 9 System Monitor > Traffic Status > WAN

LABEL	DESCRIPTION
Refresh Interval	Select how often you want the VMG to update this screen.
Connected Interface	This shows the name of the WAN interface that is currently connected.
Packets Sent	
Data	This indicates the number of transmitted packets on this interface.
Error	This indicates the number of frames with errors transmitted on this interface.
Drop	This indicates the number of outgoing packets dropped on this interface.
Packets Received	
Data	This indicates the number of received packets on this interface.
Error	This indicates the number of frames with errors received on this interface.
Drop	This indicates the number of received packets dropped on this interface.
Disabled Interface	This shows the name of the WAN interface that is currently disabled.
Packets Sent	
Data	This indicates the number of transmitted packets on this interface.
Error	This indicates the number of frames with errors transmitted on this interface.
Drop	This indicates the number of outgoing packets dropped on this interface.
Packets Received	
Data	This indicates the number of received packets on this interface.
Error	This indicates the number of frames with errors received on this interface.
Drop	This indicates the number of received packets dropped on this interface.

6.3 LAN Status

Click **System Monitor > Traffic Status > LAN** to open the following screen. The figures in this screen show the number of bytes received and sent from each LAN port and wireless network.

Figure 21 System Monitor > Traffic Status > LAN

Figures about data that have been sent to and received from each LAN port (including WiFi) are displayed in the following table.

Refresh Interval: 15 seconds

Interface	LAN1
Bytes Sent	679845
Bytes Received	96085

Interface	LAN1	
Sent (Packet)	Data	746
	Error	0
	Drop	0
Received (Packet)	Data	663
	Error	0
	Drop	0

The following table describes the fields in this screen.

Table 10 System Monitor > Traffic Status > LAN

LABEL	DESCRIPTION
Refresh Interval	Select how often you want the VMG to update this screen.
Interface	This shows the LAN interface.
Bytes Sent	This indicates the number of bytes transmitted on this interface.
Bytes Received	This indicates the number of bytes received on this interface.
Interface	This shows the LAN interface.
Sent (Packets)	
Data	This indicates the number of transmitted packets on this interface.
Error	This indicates the number of frames with errors transmitted on this interface.
Drop	This indicates the number of outgoing packets dropped on this interface.
Received (Packets)	
Data	This indicates the number of received packets on this interface.
Error	This indicates the number of frames with errors received on this interface.
Drop	This indicates the number of received packets dropped on this interface.

CHAPTER 7

ARP Table

7.1 ARP Table Overview

Address Resolution Protocol (ARP) is a protocol for mapping an Internet Protocol address (IP address) to a physical machine address, also known as a Media Access Control or MAC address, on the local area network.

An IP (version 4) address is 32 bits long. MAC addresses are 48 bits long. The ARP Table maintains an association between each MAC address and its corresponding IP address.

7.1.1 How ARP Works

When an incoming packet destined for a host device on a local area network arrives at the device, the device's ARP program looks in the ARP Table and, if it finds the address, sends it to the device.

If no entry is found for the IP address, ARP broadcasts the request to all the devices on the LAN. The device fills in its own MAC and IP address in the sender address fields, and puts the known IP address of the target in the target IP address field. In addition, the device puts all ones in the target MAC field (FF.FF.FF.FF.FF.FF is the Ethernet broadcast address). The replying device (which is either the IP address of the device being sought or the router that knows the way) replaces the broadcast address with the target's MAC address, swaps the sender and target pairs, and unicasts the answer directly back to the requesting machine. ARP updates the ARP Table for future reference and then sends the packet to the MAC address that replied.

7.2 ARP Table Settings

Use the ARP table to view the IPv4-to-MAC address mapping(s) for the LAN. The neighbor table shows the IPv6-to-MAC address mapping(s) of each neighbor. To open this screen, click **System Monitor > ARP Table**.

Figure 22 System Monitor > ARP Table

ARP Table			
ARP Table displays the IPv4 address and MAC address of each DHCP connection. Neighbour Table displays the IPv6 address and MAC address of each Neighbour.			
IPv4 ARP Table			
#	IPv4 Address	MAC Address	Device
1	192.168.1.13	dc:4a:3e:40:ec:5f	br0
IPv6 Neighbour Table			
#	IPv6 Address	MAC Address	Device
1	fe80::ecad:ab45:c530:cc3f	dc:4a:3e:40:ec:5f	br0

The following table describes the labels in this screen.

Table 11 System Monitor > ARP Table

LABEL	DESCRIPTION
#	This is the ARP table entry number.
IPv4/IPv6 Address	This is the learned IPv4 or IPv6 IP address of a device connected to a port.
MAC Address	This is the MAC address of the device with the listed IP address.
Device	This is the type of interface used by the device. You can click on the device type to go to its configuration screen.

CHAPTER 8

MAC Address Table

8.1 MAC Address Table Overview

The MAC address (media access control address) of a device is a unique identifier assigned to a network interface controller for communications at the data link layer of a network segment. This table lists the MAC address of each client device. VLAN information also shows when this device belongs to a VLAN group.

Note: The MAC address of the VMG can be found in the **System Info** of the **Status** screen (see [Section 4.2 on page 23](#) for details).

8.2 MAC Address Table Settings

Aside from the MAC address, the VLAN information of the associated wired clients are also listed in the table. If the wired client does not tag with VLAN, the VLAN entry for this client is **0**.

Click **System Monitor > MAC Address Table** to open the following screen.

Figure 23 System Monitor > MAC Address Table

#	VLAN	MAC Address	Device
1	0	dc:4a:3e:40:ec:5f	eth1.0

The following table describes the labels in this screen.

Table 12 System Monitor > MAC Address Table

LABEL	DESCRIPTION
#	This is the MAC address table entry number.
VLAN	This is the VLAN information of the associated wired clients. This displays 0 when the wired client does not tag with VLAN.
MAC Address	This is the MAC address of the wired client's device.
Device	This is the type of interface used by the wired client's device.

CHAPTER 9

xDSL Statistics

9.1 xDSL Statistics Overview

Use this screen to view detailed DSL information. It allows you to see the DSL status, check port details, and see DSL counters. Click **System Monitor** > **xDSL Statistics** to open the following screen.

Figure 24 System Monitor > xDSL Statistics

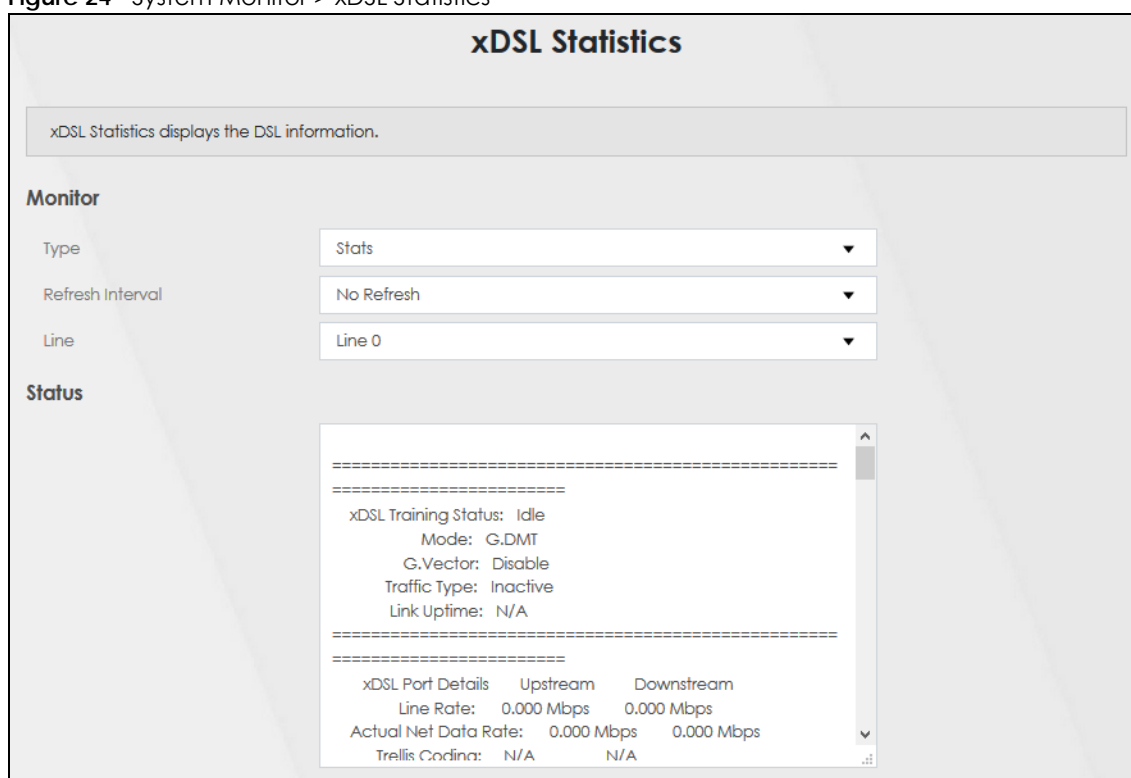

The following table describes the labels in this screen.

Table 13 System > xDSL Statistics

LABEL	DESCRIPTION
Monitor	
Type	Select Stats to display the various DSL status, downstream/upstream counters and port details in the Status window. Select Profile to display the DSL PHY and driver version, modulations, VDSL profiles, capability and PHY type configuration details in the Status window.
Refresh Interval	Select the time interval for refreshing statistics.
Line	Select which DSL line's statistics you want to display.
Status	

Table 13 System > xDSL Statistics (continued)

LABEL	DESCRIPTION
xDSL Training Status	This displays the current state of setting up the DSL connection.
Mode	This displays the ITU standard used for this connection.
Traffic Type	This displays the type of traffic the DSL port is sending and receiving. Inactive displays if the DSL port is not currently sending or receiving traffic.
Link Uptime	This displays how long the port has been running (or connected) since the last time it was started.
xDSL Port Details	
Upstream	These are the statistics for the traffic direction going out from the port to the service provider.
Downstream	These are the statistics for the traffic direction coming into the port from the service provider.
Line Rate	These are the data transfer rates at which the port is sending and receiving data.
Actual Net Data Rate	These are the rates at which the port is sending and receiving the payload data without transport layer protocol headers and traffic.
Trellis Coding	This displays whether or not the port is using Trellis coding for traffic it is sending and receiving. Trellis coding helps to reduce the noise in ADSL transmissions. Trellis may reduce throughput but it makes the connection more stable.
SNR Margin	This is the upstream and downstream Signal-to-Noise Ratio margin (in dB). A DMT sub-carrier's SNR is the ratio between the received signal power and the received noise power. The signal-to-noise ratio margin is the maximum that the received noise power could increase with the system still being able to meet its transmission targets.
Actual Delay	This is the upstream and downstream interleave delay. It is the wait (in milliseconds) that determines the size of a single block of data to be interleaved (assembled) and then transmitted. Interleave delay is used when transmission error correction (Reed- Solomon) is necessary due to a less than ideal telephone line. The bigger the delay, the bigger the data block size, allowing better error correction to be performed.
Transmit Power	This is the upstream and downstream far end actual aggregate transmit power (in dBm). Upstream is how much power the port is using to transmit to the service provider. Downstream is how much power the service provider is using to transmit to the port.
Receive Power	Upstream is how much power the service provider is receiving from the port. Downstream is how much power the port is receiving from the service provider.
Actual INP	Sudden spikes in the line's level of external noise (impulse noise) can cause errors and result in lost packets. This could especially impact the quality of multimedia traffic such as voice or video. Impulse noise protection (INP) provides a buffer to allow for correction of errors caused by error correction to deal with this. The number of DMT (Discrete Multi-Tone) symbols shows the level of impulse noise protection for the upstream and downstream traffic. A higher symbol value provides higher error correction capability, but it causes overhead and higher delay which may increase error rates in received multimedia data.
Attainable Net Data Rate	These are the highest theoretically possible transfer rates at which the port could send and receive payload data without transport layer protocol headers and traffic.
xDSL Counters	
Downstream	These are the statistics for the traffic direction coming into the port from the service provider.
Upstream	These are the statistics for the traffic direction going out from the port to the service provider.
FEC	This is the number of Far End Corrected blocks.
CRC	This is the number of Cyclic Redundancy Checks.
ES	This is the number of Errored Seconds meaning the number of seconds containing at least one errored block or at least one defect.
SES	This is the number of Severely Errored Seconds meaning the number of seconds containing 30% or more errored blocks or at least one defect. This is a subset of ES.
UAS	This is the number of UnAvailable Seconds.

Table 13 System > xDSL Statistics (continued)

LABEL	DESCRIPTION
LOS	This is the number of Loss Of Signal seconds.
LOF	This is the number of Loss Of Frame seconds.
LOM	This is the number of Loss of Margin seconds.
Retr.	This is the number of DSL retraining count in the BRCM DSL driver.
HostInitRetr	This is the number of the retraining counts the host initiated.
FastRetr	This is the number of DSL fast retraining counts.
FailedRetr	This is the number of failed retraining attempts.
FailedFastRetr	This is the number of failed fast retraining attempts.

CHAPTER 10

System

10.1 System Overview

In the **System** screen, you can name your VMG (Host) and give it an associated domain name. Domain is the name given to a network. It will be required to reach a network from an external point (like the Internet). Knowing the domain name will allow you to reach a particular network, and knowing the host name will allow you to reach a particular device. For this reason, accessing a device from another device within a network may work with just the host name (without the use of the domain name).

10.2 System Settings

Click **Maintenance > System** to open the following screen. Assign a unique name to this device so it can be easily recognized on your network. You can use up to 30 characters, including spaces.

Figure 25 Maintenance > System

The screenshot shows a web interface titled "System". At the top, there is a message box that says "You can assign a unique name to this device so it can be recognized easily on your network." Below this, there are two input fields. The first is labeled "Host Name" and contains the text "VMG4005-B60A". The second is labeled "Domain Name" and contains the text "home". At the bottom of the form, there are two buttons: "Cancel" and "Apply".

The following table describes the labels in this screen.

Table 14 Maintenance > System

LABEL	DESCRIPTION
Host Name	Type a host name for your VMG. Enter a descriptive name of up to 16 alphanumeric characters, not including spaces, underscores, and dashes.
Domain Name	Type a Domain name for your host VMG.
Cancel	Click Cancel to abandon this screen without saving.
Apply	Click Apply to save your changes.

CHAPTER 11

User Account

11.1 User Account Overview

In the **User Account** screen, you can view and modify the settings of the “admin” and other user accounts that you use to log into the VMG to manage it.

11.2 User Account Settings

Click **Maintenance > User Account** to open the following screen. Use this screen to create or manage user accounts and their privileges on the VMG.

Figure 26 Maintenance > User Account

#	Active	User Name	Retry Times	Idle Timeout	Lock Period	Group	Modify
1	<input checked="" type="checkbox"/>	admin	3	60	5	Administrator	
2	<input type="checkbox"/>	Zyxel	3	5	5	User	

The following table describes the labels in this screen.

Table 15 Maintenance > User Account

LABEL	DESCRIPTION
Add New Account	Click this button to add a new user account.
#	This is the index number.
Active	This field indicates whether the user account is active or not. Clear the check box to disable the user account. Select the check box to enable it.
User Name	This field displays the name of the account used to log into the VMG Web Configurator.
Retry Times	This field displays the number of times consecutive wrong passwords can be entered for this account. 0 means there is no limit.

Table 15 Maintenance > User Account (continued)

LABEL	DESCRIPTION
Idle Timeout	This field displays the length of inactive time before the VMG will automatically log the user out of the Web Configurator.
Lock Period	This field displays the length of time a user must wait before attempting to log in again after a number of consecutive wrong passwords have been entered as defined in Retry Times .
Group	This field displays whether this user has Administrator or User privileges.
Modify	Click the Edit icon to configure the entry. Click the Delete icon to remove the entry.
Cancel	Click Cancel to restore your previously saved settings.
Apply	Click Apply to save your changes.

11.2.1 User Account Add/Edit

Click **Add New Account** or the **Edit** icon of an existing account in the **Maintenance > User Account** to open the following screen.

Figure 27 Maintenance > User Account > Add/Edit

The screenshot shows the 'User Account Add' configuration screen. It includes the following fields and options:

- Active:** A toggle switch is turned on (blue).
- User Name:** A text input field.
- Password:** A text input field with a visibility icon (eye).
- Verify Password:** A text input field with a visibility icon (eye).
- Retry Times:** A numeric input field set to 3, with a range of [0~5] and a note '0 : Not limit'.
- Idle Timeout:** A numeric input field set to 5, with a range of Minute(s) [1~60].
- Lock Period:** A numeric input field set to 5, with a range of Minute(s) [5~90].
- Group:** A dropdown menu set to Administrator.
- Protocol:** Four checkboxes are checked: HTTP&HTTPS, SSH, TELNET, and FTP.

A note at the bottom reads: "To use Protocol control Feature for each user account under Remote Management>MGMT Services, please first enable specified service". At the bottom of the screen are 'Cancel' and 'OK' buttons.

Note: When adding accounts, an **Administrator** can create new **User** or **Administrator** accounts, while a **User** can only create **User** accounts

The following table describes the labels in this screen.

Table 16 Maintenance > User Account > Add/Edit

LABEL	DESCRIPTION
Active	Select Enable or Disable to activate or deactivate the user account.
User Name	Enter a new name for the account. The User Name must contain 1 to 15 characters, including 0 to 9, a to z, and !@#%*()-_+=~.,{}[]\ . Spaces are not allowed.
Password	Type your new system password. The Password must contain 6 to 64 characters, including 0 to 9 and a to z. Note that as you type a password, the screen displays a (*) for each character you type. After you change the password, use the new password to access the VMG.
Verify New Password	Type the new password again for confirmation.
Retry Times	Enter the number of times consecutive wrong passwords can be entered for this account. 0 means there is no limit.
Idle Timeout	Enter the length of inactive time before the VMG will automatically log the user out of the web configurator.
Lock Period	Enter the length of time a user must wait before attempting to log in again after a number of consecutive wrong passwords have been entered as defined in Retry Times .
Group	Specify whether this user will have Administrator or User privileges. Administrator and User privileges are mostly the same, but the System settings will only display when you log in as an Administrator .
Protocol	Select the network protocol for operating network services over an unsecured network. Only HTTP&HTTPS is available when User is selected in the Group field. Note: To use the Protocol Control feature for each user account under Remote Management > MGMT Services , please enable the specified service.
Cancel	Click Cancel to restore your previously saved settings.
OK	Click OK to save your changes.

CHAPTER 12

Remote Management

12.1 Remote Management Overview

Use remote management to control what services you can use through which interface(s) in order to manage the VMG.

12.1.1 What You Can Do in this Chapter

- Use the **MGMT Services** screen to allow various approaches to access the VMG remotely from a DSL and/or LAN connection (Section 12.2 on page 42).
- Use the **Trust Domain** screen to enable users to permit access from local management services by entering specific IP addresses (Section 12.3 on page 43).

Note: The VMG is managed using the Web Configurator.

12.2 MGMT Services

Use this screen to configure through which interface(s), each service can access the VMG. You can also specify service port numbers computers must use to connect to the VMG. Click **Maintenance > Remote Management > MGMT Services** to open the following screen.

Figure 28 Maintenance > Remote Management > MGMT Services

Remote MGMT enables various approaches to access this device remotely from a WAN and/or LAN connection.

Service Control

WAN Interface used for services: Any_WAN Multi_WAN

MGMT_PTMM MGMT_ATM

Service	LAN	WAN	Trust Domain	Port
HTTP	<input type="checkbox"/> Enable	<input type="checkbox"/> Enable	<input type="checkbox"/> Enable	80
HTTPS	<input checked="" type="checkbox"/> Enable	<input checked="" type="checkbox"/> Enable	<input type="checkbox"/> Enable	443
FTP	<input type="checkbox"/> Enable	<input type="checkbox"/> Enable	<input type="checkbox"/> Enable	21
TELNET	<input type="checkbox"/> Enable	<input type="checkbox"/> Enable	<input type="checkbox"/> Enable	23
SSH	<input type="checkbox"/> Enable	<input checked="" type="checkbox"/> Enable	<input type="checkbox"/> Enable	22
PING	<input checked="" type="checkbox"/> Enable	<input checked="" type="checkbox"/> Enable	<input type="checkbox"/> Enable	

Cancel Apply

The following table describes the fields in this screen.

Table 17 Maintenance > Remote Management > MGMT Services

LABEL	DESCRIPTION
WAN Interface used for services	<p>Select Any_WAN to have the VMG automatically activate the remote management service when any WAN connection is up.</p> <p>Select Multi_WAN and then select one or more WAN connections to have the VMG activate the remote management service when the selected WAN connections are up.</p>
Service	<p>This is the service you may use to access the VMG.</p> <ul style="list-style-type: none"> • HTTP provides a non secured way. • HTTPS is the secured version of HTTP, it makes sure that your data cannot be read during transmission. • FTP is the most common way of communication between two devices. • TELNET provides a way to control your VMG remotely. • SSH prevents leakage of data during remote management. Additionally, it can encrypt all transmitted data. • PING is a diagnostic tool that can check if your VMG is connected to the Internet.
LAN	Select the Enable check box for the corresponding services that you want to allow access to the VMG from the LAN.
WAN	Select the Enable check box for the corresponding services that you want to allow access to the VMG from all WAN connections.
Trust Domain	<p>Select the Enable check box for the corresponding services that you want to allow access to the VMG from the trusted hosts configured in the Maintenance > Remote MGMT > Trust Domain screen.</p> <p>If you only want certain WAN connections to have access to the VMG using the corresponding services, then clear WAN, select Trust Domain and configure the allowed IP address(es) in the Trust Domain screen.</p>
Port	You may change the server port number for a service if needed, however you must use the same port number in order to use that service for remote management.
Cancel	Click Cancel to restore your previously saved settings.
Apply	Click Apply to save your changes back to the VMG.

12.3 Trust Domain

Use this screen to view a list of public IP addresses which are allowed to access the VMG through the services configured in the **Maintenance > Remote Management > MGMT Services** screen.

Click **Maintenance > Remote Management > Trust Domain** to open the following screen.

Note: If this list is empty, all public IP addresses cannot access the VMG from the WAN through the specified services.

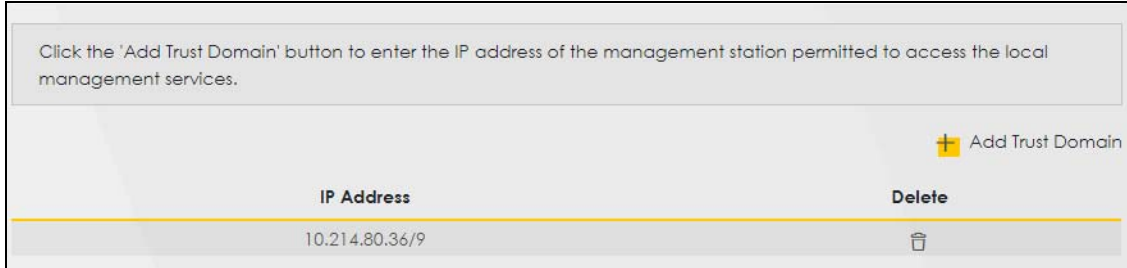
Figure 29 Maintenance > Remote Management > Trust Domain

The following table describes the fields in this screen.

Table 18 Maintenance > Remote Management > Trust Domain

LABEL	DESCRIPTION
Add Trust Domain	Click this to add a trusted host IP address.
IP Address	This field shows a trusted host IP address.
Delete	Click the Delete icon to remove the trust IP address.

12.3.1 Add Trust Domain

Use this screen to configure a public IP address which is allowed to access the VMG. Click the **Add Trust Domain** button in the **Maintenance > Remote Management > Trust Domain** screen to open the following screen.

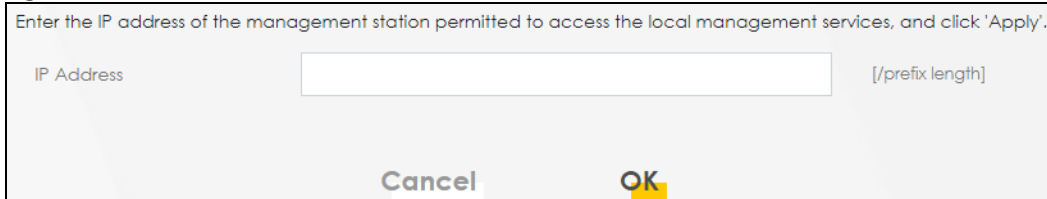
Figure 30 Maintenance > Remote Management > Trust Domain > Add Trust Domain

The following table describes the fields in this screen.

Table 19 Maintenance > Remote Management > Trust Domain > Add Trust Domain

LABEL	DESCRIPTION
IP Address	Enter a public IPv4 IP address which is allowed to access the service on the VMG from the WAN.
OK	Click OK to save your changes back to the VMG.
Cancel	Click Cancel to restore your previously saved settings.

CHAPTER 13

Time Settings

13.1 Time Settings Overview

This chapter shows you how to configure system related settings, such as system time, password, name, the domain name and the inactivity timeout interval.

13.2 Time Setup

To change your VMG's time and date, click **Maintenance > Time**. The screen appears as shown. Use this screen to configure the VMG's time based on your local time zone. You can add a time server address, select your time zone, and configure Daylight Savings if your location uses it.

Figure 31 Maintenance > Time

In order to get a correct time for the device, fill in a time server address, select the time zone where this device is physically located, and complete the daylight saving settings if needed.

Current Date/Time

Current Time 09:21:28
Current Date 2018-04-16

Time and Date Setup

Time Protocol SNTP (RFC-1769)

First Time Server Address pool.ntp.org
Second Time Server Address clock.nyc.he.net
Third Time Server Address clock.sjc.he.net
Fourth Time Server Address None
Fifth Time Server Address None

Time Zone

Time Zone (GMT-12:00) International Date Line West

Daylight Savings

Active

Start Rule

Day 1 in
 Last Sunday in
Month April
Hour 2 : 0

End Rule

Day 1 in
 Last Sunday in
Month November
Hour 3 : 0

Cancel Apply

The following table describes the fields in this screen.

Table 20 Maintenance > Time

LABEL	DESCRIPTION
Current Date/Time	
Current Time	This field displays the time of your VMG. Each time you reload this page, the VMG synchronizes the time with the time server.
Current Date	This field displays the date of your VMG. Each time you reload this page, the VMG synchronizes the date with the time server.
Time and Date Setup	
First ~ Fifth Time Server Address	Select an NTP time server from the drop-down list box. Otherwise, select Other and enter the IP address or URL (up to 29 extended ASCII characters in length) of your time server. Select None if you don't want to configure the time server. Check with your ISP/network administrator if you are unsure of this information.
Time Zone	
Time zone	Choose the time zone of your location. This will set the time difference between your time zone and Greenwich Mean Time (GMT).
Daylight Savings	Daylight Saving Time is a period from late spring to early fall when many countries set their clocks ahead of normal local time by one hour to give more daytime light in the evening.
Active	Click this switch to enable or disable Daylight Saving Time. When the switch goes to the right  , the function is enabled. Otherwise, it is not.
Start Rule	Configure the day and time when Daylight Saving Time starts if you enabled Daylight Saving. You can select a specific date in a particular month or a specific day of a specific week in a particular month. The Time field uses the 24 hour format. Here are a couple of examples: Daylight Saving Time starts in most parts of the United States on the second Sunday of March. Each time zone in the United States starts using Daylight Saving Time at 2 A.M. local time. So in the United States, set the day to Second, Sunday , the month to March and the time to 2 in the Hour field. Daylight Saving Time starts in the European Union on the last Sunday of March. All of the time zones in the European Union start using Daylight Saving Time at the same moment (1 A.M. GMT or UTC). So in the European Union you would set the day to Last, Sunday and the month to March . The time you select in the o'clock field depends on your time zone. In Germany for instance, you would select 2 in the Hour field because Germany's time zone is one hour ahead of GMT or UTC (GMT+1).
End Rule	Configure the day and time when Daylight Saving Time ends if you enabled Daylight Saving. You can select a specific date in a particular month or a specific day of a specific week in a particular month. The Time field uses the 24 hour format. Here are a couple of examples: Daylight Saving Time ends in the United States on the first Sunday of November. Each time zone in the United States stops using Daylight Saving Time at 2 A.M. local time. So in the United States you would set the day to First, Sunday , the month to November and the time to 2 in the Hour field. Daylight Saving Time ends in the European Union on the last Sunday of October. All of the time zones in the European Union stop using Daylight Saving Time at the same moment (1 A.M. GMT or UTC). So in the European Union you would set the day to Last, Sunday , and the month to October . The time you select in the o'clock field depends on your time zone. In Germany for instance, you would select 2 in the Hour field because Germany's time zone is one hour ahead of GMT or UTC (GMT+1).
Cancel	Click Cancel to exit this screen without saving.
Apply	Click Apply to save your changes.

CHAPTER 14

Log Setting

14.1 Logs Setting Overview

You can configure where the VMG sends logs and which logs and/or immediate alerts the VMG records in the **Logs Setting** screen.

14.2 Log Setup

To change your VMG's log settings, click **Maintenance > Log Setting**. The screen appears as shown.

If you have a LAN client on your network or a remote server that is running a syslog utility, you can also save its log files by enabling **Syslog Logging**, selecting **Remote** or **Local File and Remote** in the **Mode** field, and entering the IP address of the LAN client in the **Syslog Server** field. **Remote** allows you to store logs on a syslog server, while **Local File** allows you to store them on the VMG. **Local File and Remote** means your logs are stored both on the VMG and on a syslog server.

Figure 32 Maintenance > Log Setting

Log Setting

Log Setting defines which types of logs and which log levels you want to record. If you have a LAN client on your network that is running a syslog utility, you can also save the log files there by enabling Syslog Logging and enter the IP address of that LAN client.

Syslog Setting

Syslog Logging

Mode Local File and Remote

Syslog Server 0.0.0.0 (Server NAME or IPv4/IPv6 Address)

UDP Port 514 (Server Port)

Active Log

System Log

WAN-DHCP

DHCP Server

PPPoE

TR-069

HTTP

System

xDSL

ACL

Security Log

Account

Attack

Firewall

MAC Filter

Cancel
Apply

The following table describes the fields in this screen.

Table 21 Maintenance > Log Setting

LABEL	DESCRIPTION
Syslog Setting	
Syslog Logging	The VMG sends a log to an external syslog server. Click this switch to enable or disable to enable syslog logging. When the switch goes to the right , the function is enabled. Otherwise, it is not.
Mode	Select the syslog destination from the drop-down list box. If you select Remote , the log(s) will be sent to a remote syslog server. If you select Local File , the log(s) will be saved in a local file. If you want to send the log(s) to a remote syslog server and save it in a local file, select Local File and Remote . Note: When Remote Syslog is enabled, the recipient may receive personal information of Individuals on its behalf. The types of personal information being collected includes without limitation to the following: host name, host IP address and MAC address.
Syslog Server	Enter the server name or IP address of the syslog server that will log the selected categories of logs.
UDP Port	Enter the port number used by the syslog server.
Active Log	
System Log	Select the categories of system logs that you want to record.

Table 21 Maintenance > Log Setting (continued)

LABEL	DESCRIPTION
Security Log	Select the categories of security logs that you want to record.
Cancel	Click Cancel to restore your previously saved settings.
Apply	Click Apply to save your changes.

CHAPTER 15

Firmware Upgrade

15.1 Firmware Upgrade Overview

This screen lets you upload new firmware to your VMG. You can download new firmware releases from your nearest Zyxel FTP site (or www.zyxel.com) to upgrade your device's performance.

Only use firmware for your device's specific model. Refer to the label on the bottom of your VMG.

15.2 Firmware Settings

Click **Maintenance > Firmware Upgrade** to open the following screen. Download the latest firmware file from the Zyxel website and upload it to your VMG using this screen. The upload process uses HTTP (Hypertext Transfer Protocol) and may take up to two minutes. After a successful upload, the VMG will reboot.

Do NOT turn off the VMG while firmware upload is in progress!

Figure 33 Maintenance > Firmware Upgrade

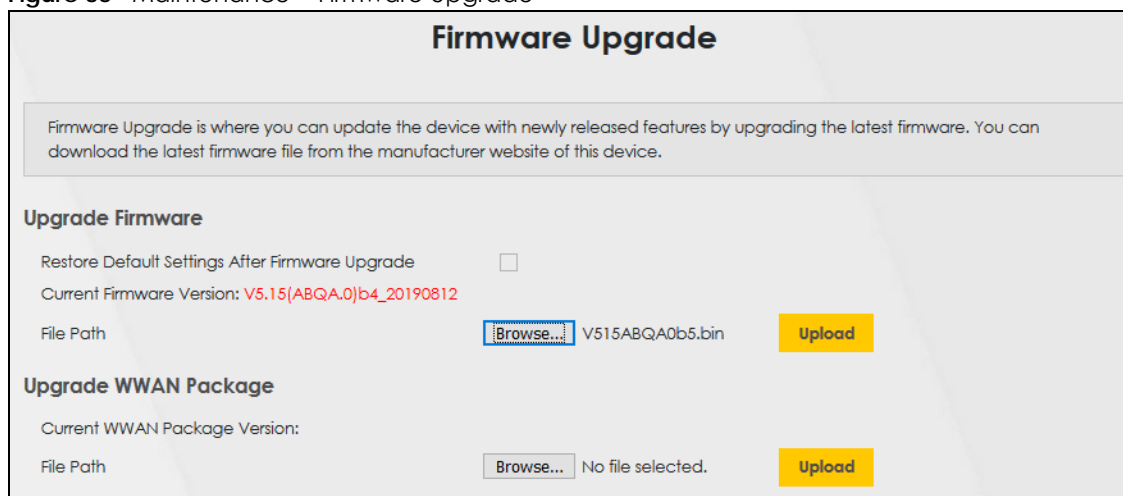

The screenshot shows a web interface titled "Firmware Upgrade". At the top, there is a descriptive text box: "Firmware Upgrade is where you can update the device with newly released features by upgrading the latest firmware. You can download the latest firmware file from the manufacturer website of this device." Below this, there are two main sections: "Upgrade Firmware" and "Upgrade WWAN Package".

Upgrade Firmware

- Restore Default Settings After Firmware Upgrade:
- Current Firmware Version: V5.15(ABQA.0)b4_20190812
- File Path:

Upgrade WWAN Package

- Current WWAN Package Version:
- File Path:

The following table describes the labels in this screen. After you see the firmware updating screen, wait

two minutes before logging into the VMG again.

Table 22 Maintenance > Firmware Upgrade

LABEL	DESCRIPTION
Upgrade Firmware	
Restore Default Settings After Firmware Upgrade	Select the check box to have the VMG automatically reset itself after the new firmware is uploaded.
Current Firmware Version	This is the present Firmware version and the date created.
File Path	Type in the location of the file you want to upload in this field or click Browse to find it.
Browse	Click this to find the .bin file you want to upload. Remember that you must decompress compressed (.zip) files before you can upload them.
Upload	Click this to begin the upload process. This process may take up to two minutes.
Upgrade WWAN Package	
Current WWAN Package Version	This is the present WWAN Package version and the date created.
File Path	Type in the location of the file you want to upload in this field or click Browse to find it.
Browse	Click this to find the .bin file you want to upload. Remember that you must decompress compressed (.zip) files before you can upload them.
Upload	Click this to begin the upload process. This process may take up to two minutes.

Figure 34 Firmware Uploading

The screenshot shows the 'Firmware Upgrade' interface. At the top, there is a title 'Firmware Upgrade' and a descriptive text box: 'Firmware Upgrade is where you can update the device with newly released features by upgrading the latest firmware. You can download the latest firmware file from the manufacturer website of this device.'

Under the 'Upgrade Firmware' section, there is a checkbox for 'Restore Default Settings After Firmware Upgrade' which is currently unchecked. Below it, the 'Current Firmware Version' is displayed as 'V5.15(ABQA.0)b4_20190812'. There is a 'File Path' field containing 'V515ABQA0b5.bin', a 'Browse...' button, and an 'Upload' button.

Under the 'Upgrade WWAN Package' section, the 'Current WWAN Package Version' is blank. The 'File Path' field contains 'No file selected.', with a 'Browse...' button and an 'Upload' button.

After two minutes, log in again and check your new firmware version in the **Status** screen.

If the upload was not successful, the following screen will appear. Click **OK** to go back to the **Firmware Upgrade** screen.

Figure 35 Error Message

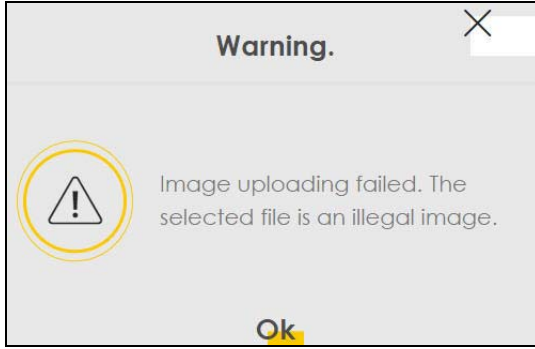

Note that the VMG automatically restarts during the upload, causing a temporary network disconnect. In some operating systems, you may see the following icon on your desktop.

Network Temporarily Disconnected

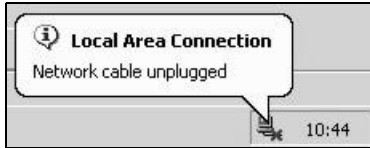

CHAPTER 16

Backup/Restore

16.1 Backup/Restore Overview

The **Backup/Restore** screen allows you to backup and restore device configurations. You can also reset your device settings back to the factory default.

16.2 Backup/Restore Settings

Click **Maintenance > Backup/Restore**. Information related to factory default settings and backup configuration are shown in this screen. You can also use this to restore previous device configurations.

Figure 36 Maintenance > Backup/Restore

Backup/Restore

You can save the current settings in a backup file on your computer, or restore previous settings from a backup file. You can also reset the device back to its factory default state.

Backup Configuration

Click Backup to save the current configuration of your system to your computer.

Backup

Restore Configuration

To restore a previously saved configuration file to your system, browse to the location of the configuration file and click Upload.

File Path No file selected. **Upload**

Back to Factory Default Settings

Click Reset to clear all user-entered configuration information and return to factory default settings. After resetting, the

- Password is printed on a label on the bottom of the device, written after the text "Password".
- LAN IP address will be 192.168.1.1
- DHCP will be reset to default setting

Reset

Backup Configuration

Backup Configuration allows you to back up (save) the VMG's current configuration to a file on your computer. Once your VMG is configured and functioning properly, it is highly recommended that you

back up your configuration file before making configuration changes. The backup configuration file will be useful in case you need to return to your previous settings.

Click **Backup** to save the VMG's current configuration to your computer.

Restore Configuration

Restore Configuration allows you to upload a new or previously saved configuration file from your computer to your VMG.

Table 23 Restore Configuration

LABEL	DESCRIPTION
File Path	Type in the location of the file you want to upload in this field or click Browse to find it.
Browse	Click this to find the file you want to upload. Remember that you must decompress compressed (.ZIP) files before you can upload them.
Upload	Click this to begin the upload process.

Do NOT turn off the VMG while configuration file upload is in progress.

After the VMG configuration has been restored successfully, the login screen appears. Login again to restart the VMG.

The VMG automatically restarts in this time causing a temporary network disconnect. In some operating systems, you may see the following icon on your desktop.

Figure 37 Network Temporarily Disconnected

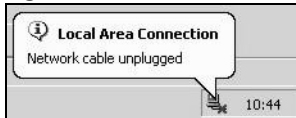

If you uploaded the default configuration file you may need to change the IP address of your computer to be in the same subnet as that of the default device IP address (192.168.1.1).

If the upload was not successful, the following screen will appear. Click **OK** to go back to the **Configuration** screen.

Figure 38 Configuration Upload Error

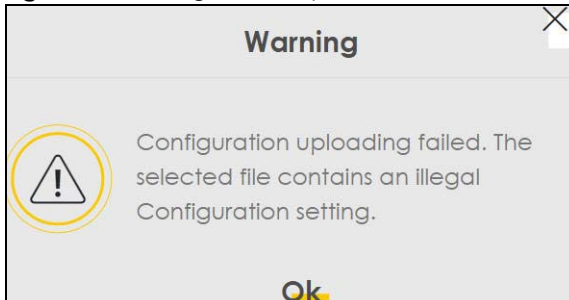

Reset to Factory Defaults

Click the **Reset** button to clear all user-entered configuration information and return the VMG to its factory defaults. The following warning screen appears.

Figure 39 Reset Warning Message



Figure 40 Reset In Process Message

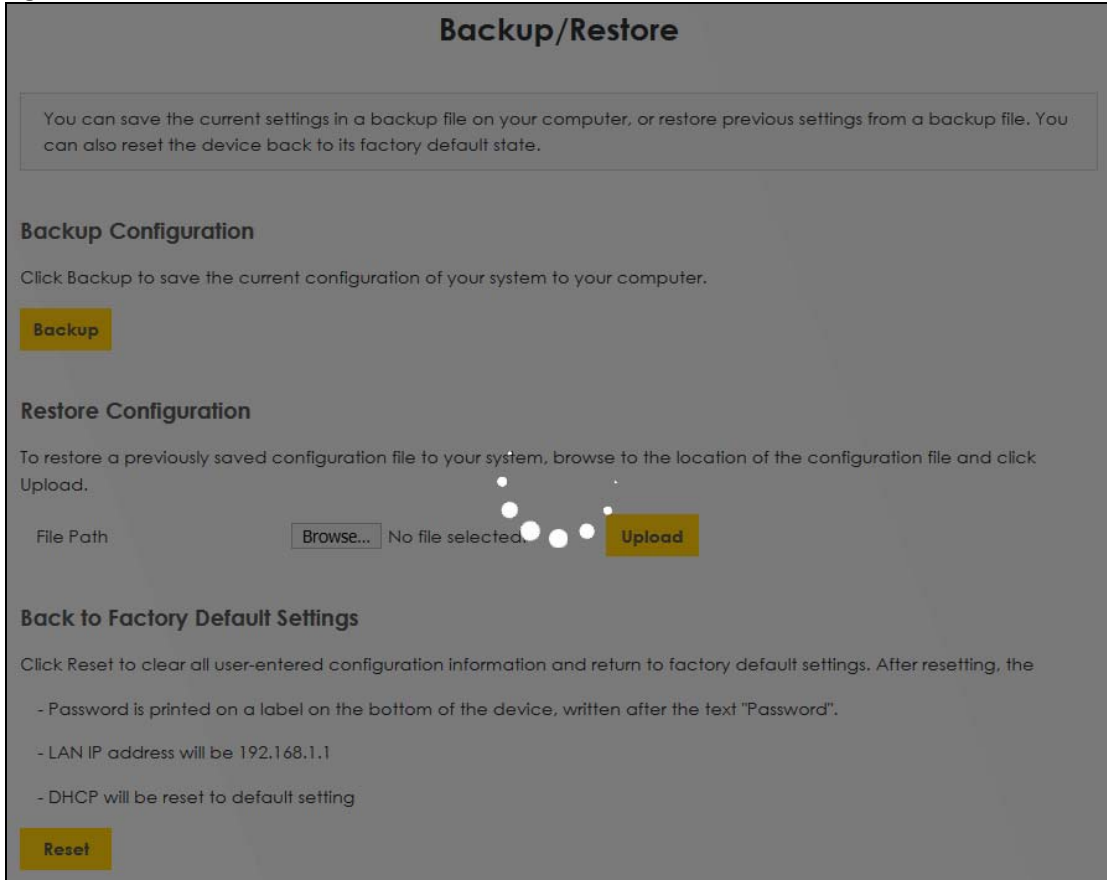

You can also press the **RESET** button on the bottom panel to reset the factory defaults of your VMG. Refer to [Section 1.5.4 on page 13](#) for more information on the **RESET** button.

16.3 Reboot

System Reboot allows you to reboot the VMG remotely without turning the power off. You may need to do this if the VMG hangs, for example.

Click **Maintenance > Reboot**. Click **Reboot** to have the VMG reboot. This does not affect the VMG's configuration.

Figure 41 Maintenance > Reboot

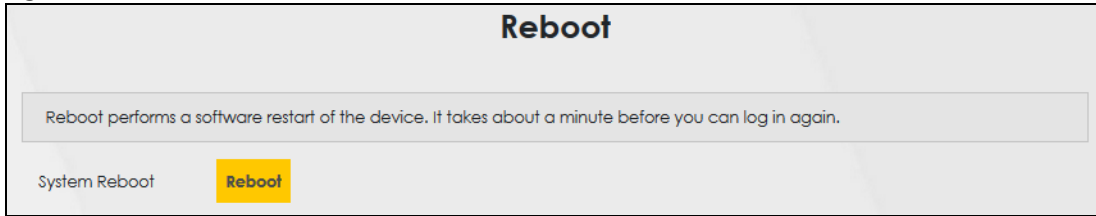

CHAPTER 17

Diagnostic

17.1 Diagnostic Overview

The **Diagnostic** screens display information to help you identify problems with the VMG.

The route between a Central Office Very-high-bit-rate Digital Subscriber Line (CO VDSL) switch and one of its Customer-Premises Equipment (CPE) may go through switches owned by independent organizations. A connectivity fault point generally takes time to discover and impacts subscriber's network access. In order to eliminate the management and maintenance efforts, IEEE 802.1ag is a Connectivity Fault Management (CFM) specification which allows network administrators to identify and manage connection faults. Through discovery and verification of the path, CFM can detect, analyze and isolate connectivity faults in bridged LANs.

17.1.1 What You Can Do in this Chapter

- The **Ping & TraceRoute & NsLookup** screen lets you ping an IP address or trace the route packets take to a host ([Section 17.3 on page 59](#)).
- The **802.1ag** screen lets you perform CFM actions ([Section 17.4 on page 60](#)).
- The **802.3ah** screen lets you configure link OAM port parameters([Section 17.5 on page 61](#)).
- The **OAM Ping** screen lets you send an ATM OAM (Operation, Administration and Maintenance) packet to verify the connectivity of a specific PVC. ([Section 17.6 on page 62](#)).

17.2 What You Need to Know

The following terms and concepts may help as you read through this chapter.

How CFM Works

A Maintenance Association (MA) defines a VLAN and associated Maintenance End Point (MEP) ports on the device under a Maintenance Domain (MD) level. An MEP port has the ability to send Connectivity Check Messages (CCMs) and get other MEP ports information from neighbor devices' CCMs within an MA.

CFM provides two tests to discover connectivity faults.

- Loopback test - checks if the MEP port receives its Loop Back Response (LBR) from its target after it sends the Loop Back Message (LBM). If no response is received, there might be a connectivity fault between them.

- Link trace test - provides additional connectivity fault analysis to get more information on where the fault is. If an MEP port does not respond to the source MEP, this may indicate a fault. Administrators can take further action to check and resume services from the fault according to the line connectivity status report.

17.3 Ping & TraceRoute & Nslookup

Use this screen use ping, traceroute, or nslookup for troubleshooting. Ping and traceroute are used to test whether a particular host is reachable. After entering an IP address and clicking on one of the buttons to start a test, the results will be shown in the Ping/Traceroute Test area. Use nslookup to find the IP address for a host name and vice versa. Click **Maintenance > Diagnostic > Ping&TraceRoute&Nslookup** to open the screen shown next.

Figure 42 Maintenance > Diagnostic > Ping&TraceRoute&Nslookup

Ping and TraceRoute are network utilities used to test whether a particular host is reachable. Enter either an IP address or a host name and click one of the buttons to start a Ping or TraceRoute test. The test result will be shown in the Info area.

Ping/TraceRoute Test

TCP/IP

Address

Ping Ping 6 Trace Route Trace Route 6 Nslookup

The following table describes the fields in this screen.

Table 24 Maintenance > Diagnostic > Ping & TraceRoute & Nslookup

LABEL	DESCRIPTION
URL or IP Address	Type the IP address of a computer that you want to perform ping, traceroute, or nslookup in order to test a connection.
Ping	Click this to ping the IPv4 address that you entered.
Ping 6	Click this to ping the IPv6 address that you entered.
Trace Route	Click this to display the route path and transmission delays between the VMG to the IPv4 address that you entered.
Trace Route 6	Click this to display the route path and transmission delays between the VMG to the IPv6 address that you entered.
Nslookup	Click this button to perform a DNS lookup on the IP address of a computer you enter.

17.4 802.1ag (CFM)

Click **Maintenance > Diagnostic > 802.1ag** to open the following screen. Use this screen to configure and perform Connectivity Fault Management (CFM) actions as defined by the IEEE 802.1ag standard. CFM protocols include Continuity Check Protocol (CCP), Link Trace (LT), and Loopback (LB).

Figure 43 Maintenance > Diagnostic > 802.1ag

The following table describes the fields in this screen.

Table 25 Maintenance > Diagnostic > 802.1ag



LABEL	DESCRIPTION
802.1ag Connectivity Fault Management	
IEEE 802.1ag CFM	Click this switch to enable or disable the IEEE802.1ag CFM specification, which allows network administrators to identify and manage connection faults. When the switch goes to the right  , the function is enabled. Otherwise, it is not.
Y.1731	Click this switch to enable or disable Y.1731, which monitors Ethernet performance. When the switch goes to the right  , the function is enabled. Otherwise, it is not.
Interface	Select the interface on which you want to enable the IEE 802.1ag CFM.
Maintenance Domain (MD) Level	Select a level (0-7) under which you want to create an MA.

Table 25 Maintenance > Diagnostic > 802.1ag (continued)

LABEL	DESCRIPTION
MD Name	Enter a descriptive name for the MD (Maintenance Domain).
MA ID	Enter a descriptive name to identify the Maintenance Association.
MEG ID	Enter a descriptive name to identify the Maintenance Entity Group. This field only appears if the Y.1731 field is enabled.
802.1Q VLAN ID	Type a VLAN ID (1-4094) for this MA.
Local MEP ID	Enter the local Maintenance Endpoint Identifier (1~8191).
CCM	Select Enable to continue sending MEP information by CCM (Connectivity Check Messages). When CCMs are received the VMG will always process it, whether CCM is enabled or not.
Remote MEP ID	Enter the remote Maintenance Endpoint Identifier (1~8191).
Test the connection to another Maintenance End Point (MEP)	
Destination MAC Address	Enter the target device's MAC address to which the VMG performs a CFM loopback and linktrace test.
Test Result	
Loopback Message (LBM)	This shows Pass if a Loop Back Messages (LBMs) responses are received. If LBMs do not get a response it shows Fail .
Linktrace Message (LTM)	This shows the MAC address of MEPs that respond to the LTMs.
Apply	Click this button to save your changes.
Send Loopback	Click this button to have the selected MEP send the LBM (Loop Back Message) to a specified remote end point.
Send Linktrace	Click this button to have the selected MEP send the LTMs (Link Trace Messages) to a specified remote end point.

17.5 802.3ah (OAM)

Click **Maintenance > Diagnostic > 803.ah** to open the following screen. Link layer Ethernet OAM (Operations, Administration and Maintenance) as described in IEEE 802.3ah is a link monitoring protocol. It utilizes OAM Protocol Data Units (OAM PDU's) to transmit link status information between directly connected Ethernet devices. Both devices must support IEEE 802.3ah.

Figure 44 Maintenance > Diagnostic > 802.3ah

IEEE 802.3ah Configuration

IEEE 802.3ah Ethernet OAM

Interface atm0

OAM ID 0



Auto Event

Features Variable Retrieval Link Events Remote Loopback Active Mode

Apply

The following table describes the labels in this screen.

Table 26 Maintenance > Diagnostics > 802.3ah

LABEL	DESCRIPTION
IEEE 802.3ah Ethernet OAM	Click this switch to enable or disable the Ethernet OAM on the specified interface. When the switch goes to the right  , the function is enabled. Otherwise, it is not.
Interface	Select the interface on which you want to enable the IEEE802.3ah.
OAM ID	Enter a positive integer to identify this node.
Auto Event	Click this switch to detect link status and send a notification when an error (such as errors in symbol, frames, or seconds) is detected. Otherwise, disable this and you will not be notified. When the switch goes to the right  , the function is enabled. Otherwise, it is not.
Features	<p>Select Variable Retrieval so the VMG can respond to requests for information, such as requests for Ethernet counters and statistics, about link events.</p> <p>Select Link Events so the VMG can interpret link events, such as link fault and dying asp. Link events are set in event notification PDUs (Protocol Data Units), and indicate when the number of errors in a certain given interval (time, number of frames, number of symbols, or number of errored frame seconds) exceeds a specified threshold. Organizations may create organization-specific link event TLVs as well.</p> <p>Select Remote Loopback so the VMG can accept loopback control PDUs to convert VMG into loopback mode.</p> <p>Select Active Mode so the VMG initiates OAM discovery, send information PDUs; and may send event notification PDUs, variable request/response PDUs, or loopback control PDUs.</p>
Apply	Click this button to save your changes.

17.6 OAM Ping

Click **Maintenance > Diagnostic > OAM Ping** to open the screen shown next. Use this screen to perform an OAM (Operation, Administration and Maintenance) F4 or F5 loopback test on a PVC. The VMG sends an OAM F4 or F5 packet to the DSLAM or ATM switch and then returns it to the VMG. The test result then displays in the text box. ATM sets up virtual circuits over which end systems communicate. The terminology for virtual circuits is as follows:

- Virtual Channel (VC) Logical connections between ATM devices
- Virtual Path (VP) A bundle of virtual channels
- Virtual Circuits A series of virtual paths between circuit end points

Figure 45 Virtual Circuit Topology

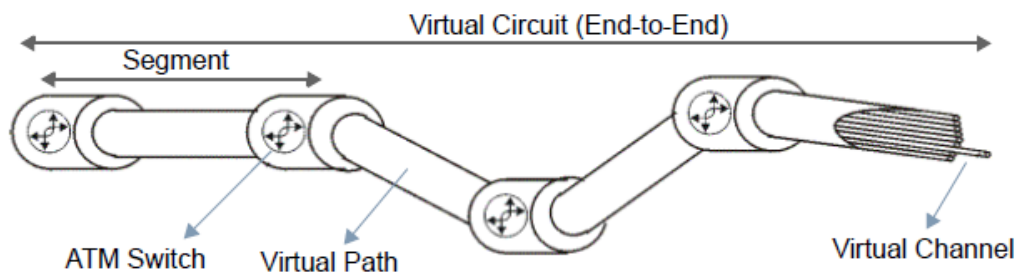

Think of a virtual path as a cable that contains a bundle of wires. The cable connects two points and wires within the cable provide individual circuits between the two points. In an ATM cell header, a VPI (Virtual Path Identifier) identifies a link formed by a virtual path; a VCI (Virtual Channel Identifier) identifies a channel within a virtual path. A series of virtual paths make up a virtual circuit.

F4 cells operate at the virtual path (VP) level, while F5 cells operate at the virtual channel (VC) level. F4 cells use the same VPI as the user data cells on VP connections, but use different predefined VCI values. F5 cells use the same VPI and VCI as the user data cells on the VC connections, and are distinguished from data cells by a predefined Payload Type Identifier (PTI) in the cell header. Both F4 flows and F5 flows are bidirectional and have two types.

- segment F4 flows (VCI=3)
- end-to-end F4 flows (VCI=4)
- segment F5 flows (PTI=100)
- end-to-end F5 flows (PTI=101)

OAM F4 or F5 tests are used to check virtual path or virtual channel availability between two DSL devices. Segment flows are terminated at the connecting point which terminates a VP or VC segment. End-to-end flows are terminated at the end point of a VP or VC connection, where an ATM link is terminated. Segment loopback tests allow you to verify integrity of a PVC to the nearest neighboring ATM device. End-to-end loopback tests allow you to verify integrity of an end-to-end PVC.

Note: The DSLAM to which the VMG is connected must also support ATM F4 and/or F5 to use this test.

Note: This screen is available only when you configure an ATM layer-2 interface.

Figure 46 Maintenance > Diagnostic > OAM Ping

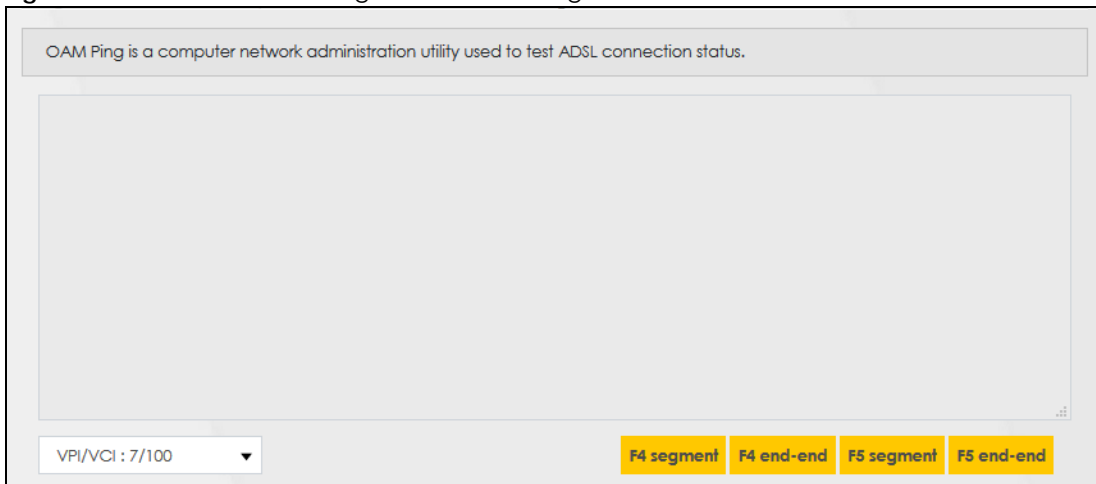

The following table describes the fields in this screen.

Table 27 Maintenance > Diagnostic > OAM Ping

LABEL	DESCRIPTION
	Select a PVC on which you want to perform the loopback test.
F4 segment	Press this to perform an OAM F4 segment loopback test.
F4 end-end	Press this to perform an OAM F4 end-to-end loopback test.

Table 27 Maintenance > Diagnostic > OAM Ping (continued)

LABEL	DESCRIPTION
F5 segment	Press this to perform an OAM F5 segment loopback test.
F5 end-end	Press this to perform an OAM F5 end-to-end loopback test.

PART III

Troubleshooting and Appendices

CHAPTER 18

Troubleshooting

This chapter offers some suggestions to solve problems you might encounter. The potential problems are divided into the following categories.

- [Power, Hardware Connections, and LEDs](#)
- [VMG Access and Login](#)
- [Internet Access](#)
- [IP Address Setup](#)

18.1 Power, Hardware Connections, and LEDs

The VMG does not turn on. None of the LEDs turn on.

- 1 Make sure the VMG is turned on.
- 2 Make sure you are using the power adapter included with the VMG.
- 3 Make sure the power adapter is connected to the VMG and plugged in to an appropriate power source. Make sure the power source is turned on.
- 4 Turn the VMG off and on.
- 5 If the problem continues, contact the vendor.

One of the LEDs does not behave as expected.

- 1 Make sure you understand the normal behavior of the LED. See [Figure 4 on page 12](#).
- 2 Check the hardware connections.
- 3 Inspect your cables for damage. Contact the vendor to replace any damaged cables.
- 4 Turn the VMG off and on.
- 5 If the problem continues, contact the vendor.

18.2 VMG Access and Login

I forgot the IP address for the VMG.

- 1 The default LAN IP address is 192.168.1.1.
- 2 If you changed the IP address and have forgotten it, you might get the IP address of the VMG by looking up the IP address of the default gateway for your computer. To do this in most Windows computers, click **Start > Run**, enter **cmd**, and then enter **ipconfig**. The IP address of the **Default Gateway** might be the IP address of the VMG (it depends on the network), so enter this IP address in your Internet browser.
- 3 If this does not work, you have to reset the device to its factory defaults. See [Section 1.5.4 on page 13](#).

I forgot the password.

- 1 See the cover page for the default login names and associated passwords.
- 2 If those do not work, you have to reset the device to its factory defaults. See [Section 1.5.4 on page 13](#).

I cannot see or access the **Login** screen in the Web Configurator.

- 1 Make sure you are using the correct IP address.
 - The default IP address is [192.168.1.1](#).
 - If you changed the IP address ([Section 7.2 on page 59](#)), use the new IP address.
 - If you changed the IP address and have forgotten it, see the troubleshooting suggestions for [I forgot the IP address for the VMG](#).
 - Make sure your computer has an IP address in the same subnet as the VMG. Your computer should have an IP address from 192.168.1.2 to 192.168.1.254. See [Section 18.4 on page 69](#).
- 2 Check the hardware connections, and make sure the LEDs are behaving as expected. See [Figure 4 on page 12](#).
- 3 Make sure your Internet browser does not block pop-up windows and has JavaScripts and Java enabled.
- 4 If it is possible to log in from another interface, check the service control settings for HTTP and HTTPS (**Maintenance > Remote Management**).
- 5 Reset the device to its factory defaults, and try to access the VMG with the default IP address. See [Section 1.5.4 on page 13](#).

- 6 If the problem continues, contact the network administrator or vendor, or try one of the advanced suggestions.

Advanced Suggestions

- Make sure you have logged out of any earlier management sessions using the same user account even if they were through a different interface or using a different browser.
- Try to access the VMG using another service, such as Telnet. If you can access the VMG, check the remote management settings and firewall rules to find out why the VMG does not respond to HTTP.

I can see the [Login](#) screen, but I cannot log in to the VMG.

- 1 Make sure you have entered the password correctly. See the cover page for the default login names and associated passwords. The field is case-sensitive, so make sure [Caps Lock] is not on.
- 2 You cannot log in to the Web Configurator while someone is using Telnet to access the VMG. Log out of the VMG in the other session, or ask the person who is logged in to log out.
- 3 Turn the VMG off and on.
- 4 If this does not work, you have to reset the device to its factory defaults. See [Section 18.1 on page 66](#).

I cannot Telnet to the VMG.

See the troubleshooting suggestions for [I cannot see or access the Login screen in the Web Configurator](#). Ignore the suggestions about your browser.

18.3 Internet Access

I cannot access the Internet.

- 1 Check the hardware connections, and make sure the LEDs are behaving as expected. See the **Quick Start Guide** and [Figure 4 on page 12](#).
- 2 Disconnect all the cables from your device and reconnect them.
- 3 If the problem continues, contact your ISP.

I cannot access the Internet through a DSL connection.

- 1 Make sure you have the **DSL** port connected to a telephone jack (or the DSL or modem jack on a splitter if you have one).

I cannot connect to the Internet using a second DSL connection.

ADSL and VDSL connections cannot work at the same time. You can only use one type of DSL connection, either ADSL or VDSL connection at one time.

I cannot access the VMG anymore. I had access to the VMG, but my connection is not available anymore.

- 1 Your session with the VMG may have expired. Try logging into the VMG again.
- 2 Check the hardware connections, and make sure the LEDs are behaving as expected. See the **Quick Start Guide** and [Figure 4 on page 12](#).
- 3 Turn the VMG off and on.
- 4 If the problem continues, contact your vendor.

18.4 IP Address Setup

I need to set the computer's IP address to be in the same subnet as the VMG.

- 1 In Windows 10, open the **Control Panel**.
- 2 Click **Network and Internet** (this field may be missing in your version) > **Network and Sharing Center**.

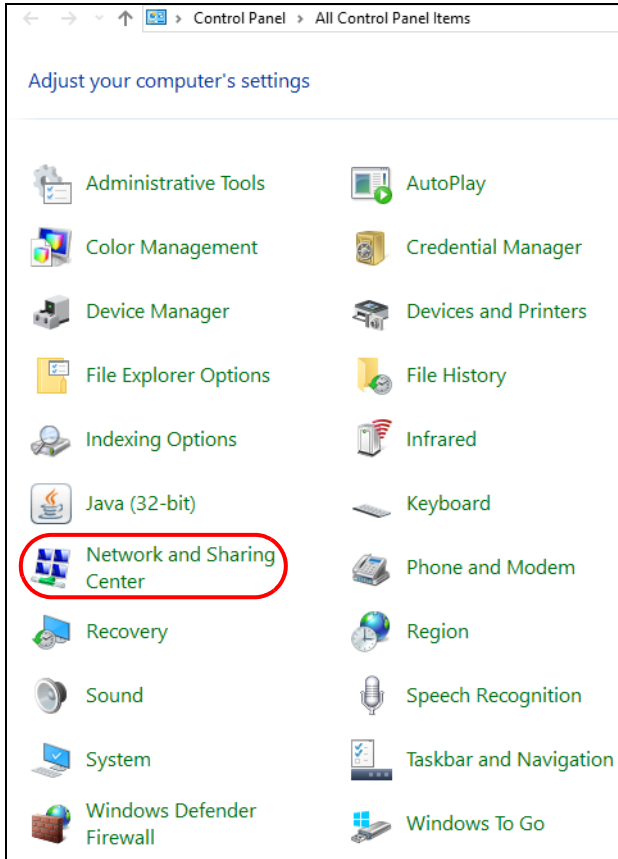

3 Click **Change adapter settings**.

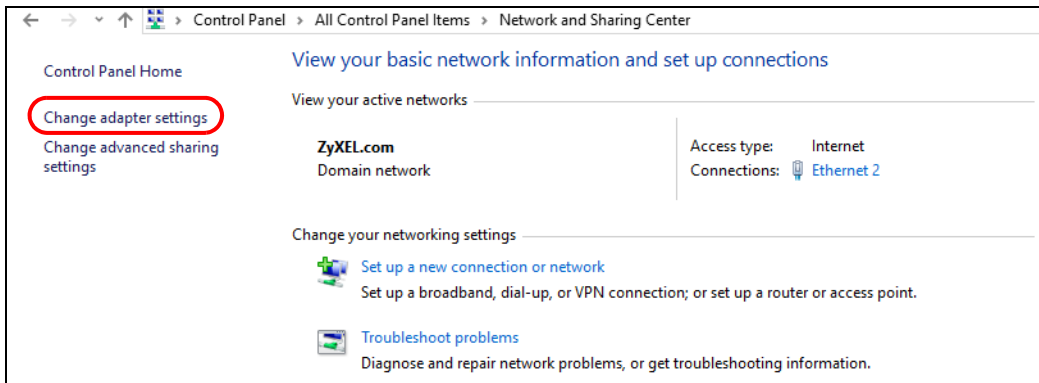

4 Right-click the **Ethernet** icon, and then select **Properties**

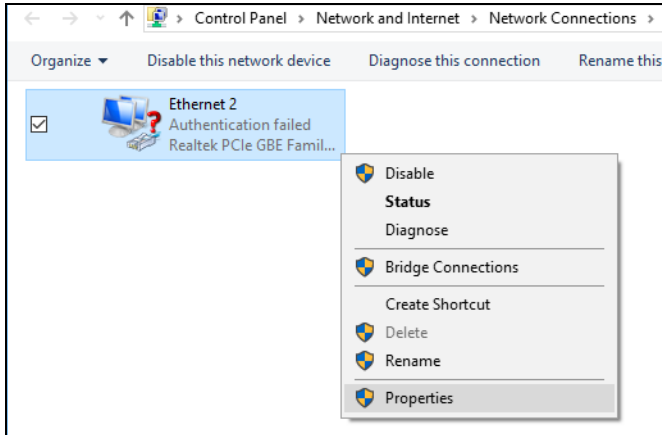

- 5 Click **Internet Protocol Version 4 (TCP/IPv4)** and then click **Properties**.

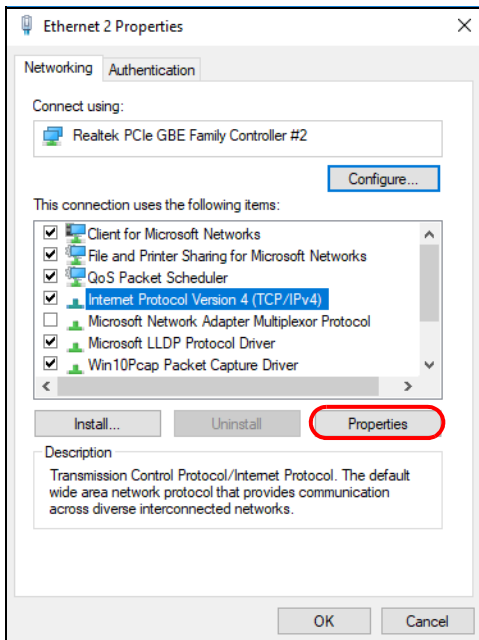

- 6 Select **Use the following IP address** and enter an IP address from 192.168.1.2 to 192.168.1.254. The **Subnet mask** will be entered automatically.

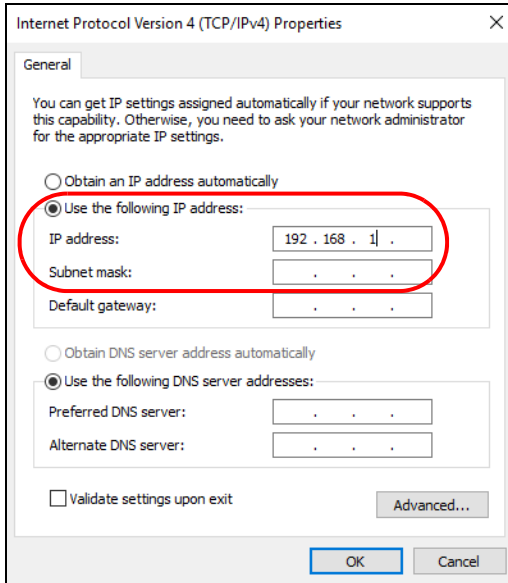

- 7 Click **OK** when you are done and close all windows.

APPENDIX A

Customer Support

In the event of problems that cannot be solved by using this manual, you should contact your vendor. If you cannot contact your vendor, then contact a Zyxel office for the region in which you bought the device.

See <https://www.zyxel.com/homepage.shtml> and also https://www.zyxel.com/about_zyxel/zyxel_worldwide.shtml for the latest information.

Please have the following information ready when you contact an office.

Required Information

- Product model and serial number.
- Warranty Information.
- Date that you received your device.
- Brief description of the problem and the steps you took to solve it.

Corporate Headquarters (Worldwide)

Taiwan

- Zyxel Communications Corporation
- <http://www.zyxel.com>

Asia

China

- Zyxel Communications (Shanghai) Corp.
- Zyxel Communications (Beijing) Corp.
- Zyxel Communications (Tianjin) Corp.
- <https://www.zyxel.com/cn/zh/>

India

- Zyxel Technology India Pvt Ltd
- <https://www.zyxel.com/in/en/>

Kazakhstan

- Zyxel Kazakhstan
- <https://www.zyxel.kz>

Korea

- Zyxel Korea Corp.
- <http://www.zyxel.kr>

Malaysia

- Zyxel Malaysia Sdn Bhd.
- <http://www.zyxel.com.my>

Pakistan

- Zyxel Pakistan (Pvt.) Ltd.
- <http://www.zyxel.com.pk>

Philippines

- Zyxel Philippines
- <http://www.zyxel.com.ph>

Singapore

- Zyxel Singapore Pte Ltd.
- <http://www.zyxel.com.sg>

Taiwan

- Zyxel Communications Corporation
- <https://www.zyxel.com/tw/zh/>

Thailand

- Zyxel Thailand Co., Ltd
- <https://www.zyxel.com/th/th/>

Vietnam

- Zyxel Communications Corporation-Vietnam Office
- <https://www.zyxel.com/vn/vi>

Europe

Belarus

- Zyxel BY
- <https://www.zyxel.by>

Belgium

- Zyxel Communications B.V.
- <https://www.zyxel.com/be/nl/>

- <https://www.zyxel.com/be/fr/>

Bulgaria

- Zyxel България
- <https://www.zyxel.com/bg/bg/>

Czech Republic

- Zyxel Communications Czech s.r.o
- <https://www.zyxel.com/cz/cs/>

Denmark

- Zyxel Communications A/S
- <https://www.zyxel.com/dk/da/>

Estonia

- Zyxel Estonia
- <https://www.zyxel.com/ee/et/>

Finland

- Zyxel Communications
- <https://www.zyxel.com/fi/fi/>

France

- Zyxel France
- <https://www.zyxel.fr>

Germany

- Zyxel Deutschland GmbH
- <https://www.zyxel.com/de/de/>

Hungary

- Zyxel Hungary & SEE
- <https://www.zyxel.com/hu/hu/>

Italy

- Zyxel Communications Italy
- <https://www.zyxel.com/it/it/>

Latvia

- Zyxel Latvia
- <https://www.zyxel.com/lv/lv/>

Lithuania

- Zyxel Lithuania
- <https://www.zyxel.com/lt/lt/>

Netherlands

- Zyxel Benelux
- <https://www.zyxel.com/nl/nl/>

Norway

- Zyxel Communications
- <https://www.zyxel.com/no/no/>

Poland

- Zyxel Communications Poland
- <https://www.zyxel.com/pl/pl/>

Romania

- Zyxel Romania
- <https://www.zyxel.com/ro/ro>

Russia

- Zyxel Russia
- <https://www.zyxel.com/ru/ru/>

Slovakia

- Zyxel Communications Czech s.r.o. organizacna zlozka
- <https://www.zyxel.com/sk/sk/>

Spain

- Zyxel Communications ES Ltd
- <https://www.zyxel.com/es/es/>

Sweden

- Zyxel Communications
- <https://www.zyxel.com/se/sv/>

Switzerland

- Studerus AG
- <https://www.zyxel.ch/de>
- <https://www.zyxel.ch/fr>

Turkey

- Zyxel Turkey A.S.
- <https://www.zyxel.com/tr/tr/>

UK

- Zyxel Communications UK Ltd.
- <https://www.zyxel.com/uk/en/>

Ukraine

- Zyxel Ukraine
- <http://www.ua.zyxel.com>

South America

Argentina

- Zyxel Communications Corporation
- <https://www.zyxel.com/co/es/>

Brazil

- Zyxel Communications Brasil Ltda.
- <https://www.zyxel.com/br/pt/>

Colombia

- Zyxel Communications Corporation
- <https://www.zyxel.com/co/es/>

Ecuador

- Zyxel Communications Corporation
- <https://www.zyxel.com/co/es/>

South America

- Zyxel Communications Corporation
- <https://www.zyxel.com/co/es/>

Middle East

Israel

- Zyxel Communications Corporation
- <http://il.zyxel.com/>

Middle East

- Zyxel Communications Corporation
- <https://www.zyxel.com/me/en/>

North America

USA

- Zyxel Communications, Inc. - North America Headquarters
- <https://www.zyxel.com/us/en/>

Oceania

Australia

- Zyxel Communications Corporation
- <https://www.zyxel.com/au/en/>

Africa

South Africa

- Nology (Pty) Ltd.
- <https://www.zyxel.com/za/en/>

APPENDIX B

Legal Information

Copyright

Copyright © 2019 by Zyxel Communications Corporation.

The contents of this publication may not be reproduced in any part or as a whole, transcribed, stored in a retrieval system, translated into any language, or transmitted in any form or by any means, electronic, mechanical, magnetic, optical, chemical, photocopying, manual, or otherwise, without the prior written permission of Zyxel Communications Corporation.

Published by Zyxel Communications Corporation. All rights reserved.

Disclaimer

Zyxel does not assume any liability arising out of the application or use of any products, or software described herein. Neither does it convey any license under its patent rights nor the patent rights of others. Zyxel further reserves the right to make changes in any products described herein without notice. This publication is subject to change without notice.

Regulatory Notice and Statement

UNITED STATES of AMERICA



The following information applies if you use the product within USA area.

FCC EMC Statement

- The device complies with Part 15 of FCC rules. Operation is subject to the following two conditions:
 - (1) This device may not cause harmful interference, and
 - (2) This device must accept any interference received, including interference that may cause undesired operation.
- Changes or modifications not expressly approved by the party responsible for compliance could void the user's authority to operate the device.
- This product has been tested and complies with the specifications for a Class B digital device, pursuant to Part 15 of the FCC Rules. These limits are designed to provide reasonable protection against harmful interference in a residential installation. This device generates, uses, and can radiate radio frequency energy and, if not installed and used according to the instructions, may cause harmful interference to radio communications. However, there is no guarantee that interference will not occur in a particular installation.
- If this device does cause harmful interference to radio or television reception, which is found by turning the device off and on, the user is encouraged to try to correct the interference by one or more of the following measures:
 - Reorient or relocate the receiving antenna
 - Increase the separation between the devices
 - Connect the equipment to an outlet other than the receiver's
 - Consult a dealer or an experienced radio/TV technician for assistance

FCC Part 68 Statement

- This equipment complies with Part 68 of the FCC rules and the requirements adopted by the ACTA. On the back of this equipment is a label that contains, among other information, a product identifier in the format US: 1RODL01AV4005B50B (part 68 ID). If requested, this number must be provided to the telephone company.
- List all applicable certification jack Universal Service Order Codes ("USOC") for the equipment. USOC JACK: RJ14CW (Depend on EUT interface)
- A plug and jack used to connect this equipment to the premises wiring and telephone network must comply with the applicable FCC Part 68 rules and requirements adopted by the ACTA. A compliant telephone cord and modular plug is provided with this product. It is designed to be connected to a compatible modular jack that is also compliant. See installation instructions for details.
- The REN is used to determine the number of devices that may be connected to a telephone line. Excessive RENs on a telephone line may result in the devices not ringing in response to an incoming call. In most but not all areas, the sum of RENs should not exceed five (5.0). To be certain of the number of devices that may be connected to a line, as determined by the total RENs, contact the local telephone company. For products approved after July 23, 2001, the REN for this product is part of the product identifier that has the format US:AAAEQ##TXXXX. The digits represented by ## are the REN without a decimal point (e.g., 03 is a REN of 0.3). For earlier products, the REN is separately shown on the label.
- If this equipment US: 1RODL01AV4005B50B (part 68 ID) causes harm to the telephone network, the telephone company will notify you in advance that temporary discontinuance of service may be required. But if advance notice isn't practical, the telephone company will notify the customer as soon as possible. Also, you will be advised of your right to file a complaint with the FCC if you believe it is necessary.
- The telephone company may make changes in its facilities, equipment, operations or procedures that could affect the operation of the equipment. If this happens the telephone company will provide advance notice in order for you to make necessary modifications to maintain uninterrupted service.

- If trouble is experienced with this equipment US: 1RODL01AV4005B50B (part 68 ID), for repair or warranty information, please contact Zyxel Communication Inc.: 1130 N Miller street Anaheim, CA 92806-2001, USA ;TEL: 002 +1 714-6320882. If the equipment is causing harm to the telephone network, the telephone company may request that you disconnect the equipment until the problem is resolved.
- Connection to party line service is subject to state tariffs. Contact the state public utility commission, public service commission or corporation commission for information.
- If your home has specially wired alarm equipment connected to the telephone line, ensure the installation of this US: 1RODL01AV4005B50B (part 68 ID) does not disable your alarm equipment. If you have questions about what will disable alarm equipment, consult your telephone company or a qualified installer.
- The Ringer Equivalence Number (REN) is 0.1A.

CANADA

The following information applies if you use the product within Canada area

Innovation, Science and Economic Development Canada ICES Statement

CAN ICES-3 (B)/NMB-3(B)

Industry Canada CS-03 Statement

- This product meets the applicable Innovation, Science and Economic Development Canada technical specifications.
- The Ringer Equivalence Number (REN) indicates the maximum number of devices allowed to be connected to a telephone interface. The termination of an interface may consist of any combination of devices subject only to the requirement that the sum of the RENs of all the devices not exceed five.
- The Ringer Equivalence Number (REN) is 0.1.

Déclaration de conformité

- Le présent produit est conforme aux spécifications techniques applicables d'Innovation, Sciences et Développement économique Canada.
- L'indice d'équivalence de la sonnerie (IES) sert à indiquer le nombre maximal de dispositifs qui peuvent être raccordés à une interface téléphonique. La terminaison d'une interface peut consister en une combinaison quelconque de dispositifs, à la seule condition que la somme des IES de tous les dispositifs n'excède pas cinq.
- Le nombre d'équivalences de sonnerie (REN) est 0,1.

EUROPEAN UNION



The following information applies if you use the product within the European Union.

List of national codes

COUNTRY	ISO 3166 2 LETTER CODE	COUNTRY	ISO 3166 2 LETTER CODE
Austria	AT	Liechtenstein	LI
Belgium	BE	Lithuania	LT
Bulgaria	BG	Luxembourg	LU
Croatia	HR	Malta	MT
Cyprus	CY	Netherlands	NL
Czech Republic	CZ	Norway	NO
Denmark	DK	Poland	PL
Estonia	EE	Portugal	PT
Finland	FI	Romania	RO
France	FR	Serbia	RS
Germany	DE	Slovakia	SK
Greece	GR	Slovenia	SI
Hungary	HU	Spain	ES
Iceland	IS	Switzerland	CH
Ireland	IE	Sweden	SE
Italy	IT	Turkey	TR
Latvia	LV	United Kingdom	GB

Safety Warnings

- Do not use this product near water, for example, in a wet basement or near a swimming pool.

- Do not expose your device to dampness, dust or corrosive liquids.
- Do not store things on the device.
- Do not obstruct the device ventilation slots as insufficient airflow may harm your device. For example, do not place the device in an enclosed space such as a box or on a very soft surface such as a bed or sofa.
- Do not install, use, or service this device during a thunderstorm. There is a remote risk of electric shock from lightning.
- Connect ONLY suitable accessories to the device.
- Do not open the device or unit. Opening or removing covers can expose you to dangerous high voltage points or other risks.
- Only qualified service personnel should service or disassemble this device. Please contact your vendor for further information.
- Make sure to connect the cables to the correct ports.
- Place connecting cables carefully so that no one will step on them or stumble over them.
- Always disconnect all cables from this device before servicing or disassembling.
- Do not remove the plug and connect it to a power outlet by itself; always attach the plug to the power adaptor first before connecting it to a power outlet.
- Do not allow anything to rest on the power adaptor or cord and do NOT place the product where anyone can walk on the power adaptor or cord.
- Please use the provided or designated connection cables/power cables/ adaptors. Connect it to the right supply voltage (for example, 110V AC in North America or 230V AC in Europe). If the power adaptor or cord is damaged, it might cause electrocution. Remove it from the device and the power source, repairing the power adaptor or cord is prohibited. Contact your local vendor to order a new one.
- Do not use the device outside, and make sure all the connections are indoors. There is a remote risk of electric shock from lightning.
- CAUTION: Risk of explosion if battery is replaced by an incorrect type, dispose of used batteries according to the instruction. Dispose them at the applicable collection point for the recycling of electrical and electronic devices. For detailed information about recycling of this product, please contact your local city office, your household waste disposal service or the store where you purchased the product.
- The following warning statements apply, where the disconnect device is not incorporated in the device or where the plug on the power supply cord is intended to serve as the disconnect device,
 - For permanently connected devices, a readily accessible disconnect device shall be incorporated external to the device;
 - For pluggable devices, the socket-outlet shall be installed near the device and shall be easily accessible.

Important Safety Instructions

- Caution! The RJ-45 jacks are not used for telephone line connection.
- Caution! To reduce the risk of fire, use only No. 26 AWG or larger (e.g., 24 AWG) UL Listed or CSA Certified Telecommunication Line Cord.
- Caution! Do not use this product near water, for example a wet basement or near a swimming pool.
- Caution! Avoid using this product (other than a cordless type) during an electrical storm. There may be a remote risk of electric shock from lightning.
- Caution! Always disconnect all telephone lines from the wall outlet before servicing or disassembling this product.
- Attention: Les prises RJ-45 ne sont pas utilisés pour la connexion de la ligne téléphonique.
- Attention: Pour réduire les risques d'incendie n'utiliser que des câbles de type 26 AWG ou des câbles de connexion plus épais.
- Attention: Ne pas utiliser ce produit près de l'eau, par exemple un sous-sol humide ou près d'une piscine.
- Attention: Évitez d'utiliser ce produit (autre qu'un type sans fil) pendant un orage. Il peut y avoir un risque de choc électrique de la foudre.
- Attention: Toujours débrancher toutes les lignes téléphoniques de la prise murale avant de réparer ou de démonter ce produit.

Environment Statement

ErP (Energy-related Products)

Zyxel products put on the EU market in compliance with the requirement of the European Parliament and the Council published Directive 2009/125/EC establishing a framework for the setting of ecodesign requirements for energy-related products (recast), so called as "ErP Directive (Energy-related Products directive) as well as ecodesign requirement laid down in applicable implementing measures, power consumption has satisfied regulation requirements which are:

- Network standby power consumption < 8W, and/or
- Off mode power consumption < 0.5W, and/or
- Standby mode power consumption < 0.5W.

European Union - Disposal and Recycling Information

The symbol below means that according to local regulations your product and/or its battery shall be disposed of separately from domestic waste. If this product is end of life, take it to a recycling station designated by local authorities. At the time of disposal, the separate collection of your product and/or its battery will help save natural resources and ensure that the environment is sustainable development.

Die folgende Symbol bedeutet, dass Ihr Produkt und/oder seine Batterie gemäß den örtlichen Bestimmungen getrennt vom Hausmüll entsorgt werden muss. Wenden Sie sich an eine Recyclingstation, wenn dieses Produkt das Ende seiner Lebensdauer erreicht hat. Zum Zeitpunkt der Entsorgung wird die getrennte Sammlung von Produkt und/oder seiner Batterie dazu beitragen, natürliche Ressourcen zu sparen und die Umwelt und die menschliche Gesundheit zu schützen.

El símbolo de abajo indica que según las regulaciones locales, su producto y/o su batería deberán depositarse como basura separada de la doméstica. Cuando este producto alcance el final de su vida útil, llévelo a un punto limpio. Cuando llegue el momento de desechar el producto, la recogida por separado éste y/o su batería ayudará a salvar los recursos naturales y a proteger la salud humana y medioambiental.

Le symbole ci-dessous signifie que selon les réglementations locales votre produit et/ou sa batterie doivent être éliminés séparément des ordures ménagères. Lorsque ce produit atteint sa fin de vie, amenez-le à un centre de recyclage. Au moment de la mise au rebut, la collecte séparée de votre produit et/ou de sa batterie aidera à économiser les ressources naturelles et protéger l'environnement et la santé humaine.

Il simbolo sotto significa che secondo i regolamenti locali il vostro prodotto e/o batteria deve essere smaltito separatamente dai rifiuti domestici. Quando questo prodotto raggiunge la fine della vita di servizio portarlo a una stazione di riciclaggio. Al momento dello smaltimento, la raccolta separata del vostro prodotto e/o della sua batteria aiuta a risparmiare risorse naturali e a proteggere l'ambiente e la salute umana.

Symbolen innebär att enligt lokal lagstiftning ska produkten och/eller dess batteri kastas separat från hushållsavfallet. När den här produkten når slutet av sin livslängd ska du ta den till en återvinningsstation. Vid tiden för kasseringen bidrar du till en bättre miljö och mänsklig hälsa genom att göra dig av med den på ett återvinningsställe.



台灣





安全警告 - 為了您的安全，請先閱讀以下警告及指示：

- 請勿將此產品接近水、火焰或放置在高溫的環境。
- 避免設備接觸
 - 任何液體 - 切勿讓設備接觸水、雨水、高濕度、污水腐蝕性的液體或其他水份。
 - 灰塵及污物 - 切勿接觸灰塵、污物、沙土、食物或其他不適合的材料。
- 雷雨天氣時，不要安裝、使用或維修此設備。有遭受電擊的風險。
- 切勿重摔或撞擊設備，並勿使用不正確的電源變壓器。
- 若接上不正確的電源變壓器會有爆炸的風險。
- 請勿隨意更換產品內的電池。
- 如果更換不正確之電池型式，會有爆炸的風險，請依製造商說明書處理使用過之電池。
- 請將廢電池丟棄在適當的電器或電子設備回收處。
- 請勿將設備解體。
- 請勿阻礙設備的散熱孔，空氣對流不足將會造成設備損害。
- 請插在正確的電壓供給插座（如：北美 / 台灣電壓 110V AC，歐洲是 230V AC）。
- 假若電源變壓器或電源變壓器的纜線損壞，請從插座拔除，若您還繼續插電使用，會有觸電死亡的風險。
- 請勿試圖修理電源變壓器或電源變壓器的纜線，若有毀損，請直接聯絡您購買的店家，購買一個新的電源變壓器。
- 請勿將此設備安裝於室外，此設備僅適合放置於室內。
- 請勿隨一般垃圾丟棄。
- 請參閱產品背貼上的設備額定功率。
- 請參考產品型錄或是彩盒上的作業溫度。
- 產品沒有斷電裝置或者採用電源線的插頭視為斷電裝置的一部分，以下警語將適用：
 - 對永久連接之設備，在設備外部須安裝可觸及之斷電裝置；
 - 對插接式之設備，插座必須接近安裝之地點而且是易於觸及的。

About the Symbols

Various symbols are used in this product to ensure correct usage, to prevent danger to the user and others, and to prevent property damage. The meaning of these symbols are described below. It is important that you read these descriptions thoroughly and fully understand the contents.

Explanation of the Symbols

SYMBOL	EXPLANATION
	Alternating current (AC): AC is an electric current in which the flow of electric charge periodically reverses direction.
	Direct current (DC): DC is the unidirectional flow or movement of electric charge carriers.
	Earth; ground: A wiring terminal intended for connection of a Protective Earthing Conductor.
	Class II equipment: The method of protection against electric shock in the case of class II equipment is either double insulation or reinforced insulation.

Viewing Certifications

Go to <http://www.zyxel.com> to view this product's documentation and certifications.

Zyxel Limited Warranty

Zyxel warrants to the original end user (purchaser) that this product is free from any defects in material or workmanship for a specific period (the Warranty Period) from the date of purchase. The Warranty Period varies by region. Check with your vendor and/or the authorized Zyxel local distributor for details about the Warranty Period of this product. During the warranty period, and upon proof of purchase, should the product have indications of failure due to faulty workmanship and/or materials, Zyxel will, at its discretion, repair or replace the defective products or components without charge for either parts or labor, and to whatever extent it shall deem necessary to restore the product or components to proper operating condition. Any replacement will consist of a new or re-manufactured functionally equivalent product of equal or higher value, and will be solely at the discretion of Zyxel. This warranty shall not apply if the product has been modified, misused, tampered with, damaged by an act of God, or subjected to abnormal working conditions.

Note

Repair or replacement, as provided under this warranty, is the exclusive remedy of the purchaser. This warranty is in lieu of all other warranties, express or implied, including any implied warranty of merchantability or fitness for a particular use or purpose. Zyxel shall in no event be held liable for indirect or consequential damages of any kind to the purchaser.

To obtain the services of this warranty, contact your vendor. You may also refer to the warranty policy for the region in which you bought the device at http://www.zyxel.com/web/support_warranty_info.php.

Registration

Register your product online to receive e-mail notices of firmware upgrades and information at www.zyxel.com for global products, or at www.us.zyxel.com for North American products.

Trademarks

ZyNOS (Zyxel Network Operating System) and ZON (Zyxel One Network) are registered trademarks of Zyxel Communications, Inc. Other trademarks mentioned in this publication are used for identification purposes only and may be properties of their respective owners.

Open Source Licenses

This product contains in part some free software distributed under GPL license terms and/or GPL like licenses. Open source licenses are provided with the firmware package. You can download the latest firmware at www.zyxel.com. To obtain the source code covered under those Licenses, please contact support@zyxel.com.tw to get it.

Index

A

Address Resolution Protocol [32](#)
Annex A [9](#)
Annex B [9](#)
applications
 Internet access [9](#)
ARP Table [32, 34](#)

B

backup
 configuration [54](#)
blinking LEDs [12](#)
bottom panel [13](#)
button
 RESET [13](#)

C

CCMs [58](#)
certifications [80](#)
 viewing [82](#)
CFM [58](#)
 CCMs [58](#)
 link trace test [59](#)
 loopback test [58](#)
 MA [58](#)
 MD [58](#)
 MEP [58](#)
 MIP [58](#)
configuration
 back up [11](#)
 backup [54](#)
 reset [55](#)
 restoring [55](#)
Connectivity Check Messages, see CCMs
contact information [73](#)

copyright [79](#)
customer support [73](#)

D

disclaimer [79](#)
DSL bonding [10](#)
 example [10](#)
 setup [10](#)
DSL line [10](#)

F

factory default
 reset to [13](#)
firmware [51](#)
 version [24](#)

I

icon
 settings [16](#)
Integrated Services Digital Network, See ISDN
Internet
 wizard setup [19](#)
Internet access [9](#)
 wizard setup [19](#)
IP address
 ping [59](#)
ISDN [9](#)

J

Java permissions [14](#)
JavaScript [14](#)

L

LAN
 status [25](#)
language
 select [17](#)
LBR [58](#)
LEDs [12](#)
link trace [59](#)
Link Trace Message, see LTM
Link Trace Response, see LTR
login [14](#)
 passwords [14](#)
logs [26, 29, 48](#)
Loop Back Response, see LBR
loopback [58](#)
LTM [59](#)
LTR [59](#)

M

MA [58](#)
Maintenance Association, see MA
Maintenance Domain, see MD
Maintenance End Point, see MEP
managing the device
 good habits [11](#)
MD [58](#)
MEG [61](#)
MEP [58](#)

N

navigation panel [16](#)
network map [18, 23](#)

P

password
 change [11, 15](#)
passwords [14](#)

Plain Old Telephone Service, See ISDN
ports [12](#)
product registration [83](#)

R

reboot the VMG [17](#)
registration
 product [83](#)
reset [13, 55](#)
RESET button [13](#)
restart [56](#)
restoring configuration [55](#)
RFC 3164 [26](#)
router features [9](#)

S

screen resolution recommended [14](#)
Security Log [27](#)
service access control [42](#)
side bar [17](#)
splitter [10](#)
status [23](#)
 firmware version [24](#)
 LAN [25](#)
 WAN [24](#)
 wireless LAN [25](#)
status indicators [12](#)
syslog
 protocol [26](#)
 severity levels [26](#)
system
 firmware [51](#)
 version [24](#)
 passwords [14](#)
 reset [13](#)
 status [23](#)
 LAN [25](#)
 WAN [24](#)
 wireless LAN [25](#)
 time [45](#)

T

- time [45](#)
- trademarks [83](#)
- two-line splitter [10](#)

U

- upgrading firmware [51](#)

V

- VMG
 - feature difference [9](#)
 - good habits for managing [11](#)
 - managing [11](#)
 - reboot [17](#)

W

- WAN
 - status [24](#)
- warranty [83](#)
 - note [83](#)
- web browser
 - pop-up window [14](#)
- web browser version recommended [14](#)
- Web Configurator
 - accessing [14](#)
 - layout [16](#)
 - login [14](#)
 - overview [14](#)
 - passwords [14](#)
- Web pop-up
 - blocking [14](#)
- wireless LAN
 - status [25](#)
- wizard setup
 - Internet [19](#)