



User Manual

ARK-1124

Fanless Embedded Box PC

ADVANTECH

Enabling an Intelligent Planet

Attention!

Please note:

This package contains a hard-copy user manual in Chinese for China CCC certification purposes, and there is an English user manual included as a PDF file on the website. Please disregard the Chinese hard copy user manual if the product is not to be sold and/or installed in China.

Copyright

The documentation and the software included with this product are copyrighted 2017 by Advantech Co., Ltd. All rights are reserved. Advantech Co., Ltd. reserves the right to make improvements in the products described in this manual at any time without notice.

No part of this manual may be reproduced, copied, translated or transmitted in any form or by any means without the prior written permission of Advantech Co., Ltd. Information provided in this manual is intended to be accurate and reliable. However, Advantech Co., Ltd. assumes no responsibility for its use, nor for any infringements of the rights of third parties, which may result from its use.

Acknowledgements

Award is a trademark of Award Software International, Inc.

VIA is a trademark of VIA Technologies, Inc.

IBM, PC/AT, PS/2 and VGA are trademarks of International Business Machines Corporation.

Intel® and Pentium® are trademarks of Intel Corporation.

Microsoft Windows® is a registered trademark of Microsoft Corp.

RTL is a trademark of Realtek Semi-Conductor Co., Ltd.

ESS is a trademark of ESS Technology, Inc.

UMC is a trademark of United Microelectronics Corporation.

SMI is a trademark of Silicon Motion, Inc.

Creative is a trademark of Creative Technology LTD.

CHRONTEL is a trademark of Chrontel Inc.

All other product names or trademarks are properties of their respective owners.

For more information about this and other Advantech products, please visit our website at:

<http://www.advantech.com/>

<http://www.advantech.com/ePlatform/>

For technical support and service, please visit our support website at:

<http://support.advantech.com.tw/support/>

Product Warranty (2 years)

Advantech warrants to you, the original purchaser, that each of its products will be free from defects in materials and workmanship for two years from the date of purchase.

This warranty does not apply to any products which have been repaired or altered by persons other than repair personnel authorized by Advantech, or which have been subject to misuse, abuse, accident or improper installation. Advantech assumes no liability under the terms of this warranty as a consequence of such events.

Because of Advantech's high quality-control standards and rigorous testing, most of our customers never need to use our repair service. If an Advantech product is defective, it will be repaired or replaced at no charge during the warranty period. For out-of-warranty repairs, you will be billed according to the cost of replacement materials, service time and freight. Please consult your dealer for more details.

If you think you have a defective product, follow these steps:

1. Collect all the information about the problem encountered. (For example, CPU speed, Advantech products used, other hardware and software used, etc.) Note anything abnormal and list any onscreen messages you get when the problem occurs.
2. Call your dealer and describe the problem. Please have your manual, product, and any helpful information readily available.
3. If your product is diagnosed as defective, obtain an RMA (return merchandise authorization) number from your dealer. This allows us to process your return more quickly.
4. Carefully pack the defective product, a fully-completed Repair and Replacement Order Card and a photocopy proof of purchase date (such as your sales receipt) in a shippable container. A product returned without proof of the purchase date is not eligible for warranty service.
5. Write the RMA number visibly on the outside of the package and ship it prepaid to your dealer.

Declaration of Conformity

FCC Class B

Note: This equipment has been tested and found to comply with the limits for a Class B digital device, pursuant to part 15 of the FCC Rules. These limits are designed to provide reasonable protection against harmful interference in a residential installation. This equipment generates, uses and can radiate radio frequency energy and, if not installed and used in accordance with the instructions, may cause harmful interference to radio communications. However, there is no guarantee that interference will not occur in a particular installation. If this equipment does cause harmful interference to radio or television reception, which can be determined by turning the equipment off and on, the user is encouraged to try to correct the interference by one or more of the following measures:

- Reorient or relocate the receiving antenna.
- Increase the separation between the equipment and receiver.
- Connect the equipment into an outlet on a circuit different from that to which the receiver is connected.
- Consult the dealer or an experienced radio/TV technician for help.

Technical Support and Assistance

1. Visit the Advantech web site at www.advantech.com/support where you can find the latest information about the product.
2. Contact your distributor, sales representative, or Advantech's customer service center for technical support if you need additional assistance. Please have the following information ready before you call:
 - Product name and serial number
 - Description of your peripheral attachments
 - Description of your software (operating system, version, application software, etc.)
 - A complete description of the problem
 - The exact wording of any error messages

Warnings, Cautions and Notes

Warning! *Warnings indicate conditions, which if not observed, can cause personal injury!*



Caution! *Cautions are included to help you avoid damaging hardware or losing data.*



There is a danger of a new battery exploding if it is incorrectly installed. Do not attempt to recharge, force open, or heat the battery. Replace the battery only with the same or equivalent type recommended by the manufacturer. Discard used batteries according to the manufacturer's instructions.

Note! *Notes provide optional additional information.*



Packing List

Before installation, please ensure the following items have been shipped:

- 1 x ARK-1124 unit
- 1 x Registration and 2 years warranty card
- 1 x China RoHS
- 1 x 12V Power Adaptor
- 1 x Utility CD
- 1 x Simplified Chinese manual

Ordering Information

Model Number	Description
ARK-1124C-S1A1E	Intel Atom N3350 DC 1.1GHz w/VGA, four COM, one GbE LAN
ARK-1124U-S1A1E	Intel Atom N3350 DC 1.1GHz w/VGA, four USB3.0, dual GbE LAN
ARK-1124H-S6A1E	Intel Atom E3940 QC 1.6GHz w/dual HDMI , four USB 3.0, dual GbE LAN

Optional Accessories

For ARK-1124

Part Number	Description
MOS-2220-Z1101E	High Speed COM module, 1-Ch, USB I/F
MOS-1120Y-0201E	Isolated RS-232, 2-Ch, DB9, PCIe I/F
MOS-1120Y-1401E	Non-Isolated RS-232, DB37, 4-Ch, PCIe I/F
MOS-1121Y-0201E	Isolated RS-422/485, 2-Ch, DB9, PCIe I/F
MOS-1121Y-1401E	Non-Isolated RS-422/485, DB37, 4-Ch, PCIe I/F
MOS-2120-Z1101E	Giga LAN Ethernet module, 1-Ch, PCIe I/F
MOS-2220-X1101E	Parallel LPT module, 1-Ch, USB I/F
MOS-1130Y-0201E	Isolated CANBus, 2-Ch, DB9, PCIe I/F
MOS-2230-Z1201E	CANBus module, 2-Ch, USB I/F
MOS-1110Y-0101E	Isolated 16 DI/8 DO, 1-Ch, DB37, PCIe I/F
MOS-2110Z-1201E	USB module, 2-Ch, PCIe Interface I/F
AMO-1101	2nd Layer, iDoor Expansion Kit
AMO-P011	12V-24V Power Module kit

Safety Instructions

1. Please read these safety instructions carefully.
2. Please keep this User's Manual for later reference.
3. Please disconnect this equipment from AC outlet before cleaning. Use a damp cloth. Don't use liquid or sprayed detergent for cleaning. Use moisture sheet or clothe for cleaning.
4. For pluggable equipment, the socket-outlet shall near the equipment and shall be easily accessible.
5. Please keep this equipment from humidity.
6. Lay this equipment on a reliable surface when install. A drop or fall could cause injury.
7. The openings on the enclosure are for air convection hence protecting the equipment from overheating. **DO NOT COVER THE OPENINGS.**
8. Make sure the voltage of the power source when connecting the equipment to the power outlet.
9. Place the power cord such a way that people cannot step on it. Do not place anything over the power cord.
10. All cautions and warnings on the equipment should be noted.
11. If the equipment is not used for long time, disconnect the equipment from mains to avoid being damaged by transient over-voltage.
12. Never pour any liquid into ventilation openings; this could cause fire or electrical shock.
13. Never open the equipment. For safety reasons, only qualified service personnel should open the equipment.
14. If one of the following situations arises, get the equipment checked by service personnel:
 - The power cord or plug is damaged.
 - Liquid has penetrated into the equipment.
 - The equipment has been exposed to moisture.
 - The equipment does not work well, or you cannot get it to work according to the user's manual.
 - The equipment has been dropped and damaged.
 - The equipment has obvious signs of breakage.
15. Do not leave this equipment in an environment where the storage temperature may go below -40°C (-40°F) or above 85°C (185°F). This could damage the equipment. the equipment should be in a controlled environment.
16. Caution: Danger of explosion if battery is incorrectly replaced. Replace only with the same or equivalent type recommended by the manufacturer, discard used batteries according to the manufacturer's instructions.
17. The sound pressure level at the operator's position according to IEC 704-1:1982 is no more than 70 dB (A).
18. **RESTRICTED ACCESS AREA:** The equipment should only be installed in a Restricted Access Area.
19. **DISCLAIMER:** This set of instructions is given according to IEC 704-1. Advan-tech disclaims all responsibility for the accuracy of any statements contained herein.

Contents

Chapter 1	General Introduction	1
1.1	Introduction	2
1.2	Product Features.....	3
1.2.1	General	3
1.2.2	Display	3
1.2.3	Ethernet	3
1.3	Chipset.....	4
1.3.1	Functional Specification	4
1.3.2	WISE-PaSS/RMM.....	5
1.4	Mechanical Specifications.....	5
1.4.1	ARK-1124C Dimensions	5
	Figure 1.1 ARK-1124C Mechanical dimension drawing	5
1.4.2	ARK-1124U Dimensions	6
	Figure 1.2 ARK-1124U Dimensions.....	6
1.4.3	ARK-1124H Dimensions	6
	Figure 1.3 ARK-1124H Dimensions.....	6
1.4.4	Weight.....	7
1.5	Power Requirement	7
1.5.1	System Power.....	7
1.5.2	RTC Battery	7
1.6	Environment Specification.....	8
1.6.1	Operating Temperature.....	8
1.6.2	Relative Humidity	8
1.6.3	Storage Temperature.....	8
1.6.4	Vibration during Operation	8
1.6.5	Shock during Operation	8
1.6.6	Safety.....	8
1.6.7	EMC.....	8
Chapter 2	H/W Installation.....	9
2.1	Introduction	10
2.2	Jumpers	10
2.2.1	Jumper Description	10
2.2.2	Jumper List	11
	Table 2.1: Jumper setting	11
2.2.3	Jumper Location	11
	Figure 2.1 Jumper Layout.....	11
2.2.4	Jumper Setting.....	11
2.3	ARK-1124 I/O Introduction	12
	Figure 2.2 ARK-1124C Front View	12
	Figure 2.3 ARK-1124C Rear View.....	12
	Figure 2.4 ARK-1124U Front View	12
	Figure 2.5 ARK-1124U Rear View.....	13
	Figure 2.6 ARK-1124H Front View	13
	Figure 2.7 ARK-1124H Rear View.....	13
2.4	ARK-1124H External I/O	14
2.4.1	Power On/Off Button	14
	Figure 2.8 Power On/Off Button	14
2.4.2	Power Input Connector	14
	Figure 2.9 Power Input Connector.....	14
2.4.3	Ethernet Connector (LAN)	14
	Figure 2.10 Ethernet Connector (LAN).....	14
	Table 2.2: Ethernet Connector (LAN)Pin Definition.....	14

	2.4.4	USB 3.0 Connector.....	15
		Figure 2.11USB Connector	15
		Table 2.3: USB Connector Pin Definition	15
	2.4.5	Audio Connector.....	16
		Figure 2.12Audio Connector.....	16
		Table 2.4: Audio Connector Pin Definition	16
	2.4.6	COM Connector.....	16
		Figure 2.13COM Connector	16
		Table 2.5: COM Connector Pin Definition	16
	2.4.7	HDMI Connector.....	17
		Figure 2.14HDMI Connector.....	17
		Table 2.6: HDMI Connector Pin Definition	17
	2.4.8	HDD LED Indicators	17
		Figure 2.15HDD LED Indicators	17
	2.4.9	Antenna Hole.....	18
		Figure 2.16Antenna Hole.....	18
2.5	ARK-1124U	External I/O Connector	18
	2.5.1	Power On/Off Button.....	18
		Figure 2.17Power On/Off Button	18
	2.5.2	Power Input Connector.....	18
		Figure 2.18Power Input Connector.....	18
	2.5.3	Ethernet Connector (LAN).....	18
		Figure 2.19Ethernet Connector (LAN).....	18
		Table 2.7: Ethernet Connector (LAN)Pin Definition.....	18
	2.5.4	USB Connector.....	19
		Figure 2.20USB Connector	19
		Table 2.8: USB Connector Pin Definition	19
	2.5.5	Audio Connector.....	20
		Figure 2.21Audio Connector.....	20
		Table 2.9: Audio Connector Pin Definition	20
	2.5.6	COM Connector.....	20
		Figure 2.22COM Connector	20
		Table 2.10: COM Connector Pin Definition	20
	2.5.7	VGA Connector.....	21
		Figure 2.23VGA Connector	21
		Table 2.11:VGA Connector Pin Definition	21
	2.5.8	HDD LED Indicators	21
		Figure 2.24HDD LED Indicators	21
	2.5.9	Antenna Hole.....	22
		Figure 2.25Antenna Hole.....	22
2.6	ARK-1124C	External I/O Connector	22
	2.6.1	Power On/Off Button.....	22
		Figure 2.26Power On/Off Button	22
	2.6.2	Power Input Connector.....	22
		Figure 2.27Power Input Connector.....	22
	2.6.3	Ethernet Connector (LAN).....	22
		Figure 2.28Ethernet Connector (LAN).....	22
		Table 2.12: Ethernet Connector (LAN)Pin Definition.....	22
	2.6.4	USB Connector.....	23
		Figure 2.29USB Connector	23
		Table 2.13: USB Connector Pin Definition	23
	2.6.5	Audio Connector.....	24
		Figure 2.30Audio Connector.....	24
		Table 2.14: Audio Connector Pin Definition	24
	2.6.6	COM Connector.....	24
		Figure 2.31COM Connector	24
		Table 2.15: COM Connector Pin Definition	24
	2.6.7	VGA Connector.....	25
		Figure 2.32VGA Connector	25
		Table 2.16:VGA Connector Pin Definition	25

2.6.8	HDD LED Indicator	25
	Figure 2.33HDD LED Indicators	25
2.6.9	Antenna Hole	26
	Figure 2.34Antenna Hole	26
2.7	Installation	26
2.7.1	HDD/SSD Installation.....	26
2.7.2	RAM Installation.....	28
2.7.3	M.2 Module Installation.....	29
2.7.4	mSATA Installation:	30
2.7.5	iDoor Module (AMO-1101) Installation (Option).....	31
2.7.6	Power Module (AMO-P011) Installation (Option).....	33

Chapter 3 BIOS Settings.....35

3.1	BIOS Setup	36
	Figure 3.1 Setup program initial screen.....	36
3.2	Entering Setup	37
3.2.1	Main Setup.....	37
	Figure 3.2 Main setup screen	37
3.2.2	Advanced BIOS Features Setup.....	38
	Figure 3.3 Advanced BIOS features setup screen	38
	Figure 3.4 Driver Health Status screen.....	39
	Figure 3.5 ACPI Setting.....	39
	Figure 3.6 First Serial Port Configuration(SCH3114)	40
	Figure 3.7 Second Serial Port Configuration(SCH3106)	42
	Figure 3.8 Serial Port Settings (Port3).....	42
	Figure 3.9 Intel Fast Flash Standby.....	46
	Figure 3.10CPU Power Management Settings.....	47
	Figure 3.11Network Configuration Settings	48
	Figure 3.12CSM Configuration Settings	49
	Figure 3.13Security Configuration Settings	51
	Figure 3.14RC ACPI Settings	52
3.2.3	Chipset Configuration	53
	Figure 3.15Chipset Configuration	53
	Figure 3.16North Bridge Configuration	54
	Figure 3.17South Bridge Configuration	54
	Figure 3.18Uncore Configuration.....	55
	Figure 3.19South Cluster Configuration	56
	Figure 3.20HD-Audio Configuration Settings.....	57
	Figure 3.21PCI Express Configuration (ARK-1124C).....	58
	Figure 3.22PCI Express Configuration (ARK-1124U/ARK-1124H)	59
	Figure 3.23PCI Express Configuration Settings	60
	Figure 3.24SATA Drives Settings	61
	Figure 3.25USB Configuration Settings.....	62
	Figure 3.26Miscellaneous Configuration Settings	63
3.2.4	Security	64
	Figure 3.27Security Settings.....	64
3.2.5	Boot.....	65
3.2.6	Save & Exit	66
	Figure 3.28Save & Exit.....	66

Appendix A Watchdog Timer Sample Code.....67

A.1	Watchdog Timer Sample Code.....	68
-----	---------------------------------	----

Appendix B SUSI API Introduction71

B.1	SUSI API Introduction	72
	B.1.1 The Watchdog API.....	72
	B.1.2 The Hardware Monitor API	72

Chapter 1

General Introduction

This chapter gives background information on ARK-1124 series.

1.1 Introduction

ARK-1124 is a palm-sized, modular and multifunctional fanless embedded system. A fully modular design, ARK-1124 supports easy I/O switching with optional iDoor modules and power board expansions, which let customer change system configuration by demand. ARK-1124 is a design ready platform which is targeted in market like Machine Automation, Equipment Integration, KIOSK, and Edge Computing.

Palm Size & Multifunctional Design

ARK-1124 powers by Intel® Celeron® N3350 /Atom™ E3940 processor to offer high performance in low power consumption. And its palm size dimension let user install in space limited environment.

ARK-1124 provides a selection of I/O ports for different application by model. ARK-1124C supports up to 4 COM port which is suitable for automation ; ARK-1124U offers 4 USB 3.0 , 2 GbE LAN , and 1 x M.2 for wireless module which is suitable for data gateway; ARK-1124H provides 2 x 4K2K HDMI display and 4 USB 3.0, which is suitable for kiosk or digital signage.

For ARK-1124, the default power input is 12V DC in, and supports an optional wide range 12~24V power module with wide temperature operation of -20 to 60C.

ARK-1124 passes worldwide certification including CE/FCC, CB, UL, CCC and BSMI.

Multiple Display Support

ARK-1124 supports up to two display types: VGA and HDMI. In ARK-1124H, system offers two 4K2K HDMI displays, which support dual independent displays. In ARK-1124C and ARK-1124U, system provides one VGA display up to 2048 x 1280 @60Hz. The graphic engine is DirectX 11.3, OpenGL 4.4, and OpenCL 2.1 Full AVC/VC1/MPEG2 HW Decode.

Flexible I/O Selection – iDoor and ARK Plus module

ARK-1124 offers flexible I/O design, with ARK plus module, user can extend I/O or power module based on demands.

User can install iDoor on ARK plus module to extend I/O like COM, USB, LAN, CAN-Bus, etc. And also can use ARK plus module to add 12-24V power module to extend power input range.

Built in Intelligent Management Tools - WISE-PaSS/RMM

Advantech WISE-PaSS/RMM provides a valuable suite of programmable APIs such as multi-level watchdog, hardware monitor, system restore, and other user-friendly interface. WISE-PaSS/RMM makes the whole system more reliable and more intelligent. ARK-1124 provides easy remote management so users can monitor, configure, and control a large number of terminals to make maintenance and system recovery simpler.

1.2 Product Features

1.2.1 General

- **CPU:**
 - Intel® Celeron® N3350 DC SoC 1.1GHz boost up to 2.4 GHz
 - Intel Atom™ E3940 QC SoC 1.6GHz boost up to 1.8GHz
- **BIOS:** AMI UEFI 64Mbit
- **System Memory:** 1x DDR3L 1866MHz up to 8 GB
- **Watchdog Timer:** Single chip Watchdog 255-level interval timer, setup by software
- **Series Port:**
 - ARK-1124C: 4 x RS-232/422/485
 - ARK-1124U: 2 x RS-232/422/485
 - ARK-1124H: 1 x RS-232/422/485
- **USB:**
 - ARK-1124C: 2 x USB 3.0
 - ARK-1124U/ARK-1124H: 4 x USB 3.0
- **Audio:** High Definition Audio (HD), Line out, Line-in
- **Storage:**
 - ARK-1124C/ARK-1124H: 1 x mSATA and 1 x high capacity 2.5”SATA HDD (up to 9.5mm height)
 - ARK-1124U: 1 x high capacity 2.5”SATA HDD (up to 9.5mm height)
- **Expansion Interface:**
 - Supports 1 x Full Size MiniPCle with SIM holder on board
 - Supports 1 x M.2 (E-Key) in ARK-1124U and ARK-1124H
 - Supports 1 x ARK Plus expansion (by 2nd layer)

1.2.2 Display

- **Controller:** Intel® HD Graphics 500
- **Resolution:**
 - ARK-1124C/ARK-1124U: 1 x VGA, support up to 2048 x 1280 @ 60Hz
 - ARK-1124H: 2 x HDMI 1.4b, support up to 3840 x 2160 @ 30Hz
- **Dual Display:** ARK-1124H Only, HDMI + HDMI

1.2.3 Ethernet

- **Chipset:**
 - LAN1 Intel i210
 - LAN2 Intel i210
- **Speed:** 1000 Mbps
- **Interface:** 2 x RJ45
- **Standard:** Compliant with IEEE 802.3, IEEE 802.3u, IEEE 802.3x, IEEE 802.3y, IEEE 802.ab.

1.3 Chipset

1.3.1 Functional Specification

1.3.1.1 Processor

Processor	Intel® Celeron® N3350 DC SoC 1.1GHz boost up to 2.4 GHz Intel Atom™ E3940 QC SoC 1.6GHz boost up to 1.8GHz
Memory	Supports DDR3L 1866MHz up to 8GB 1 x 204-pin SODIMM socket type

1.3.1.2 Chipset

Internal Graphics Features	<ul style="list-style-type: none">■ DirectX 11.3, OpenGL 4.4■ Display Ports VGA, HDMI (HDMI 1.4a)
Video Accelerator	<ul style="list-style-type: none">■ H/W accelerated video decode■ Video decoder: AVC/VC1/MPEG2 HW Decode■ Supports DVD, Blu-ray, and HD video
SATA Interface	<ul style="list-style-type: none">■ Supports several optional sections of Serial ATA II: Extensions to Serial ATA 1.0 Specification, Revision 1.0■ Supports SATA transfers to 300 Mbytes/sec.■ Support mSATA socket (ARK-1124C/ARK-1124H)
USB Interface	<ul style="list-style-type: none">■ USB host interface with support up to 4 USB 3.0 ports■ All ports are High-Speed, Full-Speed, and Low-Speed capable■ Supports legacy keyboard/mouse software
BIOS	<ul style="list-style-type: none">■ UEFI 64Mbit

1.3.1.3 Others

Serial ports	<ul style="list-style-type: none">■ ARK-1124C support 4x RS-232/422/485 , support auto-flow control.■ ARK-1124U support 2xRS-232/422/485 , support auto-flow control.■ ARK-1124H support 1xRS-232/422/485 , support auto-flow control. COM connector: D-SUB CON. 9P
Ethernet	LAN1 Intel i210, LAN2 Intel i210 <ul style="list-style-type: none">■ Compliant with IEEE 802.3, IEEE 802.3u, IEEE 802.3x, IEEE 802.3y, IEEE 802.ab.■ Supports 10/100/1000 Mbps. LAN Connectors: Phone Jack RJ45 8P 90D(F)
Audio	Audio Codec: Realtek ALC888S: <ul style="list-style-type: none">■ Compliant with HD Audio specifications■ Supports 16/20/24-bit DAC and 16/20/24-bit ADC resolution■ Supports: Line-out, Line-in Audio Connectors: Ear Phone Jack * 2
Battery backup	<ul style="list-style-type: none">■ BATTERY 3V/210 mAh with WIRE x 1

1.3.2 WISE-PaSS/RMM

Sequence control	Supported
Watchdog timer	Multi Level WDT Programmable 1-255 sec / min
Hardware monitor	CPU Temperature / input Current / input Voltage
Power saving	Deep sleep S5 mode
System information	Running HR / Boot record

1.4 Mechanical Specifications

1.4.1 ARK-1124C Dimensions

133[5.24] x 46.4 [1.83] x 94.2 [3.71] Unit: mm [Inch]

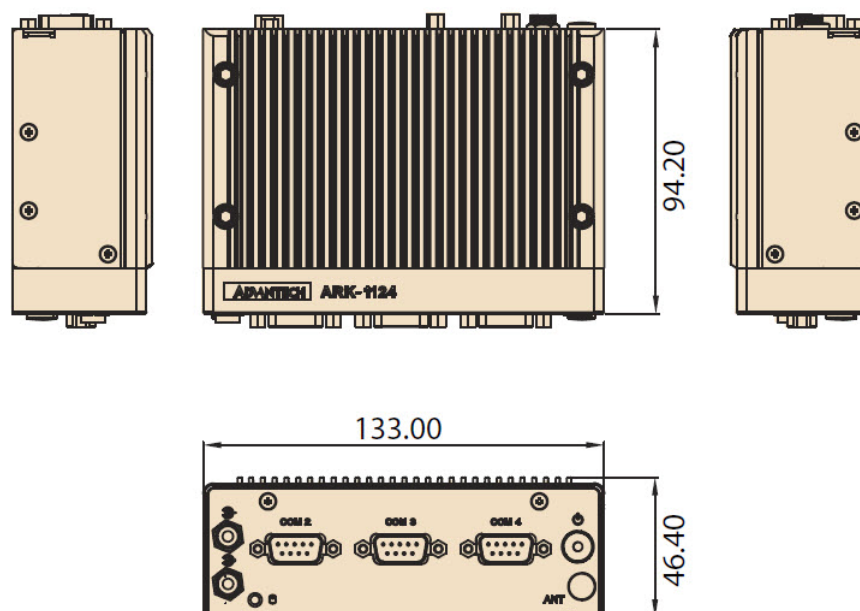

Figure 1.1 ARK-1124C Mechanical dimension drawing

1.4.2 ARK-1124U Dimensions

133[5.24] x 46.4 [1.83] x 94.2 [3.71] Unit: mm [Inch]

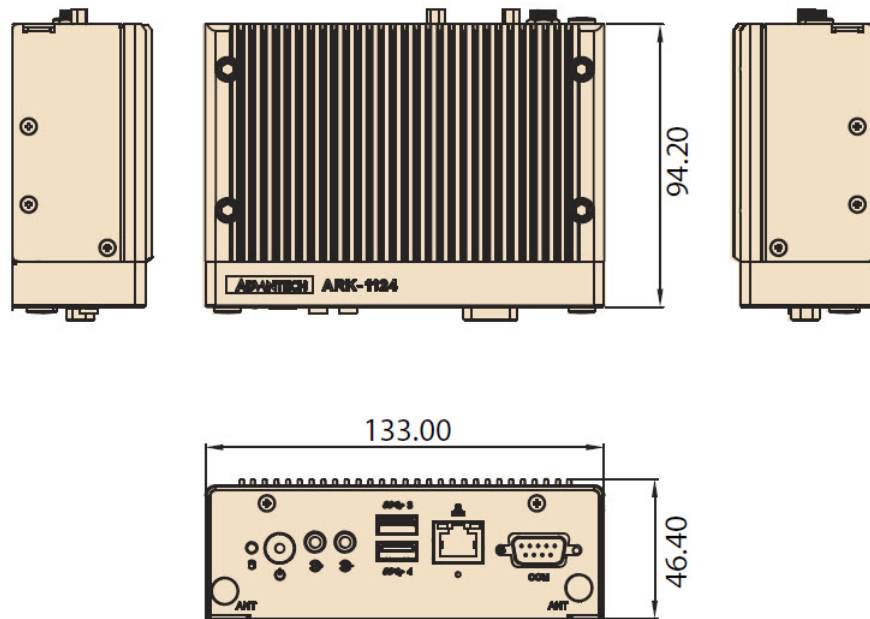

Figure 1.2 ARK-1124U Dimensions

1.4.3 ARK-1124H Dimensions

133[5.24] x 46.4 [1.83] x 94.2 [3.71] Unit: mm [Inch]

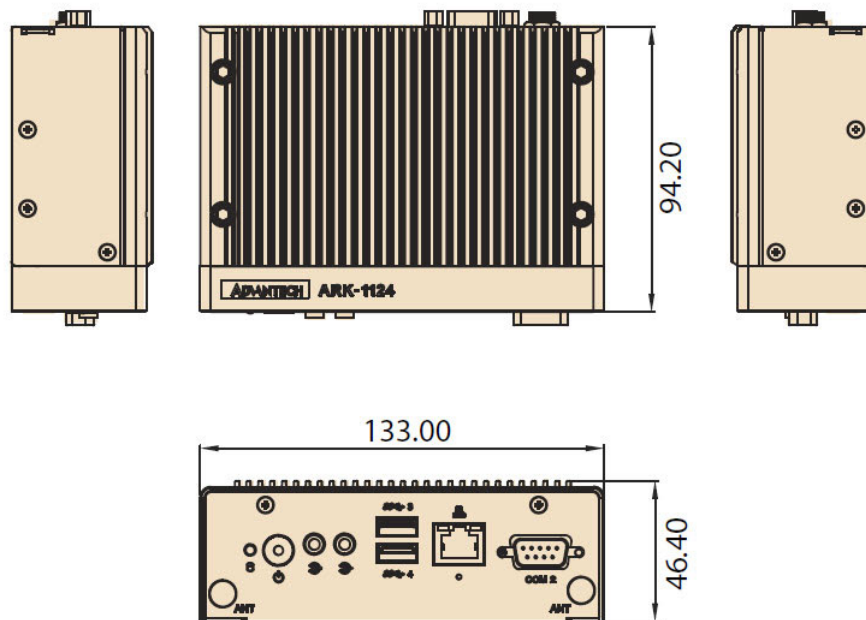

Figure 1.3 ARK-1124H Dimensions

1.4.4 Weight

0.7kg (1.55lb)

1.5 Power Requirement

1.5.1 System Power

- **Minimum power input:**
 - ARK-1124C: DC 12V, 3A
 - ARK-1124U/ARK-1124H: DC 12V, 5A

1.5.2 RTC Battery

- Lithium 3 V/210 mAH

1.6 Environment Specification

1.6.1 Operating Temperature

- With Industrial Grade SSD/mSATA: -20 ~ 60° C (-4~140° F), with air flow, speed=0.7 m/sec
- With 2.5-inch hard disk 0 to 45° C (32~113° F), with air flow, speed=0.7 m/sec

1.6.2 Relative Humidity

- 95% @ 40° C (non-condensing)

1.6.3 Storage Temperature

- -40 ~ 85° C (-40 ~ 185° F)

1.6.4 Vibration during Operation

- When the system is equipped with SSD/mSATA: 3Grms, IEC 60068-2-64, random, 5 ~ 500 Hz, 1hr/axis, x,y,z 3 axes.

1.6.5 Shock during Operation

- When the system is equipped with SSD/mSATA: 30G, IEC 60068-2-27, half sine, 11 ms duration.

1.6.6 Safety

- UL, CB, CCC, BSMI

1.6.7 EMC

- CE, FCC, CCC, BSMI

Chapter 2

H/W Installation

This chapter introduces external IO and the installation of ARK-1124 hardware.

2.1 Introduction

The following sections show the internal jumpers settings and the external connector pin assignments for application.

2.2 Jumpers

2.2.1 Jumper Description

You may configure ARK-1124 to match the needs of your application by setting jumpers. A jumper is a metal bridge used to close an electric circuit. It consists of two metal pins and a small metal clip (often protected by a plastic cover) that slides over the pins to connect them. To close a jumper, you connect the pins with the clip. To open a jumper, you remove the clip. Sometimes a jumper will have three pins, labeled 1, 2 and 3. In this case you would connect either pins 1 and 2, or 2 and 3.

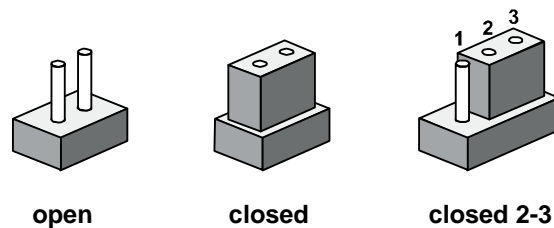

The jumper settings are schematically depicted in this manual as follows.

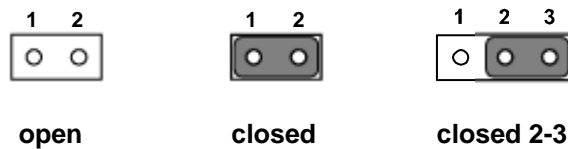

A pair of needle-nose pliers may be helpful when working with jumpers. If you have any doubts about the best hardware configuration for your application, contact your local distributor or sales representative before you make any changes. Generally, you simply need a standard cable to make most connections.

2.2.2 Jumper List

Table 2.1: Jumper setting

J1	Auto Power On Setting
----	-----------------------

2.2.3 Jumper Location

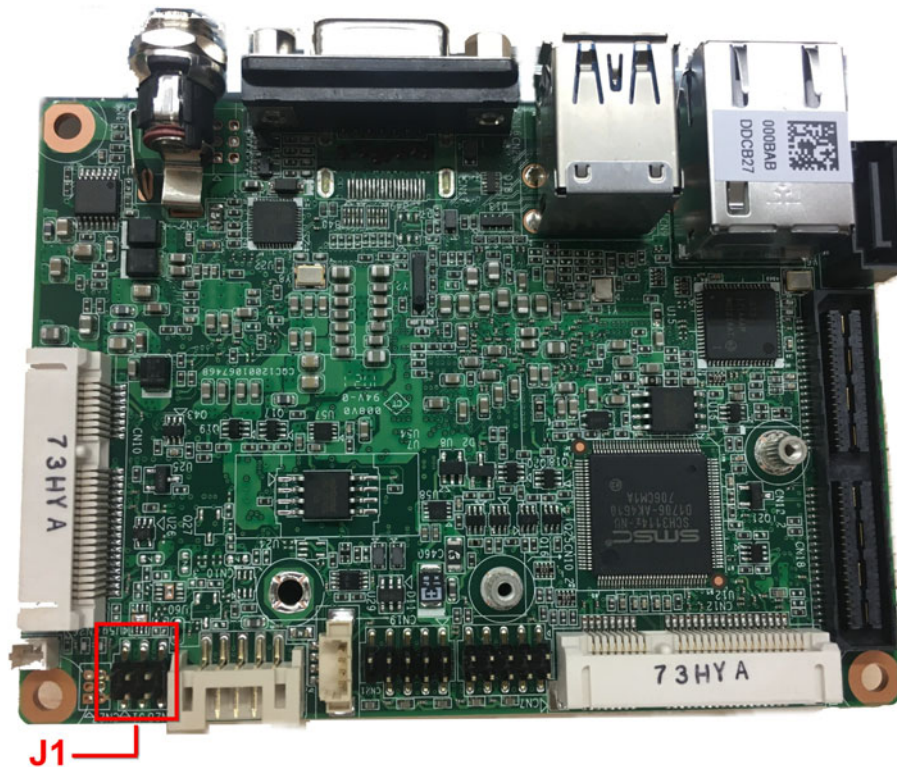
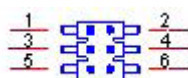

Figure 2.1 Jumper Layout

2.2.4 Jumper Setting

On the Motherboard

J1	Auto Power On Setting
Part Number	1653003260
Footprint	HD_3x2P_79
Description	PIN HEADER 3x2P 2.0mm 180D(M) SMD SOURCE PIN
Setting	Function
NL	Power On by power button (default)
(1-2)	+5V
(3-4)	+3.3V
(5-6)	AT Mode



2.3 ARK-1124 I/O Introduction

ARK-1124C

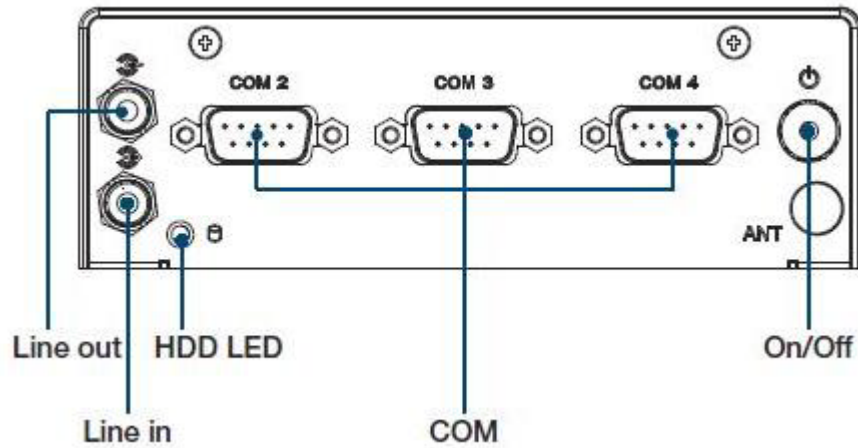

Figure 2.2 ARK-1124C Front View

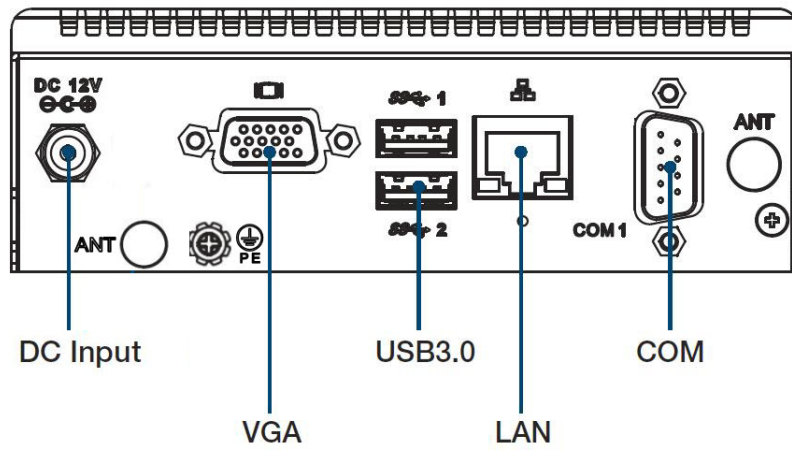

Figure 2.3 ARK-1124C Rear View

ARK-1124U

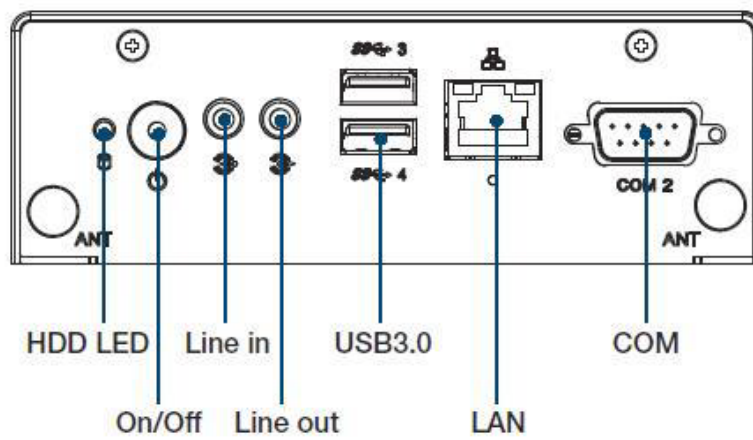

Figure 2.4 ARK-1124U Front View

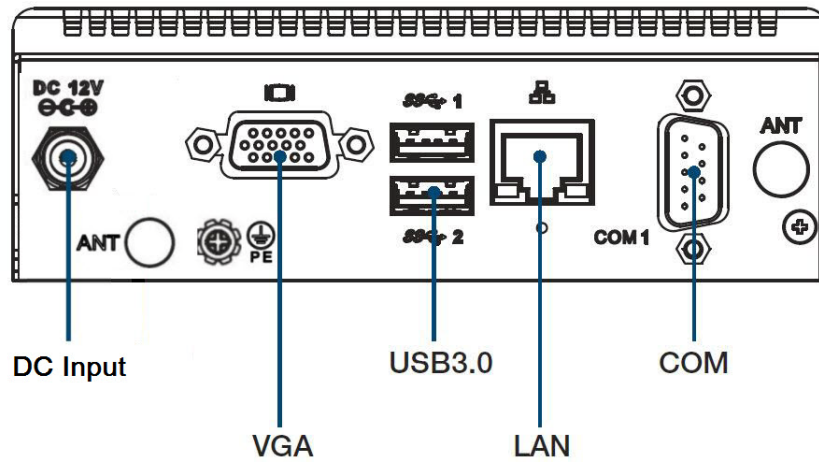

Figure 2.5 ARK-1124U Rear View

ARK-1124H

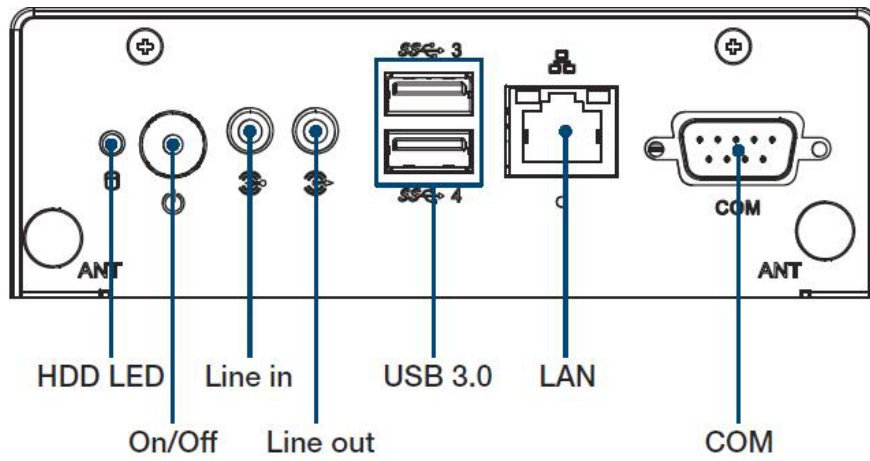

Figure 2.6 ARK-1124H Front View

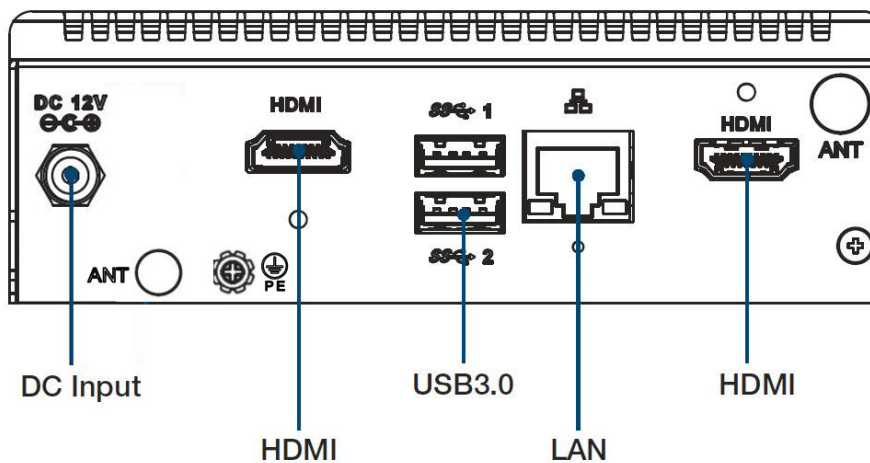

Figure 2.7 ARK-1124H Rear View

2.4 ARK-1124H External I/O

2.4.1 Power On/Off Button

ARK-1124H has a Power On/Off button with LED indicators on the front side that show On status (Green LED) and Off/Suspend status (Orange LED). The Power button supports dual functions: Soft Power -On/Off (Instant off or Delay 4 Seconds then off) and Suspend.



Figure 2.8 Power On/Off Button

2.4.2 Power Input Connector

ARK-1124H comes with a DC-Jack header that carries 12 VDC external power input.



Figure 2.9 Power Input Connector

2.4.3 Ethernet Connector (LAN)

ARK-1124H is equipped with two Ethernet controllers that are fully compliant with IEEE 802.3u 10/100/1000 Mbps CSMA/CD standards. LAN1, LAN2 are all equipped with i210 Ethernet controller. The Ethernet port provides a standard RJ-45 jack connector with LED indicators on the front side to show its Active/Link status (Green LED) and Speed status (Yellow LED).

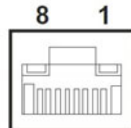

Figure 2.10 Ethernet Connector (LAN)

Table 2.2: Ethernet Connector (LAN) Pin Definition

Pin	10/100/1000 Mbps Signal Name
1	BI_DA+(GHz)
2	BI_DA-(GHz)
3	BI_DB+(GHz)
4	BI_DC+(GHz)
5	BI_DC-(GHz)
6	BI_DB-(GHz)
7	BI_DD+(GHz)
8	BI_DD-(GHz)
H3	GND
H4	GND

2.4.4 USB 3.0 Connector

ARK-1124H supports four USB3.0 interfaces, which provide complete Plug & Play and hot swapping for up to 127 external devices. The USB interface complies with USB UHCI, Rev. 3.0.

Please refer to Table. 2.3 for its pin assignments. USB 3.0 connectors contain legacy pins to interface to USB 2.0 devices, and a new set of pins for USB 3.0 connectivity (both sets reside in the same connector).

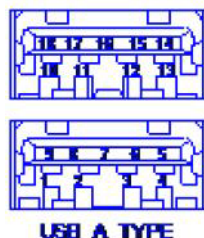

Figure 2.11 USB Connector

Table 2.3: USB Connector Pin Definition

Pin	Signal Name
1	+5V
2	D-_0
3	D+_0
4	GND
5	USB0_SSRX-
6	USB0_SSRX+
7	GND
8	USB0_SSTX-
9	USB0_SSTX+
10	+5V
11	D-_1
12	D+_1
13	GND
14	USB1_SSRX-
15	USB1_SSRX+
16	GND
17	USB1_SSTX-
18	USB1_SSTX+

2.4.5 Audio Connector

ARK-1124H offers stereo audio ports by two phone jack connectors of Line Out, Lin In. The audio chip is controlled by ALC888S, and it's compliant with Azalea standard.

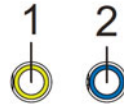

Figure 2.12 Audio Connector

Table 2.4: Audio Connector Pin Definition

Pin	Signal Name
1	Line-out
2	Line-in

2.4.6 COM Connector

ARK-1124H provides one D-sub 9-pin connectors, which offers RS232/422/485 serial communication interface ports. Default setting is RS-232, if you want to use RS-422/485, you can find the BIOS manual to change setting.

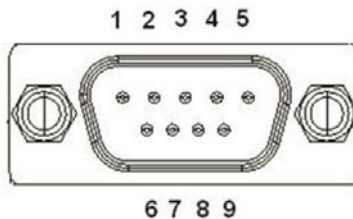

Figure 2.13 COM Connector

Table 2.5: COM Connector Pin Definition

Pin	Signal Name		
	RS-232	RS-422	RS-485
1	DCD	Tx-	DATA-
2	RxD	Tx+	DATA+
3	TxD	Rx+	NC
4	DTR	Rx-	NC
5	GND	GND	GND
6	DSR	NC	NC
7	RTS	NC	NC
8	CTS	NC	NC
9	RI	NC	NC

NC represents “No Connection”.

2.4.7 HDMI Connector

ARK-1124H offers two integrated 19-pin receptacle connector HDMI 1.4a interface. The HDMI link supports resolutions up to 3840 x 2160 @ 30 Hz.

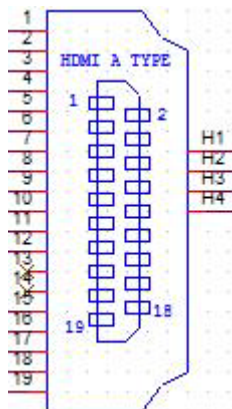

Figure 2.14 HDMI Connector

Table 2.6: HDMI Connector Pin Definition

Pin	Signal Name
1	HDMI_TX2+
2	GND
3	HDMI_TX2-
4	HDMI_TX1+
5	GND
6	HDMI_TX1-
7	HDMI_TX0+
8	GND
9	HDMI_TX0-
10	HDMI_CLK+
11	GND
12	HDMI_CLK-
13	NC
14	NC
15	HDMI_DCLK
16	HDMI_DDAT
17	GND
18	+V5_HDMI-HPD
19	DDPO_HPDP

NC represents "No Connection".

2.4.8 HDD LED Indicators

ARK-1124H provides one LED on the front panel that indicates HDD and compact flash disk status.



Figure 2.15 HDD LED Indicators

2.4.9 Antenna Hole

ARK-1124H reserves four antenna hole for wireless antenna installation. Each of antenna hole mark “ANT” to let antenna hold easy to be recognized.



Figure 2.16 Antenna Hole

2.5 ARK-1124U External I/O Connector

2.5.1 Power On/Off Button

ARK-1124U has a Power On/Off button with LED indicators on the front side that show On status (Green LED) and Off/Suspend status (Orange LED). The Power button supports dual functions: Soft Power -On/Off (Instant off or Delay 4 Seconds then off) and Suspend.



Figure 2.17 Power On/Off Button

2.5.2 Power Input Connector

ARK-1124U comes with a DC-Jack header that carries 12 VDC external power input



Figure 2.18 Power Input Connector

2.5.3 Ethernet Connector (LAN)

ARK-1124U is equipped with two Ethernet controllers that are fully compliant with IEEE 802.3u 10/100/1000 Mbps CSMA/CD standards. LAN1, LAN2 are all equipped with i210 Ethernet controller. The Ethernet port provides a standard RJ-45 jack connector with LED indicators on the front side to show its Active/Link status (Green LED) and Speed status (Yellow LED).

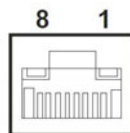

Figure 2.19 Ethernet Connector (LAN)

Table 2.7: Ethernet Connector (LAN)Pin Definition

Pin	10/100/1000 Mbps Signal Name
1	BI_DA+(GHz)
2	BI_DA-(GHz)
3	BI_DB+(GHz)
4	BI_DC+(GHz)

Table 2.7: Ethernet Connector (LAN)Pin Definition

5	BI_DC-(GHz)
6	BI_DB-(GHz)
7	BI_DD+(GHz)
8	BI_DD-(GHz)
H3	GND
H4	GND

2.5.4 USB Connector

ARK-1124U supports four USB3.0 interfaces, which provide complete Plug & Play and hot swapping for up to 127 external devices. The USB interface complies with USB UHCI, Rev. 3.0.

Please refer to Table. 2.8 for its pin assignments. USB 3.0 connectors contain legacy pins to interface to USB 2.0 devices, and a new set of pins for USB 3.0 connectivity (both sets reside in the same connector).

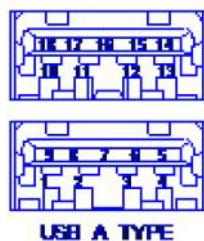
**Figure 2.20 USB Connector****Table 2.8: USB Connector Pin Definition**

Pin	Signal Name
1	+5V
2	D-_0
3	D+_0
4	GND
5	USB0_SSRX-
6	USB0_SSRX+
7	GND
8	USB0_SSTX-
9	USB0_SSTX+
10	+5V
11	D-_1
12	D+_1
13	GND
14	USB1_SSRX-
15	USB1_SSRX+
16	GND
17	USB1_SSTX-
18	USB1_SSTX+

2.5.5 Audio Connector

ARK-1124U offers stereo audio ports by two phone jack connectors of Line Out, Lin In. The audio chip is controlled by ALC888S, and it's compliant with Azalea standard.

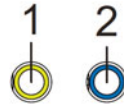

Figure 2.21 Audio Connector

Table 2.9: Audio Connector Pin Definition

Pin	Signal Name
1	Line-out
2	Line-in

2.5.6 COM Connector

ARK-1124U provides two D-sub 9-pin connectors, which offers RS232/422/485 serial communication interface ports. Default setting is RS-232, if you want to use RS-422/485, you can find the BIOS manual to change setting.

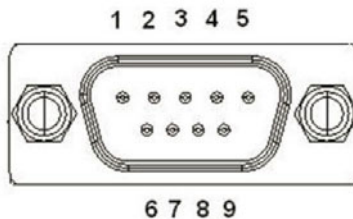

Figure 2.22 COM Connector

Table 2.10: COM Connector Pin Definition

Pin	Signal Name		
	RS-232	RS-422	RS-485
1	DCD	Tx-	DATA-
2	RxD	Tx+	DATA+
3	TxD	Rx+	NC
4	DTR	Rx-	NC
5	GND	GND	GND
6	DSR	NC	NC
7	RTS	NC	NC
8	CTS	NC	NC
9	RI	NC	NC

NC represents "No Connection".

2.5.7 VGA Connector

ARK-1124U The ARK-1124U provides a high resolution VGA interface connected by a D-sub 15- pin connector to support a VGA CRT monitor. It supports display resolutions of up to 2048 x 1280 @ 60Hz.

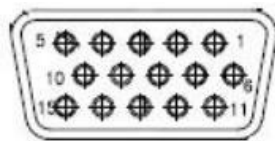

Figure 2.23 VGA Connector

Table 2.11: VGA Connector Pin Definition

Pin	Signal Name
1	VGA_z_R
2	VGA_z_G
3	VGA_z_B
4	VGA_z_SPC
5	GND
6	GND_RGB
7	GND_RGB
8	GND_RGB
9	+V5
10	GND
11	VGA_z_SPD
12	VGA_z_DDAT
13	VGA_z_HS
14	VGA_z_VS
15	VGA_z_DCLK
16	NC
17	NC
18	GND_IO
19	GND_IO

NC represents "No Connection".

2.5.8 HDD LED Indicators

ARK-1124U provides one LED on the front panel that indicates HDD and compact flash disk status.



Figure 2.24 HDD LED Indicators

2.5.9 Antenna Hole

ARK-1124U reserves four antenna holes for wireless antenna installation. Each of antenna hole mark “ANT” to let antenna hold easy to be recognized.



Figure 2.25 Antenna Hole

2.6 ARK-1124C External I/O Connector

2.6.1 Power On/Off Button

ARK-1124C has a Power On/Off button with LED indicators on the front side that show On status (Green LED) and Off/Suspend status (Orange LED). The Power button supports dual functions: Soft Power -On/Off (Instant off or Delay 4 Seconds then off) and Suspend.



Figure 2.26 Power On/Off Button

2.6.2 Power Input Connector

ARK-1124C comes with a DC-Jack header that carries 12 VDC external power input



Figure 2.27 Power Input Connector

2.6.3 Ethernet Connector (LAN)

ARK-1124C is equipped with one Ethernet controllers that are fully compliant with IEEE 802.3u 10/100/1000 Mbps CSMA/CD standards. LAN1 is equipped with i210 Ethernet controller. The Ethernet port provides a standard RJ-45 jack connector with LED indicators on the front side to show its Active/Link status (Green LED) and Speed status (Yellow LED).

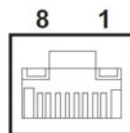

Figure 2.28 Ethernet Connector (LAN)

Table 2.12: Ethernet Connector (LAN)Pin Definition

Pin	10/100/1000 Mbps Signal Name
1	BI_DA+(GHz)
2	BI_DA-(GHz)
3	BI_DB+(GHz)
4	BI_DC+(GHz)

Table 2.12: Ethernet Connector (LAN)Pin Definition

5	BI_DC-(GHz)
6	BI_DB-(GHz)
7	BI_DD+(GHz)
8	BI_DD-(GHz)
H3	GND
H4	GND

2.6.4 USB Connector

ARK-1124C supports two USB3.0 interface, which provide complete Plug & Play and hot swapping for up to 127 external devices. The USB interface complies with USB UHCI, Rev. 3.0.

Please refer to Table. 2.13 for its pin assignments. USB 3.0 connectors contain legacy pins to interface to USB 2.0 devices, and a new set of pins for USB 3.0 connectivity (both sets reside in the same connector).

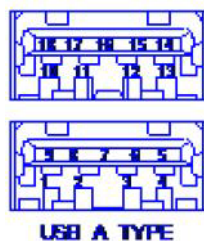
**Figure 2.29 USB Connector****Table 2.13: USB Connector Pin Definition**

Pin	Signal Name
1	+5V
2	D-_0
3	D+_0
4	GND
5	USB0_SSRX-
6	USB0_SSRX+
7	GND
8	USB0_SSTX-
9	USB0_SSTX+
10	+5V
11	D-_1
12	D+_1
13	GND
14	USB1_SSRX-
15	USB1_SSRX+
16	GND
17	USB1_SSTX-
18	USB1_SSTX+

2.6.5 Audio Connector

ARK-1124C offers stereo audio ports by two phone jack connectors of Line_Out, Lin_In. The audio chip is controlled by ALC888S, and it's compliant with Azalea standard.

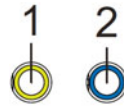

Figure 2.30 Audio Connector

Table 2.14: Audio Connector Pin Definition

Pin	Signal Name
1	Line-out
2	Line-in

2.6.6 COM Connector

ARK-1124C provides four D-sub 9-pin connectors, which offers RS232/422/485 serial communication interface ports. Default setting is RS-232, if you want to use RS-422/ 485, you can find the BIOS manual to change setting.

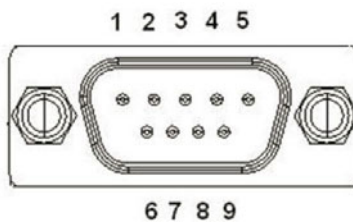

Figure 2.31 COM Connector

Table 2.15: COM Connector Pin Definition

Pin	RS-232	RS-422	RS-485
	Signal Name		
1	DCD	Tx-	DATA-
2	RxD	Tx+	DATA+
3	TxD	Rx+	NC
4	DTR	Rx-	NC
5	GND	GND	GND
6	DSR	NC	NC
7	RTS	NC	NC
8	CTS	NC	NC
9	RI	NC	NC

NC represents "No Connection".

2.6.7 VGA Connector

The ARK-1124C provides a high resolution VGA interface connected by a D-sub 15-pin connector to support a VGA CRT monitor. It supports display resolutions of up to 2048 x 1280 @ 60Hz.

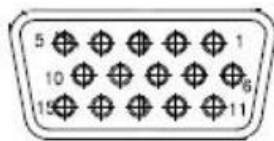

Figure 2.32 VGA Connector

Table 2.16: VGA Connector Pin Definition

Pin	Signal Name
1	VGA_z_R
2	VGA_z_G
3	VGA_z_B
4	VGA_z_SPC
5	GND
6	GND_RGB
7	GND_RGB
8	GND_RGB
9	+V5
10	GND
11	VGA_z_SPD
12	VGA_z_DDAT
13	VGA_z_HS
14	VGA_z_VS
15	VGA_z_DCLK
16	NC
17	NC
18	GND_IO
19	GND_IO

NC represents "No Connection".

2.6.8 HDD LED Indicator

ARK-1124C provides one LED on the front panel that indicates HDD and compact flash disk status.



Figure 2.33 HDD LED Indicators

2.6.9 Antenna Hole

ARK-1124C reserves three antenna hole for wireless antenna installation. Each of antenna hole mark “ANT” to let antenna hold easy to be recognized.



Figure 2.34 Antenna Hole

2.7 Installation

2.7.1 HDD/SSD Installation

1. Remove the four screws on right and left side of ARK-1124.



2. Remove the bottom cover.



3. Remove the four snap rivets from the bottom cover.

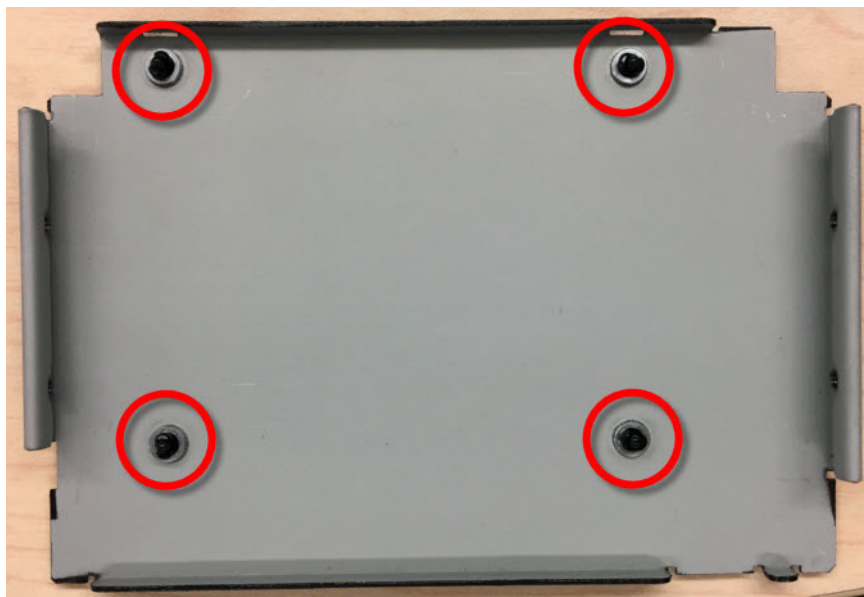

4. Secure 2.5" SATA HDD onto the bottom cover. The screws are in the accessory box.

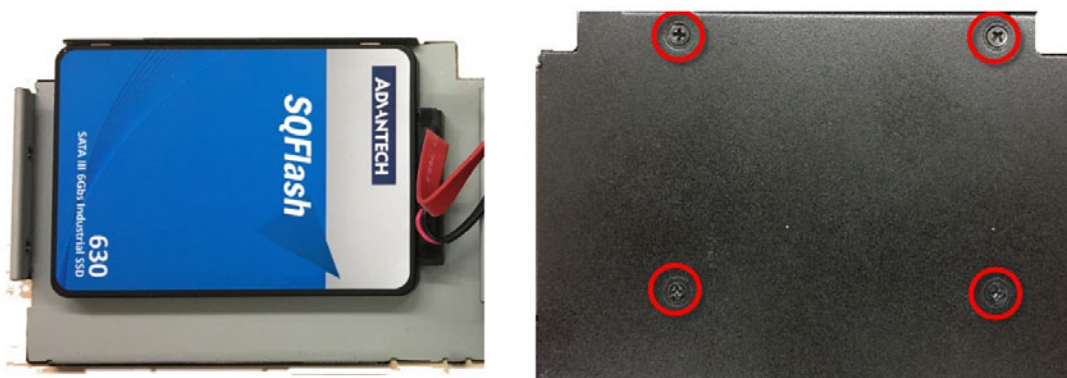

5. Connect SATA signal and power cable to the 2.5" SATA HDD.



6. Replace the bottom cover and fasten the four screws back onto the system.



2.7.2 RAM Installation

1. Unscrew the 4 screws on the top cover. (Please use the tool in the accessory box.)



2. Remove the top cover and install the memory into the memory socket.



3. Replace the top cover and screw four screws back.

2.7.3 M.2 Module Installation

** Below installation is for ARK-1124H only. For ARK-1124U, we suggest to install by CTOS due to complex installation.

1. Remove the four screws on right and left side of ARK-1124.



2. Remove the bottom cover.



3. Install M.2 module in M.2 slot and secure module.

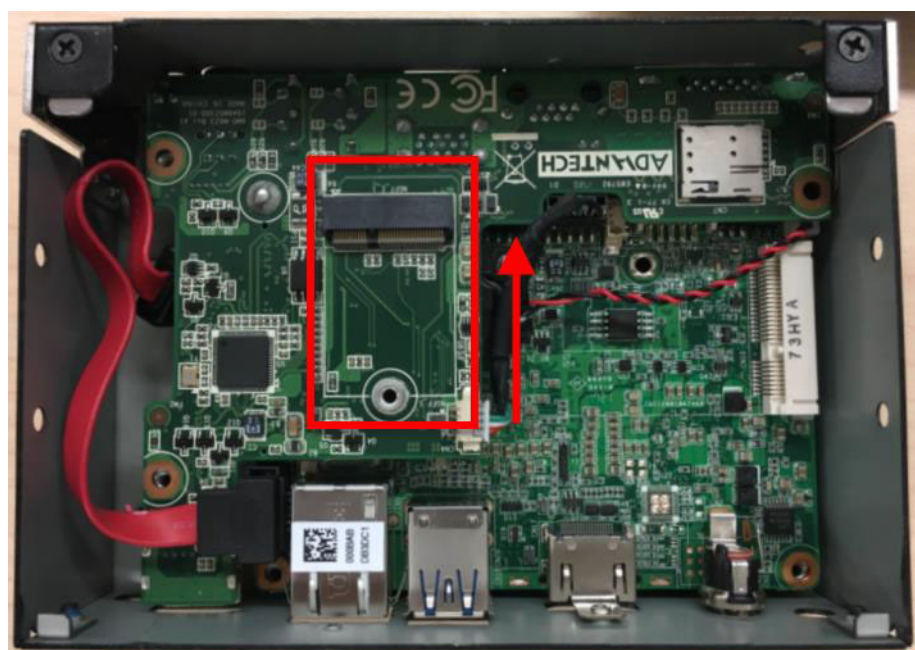

4. Replace the bottom cover and fasten the four screws back onto the system.

2.7.4 mSATA Installation:

For ARK-1124 series, we suggest to install mSATA by CTOS due to complex installation.

2.7.5 iDoor Module (AMO-1101) Installation (Option)

1. Remove the four screws on both sides of ARK-1124.



2. Remove the bottom cover.
3. Install iDoor module on miniPCIe slot.



4. Screw I/O plate of iDoor module on ARK Plus module (AMO-1101).



5. Stack ARK plus module with system, and screw two screws each rear side.

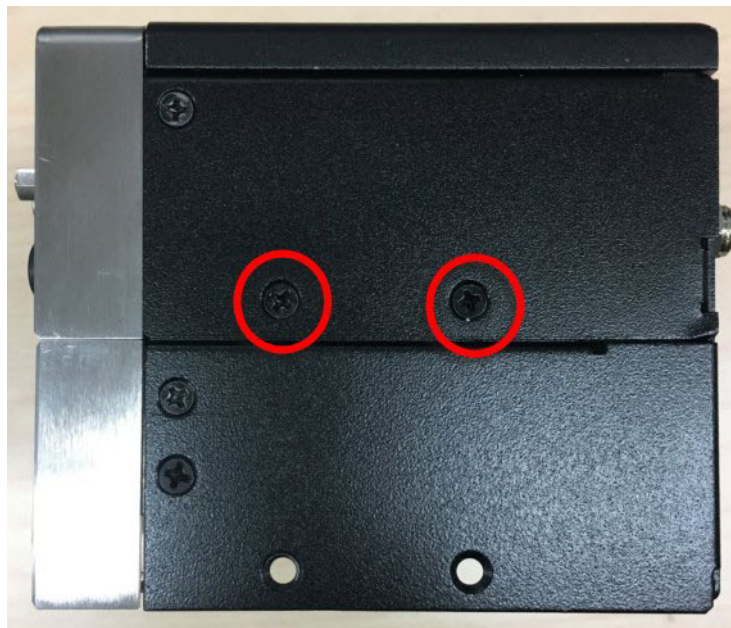

6. Recover bottom cover, and screw two screws each rear side.
7. Finished.

2.7.6 Power Module (AMO-P011) Installation (Option)

1. Screw power module with ARK Plus module (AMO-1101)



2. Remove the four screws on both sides of ARK-1124.



3. Remove the bottom cover.
4. Connect power cable between power module and M/B.

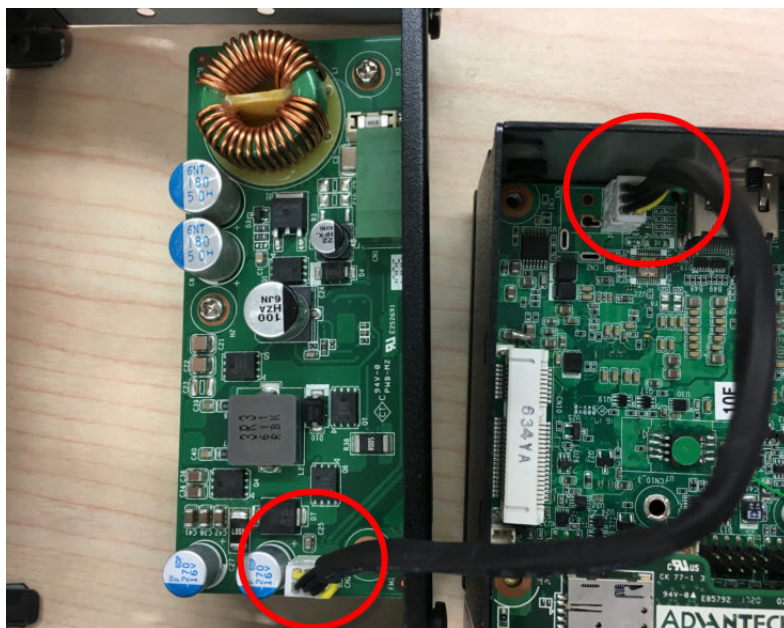

5. Stack ARK plus module with system, and screw two screws each rear side.
6. Recover bottom cover, and screw two screws each rear side.
7. Stick black Mylar on 12V DC print, and put DC jack cover on the hold in original DC jack position.

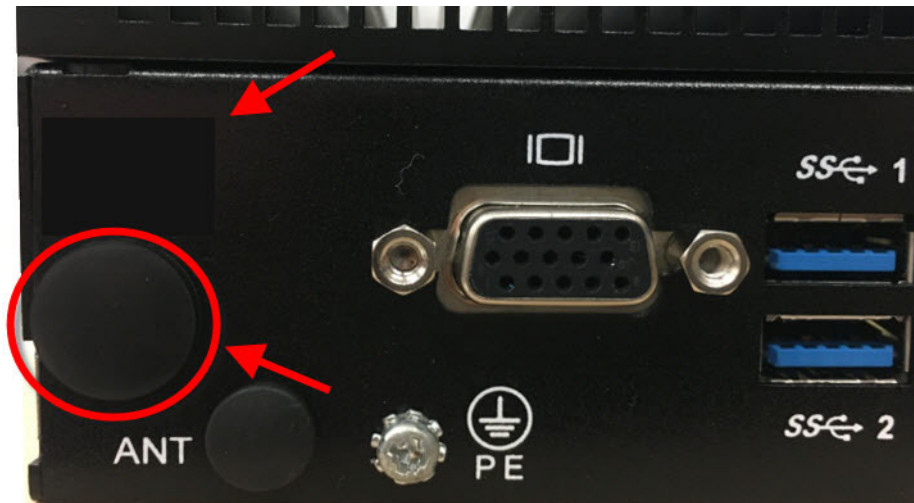

8. Finished.

Chapter 3

BIOS Settings

3.1 BIOS Setup

With the AMIBIOS setup program, you can modify BIOS settings and control the various system features. This chapter describes the basic navigation of the ARK-1124 BIOS setup screens.

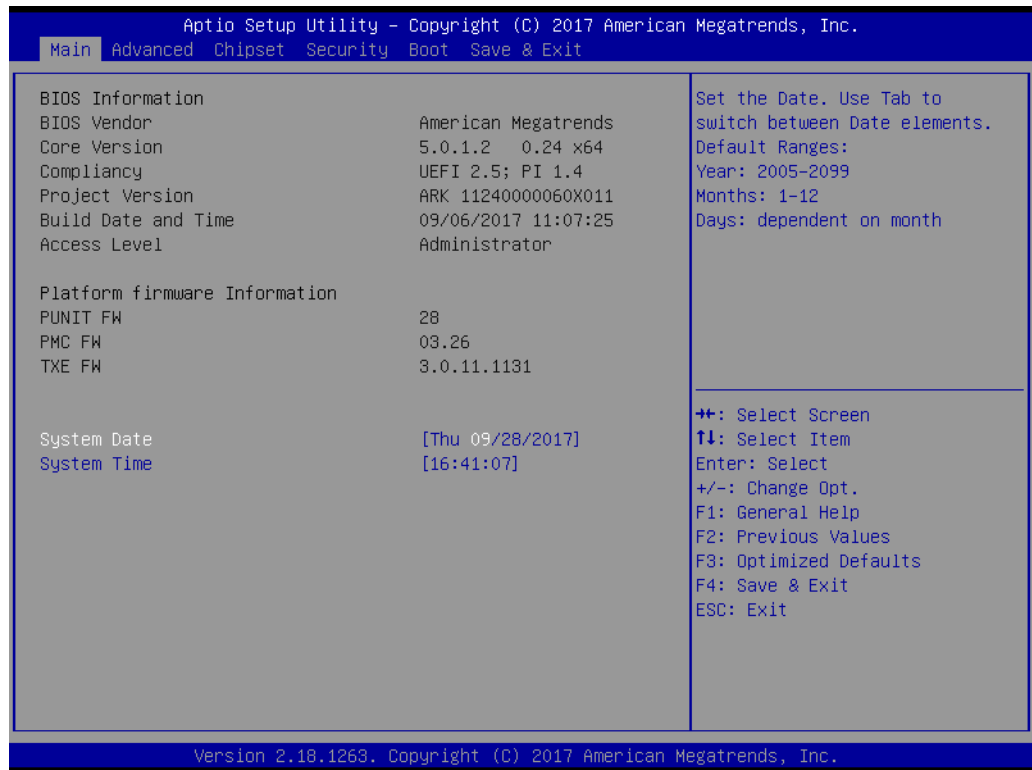

Figure 3.1 Setup program initial screen

AMI's BIOS ROM has a built-in Setup program that allows users to modify the basic system configuration. This information is stored in flash ROM so it retains the Setup information when the power is turned off.

3.2 Entering Setup

Turn on the computer and then press <F2> or to enter Setup menu.

3.2.1 Main Setup

When users first enter the BIOS Setup Utility, users will enter the Main setup screen. Users can always return to the Main setup screen by selecting the Main tab. There are two Main Setup options. They are described in this section. The Main BIOS Setup screen is shown below.

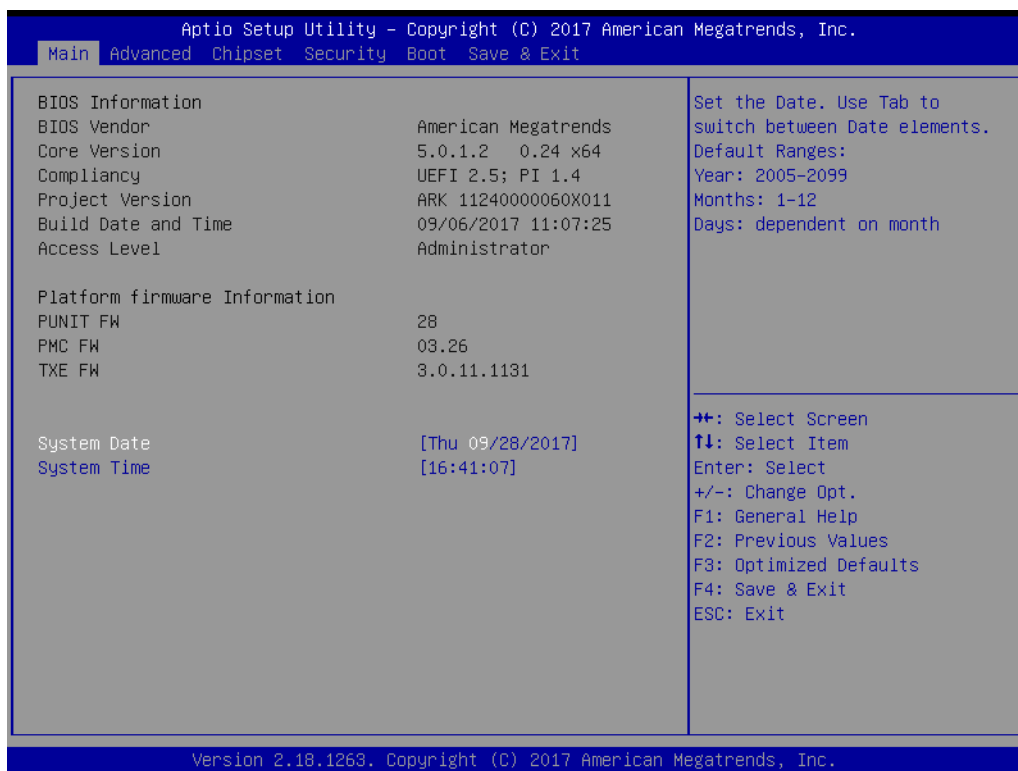

Figure 3.2 Main setup screen

The Main BIOS setup screen has two main frames. The left frame displays all the options that can be configured. Grayed-out options cannot be configured; options in blue can. The right frame displays the key legend.

Above the key legend is an area reserved for a text message. When an option is selected in the left frame, it is highlighted in white. Often a text message will accompany it.

■ System date / System time

Use this option to change the system time and date. Highlight System Time or System Date using the <Arrow> keys. Enter new values through the keyboard. Press the <Tab> key or the <Arrow> keys to move between fields. The date must be entered in MM/DD/YY format. The time must be entered in HH:MM:SS format.

3.2.2 Advanced BIOS Features Setup

Select the Advanced tab from the ARK-1124 setup screen to enter the Advanced BIOS Setup screen. You can select any of the items in the left frame of the screen, such as CPU Configuration, to go to the sub menu for that item. You can display an Advanced BIOS Setup option by highlighting it using the <Arrow> keys. All Advanced BIOS Setup options are described in this section. The Advanced BIOS Setup screens are shown below. The sub menus are described on the following pages.

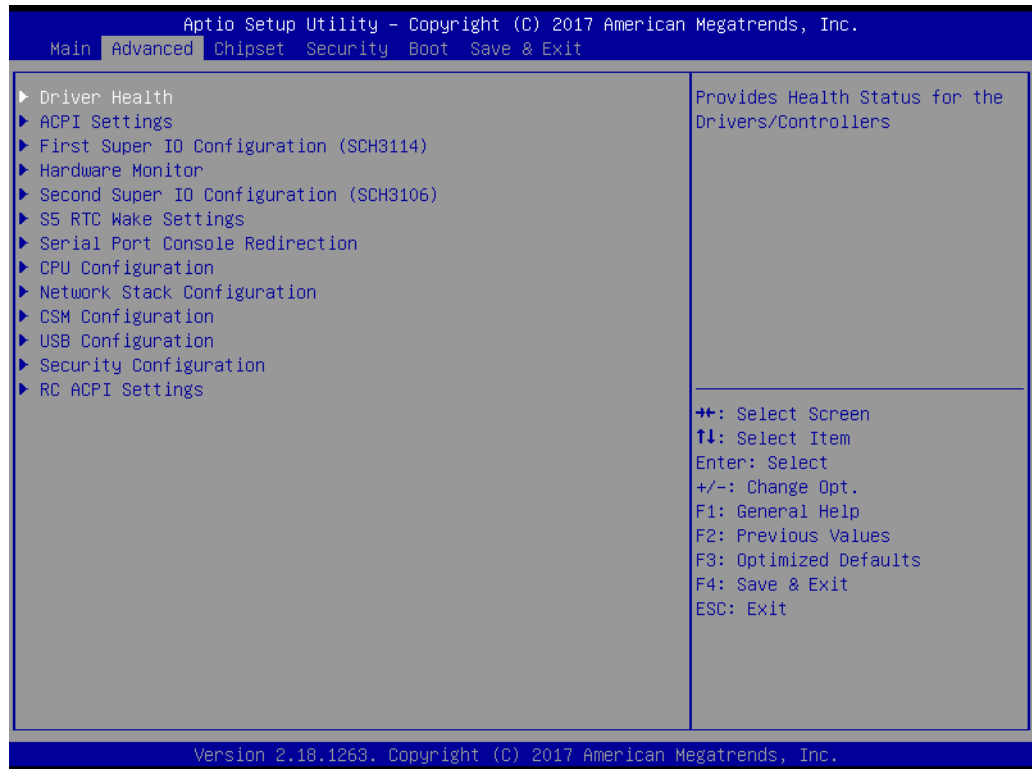

Figure 3.3 Advanced BIOS features setup screen

3.2.2.1 Driver Health



Figure 3.4 Driver Health Status screen

Provides Health Status for the Drivers/Controllers.

3.2.2.2 ACPI Settings

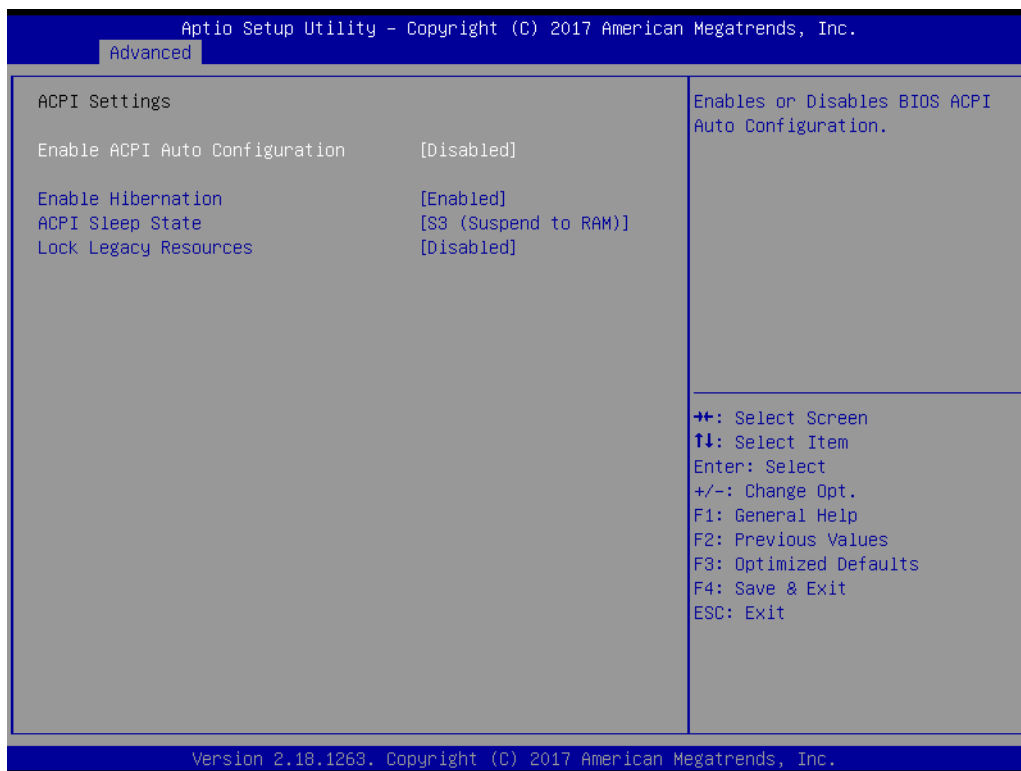

Figure 3.5 ACPI Setting

- **Enable ACPI Auto Configuration**
This item allows users to enable or disable BIOS ACPI auto configuration.
- **Enable Hibernation**
This item allows users to enable or disable hibernation.
- **ACPI Sleep State**
This item allows users to set the ACPI sleep state.
- **Lock Legacy Resources**
This item allows users to lock legacy device resources.

3.2.2.3 Super I/O Configuration

- **First Super I/O Configuration (SCH3114)**

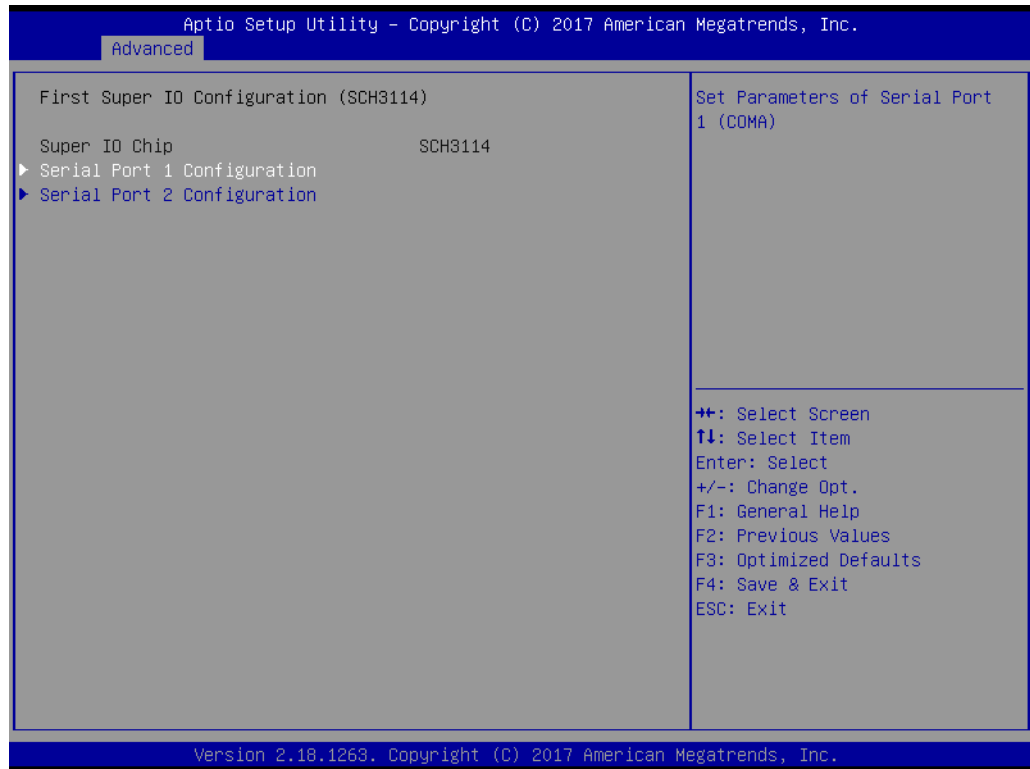
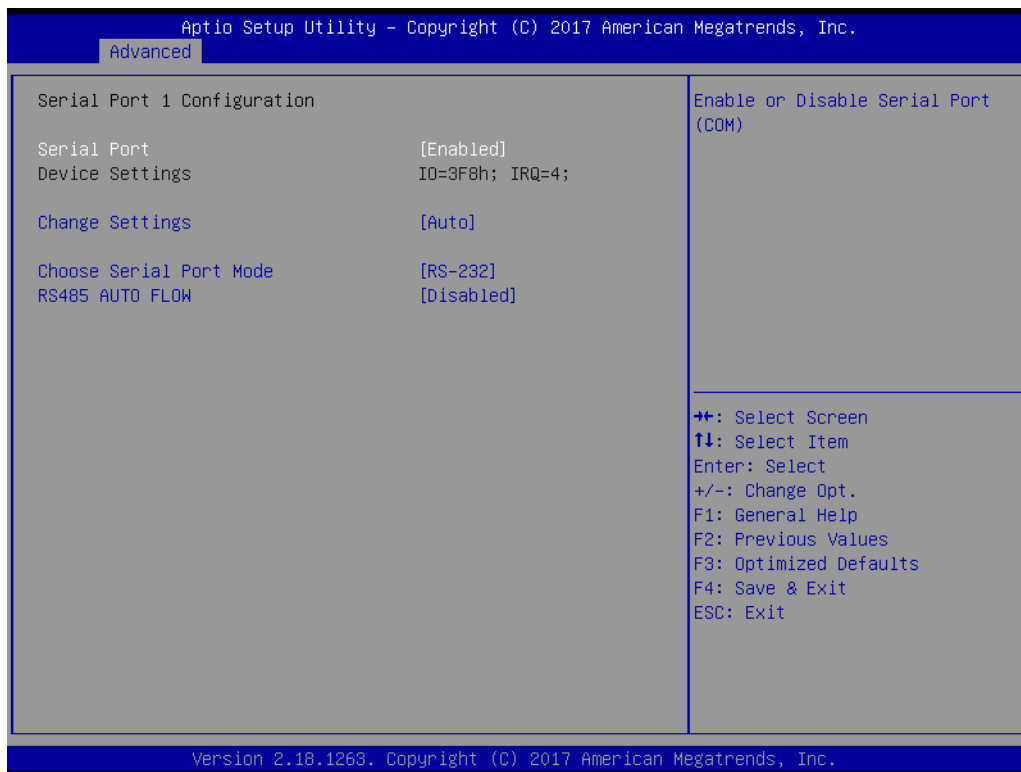

Figure 3.6 First Serial Port Configuration(SCH3114)

- Serial Port 1 Configuration
Set Parameters of Serial Port 1 (COMA).
- Serial Port 2 Configuration
Set Parameters of Serial Port 2 (COMB).



- Serial Port
Enable or Disable Serial Port (COM).
- Change Settings
Select an optimal settings for Super IO Device.
- Choose Serial Port Mode
Change the Serial Port Mode.
- RS485 AUTO FLOW
Enable or Disable RS485 AUTO FLOW

■ **Second Super I/O Configuration (SCH3106)**



Figure 3.7 Second Serial Port Configuration(SCH3106)

- Serial Port 3 Configuration
Set Parameters of Serial Port 3 (COMA2).
- Serial Port 4 Configuration
Set Parameters of Serial Port 4 (COMB2).

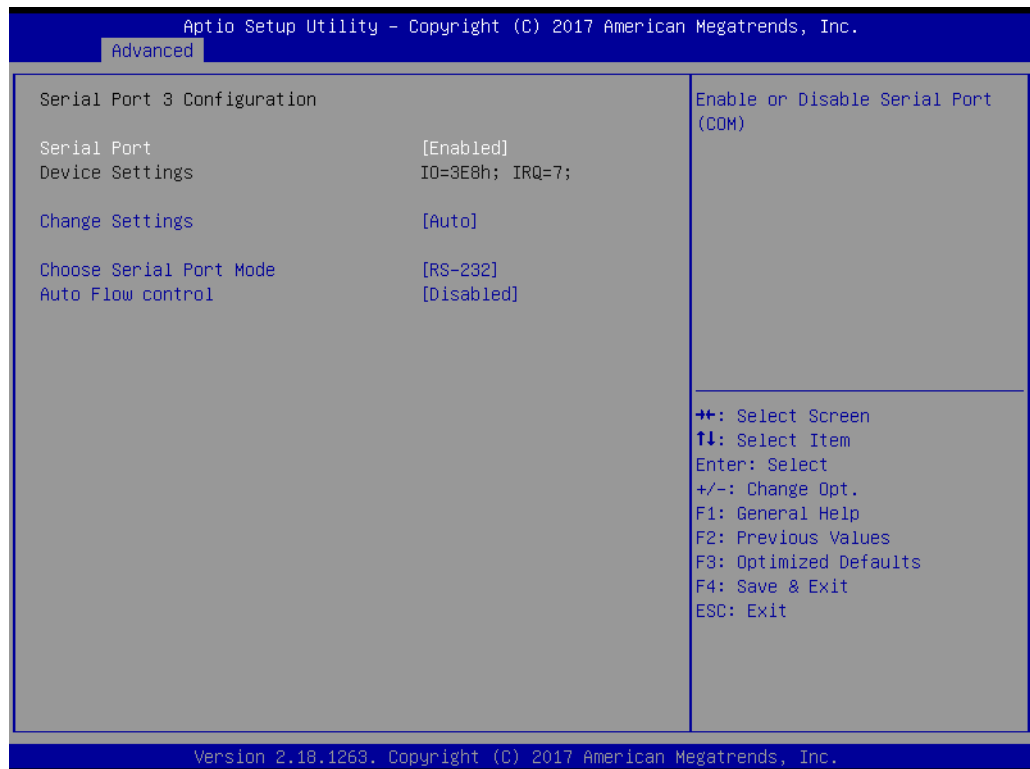
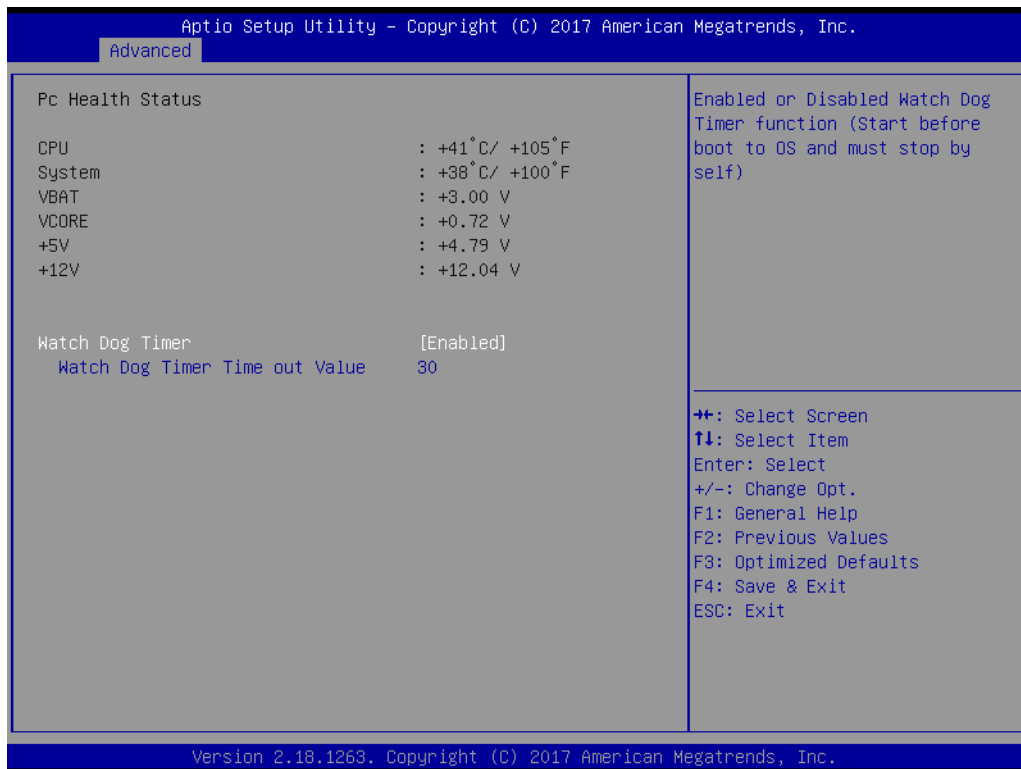

Figure 3.8 Serial Port Settings (Port3)

- Serial Port
Enable or Disable Serial Port (COM).
- Change Settings
Select an optimal settings for Super IO Device.
- Choose Serial Port Mode
Change the Serial Port Mode.
- RS485 AUTO FLOW
Enable or Disable RS485 AUTO FLOW

3.2.2.4 Hardware Monitor



- **Pc Health Status**
This page displays all the information about system Temperature/Voltage.
- **Watch Dog Timer**
Enabled or Disabled Watch Dog Timer function (Start before boot to OS and must stop by self).

3.2.2.5 S5 RTC Wake Settings

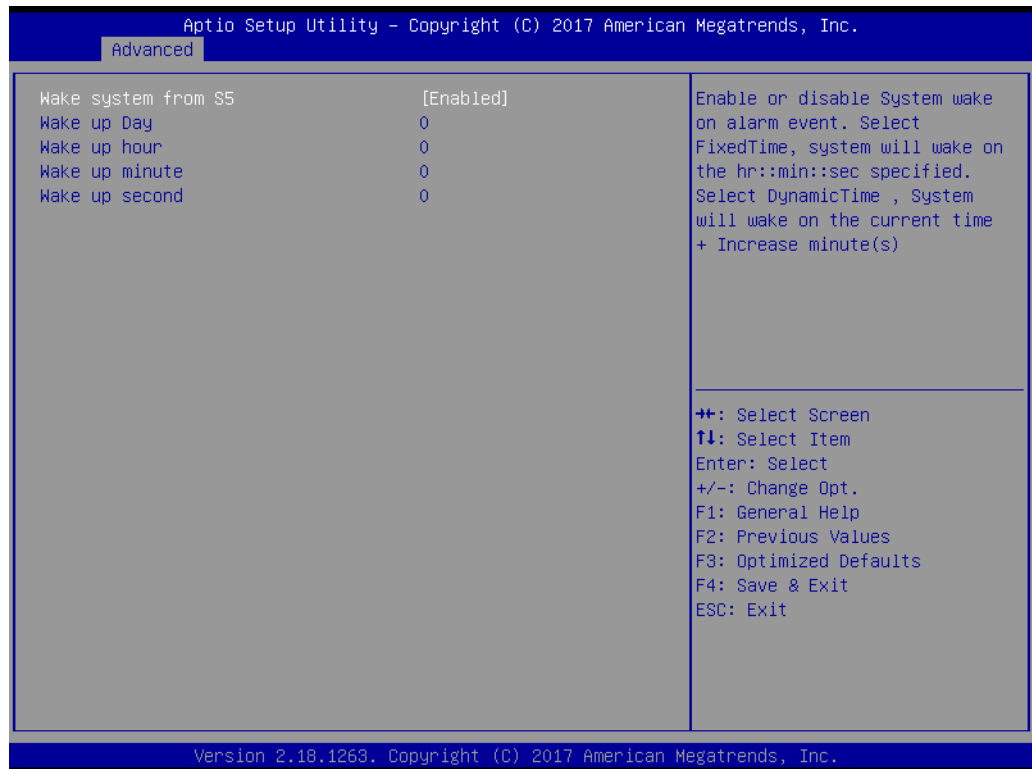

- **Wake system with Fixed Time**
Enable or disable System wake on alarm event. Selecting FixedTime, system will wake on the hr:min:sec specified. Selecting DynamicTime, System will wake on the current time + Increase minute(s).

3.2.2.6 Serial Port Console Redirection

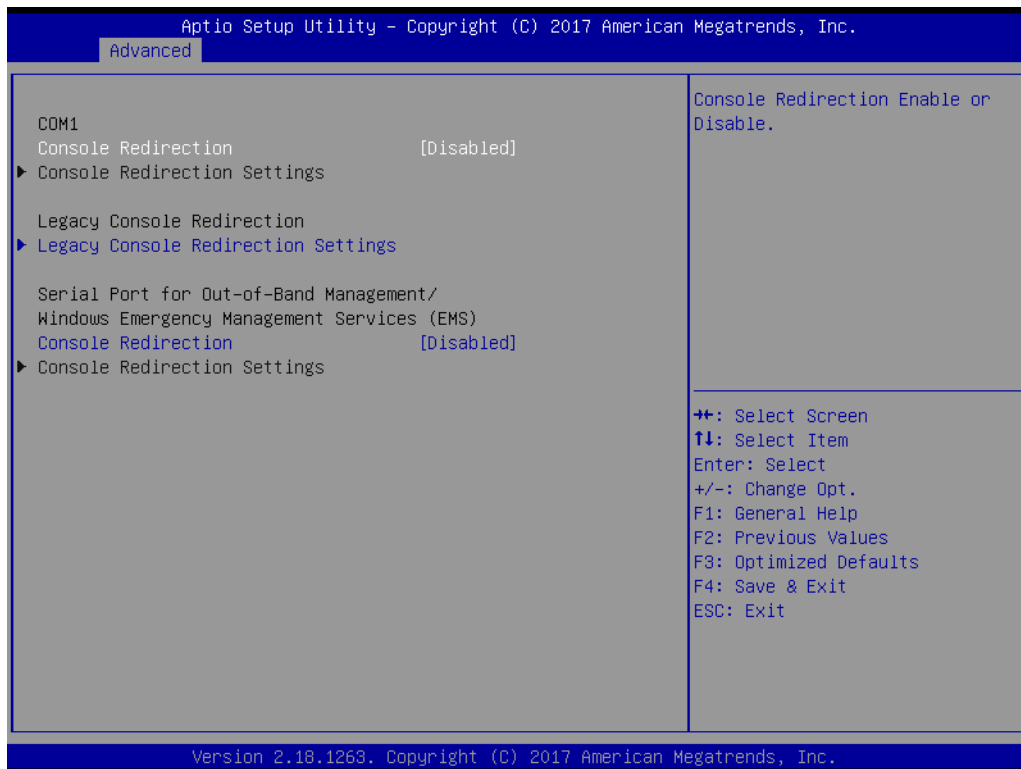

- **Console Redirection**
This item allows users to enable or disable console redirection for Microsoft Windows Emergency Management Services (EMS).
- **Legacy Console Redirection**
This item allows users to configuration Legacy Serial Redirection Port
- **Console Redirection**
This item allows users to configuration console redirection detail settings.

3.2.2.7 CPU Configuration

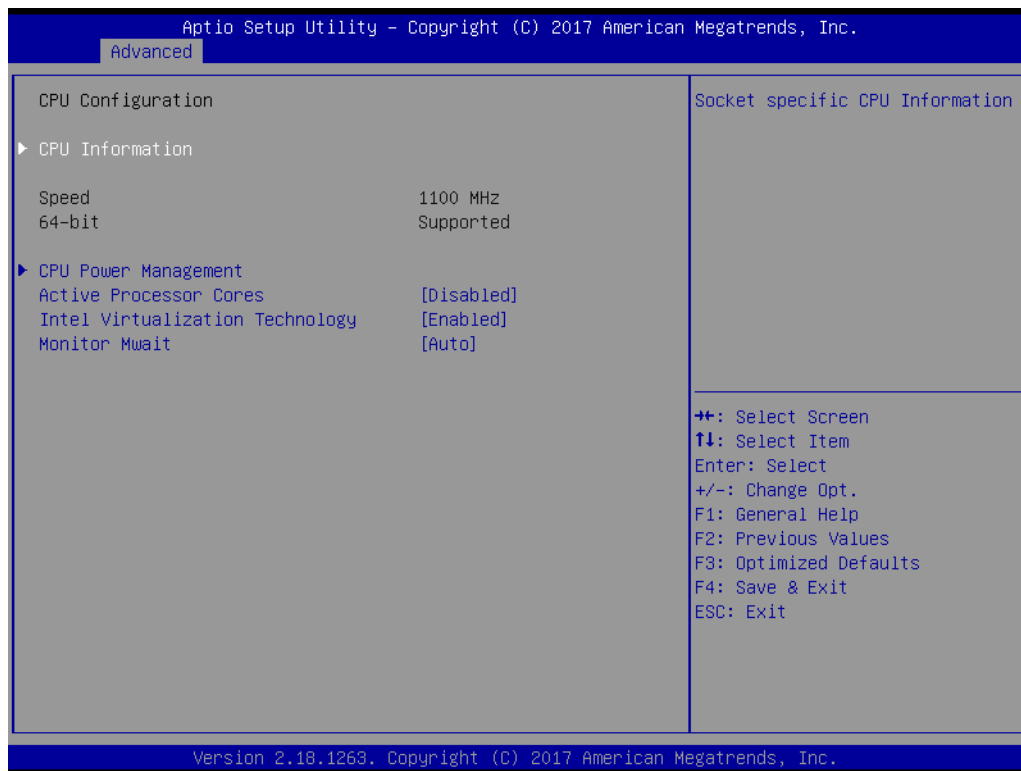

Figure 3.9 Intel Fast Flash Standby

- **CPU Configuration**
Socket specific CPU Information.
- **CPU Power Management**
CPU Power Management options.
- **Active Processor Cores**
Number of cores to enable in each processor package.
- **Intel Virtualization Technology**
When enabled, a VMM can utilize the additional hardware capabilities provided by Vanderpool Technology.
- **Monitor Mwait**
Enable/Disable Monitor Mwait.

■ CPU Power Management Configuration

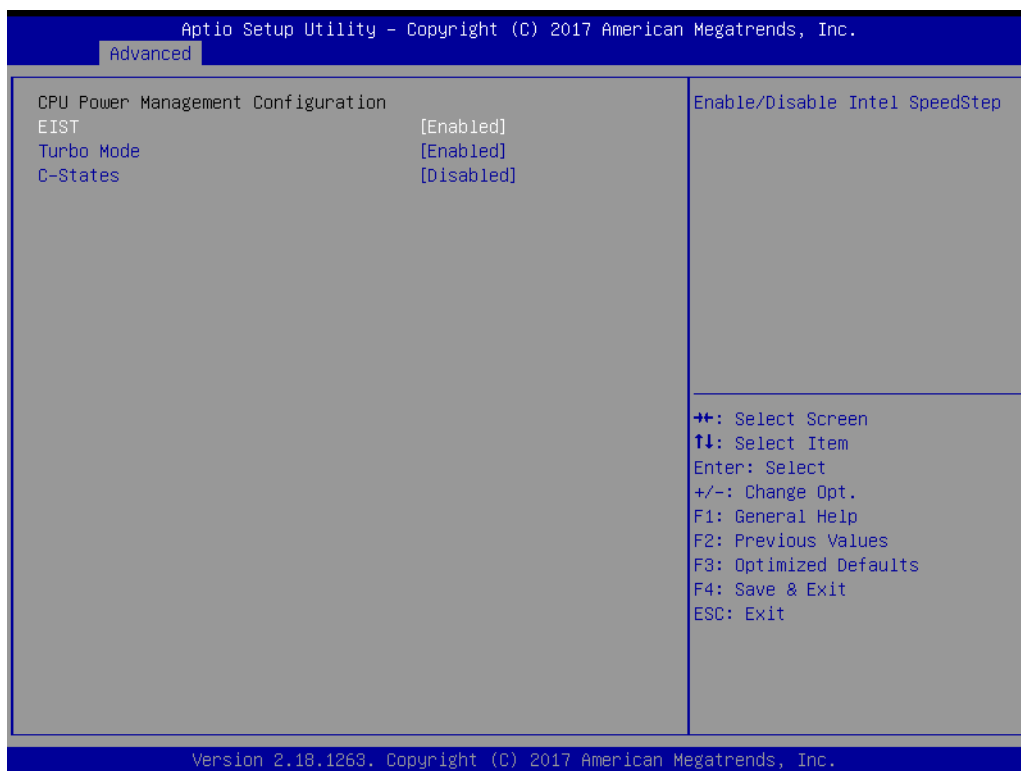

Figure 3.10 CPU Power Management Settings

- EIST
Enable/Disable Intel SpeedStep.
- Turbo mode
Turbo Mode.
- C-States
Enable/Disable C States.

3.2.2.8 Network Stack Configuration

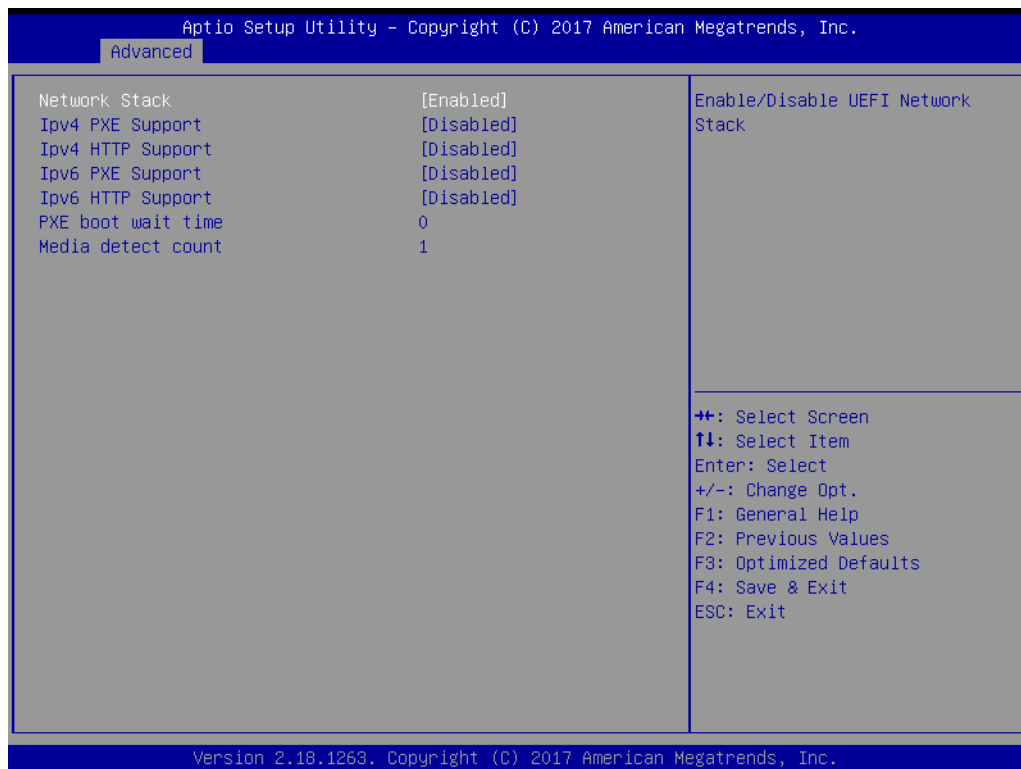

Figure 3.11 Network Configuration Settings

- **Network Stack**
Enable/Disable UEFI Network Stack.
- **Ipv4 PXE Support**
Enable Ipv4 PXE Boot Support. If disabled IPV4 PXE boot option will not be created.
- **Ipv4 HTTP Support**
Enable Ipv4 HTTP Boot Support. If disabled IPV4 HTTP boot option will not be created.
- **PXE boot wait time**
Wait time to press ESC key to abort the PXE boot.
- **Media detect count**
Number of times presence of media will be checked.

3.2.2.9 CSM Configuration

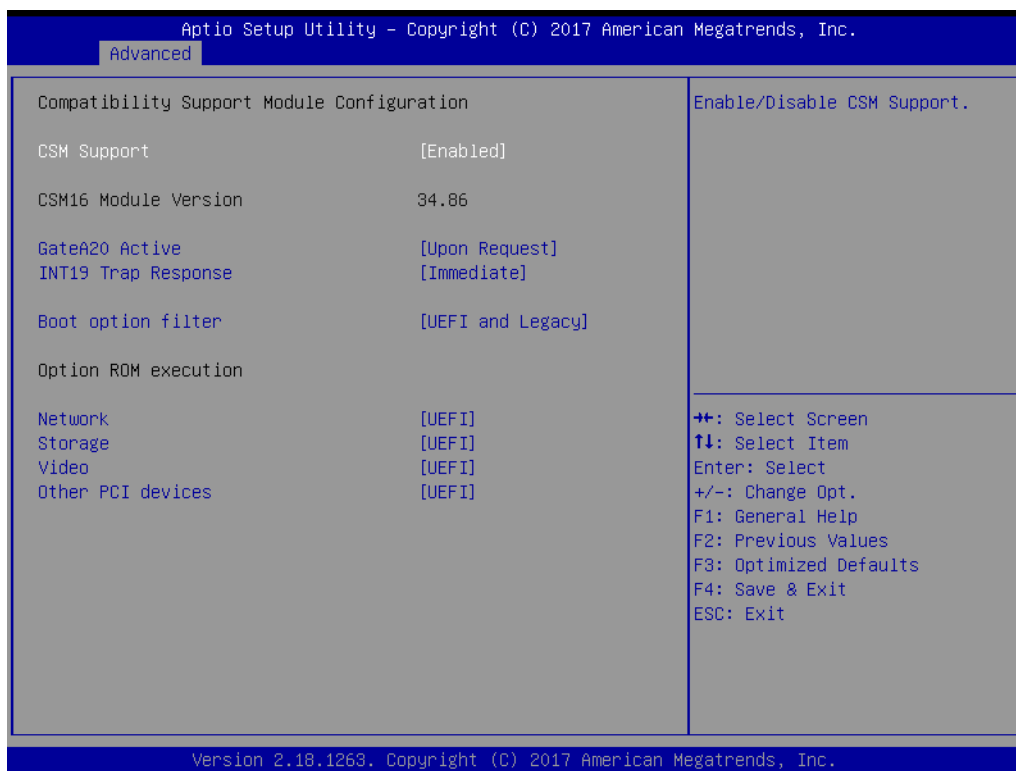
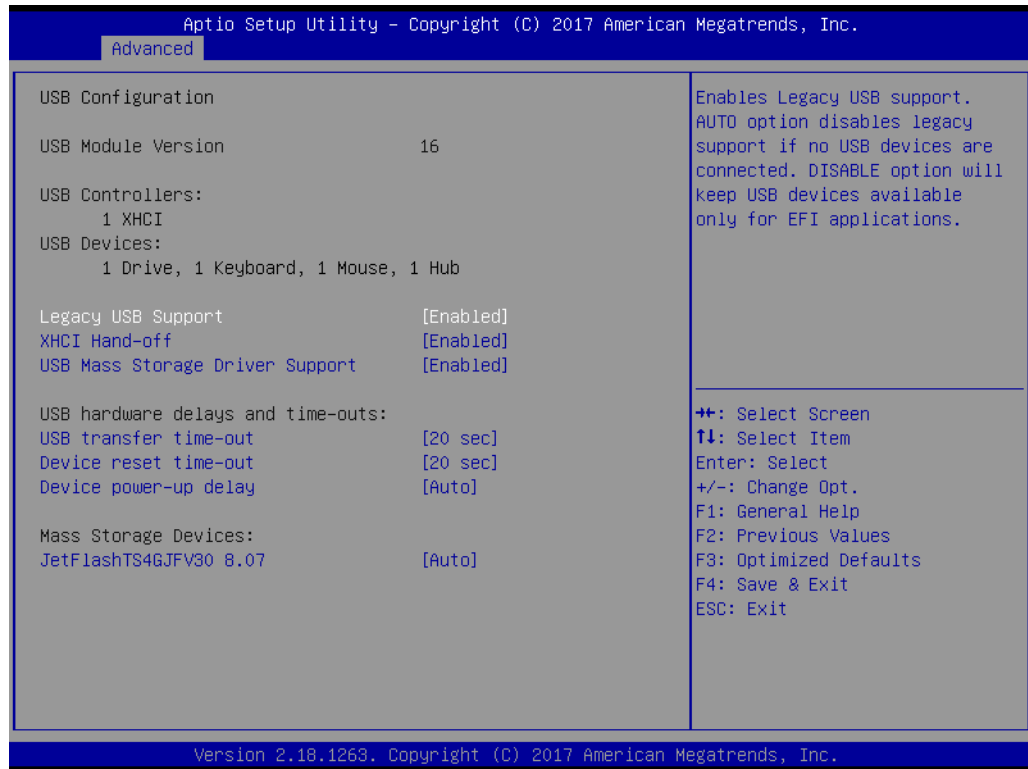

Figure 3.12 CSM Configuration Settings

- **CSM Support**
Enable/Disable CSM Support.
- **GateA20 Active**
UPON REQUEST - GA20 can be disabled using BIOS services. ALWAYS - do not allow disabling GA20; this option is useful when any RT code is executed above 1 MB.
- **INT19 Trap Response**
BIOS reaction on INT19 trapping by Option ROM: IMMEDIATE - execute the trap right away; POSTPONED - execute the trap during legacy boot.
- **Boot option filter**
This option controls Legacy/UEFI ROMs priority.
- **Network**
Controls the execution of UEFI and Legacy PXE OpROM.
- **Storage**
Controls the execution of UEFI and Legacy Storage OpROM.
- **Video**
Controls the execution of UEFI and Legacy Video OpROM.
- **Other PCI devices**
Determines OpROM execution policy for devices other than Network, Storage, or Video.

3.2.2.10 USB Configuration



- **Legacy USB Support**
Enables Legacy USB support. AUTO option disables legacy support if no USB devices are connected. DISABLE option will keep USB devices available only for EFI applications.
- **XHCI Hand-off**
This is a workaround for OS without XHCI hand-off support. The XHCI ownership change should be claimed by XHCI driver.
- **EHCI Hand-Off**
This is a workaround for OS without EHCI hand-off support. The EHCI ownership change should claim by EHCI driver.
- **USB Mass Storage Driver Support**
Enable/Disable USB Mass Storage Driver Support.
- **Device reset time-out**
USB mass storage device start unit command time-out.
- **Device power-up delay**
Maximum time the device will take before it properly reports itself to the Host Controller. 'Auto' uses default value: for a Root port it is 100 ms, for a Hub port the delay is taken from Hub descriptor.

3.2.2.11 Security Configuration

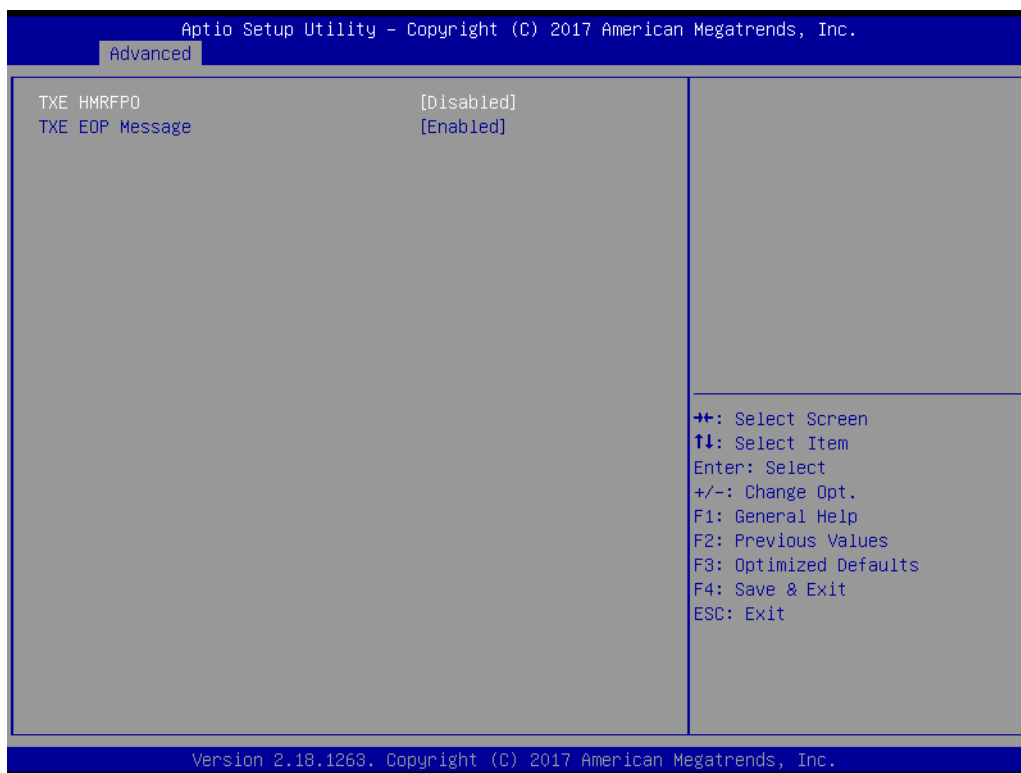

Figure 3.13 Security Configuration Settings

- **TXE EOP Message**
Send EOP message before entering OS

3.2.2.12 RC ACPI Settings

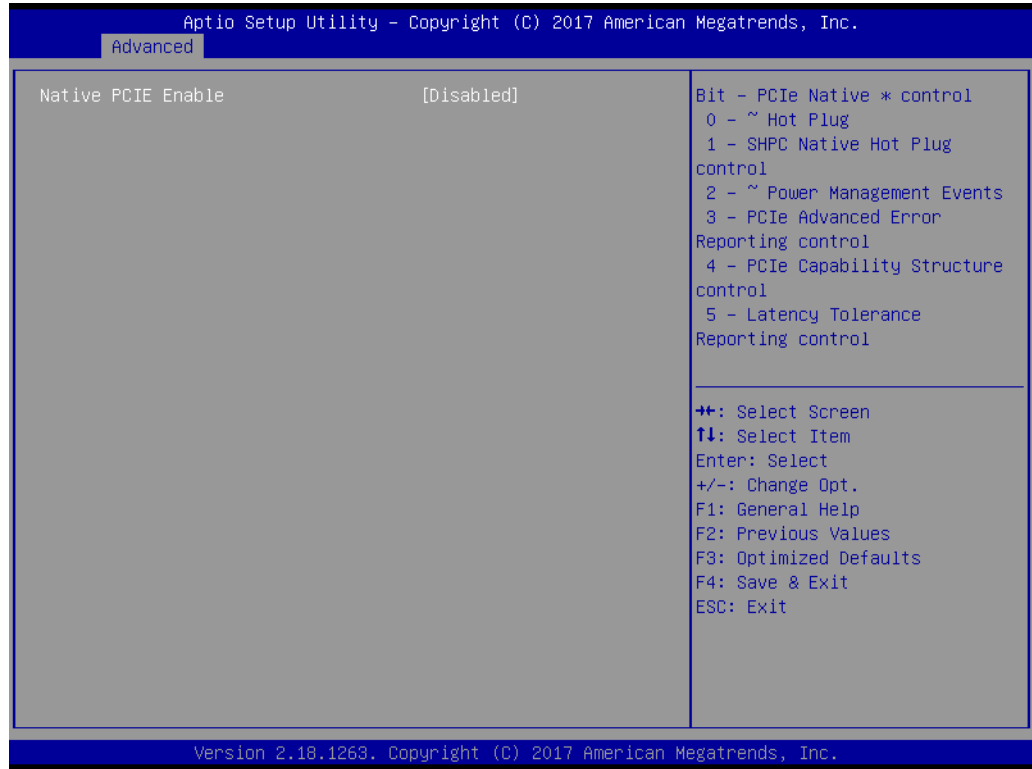

Figure 3.14 RC ACPI Settings

- **Native PCIE Enable**
Bit - PCIe Native * control
0 - ~ Hot Plug
1 - SHPC Native Hot Plug control
2 - ~ Power Management Events
3 - PCIe Advanced Error Reporting control
4 - PCIe Capability Structure control
5 - Latency Tolerance Reporting control.
- **Native ASPM**
On enable, Vista will control the ASPM support for the device. If disabled, the BIOS will.

3.2.3 Chipset Configuration

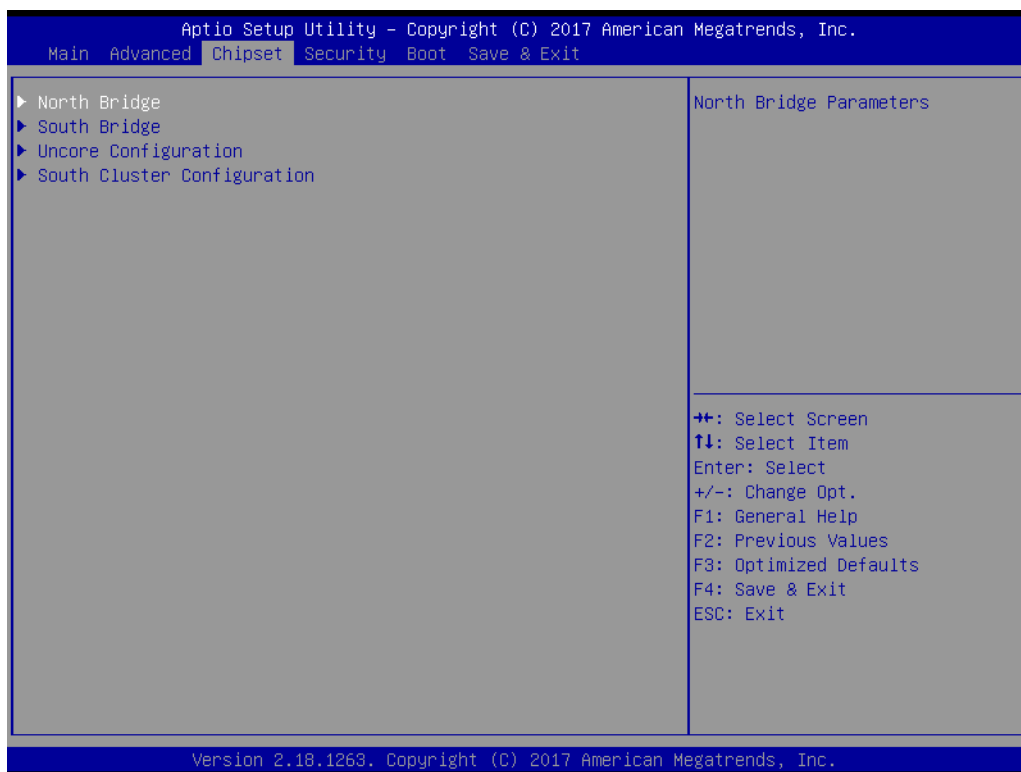

Figure 3.15 Chipset Configuration

- **North Bridge**
Details for North Bridge items.
- **South Bridge**
Details for South Bridge items.
- **Uncore Configuration**
Detail for Uncore items.
- **South Cluster Configuration**
Detail for South Cluster items

3.2.3.1 North Bridge

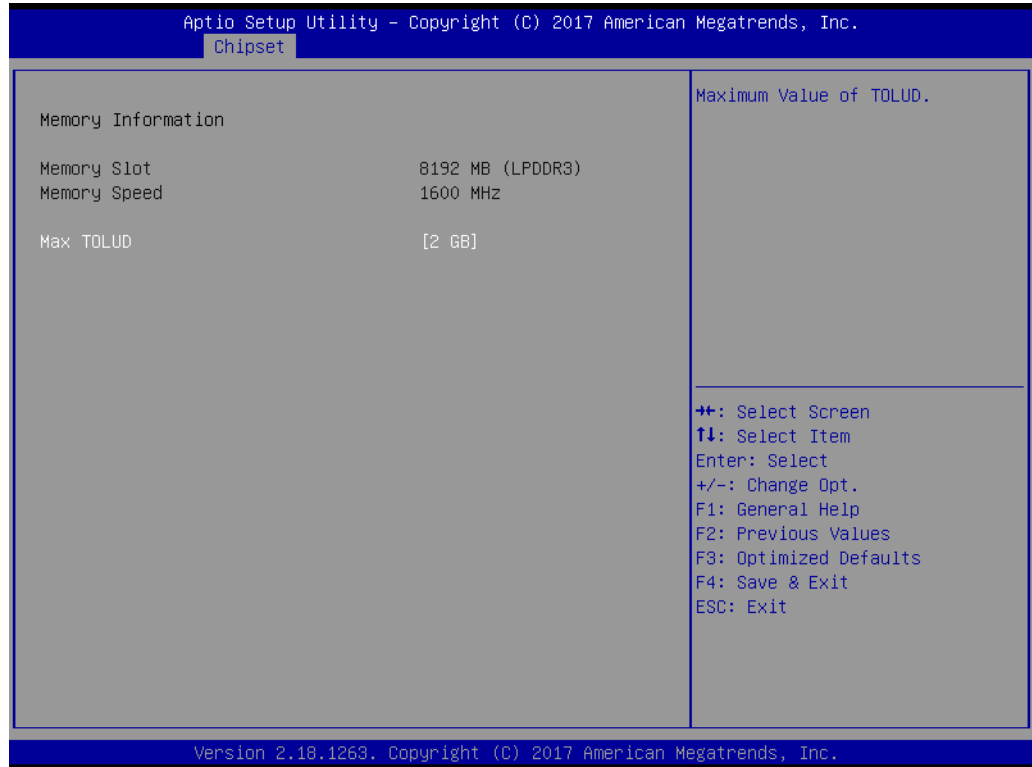

Figure 3.16 North Bridge Configuration

- **Max TOLUD**
Maximum value of TOLUD.

3.2.3.2 South Bridge

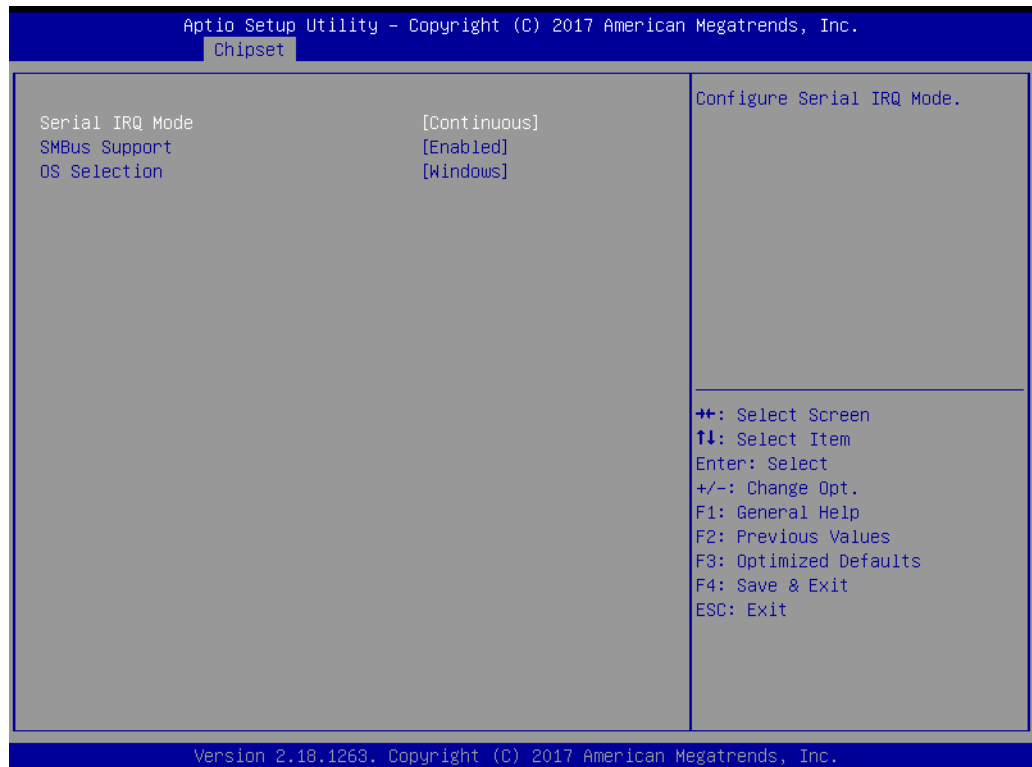

Figure 3.17 South Bridge Configuration

- **Serial IRQ Mode**
Configure Serial IRQ Mode.
- **SMBus Support**
Enable/Disable SMBus Support.
- **OS Selection**
Select the target OS.

3.2.3.3 Uncore Configuration

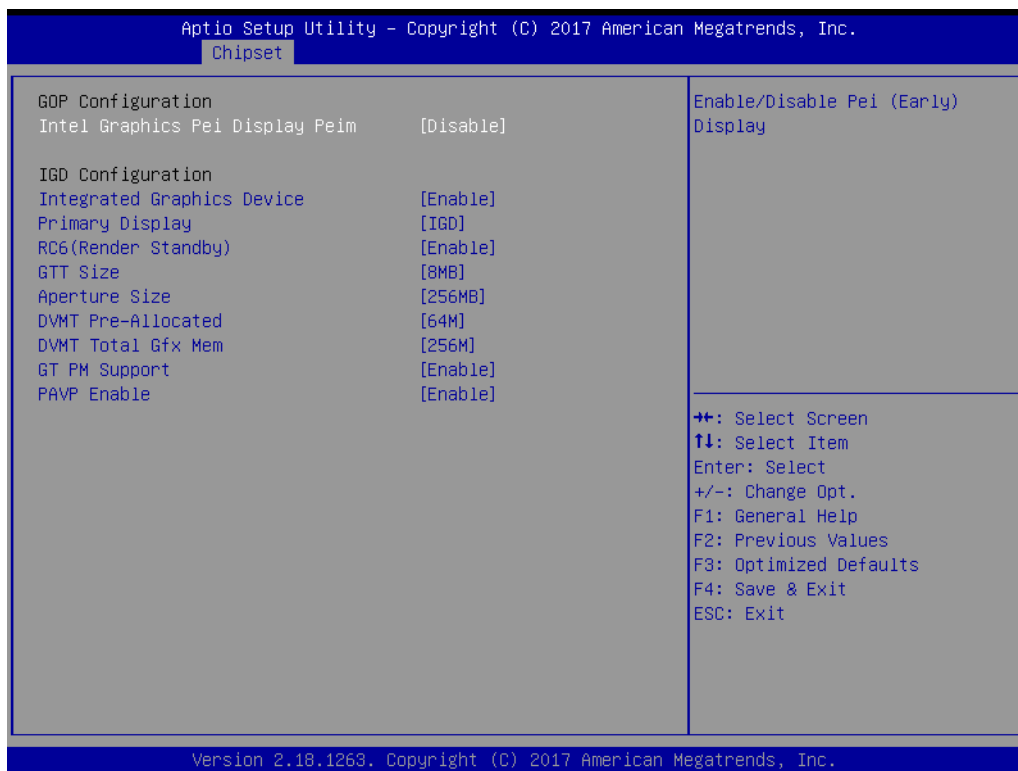

Figure 3.18 Uncore Configuration

- **Integrated Graphics Device**
Enable: Enable Integrated Graphics Device (IGD) when selected as the Primary Video Adaptor. Disable: Always disable IGD.
- **Primary Display**
Select which of IGD/PCI Graphics device should be Primary Display.
- **RC6(Render Standby)**
Check to enable render standby support.
- **GTT Size**
Select the GTT Size.
- **Aperture Size**
Select the Aperture Size.
- **DVMT Pre-Allocated**
Select DVMT 4.0 Pre-Allocated (UMA) Graphics Memory size used by the Internal Graphics Device.
- **DVMT Total Gfx Mem**
Select DVMT5.0 Total Graphic Memory size used by the Internal Graphics Device.
- **GT PM Support**

Enable/Disable GT PM Support.

- **PAVP Enable**

Enable/Disable PAVP.

3.2.3.4 South Cluster Configuration

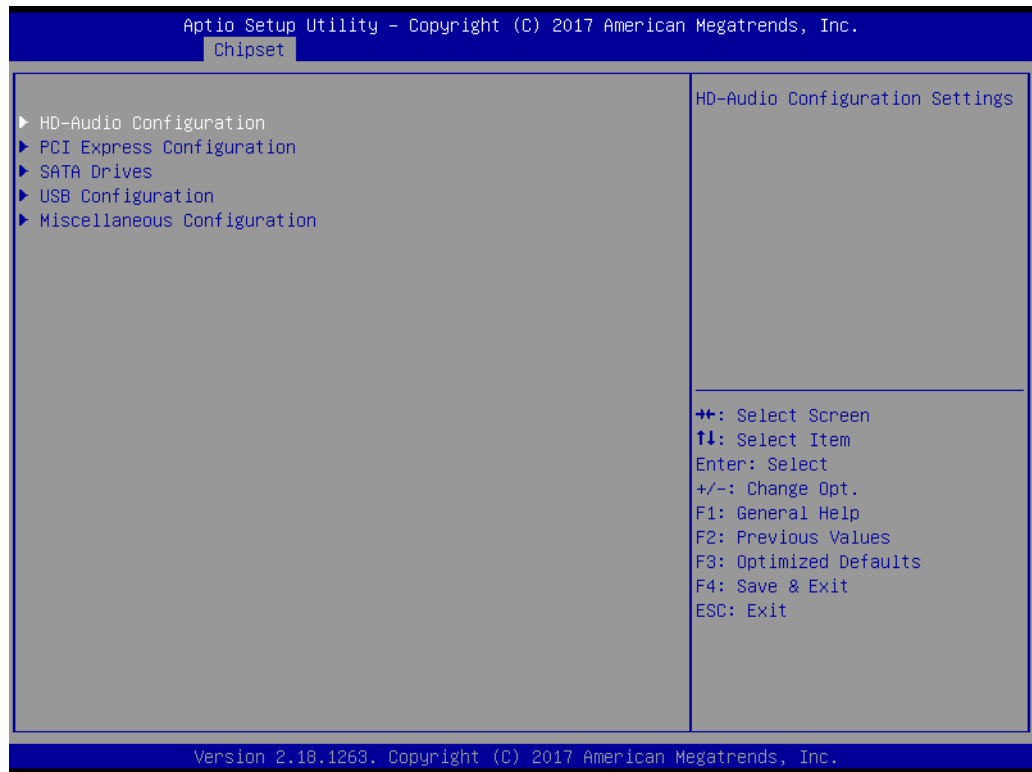

Figure 3.19 South Cluster Configuration

- **HD-Audio Configuration**

HD-Audio Configuration Settings.

- **PCI Express Configuration**

PCI Express Configuration Settings.

- **SATA Drives**

Press <Enter> to select the SATA Device Configuration Setup options.

- **USB Configuration**

USB Configuration Settings.

- **Miscellaneous Configuration**

Enable/Disable Misc. Features.

■ HD-Audio Configuration Settings

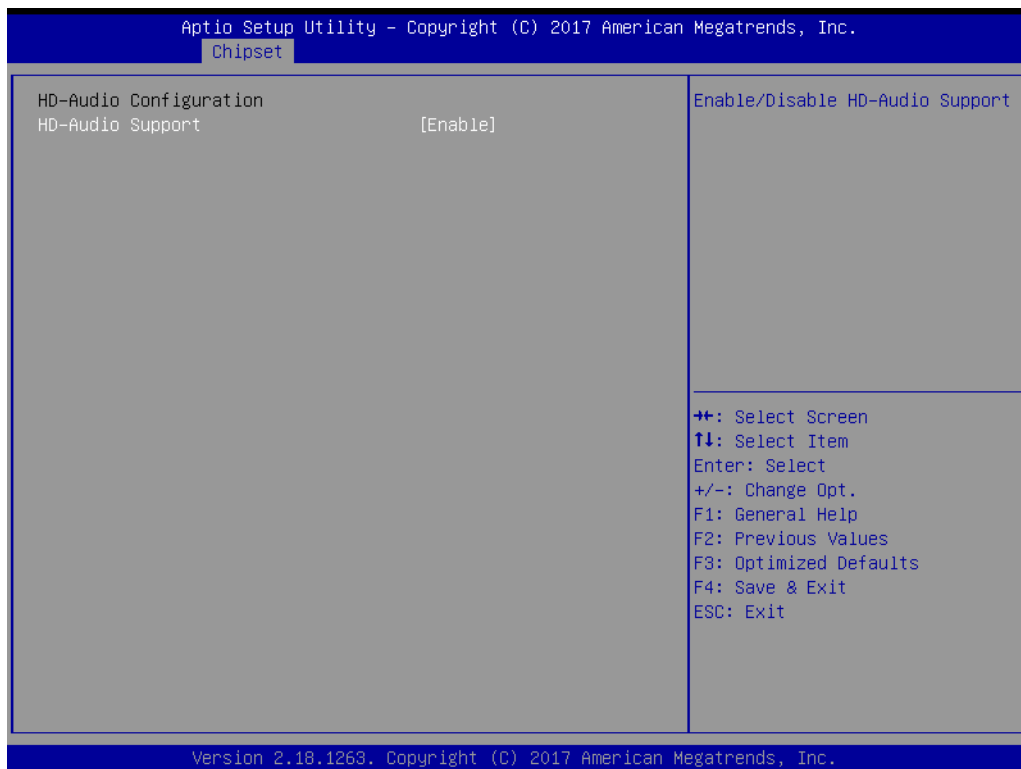

Figure 3.20 HD-Audio Configuration Settings

- **HD-Audio Support**
Enable/Disable HD-Audio Support.

■ PCI Express Configuration

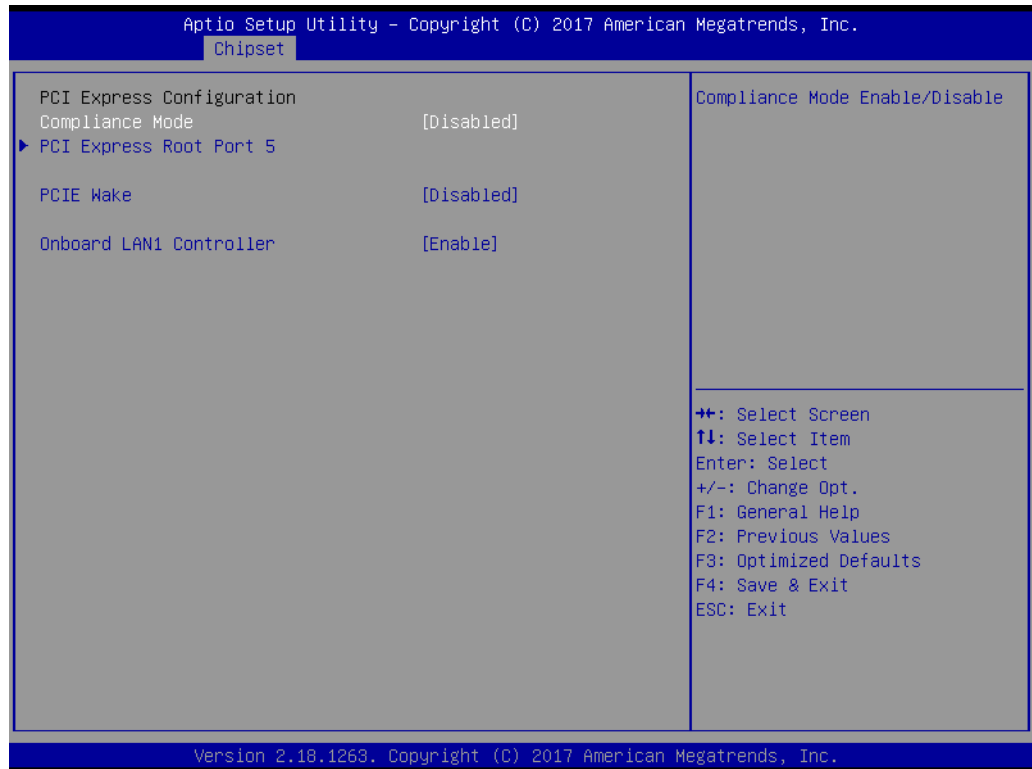

Figure 3.21 PCI Express Configuration (ARK-1124C)

- Compliance Mode
Compliance Mode Enable/Disable.
- PCI Express Wake
Enable or disable PCI Express to wake the system from S5.
- Onboard LAN1 Controller
Select to Enable or Disable Onboard LAN1 Controller

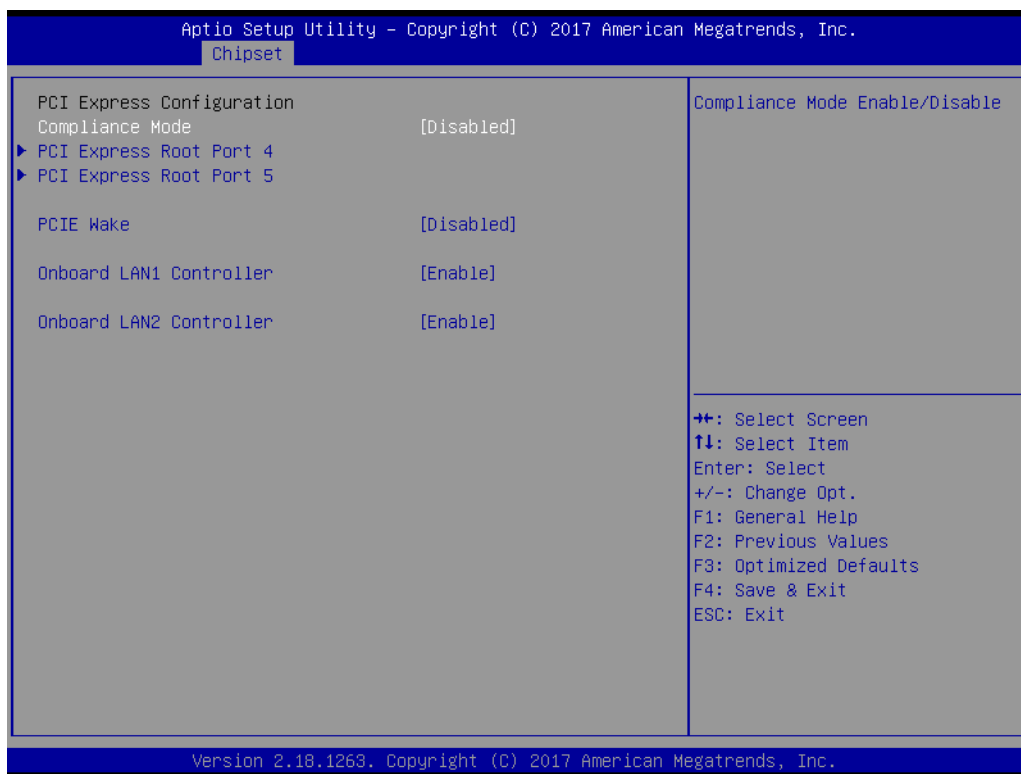

Figure 3.22 PCI Express Configuration (ARK-1124U/ARK-1124H)

- Compliance Mode
Compliance Mode Enable/Disable.
- PCIE Wake
Enable or disable PCIE to wake the system from S5.
- Onboard LAN1 Controller
Select to Enable or Disable Onboard LAN1 Controller
- Onboard LAN2 Controller
Select to Enable or Disable Onboard LAN2 Controller

■ PCI Express Configuration Settings



Figure 3.23 PCI Express Configuration Settings

- PCI Express Root Port 5
Control the PCI Express Root Port.
AUTO: To disable unused root port automatically for the most optimum power savings.
Enable: Enable PCIe root port.
Disable: Disable PCIe root port.
- ASPM
PCI Express Active State Power Management settings.
- PCIe Speed
Configure PCIe Speed.

■ SATA Drives

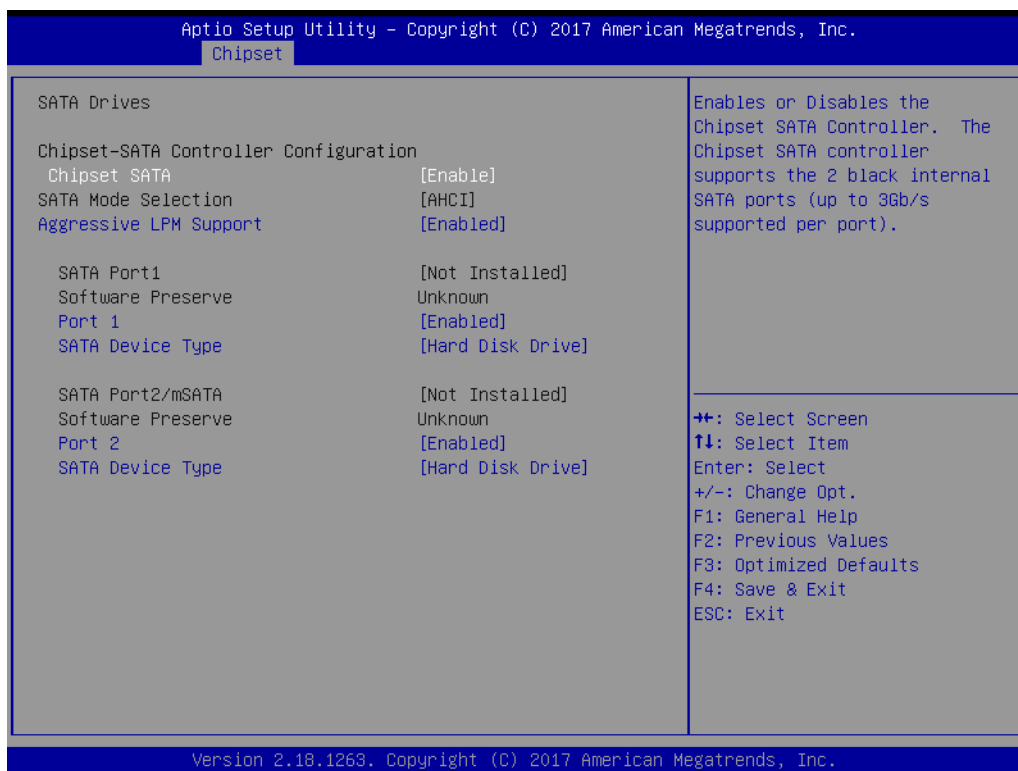

Figure 3.24 SATA Drives Settings

- Chipset SATA
Enables or Disables the Chipset SATA Controller. The Chipset SATA controller supports the 2 black internal SATA ports (up to 3Gb/s supported per port).
- Aggressive LPM Support
Enable PCH to aggressively enter link power state.
- Port 1
Enable or Disable SATA Port.
- SATA Device Type
Identify the SATA port is connected to Solid State Drive or Hard Disk Drive.

■ USB Configuration

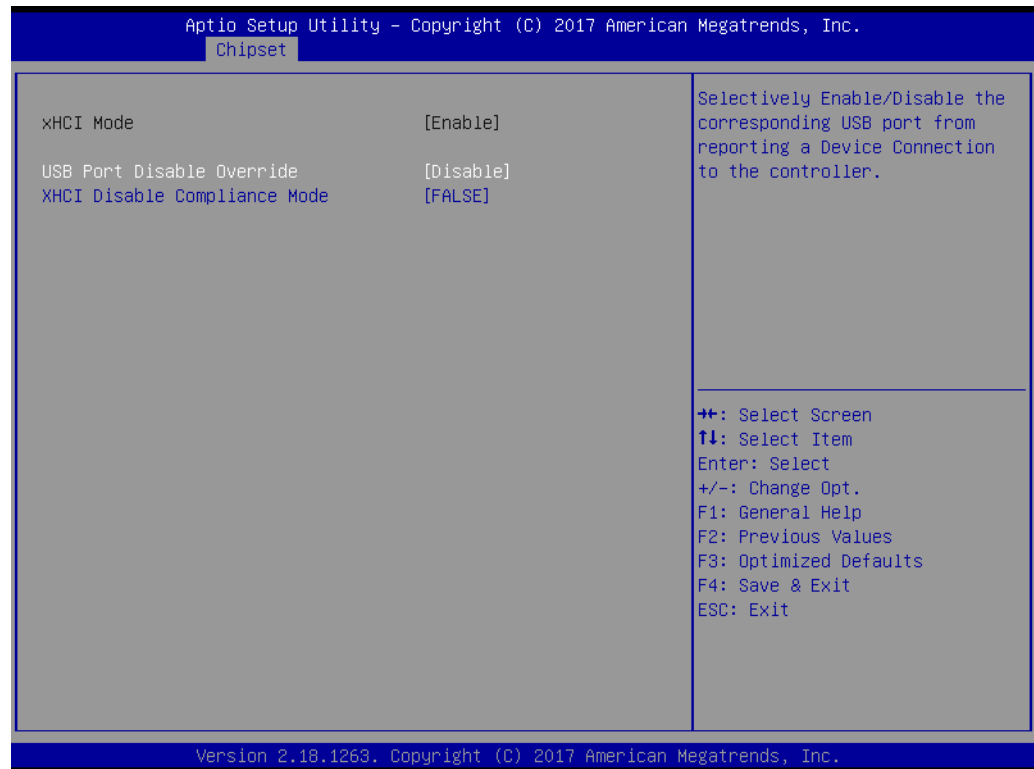

Figure 3.25 USB Configuration Settings

- xHCI Mode
Once disabled, XHCI controller would be function disabled, none of the USB devices are detectable and usable during boot and in OS. Do not disable it unless for debug purpose.
- USB Port Disable Override
Selectively Enable/Disable the corresponding USB port from reporting a Device Connection to the controller.
- XHCI Disable Compliance Mode
Options to disable XHCI Link Compliance Mode. Default is FALSE to not disable Compliance Mode. Set TRUE to disable Compliance Mode.

■ Miscellaneous Configuration

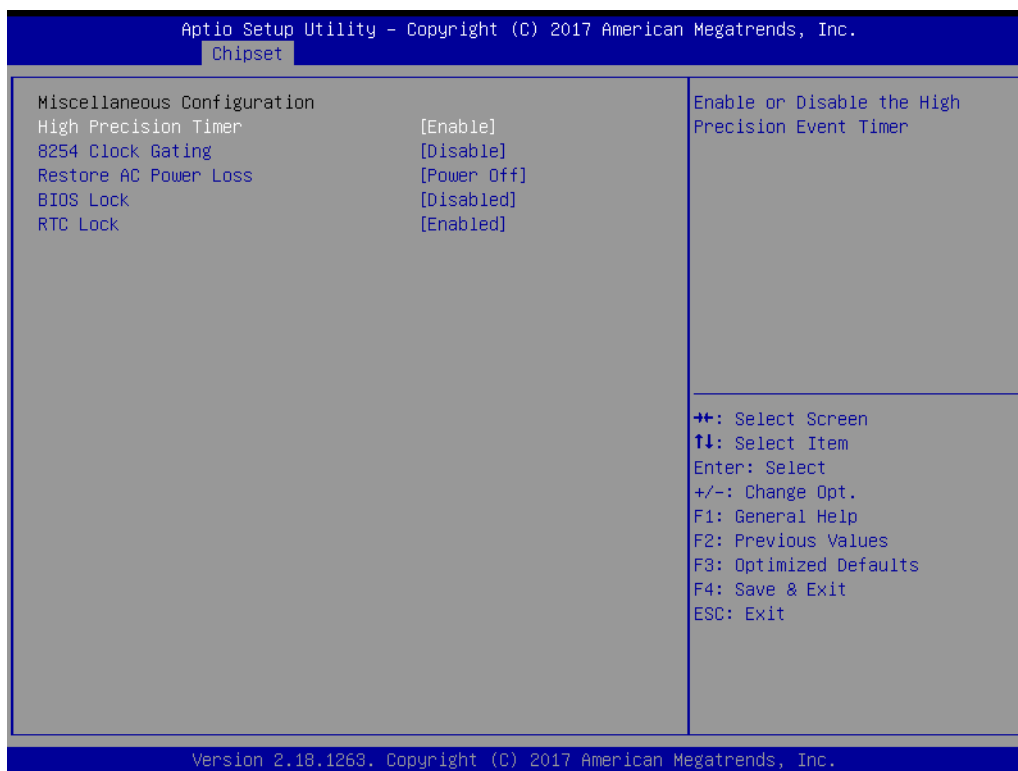

Figure 3.26 Miscellaneous Configuration Settings

- High Precision Timer
Enable or Disable the High Precision Event Timer.
- 8254 Clock Gating
Enable or Disable 8254 Clock Gating.
- Restore AC Power Loss
Specify what state to go to when power is re-applied after a power failure (G3 state).
Power On: System will boot directly as soon as power applied.
Power Off: System keeps in power-off state until power button is pressed.
Last State: System will act as like last power states.
- BIOS Lock
Enable/Disable the SC BIOS Lock Enable feature. Required to be enabled to ensure SMM protection of flash.
- RTC Lock
Enable will lock bytes 38h-3Fh in the lower/upper 128-byte bank of RTC RAM.

?

3.2.4 Security

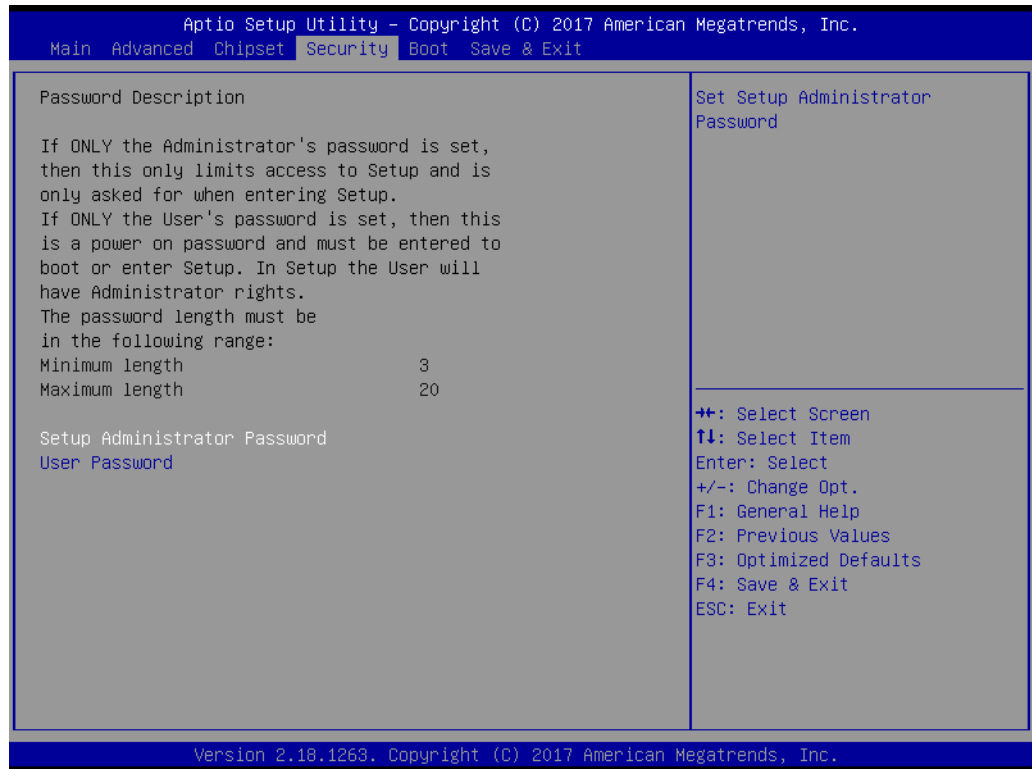
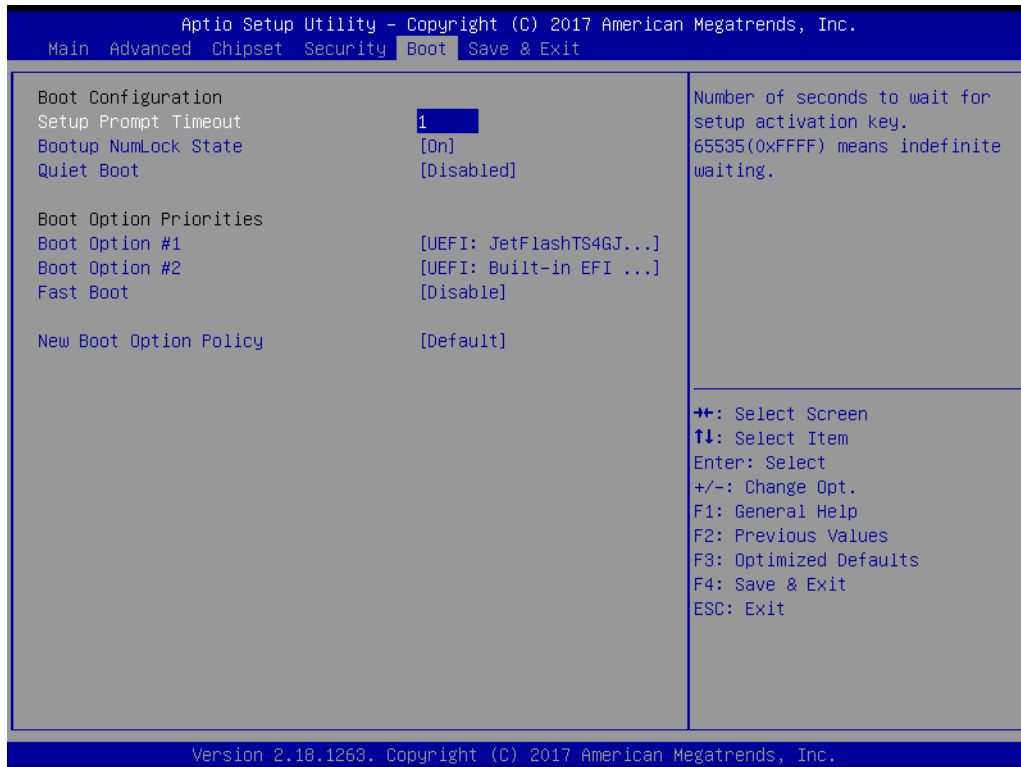

Figure 3.27 Security Settings

Select Security Setup from the ARK-1124 Setup main BIOS setup menu. All Security Setup options, such as password protection is described in this section. To access the sub menu for the following items, select the item and press <Enter>:

- **Change Administrator / User Password**
Select this option and press <ENTER> to access the sub menu, and then type in the password.

3.2.5 Boot



- **Setup Prompt Timeout**
Number of seconds to wait for setup activation key. 65535(0xFFFF) means indefinite waiting.
- **Bootup NumLock State**
Select the keyboard NumLock state.
- **Quiet Boot**
Enables or disables Quiet Boot option.
- **Boot Option #1**
Sets the system boot order.
- **Fast Boot**
Enable or Disable FastBoot features. Most probes are skipped to reduce time cost during boot.
- **New Boot Option Policy**
Controls the placement of newly detected UEFI boot options.

3.2.6 Save & Exit

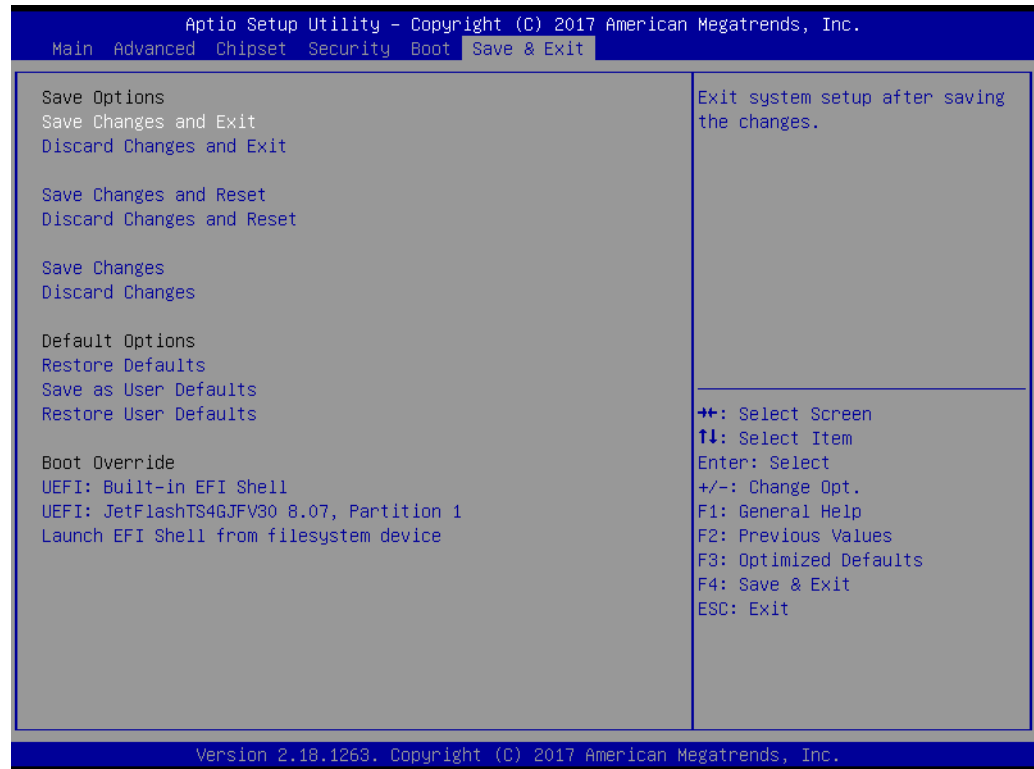

Figure 3.28 Save & Exit

- **Save Changes and Exit**
This item allows you to exit system setup after saving the changes.
- **Discard Changes and Exit**
This item allows you to exit system setup without saving any changes.
- **Save Changes and Reset**
This item allows you to reset the system after saving the changes.
- **Discard Changes and Reset**
This item allows you to rest system setup without saving any changes.
- **Save Changes**
This item allows you to save changes done so far to any of the options.
- **Discard Changes**
This item allows you to discard changes done so far to any of the options.
- **Restore Defaults**
This item allows you to restore/load default values for all the options.
- **Save as User Defaults**
This item allows you to save the changes done so far as user defaults.
- **Restore User Defaults**
This item allows you to restore the user defaults to all the options.
- **Boot Override**
Boot device select can override your boot priority.

Appendix **A**

Watchdog Timer
Sample Code

A.1 Watchdog Timer Sample Code

Watchdog function:

The SCH3114 Runtime base I/O address is A00h
Setting WatchDog time value location at offset 66h
If set value "0", it is mean disable WatchDog function.

Superio_GPIO_Port = A00h

```
mov dx,Superio_GPIO_Port + 66h
```

```
mov al,00h
```

```
out dx,al
```

```
.model small
```

```
.486p
```

```
.stack 256
```

```
.data
```

```
SCH3114_IO EQU A00h
```

```
.code
```

```
org 100h
```

```
.STARTup
```

```
=====
```

```
;47H
```

```
;enable WDT function bit [0]=0Ch
```

```
=====
```

```
mov dx,SCH3114_IO + 47h
```

```
mov al,0Ch
```

```
out dx,al
```

```
=====
```

```
;65H
```

```
;bit [1:0]=Reserved
```

```
;bit [6:2]Reserve=00000
```

```
;bit [7] WDT time-out Value Units Select
```

```
;Minutes=0 (default) Seconds=1
```

```
=====
```

```
mov dx,SCH3114_IO + 65h;
```

```
mov al,080h
```

```
out dx,al
```

```
=====
```

```
;66H
```

```
;WDT timer time-out value
```

```
;bit[7:0]=0~255
```

```
=====
```

```
mov dx,SCH3114_IO + 66h
```

```
mov al,01h
```

```
out dx,al
```

```
=====
```

```
;bit[0] status bit R/W
```

```
;WD timeout occurred =1;WD timer counting = 0
```

```
=====
```

```
mov dx,SCH3114_IO + 68h
```



```
mov al,01h  
out dx,al  
.exit  
END
```

Appendix **B**

SUSI API Introduction

B.1 SUSI API Introduction

To make hardware easier and more convenient to access for programmers, Advantech has released a suite of API (Application Programming Interface) in the form of a program library. The program Library is called Secured and Unified Smart Interface or SUSI for short.

SUSI provides a uniform API for application programmers to access the hardware functions in different Operating Systems and on different Advantech hardware platforms.

Application programmers can invoke the functions exported by SUSI instead of calling the drivers directly. The benefit of using SUSI is portability. The same set of APIs is defined for different Advantech hardware platforms. Also, the same API set is implemented in different Operating Systems. This user's manual describes some sample programs and the API in SUSI. The hardware functions currently supported by SUSI can be grouped into a few categories including Watchdog and Hardware Monitor. Each category of API in SUSI is briefly described below.

B.1.1 The Watchdog API

A watchdog timer (abbreviated as WDT) is a hardware device which triggers an action, e.g. rebooting the system, if the system does not reset the timer within a specific period of time. The WDT API in SUSI provides developers with functions such as starting the timer, resetting the timer, and setting the timeout value if the hardware requires customized timeout values.

B.1.2 The Hardware Monitor API

The hardware monitor (abbreviated as HWM) is a system health supervision capability achieved by placing certain I/O chips along with sensors for inspecting the target of interests for certain condition indexes, such as temperature and voltage etc.

However, due to the inaccuracy among many commercially available hardware monitoring chips, Advantech has developed a unique scheme for hardware monitoring - achieved by using a dedicated micro-processor with algorithms specifically designed for providing accurate, real-time and reliable data content; helping protect your system in a more reliable manner.

ADVANTECH

Enabling an Intelligent Planet

www.advantech.com

Please verify specifications before quoting. This guide is intended for reference purposes only.

All product specifications are subject to change without notice.

No part of this publication may be reproduced in any form or by any means, electronic, photocopying, recording or otherwise, without prior written permission of the publisher.

All brand and product names are trademarks or registered trademarks of their respective companies.

© Advantech Co., Ltd. 2017