

Register your product and get support at
www.philips.com/welcome

User Manual

PHILIPS

Contents

1 My new TV 4

- 1.1 Ultra HD TV 4
- 1.2 Smart TV 4
- 1.3 App gallery 4
- 1.4 Rental videos 4
- 1.5 Social networks 4
- 1.6 Ambilight+hue 5
- 1.7 Skype 5
- 1.8 Smartphones and tablets 5
- 1.9 Pause TV and recordings 5
- 1.10 Gaming 5
- 1.11 EasyLink 6

2 Setting up 7

- 2.1 Read safety 7
- 2.2 TV stand and wall mounting 7
- 2.3 Tips on placement 7
- 2.4 Power cable 7
- 2.5 Antenna cable 8
- 2.6 Satellite dish 8

3 Network 9

- 3.1 Wireless network 9
- 3.2 Wired network 10
- 3.3 Network settings 10

4 Connections 12

- 4.1 Tips on connections 12
- 4.2 EasyLink HDMI CEC 13
- 4.3 Common interface - CAM 14
- 4.4 Set-top box - STB 15
- 4.5 Satellite receiver 15
- 4.6 Home Theatre System - HTS 16
- 4.7 Blu-ray Disc player 17
- 4.8 DVD player 17
- 4.9 Game console 17
- 4.10 USB Hard Drive 18
- 4.11 USB keyboard or mouse 19
- 4.12 USB flash drive 20
- 4.13 Photo camera 20
- 4.14 Camcorder 20
- 4.15 Computer 21
- 4.16 Headphones 21
- 4.17 Wireless speakers (For 7500 series TV) 22

5 Switch on 23

- 5.1 On or Standby 23
- 5.2 Keys on TV 23
- 5.3 Word mark brightness 23

6 Remote control 24

- 6.1 Key overview for 7100, 7500 series 24
- 6.2 Key overview for 6300, 6500, 6600, 6700 series 25
- 6.3 Keyboard 26
- 6.4 Pointer (For 7500 series TV) 27
- 6.5 IR sensor for RF remote control 28
- 6.6 IR sensor for non-RF remote control 28
- 6.7 Pairing with TV 28
- 6.8 Batteries 29

- 6.9 Cleaning 29

7 TV channels 30

- 7.1 Watching TV channels 30
- 7.2 Channel installation 35

8 Satellite channels 39

- 8.1 Satellite channels 39
- 8.2 Watching satellite channels 39
- 8.3 Satellite channel list 39
- 8.4 Favourite satellite channels 39
- 8.5 Lock satellite channels 40
- 8.6 Satellite installation 41
- 8.7 Problems with satellites 45

9 Home menu 46

10 TV guide 47

- 10.1 What you need 47
- 10.2 Using the TV guide 47
- 10.3 Recordings 47

11 Sources 48

- 11.1 Sources list 48
- 11.2 From standby 48
- 11.3 EasyLink 48

12 Timers and clock 49

- 12.1 Sleptimer 49
- 12.2 Clock 49
- 12.3 Switch off timer 49

13 3D 50

- 13.1 3D 50
- 13.2 What you need 50
- 13.3 The 3D glasses 50
- 13.4 Care of the 3D glasses 51
- 13.5 Watch 3D 51
- 13.6 Optimal 3D viewing 51
- 13.7 Health warning 52

14 Games 53

- 14.1 Play a game 53
- 14.2 Two-player games 53

15 Your photos, videos and music 55

- 15.1 From a USB connection or network computer 55
- 15.2 Wi-Fi Miracast 56

16 Pause TV 58

17 Recording 59

- 17.1 What you need 59
- 17.2 Record a programme 59
- 17.3 Watch a recording 59

18 Skype 61

- 18.1 About Skype 61
- 18.2 What you need 61
- 18.3 Start with Skype 61
- 18.4 Skype menu 62

- 18.5 My profile 62
- 18.6 People 63
- 18.7 Calling on Skype 64
- 18.8 Skype credit 65
- 18.9 Skype settings 65
- 18.10 Sign out 67
- 18.11 Quit Skype 67
- 18.12 Terms of use & Privacy Policy 67

19 Smart TV 68

- 19.1 About Smart TV 68
- 19.2 What you need 68
- 19.3 Setup Smart TV 68
- 19.4 Smart TV Apps 68
- 19.5 Reset Smart TV 70

20 Multi room 71

- 20.1 About Multi room 71
- 20.2 What you need 71
- 20.3 Using Multi room 71

21 Share this... 73

22 MyRemote App 74

- 22.1 About MyRemote App 74
- 22.2 What you need 74
- 22.3 App download 75
- 22.4 App menu 75
- 22.5 App functions 75

23 Settings 78

- 23.1 Setup menu 78
- 23.2 Picture 79
- 23.3 Sound 83
- 23.4 Ambilight 86
- 23.5 Universal access 88

24 Specifications 91

- 24.1 Environmental 91
- 24.2 Reception for non-satellite TVs 92
- 24.3 Reception for satellite TVs 92
- 24.4 Display 92
- 24.5 Power 93
- 24.6 Dimensions and weights (7500 series) 93
- 24.7 Dimensions and weights (7100 series) 93
- 24.8 Dimensions and weights (6600/6700 series) 94
- 24.9 Dimensions and weights (6500 series) 94
- 24.10 Connectivity for three side connector 94
- 24.11 Connectivity for two side connector 95
- 24.12 Multimedia 95

25 Software 96

- 25.1 Software update 96
- 25.2 Software version 96
- 25.3 Open source software 96
- 25.4 Open source license 96

26 Troubleshooting and support 102

- 26.1 Troubleshooting 102
- 26.2 Register 103
- 26.3 Help 103
- 26.4 Online help 103
- 26.5 Consumer Care / Repair 104

27 Safety and care 105

- 27.1 Safety 105

- 27.2 Screen care 106

28 Terms of use, copyrights and licenses 107

- 28.1 Terms of use 107
- 28.2 Copyrights and licenses 107

Index 110

My new TV

Ultra HD TV

This TV has an **Ultra HD** display. Its resolution is four times as much as normal HD displays. Ultra HD means 8 million pixels for the most refined and lifelike picture on TV.

On top, the new **Ultra Pixel HD Engine** continuously converts any incoming TV signal into Ultra HD resolution. So you can enjoy this stunning picture quality the moment you switch on the TV. Or you can watch native Ultra HD videos through the HDMI 4 connection. Ultra HD offers TV viewing that is crisp and sharp even on a big screen.

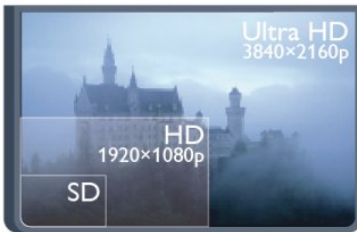

- Only for TVs that have an Ultra HD display.

Smart TV

Connect this **Philips Smart LED TV** to the Internet and discover a new world of television. You can make a wired connection to your router or you can link up wirelessly with Wi-Fi.

With the TV connected to your home network, a smartphone can show a photo on TV, you can play videos stored on your computer or control the TV with your tablet.

With your TV connected to the Internet, you can watch a rental video from an online video store, read the online TV guide or record your favourite TV show on a USB Hard Drive.

The Smart TV Apps add to the fun with all sorts of entertainment and convenient services.

In **Help**, press **Keywords** and look up **Smart TV** for more information.

App gallery

Open the **App gallery** in Smart TV to browse the Apps, the collection of tailored websites for TV.

Find the App for YouTube videos, a national newspaper, an online photo album, Facebook, Twitter, etc.

There are Apps to rent a video from an online video store and Apps for watching programmes you missed.

If the App gallery does not hold what you are looking for, try the World Wide Web and surf the Internet on TV.

In **Help**, press **Keywords** and look up **App gallery** for more information.

Rental videos

To watch a **rental video**, you don't need to leave your home. Simply rent the latest movie from your regional online video store.

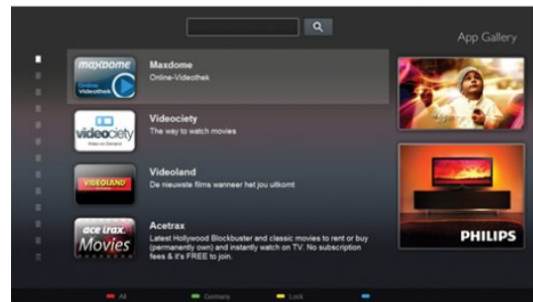

Start Smart TV and add the video store App to the Smart TV start page.

Open the video store App, create your personal account, select the movie and press play.

No fuss with downloading, you can watch the movie immediately*.

In **Help**, press **Keywords** and look up **Rental videos** for more information.

* Depending on the video streaming service of the selected video store.

Social networks

No need to get up to check your friend's messages on your computer.

Open Smart TV, select your **social network** page and send a message back from your couch.



Smart TV supports the popular social networks Facebook and

Twitter.

In **Help**, press **Keywords** and look up **App gallery** for more information.

1.6

Ambilight+hue

With **Ambilight+hue**, you can set up your **Philips hue** lamps to follow the Ambilight colours of the TV.

The Philips hue lamps will expand the Ambilight effect across the room. If you don't have any Philips hue lamps yet, buy the **Philips hue Starter Kit** (includes a hue bridge and 3 hue bulbs) and install the bulbs and bridge. You can buy extra Philips hue bulbs separately.



- Only for TVs with Ambilight.

1.7

Skype

With **Skype™** you can make video calls on your TV for free.

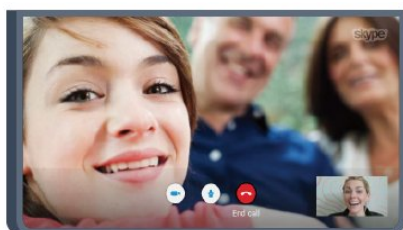

You can call and see your friends from anywhere in the world. To make a video call, you need a camera with a built-in microphone and a good connection to the Internet. Some Philips TVs have a camera and microphone built in.

In **Help**, press **Keywords** and look up **Skype** for more information.

1.8

Smartphones and tablets

To use your smartphone or tablet as a TV remote control or as your media controller, download the **Philips MyRemote** app from your smartphone or tablet app store.



Operate your TV from your smartphone or tablet, switch channels or change the volume. With the MyRemote app, you can use your phone or tablet to send photos, music or videos from your computer to your TV. And with MyRemote app on a tablet, you can call up the TV guide, read about the programmes and switch the TV to a channel with a simple tap of your finger. The MyRemote app is available for iOS and Android.

In **Help**, press **Keywords** and look up **MyRemote app** for more information.

1.9

Pause TV and recordings

If you connect a **USB Hard Drive**, you can pause and record a broadcast from a digital TV channel.



Pause your TV and answer that urgent phone call or simply take a break during a sports match, while the TV stores the broadcast on the USB Hard Drive. You can start watching again later. With a USB Hard Drive connected, you can also record digital broadcasts. You can record while you are watching a programme or schedule a recording of an upcoming programme.

In **Help**, press **Keywords** and look up **Pause TV** or **Recording** for more information.

Gaming

If you select your game console in the Home menu, the TV switches to the settings ideal for gaming automatically.

If you play a multi-player game with split screens, you can set the TV to show each screen as a full screen simultaneously.

Each player can focus on his own game to play.



The TV uses 3D technology to show both screens. To play a two-player game with two different full screen pictures, you need a pair of 3D glasses for each player.

In **Help**, press **— Keywords** and look up **Game console or Two player games** for more information.

EasyLink

With **EasyLink** you can operate a connected device, like a Bluray Disc player, with the remote control of the TV.

EasyLink uses HDMI CEC to communicate with the connected devices.

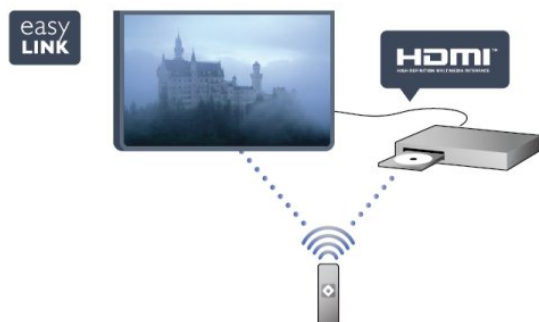

In **Help**, press **— Keywords** and look up **EasyLink** for more information.

Setting up

2.1

Read safety

Read the safety instructions first before you use the TV.

In Help, go to **Safety and care** > **Safety**.

2.2

TV stand and wall mounting

TV stand

You can find the instructions for mounting the TV stand in the Quick Start Guide that came with the TV. In case you lost this guide, you can download it from www.philips.com.

Use the product type number of the TV to look for the Quick Start Guide to download.

Wall mounting

Your TV is also prepared for a VESA-compliant wall mount bracket (sold separately).

Use the following VESA code when purchasing the wall mount .

..

To fix the bracket securely, use screws with a length indicated in the drawing.

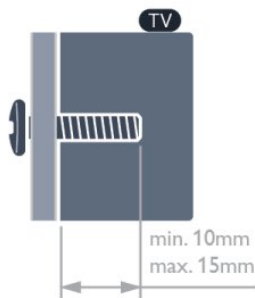

- For 7500 series 42-inch/47-inch/55-inch/65-inch TV
VESA MIS-F 400x400, M6
- For 7179/7189/7199 series 42-inch/47-inch/55-inch/65-inch TV
VESA MIS-F 400x400, M6
- For 7100 series 42-inch/47-inch TV
VESA MIS-F 300x300, M6
- For 7100 series 55-inch TV
VESA MIS-F 400x400, M6
- For 6800 series 58-inch TV
VESA MIS-F 400x400, M6

- For 6800 series 50-inch TV
VESA MIS-F 400x200, M6
- For 6800 series 40-inch TV
VESA MIS-F 200x100, M6
- For 6700 series 40-inch/48-inch TV
VESA MIS-F 400x200, M6
- For 6600 series 55-inch/65-inch TV
VESA MIS-F 400x400, M6
- For 6600 series 40-inch/48-inch TV
VESA MIS-F 400x200, M6
- For 6500 series 55-inch TV
VESA MIS-F 400x400, M6
- For 6500 series 32-inch/42-inch/47-inch TV
VESA MIS-F 400x200, M6
- For 6400 series 55-inch TV
VESA MIS-F 400x400, M6
- For 6400 series 40-inch/48-inch TV
VESA MIS-F 400x200, M6

Caution

Wall mounting the TV requires special skills and should only be performed by qualified personnel. The TV wall mounting should meet safety standards according to the TV's weight. Also read the safety precautions before positioning the TV.

TP Vision Europe B.V. bears no responsibility for improper mounting or any mounting that results in accident or injury.

2.3

Tips on placement

- Position the TV where light does not shine directly on the screen.
- Dim lighting conditions in the room for best Ambilight effect.*
- Position the TV up to 15 cm away from the wall.
- The ideal distance to watch TV is 3 times its diagonal screen size. When seated, your eyes should be level with the centre of the screen.



* Ambilight function is only for TVs with Ambilight.

2.4

Power cable

- Insert the power cable into the **POWER** connector on the back of the TV.
- Make sure the power cable is securely inserted in the connector.

- Make sure that the power plug, in the wall socket, is accessible at all times.
- When you unplug the power cable, always pull the plug, never pull the cable.

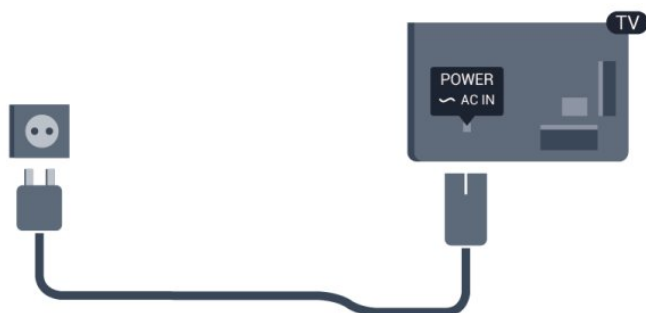

Although this TV has a very low standby power consumption, unplug the power cable to save energy if you do not use the TV for a long period of time.

In **Help**, press **Keywords** and look up **Switching on** for more information on switching the TV on or off.

2.5

Antenna cable

Insert the antenna plug firmly into the **ANTENNA** socket at the back of the TV.

You can connect your own antenna or an antenna signal from an antenna distribution system. Use an IEC Coax 75 Ohm RF antenna connector.

Use this antenna connection for DVB-T and DVB-C input signals.



2.6

Satellite dish

Attach the satellite F-type connector to the satellite connection **SAT** at the back of the TV.

- Only for TVs with a built-in satellite tuner.

Network

3.1

Wireless network

What you need

To connect the TV wirelessly to the Internet, you need a wireless router. Use a high-speed (broadband) connection to the Internet.



Network devices

The TV can connect to other devices in your wireless network, like your computer or smartphone. You can use a computer with Microsoft Windows or Apple OS X.

File sharing

On this TV, you can open photos, music and videos stored on your computer. Use a recent version of media server software like Philips MediaManager*, Windows Media Player 11, Twonky™ or similar.

Install the media server software on your computer and set it up to share your media files with the TV. Read the manual of the media server software for more information. This software must be running on your computer to view or play your files on TV.

* You can download the Philips MediaManager software from the Philips support site www.philips.com/support

Make the connection

Follow steps 1 to 5.

Step 1 - Make sure that the router of your wireless network is switched on.

Step 2 - Press **Home** and select **Setup** and press **OK**.

Step 3 - Select **Connect to network** and press **OK**.

Step 4 - Select **Connect** and press **OK**.

Step 5 - Select **Wireless** and press **OK**.

Step 6 - Select **Scan** to scan for your wireless network. If you have a router with WPS (Wi-Fi Protected Setup), you can select **WPS**. Select your choice and press **OK**.

- **Scan**

Select **Scan** to scan for your wireless network (your wireless router). The TV might find several wireless networks in your proximity.

- **WPS**

If your router has WPS, you can directly connect to the router without scanning. Go to the router, press the WPS button and return to the TV within 2 minutes. Then press **Connect** to make the connection.

If you have devices in your wireless network that use the WEP security encryption system, you cannot use WPS.

If you must use the **WPS PIN code** to connect, select **Scan** instead of WPS.

Step 7 - In the list of networks found, select your wireless network and press **OK**.

If your network is not in the list because the network name is hidden (you switched off the SSID broadcast of the router), select **Manual entry** to enter the network name yourself.

Step 8 - Depending on the type of router, you can now enter your encryption key (WEP, WPA or WPA2). If you entered the encryption key for this network before, you can select **Next** to make the connection immediately.

If your router supports WPS or WPS PIN, you select **WPS**, **WPS PIN** or **Standard**. Select your choice and press **OK**.

- **Standard**

Select **Standard** to enter the encryption key (password, passphrase or security key) manually. You can use the keyboard on the RC to enter the encryption key. Once you have entered the key, press **Connect**.

- **WPS PIN**

To make a secured WPS connection with a PIN code, select **WPS PIN** and press **OK**. Write down the 8-digit PIN code shown and enter it in the router software on your PC. Return to the TV and press **Connect**. Consult the router manual on where to enter the PIN code in the router software.

Step 9 - A message will be shown when the connection is successful.

Network configuration

If the connection fails, you can check the DHCP setting of the router. DHCP should be set to **On**.

Alternatively, if you are an advanced user and want to install your network with Static IP addressing, set the TV to Static IP. To set the TV to Static IP, press **Home** and select **Setup** and press **OK**. Select **Network settings** > **Network settings** > **Network configuration** > **Static IP**. With Static IP selected in the menu, you can set the IP address and other necessary settings in **Static IP configuration** in the same menu.

Network problems

Wireless network not found or distorted

- Microwave ovens, DECT phones or other Wi-Fi 802.11b/g/n devices in your proximity might disturb the wireless network.
- Make sure that the firewalls in your network allow access to the TV's wireless connection.
- If the wireless network does not work properly in your home, try the wired network installation.

Internet does not work

- If the connection to the router is OK, check the router connection to the Internet.

The PC and Internet connection are slow

- Look in your wireless router's user manual for information on indoor range, transfer rate and other factors of signal quality.
- Use a high-speed (broadband) Internet connection for your router.

3.2

Wired network

What you need

You need a network **router** to connect the TV to the Internet. Use a router with a high-speed (broadband) connection to the Internet.

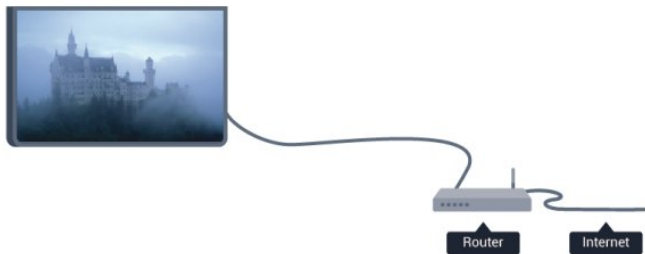

File sharing

On this TV, you can open photos, music and videos stored on your computer. Use a recent version of media server software like Philips MediaManager*, Windows Media Player 11, Twonky™ or similar.

Install the media server software on your computer and set it up to share your media files with the TV. Read the manual of the media server software for more information. This software must be running on your computer to view or play your files on TV.

* You can download the Philips MediaManager software from the Philips support site www.philips.com/support

In **Help**, press **— Keywords** and look up **Media server software, supported** for an overview of supported media server software.

Connect the router

To connect and setup the router follow steps **1** to **5**.

- 1 - Connect the router to the TV with a network cable (Ethernet cable**).
- 2 - Make sure that the router is switched on.
- 3 - Press **▲** and select **Setup** and press **OK**.
- 4 - Select **Connect to network** and press **OK**.
- 5 - Select **Wired** and press **OK**.

The TV constantly searches for the network connection. A message will be shown when the connection is successful.

Network configuration

If the connection fails, you can check the DHCP setting of the router. DHCP should be set to **On**.

Alternatively, if you are an advanced user and want to install your network with static IP addressing, set the TV to Static IP. To set the TV to Static IP, press **▲** and select **Setup** and press **OK**.

Select **Network settings > Network settings > Network configuration > Static IP**. With Static IP selected in the menu, you can set the IP address and other necessary settings in **Static IP configuration** in the same menu.

**To fulfill EMC regulations, use a shielded FTP Cat. 5E Ethernet cable.

3.3

Network settings

To open the Network settings . . .

- 1 - Press **▲** and select **Setup** and press **OK**.
- 2 - Select **Network settings** and press **OK**.

• View network settings

All current network settings are shown here. The IP and MAC address, signal strength, speed, encryption method, etc.

• Network settings

- Network type

Sets the network to Wired or Wireless.

- Network configuration

Sets the network configuration to DHCP or Static IP.

• Wi-Fi media playback

To receive multimedia files from smartphones or tablets, set the DMR to On.

• Static IP configuration

If Static IP is selected in Network Settings menu, you can set all necessary static IP settings here.

• Wi-Fi Miracast

For more information on Wi-Fi Miracast, press **— Keywords** and look up **Wi-Fi Miracast™**.

- **Reset Wi-Fi direct group**

Clear the list of connected and blocked devices that are used with Miracast.

- **Wi-Fi smart screen**

For more information on Wi-Fi smart screen, press **— Keywords** and look up **MyRemote App, Wi-Fi smart screen**.

- **MyRemote recording**

Manage TV recordings remotely with a smartphone or tablet.

- **TV network name**

If you have more than one TV in your network, you can rename the TVs here.

- **Netflix Settings**

Adjust Netflix settings.

- **Clear Internet memory**

With Clear Internet memory, you can clear all Internet files stored on your TV. You clear your Philips Smart TV registration and parental rating settings, your video store app logins, all Smart TV app favourites, Internet bookmarks and history. Interactive MHEG applications can also save so-called 'cookies', on your TV. These files will also be cleared.

Connections

4.1

Tips on connections

Connectivity guide

Always connect a device to the TV with the highest quality connection available. Also, use good quality cables to ensure a good transfer of picture and sound.

If you need help to connect several devices to the TV, you can visit the Philips TV connectivity guide. The guide offers information on how to connect and which cables to use.

Go to www.connectivityguide.philips.com

Antenna

If you have a Set-top box (a digital receiver) or Recorder, connect the antenna cables to run the antenna signal through the Set-top box and/or Recorder first before it enters the TV. In this way, the antenna and the Set-top box can send possible additional channels to the Recorder to record.

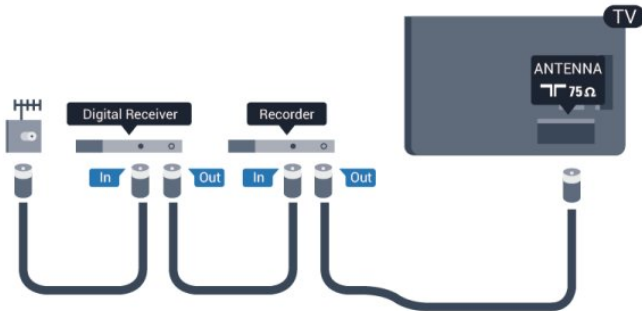

HDMI

HDMI CEC

An HDMI connection has the best picture and sound quality. One HDMI cable combines video and audio signals. Use an HDMI cable for High Definition (HD) or Ultra HD (UHD) TV signals. For best signal quality transfer, use a High speed HDMI cable and do not use an HDMI cable longer than 5 m.



If your devices are connected with HDMI and have EasyLink, you can operate them with the TV remote control. EasyLink HDMI CEC must be switched On on the TV and the connected device.

For more information on using EasyLink, press **Keywords** and look up **EasyLink CEC**.

DVI to HDMI

Use a DVI to HDMI adapter if your device only has a DVI connection. Use one of the HDMI connections and add an Audio L/R cable (mini-jack 3.5mm) to AUDIO IN for sound, on the back of the TV.

Copy protection

DVI and HDMI cables support HDCP (High-bandwidth Digital Content Protection). HDCP is a copy protection signal that prevents copying content from a DVD disc or Blu-ray Disc. Also referred to as DRM (Digital Rights Management).

HDMI ARC

All of the HDMI connections on the TV have HDMI ARC (Audio Return Channel).

If the device, typically a Home Theatre System (HTS), also has the HDMI ARC connection, connect it to any of the HDMI connections on this TV. With the HDMI ARC connection, you do not need to connect the extra audio cable that sends the sound of the TV picture to the HTS. The HDMI ARC connection combines both signals.

You can use any HDMI connection on this TV to connect the HTS but ARC is only available for 1 device/connection at a time.

In case you prefer to switch off ARC on the HDMI connections, press **Home** and select **Setup** and press **OK**.

Select **TV settings > Sound > Advanced > HDMI ARC**.

HDMI Ultra HD

You can watch videos filmed or made in 'native' Ultra HD resolution - 3840x2160 pixels - on this TV.

Connect a blu-ray Disc player, game console or computer that plays Ultra HD videos to an **HDMI** connection. Use a High speed HDMI cable to connect. The HDMI UHD connection can have ARC (Audio Return Channel) and does not support 3D.



- Only for TVs have an Ultra HD display.

EasyLink HDMI CEC

Y Pb Pr - Audio L R

Y Pb Pr - Component Video is a high quality connection. The YPbPr connection can be used for High Definition (HD) TV signals. Next to the Y, Pb and Pr signals add the Audio Left and Right signals for sound.

- Y shares the same jack with CVBS.
- Component and Composite share audio jacks.



- Only for TVs with component connectors.

CVBS - Audio L R

CVBS - Composite Video is a high quality connection. The CVBS connection can be used for High Definition (HD) TV signals. Next to the CVBS signal adds the Audio Left and Right signals for sound.

- Y shares the same jack with CVBS.
- Component and Composite share audio jacks.

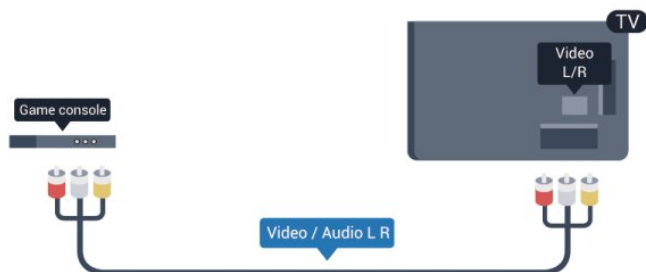

- Only for TVs with component/composite connectors.

Scart

SCART is a good quality connection. The SCART connection can be used for CVBS and RGB video signals but cannot be used for High Definition (HD) TV signals. The SCART connection combines video and audio signals.

Use the SCART adapter cable to connect your device.



Audio Out - Optical

Audio Out - Optical is a high quality sound connection. This optical connection can carry 5.1 audio channels. If your device, typically a Home Theatre System (HTS), has no HDMI ARC connection, you can use this connection with the Audio In - Optical connection on the HTS. The Audio Out - Optical connection sends the sound from the TV to the HTS.



You can set the type of the audio out signal to fit the audio capabilities of your Home Theatre System.

For more information, press **— Keywords** and look up **Audio Out settings**.

If the sound does not match the video on screen, you can adjust the audio to video synchronisation.

For more information, press **— Keywords** and look up **Audio to video sync**.

4.2

EasyLink HDMI CEC

EasyLink

With EasyLink you can operate a connected device with the TV remote control. EasyLink uses HDMI CEC (Consumer Electronics Control) to communicate with the connected devices. Devices must support HDMI CEC and must be connected with an HDMI connection.

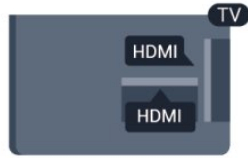

EasyLink setup

The TV comes with EasyLink switched on. Make sure that all HDMI CEC settings are properly set up on the connected EasyLink devices. EasyLink might not work with devices from other brands.

HDMI CEC on other brands

The HDMI CEC functionality has different names on different brands. Some examples are: Anynet, Aquos Link, Bravia Theatre Sync, Kuro Link, Simplink and Viera Link. Not all brands are fully compatible with EasyLink.

Example HDMI CEC branding names are property of their respective owners.

Operate devices

To operate a device connected to HDMI and set up with EasyLink, select the device - or its activity - in the list of TV connections. Press **SOURCES**, select a device connected to an HDMI connection and press **OK**.



Once the device is selected, the TV remote control can control the device. However **HOME** and **OPTIONS** keys and some other TV keys are not forwarded to the device.

If the key you need is not on the TV remote control, you can select the key in the Options menu.

Press **OPTIONS** and select **Controls** in the menu bar. On the screen, select the device key you need and press **OK**.

Some very specific device keys might not be available in the Controls menu.

Note: Only devices that support **EasyLink remote control** function will respond to the TV remote control.

EasyLink settings

The TV comes with all EasyLink settings switched on. You can switch off any EasyLink setting independently.

EasyLink

To switch off EasyLink completely . . .

- 1 - Press **HOME** and select **Setup** and press **OK**.
- 2 - Select **TV settings** > **General settings** > **EasyLink**, and press **OK**.
- 3 - Select **Off** and press **OK**.
- 4 - Press **BACK**, repeatedly if necessary, to close the menu.

EasyLink Remote Control

If you want devices to communicate but you don't want to operate them with the TV remote control, you can switch off EasyLink remote control separately.

In the EasyLink settings menu, select **EasyLink remote control** and select **Off**.

Pixel Plus Link

Some devices, a DVD or Blu-ray Disc player, might have their own picture quality processing. To avoid bad picture quality caused by interference with the TV processing, the picture processing of these devices should be disabled. The TV comes with Pixel Plus Link switched on and disables the picture quality processing of recent Philips devices connected to the TV. To switch off Pixel Plus Link, in the EasyLink settings menu, select **Pixel Plus Link** and select **Off**.

Auto subtitle shift

If you play a DVD or Blu-ray Disc on a Philips disc player that supports subtitles, the TV can move the subtitles upwards. Subtitles will be visible whatever Picture format you select. The TV comes with Auto subtitle shift switched on.

To switch off Auto subtitle shift, in the EasyLink settings menu, select **Auto subtitle shift** and select **Off**.

Auto switch off devices

You can set the TV to switch off the connecting HDMI-CEC compliant devices if they are not the active source. The TV switches the connected device to standby after 10 minutes of inactivity.

4.3

Common interface - CAM

CI+

This TV is ready for the CI+ Conditional Access.

With CI+ you can watch premium HD programmes, like movies and sports, offered by digital TV broadcasters in your region.

These programmes are scrambled by the TV broadcaster and descrambled with a prepaid CI+ module.

Digital TV broadcasters provide this CI+ module (Conditional Access Module - CAM) when you subscribe to their premium programmes. These programmes have a high level of copy protection.

Contact a digital TV broadcaster for more information on terms & conditions.

For more information on connecting a CAM module, press

— **Keywords** and look up **Common Interface CAM**.



CAM

Insert a CAM module

Switch off the TV before inserting a CAM.
Look on the CAM for the correct method of insertion. Incorrect insertion can damage the CAM and TV.

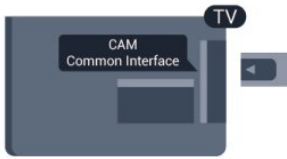

Use the Common Interface slot on the TV to insert the CAM card.
With the front of the card facing towards you, gently insert the CAM as far as it will go.
Leave the card in the slot permanently.

It may take a few minutes before the CAM is activated.
Removing the CAM will deactivate the broadcast service on TV.
If a CAM is inserted and subscription fees are paid, (connection methods can differ), you can watch the TV broadcast. The inserted CAM is exclusively for your TV.

CAM settings

To set passwords or PIN codes for the CAM TV broadcast, press **Home** and select **Setup** and press **OK**.
Select **Channel settings > Common Interface**.
Select the CAM TV broadcaster and press **OK**.

4.4

Set-top box - STB

Use 2 antenna cables to connect the antenna to the Set-top box (a digital receiver) and the TV.

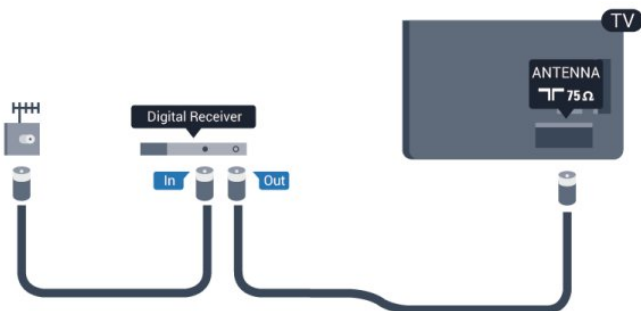

Next to the antenna connections, add an HDMI cable to

connect the Set-top box to the TV.

Alternatively, you can use a SCART cable if the Set-top box has no HDMI connection.

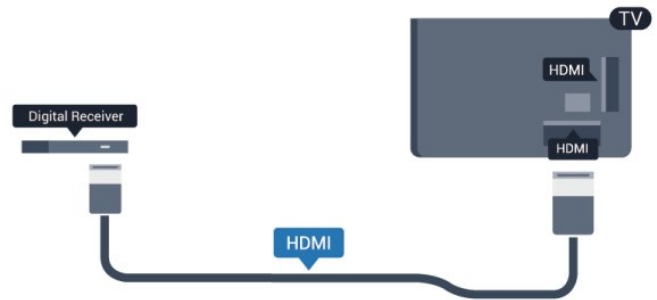

Switch off timer

Switch off this automatic timer, if you only use the remote control of the Set-top box. Do this to prevent the TV from switching off automatically after a 4 hour period without a key press on the remote control of the TV.

To switch off the Switch off timer, press **Home** and select **Setup** and press **OK**.

Select **TV settings > General settings > Switch off timer** and set the slider bar to **Off**.

4.5

Satellite receiver

- Only for TVs with a built-in satellite tuner.

Connect the dish antenna cable to the Satellite receiver.

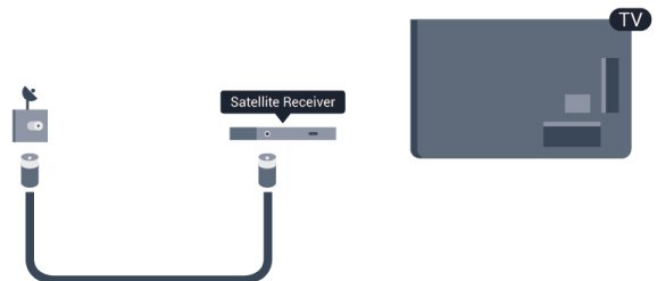

Next to the antenna connection, add an HDMI cable to connect the device to the TV.

Alternatively, you can use a SCART cable if the device has no HDMI connection.

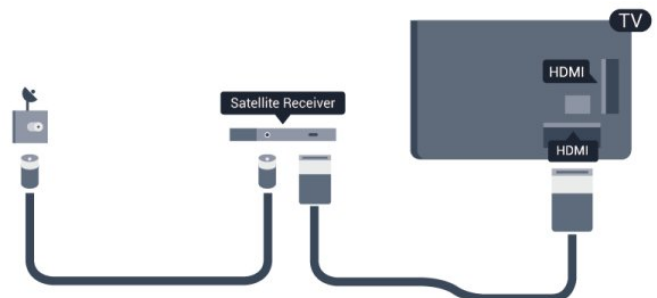

Switch off timer

Switch off this automatic timer, if you only use the remote control of the Set-top box. Do this to prevent the TV from switching off automatically after a 4 hour period without a key press on the remote control of the TV.

To switch off the Switch off timer, press **Home** and select **Setup** and press **OK**.

Select **TV settings** > **General settings** > **Switch off timer** and set the slider bar to **Off**.

4.6

Home Theatre System - HTS

Connect HTS

Use an HDMI cable to connect a Home Theatre System (HTS) to the TV. You can connect a Philips Soundbar or an HTS with a built-in disc player.

Alternatively, you can use a SCART cable if the device has no HDMI connection.

HDMI ARC

If your Home Theatre System has an HDMI ARC connection, you can use any HDMI connection on the TV to connect. With HDMI ARC, you do not need to connect the extra audio cable. The HDMI ARC connection combines both signals.

All HDMI connections on the TV can offer the Audio Return Channel (ARC) signal. But once you have connected the Home Theatre System, the TV can only send the ARC signal to this HDMI connection.

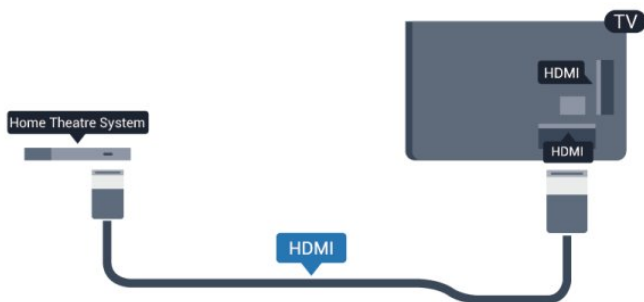

If the Home Theatre System has no HDMI ARC connection, add an optical audio cable (Toslink) to send the sound of the TV picture to the Home Theatre System.



Audio to video synchronisation (sync)

If the sound does not match the video on screen, you can set a delay on most Home Theatre Systems with a disc player to match the sound with the video.

For more information, press **Red** **Keywords** and look up **Audio to video sync**.

Audio Out settings

Audio Out delay

With a Home Theatre System (HTS) connected to the TV, the picture on TV and the sound from the HTS should be synchronised.

Automatic audio to video sync

With recent Philips Home Theatre Systems, the audio to video sync is done automatically synchronised and always correct.

Audio sync delay

For some Home Theatre Systems you might need to adjust the audio sync delay to synchronise the audio to the video. On the HTS, increase the delay value until there is a match between picture and sound. A delay value of 180ms may be required. Read the user manual of the HTS. With a delay value set up on the HTS, you need to switch off Audio out delay on the TV.

To switch off the Audio Out delay . . .

- 1 - Press **Home** and select **Setup** and press **OK**.
- 2 - Select **TV settings** > **Sound** > **Advanced** > **Audio out delay**.
- 3 - Select **Off** and press **OK**.
- 4 - Press **Left Arrow**, repeatedly if necessary, to close the menu.

Audio Out offset

If you cannot set a delay on the Home Theatre System, you can set the TV to sync the sound. You can set an offset that compensates for the time necessary for the Home Theatre System to process the sound of the TV picture. You can set the value in steps of 5ms. Maximum setting is -60ms. The Audio Out delay setting should be switched on.

To synchronise the sound on the TV . . .

- 1 - Press **Home** and select **Setup** and press **OK**.
- 2 - Select **TV settings** > **Sound** > **Advanced** > **Audio out offset**.
- 3 - Use the slider bar to set the sound offset and press **OK**.
- 4 - Press **Left Arrow**, repeatedly if necessary, to close the menu.

Audio Out format

If you have a Home Theatre System (HTS) with multichannel sound processing capabilities like Dolby Digital, DTS® or similar, set the Audio out format to

Multichannel. With Multichannel, the TV can send the compressed multichannel sound signal from a TV channel or connected player to the Home Theatre System. If you have a Home Theatre System without multichannel sound processing, select Stereo.

To set the Audio out format . . .

- 1 - Press **Home** and select **Setup** and press **OK**.
- 2 - Select **TV settings > Sound > Advanced > Audio out format**.
- 3 - Select **Multichannel** or **Stereo**.
- 4 - Press **Back**, repeatedly if necessary, to close the menu.

Audio Out levelling

Use the Audio Out levelling setting to level the volume (loudness) of the TV and the Home Theatre System when you switch over from one to another. Volume differences can be caused by differences in sound processing.

To level the difference in volume . . .

- 1 - Press **Home** and select **Setup** and press **OK**.
- 2 - Select **TV settings > Sound > Advanced > Audio out levelling**.
- 3 - If the volume difference is large, select **More**. If the volume difference is small, select **Less**.
- 4 - Press **Back**, repeatedly if necessary, to close the menu.

Audio Out levelling affects both the Audio Out - Optical and HDMI ARC sound signals.

Problems with HTS sound

Sound with loud noise

If you watch a video from a plugged in USB flash drive or connected computer, the sound from your Home Theatre System might be distorted. This noise is heard when the audio or video file has DTS sound but the Home Theatre System has no DTS sound processing. You can fix this by setting the **Audio out format** of the TV to **Stereo**.

Press **Home** and select **Setup > TV settings > Sound > Advanced > Audio out format**.

No sound

If you cannot hear the sound from the TV on your Home Theatre System, check the following . . .

- Check if you connected the HDMI cable to an **HDMI ARC** connection on the Home Theatre System. All HDMI connections on the TV are HDMI ARC connections.
- Check if the **HDMI ARC** setting on the TV is switched **On**. Press **Home** and select **Setup > TV settings > Sound > Advanced > HDMI ARC**.

4.7

Blu-ray Disc player

Use a **High speed HDMI** cable to connect the Blu-ray Disc player to the TV.



If the Blu-ray Disc player has EasyLink HDMI CEC, you can operate the player with the TV remote control.

For more information on EasyLink, press **Red** **Keywords** and look up **EasyLink HDMI CEC**.

4.8

DVD player

Use an HDMI cable to connect the DVD player to the TV. Alternatively, you can use a SCART cable, if the device has no HDMI connection.



If the DVD player is connected with HDMI and has EasyLink HDMI CEC, you can operate the player with the TV remote control.

For more information on EasyLink, press **Red** **Keywords** and look up **EasyLink HDMI CEC**.

4.9

Game console

HDMI

For best quality, connect the game console with an High speed HDMI cable to the TV

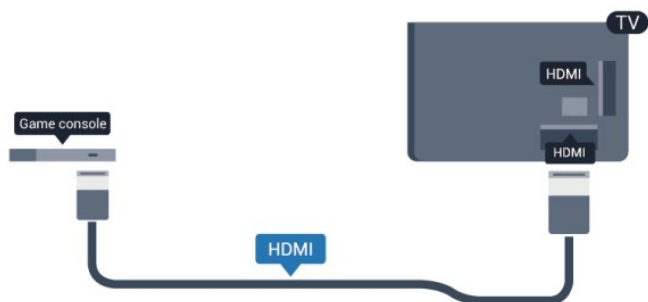

Y Pb Pr - Audio L R

Connect the game console with a component video cable (Y Pb Pr) and an audio L/R cable to the TV.



- Y shares the same jack with CVBS.
- Component and Composite share audio jacks.

CVBS - Audio L R / Scart

Connect the game console to the TV with a composite cable (CVBS) and an audio L/R cable to the TV.

If your game console only has Video (CVBS) and Audio L/R output, use a Video Audio L/R to SCART adapter to connect to the SCART connection.

Note: the CVBS to SCART Adapter is not provided in the TV set.

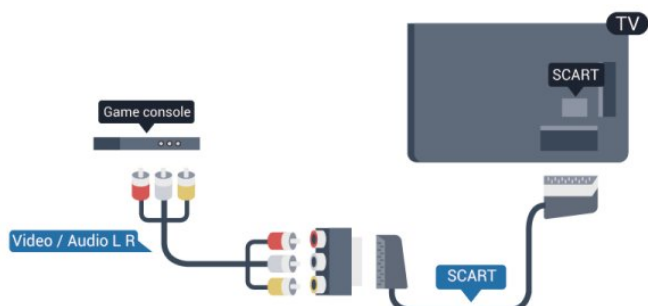

CVBS - Audio L R

Connect the game console to the TV with a composite cable (CVBS) and an audio L/R cable to the TV.

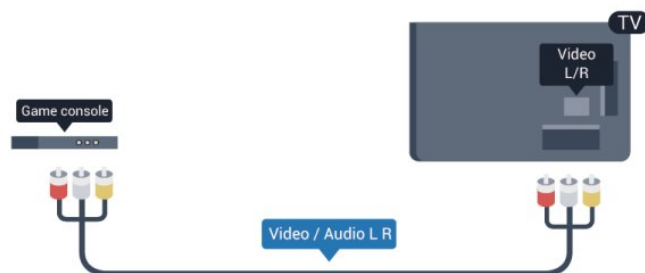

- Y shares the same jack with CVBS.
- Component and Composite share audio jacks.

4.10

USB Hard Drive

What you need

If you connect a USB Hard Drive, you can pause or record a TV broadcast. The TV broadcast must be a digital broadcast (DVB broadcast or similar).

To pause

To pause a broadcast, you need a USB 2.0 compatible Hard Drive with a minimum of 32GB disk space.

To record

To pause and record a broadcast, you need a minimum of 250GB disk space.



TV guide

Before you decide to buy a USB Hard Drive to record, you can check if it is possible to record digital TV channels in your country.

Press **TV GUIDE** on the remote control. If there is a Record button on the TV guide page, you can record.

For more information on how to install a USB Hard Drive, press **Keywords** and look up **USB Hard Drive, installation**.

Installation

Before you can pause or record a broadcast, you must connect and format a USB Hard Drive. If you want to record a broadcast with TV guide data from the Internet, you need to have the Internet connection installed on your TV before you install the USB Hard Drive. Formatting removes all files from the USB Hard Drive.

1 - Connect the USB Hard Drive to one of the **USB** connections on the TV. Do not connect another USB device to the other USB ports when formatting.

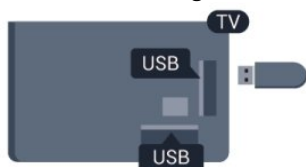

2 - Switch on the USB Hard Drive and the TV.

3 - When the TV is tuned to a digital TV channel, press **||** (Pause). Trying to pause will start the formatting.

Follow the instructions on screen.

When the USB Hard Drive is formatted, leave it connected permanently.

Warning

The USB Hard Drive is formatted exclusively for this TV, you cannot use the stored recordings on another TV or PC. Do not copy or change recording files on the USB Hard Drive with any PC application. This will corrupt your recordings. When you format another USB Hard Drive, the content on the former will be lost. A USB Hard Drive installed on your TV will need reformatting for use with a computer.

For more information, press **— Keywords** and look up **Pause TV** or **Recording**.

4.11

USB keyboard or mouse

USB keyboard

Connect a USB keyboard (USB-HID type) to enter text on your TV.

You can connect a keyboard and a mouse to the TV. Use one of the **USB** connections to connect.

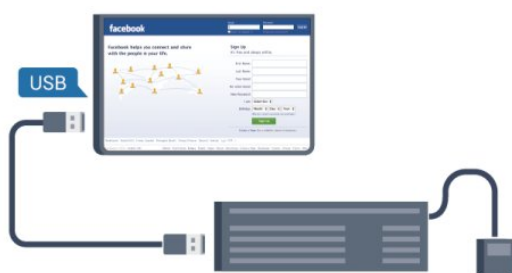

Install the keyboard

To install the USB keyboard, switch on the TV and connect the USB keyboard to one of the **USB** connections on the TV. When the TV detects the keyboard for the first time, you can select your keyboard lay-out and test your selection. If you select a Cyrillic or Greek keyboard lay-out first, you can select a secondary Latin keyboard lay-out.

To change the keyboard lay-out setting when a lay-out was selected...

1 - Press **Home** and select **Setup** and press **OK**.

2 - Select **TV settings** > **General settings** > **USB keyboard settings** and press **OK**.

Keys for channel renaming

- Enter key = OK
- Backspace = delete character before cursor
- Arrow keys = navigate within a text field
- To switch between keyboard lay-outs, if a secondary lay-out is set, press the **Ctrl + Shift** keys simultaneously.

Keys for Smart TV Apps and Internet pages

- Shift + Tab = Next and Previous
- Home = scroll to the top of the page
- End = scroll to the bottom of the page
- Page Up = jump one page up
- Page Down = jump one page down
- + = zoom in one step
- - = zoom out one step
- * = fit the web page to the screen width.

USB mouse

Connect USB mouse

You can connect a USB mouse (USB-HID type) to navigate pages on the Internet.

On an Internet page, you can select and click on links more easily.

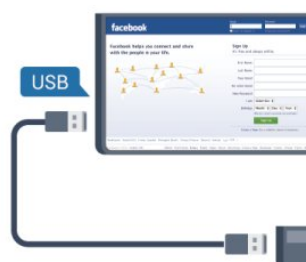

Connect the mouse

Switch the TV on and connect the USB mouse to one of the **USB** connections on the TV. You can also connect the USB mouse to a connected USB keyboard.

Mouse clicks

- Left click = OK
- Right click = **Back** ↩

You can use the scroll wheel to scroll pages up and down.

For more information on how to connect a keyboard, press **— Keywords** and look up **USB keyboard**.

Mouse speed

You can adjust the speed of the mouse moving on screen.

To adjust the speed . . .

- 1 - Press **Home** and select **Setup** and press **OK**.
- 2 - Select **TV settings** and press **OK**.
- 3 - Select **General settings > Pointer / Mouse settings** and press **OK**.
- 4 - Press the arrows **▲** (up) or **▼** (down) to increase or lower the speed.
- 5 - Press **OK** to store and close the setting.
- 6 - Press **Back**, repeatedly if necessary, to close the menu.

4.12

USB flash drive

You can view photos or play your music and videos from a connected USB flash drive.

Insert a USB flash drive in one of the **USB** connections on the TV while the TV is switched on.



The TV detects the flash drive and opens a list showing its content.

If the contents list does not appear automatically, press **Source**, select **USB** and press **OK**.

To stop watching the USB flash drive content, press **TV EXIT** or select another activity.

To disconnect the USB flash drive, you can pull out the flash drive anytime.

For more information on watching or playing content from a USB flash drive, press **— Keywords** and look up **Your photos, videos and music**.

4.13

Photo camera

To view photos stored on your digital photo camera, you can connect the camera directly to the TV.

Use one of the **USB** connections on the TV to connect. Switch on the camera after you made the connection.



If the contents list does not appear automatically, press **Source**, select **USB** and press **OK**.

Your camera might need to be set to transfer its content with PTP (Picture Transfer Protocol). Read the user manual of the digital photo camera.

For more information on viewing photos, press **— Keywords** and look up **Your photos, videos and music**.

Ultra HD on USB

You can view photos in Ultra HD resolution from a connected USB device or flash drive. The TV will downscale the resolution to Ultra HD if the resolution of the photo is higher. You cannot play a native Ultra HD video on any of the USB connections.

4.14

Camcorder

HDMI

For best quality, use an HDMI cable to connect the camcorder to the TV.



CVBS - Audio L R / Scart

You can use an HDMI, YPbPr or SCART connection to connect your camcorder. If your camcorder only has Video (CVBS) and Audio L/R output, use a Video Audio L/R to SCART adapter to connect to the SCART connection.

Note: the CVBS to Scart Adaptor is not provided in the TV set.

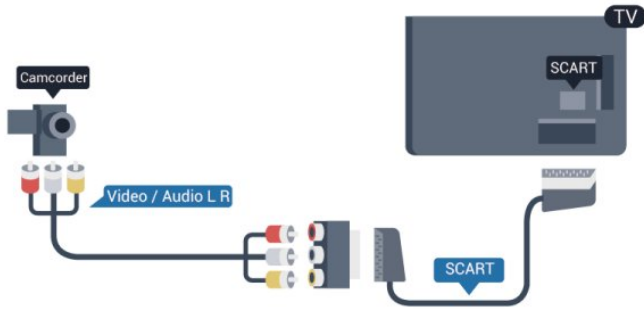

CVBS - Audio L R

Use a Video Audio L/R cable to connect the camcorder to the TV.

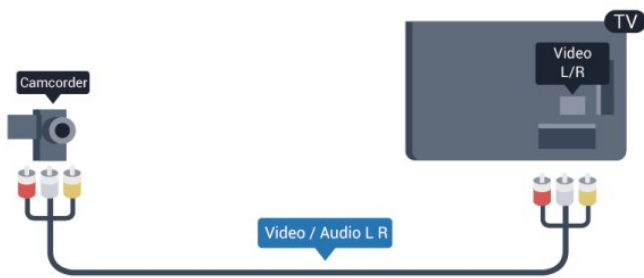

- Y shares the same jack with CVBS.
- Component and Composite share audio jacks.

4.15

Computer

Connect

You can connect your computer to the TV and use the TV as a PC monitor.

With HDMI

Use an HDMI cable to connect the computer to the TV.

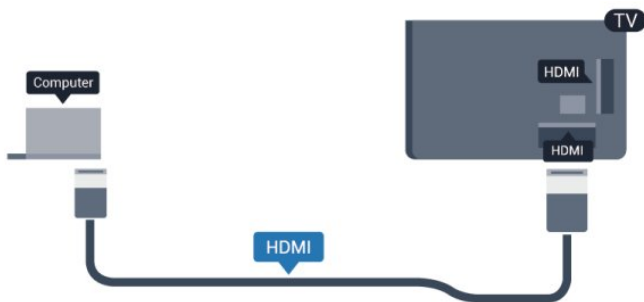

With DVI to HDMI

Alternatively, you can use a DVI to HDMI adapter to connect

the PC to HDMI and an audio L/R cable (mini-jack 3.5mm) to AUDIO IN L/R on the back of the TV.

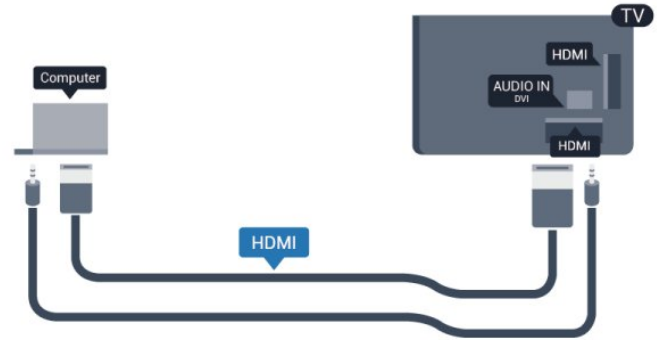

Settings

Ideal monitor setting

If your computer is added as a Computer type of device in the Source menu (the list of connections), the TV is set to the ideal Computer setting automatically.

If you use your computer to watch movies or use it to play games, you might want to set the TV back to the ideal TV watching or gaming setting.

To set the TV to the ideal setting manually . . .

- 1 - Press **Home** and select **Setup** and press **OK**.
- 2 - Select **TV settings** > **Picture** > **Advanced** > **Activity style** and press **OK**.
- 3 - Select **Game** (for gaming) or select **Computer** (for watching a movie) and press **OK**.
- 4 - Press **Back**, repeatedly if necessary, to close the menu.

Remember to set the Game or computer setting back to **Computer** when you stop playing the game.

4.16

Headphones

You can connect a set of headphones to the **Headphones** connection on the TV. The connection is a mini-jack 3.5mm. You can adjust the volume of the headphones separately.

To adjust the volume . . .

- 1 - Press **Home** and select **Setup** and press **OK**.
- 2 - Select **TV settings** > **Sound** > **Headphones volume** and press **OK**.
- 3 - Press **Up** (up) or **Down** (down) to adjust the volume.
- 4 - Press **Back**, repeatedly if necessary, to close the menu.



4.17

Wireless speakers (For 7500 series TV)

You can connect a wireless speaker - a subwoofer or a sound bar - to this TV. A range of selected Philips wireless speaker products can connect and play the TV sound. Consult www.philips.com/tv

To play the TV sound on a wireless speaker, you must pair the wireless speaker with the TV. You can pair up to 10 wireless speakers but you can only use 1 speaker system - a subwoofer or a sound bar - at a time.

To pair a wireless speaker with the TV...

- 1 - Switch on the wireless speaker and place it within range of the TV. Read the user manual of the device for specific information on pairing and wireless range.
- 2 - The wireless speaker blue LED indicator button will blink rapidly to indicate that it is ready to be paired by the TV.
- 3 - On the TV, press **Home**, select **Setup** and press **OK**.
- 4 - Select **TV settings** > **Sound** > **Sound output** and press **OK**.
- 5 - Select **Wireless speaker** > **Add new speaker** and press **OK**.
- 6 - Follow the instructions on screen. You will pair the device with the TV and the TV will store the connection.
- 7 - At any time to re-pair the TV with the wireless speaker, press and hold for 3 seconds the blue LED indicator button on the wireless speaker, and repeat step 3 to 6.

For more information on switching the TV sound to the wireless speaker, press **Red** **Keywords** and look up **Wireless speakers, select**.

Switch on

5.1

On or Standby

Make sure you plugged in the mains power on the back of the TV before you switch on the TV.

If the red indicator light is off, press the Joystick on the right side or on the back of the TV to put the TV in standby - the red indicator will light up.



With the TV in standby, press  on the remote control to switch the TV on.



Switch to standby

To switch the TV to standby, press  on the remote control.

Switch Off

To switch the TV Off, press the Joystick on the right or on the back. The red indicator light is off. The TV is still connected to the mains power but consumes a minimum of energy.

To switch off the TV completely, disconnect the power plug. When disconnecting the power plug, always pull the power plug, never the cord. Ensure that you have full access to the power plug, power cord and outlet socket at all times.

5.2

Keys on TV

While the on-screen display is on, press the Joystick to display the menu.

- Use the arrow/navigation keys to navigate up, down, left or right.

- Press the Joystick to confirm a selection or setting.

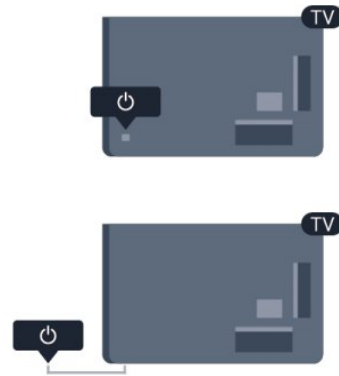



5.3

Word mark brightness

You can switch off or adjust the word mark lighting.

To adjust or switch off...

- 1 - Press  and select **Setup** and press **OK**.
 - 2 - Select **TV settings** > **General settings** > **Word mark brightness** and press **OK**.
 - 3 - Select **Maximum**, **Medium**, **Minimum** or select **Off** to switch off the lighting of the word mark.
 - 4 - Press , repeatedly if necessary, to close the menu.
- Only available for certain TV models

Remote control

6.1

Key overview for 7100, 7500 series

Top



1 - Standby / On

To switch the TV On or back to Standby.

2 - Playback and record keys

- Play , to playback.
- Pause , to pause playback
- Stop , to stop playback
- Rewind , to rewind
- Fast forward , to go fast forward
- Record , to record now

3 - Ambilight

To select an Ambilight setting.

4 - TV GUIDE

To open or close the TV guide.

5 - Settings

To open the Settings menu.

6 - Picture format

To open or close the Picture format menu.

7 - SOURCES

To open or close the Sources menu - the list of connected devices.

8 - SEARCH

To open the Popular searches page.

Middle



1 - SMART TV

To open the Smart TV start page.

2 - Colour keys

Follow on screen instructions. Blue key , opens Help.

3 - INFO

To open or close programme info.

4 - BACK

To switch back to the previous channel you selected.

To close a menu without changing a setting.

To go back to the previous Smart TV page.

5 - HOME

To open or close the home menu.

6 - EXIT

To switch back to watching TV.

7 - OPTIONS

To open or close the Options menu.

8 - OK key

To confirm a selection or setting.

9 - Arrow / navigation keys

To navigate up, down, left or right.

10 - MULTIVIEW

To open an extra small screen.

Bottom



1 - Volume

To adjust the volume level.

2 - Number keys and text keypad

To select a TV channel directly or to enter text.

3 - SUBTITLE

To switch subtitles on, off or Automatic.

4 - LIST

To open or close the channel list.

5 - Channel

To switch to the next or previous channel in the channel list.

To open the next or previous page in Text or start the next or previous chapter on a disc.

6 - Mute

To mute the sound or to restore it.

7 - TEXT

To open or close Text / Teletext.

6.2

Key overview for 6300, 6500, 6600, 6700 series







Top



1 - Standby / On

To switch the TV On or back to Standby.

2 - Playback and record keys

- Play , to playback.
- Pause , to pause playback
- Stop , to stop playback
- Rewind , to rewind
- Fast forward , to go fast forward
- Record , to record now

3 - Ambilight

To select an Ambilight setting.

4 - TV GUIDE

To open or close the TV guide.

5 - Settings

To open the Settings menu.

6 - Picture format

To open or close the Picture format menu.

7 - SOURCES

To open or close the Sources menu - the list of connected devices.

8 - SEARCH

To open the Popular searches page.

Middle



1 - SMART TV

To open the Smart TV start page.

2 - Colour keys

Follow on screen instructions. Blue key , opens Help.

3 - INFO

To open or close programme info.

4 - BACK

To switch back to the previous channel you selected.

To close a menu without changing a setting.

To go back to the previous Smart TV page.

5 - HOME

To open or close the home menu.

6 - EXIT

To switch back to watching TV.

7 - OPTIONS

To open or close the Options menu.

8 - OK key

To confirm a selection or setting.

9 - Arrow / navigation keys

To navigate up, down, left or right.

10 - MULTIVIEW

To open an extra small screen.

Bottom



1 - Volume

To adjust the volume level.

2 - Number keys and text keypad

To select a TV channel directly or to enter text.

3 - SUBTITLE

To switch subtitles on, off or Automatic.

4 - ≡ LIST

To open or close the channel list.

5 - ≡ Channel

To switch to the next or previous channel in the channel list.
To open the next or previous page in Text or start the next or previous chapter on a disc.

6 - 🔇 Mute

To mute the sound or to restore it.

7 - TEXT

To open or close Text / Teletext.

6.3

Keyboard

Overview

Qwerty and Azerty

Overview of a Qwerty / Azerty keyboard.*

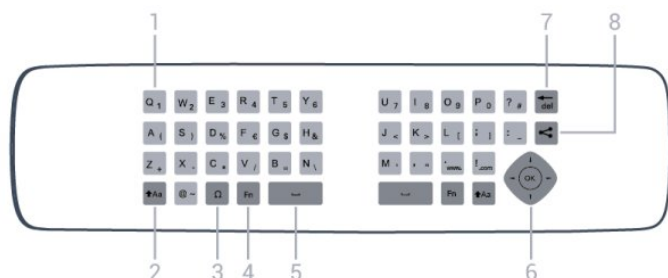

1 - Qwerty / Azerty character

Character position if the keyboard layout is set to Azerty.

2 - ⬆️ Shift

To type uppercase characters.

3 - Ω Special characters

To open the onscreen keyboard to select accented characters or symbols.

4 - Fn key

To type a number or punctuation character.

5 - ⬅️ Spacebar

6 - Navigation and OK

7 - ⬅️ Backspace

To delete the character in front of the text cursor.

8 - ➦ Share this

To share online what you are watching at the moment.

Qwerty and Cyrillic

Overview of a Qwerty / Cyrillic keyboard.*

1 - Cyrillic characters

Characters available when the keyboard is switched to Cyrillic.

2 - 🗃️ Cyrillic keyboard switch

To switch the keyboard to the Cyrillic characters or back to Qwerty.

3 - ⬆️ Shift

To type uppercase characters.

4 - Ω Special characters

To open the onscreen keyboard to select accented characters or symbols.

5 - Fn key

To type a number or punctuation character

6 - ⬅️ Spacebar

7 - ➦ Share this

To share online what you are watching at the moment.

8 - Navigation and OK

* Your remote control has a Qwerty / Azerty or a Qwerty / Cyrillic keyboard, depending on your region.

Writing text

With the keyboard on the back of the remote control, you can write text in any text field on screen. Turn the keyboard facing upwards to activate the keyboard keys. Hold the remote control with two hands and type with both thumbs.

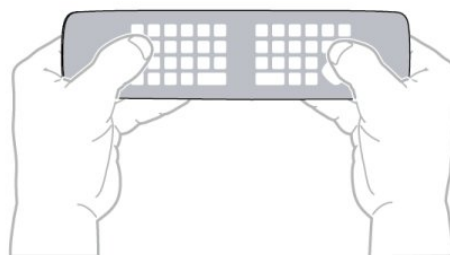

Enter text

- To enter text in a text field on screen, select the text field and start typing. Press **OK** to confirm the text.

Uppercase and lowercase

- To type an uppercase character, press the ⬆️ (Shift) key just before you type the character.
- To type several uppercase characters consecutively, press and hold the ⬆️ key while typing.
- To type uppercase constantly, press the ⬆️ key for 2 seconds

to switch the keyboard in uppercase mode.

- To switch out of uppercase mode, press the **⌘Aa** key again. If no keys are pressed for 20 seconds, the uppercase mode switches off automatically. Also, if you press another modifier key, like **Fn** or **Ω**, you switch out of uppercase mode.

Numbers and punctuation characters

- To type a number or punctuation character, press the **Fn** key just before you type the number or punctuation character you need. You can switch the Fn mode on or off as you do for the uppercase mode.

Internet

- You can use the **Fn** key to enter **www.** or **.com**.

Accented letters and symbols

Accented characters and symbols are not directly available on the remote control keyboard.

To type such a character, you can open the onscreen keyboard.

To open the onscreen keyboard, press **Ω**. In the onscreen keyboard, you can navigate to the character you need. Switch the keyboard layout with the colour keys. Press **OK** to enter a character. The onscreen keyboard disappears when you press a character on the remote control keyboard.

Alternatively, you can enter special characters with the remote control SMS/text keypad on the front of the remote control.

Qwerty, Azerty and Cyrillic keyboard

The standard layout of the remote control keyboard is Qwerty.

Azerty keyboard

Depending on your region, the remote control keyboard can be set to Azerty. The Azerty characters are shown at the top right of the relevant keys.

To set the keyboard layout to Azerty, . . .

- 1 - Press **⏠** and select **Setup** and press **OK** to open the Setup menu.
- 2 - Select **TV settings > General settings > Remote control keyboard**.
- 3 - Select **Azerty** or **Qwerty**.

Cyrillic keyboard

Depending on your region, the remote control keyboard can be switched to Cyrillic characters.

The Cyrillic characters are shown at the top right of the keyboard keys.

To write Cyrillic characters . . .

- 1 - Press **⌨** on the remote control.
- 2 - Press **⌨** again to switch back to Qwerty.

Qwerty and Azerty keyboard

The standard layout of the remote control keyboard is Qwerty.

Azerty keyboard

Depending on your region, the remote control keyboard can be set to Azerty. The Azerty characters are shown at the top right of the relevant keys.

To set the keyboard layout to Azerty, . . .

- 1 - Press **⏠** and select **Setup** and press **OK**.
- 2 - Select **TV settings > General settings > Remote control keyboard**.
- 3 - Select **Azerty** or **Qwerty**.

6.4

Pointer (For 7500 series TV)

About pointer

Instead of navigating the screen with the arrow keys, you can use the pointer. You can move the pointer — a blue arrow — over the TV screen by moving the remote control. Just like you move the cursor on a computer screen with a mouse.

You can use the pointer to navigate **Smart TV Apps*** and **Internet pages** on TV. Some Smart TV Apps might not support the use of the pointer. When the pointer is not available, you can use the arrow keys to navigate the screen.

You can adjust the speed of the pointer or if you never want to use the pointer, you can switch it off.

* Gradually more Smart TV Apps will come available for use with the pointer.

Using the pointer

When you open the Smart TV start page, the pointer is shown in the middle of the screen.

Put your thumb on the **OK** key — do not press it — and move the remote control from the wrist, no need to move your arm. You can let go of the OK key and leave the pointer where it is. You can move the remote control and pick up the pointer again when you put your thumb on the OK key.

When you press an arrow key to navigate, the pointer disappears. To recall the pointer, put your thumb on the OK key and briefly jiggle the remote control.



When you hover the pointer over a link . . .

- 1 - The pointer lights up.
- 2 - Press **OK** to open the link.

When you hover the pointer over a text field . . .
Press **OK** to enter text.

Pointer speed

You can adjust the speed of the pointer, the speed at which the pointer moves on screen.

To adjust the speed . . .

- 1 - Press **Home** and select **Setup** and press **OK**.
- 2 - Select **TV settings** and press **OK**.
- 3 - Select **General settings > Pointer and mouse speed** and press **OK**.
- 4 - Press the arrows **▲** (up) or **▼** (down) to increase or lower the speed.
- 5 - Press the arrow **▶** (right) to test the speed you set.
- 6 - Press the arrow **◀** (left) to return to the setting. You can adjust the setting again.
- 7 - Press **OK** to store and close the setting.
- 8 - Press **Back**, repeatedly if necessary, to close the menu.

Switch off

If you want to navigate the Smart TV and Internet pages with the arrow keys only, you can switch off the pointer.

To switch off the pointer . . .

- 1 - Press **Home** and select **Setup** and press **OK**.
- 2 - Select **TV settings** and press **OK**.
- 3 - Select **General settings > Remote control pointer** and select **Off**.
- 4 - Press **Back**, repeatedly if necessary, to close the menu.

6.5

IR sensor for RF remote control

The remote control of the TV uses RF (radio frequency) to send its commands to the TV. With RF, you do not need to point the remote control at the TV.

However, the TV can also receive commands from a remote control that uses IR (infrared) to send commands. If you use such a remote control, always make sure you point the remote control at the infrared sensor on the front of the TV.



6.6

IR sensor for non-RF remote control

The TV can receive commands from a remote control that uses IR (infrared) to send commands. If you use such a remote control, always make sure you point the remote control at the infrared sensor on the front of the TV.



6.7

Pairing with TV

* Only for 7100, 7500 series TV

This remote control uses radio frequency (RF) to send its commands to the TV. Contrary to remote controls using infrared signals, with this remote control you can send commands without pointing at the TV.

The TV will notify you when the battery power of the remote control is low.

Pairing the remote control

For the remote control to communicate with the TV, both TV and remote control should be paired with each other. Once paired, you cannot use the remote control to control another TV.

When you started the initial TV installation, the TV invited you to press the **OK** key, and by doing so, the pairing was done. When you switch off the TV, the pairing is stored. You can pair up to 5 remote controls with this TV.

Pairing again

You can pair another remote control with this TV.

The method to pair a remote control is different for a remote control already paired with another TV compared with a remote control that is not paired yet.

- **The remote control is paired with another TV**

To pair, hold the remote control close to the Philips logo (about 10cm) and press the **Red** and **Blue** key at the same time. A message will appear if pairing is successful.

- **The remote control is not paired yet**

To pair, hold the remote control close to the Philips logo (about 10cm) and press **OK**. A message will appear if pairing is successful.

For retail

To pair a new — not yet paired — TV with a remote control which is already paired with another TV, hold the remote control close to the Philips logo (about 10cm) and press the **Red** and **Blue** key at the same time. A message will appear if pairing is successful.

Note:

If the remote control is still fail to pair the TV, press **Home** > Setup > TV settings > General settings > Reinstall TV, then repeat pairing step again.

6.8

Batteries

With sliding door

If the TV does not react on a key press on the remote control, the batteries might be empty.

To replace the batteries, open the battery compartment on the keyboard side of the remote control.

- 1 - Slide the battery door in the direction shown by the arrow.
- 2 - Replace the old batteries with 2 type **AAA-LR03-1.5V** alkaline batteries. Make sure the + and the - ends of the batteries line up correctly.
- 3 - Reposition the battery door and slide it back until it clicks.



Remove the batteries if you are not using the remote control for a long time.

Safely dispose of your old batteries according to the end of use directions.

For more information, press **Red** **Keywords** and look up **End of use**.

With click door

The TV will notify you when the battery power of the remote control is low.

To replace the batteries, open the battery compartment on the keyboard side of the remote control.

- 1 - Use a small coin or other small, blunt object and press the square shaped release button to open the battery lid.
- 2 - Slide the blue lock open in the direction shown by the arrow and lift the lock.
- 3 - Replace the old batteries with 2 type **AA-LR6-1.5V** alkaline batteries. Make sure the + and the - ends of the batteries line up correctly.
- 4 - Push the blue lock down and slide it back until it clicks.
- 5 - Reposition the battery door and push it down until it clicks.

Put the remote control down for about 15 seconds to calibrate the pointer.

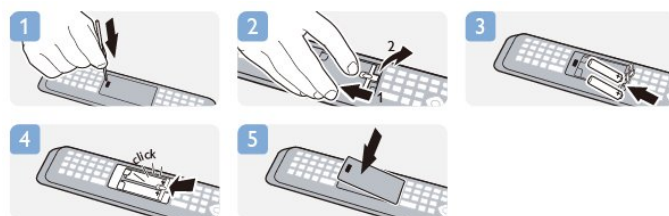

Remove the batteries if you are not using the remote control for a long time.

Safely dispose of your old batteries according to the end of use directions.

For more information, press **Red** **Keywords** and look up **End of use**.

6.9

Cleaning

Your remote control is treated with a scratch-resistant coating.

To clean the remote control, use a soft damp cloth. Never use substances such as alcohol, chemicals or household cleaners on the remote control.

TV channels

7.1

Watching TV channels

Switch channels

To watch TV channels, press **TV**. The TV tunes to the TV channel you last watched.

Alternatively, press **HOME** to open the Home menu and select **Watch TV** and press **OK**.



To switch channels, press **NUM +** or **NUM -**. If you know the channel number, type in the number with the number keys. Press **OK** after you entered the number to switch channels.

To switch back to the previously tuned channel, press **↩**.

To switch to a channel from a channel list

While watching a TV channel, press **≡ LIST** to open the channel lists.

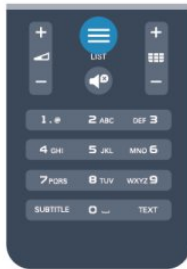

The channel list can have several pages with channels. To view the next or previous page, press **NUM +** or **NUM -**.

To close the channel lists without switching channels, press **≡ LIST** again.

Radio channels

If digital broadcasting is available, digital radio stations are installed during installation. Switch to a radio channel just like you switch to a TV channel.

Channel list

Favourite channels

You can create a favourite channel list that only holds the channels you want to watch. With the Favourite channel list selected, you will only see your favourite channels when you switch through channels.

Create your favourite channel list

- 1 - While watching a TV channel, press **≡ LIST** to open the channel list.
- 2 - Select All to view all channels.
- 3 - Select the channel, and press **★** to mark as favourite.
- 4 - The selected channel is marked with a **★**.
- 5 - To finish, press **↩**. The channels are added to the Favourites list.

To remove a channel from the favourites list, select the channel with **★**, then press **★** again to unmark as favourite.

Reorder

You can reorder — reposition — channels in the Favourite channel list.

- 1 - In the channel list **Favourites**, highlight the channel you want to reposition.
- 2 - Press **→**.
- 3 - Select the channel to reorder and press **OK**.
- 4 - Press the **Navigation buttons** to move the highlighted channel to another location and press **OK**.
- 5 - Once complete, press **TV EXIT** to exit from the Favourite channel list.

You can highlight another channel and do the same.

Channel list views

In the channel lists, you can find all installed TV and radio channels.

Next to the channel list **All**, which holds all installed channels, you can set up a list of **Favourites**, view the installed **Radio** stations separately or discover the newly added channels in **New**.

Channel logos

In some countries, the TV can show the channel logos. If you do not want these logos to appear, you can switch them off. To switch off Channel logos . . .

- 1 - Press **HOME** and select **Setup** and press **OK**.
- 2 - Select **TV settings > General settings > Channel logos** and press **OK**.
- 3 - Select **Off** and press **OK**.
- 4 - Press **↩**, repeatedly if necessary, to close the menu.

Rename channels

You can rename channels in the channel list.

- 1 - Select the channel you want to rename in one of the channel lists.
- 2 - Select the channel to rename.
- 3 - Press **→**.

You can enter text with the remote control keyboard or open the on-screen keyboard.

With the on-screen keyboard

- To open the on-screen keyboard, place the cursor in the name text field and press **OK**.
- To delete the character in front of the cursor, press **←**.
- **Backspace.**
- To enter a character, select the character with the arrow keys and press **OK**.
- To select uppercase characters, press **↵**.
- To select numbers or special characters, press **↵**.
- When you are ready, press **↵** to close the on-screen keyboard.
- To finish renaming, select **Done** and press **OK**.

With the remote control keyboard*

- To delete a character, position the cursor behind the character and press **del**.
- To enter a character, press the character on the keyboard.
- When you are ready, press **OK** to select **Done**.

Press **OK** again to finish renaming.

For more information on using the keyboard, press **→** **Keywords** and look up **Remote control, keyboard**.

* Only for the remote control with keyboard

Lock a channel

To prevent children from watching a channel or a programme, you can lock channels or lock age rated programmes.

Lock a channel

You can lock a channel to prevent children from watching it. To watch a locked channel you need to enter the Child lock code. You cannot lock programmes from connected devices.

To lock a channel . . .

- 1 - While watching a TV channel, press **≡** **LIST** to open the **Channel list**.
- 2 - In any list, select the channel you want to lock.
- 3 - Press **≡** **OPTIONS** and select **Lock channel**. In a channel list, a locked channel is marked with a lock **🔒**.

To unlock a channel, select the locked channel in the channel list. Press **≡** **OPTIONS** and select **Unlock channel**. You will need to enter the Child lock code.

Parental rating

To prevent children from watching a programme not suitable for their age, you can use an age rating.

Some digital broadcasters have age rated their programmes. When the age rating of a programme is equal to or higher than the age you have set as age rating for your child, the programme will be locked.

To watch a locked programme you must enter the child lock code. The parental age rating is set for all channels.

To set an age rating . . .

- 1 - Press **⬆** and select **Setup** and press **OK**.
- 2 - Select **Channel settings** > **Child lock** > **Parental rating** and press **OK**.
- 3 - Enter a 4-digit Child lock code and confirm. Now you can set an age rating.
- 4 - Set the age and press **OK**.
- 5 - Press **↵**, repeatedly if necessary, to close the menu.

To switch off the parental age rating, select **None** as age setting.

The TV will ask for the code to unlock the programme. For some broadcasters / operators, the TV only locks programmes with a higher rating.

Set or change the lock code

To set the lock code or to change the current code . . .

- 1 - Press **⬆** and select **Setup** and press **OK**.
- 2 - Select **Channel settings** > **Child lock** > **Change code** and press **OK**.
- 3 - If a code is set already, enter the current Child lock code and then enter the new code twice.

The new code is set.

Forgotten your code?

If you have forgotten your code to unlock, call Consumer Care in your country. Find the telephone number on the documentation that came with the TV or go to www.philips.com/support

Options for channels

While watching a channel, depending on the type of channel (analogue or digital) you are watching or depending on the TV settings you made, some options are available.

Open the options menu

While watching a channel, press **≡** **OPTIONS**.



Universal access

With Universal access switched on, you can set some options for hearing impaired and visually impaired people.

For more information, press **— Keywords** and look up **Universal access**.

Video selection

Digital TV channels can offer multi video signals (multi-feed broadcast), different camera viewpoints or angles of the same event or different programmes on one TV channel. The TV shows a message if any such TV channels are available.

Subtitles

Switch **Subtitles on** or **Subtitles off** with this options. Select **Automatic** to show subtitles only when the sound is muted with **🔇**.

Subtitle language

For digital broadcast, you can select an available subtitle language temporarily if none of your preferred languages are available. For more information, press **— Keywords** and look up **Subtitles**.

Audio languages

For digital broadcast, you can select an available audio language temporarily if none of your preferred languages are available. For more information, press **— Keywords** and look up **Audio languages**.

Dual I-II

If an audio signal contains two audio languages but one language — or both — has no language indication, this option is available.

Common interface

If prepaid premium content is available from a CAM, you can set the provider settings with this option.

HbbTV on this channel

You can block the HbbTV pages from a channel that offers HbbTV.

For more information, press **— Keywords** and look up **HbbTV**.

MHP applications

Enable or disable the MHP applications.

For more information, press **— Keywords** and look up **MHP**.

Status

Select **Status** to view technical information on the channel (if it is analogue or digital) or a connected device you are watching.

Share

Enables the user to communicate his activity with his social networks (such as Twitter, facebook or email).

Picture format

If black bars appear on top and bottom or on both sides of the picture, you can adjust the picture format to a format that fills the screen.

To change the picture format . . .

1 - While watching a TV channel, press **📺** to open the **Picture format** menu.

2 - Select a format from the list and press **OK**.

The following format can be available according the picture on screen . . .

- **Basic**
 - Fill screen
 - Fit to screen

- **Advanced**
 - Last setting
 - Shift
 - Zoom
 - Stretch
 - Native
 - Undo

Text / Teletext

Text pages

To open Text (Teletext) while you are watching TV channels, press **TEXT**.

To close Text, press **TEXT** again.



Select a Text page

To select a page . . .

- 1 - Enter the page number with the number keys.
- 2 - Use the arrow keys to navigate.
- 3 - Press a colour key to select a colour-coded subject at the bottom of the screen.

Text sub-pages

A Text page number can hold several subpages. The subpage numbers are shown on a bar next to the main page number.

To select a subpage, press **◀** or **▶**.

T.O.P. Text pages

Some broadcasters offer T.O.P. Text.
To open T.O.P. Text pages within Text,
press **≡** **OPTIONS** and select **T.O.P. overview**.

Text options

In Text, press **≡** **OPTIONS** to select the following . . .

- **Freeze page**
To stop the automatic rotation of subpages.
- **Dual screen / Full screen**
To show the TV channel and Text alongside each other.
- **T.O.P. overview**
To open T.O.P. Text.
- **Enlarge**
To enlarge the Text page for comfortable reading.
- **Reveal**
To unhide hidden information on a page.
- **Cycle subpages**
To cycle subpages when these are available.
- **Language**
To switch the group of characters that Text uses to display correctly.
- **Text 2.5**
To activate the Text 2.5 for more colours and better graphics.

Text setup

Text language

Some digital TV broadcasters have several Text languages available.

To set your primary and secondary Text language . . .

- 1 - Press **⏠** and select **Setup** and press **OK**.
- 2 - Select **Channel settings** > **Language**.
- 3 - Select **Primary Teletext** or **Secondary Teletext**.
- 4 - Select your preferred Text languages.
- 5 - Press **↩**, repeatedly if necessary, to close the menu.

Text 2.5

If available, Text 2.5 offers more colours and better graphics.

Text 2.5 is activated as a standard factory setting.

To switch off Text 2.5 . . .

- 1 - Press **TEXT**.
- 2 - While watching the teletext, press **≡** **OPTIONS**.
- 3 - Select **Text 2.5** > **Off**.
- 4 - Press **↩**, repeatedly if necessary, to close the menu.

Menu language

To change the language of the TV menus and messages . . .

- 1 - Press **⏠** and select **Setup** and press **OK**.
- 2 - Select **TV settings** > **General settings** > **Menu language** and press **OK**.
- 3 - Select the language you want and press **OK**.

- 4 - Press **↩**, repeatedly if necessary, to close the menu.

Audio languages

If the TV channel broadcasts multiple or dual audio languages, you can select your preferred audio language.

- 1 - While you watch TV, press **≡** **OPTIONS**.
- 2 - For digital channels, select **Audio language**. For analogue channels, select **Alternate audio**. Press **OK** to confirm your selection.
- 3 - Select from the available languages, then press **OK**.

Note:

If you have selected **Alternate audio** for analogue channels, select between:

- **Main**: Primary audio language or
- **SAP**: Secondary audio language

Subtitles and languages

Subtitles

Switch subtitles on

To open the Subtitle menu, press **SUBTITLE**.

You can set subtitles to **On**, **Off** or **Automatic**.

To show subtitles when the broadcasted programme is not in your language — the language you set for the TV, select **Automatic**. Also, this setting will show subtitles when you mute the sound with **🔇**.

For analogue channels, subtitles must be made available in **Text**.



Subtitles for digital channels

There is no need to set subtitles in Text for digital channels. Digital channels can offer several subtitle languages for a programme. You can set a preferred primary and secondary subtitle language. If subtitles in one of these languages are available, the TV will show them.

If none of the preferred subtitle languages are available, you can select another subtitle language which is available.

To set the primary and secondary subtitle language . . .

- 1 - Press **⏠** and select **Setup** and press **OK**.
- 2 - Select **Channel settings** and select **Languages** > **Primary subtitles language** or **Secondary subtitles language** and press **OK**.

- 3 - Select a language and press **OK**.
- 4 - Press **↩**, repeatedly if necessary, to close the menu.

To select a subtitle language when none of your preferred languages are available . . .

- 1 - Press **≡** **OPTIONS**.
- 2 - Select **Subtitle language** and select a language you want temporarily and press **OK**.

Subtitles for analogue channels

For analogue channels, you need to make the subtitles available for each channel manually.

- 1 - Switch to a channel and press **TEXT** to open Text.
- 2 - Enter the page number for subtitles, usually **888**.
- 3 - Press **TEXT** again, to close Text.

If you select On in the Subtitle menu when watching this analogue channel, subtitles will be shown if available.

To know if a channel is analogue or digital, switch to the channel and open **Status** in the **Options** menu.

Audio languages

Digital TV channels can broadcast audio with several spoken languages for a programme. You can set a preferred primary and secondary audio language. If audio in one of these languages is available, the TV will switch to this audio.

If none of the preferred audio languages is available, you can select another audio language which is available.

To set the primary and secondary audio language . . .

- 1 - Press **🏠** and select **Setup** and press **OK**.
- 2 - Select **Channel settings** and select **Languages > Primary audio language** or **Secondary audio language** and press **OK**.
- 3 - Select a language and press **OK**.
- 4 - Press **↩**, repeatedly if necessary, to close the menu.

To select an audio language when none of your preferred audio language is available . . .

- 1 - Press **≡** **OPTIONS**.
- 2 - Select **Audio language** and select an audio language you want temporarily and press **OK**.



Audio languages for the hearing and visually impaired

Some digital TV channels broadcast special audio and subtitles adapted for people who are hearing or visually impaired.

For more information, press **—** **Keywords** and look up **Universal access**.

Menu language

To change the language of the TV menus and messages . . .

- 1 - Press **🏠** and select **Setup** and press **OK**.
- 2 - Select **TV settings > General settings > Menu language** and press **OK**.
- 3 - Select the language you want and press **OK**.
- 4 - Press **↩**, repeatedly if necessary, to close the menu.

Interactive TV

About iTV

With interactive TV, some digital broadcasters combine their normal TV programme with information or entertainment pages. On some pages, you can respond to a programme or vote, do online shopping or pay for a video-on-demand programme.

HbbTV, MHEG, . . .

Broadcasters use various interactive TV systems : HbbTV (Hybrid Broadcast Broadband TV) or iTV (Interactive TV - MHEG). Interactive TV is sometimes referred to as Digital Text or Red button. But each system is distinct.

Visit the broadcaster's Internet website for more information.

What you need

Interactive TV is only available on digital TV channels. To enjoy the full benefits of Interactive TV, you need a high-speed (broadband) Internet connection to the TV.

HbbTV

If a TV channel offers HbbTV pages, you must first switch on HbbTV in the TV settings to view the pages.

- 1 - Press **🏠** and select **Setup** and press **OK**.
- 2 - Select **TV settings** and select **General settings > HbbTV** and press **OK**.
- 3 - Select **On** and press **OK**.
- 4 - Press **↩**, repeatedly if necessary, to close the menu.

If you want to avoid access to HbbTV pages on a specific channel, you can block the HbbTV pages for this channel only.

- 1 - Tune to the channel of which you want to block the HbbTV pages.
- 2 - Press **≡** **OPTIONS** and select **HBB TV on this channel** and press **OK**.
- 3 - Select **Off** and press **OK**.

Use iTV

Open iTV pages

Most channels that offer HbbTV or iTV invite you to press the

➔ key or **OK** key to open their interactive programme.

Navigate iTV pages

You can use the arrow and colour keys, the number keys and the ⏪ key to navigate the iTV pages.

You can use the ▶ (Play), ⏸ (Pause) and ■ (Stop) keys to watch videos within iTV pages.

Digital Text (UK only)

To open Digital Text, press **TEXT**. To close, press ⏪.

Close iTV pages

Most iTV pages inform you which key to use to close.

To force an iTV page to close, switch to the next TV channel and switch back.

About interactive TV

With interactive TV, some digital broadcasters combine their normal TV programme with information or entertainment pages.

Note:

- You cannot download files to your TV with this feature.
- Not all TV programmes, commercials and features include closed captioning information.
- You cannot respond to the digital content.

Visit the broadcaster's Internet website for more information.

7.2

Channel installation

Update channels

Automatic update

If you receive digital channels, you can set the TV to automatically update the list with new channels. Alternatively, you can start a channel update yourself.

Automatic channel update

Once a day, at 6 AM, the TV updates the channels and stores new channels. New channels are stored in the All channels list but also in the New channels list. Empty channels are removed. If new channels are found or if channels are updated or removed, a message is shown at TV start up. The TV must be in standby to automatically update channels.

To switch off the message at start up . . .

- 1 - Press **⏪** and select **Setup** and press **OK**.
- 2 - Select **Channel settings** and press **OK**.
- 3 - Select **Channel installation > Channel update message >**

Off.

To switch off the Automatic channel update . . .

- 1 - Press **⏪** and select **Setup** and press **OK**.
- 2 - Select **Channel settings** and press **OK**.
- 3 - Select **Channel installation > Automatic channel update > Off** and press **OK**.

Start an update

To start an update yourself . . .

- 1 - Press **⏪** and select **Setup** and press **OK**.
- 2 - Select **Search for channels** and press **OK**.
- 3 - Select **Update channels** and follow the instructions on screen. The update may take a few minutes.

In certain countries, the Automatic channel update is done while watching TV or any moment when the TV is in standby.

Reinstall channels

You can search for and reinstall channels and leave all other TV settings untouched. Alternatively, you can do a full new TV installation.

If a child lock code is set, you will need to enter this code before you can reinstall channels.

Reinstall channels

To reinstall the channels only . . .

- 1 - Press **⏪** and select **Setup** and press **OK**.
- 2 - Select **Search for channels > Re-install channels** and press **OK**.
- 3 - Select the country where you install the TV.
- 4 - Select **Antenna (DVB-T)** or **Cable (DVB-C)**. The channel search may take a few minutes. Follow the instructions on screen.

Full installation

To redo a full TV installation . . .

- 1 - Press **⏪** and select **Setup** and press **OK**.
- 2 - Select **TV settings > General settings > Reinstall TV** and press **OK**. The installation may take a few minutes. Follow the instructions on screen.

Factory settings

Factory settings sets the TV back to the original TV settings for picture and sound. To switch back to the original Factory settings . . .

- 1 - Press **⏪** and select **Setup** and press **OK**.
- 2 - Select **TV settings > General settings > Factory settings** and press **OK**.
- 3 - Press **OK** to confirm.
- 4 - Press **⏪**, repeatedly if necessary, to close the menu.

Channel list copy

Introduction

Channel list copy is intended for dealers and expert users. In some countries, Channel list copy is only available for copying satellite channels.

With **Channel list copy**, you can copy the channels installed on one TV onto another Philips TV of the same range. With Channel list copy, you avoid the time-consuming channel search by uploading a predefined channel list on a TV. Use a USB flash drive of minimum 1 GB.

Conditions

- Both TVs are from the same year range.
- Both TVs have the same hardware type. Check the hardware type on the TV type plate on the back of the TV. Typically noted as Q . . . LA
- Both TVs have compatible software versions.

Current version

You can check the current version of the TV software with **Current software info** in **Home** > **Setup** > **Software settings**.

Copy channel list

To copy a channel list . . .

- 1 - Switch on the TV which has its channels installed. Plug in a USB memory device.
- 2 - Press **Home** and select **Setup** and press **OK**.
- 3 - Select **TV settings** > **General settings** > **Channel list copy** > **Copy to USB** and press **OK**. To copy the channel list from this TV, you might be asked to enter the Child lock code you entered during the installation.
- 4 - When copying is done, unplug the USB memory device.

Now you can upload the copied channel list onto another Philips TV.

Upload channel list

Upload a copied channel list

Depending on whether your TV is already installed or not, you must use a different way to upload a channel list.

To a TV that is not yet installed

- 1 - Plug in the power plug to start the installation and select language and country. You can skip Search for channels. Finish the installation.
- 2 - Plug in the USB memory device that holds the channel list of the other TV.
- 3 - To start the channel list upload, press **Home** and select **Setup** and press **OK**.
- 4 - Select **TV settings** > **General settings** > **Channel list copy** > **Copy to TV** and press **OK**. You might be asked to enter the

Child lock code of this TV.

5 - The TV notifies you if the channel list is copied to the TV successfully. Unplug the USB memory device.

To an already installed TV

- 1 - Verify the country setting of the TV. (To verify this setting, press **Home** and select **Setup** and press **OK**. Select **Search for channels** > **Re-install channels** and press **OK**. Press **Left** and later **Cancel** to leave the Search for channels.)
If the country is correct continue with step 2.
If the country is not correct, you need to start a reinstallation. To start the reinstallation, press **Home** and select **Setup** and press **OK**. Select **TV settings** > **General settings** > **Reinstall TV** > **OK**. Select the correct country and skip the Search for channels. Finish the installation. When done, continue with step 2.
- 2 - Plug in the USB memory device that holds the channel list of the other TV.
- 3 - To start the channel list upload, press **Home** and select **Setup** and press **OK**.
- 4 - Select **TV settings** > **General settings** > **Channel list copy** > **Copy to TV** and press **OK**. You might be asked to enter the Child lock code of this TV.
- 5 - The TV notifies you if the channel list is copied to the TV successfully. Unplug the USB memory device.

DVB-T or DVB-C

DVB-T or DVB-C reception

If both DVB-T and DVB-C reception is available in your country and if this TV is ready to receive DVB-T and DVB-C for your country, you have selected one or the other during the channel installation.

If you want to change the DVB setting to start a new channel installation . . .

- 1 - Press **Home** and select **Setup** and press **OK**.
- 2 - Select **Channel settings** and press **OK**.
- 3 - Select **Channel installation** > **Antenna connection** > **Antenna (DVB-T)** or **Cable (DVB-C)** and press **OK**.
- 4 - Select the DVB setting you want.
- 5 - Press **Left**, repeatedly if necessary, to close the menu.

DVB-C channel installation

For ease of use, all DVB-C settings are set to automatic. If your DVB-C provider gave you specific DVB-C values, the network ID or network frequency, enter these values when the TV asks for them during installation.

It might be necessary to adjust the scanning (full or quick scan) or enter a specific symbol rate in the **Settings** menu while installing. To set a **Symbol rate**, first set the Symbol rate to **Manual**.

Channel number conflicts

In some countries, different TV channels (broadcasters) might have the same channel number. While installing, the TV shows the list with channel number conflicts. You need to select which

TV channel you want to install on a channel number with multiple TV channels.

DVB-T + DVB-C

If you can use a DVB-T antenna input but also a DVB-C input, you can set up your TV for both DVB-T and DVB-C. Install one system followed by the other with the necessary settings.

Once each system is installed, you need to switch the antenna input signal on the **Antenna** connection on the back of the TV and set the TV in the appropriate system to view the installed channels on TV.

To select the DVB-T or DVB-C setting, see above.

DVB settings

Access DVB settings

- 1 - Press **Home** and select **Setup** and press **OK**.
- 2 - Select **Search for channels** and press **OK**.
- 3 - Select **Re-install Channels**.
- 4 - Select the country where you install this TV.
- 5 - Select **Cable (DVB-C)**.
- 6 - Select **Start to search channels**, or select **Settings for DVB-C settings**.
- 7 - Press **Back**, repeatedly if necessary, to close the menu.

Symbol rate mode

If your cable provider did not give you a specific **symbol rate** value to install the TV channels, leave the **Symbol rate mode** setting on **Automatic**.

If you received a specific symbol rate value, select **Manual**. However, the value you received could be in the predefined list of symbol rates already. Select **Predefined symbol rates** to check if your value is available automatically.

Symbol rate

With the **Symbol rate mode** set to **Manual**, you can enter the symbol rate value you received from your cable provider. To enter the value, use the number keys.

Network frequency mode

If you intend to use the fast **Quick scan** method in **Frequency scan** to search for channels, select **Automatic**. The TV will use 1 of the predefined network frequencies (or HC - homing channel) as used by most cable providers in your country.

If you received a specific network frequency value to search for channels, select **Manual**.

Network frequency

With the **Network frequency mode** set to **Manual**, you can enter the network frequency value received from your cable provider here. To enter the value, use the number keys.

Frequency scan

Select the method of searching for channels. You can select the faster **Quick scan** method and use the predefined settings used by most cable providers in your country.

If this results in having no channels installed or if some channels are missing, you can select the extended **Full scan** method. This method will take more time to search for and install channels.

Digital channels

If you know your cable provider is not offering digital channels, you can skip searching for digital channels. Select **Off**.

Analogue channels

If you know your cable provider is not offering analogue channels, you can skip searching for analogue channels. Select **Off**.

Free / Scrambled

If you have a subscription and a CAM - Conditional Access Module for pay TV services, select **Free + scrambled**. If you did not subscribe to pay TV channels or services, you can select **Free channels** only.

For more information, press **Red** **Keywords** and look up **CAM - Conditional Access Module**.

Reception quality

If you receive digital channels, you can check the quality and signal strength of a channel.

If you have your own antenna, you can reposition the antenna to try and improve the reception.

To check the reception quality of a digital channel . . .

- 1 - Tune to the channel.
- 2 - Press **Home** and select **Setup** and press **OK**.
- 3 - Select **Channel settings > Channel installation > Digital : reception test** and press **OK**.

The digital frequency is shown for this channel. If the reception is poor, you can reposition your antenna. To check the signal quality of this frequency again, select **Search** and press **OK**. To enter a specific digital frequency yourself, use the remote

control digit keys. Alternatively, select the frequency, position the arrows on a number with ◀ and ▶ and change the number with ▲ and ▼. To check the frequency, select **Search** and press **OK**.

If you use DVB-C to receive channels, the option **Symbol rate mode** is available. For Symbol rate mode, select **Automatic**, unless your cable provider gave you a specific symbol rate value. To enter the symbol rate value, use the number keys.

Manual installation

Analogue TV channels can be manually installed, channel by channel.

To install analogue channels manually . . .

1 - Press **Home** and select **Setup** and press **OK**.

2 - Select **Channel settings** > **Channel installation** > **Analogue : Manual installation** and press **OK**.

- **System**

To set up the TV system, select **System** and press **OK**.

Select your country or the part of the world where you are now.

- **Search channel**

To find a channel, select **Search channel** and press **OK**. Select **Search** and press **OK**. You can also enter a frequency yourself. If the reception is poor, press **Search** again. If you want to store the channel, select **Done** and press **OK**.

- **Fine tune**

To fine tune a channel, select **Fine tune** and press **OK**. You can fine tune the channel with ▲ or ▼.

If you want to store the channel found, select **Done** and press **OK**.

- **Store current channel / Store as new channel**

You can store the channel on the current channel number or as a new channel number.

Select **Store current channel** or **Store as new channel**.

You can redo these steps until you have found all available analogue TV channels.

Satellite channels

8.1

Satellite channels

- Only for TVs with a built-in satellite tuner.

8.2

Watching satellite channels

To watch satellite channels . . .

Press **Home** and select **Satellite** and press **OK**. The TV tunes to the satellite channel you last watched.

Change channel

To change channels, press **Menu** + or **Menu** -. The TV will tune to the next channel in the selected channel list. If you know the channel number, you can use the number keys on the remote control. To change back to the previously tuned channel, press **Back**.

You can also tune to a channel directly from the Satellite channel list.

8.3

Satellite channel list

About the channel list

When the satellite installation is completed, all satellite channels are put in the channel list. You can view the list of all channels or filter the list down to show the favourite channels only or the radio stations only. Or, after a channel update, you can find the newly added channels in the list of new channels.

From any list, you can directly tune to a channel. The list you select in the channel list, determines the channels you tune to with the **Menu** + and **Menu** - keys.

You can only reorder channels in the list of favourite channels.

Select a list filter

The list you select in the channel list, determines the channels you tune to with the **Menu** + and **Menu** - keys.

To select a channel list . . .

- 1 - Press **Home** and select **Satellite** and press **OK**.
- 2 - Press **Menu** LIST to open the channel list. The list appears with the current channel selected.
- 3 - Navigate up to select **All** or a list filter.

The lists Radio or New are only shown when radio stations are available or new channels were found with a channel update.

Tune from the channel list

To tune to a channel from the channel list . . .

- 1 - In the channel list, select **TV** or **Satellite** in the menu bar to select the TV or Satellite channel list.
- 2 - Select a list.
- 3 - Select a channel in any of the lists and press **OK**. The TV will tune to the selected channel.

Channel list options

To view the channel list options on the current channel . . .

- 1 - With the All channels list on screen, select a channel and press **Menu** OPTIONS.
- 2 - Select the option you want and press **OK**.

Available options for satellite channels . . .

• Satellite

Filter the channel list to only show the channels of a specific satellite or show the channels of all satellites.

• Free/Scrambled

Filter the channel list to only show the free-to-air channels, only the scrambled channels or both. Scrambled channels are marked with a key **KS**.

• Lock channel

You can lock a channel. First select a channel in the list, press **Menu** OPTIONS and select **Lock channel**. You will have to enter the 4-digit child lock code. A locked channel is marked with a lock **KL**.

• Unlock channel

To unlock a locked channel. Select a locked channel in the list, press **Menu** OPTIONS and select **Unlock channel**. You will have to enter the 4-digit child lock code.

Channel list copy

Channel list copy is intended for dealers and expert users. With Channel list copy, you can copy the channels installed on one TV onto another Philips TV of the same range. Channel list copy will copy both terrestrial and satellite channels.

For more information, press **Menu** Keywords and look up **Channel list copy**.

Favourite satellite channels

Favourite channels

You can mark channels as favourite channels. Your favourite satellite channels are collected in the **Favourites** list of the satellite channel list.

Watching favourite channels

Set up a favourite channel list to easily switch between the channels you want to watch.

To only switch between your favourite channels with **≡ +** and **≡ -**, select the Favourites list in the channel list and close the channel list again.

There are two favourite lists, one for TV channels and one for satellite channels.

Set up your favourites list

To compose a list of your favourite channels . . .

- 1 - While watching a channel, press **≡ LIST** to open the channel list.
- 2 - In the menu bar, select **📡** for satellite channels.
- 3 - Select the **Favourites** list.
- 4 - The TV will ask you to start adding channels immediately. Press **OK**. To avoid a lot of reordering later, select the channels in the order you want them in the list.
- 5 - To add a channel to the Favourites list, select the channel and press **OK**. You can then select another channel to add as a favourite.
- 6 - To finish, press **↩**.

Add or remove favourite channels

To add or remove favourites list . . .

- 1 - While watching a TV channel, press **≡ LIST** to open the channel list.
- 2 - Select **All** to view all channels.
- 3 - Select the channel, and press **👉** to mark as favourite.
- 4 - The selected channel is marked with a **★**.
- 5 - To finish, press **↩**. The channels are added to the Favourites list.

To remove a channel from the favourites list, press **👉** to unmark as favourite.

Reorder favourite channels

You can only reorder channels in the Favourites list.

- 1 - In the channel list **Favourites**, highlight the channel you want to reposition.
- 2 - Press **👉**.
- 3 - Select the channel to reorder and press **OK**.
- 4 - Press the **Navigation buttons** to move the highlighted channel to another location and press **OK**.
- 5 - Once complete, press **TV EXIT** to exit from the Favourite channel list.

Lock satellite channels

Lock a channel

You can lock a channel to prevent children from watching it. To watch a locked channel you need to enter the Child lock code. You cannot lock programmes from connected devices.

To lock a channel . . .

- 1 - While watching a TV channel, press **≡ LIST** to open the channel list.
- 2 - In any list, select the channel you want to lock.
- 3 - Press **≡ OPTIONS** and select **Lock channel**. In a channel list, a locked channel is marked with a lock **🔒**.

To unlock a channel, select the locked channel in the channel list and press **≡ OPTIONS**, select **Unlock channel**.

Use an age rating

To prevent children from watching a programme not suitable for their age, you can use an age rating.

Some digital broadcasters have age rated their programmes. When the age rating of a programme is equal to or higher than the age you have set as age rating for your child, the programme will be locked.

To watch a locked programme you must enter the child lock code. The parental age rating is set for all channels.

To set an age rating . . .

- 1 - Press **🏠** and select **Setup** and press **OK**.
- 2 - Select **Satellite settings > Child lock > Parental rating** and press **OK**.
- 3 - Enter a 4-digit Child lock code and confirm. Now you can set an age rating.
- 4 - Set the age and press **OK**.
- 5 - Press **↩**, repeatedly if necessary, to close the menu.

To switch off the parental age rating, select **None** as age setting.

The TV will ask for the code to unlock the programme. For some broadcasters / operators, the TV only locks programmes

with a higher rating.

Child lock code

You can set or change the Child lock code.

To set the lock code or to change the current code . . .

- 1 - Press **Home** and select **Setup** and press **OK**.
- 2 - Select **Satellite settings** > **Child lock** > **Change code** and press **OK**.
- 3 - If a code is set already, enter the current Child lock code and then enter the new code twice.

The new code is set.

Forgotten your Child lock code?

If you forgot your code, you can override the current code and enter a new code.

- 1 - Press **Home** and select **Setup** and press **OK**.
- 2 - Select **Satellite settings** > **Child lock** > **Change code** and press **OK**.
- 3 - Enter the overriding code **8888**.
- 4 - Now enter a new Child lock code and enter it again to confirm.

8.6

Satellite installation

Installing satellites

About installing satellites

This TV has a built-in satellite DVB-S/DVB-S2 receiver. Connect the cable from your satellite dish directly to the TV. Use a coaxial cable fit for connecting a satellite antenna dish. Make sure your satellite dish is perfectly aligned before you start the installation.

Up to 4 satellites

You can install up to 4 satellites (4 LNBs) on this TV. Select the exact number of satellites you wish to install at the start of the installation. This will speed up the installation.

Unicable

You can use a Unicable system to connect the antenna dish to the TV. Select if you are installing satellites for a Unicable system, for 1 or for 2 satellites at the start of the installation.

MDU - Multi-Dwelling-Unit

The satellite receiver of this TV supports MDU on the Astra satellites and for Digiturk on the Eutelsat satellite. MDU on Türksat is not supported.

Installing

You can install your satellites during the initial TV setup. The satellite installation follows the TV channel installation. If you only watch satellite channels, you can skip the TV channel installation. You can always start a new satellite installation from the Setup menu.

To install satellite channels . . .

- 1 - Press **Home** and select **Setup** and press **OK**.
- 2 - Select **Search for satellite** and press **OK**.
- 3 - Select **Install satellites** and press **OK**.
- 4 - The TV shows the current installation setting. If the current setting corresponds with the satellite installation you want, you can start searching for satellites. Select **Search** and press **OK**. Go to step 5. If the current setting is not the setting you want, select **Settings** and press **OK**. Go to step 4b.
- 4b - In the Settings menu, select the exact number of satellites you want to install. Or, if you use a Unicable setup, select **Unicable for 1 satellite** or **Unicable for 2 satellites** according to the number of satellites you want to install for Unicable. Select the setting you want and press **OK**.
- 4c - If the exact number of satellites is set or you completed the Unicable settings, select **Search** and press **OK**.
- 5 - The TV will search for satellites available on the alignment of your antenna dish. This may take a few minutes. If a satellite is found, its name and reception strength are shown on screen.
- 6 - If a channel package is available for any of the satellites found, you can select the package you want.
- 7 - To install the channels of the satellites found, select **Install** and press **OK**. The TV shows the number of channels and radio stations found.
- 8 - To store the satellite settings, all satellite channels and satellite radio stations, select **Finish** and press **OK**.

Channel packages

About channel packages

Satellites can offer channel packages that bundle free channels (free-to-air) and offer a sorting that suits a country. Some satellites offer subscription packages - a collection of channels you pay for.

If you choose a subscription package, the TV might ask you to select a Quick or Full installation.

Select **Satellite operator channels only** to install the channels of the package only or select **All satellite channels** to install the package and all other available channels too. We recommend a Quick installation for subscription packages. If you have additional satellites that are not part of your subscription package, we recommend a Full installation. All installed channels are put in the channels list All.

Update channel packages

With **Update channel package**, you can bring back satellite channels that were in the satellite channel list before but are now missing. The missing channels were repositioned on the transponder by the satellite operator. The TV must be updated with the latest version of the channel package.

To download the latest version of the channel package . . .

1 - Go to the Philips support website www.philips.com/support and enter the type number of your TV.

2 - Click on **Software and drivers** and look for the file :

PredefinedSortingList

3 - Download the file on your computer and copy the file on the root directory of a USB flash drive, not in a folder (if necessary, unzip the file first).

4 - Plug the USB flash drive into the TV and press **⬆** and select **Setup** and press **OK**.

5 - Select **Satellite settings > Channel installation > Update channel package** and press **OK**.

6 - The TV will copy the file and ask you to start a channel update immediately. Select **Yes** and press **OK**. This may take a few minutes. If you want to postpone the channel update, you can do it later with **Setup > Search for satellite > Update channels**.

7 - After the channel update is done, the missing channels should be back at their former position in the satellite channel list.

Unicable setup

The Unicable system

You can use a Unicable system to connect the antenna dish to the TV. A Unicable system uses one cable to connect the satellite dish to all satellite receivers in its system. Unicable is typically used in apartment buildings. If you use a Unicable system, the TV will ask you to assign a user band number and corresponding frequency during the installation. You can install 1 or 2 satellites with Unicable on this TV.

If you notice some missing channels after a Unicable installation, another installation might have been done at the same moment on the Unicable system. Do the installation again to install the missing channels.

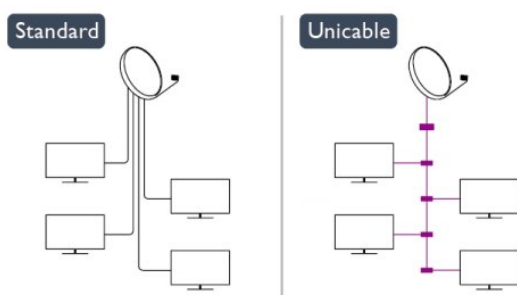

User band number

In a Unicable system, each connected satellite receiver must be numbered (e.g. 0, 1, 2 or 3 etc.).

You can find the available user bands and their number on the Unicable switchbox. User band is sometimes shortened as UB. There are Unicable switchboxes that offer 4 or 8 user bands. If you select Unicable in the settings, the TV will ask you to assign the unique user band number for its built-in satellite receiver. A satellite receiver cannot have the same user system band number as another satellite receiver in the Unicable system.

User band frequency

Next to the unique user band number, the built-in satellite receiver needs the frequency of the selected user band number. These frequencies are mostly shown next to the user band number on a Unicable switchbox.

Add a satellite

You can add an additional satellite to your current satellite installation. The installed satellites and their channels remain untouched. However, some satellite operators do not allow adding a satellite.

The additional satellite should be seen as an extra, it is not your main satellite subscription or not the main satellite of which you use its channel package. Typically, you would add a 4th satellite when you have 3 satellites already installed. If you have 4 satellites installed, you might consider removing one first to be able to add a new satellite.

Settings

If you currently have only 1 or 2 satellites installed, the current installation settings might not allow adding an extra satellite. If you need to change the installation settings, you must redo the complete satellite installation. You cannot use **Add satellite** if a change of settings is needed.

To add a satellite . . .

1 - Press **⬆** and select **Setup** and press **OK**.

2 - Select **Search for satellite** and press **OK**.

3 - Select **Add satellite** and press **OK**. The current satellites are shown.

4 - Select **Add** and press **OK**. The TV will search for new satellites.

5 - If the TV has found one or more satellites, select **Install** and press **OK**. The TV installs the channels of the found satellites.

6 - To store the channels and radio stations, select **Finish** and press **OK**.

Remove a satellite

You can remove one or more satellites from your current satellite installation. You remove the satellite and its channels. However, some satellite operators do not allow removing a satellite.

To remove satellites . . .

- 1 - Press **▲** and select **Setup** and press **OK**.
- 2 - Select **Search for satellite** and press **OK**.
- 3 - Select **Remove satellite** and press **OK**. The current satellites are shown.
- 4 - Use the arrows keys to select the satellite you want to remove.
- 5 - Press **OK** to mark a satellite to remove. Press **OK** again to unmark.
- 6 - Select **Remove**, press **OK** and confirm. The satellites are removed.
- 7 - Select **Exit** and press **OK** to close Remove satellite.

Reorder and rename channels

You can reorder and rename satellite channels.

Reorder

You can only reorder channels in the Favourites list. For more information on Reordering satellite channels, press **■** **Keywords** and look up **Satellite, reorder channels**.

Rename channels

You can rename channels in the channel list.

- 1 - Select the channel you want to rename in one of the channel lists - **All**, **Favourites**, **Radio** or **New**.
- 2 - Press **■** **Rename**. You can enter text with the remote control keyboard or open the on-screen keyboard.

With the remote control keyboard

To delete a character, position the cursor behind the character and press **del**.

To enter a character, press the character on the keyboard.

When you are ready, press **OK** to select **Done**. Press **OK** again to finish renaming.

For more information on entering text, press **■** **Keywords** and look up **Remote control, keyboard**.

With the on-screen keyboard

To open the on-screen keyboard, place the cursor in the name text field and press **OK**.

To delete the character in front of the cursor, press **⬅** **Backspace**.

To enter a character, select the character with the arrow keys and press **OK**.

To select uppercase letters, press **■**.

To select numbers or special characters, press **■**.

When you are ready, press **➡** to close the on-screen keyboard.

To finish renaming, select **Done** and press **OK**.

Update satellite channels

Once a day, at 6 AM, the TV automatically updates the satellite channels. A channel update looks for new channels and adds them to the channel list. No longer available channels are removed and if a provider reorders its channel package, the channel list of the TV will be updated. The TV must be on standby to automatically update the satellite channels. Alternatively, you can do a channel update yourself at any moment.

New channels, found with the channel update, are marked with the letter N and collected in the channel list New. New channels are also added in the All channel list. New channels stay in the channel list New as long as you do not tune to them or mark them as a favourite.

Switch off the automatic channel update

You can completely switch off the TV at night to avoid a channel update. Alternatively, you can switch off the automatic update in the setup menu.

- 1 - Press **▲** and select **Setup** and press **OK**.
- 2 - Select **Satellite settings** > **Channel installation** > **Automatic channel update** and select **Off**.

Switch off the update for a specific satellite

- 1 - Press **▲** and select **Setup** and press **OK**.
 - 2 - Select **Satellite settings** > **Channel installation** > **Automatic update option**.
 - 3 - With the arrow keys, select the satellite you do not wish to update. Press **OK** to unmark the satellite.
 - 4 - Select **Done** and press **OK** to close the menu.
- The TV will not update the channels from the satellite you unmarked.

Start an update yourself

- 1 - Press **▲** and select **Setup** and press **OK**.
- 2 - Select **Search for satellite** and press **OK**.
- 3 - Select **Update channels** and press **OK**.
- 4 - If you want to check which satellites are set for updating, select **Settings** and press **OK**.
- 5 - With the arrow keys, mark or unmark the satellites for updating. Select **Done** and press **OK**.
- 6 - Select **Update** and press **OK**. The update may take a few minutes.
- 7 - Select **Finish** and press **OK**.

Languages and audio

Preferred languages and subtitles

Satellite channels can hold different audio languages, subtitle languages or Text languages. You can set the TV to automatically switch to the language, subtitle language or Text language you prefer, if this language is available on the channel or Text pages.

To set the your preferred language . . .

- 1 - Press **⏠** and select **Setup** and press **OK**.
- 2 - Select **Satellite settings** and press **OK**.
- 3 - Select **Languages** and press **OK**. Select the setting you want.
- 4 - Press **⏪**, repeatedly if necessary, to close the menu.

Hearing impaired audio

Some digital TV channels broadcast special audio and subtitles adapted for hearing impaired people.

With Hearing impaired switched on, the TV automatically switches to the adapted audio and subtitles, if available. Before you can switch on Hearing impaired, you have to switch on **Universal access**.

Switch on

To switch on Hearing impaired, press **≡ OPTIONS**, select **Universal access** and press **OK**. Select **Hearing impaired**, select **On** and press **OK**.

To check whether a hearing impaired audio language is available, press **≡ OPTIONS**, select **Audio language** and look for an audio language marked with a **⦿+**.

If Universal access does not appear in the Options menu, switch on **Universal access** in Setup.

For more information, press **— Keywords** and look up **Universal access**.

Audio description

Switch on

Digital TV channels can broadcast special audio commentary describing what is happening on screen. To be able to set the Audio description audio and effects, you have to switch on Audio description first. Also, before you can switch on Audio description, you have to switch on **Universal access**.

Audio description

With Audio description, a narrator's commentary is added to the normal audio.

To switch on the commentary (if available) . . .

- 1 - With **Universal access** switched on, press **≡ OPTIONS** and select the **Options** tab in the menu bar.
- 2 - Select **Audio description** and press **OK**.
- 3 - Select **On** and press **OK**.

You can check if an audio commentary is available.

In the **Options** menu, select **Audio language** and look for an audio language marked with a **⦿+**.

Speakers / Headphones

You can select where you want to hear the audio commentary. On the TV speakers only, on the headphones only or on both.

To set Speakers / Headphones . . .

- 1 - Press **⏠** and select **Setup** and press **OK**.
- 2 - Select **Satellite settings** > **Languages** > **Audio description** > **Speakers / Headphones** and press **OK**.
- 3 - Select **Speakers**, **Headphones** or **Speakers + headphones** and press **OK**.
- 4 - Press **⏪**, repeatedly if necessary, to close the menu.

Mixed volume

You can mix the volume of the normal audio with the audio commentary.

To mix the volume . . .

- 1 - Press **≡ OPTIONS** and select the **Options** tab in the menu bar.
- 2 - Select **Universal access** > **Mixed volume** and press **OK**.
- 3 - Use the arrows up and down to set the slider bar.
- 4 - Press **OK** to confirm.

Audio effect

Some audio commentary can hold extra audio effects, like stereo or fading sound.

To switch on Audio effects (if available) . . .

- 1 - Press **⏠** and select **Setup** and press **OK**.
- 2 - Select **Satellite settings** > **Languages** > **Audio description** > **Audio effects** and press **OK**.
- 3 - Select **On** or **Off** and press **OK**.
- 4 - Press **⏪**, repeatedly if necessary, to close the menu.

Speech

The audio commentary can also hold subtitles for the words which are spoken.

To switch on these subtitles (if available) . . .

- 1 - Press **⏠** and select **Setup** and press **OK**.
- 2 - Select **Satellite settings** > **Languages** > **Audio description** > **Speech** and press **OK**.
- 3 - Select **Descriptive** (audio) or **Subtitles** and press **OK**.
- 4 - Press **⏪**, repeatedly if necessary, to close the menu.

Manual installation

Manual installation is intended for expert users.

You can use Manual installation to quickly add new channels from a satellite transponder. You need to know the frequency and polarization of the transponder. The TV will install all channels of that transponder. If the transponder was installed before, all its channels - the former and the new ones - are moved to the end of the channel list All.

You cannot use Manual installation if you need to change the number of satellites. If this is needed, you have to do a complete installation with Install satellites.

To install a transponder . . .

1 - Press **Home** and select **Setup** and press **OK**.

2 - Select **Satellite settings** > **Channel installation** > **Manual installation** and press **OK**.

3 - If you have more than 1 satellite installed, select the satellite/LNB for which you want to add channels.

4 - Set the **Polarization** you need. If you set the **Symbol rate mode** to **Manual**, you can enter the symbol rate in **Symbol rate** manually. Enter the **Frequency** and start searching for the transponder.

5 - If a transponder is found, select **Store** and press **OK** to store the new transponder on the selected LNB.

6 - Select **Exit** to leave the manual installation.

8.7

Problems with satellites

The TV cannot find the satellites I want or the TV installs the same satellite twice

- Make sure that the correct number of satellites is set in Settings at the start of the installation. You can set the TV to search for One, Two or 3/4 satellites.

A dual head LNB cannot find a second satellite

- If the TV finds one satellite but cannot find a second one, turn the dish a few degrees. Align the dish to get the strongest signal on the first satellite. Check the signal strength indicator of the first satellite on screen. With the first satellite set at the strongest signal, select Search again to find the second satellite.
- Make sure the settings are set to Two satellites.

Changing the installation settings did not solve my problem

- All settings, satellites and channels are only stored at the end of the installation when you finish.

All satellite channels are gone

- If you use a Unicable system, make sure you assigned a unique user band number to the satellite receiver in the Unicable settings. It might be that another satellite receiver is using the same user band number.

Some satellite channels seem to have disappeared from the channel list

- If some channels seem to be gone or displaced, the broadcaster might have changed the transponder location of these channels. To restore the channel positions in the channel list, you can try an update of the channel package.

I cannot remove a satellite

- Subscription packages do not allow removing a satellite. To remove the satellite, you have to do a complete installation again and select another package.

Sometimes the reception is poor

- Check if the satellite dish is solidly mounted. Strong winds can move the dish.
- Snow and rain can degrade the reception.

Home menu

From the Home menu, you can start any activity you can do with the TV.

Open the Home menu to start watching TV or start watching a disc on your Home Theatre System. Also in the Home menu, you can open Smart TV to surf the Internet, start Skype or open Help if you need information on using the TV.

Open the Home menu

- 1 - To open the Home menu, press **HOME**.
- 2 - Select an activity using the arrow keys and press **OK** to start the activity.
- 3 - To close the Home menu without changing the current activity, press **BACK**.



- **Help**

Select **Help** and press **OK** to open the on screen Help. You can look up a topic in an alphabetical list.

- **Setup**

Select **Setup** to install channels or adjust all TV settings.

- **Satellite**

Select **Satellite** and press **OK** to watch satellite channels (only for TVs with a built-in satellite tuner).

- **TV**

Select **TV** and press **OK** to watch TV channels.

- **Smart TV**

Select **Smart TV** and press **OK** to open the Smart TV start page. (only for Smart TVs)

- **Source**

Select **Source** and select a connected device in the list underneath the icon. Press **OK** to switch to the selected device.

- **TV guide**

Select **TV guide** and press **OK** to open a list of the current and scheduled TV programmes of your channels.

- **Recordings**

Select **Recordings** and press **OK** to open the list of your recordings.

- **Skype**

Select **Skype** to make video calls for free. (only for Smart TVs)

- **Demo**

Select **Demo** to watch demonstration videos.

TV guide

10.1

What you need

With the TV guide you can view a list of the current and scheduled TV programmes of your channels. Depending on where the TV guide information (data) is coming from, analogue and digital channels or only digital channels are shown. Not all channels offer TV guide information.

The TV can collect TV guide information for the channels that are installed on the TV (e.g the channels you watch with Watch TV). The TV cannot collect the TV guide information for channels viewed from a digital receiver.

10.2

Using the TV guide

Open the TV guide

To open the TV guide, press **≡ TV GUIDE**.

Press **≡ TV GUIDE** again to close.



The first time you open the TV guide, the TV scans all TV channels for programme information. This may take several minutes. TV guide data is stored in the TV.

Tune to a programme

Switch to a programme

From the TV guide, you can switch to a current programme. To select a programme, use the arrow keys to highlight the programme name.

Navigate to the right to view programmes scheduled later that day.

To switch to the programme (channel), select the programme and press **OK**.

View programme details

To call up the details of the selected programme, press **ⓘ INFO**.

Change day

The TV guide can show scheduled programmes for the upcoming days (maximum up to 8 days).

If the TV guide information comes from the broadcaster, you can press **≡ +** to view the schedule of one of the next days. Press **≡ -** to go back to the previous day.

Alternatively, you can press **≡ OPTIONS** and select **Change day**.

Select **Previous day**, **Today** or **Next day** and press **OK**, to select the day of the schedule.

Set a reminder

You can set reminders that alert you of the start of a programme with a message on screen.

- To set a reminder, select the programme in the schedule and press **■** for **Set reminder**. The programme is marked with a clock.
- To cancel the reminder, press the **■** for **Clear reminder**.
- To view a list of all reminders you have set, press **≡ OPTIONS**, and select **All reminders**.

Search by genre

If the information is available, you can look up scheduled programmes by genre like movies, sports, etc.

To search for programmes by genre, press **≡ OPTIONS** and select **Search by genre**.

Select a genre and press **OK**. A list with the found programmes appears.

10.3

Recordings

From the TV guide, you can instantly record or schedule a recording of a TV programme. To store the recordings, connect a USB Hard Drive to the TV.

For more information on Recording, press **■ Keywords** and look up **Recording**.

Sources

11.1

Sources list

In the list of connections - the Source menu - you can find the devices connected to the TV. From this Source menu, you can switch to a device.

Sources menu

To open the Sources menu, press **SOURCES**.

To switch to a connected device, select the device with the arrows **◀** (left) or **▶** (right) and press **OK**.

For some devices (HDMI-CEC devices), you can select an activity directly in the list underneath the device icon.

Select the device and select an activity and press **OK**.

To close the Source menu without switching to a device, press **SOURCES** again.



Automatic detection

When you connect a new device to the TV, the device is detected automatically and put in the Sources menu. The device is shown as an icon (the device type) and has a name. If the device type does not correspond with the device, e.g. the TV says it is a player but it is not, you can change the type.

To change the type of the device, press **Change type** and select a type that fits the device and press **OK**.

If the name does not fit the device or you want to give the device a name of your own, press **Rename**. Use the remote control keypad to enter a new name.

An appropriate device type helps you in using the device. The device type determines picture and sound styles, resolution values, specific settings or the position within the Sources menu.

When you connect a new device to the TV, the icon of the device jumps to the front of the Sources menu.

If the TV does not detect the device automatically, select the connection you used to connect the device and adjust the Device type and name.

Original name and icon

To restore the device icon to its original name and type icon, press **OPTIONS**. Select **Original name and icon** and press **OK**.

Scan connections

To rescan all TV connections and update the Sources menu, press **OPTIONS**. select **Scan connections** and press **OK**.

11.2

From standby

With the TV in standby, you can switch on a connected device with your TV remote control.

Play

To switch on both disc player and TV from standby and start playing the disc or programme immediately, press **▶** (play) on the TV remote control.

The device should be connected with an HDMI cable and both TV and device must have HDMI CEC switched on.



Home Theatre System

You can switch on your Home Theatre System to listen to an audio disc or a radio channel and leave the TV in standby.

To only switch on the HTS, with the TV in standby, press **SOURCES** on the TV remote control.



11.3

EasyLink

With **EasyLink** you can operate a connected device with the TV remote control. EasyLink uses HDMI CEC to communicate with the connected devices. Devices must support HDMI CEC and must be connected with an HDMI connection.

For more information, press **Keywords** and look up **EasyLink**.

Timers and clock

12.1

Sleeptimer

With the sleep timer, you can set the TV to switch to standby automatically after a preset time.

To set the sleep timer . . .

- 1 - Press **⏠** and select **Setup** and press **OK**.
- 2 - Select **TV settings > General settings > Sleep timer**.
With the slider bar you can set the time to up to 240 minutes in increments of 30 minutes. If set to **Off**, the sleep timer is switched off. You can always switch off your TV earlier or reset the time during the countdown.
- 3 - Press **↩**, repeatedly if necessary, to close the menu.

12.2

Clock

To know what time it is, press **≡ TV GUIDE** to find the time in the TV guide.

In some countries, digital broadcasts do not send UTC - Coordinated Universal Time information. The daylight saving change might be ignored and the TV might show an incorrect time.

To correct the TV clock . . .

- 1 - Press **⏠** and select **Setup** and press **OK**.
- 2 - Select **TV settings > General settings > Clock > Auto clock mode**, and select **Country dependent**.
- 3 - Select **Daylight saving** and select the appropriate setting.
- 4 - Press **↩**, repeatedly if necessary, to close the menu.

To set the TV clock manually . . .

- 1 - Press **⏠** and select **Setup** and press **OK**.
- 2 - Select **TV settings > General settings > Clock > Auto clock mode**, and select **Manual**.
- 3 - Select **Day** and **Time** to adjust.
- 4 - Press **↩**, repeatedly if necessary, to close the menu.

12.3

Switch off timer

If you do not press a key on the remote control during a 4 hour period, or if the TV receives no input signal nor remote control commands for 10 minutes, the TV switches off automatically to save energy.

If you use the TV as a monitor or use a digital receiver to watch TV (a Set-top box - STB) and you do not use the remote control of the TV, you should deactivate the automatic switch

off.

To deactivate the **Switch off timer** . . .

- 1 - Press **⏠** and select **Setup** and press **OK**.
- 2 - Select **TV settings > General settings > Switch off timer** and set the slider bar to **Off**.
- 3 - Press **↩**, repeatedly if necessary, to close the menu.

For more information on environmentally friendly TV settings, press **— Keywords** and look up **Eco settings**.

3D

13.1

3D

- Only for TVs with 3D function.
-

13.2

What you need

For Active 3D sets

This is an Active 3D TV. On this TV, you can watch 3D programmes and movies in full High Definition resolution with Active 3D.

To watch 3D you need to :

- Tune to a TV channel that broadcasts programmes in 3D.
- Rent a movie in 3D from an online video store with Smart TV.
- Watch a movie in 3D from a 3D Blu-ray Disc, a USB device or computer.

Also, to watch 3D on this TV, you will need one of these types of Philips Active 3D glasses. . .

- PTA507
 - PTA508
 - PTA509
 - PTA517
 - PTA518
 - PTA519
-

For Passive 3D sets

This is a Passive 3D TV.

To watch 3D you need to :

- Tune to a TV channel that broadcasts programmes in 3D.
- Rent a movie in 3D from an online video store with Smart TV.
- Watch a movie in 3D from a 3D Blu-ray Disc, a USB device or computer.

You can view photos in Ultra HD resolution in 3D, from a USB connection.

13.3

The 3D glasses

For Active 3D sets

Overview

- 1 - On or off switch
- 2 - Player 1 or player 2 selection
- 3 - Receiver lens
- 4 - Battery compartment

When you unpack the 3D glasses, also remove the small plastic foil from the battery compartment that prevents the battery from running empty.

Switch on and off

Switch on

When a 3D programme is shown on screen, press **⏻** on the 3D glasses and put them on. The glasses need some seconds to adjust to the 3D signal from the 3D transmitter on the TV. At first use, this may take up to 15 seconds.

Battery level

You can check the battery level when you switch on the 3D glasses.

- If the LED light blinks green, you can use the glasses for 4 hours or more.
- If the LED light blinks orange, you can use the glasses for at least 2 hours but less than 4.
- If the LED light blinks red, the battery is almost empty and less than 2 hours of 3D watching remain.

Switch off

To switch off the 3D glasses, press **⏻**. The LED light blinks red 4 times. When the 3D glasses do not receive 3D signals for 2 minutes, the glasses switch off automatically.

3D transmitter

3D transmitter

Make sure the receiver lens in the centre of the glasses can receive the 3D signals. Also, clear objects away from the 3D transmitter on the TV.

- 1 - 3D transmitter on the TV
 - 2 - 3D receiver on the 3D glasses
-

Two-player gaming

Two-player gaming

You can use these glasses to play two-player games. Two players can watch the same TV but see two different screens to play a game.

To switch the glasses to watch the Player 1 or Player 2 screen,

switch on the glasses and then press the **Player 1/2** key.

- If the LED light is orange and lites continuously for 2 seconds, the glasses are set for player 1.
- If the LED light is orange and blinks, the glasses are set for player 2.

For more information, press  **Keywords** and look up **Two-player gaming**.

Replacing the batteries

To replace the battery of the 3D glasses PTA508, unscrew the small battery lid and replace the battery: type CR2032 (3V). Make sure the + side of the battery is visible. Replace the lid and fix it with the screw.

To replace the battery of the 3D glasses PTA509, PTA51, press the small knob on the battery lid and slide the lid up to open. Replace the battery: type CR2032 (3V). Make sure the + side of the battery is visible. Replace the lid and slide it down until it clicks.

Warning

Danger of explosion if the battery is incorrectly replaced. Replace only with the same or equivalent type.

For Passive 3D sets

When a 3D programme is shown on screen, simply put on the 3D glasses to watch the programme in 3D.

Recommended viewing height

For best picture quality, when watching passive 3D, your eyes should be level with the centre of the screen.

13.4

Care of the 3D glasses

- Do not use cleaning chemicals containing alcohol, solvent, surfactant, or wax, benzene, thinner, mosquito repellent or lubricant. Using these chemicals can cause discoloration or cracks.
- Do not expose the 3D glasses to direct sunlight, heat, fire or water. This may result in a product malfunction or fire.
- Do not drop, bend or apply force to the lenses of the 3D glasses.
- Use a clean soft cloth (microfiber or cotton flannel) to clean the lenses to avoid scratching them. Never spray cleaner directly onto the 3D glasses. This may damage the electronics (for Active 3D glasses).

13.5

Watch 3D

To experience the best 3D effect while you watch 3D programmes:

- Sit at a distance that is at least three times the width (w) of the TV screen.
- Do not sit more than 6m away.

3D switching

The first time a 3D signal is detected, you can set your preference on how to start 3D in the future.

- To switch to 3D automatically, select **Automatic**.
- To show a notification first, select **Notification only**.
- To never switch to 3D, select **Never**.

You can still change this preference in  > **Setup** > **TV settings** > **3D** > **Switch to 3D**.

Start 3D

When the TV switches to 3D or when a notification is shown that 3D is available, put on your 3D glasses.

If the TV cannot detect the 3D signal (the 3D signal tag is missing), the 3D programme is shown as a double image on screen. To switch to 3D, adjust the 3D settings and select Side by side or Top / bottom according to the double image positions.

Stop 3D

To stop watching 3D, press , select 3D settings and select Off. 3D is switched to 2D when you switch to another channel or connected device.

2D to 3D conversion

You can convert any 2D programme to watch it in 3D.

- 1 - Press .
- 2 - Select **Picture and sound** > **3D settings** > **2D to 3D conversion**.

To adjust the 3D depth...

- 1 - Press .
- 2 - Select **Picture and sound** > **3D effect**.
- 3 - Select an option, then press **OK**.

To switch off 2D to 3D conversion...

- 1 - Press .
- 2 - Select **Picture and sound** > **3D settings** > **2D**, then press **OK**.

Note: If you switch to another activity, the conversion stops.

You can change the depth of 3D for a weaker or stronger 3D effect in the 2D to 3D conversion. To change the 3D effect, press  and select **3D effect**. Select **Off** (no 3D), **Less** (less 3D depth), **Normal** (optimal 3D quality) or **More** (more 3D depth).

Optimal 3D viewing

For an optimal 3D viewing experience, we recommend that you:

- sit at least 3 times the height of the TV screen away from the TV, but no further than 6 meters away.
- avoid fluorescent lighting (such as TL lighting or certain energy saving light bulbs which operate on a low frequency) and direct sunlight as they may interfere with the 3D experience.

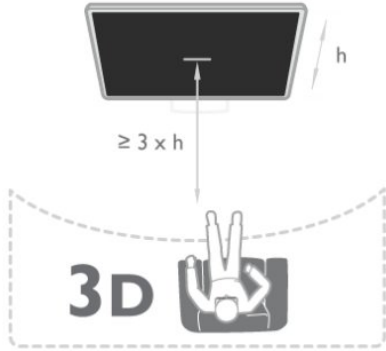

Health warning

- Watching 3D is not recommended for children under the age of six.
- If you or your family have a history of epilepsy or photosensitive seizures, consult a medical professional before exposing yourself to flashing light sources, rapid image sequences or 3D viewing.
- If you experience any discomfort, stop watching 3D and do not immediately engage in any potentially hazardous activity (for example driving a car) until your symptoms have disappeared. If symptoms persist, do not resume watching 3D without consulting a medical professional first.
- To avoid discomfort such as dizziness, headache or disorientation, we recommend not watching 3D for extended periods of time.
- Do not use the 3D glasses for any purpose other than watching 3D TV.
- If you normally wear corrective glasses or use contact lenses, wear the 3D glasses together with these glasses or lenses.
- Keep the glasses away from small children to avoid the swallowing of small parts or batteries.
- Parents should monitor their children during 3D viewing and ensure they do not experience any discomfort as mentioned above. Watching 3D is not recommended for children under six years of age as their visual system is not fully developed yet.
- Avoid the use of the 3D glasses in case of eye infection or other diseases transmitted by contact (e.g. conjunctivitis, head lice, etc.). Only start using the 3D glasses again when the infection has disappeared completely.

Games

14.1

Play a game

With a game console connected to the TV, you can play games on TV.

For more information on connecting a game console, press

➔ **Keywords** and look up **Game console, connect**.

Start a game

- 1 - Switch on the game console.
- 2 - Press **Home**, select the game console and press **OK**.
- 3 - Start the game.

Ideal game setting

For some games, where speed and precision is needed, set the TV to the ideal **Game** setting before you start playing.

If your game console is added as a **Game** type of device in the Sources menu (list of connections), the TV is set to the ideal Game setting automatically.

If the type of your game console is set as **Player** and used as a disc player most of the time, leave the device type set to **Player**.

To set the TV to the ideal setting manually . . .

- 1 - Press **Home** and select **Setup** and press **OK**.
- 2 - Select **TV settings** > **Picture** > **Advanced** > **Activity style** and press **OK**.
- 3 - Select **Game** and press **OK**.
- 4 - Press **Back**, repeatedly if necessary, to close the menu. Remember to set the Game or computer setting back to Off when you stop playing the game.

14.2

Two-player games

For Active 3D sets

About two-player gaming

If you play a multi-player game with split screens, you can set the TV to show each screen as a full screen. Each player sees only his part of the game, full screen. The TV uses 3D technology to show both screens.



What you need

To play a two-player game with this TV, you need 2 active 3D glasses - Philips PTA507, PTA508, PTA509, PTA517, PTA518 or PTA519.

Also, the game console must be connected with HDMI.

Play a two-player game

To start a two-player game . . .

- 1 - Press **SOURCES**, select the game console and press **OK**.
- 2 - On the game console, start the game and select the multi or two-player mode. Select the mode for split screen viewing.
- 3 - On the TV, press **OPTIONS**, select **Picture and sound**, select **Two-player gaming** and press **OK**.
- 4 - Select the format in which the split screen game is shown on screen, **Side by side** or **Top / bottom** and press **OK**. The TV shows the 2 screens as full screens.

To watch the 2 different screens, put on the 3D glasses.

To switch the glasses to watch the Player 1 screen or Player 2 screen, press the **Player 1/2** selection key on the glasses.

In and out of split screen view

In two-player split screen view, you can switch back and forth from split screen to combined view, to be able to read the game menu or game scores.

To switch views back and forth, press **OK** on the remote control of the TV.

Stop a Two-player game

To stop the two-player split screen view, press **Home** and select another activity.

For Passive 3D sets

About two-player gaming

If you play a multi-player game with split screens, you can set the TV to show each screen as a full screen. Each player sees only his part of the game, full screen. The TV uses 3D technology to show both screens.

To view the two different full screen pictures, you need a pair of 3D glasses for each player.

What you need

To play a two-player game with this TV, you need a two-player kit with 2 passive 3D glasses - Philips **PTA436** (sold separately).

Also, the game console must be connected with HDMI.

Play a two-player game

To start a two-player game . . .

- 1 - Press **SOURCES**, select the game console and press **OK**.
- 2 - On the game console, start the game and select the multi or

two-player mode. Select the mode for split screen viewing.

3 - On the TV, press **≡** **OPTIONS**, select **Picture and sound**, select **Two-player gaming** and press **OK**.

4 - Select the format in which the split screen game is shown on screen, **Side by side** or **Top / bottom** and press **OK**. The TV shows the 2 screens as full screens.

To watch the 2 different screens, put on the 3D glasses.

To switch the glasses to watch the Player 1 screen or Player 2 screen, press the **Player 1/2** selection key on the glasses.

In and out of split screen view

In two-player split screen view, you can switch back and forth from split screen to combined view, to be able to read the game menu or game scores.

To switch views back and forth, press **OK** on the remote control of the TV.

Stop a Two-player game

To stop the two-player split screen view, press **🏠** and select another activity.

Your photos, videos and music

15.1

From a USB connection or network computer

What you need

You can view your photos or play your music and videos from a connected USB flash drive or USB Hard Drive. If you have a computer in your home network, you can view and play your files from your computer on the TV.

From a USB device

With the TV switched on, plug in a USB flash drive or USB Hard Drive to one of the USB connections. The TV detects the device and lists your files.

If the list does not appear automatically, press **SOURCES**, select **Browse USB** and press **OK**.



Warning

If you try to pause or record a programme with a USB Hard Drive connected, the TV will ask you to format the USB Hard Drive. This formatting will delete all current files on the USB Hard Drive.

From a computer

If the TV and the computer are in the same network, the TV can browse and play files stored on your computer.

On your computer, you need to install media server software like Twonky™ to share your files with the TV. The TV shows your files and folders as they are organised on your computer. To browse the files on your computer, press **SOURCES**, select **Browse network** and press **OK**.

Menu bar and sorting

With a USB device connected, the TV sorts the files by type. Navigate to the menu bar and select the type of file you are looking for.

If you browse files from a computer, you can only browse the files and folders as they are organized on the computer.

The menu bar

Navigate to the menu bar and select the type of file you want to watch or play.

Select **Photos**, **Music** or **Videos**. Alternatively, you can open the **Folders** view and browse your folders to look for a file.

Sorting

To browse your photos by date, month, year or alphabetically by name, press **Sort**.

To browse your music by album, artist, genre or alphabetically by name, press **Sort**.

Videos are sorted alphabetically.

View photos

To view photos, select **Photos** in the menu bar, select a photo thumbnail and press **OK**.

If there are several photos in the same folder, select a photo and press **Slide show** to start a slide show of all photos in this folder.

To jump to the next or previous photo, press **+** or **-**.

To stop the slide show or close the photo, press **LIST** or **Stop**.

You can play music with a slide show.

Start the slide show after you started the music.

1 - Select a song or a folder with songs and press **OK**.

2 - Press **LIST** and select **Photos**.

3 - Select a photo or a folder with photos and press **Slide show**.

Info

To view info on a photo (size, creation date, file path, etc.), select a photo and press **INFO**.

Press again to hide the info.

Options

Press **OPTIONS**.

• Shuffle

Shows your photos in a random order.

• Repeat

Plays the slide show continuously.

• Slide show speed

Sets the speed of the slide show.

• Slide show transition

Sets the style of the photo transitions.

To close **Browse USB** or **Browse network**, press **Home** and select another activity.

Play music

To play music, select **Music** in the menu bar, select a song and press **OK**.

If there are more songs in the same folder, press **Play all** to play all songs in this folder.

To jump to the next or previous song, press **+** or **-**.

To pause the music, press **OK**. Press **OK** again to continue.

To make a 10-second jump in a song or 10-second jump back, press **▶** or **◀**.

To rewind or fast forward, press **▶▶** or **◀◀**. Press the keys several times to speed up - 2x, 4x, 8x, 16x, 32x.

To stop the music playback, press **■** (Stop).

If you press **LIST** or **↶**, the music keeps on playing.

Info

To view song info (title, artist, duration, etc.), select the song and press **INFO**.

Press again to hide the info.

Options

Press **OPTIONS**.

- **Shuffle**

Plays your music randomly.

- **Repeat**

Plays the song once or continuously.

- **Screen off**

If you only listen to music, you can switch off the TV screen to save energy.

To switch off the screen, press **OPTIONS**, select **Eco settings** in the menu bar, select **Screen off** and press **OK**. To switch the screen back on, press any key on the remote control.

To close **Browse USB** or **Browse network**, press **Home** and select another activity.

Play videos

To play a video, select **Videos** in the menu bar, select a video and press **OK**.

If there are more videos in the same folder, press **Play all** to play all videos in this folder.

To jump to the next or previous video, press **+** or **-**.

To pause the video, press **OK**. Press **OK** again to continue.

To make a 10-second jump forward or backward in a video, press **▶** or **◀**.

To rewind or go fast forward, press **▶▶** or **◀◀**. Press the keys several times to speed up - 2x, 4x, 8x, 16x, 32x.

To stop the video playback, press **□** (Stop).

Info

To view info on a video (playhead position, duration, title, date, etc.), select the video and press **INFO**.

Press again to hide the info.

Options

Press **OPTIONS**.

- **Subtitles**

If available, you can switch subtitles **On**, **Off** or **On during mute**.

- **Shuffle**

Plays your videos in a random order.

- **Repeat**

Plays a video once or continuously.

To close **Browse USB** or **Browse network**, press **Home** and select another activity.

15.2

Wi-Fi Miracast

About Wi-Fi Miracast

Your TV is a **Wi-Fi Certified Miracast™** device. With Miracast™, you can watch and share the screen of your smartphone, tablet or computer on your TV screen wirelessly. You can stream videos (audio and video), share photos or anything else that's on screen of the device. No need to connect the device to your home network. Both the TV and the device must be Wi-Fi Certified Miracast™ devices and have Miracast switched on.



For more information on Wi-Fi Certified Miracast™ go to www.wi-fi.org

Wi-Fi®, the **Wi-Fi CERTIFIED** logo, the **Wi-Fi** logo are registered trademarks of the Wi-Fi Alliance. **Wi-Fi CERTIFIED Miracast™**, **Miracast™** are trademarks of the Wi-Fi Alliance.

Switch on Miracast

The TV comes with Miracast switched On and is ready to show the screen of a device with Miracast.

Switch off Miracast

If you do not want the TV to receive requests for screen sharing from other devices, you can switch off Miracast on the TV.

1 - Press **Home** and select **Setup** and press **OK**.

2 - Select **Network settings > Wi-Fi Miracast > Off** and press **OK**.

3 - Press **↶**, repeatedly if necessary, to close the menu.

Share a screen on TV

To share the screen of your smartphone, tablet or computer on the TV . . .

- 1 - Switch on the TV.
- 2 - On the device, open an application such as Wi-Fi Miracast, Wi-Fi Direct™, Intel®Wireless Display* or similar and start scanning for other Miracast devices.
- 3 - In the list of found devices, select the TV and connect.
- 4 - On the TV, agree to the request to connect to the TV. You might be asked to enter a PIN code from the device on the TV - enter the numbers with the digit keys on the remote control. Alternatively, you might be asked by the TV to enter a PIN code on the device. If you connect, the TV will show the screen of the device.
- 5 - On the device, select the videos, photos or files you want to watch on TV.

* Miracast is supported by WiDi 3.5 onwards.

Stop sharing

From the device

With the application you use to start Miracast, you can disconnect and stop watching the screen of the device on TV. The TV will switch back to the last selected programme.

From the TV

To stop watching the screen of the device on TV, you can . . .

- press **TV** to watch a TV broadcast
- press **Home** to start another activity on TV
- press **SOURCES** to open the Sources menu and select a connected device.

Block a device

The first time you receive a request to connect from a device, you can block the device. This request, and all requests in the future, from this device, will be ignored.

To block a device, select **Block** . . . in the request window and press **OK**.

Unblock all devices

All previously connected and blocked devices are stored in the Wi-Fi Miracast list of connections. If you clear this list, all blocked devices will be unblocked.

To unblock all blocked devices . . .

- 1 - Press **Home** and select **Setup** and press **OK**.
- 2 - Select **Network settings** > **Reset Wi-Fi direct group**.
- 3 - Press **OK** to clear the list.
- 4 - Press **Back**, repeatedly if necessary, to close the menu.

Blocking a previously connected device

If you want to block a device that you previously connected, you need to clear the Wi-Fi Miracast connections list first. If you clear this list, you will have to confirm or block the connection for every device again.

Screen delay

The normal delay when sharing a screen with Miracast is about 1 second. The delay might be longer if you are using older devices/computers with less processing power.

Specifics

- Miracast on this TV is subject to the HDCP protocol and cannot display copy-protected premium content sent by a device.
- The maximum video resolution supported is 720p.

Pause TV

You can pause a TV broadcast and resume watching it later. Only digital TV channels can be paused. You must connect a USB Hard Drive to buffer the broadcast. You can pause a broadcast for a maximum time span of 90 minutes.

For more information, press **— Keywords** and look up **USB Hard Drive**.

Pause or resume a broadcast

To pause a broadcast, press **⏸** (Pause). A progress bar appears briefly on screen.

To call up the progress bar, press **⏸** (Pause) again.

To resume watching, press **▶** (Play). The icon on screen indicates you are watching a paused broadcast.

Back to the actual TV broadcast

To switch back to the actual TV broadcast, press **■** (Stop).

The moment you switch to a digital channel, the USB Hard Drive starts buffering the broadcast. When you switch to another digital channel, the broadcast of the new channel is buffered and the broadcast of the former channel is cleared. When you switch to a connected device (a Blu-ray Disc player or digital receiver) the USB Hard Drive stops buffering and the broadcast is cleared. Also when you switch the TV to standby the broadcast is cleared.

Whilst recording a programme on the USB Hard Drive, you cannot pause a broadcast.

Instant replay

Whilst watching a broadcast from a digital TV channel, you can easily instant replay the broadcast.

To replay the last 10 seconds of a broadcast, press **⏸** (Pause) and press **◀** (Left).

You can press **◀** repeatedly until you reach the start of the broadcast buffer or the maximum time span.

Progress bar

With the progress bar on screen, press **◀◀** (Rewind) or press **▶▶** (Forward) to select from where you want to start viewing the paused broadcast. Press these keys repeatedly to change speed.

Specifics

- The Audio Description audio (commentary) for the visually impaired is not available for playback in Pause TV or Recording.
- You can buffer the digital (DVB) subtitles of a channel. You cannot buffer subtitles that come from Text services. To check if digital (DVB) subtitles are available, tune to the TV channel and press **≡** **OPTIONS**, select **≡ Options** in the menu bar and select **Subtitle language** to open the list of Subtitles. You can only buffer a subtitle language preceded by a **DVB** icon.

Recording

17.1

What you need

To record a TV programme you need . . .

- a connected USB Hard Drive formatted on this TV
- digital TV channels installed on this TV (the channels you watch with Watch TV)
- to receive channel information for the built-in TV guide (from the broadcaster or from the Internet)

For more information, press **— Keywords** and look up **USB Hard Drive, installation**.

17.2

Record a programme

Record now

To record the programme you are watching, press **● (Record)** on the remote control.

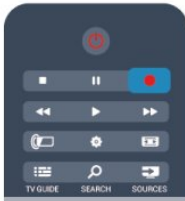

If you receive TV guide information from the Internet, you can adjust the end time of the recording in the pop-up window before you confirm the recording.

If you receive TV guide information from the broadcaster, the recording starts immediately. You can adjust the end time of the recording in the list of recordings.

To stop recording, press **■ (Stop)**.

Schedule a recording

You can schedule a recording of an upcoming programme for today or a few days from today (maximum of 8 days away).

1 - To schedule a recording, press **≡ TV Guide**.

On the TV guide page, select the channel and programme you wish to record.

You can enter the channel number to jump to the channel in the list.

Press **▶ (Right)** or **◀ (Left)** to scroll through the programmes of a channel.

To change the date of the list, press **≡ OPTIONS** and select **Select day**. In the list, select the day you want and press **OK**. If

the TV guide comes from the Internet, you can select the date at the top of the page and press **OK**.

2 - With the programme highlighted, press **— Record** or press **≡ OPTIONS** and select **Record**. The TV adds some time buffer at the end of the programme. You can add some extra buffer if needed.

3 - Select **Schedule** and press **OK**. The programme is scheduled for recording. A warning will appear / will be shown automatically when overlapping recordings are scheduled. If you plan to record a programme in your absence, remember to leave the TV switched to standby and the USB Hard Drive switched on.

List of recordings

To view the list of recordings and scheduled recordings, press **🏠**, select **📺 Recordings** and press **OK**.

In this list, you can select a recording to watch, remove recorded programmes, adjust the end time of an ongoing recording or check the free disk space. Also in this list, if the TV guide comes from the Internet, you can schedule a recording for which you set the beginning and end time yourself, as a timed recording not linked to a programme. To set a timed recording, select **Schedule recording** at the top of the page and press **OK**. Set the channel, date and time span. To confirm the recording, select **Schedule** and press **OK**.

Remove a scheduled recording

To remove a scheduled recording, select the upcoming recording in the list and press **OK**. Alternatively, you can select the scheduled recording and press **≡ OPTIONS** and select **Cancel recording**.

Specifics

- While recording a programme, you can watch a previously recorded programme.
- While recording, you cannot switch TV channels.
- While recording, you cannot pause the TV broadcast.
- To Record, broadcasters need a reliable clock setting. If you reset the TV clock manually, recordings may fail.
- The Audio Description audio (commentary) for the visually impaired cannot be recorded.
- You can record the digital (DVB) subtitles of channel. You cannot record subtitles that come from Text services. To check if digital (DVB) subtitles are available, tune to the TV channel and press **≡ OPTIONS**, select **≡ OPTIONS** in the menu bar and select **Subtitle language** to open the list of Subtitles. You can only record a subtitle language preceded by a **DVB** icon.

Watch a recording

To watch a recording . . .

- 1 - Press **Home**, select **Recordings** and press **OK**.
- 2 - In the list, select the recording and press **▶** (Play) to start the playback. You can use the **▶▶** (Forward), **◀◀** (Rewind), **⏸** (Pause) or **■** (Stop) keys on the remote control.

Expired recording

Broadcasters can limit the number of days a recording can be viewed. A recording in the list can show the number of days before it expires.

Failed recording

When a scheduled recording was prevented by the broadcaster or when the broadcast was interrupted, a recording is marked as **Failed**.

Delete a recording

To delete a made recording, select the recording in the list, press **≡** **OPTIONS** and select **Delete recording**.

For more information, press **→** **Keywords** and look up **Record a programme**.

Skype

18.1

About Skype

With **Skype™** you can make video calls on your TV for free. You can call and see your friends from anywhere in the world. Talk to your friends while watching them on the big screen of your TV.

18.2

What you need

To make a video call on Skype, you need the separately sold **Philips PTA317** TV camera with a built-in microphone and a good connection to the Internet.

Before you can start Skype, the TV must have a good quality connection to the Internet. You can connect your TV either wireless or wired.

For more information, press **— Keywords** and look up **Network, wireless**.

Skype account

To use Skype, you need to create a Skype account for yourself or for your family. You can create a new account for Skype on your TV or on your computer.

Skype Credit or Skype Subscriptions

With Skype, for a little cost, you can also call phones or mobile phones. Using your computer you can buy Skype Credit or take a Skype subscription at www.skype.com

No emergency calls

Skype is not a replacement for your telephone and cannot be used for emergency calling.

18.3

Start with Skype

Install the camera

Connect the TV camera cable to one of the USB connections on the TV.

Bend the small clamp as shown in the illustration below and position the camera on the top of the TV.

Point the camera to the position you usually sit at. When you are making a Skype call, you can pan, tilt or zoom in or out the camera image.

You can position the camera anywhere you want but it is recommended to put it away from the speakers of the TV.

If the TV camera is not connected, Skype will not start.

Sign in

Sign in to Skype with your **Skype Name** and **password**. If you don't have a Skype Name yet, you have to create a new Skype account.

To sign in to Skype...

- 1 - Press **⬆** to open the Home menu.
- 2 - Select **Skype** and press **OK** to start Skype and open the Sign in page.
- 3 - Select the **Skype Name** text field and enter your Skype Name. To open the on screen keyboard, select the text field and press **OK**. If you have signed in before, press **≡ LIST** and select your Skype Name. The TV remembers the 5 last Skype Names that signed in.
- 4 - Select the **Password** text field and enter your password.
- 5 - When done, select **Sign in** and press **OK**.

You are signed in if the Skype menu opens on screen.

Need help?

If you have forgotten your Skype Name or password, or are having problems signing in, please visit www.skype.com/support

New Skype account

If you don't have a **Skype Name** and **Password** yet, you can create a new Skype account on your computer. Once you have successfully created the new account, you can use your Skype Name and password to sign in on TV. To create a Skype account on your computer, go to www.skype.com

If you have a remote control with an integrated keyboard or have a USB keyboard connected to the TV, you can create a new Skype account on your TV.

To create a new account on your TV...

- 1 - On the Skype **Sign in** page, select **Create a new account** and press **OK**.
- 2 - On the next menu, select **Open browser** and press **OK**.
- 3 - The TV opens the web page of www.skype.com directly. You can create your new account on this web page.
- 4 - When Skype confirms that your new account is successfully created, leave the web browser and go back to the **Sign in** page of Skype on TV.
- 5 - Enter your **Skype name** and **Password** to sign in.

Skype Name

A Skype Name must begin with a letter, upper or lowercase. It must have 6 to 32 characters and can contain numbers. A Skype Name cannot contain a space.

Password

Your password must have 6 to 20 characters and must at least contain one letter or one number. It cannot contain special characters like a trademark, bullet or euro sign. A Skype

password cannot contain a space.

If you don't have a Skype Name and Password yet, you can create a new account on the sign in page on TV.

1 - On the sign-in page, select **New account** and press **OK**.

2 - Create your new account.

- Full name

Enter your full name.

- Skype name

Enter a name as your Skype name. Your Skype Name will be shown in the list of contacts of other Skype users. A Skype Name must begin with a letter, upper or lowercase. It must have 6 to 32 characters and can contain numbers. A Skype Name cannot contain a space.

- Password

Enter your password. Your password must have 6 to 20 characters and must at least contain one letter or one number. It cannot contain special characters like a trademark, bullet or euro sign. A Skype password cannot contain a space.

- Email

Enter your email address.

3 - Read and accept the Skype Terms of Use.

4 - If your new account was accepted, you are signed in.

You can edit or complete your Skype profile on your computer.

Start Skype on your computer, sign in with your Skype Name and Password and open your Skype profile. You can change your profile picture, add a mood message or set the privacy settings.

Microsoft account

If you have a Microsoft account, you can use this account to sign in to Skype on TV.

To sign in with a Microsoft account...

1 - On the Skype **Sign in** page, select **Sign in with Microsoft account** and press **OK**.

2 - Select **Next** and press **OK**. The TV will open the Microsoft account sign in web page.

3 - Enter your Microsoft account email and password.

4 - Select the **Submit** button and press **OK**.

No emergency calls

No emergency calls with Skype

Skype is not a replacement for your telephone and cannot be used for emergency calling.



18.4

Skype menu

When you have signed in successfully, Skype opens the **Skype menu**.

The Skype menu items are...

- **My profile - your Skype name**

To view or modify your Skype profile. Select your **Skype Name** and press **OK**.

- **People**

In **People**, you can start making a Skype call and manage your contacts.

- **Call phones**

In **Call phones**, you can call a landline or a mobile phone number by dialing the number on a dial pad. You must have **Skype Credit** or a **Skype subscription** to call a phone number. You can't select **Call phones** if a camera and microphone are not connected.

- **History**

In **History**, you can view your missed and former calls or view **Contact requests**.

- **Settings**

In **Settings**, you can change your password, set your privacy and voicemail settings or view your blocked contacts and much more.

- **Sign out**

To sign out of Skype on TV.

My profile

In **My profile**, you can edit your personal profile for Skype.

- **Public**

View or change your profile information that can be viewed by your contacts.

- **Phone**

You can enter or change your home, office or mobile phone number here.

- **Private**

View or change your email address, check the amount of credit you have or view the subscription information, or write a message that reflects your mood.

- **Profile picture**

If you did not upload a profile picture with your computer yet, you can select one of the available avatars as Profile picture here.

- **Online status**

You can change your online status. Select the status you want your contacts to see when you are online.

People

Your contacts

In **People**, you can find the list of your **Skype contacts**.

Your contacts are shown with their **Skype Name**. Contacts are online and available for a Skype call when a green dot is shown next their name.

You can use the text box in the top left corner of the contact page to search for a contact within your contact list. Or, simply scroll down the list to find the contact you want.

Add a contact

Add a Skype contact

In **People**, the list of your contacts, you can add a new Skype contact.

Add a Skype contact

If you know the Skype Name or email of a friend, Skype can

easily find your contact. If you do not know their Skype Name or email, you can also try to look for them by name.

To add a Skype contact...

- 1 - On the **Contacts** page, press **≡ OPTIONS**.
- 2 - Select **Add Skype Contact** and press **OK**.
- 3 - Enter a **Skype Name** or email address of your new contact. You can also try to enter a name. To open the on screen keyboard, press **OK**. When you're done, press **OK**.
- 4 - Skype will search for the contact you are looking for and will show the search results.
- 5 - Select the contact you want and press **OK** to send a contact request.
- 6 - Write the request and press **OK**. Skype will send the request message to your new contact. If the contact accepts the request, the Skype Name of the new contact will appear in the your list and you can call your contact on Skype.

Add a phone number

In **People**, the list of your contacts, you can add a phone number as a contact. You can call a phone with a Skype voice call. You need Skype Credits to make a phone call.

To add a phone number...

- 1 - On the **Contacts** page, press **≡ OPTIONS**.
- 2 - Select **Add a Phone Number** and press **OK**.
- 3 - Enter the name of your contact. To open the on screen keyboard, press **OK**. When you're done, press **OK**.
- 4 - Enter the phone number of your contact. Always start with a country code (e.g. +31 for The Netherlands). Do not use the double zero. When you're done, press **OK**. The name of your phone number contact will appear in your list.

Accept a contact request

When you receive a **Contact request**, a small icon will show next to **History** in the **Skype menu**.

To accept a contact request...

- 1 - In the **Skype menu**, select **History** and press **OK**.
- 2 - Select **Contact requests** and press **OK**. Select the request and press **OK**. Skype will ask you to accept this contact. If you accept, the contact will appear in your contact list.

Block a contact

You can **Block** a Skype contact. A blocked contact will be unable to contact you on Skype. A blocked contact will not be notified, you will appear as being offline in the contact list of the blocked contact. You can always unblock contacts you have blocked.

To block a contact...

1 - On the **Contacts** page, select the contact you want to block.
2 - Press **≡ OPTIONS** and select **Block** and press **OK**. The contact is blocked.

To unblock a contact...

1 - Select a contact that is blocked.
2 - Press **≡ OPTIONS** and select **Unblock** and press **OK**. The contact is unblocked.

To view a list of blocked contacts...

1 - In the **Skype menu**, select **Settings** and press **OK**.
2 - Select **Blocked contacts** and press **OK**. The list will show all contacts you have blocked.

Remove or rename

You can **Remove** or **Rename** contacts.

To remove a contact...

1 - On the **Contacts** page, select the contact you want to remove.
2 - Press **≡ OPTIONS** and select **Remove** and press **OK**. The contact is removed from the list.

To rename a contact...

1 - On the **Contacts** page, select the contact you want to rename.
2 - Press **≡ OPTIONS** and select **Rename** and press **OK**.
3 - Enter the new name for this contact in the text field. To open the on screen keyboard, press **OK**. When you're done, press **OK**.

18.7

Calling on Skype

Video or voice call

Make a Video call

Make a **Video call** to call and see your friends on your TV screen.

To make a Video call...

1 - On the **Contacts** page, select the contact you want to call.
2 - Select **Video call** and press **OK**. If your contact is on Skype, has a Skype camera connected and answers the call, you can see this person on TV.
3 - To end the call, select **↶ End call** and press **OK**.

When your Skype camera is switched on, a blue indicator LED lights up. You can check what your contact can see in the small screen on the bottom right of the TV screen.

To switch the Skype camera off, select **📴 Video Off** and press **OK**. To switch it back on, select **Video On** and press **OK**.

To mute your microphone, select **🔇 Mic Off** and press **OK**. To switch it back on, select **🔊 Mic On** and press **OK**.

While you are making a video call, you can change the viewpoint of the camera.

For more information on changing the viewpoint, press **—** **Keywords** and look up **Skype, camera zoom, pan and tilt**.

Make a Voice call

Make a **Voice call** to call without video, with the camera switched off.

To make a Voice call...

1 - On the **Contacts** page, select the contact you want to call.
2 - Select **Call** and press **OK**. If your contact is on Skype and answers the call, you can talk to your contact.
3 - To end the call, select **↶ End call** and press **OK**.

A contact can add you to a voice call with more than one participant. You cannot add an extra participant yourself.

Calling phones

With Skype you can also call landline phones and mobile phones. To call phones you need to buy Skype Credit or a Skype subscription.

To call a phone...

1 - On the **Contacts** page, select a phone number contact.
2 - Select **Call** and press **OK**. You must have **Skype Credits** available or have a Skype subscription to make a call with a phone number. If your contact answers the phone, you can talk to your contact.
3 - To end the call, select **↶ End call** and press **OK**.

With Skype, you can also call a phone number directly. You can enter the phone number with the dial pad.

To open the dial pad...

1 - In the **Skype menu**, select **Call phones** and press **OK**.
2 - If the dial pad is not on screen, select **☰ Show Dial Pad** and press **OK**.
3 - Dial the phone number. You can navigate to the numbers and press **OK** or use the number keys on the remote control.

No emergency calls

Skype is not a replacement for your telephone and cannot be used for emergency calling.

Receiving a call

When you are signed in to Skype and watching TV, a ringtone and a message on screen will alert you of an incoming call. The message will show who is calling and you can answer or decline the call.

To answer the call, select **Answer with video** and press **OK**.

To answer the call with the camera switched off, select **Answer with audio** and press **OK**.

To decline the call, select **Decline call** and press **OK**.

History

In the **History** page of the Skype menu, you will find a list of all calls you made, including the calls you missed. You can also see new contact requests and listen to voicemails.

To view a list, select **All calls**, **Missed calls**, **Incoming calls** or **Outgoing calls** and press **OK**.

To view new contact requests, select **Contact requests** and press **OK**.

To view and listen to your voicemails, select **Voicemails** and press **OK**.

For how long your Skype events are kept in this history list depends on the amount of contacts you have and how intensively you use Skype.

Voicemail

About Voicemail

If someone calls you on Skype and you do not take the call, he or she can leave a spoken message on your **Skype voicemail**. If you call a contact and they can't take the call, you can send a Skype voicemail to your contact.

To send a voicemail or to receive a voicemail, you - or your contact - must set up Skype voicemail first. You can set up Voicemail on your computer. Go to www.skype.com

When you made voicemail available for you on a computer, set your voicemail preferences in the **Skype menu > Settings > Voicemails**.

Record a Voicemail

When you call a contact and they can't take the call, you can leave a voicemail.

To record a voicemail...

1 - Call a contact. If your call was not answered, Skype will propose to send a **Voicemail**.

2 - Select **Yes** and speak your message.

3 - To stop recording, select **End call** and press **OK**.

Play a Voicemail

A contact can send a voicemail message to you. If a voicemail was sent to you, a small icon will show on the Skype menu. You can play a voicemail from the History page.

To play a voicemail...

1 - In the **Skype menu**, select **History** and press **OK**.

2 - Select **Voicemails** and press **OK**.

3 - Select the voicemail you want to play and press **OK**. You can listen to a voicemail as many times you want. To manage your voicemails, press **≡ OPTIONS**.

18.8

Skype credit

On Skype, you can buy Skype Credit or take a Skype subscription. With Skype Credit or a Skype subscription available, you can call landline phones and mobile phones with your TV.

Buy Skype Credit

To buy Skype Credit or take a Skype subscription, sign in to Skype on your computer.

The Skype Credit you buy will be available when you sign in to Skype on your TV.

The amount of credit or the subscription information is shown on each page where you can make a phone call.

Skype Credit low

You will be notified if your credit is too low to make a phone call.

18.9

Skype settings

Signing in

You can set Skype to automatically sign in when you select Skype from the Home menu. You do not need to enter your Skype Name or password.

To sign in when Skype starts...

1 - Sign in to Skype with your account.

2 - In the **Skype menu**, select **Settings** and press **OK**.

3 - Select **Signing in** and press **OK**.

4 - Press **▶** (right) to select the check box and press **OK** to mark **Sign me in when Skype starts**.

Change password

You can change your current Skype password and enter a new password for your Skype account.

To change your password...

- 1 - Sign in to Skype with your account.
- 2 - In the **Skype menu**, select **Settings** and press **OK**.
- 3 - Select **Change password**.
- 4 - Press **▶** (right) to select **Current password** and enter your current password. Press **OK** first if you want to use the on screen keyboard.
- 5 - Press **▼** (down) to select **New password** and enter you new password.
- 6 - Press **▼** (down) again to select **Repeat new password** and re-enter the new password.
- 7 - Press **▼** (down) again to select **Apply** to send the new password for confirmation.

Video

You can set Skype to restrict the use of video in Skype calls.

With **Automatically receive video from**, you can set Skype to automatically receive and show video from **Anyone**, **People in my contact list only** or from **No one**.

With **Show that I have video to**, you can set Skype to send out your video to **People in my contact list only** or to **No one**.

To set the Video settings...

- 1 - Sign in to Skype with your account.
- 2 - In the **Skype menu**, select **Settings** and press **OK**.
- 3 - Select **Video**.
- 4 - Press **▶** (right) to select the radio buttons and press **OK** to mark or unmark.

Privacy

You can set Skype to restrict incoming Skype calls.

You can allow calls from **Anyone** or from **From people in my contact list only**.

To set the Privacy settings...

- 1 - Sign in to Skype with your account.
- 2 - In the **Skype menu**, select **Settings** and press **OK**.
- 3 - Select **Privacy**.
- 4 - Press **▶** (right) to select the radio buttons and press **OK** to mark or unmark.

Blocked contacts

You can view a list of all your Blocked contacts.

To view the list...

- 1 - Sign in to Skype with your account.
- 2 - In the **Skype menu**, select **Settings** and press **OK**.
- 3 - Select **Blocked contacts** and press **OK**. To manage your blocked contacts, press **≡** **OPTIONS**.

Voicemail

You can set some preferences for sending voicemails.

If you allow a contact to send you a voicemail when you can't take the call, check the box of **Send unanswered calls to voicemail**. Leave the box unchecked, if you do not want to receive voicemails.

If you allow a contact to send you a voicemail when you can't answer the call within 15 seconds and you are in another call, check the box of **I am already in a call**.

If you allow a voicemail, when you declined a call, check the box of **I decline an incoming call**.

To set your preferences for voicemail...

- 1 - Sign in to Skype with your account.
- 2 - In the **Skype menu**, select **Settings** and press **OK**.
- 3 - Select **Voicemail** and press **OK**.
- 4 - Press **▼** (down) or **▲** (up) to select a check box. Press **OK** to check or uncheck.

Call forwarding

Never miss a Skype call with **Call Forwarding**.

If you are not online or can't take the call, you can forward a Skype call to any phone or mobile phone. You can also forward a Skype call to another Skype account. You can set up to three phone numbers or Skype Names in order of preference to forward calls to. You need Skype Credit or a Skype subscription to forward calls to phones. Forwarding Skype calls to other Skype accounts is free of charge. For more information on call forwarding, go to www.skype.com/support

To set up call forwarding...

- 1 - Sign in to Skype with your account.
- 2 - In the **Skype menu**, select **Settings** and press **OK**.
- 3 - Press **OK** to check the check box for **Forward calls when I am not on Skype**.
- 4 - In the entry fields below, enter the phone numbers or Skype Names from your contact list in order of preference to forward your calls to. Always add the country code for phone numbers.
- 5 - Change, if necessary, the amount of seconds before Skype

forwards your call.

6 - Select **Save** to store your **Call Forwarding** setup.

18.12

Terms of use & Privacy Policy

Read the Terms of Use of Skype at www.skype.com/go/tou

Also read the Privacy Policy at www.skype.com/go/privacy

Camera zoom, pan and tilt

You can set the viewpoint of your camera. You can zoom in or out, pan or tilt the camera frame. While you are in a Video call, you can set the camera viewpoint.

To set the camera viewpoint...

1 - Start a **Video call** and wait until the call is ongoing.

2 - Press **▶** (right) to select the icon above the small screen and press **OK**. A bar with colour key functions appears.

3 - To shift (pan) the camera frame, press **◀** (left) or **▶** (right). To tilt the camera frame, press **▲** (up) or **▼** (down). To zoom in, press **— Zoom in**. To zoom out, press **— Zoom out**.

4 - Press **— Done** to store the camera viewpoint and to go back to your Skype call.

18.10

Sign out

When you sign out of Skype, you are signing out your Skype account. Your Online status will change to **Offline**. Your contacts will not be able to call you.

To sign out...

1 - Press **↩ Back** from anywhere within Skype to return to the **Skype menu**.

2 - Select **Sign out** in the Skype menu and press **OK**.

The TV will ask you to quit Skype or to use Skype with another Skype account.

18.11

Quit Skype

When you sign out of Skype, the Skype application on TV is still active. Another Skype account can sign in or you can create a new account. To stop the Skype application on TV, you must quit Skype.

Smart TV

About Smart TV

Connect this **Philips Smart LED TV** to the Internet and discover a new world of television. You can make a wired connection to your router or you can link up wirelessly with Wi-Fi.

With the TV connected to your home network, a smartphone can show a photo on TV, you can play videos stored on your computer or control the TV with your tablet.

With your TV connected to the Internet, you can watch a rental video from an online video store, read the online TV guide or record your favourite TV show on a USB Hard Drive. The Smart TV Apps add to the fun with all sorts of entertainment and convenient services.

What you need

To enjoy **Smart TV Apps** you must connect the TV to a router with a high-speed (broadband) connection to the Internet. You can use a home network connected to the Internet. You do not need a computer.

For more information, press **— Keywords** and look up **Network**.

Tip

To enter text or to navigate an Internet page more easily, you can consider to connect a USB keyboard and a USB mouse to the TV.

For more information, press **— Keywords** and look up **USB keyboard** or **USB mouse**.

Setup Smart TV

The first time you open Smart TV, you need to configure your connection. Read and agree to the terms and conditions to continue. If you do not want to set up Smart TV, press **↩**.

Register

To register with Club Philips . . .

- 1 - Select **Register** and press **OK**.
- 2 - Enter your email address, select **Continue** and press **OK**.
- 3 - Confirm the email address.

Parental control

To lock Adult 18+ rated apps . . .

1 - Switch on Smart TV parental control by selecting **Enable** and then press **OK**.

2 - Enter an unlock PIN code of your choice.

3 - Confirm your PIN code.

Adult 18+ rated apps are now locked. To open a locked app, select the app and press **OK**. The TV will ask you to enter your 4-digit code.

Smart TV Apps

Open Smart TV

The Smart TV start page is your link to the Internet. You can rent movies online, read newspapers, watch videos and listen to music, also shop online, open your social network page (Facebook, Twitter, . . .) or watch TV programmes when it suits you with Online TV. To do this, you open Apps - Internet sites which are tailored for TV. With your TV connected to the Internet, you can open Smart TV.

Open Smart TV

To open the Smart TV start page, press **Smart TV**.

Alternatively, you can press **Home**, select **Smart TV** and press **OK**.

The TV connects to the Internet and opens the Smart TV start page. This may take a few seconds.

Close Smart TV

To close the Smart TV start page, press **Home** and select another activity.

TP Vision Europe B.V. bears no responsibility regarding the content and the quality of the content provided by the content service providers.

Smart TV start page

1 - Now on your TV

2 - Your Apps

3 - App gallery

4 - Internet

5 - Recommended Apps

6 - Search

7 - Colour keys for control

Your Apps

You start Apps from the Smart TV start page. If the start page does not hold any Apps yet, you can add Apps from the App gallery.

App gallery

In the App gallery you find all available Apps.

Internet

The Internet App opens the World Wide Web on your TV. On your TV, you can view any Internet website but most of them are not tailored for a TV screen.

- Some plug-ins (e.g. to view pages or videos) are not available on your TV.
- Internet pages are shown one page at a time and full screen.

Recommended Apps

In this window, Philips presents a range of recommended Apps for your country, Apps for Online TV or a selection of rental movies from Video stores. You can select and open them from the Recommended Apps window.

Search

With Search, you can search the App gallery for relevant Apps. Enter a keyword in the text field, select  and press **OK** to start searching. You can enter names, titles, genres and description keywords to search.

Alternatively, you can leave the text field empty and search for the most popular searches/keywords for a range of categories. In the list of found keywords, select a keyword and press **OK** to search for items with that keyword.

Open an App

To open an App, you must add it to your list of Apps in the Smart TV start page first. You can add Apps to your list from the App gallery.

The list of your Apps on the Smart TV start page can be several pages long. Use the arrow keys to go to the next or previous page. Alternatively, press  + (Next page) or  - (Previous page).

Open an App

To open an App . . .

- 1 - Press  and select **Smart TV**.
- 2 - On the start page, select an App icon and press **OK**. In an App, press  to go back 1 step or page.

Close an App

To close an App and return to the Smart TV start page, press  **Smart TV**.

Reload an App page

If an App page did not load properly, press  **OPTIONS** and select **Reload** to reload the page.



Zoom

To zoom in on an App page . . .

- 1 - Press  **OPTIONS** and select **Zoom page**.
- 2 - Use the slider bar to set the zoom level.
- 3 - Return to normal view by resetting the slider bar.

View security info

You can check the security level of an App page.

On an App page, press  **OPTIONS** and select **Security info**. If a lock  is shown next to the loading animation on the bottom of the screen while loading a page, the transfer is secured.

Feedback on an App

Select the App and press  **Feedback** to select a 'like' or 'don't like' button and send a suggestion or remark to us. You can also report an App malfunction.

Manage your Apps

In the list of Apps on the Smart TV start page you can . . .



• Remove an App

To remove an App from the list, select the App icon and press  **Remove**. The App is still available in the App gallery.

• Move an App

To reposition an App in the list, select the App icon, press  **Move** and use the arrow keys to reposition the App. Press **OK** to confirm the position.

• Lock an App

To lock an App, select the App icon and press  **Lock**. When you lock an App, you must enter the 4 digit PIN code you set for Parental control when you configured Smart TV. In the list, a locked App is marked with a lock . To unlock an App, select the App icon and press  **Unlock**. You must enter the 4 digit PIN code to unlock.

App gallery



Open the **App gallery** in Smart TV to browse the Apps, the collection of tailored websites for TV.

Find the App for YouTube videos, a national newspaper, an online photo album, Facebook, Twitter, etc. There are Apps to rent a video from an online video store and Apps for watching programmes you missed. If the App gallery does not hold what you are looking for, try the World Wide Web and surf the Internet on TV.

Rental video Apps

With the video store Apps in Smart TV, you can rent your favourite movie from an online rental video store. You can pay securely with your credit card.

Rent a movie

- 1 - Open a Video store App in your list of Apps or select a recommended video on the Smart TV start page.
- 2 - Select a movie.
- 3 - Make the online payment.
- 4 - Start watching. You can use the  (Play) and  (Pause) keys.

Most Video stores ask you to create a login account.

Streaming video

With this TV, you can watch rental movies sent as a streaming video format. You can almost instantly watch the movie. You might need a USB Hard Drive to store some video buffer. If you have a USB Hard Drive connected, you can also download rental movies from video stores that offer movie downloading only. You can pause or restart a downloaded rental movie. Consult the video store regarding the rental duration of rental movies.

Internet traffic



Streaming or downloading many videos may exceed your monthly Internet traffic limit.

Online TV

With the Online TV App on the Smart TV start page*, you can watch TV programmes you missed or watch programmes whenever it suits you best.

Open Online TV

To open the Online TV App . . .

- 1 - Press  **Smart TV**.
- 2 - On the start page, select the  **Online TV** icon and press **OK**.
- 3 - Select a programme on the page and press **OK** to start watching. You can use the **▶** (Play) and **⏸** (Pause) keys.

List per broadcaster

To view the Online TV programmes ordered by broadcaster, press  **All broadcasters**.
Select a broadcaster and press **OK**.

* If available in your region.

19.5

Reset Smart TV

To reset your connection with Smart TV, clear the Internet memory on the TV.

You will clear your Philips Smart TV registration and parental rating setting, your video store app logins, all Smart TV app favourites, Internet bookmarks and history.

To clear the Internet memory . . .

- 1 - Press  and select **Setup** and press **OK**.
- 2 - Select **Network settings** > **Clear Internet memory** and press **OK**.

Multi room

20.1

About Multi room

With Multi room you can wirelessly send -stream- digital TV channels from another Philips TV to this TV. You can stream any digital TV channel from the other TV, also channels from a subscription smart card. If you can watch the digital channel on the other TV, you can watch it on this one. If you don't have an antenna connection in the room where this TV is, you can use Multi room to watch the digital channels the other TV has to offer.

If the type number of both TVs, end with an eight e.g. (the screen size) **PFLxxx8**, you can switch on the other TV if it's in standby with this TV. Also, recordings made with the other TV and stored on its connected HDD can be watched on this TV.

Streaming a TV channel with Multi room will reduce the resolution from HD to SD. You cannot stream radio channels (audio only).

20.2

What you need

To stream and watch TV channels from another Philips TV, the other TV needs to serve as a TV channel source. Both TVs must be connected to your wireless home network.

For more information, press **— Keywords** and look up **Network**.

If the other Philips TV — the source — has a model number that ends with a seven, e.g. (the screen size) **PFLxxx7** and it has the latest software, you're all set.

On the other TV, read the Help chapter on **Software update** to update its TV software.

Switch on with Wi-Fi

If the type number of both TVs, end with an eight e.g. (the screen size) **PFLxxx8**, you can switch on the other TV from standby with this TV. Make sure you switch on the setting **Switch on with Wi-Fi** on the other TV.

To switch on Switch on with Wi-Fi . . .

- 1 - Press **⏠**, select **Setup** and press **OK**.
- 2 - Select **Network settings** > **Switch on with Wi-Fi** and select **On** and press **OK**.

If all conditions on both TVs are met, you can use Multi room.

Using Multi room

First time use

When you start Multi room for the first time, switch on both TVs.

Once this TV made a connection with the other TV, the other one will appear automatically in the **Browse network** menu even when it's in standby.

Stream a TV channel

With Multi room, you can watch the current TV channel or open the channel list of the other TV. If you select a channel from the list, the other TV will also switch to the channel you selected. If the other TV has a build-in satellite tuner with installed channels or a connected Hard Disc Drive (HDD) with recordings*, you can also watch these on this TV. You cannot switch channels while the other TV is recording, in Pause TV mode or using Skype.

To watch a TV channel from the other TV . . .

- 1 - Make sure the other TV is in standby* or switched on.
 - 2 - On this TV, press **⏸ SOURCES**, select **Browse network** and press **OK**.
 - 3 - If the TV is not yet connected to your home network, the network installation will start automatically. If the TV is already connected, go to step 4.
 - 4 - In the **Browse network** menu, select the name of the other TV and press **OK**. If you have several TVs in your home, you might want to change the name of the other TV. You can do that on the TV itself.
 - 5 - Select what you want to watch from the other TV . . .
 - to watch the current channel of the other TV, select **Current channel** and press **OK**.
 - to open the channel list of the other TV, select **Watch TV** and press **▶ (Right)**.
 - to open the satellite channel list of the other TV, select **Watch satellite** and press **▶ (Right)**.
 - to open the list of recordings* on the other TV, select **Watch recordings** and press **▶ (Right)**.
 - you can switch channels with **⏸ +** and **⏸ -**. You cannot switch channels when the other TV is recording, in Pause TV mode or using Skype.
- * To switch on the other TV from standby or to watch its recordings from a connected HDD, both TVs must have a type number that ends with an eight, e.g. (screen size) **PFLxxx8**.

TV name

To change the TV name . . .

Press **⬆** > **Setup** > **Network settings** > **TV network name**.

Share this...

With the **Share this**  key on the Remote Control, you can share the channel and programme name you're watching or share the Internet address of the site you're on. You can share the title and info of a programme selected in the TV Guide or share the App name and its icon from Smart TV. You can share all these things on Facebook or Twitter or any social network available on your Smart TV App pages.

Your TV must be connected to the Internet.

To share what you're watching or have selected at this moment...

- 1 - Press  to open the **Share this** menu.
- 2 - Select the social network you want to share on and press **OK**.
- 3 - The TV will open the social network website. Depending on what social network you have selected, you can post, send or enter a message.

MyRemote App

22.1

About MyRemote App

What this App can do

The MyRemote App and this TV, offer . . .

- **SimplyShare** - share photos, music and videos from your smartphone or tablet
- **Control** - use your smartphone or tablet as a TV remote control
- **TV guide** - consult the TV schedule and switch the TV to the channel you want

- **Wi-Fi smart screen** - watch a TV channel on your smartphone or tablet

The MyRemote App v4.x is available for iPhone, iPad and Android™. The MyRemote App functions may vary according to version and operating system of the mobile device.

It's free

You can download the MyRemote App for free.

If you want to add the functions Wi-Fi smart screen, a small cost may apply.

Languages

The following languages are available in the MyRemote App : English, German, French, Italian, Spanish, Portuguese, Dutch and Russian.

If the language set on your mobile device is not one of these languages, the MyRemote App language is switched to English.

The MyRemote App is continually being developed. Future versions will have new functions and will be gradually available. Regularly check the MyRemote App updates on the App stores.

Apple, iPhone and iPad are trademarks of Apple Inc., registered in the U.S. and other countries. Android is a trademark of Google Inc.

Google Play is a trademark of Google Inc.

On other Philips TVs

MyRemote App with other TVs

You can use the MyRemote App on Philips TV models built from 2009 onwards.

If your TV is a 2009 model, you need to update the TV software and activate **JointSpace**. If you have a 2010 model, you only need to activate JointSpace on the TV. TV models from 2011 and onwards are ready to use the MyRemote App.

To know in what year your TV was built, check the TV type

number (E.g. xxPFLxxx4). If the last number is a '4' your TV is a 2009 model. If the last number is a '5' your TV is a 2010 model. A '6' for 2011, a '7' for 2012 and an '8' for 2013.

22.2

What you need

Home network

Home network

Your TV, smartphone, tablet and computer, must be linked up with your home network to enjoy the MyRemote App.

To connect the TV to your home network . . .

- 1 - Connect your network router to the Internet, if it was not connected yet (a broadband Internet connection).
- 2 - Connect the TV to your network router. You can do this wireless or wired.

For more information, press **Keywords** and look up **Network, wireless** or **Network, wired**.

Media server software

Media server software

If you want to view your photos or play your music and videos from your computer on the TV, you have to install media server software on your computer. Setup this media server software to share your files on your home network.

For more information, press **Keywords** and look up **Media servers, supported** for the list of media server software that is compatible with the TV.

Digital Media Renderer - DMR

Digital Media Renderer - DMR

If your media files do not play on your TV, make sure that the Digital Media Renderer is switched on. As a factory setting, DMR is switched on.

To check if DMR is switched on . . .

- 1 - Press **Home** and select **Setup** and press **OK**.
- 2 - Select **Network settings** and press **OK**.
- 3 - Select **Digital Media Renderer - DMR** and press **OK**.
- 4 - Select **On** and press **OK**.
- 5 - Press **Back**, repeatedly if necessary, to close the menu.

TV network name

TV network name

If you have more than one TV in your home network, you can rename the TV in Network settings.

To rename your TV . . .

- 1 - Press **⏠** and select **Setup** and press **OK**.
- 2 - Select **Network settings** and press **OK**.
- 3 - Select **TV network name** and press **OK** to show the current name. You can use the keyboard on the remote control to change the TV network name.
- 4 - Select **Done** and press **OK** when ready.
- 5 - Press **↩**, repeatedly if necessary, to close the menu.

22.3

App download

To download the MyRemote App on your smartphone or tablet, you can use the QR codes on this page. Select the operating system (or device type) you need and use your QR code reader to go to the download page directly.

Apple iPhone

To download the app on your iPhone, go to the Apple App Store and look for the **Philips MyRemote App**.

Apple iPad

To download the app on your iPad, go to the Apple App Store and look for the **Philips MyRemote HD App**.

Google play

To download the app on your Android device, go to Google play and look for the **Philips MyRemote App**.

22.4

App menu

From the MyRemote App menu, you can start the different MyRemote App functions. Simply tap a function to open it. To go back to the App menu, tap the App menu button at the top of the page.

Tool tips

To know what the particular buttons of the App do, tap the **ℹ** icon. The tool tips appear on top of the available buttons. To close the Tool tips, tap anywhere on the touchscreen.

Select device

In the MyRemote App menu, you can select the device - e.g. this TV - with which you want to use all the App functions. Tap the

button **Select device** at the top right corner of the App menu.

You can check the compatibility of MyRemote with your other Philips products at the online support page of your product at www.philips.com/support. Also ensure your Philips product has been updated with the latest software.

22.5

App functions

SimplyShare

With **SimplyShare**, you can send media files like photos, music or videos from a device in your home network to another device in your network.*

To open SimplyShare in the MyRemote app, tap the **SimplyShare** button in the MyRemote App menu.

Select a device to send media from

- 1 - Tap the white bar at the top to open the list of available devices in your network.
- 2 - Tap a device in the list.

Select a device to play the media

- 1 - Tap the white bar at the bottom to open the list of available devices in your network.
- 2 - Tap a device in the list.

Select a media file

Some devices that send files offer them by type of media. If so, you can select the type of media you are looking for - **Photos**, **Videos** or **Music**.

- 1 - Tap the type of media you are looking for.
- 2 - In the list, tap the song, video or photo to play it on the device you selected.

Compatible media formats

A wide range of media formats can be played on your TV.

For more information, press **— Keywords** and look up **Playback formats**.

* You can check the compatibility of MyRemote with your specific Philips product at the online support page of your product at www.philips.com/support. Also ensure your Philips product has been upgraded with the latest software.

TV guide

What you need

To view the TV guide of the TV on your smartphone or tablet . . .

- there must be a TV guide with channel and programme information on the TV
- the TV guide information has to come from the Internet

- the TV guide of the TV must be linked up with the smartphone or tablet

For more information on the TV guide, press **— Keywords** and look up **TV guide**.

MyRemote recording

To schedule a recording in the TV guide from your smartphone or tablet . . .

- connect and format a USB Hard Drive on your TV
- make sure the setting MyRemote recording is switched on
- before you use the MyRemote recording function, you must switch the TV to standby and back on again

For more information on connecting a USB Hard Drive, press **— Keywords** and look up **USB Hard Drive**.

Setting up

To open the TV guide on your smartphone or tablet, the TV guide must be linked to your mobile device.

Also, first check if the TV guide on your TV is updated from the Internet.

- 1 - Press **⏠** and select **Setup** and press **OK**.
- 2 - Select **TV settings > General settings > TV guide**.
- 3 - Select **From the Internet** and press **OK**.
- 4 - Press **↩**, repeatedly if necessary, to close the menu.

Link up with the TV

To link up your smartphone or tablet with the TV guide of the TV . . .

- 1 - Press **≡ TV GUIDE** on the remote control to open the TV guide on TV.
- 2 - Press the **—** (yellow) key to open the list of detected mobile devices.
- 3 - Select **Link a mobile device** and press **OK** to view the code to link up.
- 4 - On the mobile device, start the MyRemote App and tap the **Setup** button on the home menu.
- 5 - Tap the **TV guide** item.
- 6 - Enter the code to link up.

The MyRemote recording setting

Make sure this setting is switched on to schedule a recording.

- 1 - Press **⏠** and select **Setup** and press **OK**.
- 2 - Select **Network settings > MyRemote recording**.
- 3 - Select **On** and press **OK**.
- 4 - Press **↩**, repeatedly if necessary, to close the menu.

Using the TV guide

With the TV guide function, you can call up the TV guide of your TV on your smartphone or tablet. You can consult the TV schedule and read programme info. You can tap the programme title to switch the TV to the selected channel directly.

If you have a USB Hard Drive installed on your TV, you can schedule recordings on the TV from your smartphone or tablet.

To open the TV guide, tap the TV guide button on the MyRemote App menu.

The first time you tap the TV guide button, you will be asked to link up the tablet and TV, if you did not link up yet.

Schedule a recording

With the MyRemote App you can schedule a recording in the TV guide of the TV.

For more information on Recording, press **— Keywords** and look up **Recording**.

Control

With the **Control** function on the MyRemote App menu, you turn your smartphone or tablet into a full remote control for your TV.

Tap the **Control** button to select the TV (or Philips Blu-ray Disc player or Home Theatre System) to control.
Tap the device icon to show its remote control.

Tap the Control button to select the TV (or Philips Blu-ray Disc player or Home Theatre System) to control. Tap the device icon to show its remote control.

Wi-Fi smart screen

What you need

With the **Wi-Fi smart screen** function, you can watch a digital TV channel from your TV on your smartphone or tablet. If you use an Android operating system, you can only view free-to-air TV channels.

What you need

To watch TV on your smartphone or tablet . . .

- you must have digital TV channels installed on your TV (the channels you watch with Watch TV)
- the TV must be switched on
- your home network must be a secured network. Secure your network with **WEP, WPA, WPA2** or set it up using **WPS**
- you must have the setting **Wi-Fi smart screen** switched on. Press **⏠ > Setup > Network settings > Wi-Fi smart screen**.

Buy Wi-Fi smart screen

How to buy

Tap **Wi-Fi smart screen** in the **App menu** to open the function.

If you did not purchase this function yet, you will be asked to buy it online. After the purchase, **Wi-Fi smart screen** opens automatically and you can start watching TV.

Parental rating

Some digital broadcasters have rated their programmes. When the rating is equal or higher than the rating you have set for your child's age, the programme will be locked. You will need a **PIN code** to unlock and watch the programme.

To switch on **Parental rating**, tap the **Setup** button on the App menu. Switch on **Parental rating**, set your PIN code and set an age. The parental rating in the MyRemote App is set for watching TV on your smartphone or tablet, not the TV.

If you have forgotten your PIN code, you need to reinstall the MyRemote App from the App store. On the purchase page for Wi-Fi smart screen, you can restore your purchase without cost.

Watch a TV channel

To watch a TV channel with the Wi-Fi smart screen function, tap **Wi-Fi smart screen** in the **App menu**. Wi-Fi smart screen will show the TV channel currently on TV. If the TV is switched to a connected device, you need to switch the TV back to **Watch TV** or to **Watch Satellite** (if a built-in satellite tuner is available).

Switch TV channels

To switch TV channels, swipe the touchscreen of your smartphone or tablet. Swipe to the right to watch the previous channel or swipe to the left to watch the next channel. The sequence of channels follows the TV channel list. You can also use the **Channel bar** to look for and switch to TV channels.

Pause TV and Recording

If you pause the TV broadcast on TV or start recording a broadcast with the TV (on a connected USB Hard Drive), the Wi-Fi smart screen function will stop.

Sound

The sound that comes with the TV channel is mono sound.

Subtitles

Subtitles on Wi-Fi smart screen are not supported.

Channel bar

To switch to a channel further up or down the TV channel list, you can call up the **Channel bar**.

To call up the **Channel bar**, tap the middle of your touchscreen once. The Channel bar appears at the bottom of the screen, together with the **Tool bar** at the top. You can swipe the Channel bar and look for a TV channel.

To switch to a TV channel, tap the channel icon once.

To close the Channel bar and Tool bar, tap the middle of the

screen again.

Tool bar

In the Wi-Fi smart screen tool bar, you can select the picture format, select the TV or Satellite channel list (if available on TV), open the tool tips or switch the TV on standby.

To call up the **Tool bar**, tap the middle of your touchscreen once. The Tool bar appears at the top of the screen, together with the Channel bar.

To close the Tool bar and Channel bar, tap the middle of the screen again.

App menu button

To go back to the MyRemote App menu, tap the **App menu** button.

Scale

To scale the picture to just fit or completely fill the screen, tap the **Scale** button to toggle between fill or fit.

TV or Satellite

If you have a built-in satellite tuner in your TV, you can select the channel list of **Watch TV** or **Watch satellite**. The button shows which channel list is currently selected.

To change the current channel list, tap the button and tap **TV** or **Satellite** to select the channel list you want. If you do not have a built-in satellite tuner, there is no selection button.

Settings

23.1

Setup menu

Quick picture settings

With **Quick picture settings** you can set your basic picture preferences in a few easy steps. The settings you made are stored under the **Picture style - Personal**. You can return to your picture preference if some settings were changed. You can set a preferred picture setting for every TV activity or connected device individually.

To return to your preferred picture setting, while watching a TV channel, press **≡ OPTIONS**, select Picture and sound in the menu bar, select **Picture style** and select **Personal**.

To set a Quick picture setting . . .

- 1 - Press **⏠**, select an activity or a connected device (or its connection) and press **OK**.
- 2 - Press **⏠** again, select **Setup** and press **OK**.
- 3 - Select **Quick picture settings** and press **OK**. Go through the steps and finish. The activity or connection has your personal preferences.

For more information, press **— Keywords** and look up **Picture style**.

TV settings

In the **TV settings** menu you can set all **Picture**, **3D**, **Sound** and **Ambilight** settings. The item **General settings** in the menu holds a collection of settings like **Menu language**, **Sleep timer**, **Switch off timer**, **Universal access** and more.

For more information, press **— Keywords** and look up the topic you need

Search for channels

With **Search for channels**, you can update your current channel list and possible newly found channels are added to the channel list. You can also do a reinstallation of all channels. A channel update or a channel reinstall may take some time.

Press **— Keywords** and look up **Channel, update** or **Channels, reinstall**.

Channel settings

In the **Channel settings** menu, you can set your language preferences or switch on the Universal access for people who are hearing and visually impaired. You can set an age rating to prevent children from watching a rated programme and set or change your Child lock code. You can switch on the Automatic channel update, do a digital reception test or install analogue channels manually.

Languages

Press **— Keywords** and look up **Audio language** or **Subtitles**.

Universal access

Press **— Keywords** and look up **Universal access** for visually and hearing impaired users settings.

Channel installation

Press **— Keywords** and look up **Automatic channel update** or **Channel update message**. Also look up **Manual installation** for installing analogue channels or **DVB** to switch the antenna connection.

Child lock

Press **— Keywords** and look up **Child lock**.

Search for satellite

Press **— Keywords** and look up **Satellite, installation**.

Satellite settings

Languages

Press **— Keywords** and look up **Audio language** or **Subtitles**.

Channel installation

Press **— Keywords** and look up **Satellite, automatic channel update** or **Satellite, channel update message** or **Satellite, automatic update options**.

Child lock

Press **— Keywords** and look up **Satellite, channel lock**.

Connect to network

Press **— Keywords** and look up **Network, wireless** or **Network, wired**.

Network settings

Press **—** **Keywords** and look up **Network, settings**.

Update software

Press **—** **Keywords** and look up **Software, Internet update** or **Software, USB update**.

Software settings

Press **—** **Keywords** and look up **Software, current version**.

Watch demo

With **Watch demos** in the **Setup** menu, you can watch some demonstration videos of some of the picture quality features of your TV.

Active control

The TV monitors the incoming picture quality, the level of motion in the picture, brighter or darker scenes and the light conditions in your room. With these values, the TV adjusts the picture for best performance.

23.2

Picture

Picture style

For easy picture adjustment, you can select a preset setting with **Picture style**.

- 1 - While watching a TV channel, press **≡** **OPTIONS** to open the **Options** menu.
- 2 - Select **Picture and sound** in the menu bar and select **Picture style**.
- 3 - Select a style and press **OK**.

The available Picture styles are . . .

- **Personal** - Your preferences made in Quick picture settings
- **Vivid** - Ideal for daylight viewing
- **Natural** - Natural picture settings
- **Movie** - Ideal for watching movies
- **Energy saving** - Energy-efficient settings
- **Standard** - Factory standard settings
- **Photo** - Ideal for viewing photos

Adjust a Picture style

You can adjust a Picture style . . .

- 1 - Select the style and press **OK**.
- 2 - Press **⬆** and select **Setup** and press **OK**.

3 - Select **TV settings**, navigate to the individual setting and adjust it.

4 - Press **⬅**, repeatedly if necessary, to close the menu.

To return to the original Picture style values . . .

- 1 - Press **⬆** and select **Setup** and press **OK**.
- 2 - Select **TV settings > Picture > Picture style** and select the style you want to reset.
- 3 - Press **—** **Reset**. The style is reset.

For more information on adjusting individual picture settings, press **—** **Keywords** and look up **Picture**.

Vivid

If the Picture style is switched back to **Vivid** every time you switch on the TV, the TV location is set to **Shop**. A setting meant for in-store promotion.

To set the TV for Home use . . .

- 1 - Press **⬆** and select **Setup** and press **OK**.
 - 2 - Select **TV settings > General settings > Location** and press **OK**.
 - 3 - Select **Home** and press **OK**.
 - 4 - Press **⬅**, repeatedly if necessary, to close the menu.
-

Picture settings

Colour

With **Colour**, you can adjust the colour saturation of the picture.

To adjust the colour . . .

- 1 - Press **⬆** and select **Setup** and press **OK**.
 - 2 - Select **TV settings > Picture > Colour**.
 - 3 - Press **▶** (right) and adjust the value with **▲** (up) or **▼** (down).
 - 4 - Press **⬅**, repeatedly if necessary, to close the menu.
-

Contrast

With **Contrast**, you can adjust the contrast of the picture. If you are watching 3D pictures, this setting is switched to **3D contrast**.

To adjust the contrast . . .

- 1 - Press **⬆** and select **Setup** and press **OK**.
 - 2 - Select **TV settings > Picture > Contrast**.
 - 3 - Press **▶** (right) and adjust the value with **▲** (up) or **▼** (down).
 - 4 - Press **⬅**, repeatedly if necessary, to close the menu.
-

Sharpness

With **Sharpness**, you can adjust the level of sharpness in fine detail of the picture.

To adjust the sharpness . . .

- 1 - Press **Home** and select **Setup** and press **OK**.
- 2 - Select **TV settings > Picture > Sharpness**.
- 3 - Press **▶** (right) and adjust the value with **▲** (up) or **▼** (down).
- 4 - Press **↩**, repeatedly if necessary, to close the menu.

Advanced picture settings

Colour settings

Colour enhancement

With **Colour enhancement**, you can enhance the colour intensity and the details in bright colours.

To adjust the level . . .

- 1 - Press **Home** and select **Setup** and press **OK**.
- 2 - Select **TV settings > Picture > Advanced > Colour > Colour enhancement**.
- 3 - Press **▶** (right) and select **Maximum, Medium, Minimum** or **Off**.
- 4 - Press **↩**, repeatedly if necessary, to close the menu.

Colour temperature

With **Colour temperature**, you can set the picture to a preset colour temperature or select **Custom** to set a temperature setting yourself with **Custom colour temperature**. Colour temperature and Custom colour temperature are settings intended for expert users.

To select a preset . . .

- 1 - Press **Home** and select **Setup** and press **OK**.
- 2 - Select **TV settings > Picture > Advanced > Colour > Colour temperature**.
- 3 - Press **▶** (right) and select **Normal, Warm** or **Cool**. Select **Custom** if you want to set a colour temperature yourself.
- 4 - Press **↩**, repeatedly if necessary, to close the menu.

Custom colour temperature

With **Custom colour temperature**, you can set a colour temperature yourself. To set a Custom colour temperature, first select **Custom** in the **Colour temperature** setting to make the Custom colour temperature menu available. Custom colour temperature is a setting intended for expert users.

To set a custom colour temperature . . .

- 1 - Press **Home** and select **Setup** and press **OK**.
- 2 - Select **TV settings > Picture > Advanced > Colour > Custom colour temperature**.
- 3 - Press **▶** (right).
- 4 - Select a setting with the arrow keys. (WP is white point and BL is black level.)

5 - Press **OK** to confirm a setting. You can also select one of the presets in this menu.

6 - Press **↩**, repeatedly if necessary, to close the menu.

ISF Colour control

With **Colour control**, an ISF expert can calibrate the colour reproduction of the TV. Colour control is an ISF expert setting.

Get the most out of your TV display with ISF® Calibration. You can ask an ISF calibration expert to come to your home and set the TV to the most optimal picture setting. Additionally the expert can set an ISF Calibration for Ambilight. Ask your dealer for an ISF Calibration of your TV.

The ISF Calibration expert stores and locks the ISF settings as 2 picture styles. Once the ISF Calibration is done, press **≡** **OPTIONS**, select **Picture style** and press **OK**. Select **ISF Day** to watch TV during bright light conditions or select **ISF Night** for dark light conditions.

An ISF Calibration can be done on every activity in the Home menu, like Watch TV or a connected Blu-ray Disc player.

Calibration benefits are . . .

- better picture clarity and sharpness
- better detail in bright and dark parts
- deeper and darker blacks
- better colour purity and quality
- reduced energy consumption

Expert picture settings

When ISF Day or ISF Night is selected while an ISF Calibration is not yet performed on the TV, some expert picture settings are available.

- 1 - Press **Home** and select **Setup** and press **OK**.
- 2 - Select **TV settings > Picture > ISF expert settings** and press **OK**.

Reset picture style settings

To reset a picture style to its original values, select the picture style you want to reset in the **OPTIONS** menu. Then . . .

- 1 - Press **Home** and select **Setup** and press **OK**.
- 2 - Select **TV settings > Picture**.
- 3 - Select **Reset**, press **OK** and confirm.

ISF RGB only mode

With **RGB only mode**, an ISF expert can switch the screen to RGB colours only.

Contrast settings

Contrast modes

With **Contrast modes**, you can set the level at which power consumption can be reduced by dimming the intensity of the screen. Choose for the best power consumption or for the

picture with the best intensity.

To adjust the level . . .

- 1 - Press **▲** and select **Setup** and press **OK**.
- 2 - Select **TV settings > Picture > Advanced > Contrast > Contrast modes**.
- 3 - Press **▶** (right) and select **Best picture, Best power, Standard** or **Off**.
- 4 - Press **↵**, repeatedly if necessary, to close the menu.

Dynamic contrast

With **Dynamic contrast**, you can set the level at which the TV automatically enhances the details in the dark, middle and light areas of the picture.

To adjust the level . . .

- 1 - Press **▲** and select **Setup** and press **OK**.
- 2 - Select **TV settings > Picture > Advanced > Contrast > Dynamic contrast**.
- 3 - Press **▶** (right) and select **Maximum, Medium, Minimum** or **Off**.
- 4 - Press **↵**, repeatedly if necessary, to close the menu.

Perfect contrast

With **Perfect contrast**, you can set the level at which the TV automatically enhances the details in the dark, middle and light areas of the picture.

To adjust the level . . .

- 1 - Press **▲** and select **Setup** and press **OK**.
- 2 - Select **TV settings > Picture > Advanced > Contrast > Perfect contrast**.
- 3 - Press **▶** (right) and select **Maximum, Medium, Minimum** or **Off**.
- 4 - Press **↵**, repeatedly if necessary, to close the menu.

Brightness

With **Brightness**, you can set the level of brightness of the picture signal. Brightness is a setting intended for expert users. We recommend non-expert users to adjust the brightness of the picture with the **Contrast** setting.

To adjust the level . . .

- 1 - Press **▲** and select **Setup** and press **OK**.
- 2 - Select **TV settings > Picture > Advanced > Contrast > Brightness**.
- 3 - Press **▶** (right) and adjust the value with **▲** (up) or **▼** (down).
- 4 - Press **↵**, repeatedly if necessary, to close the menu.

Video contrast

With **Video contrast**, you can decrease the range of the video contrast. If you are watching 3D pictures, this setting is switched to **3D video contrast**. Video contrast and 3D video contrast are settings intended for expert users.

To adjust the level . . .

- 1 - Press **▲** and select **Setup** and press **OK**.
- 2 - Select **TV settings > Picture > Advanced > Contrast > Video contrast**.
- 3 - Press **▶** (right) and adjust the value with **▲** (up) or **▼** (down).
- 4 - Press **↵**, repeatedly if necessary, to close the menu.

Light sensor

The **Light sensor** adjusts the picture and Ambilight settings automatically to the lighting conditions of the room. You can switch Light sensor on or off.

To switch on or off . . .

- 1 - Press **▲** and select **Setup** and press **OK**.
 - 2 - Select **TV settings > Picture > Advanced > Contrast > Light sensor**.
 - 3 - Press **▶** (right) and select **On** or **Off**.
 - 4 - Press **↵**, repeatedly if necessary, to close the menu.
- Only for TVs with light sensor function.

Gamma

With **Gamma**, you can set a non-linear setting for picture luminance and contrast. Gamma is a setting intended for expert users.

To adjust the level . . .

- 1 - Press **▲** and select **Setup** and press **OK**.
- 2 - Select **TV settings > Picture > Advanced > Contrast > Gamma**.
- 3 - Press **▶** (right) and adjust the value with **▲** (up) or **▼** (down).
- 4 - Press **↵**, repeatedly if necessary, to close the menu.

Sharpness settings

Super resolution

With **Super resolution**, you switch on a superior sharpness in line edges and contours.

To switch on or off . . .

- 1 - Press **▲** and select **Setup** and press **OK**.
- 2 - Select **TV settings > Picture > Advanced > Sharpness > Super resolution**.
- 3 - Press **▶** (right) and select **On** or **Off**.

4 - Press **↩**, repeatedly if necessary, to close the menu.

Ultra resolution

With **Ultra resolution**, you switch on a superior sharpness in line edges and contours.

To switch on or off . . .

- 1 - Press **⬆** and select **Setup** and press **OK**.
- 2 - Select **TV settings > Picture > Advanced > Sharpness > Ultra resolution**.
- 3 - Press **▶** (right) and select **On** or **Off**.
- 4 - Press **↩**, repeatedly if necessary, to close the menu.

Noise reduction

With **Noise reduction**, you can filter out and reduce the level of image noise.

To adjust the noise reduction . . .

- 1 - Press **⬆** and select **Setup** and press **OK**.
- 2 - Select **TV settings > Picture > Advanced > Sharpness > Noise reduction**.
- 3 - Press **▶** (right) and select **Maximum, Medium, Minimum** or **Off**.
- 4 - Press **↩**, repeatedly if necessary, to close the menu.

MPEG artefact reduction

With **MPEG artefact reduction**, you can smoothen the digital transitions in the picture. MPEG artefacts are mostly visible as small blocks or jagged edges in images.

To reduce the MPEG artefacts . . .

- 1 - Press **⬆** and select **Setup** and press **OK**.
- 2 - Select **TV settings > Picture > Advanced > Sharpness > MPEG artefact reduction**.
- 3 - Press **▶** (right) and select **Maximum, Medium, Minimum** or **Off**.
- 4 - Press **↩**, repeatedly if necessary, to close the menu.

Motion settings

Perfect Natural Motion

With **Perfect Natural Motion**, you can reduce the motion judder, visible in movies on TV. Perfect Natural Motion makes any movement smooth and fluent.

To adjust the motion judder . . .

- 1 - Press **⬆** and select **Setup** and press **OK**.
- 2 - Select **TV settings > Picture > Advanced > Motion > Perfect Natural Motion**.
- 3 - Press **▶** (right) and

select **Maximum, Medium, Minimum** or **Off**.

4 - Press **↩**, repeatedly if necessary, to close the menu.

HD Natural Motion

With **HD Natural Motion**, you can reduce the motion judder, visible in movies on TV. Perfect Natural Motion makes any movement smooth and fluent.

To adjust the motion judder . . .

- 1 - Press **⬆** and select **Setup** and press **OK**.
- 2 - Select **TV settings > Picture > Advanced > Motion > HD Natural Motion**.
- 3 - Press **▶** (right) and select **Maximum, Medium, Minimum** or **Off**.
- 4 - Press **↩**, repeatedly if necessary, to close the menu.

Clear LCD

With **Clear LCD**, you switch on a superior motion sharpness, better black level, high contrast with a flicker-free, quiet image and a larger viewing angle.

To switch on or off . . .

- 1 - Press **⬆** and select **Setup** and press **OK**.
- 2 - Select **TV settings > Picture > Advanced > Motion > Clear LCD**.
- 3 - Press **▶** (right) and select **On** or **Off**.
- 4 - Press **↩**, repeatedly if necessary, to close the menu.

Game or computer

You can switch the TV to the ideal picture setting for gaming or for using the TV as a computer monitor. There is a different setting for **Game** or **Computer**. If a device has a correct type set in the Source menu - Game console or Computer - the TV switches automatically to the ideal setting when you switch to the device. If you switch the setting manually, do not forget to switch it off when you switch to watching TV or another connected device.

To switch the setting manually . . .

- 1 - Press **⬆** and select **Setup** and press **OK**.
- 2 - Select **TV settings > Picture > Advanced > Activity style**.
- 3 - Select **Game, Computer** or **TV**. The setting **TV** returns to the picture settings for watching TV.
- 4 - Press **↩**, repeatedly if necessary, to close the menu.

Location

If the TV is located in a shop, you can set the TV to display an in store promotion banner. The **Picture style** is set to **Vivid** automatically. The automatic **Switch off timer** is switched off.

To set the TV to Shop location . . .

- 1 - Press **Home** and select **Setup** and press **OK**.
- 2 - Select **TV settings** > **General settings** > **Location** and press **OK**.
- 3 - Select **Shop** and press **OK**.
- 4 - Press **Back**, repeatedly if necessary, to close the menu.

23.3

Sound

Sound style

For easy sound adjustment, you can select a preset setting with **Sound style**.

- 1 - While watching a TV channel, press **Options** to open the **Options** menu.
- 2 - Select **Picture and sound** in the menu bar and select **Sound style**.
- 3 - Select a Sound style and press **OK**.

The different Sound styles are . . .

- **Personal** - Your personal choices made in Personalise picture and sound
- **Original** - Factory standard
- **News** - Ideal for speech
- **Movie** - Ideal for watching movies
- **Game** - Ideal for gaming
- **Music** - Ideal for listening to music

Adjust a Sound style

You can adjust a Sound style . . .

- 1 - Select the style and press **OK**.
 - 2 - Press **Home** and select **Setup** and press **OK**.
 - 3 - Select **TV settings**, navigate to the individual setting and adjust it.
- Press **Back** to close the menu to store your setting.

To return to the original Sound style values . . .

- 1 - Press **Home** and select **Setup** and press **OK**.
- 2 - Select **TV settings** > **Sound** > **Sound style** and select the style you want to reset.
- 3 - Press **Reset**. The style is reset.

Press **Keywords** and look up **Sound** for adjusting individual sound settings.

Sound settings

Bass

With **Bass**, you can adjust the level of low tones in the sound.

To adjust the level . . .

- 1 - Press **Home** and select **Setup** and press **OK**.
- 2 - Select **TV settings** > **Sound** > **Bass**.
- 3 - Press **Right** and adjust the value with **Up** (up) or **Down** (down).
- 4 - Press **Back**, repeatedly if necessary, to close the menu.

Treble

With **Treble**, you can adjust the level of high tones in the sound.

To adjust the level . . .

- 1 - Press **Home** and select **Setup** and press **OK**.
- 2 - Select **TV settings** > **Sound** > **Treble**.
- 3 - Press **Right** and adjust the value with **Up** (up) or **Down** (down).
- 4 - Press **Back**, repeatedly if necessary, to close the menu.

Surround mode

With **Surround mode**, you can set the sound effect of the TV speakers. If you select **Incredible surround** for 2D viewing, the TV will switch to **Incredible surround 3D** automatically when you start watching 3D. If you do not want the TV to switch automatically, select **Off** in **Auto surround 3D**.

To set the surround mode . . .

- 1 - Press **Home** and select **Setup** and press **OK**.
- 2 - Select **TV settings** > **Sound** > **Surround mode**.
- 3 - Press **Right** and select **Stereo**, **Incredible surround** or **Incredible surround 3D**.
- 4 - Press **Back**, repeatedly if necessary, to close the menu.

Auto surround 3D

With **Auto surround 3D**, you can block the TV to automatically switch to Incredible surround 3D when the TV is switched to 3D.

To switch on or off . . .

- 1 - Press **Home** and select **Setup** and press **OK**.
- 2 - Select **TV settings** > **Sound** > **Auto surround 3D**.
- 3 - Press **Right** and select **On** or **Off**.
- 4 - Press **Back**, repeatedly if necessary, to close the menu.

Headphones volume

With **Headphones volume**, you can set the volume of a connected headphones separately.

To adjust the volume . . .

- 1 - Press **≡** **OPTIONS** and select **Picture and sound** in the menu bar.
- 2 - Press **▼** (down) and select **Headphones volume** and press **OK**.
- 3 - Press **▲** (up) or **▼** (down) to adjust the volume.
- 4 - Press **↩**, repeatedly if necessary, to close the menu.

Advanced sound settings

Auto volume levelling

With **Auto volume leveling**, you can set the TV to automatically level out sudden volume differences. Typically at the beginning of adverts or when you are switching channels.

To switch on or off . . .

- 1 - Press **⬆** and select **Setup** and press **OK**.
- 2 - Select **TV settings > Sound > Advanced > Auto volume leveling**.
- 3 - Press **▶** (right) and select **On** or **Off**.
- 4 - Press **↩**, repeatedly if necessary, to close the menu.

TV speakers

You can send the TV sound to a connected audio device - a Home Theatre System or audio system. With **TV speakers**, you select where you want to hear the TV sound and how you want to control it.

- If you select **Off**, you permanently switch off the TV speakers.
- If you select **On**, the TV speakers are always on.

With an audio device connected with HDMI CEC, you can use one of the EasyLink settings.

- If you select **EasyLink**, the TV sends the TV sound to the audio device. The TV will switch off the TV speakers when the device is playing the sound.
- If you select **EasyLink autostart**, the TV will switch on the audio device, send the TV sound to the device and switch off the TV speakers.

With **EasyLink** or **EasyLink autostart** selected, you can still switch to TV speakers or device speakers in the Picture and sound menu.

To set the TV speakers . . .

- 1 - Press **⬆** and select **Setup** and press **OK**.
- 2 - Select **TV settings > Sound > Advanced > TV speakers**.
- 3 - Press **▶** (right) and select **Off**, **TV speakers**, **EasyLink** or **EasyLink autostart**.
- 4 - Press **↩**, repeatedly if necessary, to close the menu.

To switch speakers directly . . .

- 1 - While watching TV, press **≡** **OPTIONS** and select **Picture and sound**.
- 2 - Select **Speakers** and select **TV** or **Amplifier** (audio device).
- 3 - Press **↩**, repeatedly if necessary, to close the menu.

Clear sound

With **Clear sound**, you improve the sound for speech. Ideal for news programmes. You can switch the speech improvement on or off.

To switch on or off . . .

- 1 - Press **⬆** and select **Setup** and press **OK**.
- 2 - Select **TV settings > Sound > Advanced > Clear sound**.
- 3 - Press **▶** (right) and select **On** or **Off**.
- 4 - Press **↩**, repeatedly if necessary, to close the menu.

HDMI ARC

If you do not need an Audio Return Channel (ARC) on any of the HDMI connections, you can switch the ARC signal off.

For more information, press **—** **Keywords** and look up **HDMI ARC**.

Audio Out format

With **Audio Out format** you can set the audio out signal of the TV to fit the sound processing capabilities of your Home Theatre System.

For more information, press **—** **Keywords** and look up **Audio Out format**.

Audio Out levelling

With **Audio Out leveling** you can level the sound volume of the Home Theatre System with the volume of the TV when you switch over from one to another.

For more information, press **—** **Keywords** and look up **Audio Out leveling**.

Audio Out delay

If you set an Audio sync delay on your Home Theatre System, to synchronise the sound with the picture, you must switch off **Audio Out delay** on the TV.

For more information, press **—** **Keywords** and look up **Audio Out delay**.

Audio Out offset

If you cannot set a delay on the Home Theatre System, you can set a delay on the TV with **Audio Out offset**.

For more information, press **— Keywords** and look up **Audio Out offset**.

Speakers

Wireless speakers

What you need

You can connect a wireless speaker - a subwoofer or a sound bar - to this TV. If you connect a subwoofer, the sound is played on the TV and the subwoofer. If you connect a sound bar the sound is played on the sound bar only.

To get wireless audio on your TV, go to www.philips.com/tv and apply for the **PTA209 Wireless Audio Adapter**. With this adapter a range of selected Philips wireless speaker products can connect and play the TV sound.

Consult the Philips website for suited wireless audio products for this TV.

Select a wireless speaker

When a wireless speaker is paired with the TV, you can select the speaker to play the TV sound in the Settings menu. If you connected several wireless speaker systems, you can switch between the different wireless speakers in the **Speakers** menu.

To select a wireless speaker to play the TV sound...

- 1 - Press **⏠** and select **Setup** and press **OK**.
- 2 - Select **TV settings > Sound > Sound output**.
- 3 - Press **▶** (right) and select **Wireless speaker**.
- 4 - Select the name of the wireless speaker and press **OK**. The TV speakers will switch off. If you select a wireless subwoofer the TV speakers stay switched on.
- 5 - Press **↩**, repeatedly if necessary, to close the menu.

To switch to wireless speakers in the **Speakers** menu...

- 1 - While watching TV, press **⚙**.
- 2 - Select **Speakers** and select the name of the wireless speaker and press **OK**.
- 3 - Press **↩**, repeatedly if necessary, to close the menu.

For more information on pairing a wireless speaker, press **— Keywords** and look up **Wireless speakers, connect**.

Remove a wireless speaker

You can unpair and remove a wireless speaker from the list of paired speakers.

To unpair and remove a wireless speaker...

- 1 - Press **⏠** and select **Setup** and press **OK**.
 - 2 - Select **TV settings > Sound > Sound output**.
 - 3 - Press **▶** (right) and select **Wireless speaker**.
 - 4 - Select the name of the wireless speaker and press **▶** (right).
 - 5 - Select **Remove speaker** and press **OK**. The wireless speaker is removed from the list.
 - 6 - Press **↩**, repeatedly if necessary, to close the menu.
-

Subwoofer settings

If you connect a wireless subwoofer, you can do some additional sound settings.

Volume offset

Compared to the volume of the TV, you can slightly increase or decrease the volume of the subwoofer.

- 1 - Press **⏠** and select **Setup** and press **OK**.
 - 2 - Select **TV settings > Sound > Sound output**.
 - 3 - Press **▶** (right) and select **Wireless speaker**.
 - 4 - Select the name of the wireless speaker and press **▶** (right).
 - 5 - Select **Volume offset** and press **OK**. Use the **▲** (up) and **▼** (down) keys to adjust.
 - 6 - Press **↩**, repeatedly if necessary, to close the menu.
-

Problems

Lost connection

- Position the wireless speaker within a range of 5 meters from the TV.
- Places with a high amount of wireless activity - apartments with lots of wireless routers - can hamper the wireless connection. Keep the router and wireless speaker as close to the TV as possible.

Audio and video mismatch

- There is a audio and video mismatch on the wireless speaker when you switch the **Activity style** to **Game** or **Computer**. If your game console or computer has the correct device type set in **Sources**, the switch is made automatically.
 - If you switch off picture settings like **Perfect Natural Motion** or **HD Natural Motion**, an audio and video mismatch will occur.
-

Home Theatre System

You can send the TV sound to a connected audio device - a Home Theatre System or audio system.

You can select where you want to hear the TV sound and how

you want to control it.

- If you select **Off**, you permanently switch off the TV speakers.
- If you select **TV speakers**, the TV speakers are always on.

With an audio device connected with HDMI CEC, you can use one of the EasyLink settings.

- If you select **EasyLink**, the TV sends the TV sound to the audio device. The TV will switch off the TV speakers when the device is playing the sound.
 - If you select **EasyLink autostart**, the TV will switch on the audio device, send the TV sound to the device and switch off the TV speakers.
- With EasyLink or EasyLink autostart selected, you can still switch to TV speakers if necessary.

To set the TV speakers . . .

- 1 - Press **Home** and select **Setup** and press **OK**.
- 2 - Select **TV settings** > **Sound** > **Sound output**.
- 3 - Press **Right** and select **Off**, **TV speakers**, **EasyLink** or **EasyLink autostart**.
- 4 - Press **Back**, repeatedly if necessary, to close the menu.

To switch to speakers directly . . .

- 1 - While watching TV, press **Settings**.
- 2 - Select **Speakers** and select **TV** or **Amplifier** (audio system).
- 3 - Press **Back**, repeatedly if necessary, to close the menu.

TV placement

As part of the first installation, this setting is set to either **On a TV stand** or **Wall mounted**. If you have changed the placement of the TV since then, adjust this setting accordingly for best sound reproduction.

- 1 - Press **Home** and select **Setup** and press **OK**.
- 2 - Select **TV settings** > **General settings** > **TV placement** and press **OK**.
- 3 - Select **On a TV stand** or **Wall mounted** and press **OK**.
- 4 - Press **Back**, repeatedly if necessary, to close the menu.

23.4

Ambilight

Ambilight

- Only for TVs with Ambilight.

Ambilight style

Ambilight can have a preset mode or a static mode. With preset mode, the TV follows the colours of the image on screen.

With **Static**, Ambilight has a constant static colour. You can

create an Ambilight static colour yourself. First, select the Ambilight style you prefer.

To select an Ambilight style . . .

- 1 - Press **Home** and select **Setup** and press **OK**.
- 2 - Select **TV settings** > **Ambilight** > **Ambilight style**.
- 3 - Select one of the preset style or **Off**.
- 4 - Press **Back**, repeatedly if necessary, to close the menu.

To select a static colour . . .

- 1 - Press **Home** and select **Setup** and press **OK**.
- 2 - Select **TV settings** > **Ambilight** > **Ambilight style** > **Static** and press **OK**.
- 3 - Select the colour from the colour palette. Press **OK** to confirm.
- 4 - Press **Back**, repeatedly if necessary, to close the menu.

Ambilight settings

Ambilight brightness

With Ambilight **Brightness**, you can set the level of brightness of the Ambilight.

To adjust the level . . .

- 1 - Press **Home** and select **Setup** and press **OK**.
- 2 - Select **TV settings** > **Ambilight** > **Brightness**.
- 3 - Press **OK** and adjust the value with **Up** (up) or **Down** (down).
- 4 - Press **Back**, repeatedly if necessary, to close the menu.

Ambilight saturation

With Ambilight **Saturation**, you can set the level of saturation of the Ambilight.

To adjust the level . . .

- 1 - Press **Home** and select **Setup** and press **OK**.
- 2 - Select **TV settings** > **Ambilight** > **Saturation**.
- 3 - Press **OK** and adjust the value with **Up** (up) or **Down** (down).
- 4 - Press **Back**, repeatedly if necessary, to close the menu.

Ambilight+hue

What you need

With **Ambilight+hue**, you can set up your **Philips hue** lamps to follow the **Ambilight** colours of the TV. The Philips hue lamps will expand the Ambilight effect across the room. If you don't have any Philips hue lamps yet, buy the **Philips hue Starter Kit** (includes a hue bridge and 3 hue bulbs) and install the bulbs and bridge. You can buy extra Philips hue bulbs separately.

To set up Ambilight+hue on your TV you need . . .

- a Philips hue bridge
- a few Philips hue bulbs

- this TV connected to your home network

You can do the complete Ambilight+hue setup on TV and don't need the Ambilight+hue App.

If you do download the free **Ambilight+hue App** on your smartphone or tablet later, you can use this App to adjust some Ambilight+hue settings.

Configure

Configuration steps

To configure **Philips hue** bulbs as **Ambilight+hue** bulbs, follow the steps on the following pages...



- 1 - Network
- 2 - Hue bridge
- 3 - Hue bulbs
- 4 - Configure bulb

Network

In this first step, you will prepare the TV to find the **Philips hue bridge**.

The TV and the Philips hue bridge must use the same network. Connect the Philips hue bridge to the router — the router of the network the TV is using. Switch on the hue bulbs.

To start the configuration...

- 1 - Press  (Ambilight) and switch **Ambilight On**.
- 2 - Press  and select **Setup** and press **OK**.
- 3 - Select **TV settings > Ambilight > Ambilight+hue** and press **OK**.
- 4 - Select **Ambilight+hue** one step further, select **On** and press **OK**.
- 5 - Select **Configure Ambilight+hue** and press **OK**.

If the TV is connected to your home network, it will start looking for the Philips hue bridge immediately.

If the TV is not yet connected to your network, the TV will start the network setup first. You must connect the TV to your home network.

With the TV connected to your network, go to page **Hue bridge**.

For more info on connecting the TV to your home network, press  **Keywords** and look up **Network, wireless**.

Hue bridge

In the following step, you will link up the TV with the **Philips hue bridge**.



The TV can only be linked up to one hue bridge.

To link the hue bridge...

- 1 - With the TV connected to the network, it will show the

available hue bridges. If the TV did not find your hue bridge yet, you can select **Scan again** and press **OK**.

If the TV found the only hue bridge you have, select **Next** and press **OK**.

If you have more than one hue bridge available, press  (up) or  (down) to select the hue bridge you want to use and then select **Next** and press **OK**.

2 - After you pressed **OK**, go to the **Philips hue bridge** and press the link button in the middle of the device. This will link the hue bridge with the TV. Do this within 30 seconds. The TV will confirm if a hue bridge is linked to the TV.

3 - On this confirmation, select **OK** and press **OK**.

With the Philips hue bridge linked to the TV, go to page **Hue bulbs**.

Hue bulbs

In the following step, you will select the **Philips hue bulbs** that have to follow the Ambilight.

You can select a maximum of 9 Philips hue bulbs for Ambilight+hue.

To select the bulbs for Ambilight+hue...









- 1 - In the **Configure Ambilight+hue** menu, select **Hue bulbs** and press **OK**.
- 2 - Mark the bulbs that have to follow the Ambilight. To mark a bulb, select the bulb name and press **OK**.
- 3 - When you're done, select the **OK** button and press **OK**.

With the bulbs marked for Ambilight+hue, go to page **Configure bulb**.

Configure bulb

In the following step, you will configure each **Philips hue bulb**.

To configure each hue bulb...

- 1 - Select the bulb name in the **Configure Ambilight+hue** menu and press **OK**. The bulb you selected is blinking.
- 2 - First indicate where you placed the bulb relative to the TV. A correct setting of the **Angle** will send the correct Ambilight colour to the bulb. Press  (up) or  (down) to adjust.
- 3 - Press  (right) to set the distance.
- 4 - Secondly, indicate the **Distance** between the bulb and the TV. The further away from the TV, the weaker the Ambilight colour. Press  (up) or  (down) to adjust.
- 5 - Press  (right) to set the brightness.
- 6 - Finally, set the **Brightness** of the bulb. Press  (up) or  (down) to adjust.
- 7 - To stop configuring this bulb, select **OK** and press **OK**.
- 8 - In the **Configure Ambilight+hue** menu, you can select every bulb and do the same.
- 9 - When all Ambilight+hue bulbs are configured, select **Finish** and press **OK**.

Ambilight+hue is ready for use.

You can always change the Ambilight+hue configuration later. To change the configuration, press **Home** and select **Setup > TV settings > Ambilight > Ambilight+hue**.

Immersion

With **Immersion**, you can adjust the level of the Ambilight effect for the Ambilight+hue bulbs.

To adjust the Ambilight+hue Immersion...

- 1 - Press **Home** and select **Setup** and press **OK**.
- 2 - Select **TV settings > Ambilight > Ambilight+hue > Immersion** and press **OK**.
- 3 - Press **▲** (up) or **▼** (down) to adjust.
- 4 - Press **↩**, repeatedly if necessary, to close the menu.

Info

In **View configuration**, you can consult the current Ambilight+hue configuration. Which network you use, how many bulbs are connected, etc.

To view the current Ambilight+hue setup...

- 1 - Press **Home** and select **Setup** and press **OK**.
- 2 - Select **TV settings > Ambilight > Ambilight+hue > View configuration** and press **OK**.
- 3 - Select the item you want to view and press **OK**.
- 4 - Press **↩** repeatedly if necessary, to close the menu.

Advanced Ambilight settings

Wall colour

With **Wall colour**, you can neutralise the influence of a coloured wall on the Ambilight colours. Select the colour of the wall behind the TV and the TV will modify the Ambilight colours to appear as they are intended.

To select the colour of the wall . . .

- 1 - Press **Home** and select **Setup** and press **OK**.
- 2 - Select **TV settings > Ambilight > Advanced > Wall colour**.
- 3 - Select the colour sample that matches the colour of the wall behind the TV and press **OK**.
- 4 - Press **↩**, repeatedly if necessary, to close the menu.

TV switch off

With **TV switch off**, you can set Ambilight to switch off immediately or slowly fade out when you switch off the TV. The slow fade out gives you some time to switch on the lights in your living room.

To select the TV switch off . . .

- 1 - Press **Home** and select **Setup** and press **OK**.
- 2 - Select **TV settings > Ambilight > Advanced > TV switch off**.
- 3 - Select **Fade out to off** or **Immediate switch off**.
- 4 - Press **↩**, repeatedly if necessary, to close the menu.

Lounge light mood

When the TV is on standby, you can switch Ambilight on and create a Lounge light effect in your room.

To switch Ambilight on while the TV is on standby, press **⏻** (Ambilight).

To change the Lounge light colour range, press **⏻** (Ambilight) again.

To switch off Lounge light, press and hold **⏻** (Ambilight) for a few seconds.

You can also set up the colour range in the TV settings menu.

- 1 - Switch on the TV (out of the Lounge light mode).
- 2 - Press **Home** and select **Setup** and press **OK**.
- 3 - Select **TV settings > Ambilight > Advanced > Lounge light mood** and press **OK**.
- 4 - Select the colour range you prefer.
- 5 - Press **↩**, repeatedly if necessary, to close the menu.

Lounge light+hue

If you installed Ambilight+hue, you can let the hue bulbs follow Lounge light from Ambilight. The Philips hue lamps will expand the Lounge light effect across the room. The hue bulbs are switched on and automatically set to follow Lounge light when you configure Ambilight+hue.

To switch the hue bulbs on or off...

- 1 - Press **Home** and select **Setup** and press **OK**.
- 2 - Select **TV settings > Ambilight > Advanced > Lounge light+hue**.
- 3 - Select **On** or **Off**.
- 4 - Press **↩**, repeatedly if necessary, to close the menu.

ISF for Ambilight

With **ISF**, you can ask an ISF expert to calibrate a static Ambilight colour next to the ISF picture calibration.

To select the ISF for Ambilight . . .

- 1 - Press **Home** and select **Setup** and press **OK**.
- 2 - Select **TV settings > Ambilight style > ISF**.
- 3 - Select **ISF**.
- 4 - Press **↩**, repeatedly if necessary, to close the menu.

The expert can now set the static colour in the ISF setting in Advanced Ambilight settings.

Universal access

Switch on

With **Universal access** switched on, the TV is set for use for hearing and visually impaired people.

Switch on

If you did not switch on **Universal access** during the installation, you can still switch it on in **Setup**.

To switch on Universal access . . .

- 1 - Press **Home** and select **Setup** and press **OK**.
- 2 - Select **TV settings > General settings > Universal access** and press **OK**.
- 3 - Select **On** and press **OK**.
- 4 - Press **Back**, repeatedly if necessary, to close the menu.

With Universal access switched on in Setup, the Universal access option is added in the Options menu.

Hearing impaired

Switch on

Digital TV channels can broadcast special audio commentary describing what is happening on screen.

To be able to set the visually impaired audio and effects, you have to switch on **Audio description** first.

Also, before you can switch on Audio description, you have to switch on **Universal access**.

Audio description

With Audio description, a narrator's commentary is added to the normal audio.

To switch on the commentary (if available) . . .

- 1 - With **Universal access** switched on, press **Options** and select the **Options** tab in the menu bar.
- 2 - Select **Audio description** and press **OK**.
- 3 - Select **On** and press **OK**.

You can check if an audio commentary is available.

In the Options menu, select **Audio language** and look for an audio language marked with a **+**.

Speakers / Headphones

With **Speakers / Headphones**, you can select where you want to hear the audio commentary.

On the TV speakers only, on the headphones only or on both.

To set Speakers / Headphones . . .

- 1 - Press **Home** and select **Setup** and press **OK**.
- 2 - Select **Channel settings > Languages > Audio description >**

Speakers / Headphones and press **OK**.

3 - Select **Speakers, Headphones** or **Speakers + headphones** and press **OK**.

4 - Press **Back**, repeatedly if necessary, to close the menu.

Visually impaired

Mixed volume

You can mix the volume of the normal audio with the audio commentary.

To mix the volume . . .

- 1 - Press **Options** and select **Universal access** in the menu bar.
- 2 - Select **Mixed volume** and press **OK**.
- 3 - Use the arrows up and down to set the slider bar.
- 4 - Press **OK** to confirm.

Audio effect

Some audio commentary can hold extra audio effects, like stereo or fading sound.

To switch on **Audio effects** (if available) . . .

- 1 - Press **Home** and select **Setup** and press **OK**.
- 2 - Select **Channel settings > Languages > Audio description > Audio effects** and press **OK**.
- 3 - Select **On** or **Off** and press **OK**.
- 4 - Press **Back**, repeatedly if necessary, to close the menu.

Speech

The audio commentary can also hold subtitles for the words which are spoken.

To switch on these subtitles (if available) . . .

- 1 - Press **Home** and select **Setup** and press **OK**.
- 2 - Select **Channel settings > Languages > Audio description > Speech** and press **OK**.
- 3 - Select **Descriptive** (audio) or **Subtitles** and press **OK**.
- 4 - Press **Back**, repeatedly if necessary, to close the menu.

Key beep

Key beep gives an audio feedback each time you press a key on the remote control. The volume of the beep is fixed.

To switch on Key beep . . .

- 1 - Press **Options**, select **Universal access** and press **OK**.
- 2 - Select **Key beep** and select **On**.

If Universal access does not appear in the Options menu, switch on **Universal access** in **Setup**.

For more information, press **— Keywords** and look up **Universal access**.

Specifications

24.1

Environmental

Saving energy

The **Eco settings** bundle the settings that help the environment. While you are watching TV channels, press  to open **Eco settings**.

Active settings are marked with a . You can mark or unmark each setting with the **OK** key.

Press  again to close **Eco settings**.

Energy saving

This Picture style sets the picture, together with Ambilight, in the most ideal energy conscious setting.

For more information, press  **Keywords** and look up **Picture style**.

Screen off

If you only listen to music, you can switch off the TV screen to save energy.

Select **Screen off** and press **OK**. To switch the screen back on, press any key on the remote control.

Light sensor

To save energy, the built-in ambient light sensor lowers the brightness of the TV screen when the surrounding light darkens. The built-in light sensor automatically adjusts the picture, together with Ambilight, to the lighting conditions of the room.

Switch off timer

If you do not press a key on the remote control during a 4 hour period, or if the TV receives no signal for 10 minutes, the TV switches off automatically to save energy.

If you use the TV as a monitor or use a digital receiver to watch TV (a Set-top box - STB) and you do not use the remote control of the TV, deactivate the automatic switch off.

In addition to the Eco settings, your TV also has environmentally friendly technology with regard to power consumption.

Inactive devices off

Switch off connected EasyLink HDMI-CEC (Consumer Electronic Control) compliant devices that are inactive.

European energy label

The **European Energy Label** informs you on the energy efficiency class of this product. The greener the energy efficiency class of this product is, the lower the energy it consumes.

On the label, you can find the energy efficiency class, the average

power consumption of this product in use and the average energy consumption for 1 year. You can also find the power consumption values for this product on the Philips website for your country at www.philips.com/TV

Eco-label

Philips continuously focuses on lowering the environmental impact of its innovative consumer products. We aim our efforts towards environmental improvements during manufacturing, reduction of harmful substances, energy-efficient use, end-of-life instructions and product recycling.



Thanks to our environmental effort, this TV has been awarded the **European Ecolabel** – the flower – (www.ecolabel.eu).

You can find detailed information on standby energy consumption, warranty policy, spare parts and recycling of this TV on the Philips website for your country at www.philips.com

End of use

Disposal of your old product and batteries

Your product is designed and manufactured with high quality materials and components, which can be recycled and reused.



When this crossed-out wheeled bin symbol is attached to a product it means that the product is covered by the European Directive 2002/96/EC.



Please inform yourself about the local separate collection system for electrical and electronic products.

Please act according to your local rules and do not dispose of your old products with your normal household waste. Correct disposal of your old product helps to prevent potential negative consequences for the environment and human health.

Your product contains batteries covered by the European Directive 2006/66/EC, which cannot be disposed with normal household waste.



Please find out for yourself about the local rules on separate collection of batteries because correct disposal will help to prevent negative consequences for the environment and human health.

24.2

Reception for non-satellite TVs

- Aerial input : 75 ohm coaxial (IEC75)
- Tuner bands : Hyperband; S-Channel; UHF; VHF
- DVB :
 - For model name with PxH: DVB-T (terrestrial, antenna) COFDM 2K/8K; DVB-C (cable) QAM
 - For model name with PxT: DVB-T2; DVB-C (cable) QAM
- Analogue video playback : NTSC; SECAM; PAL
- Digital video playback : MPEG2 SD/HD (ISO/IEC 13818-2); MPEG4 SD/HD (ISO/IEC 14496-10)
- Digital audio playback (ISO/IEC 13818-3)

Note: See selected countries on the TV type plate

24.3

Reception for satellite TVs

- Aerial input : 75 ohm coaxial (IEC75)
- Tuner bands : Hyperband, S-Channel, UHF, VHF
- DVB :
 - For model name with PxK: DVB-T (terrestrial, antenna) COFDM 2K/8K; DVB-C (cable) QAM; DVB-S/S2 QPSK, symbol rate 2 to 45M symbols, SCPC and MCPC
 - For model name with PxS: DVB-T2; DVB-C (cable) QAM; DVB-S/S2 QPSK, symbol rate 2 to 45M symbols, SCPC and MCPC
- Analogue video playback : NTSC, SECAM, PAL
- Digital video playback : MPEG2 SD/HD (ISO/IEC 13818-2), MPEG4 SD/HD (ISO/IEC 14496-10)
- Digital audio playback (ISO/IEC 13818-3)
- Satellite aerial input : 75 ohm F-type
- Input frequency range : 950 to 2150MHz
- Input level range : 25 to 65 dBm
- Supported satellites : Astra 19.2°E, Astra 23.5°E, Astra 28.2°E, Hotbird 13.0°E, Türksat 42.0°E, Eutelsat 7°W, Thor 1°W
- Astra HD+ support
- LNB : DiSEqC 1.0, 1 to 4 LNBs supported, Polarity selection 14/18V, Band selection 22kHz, Tone burst mode, LNB current 300mA max

Note: See selected countries on the TV type plate.

24.4

Display

Type

- Diagonal screen size :
 - 81 cm / 32 inch
 - 102 cm / 40 inch
 - 107 cm / 42 inch
 - 119 cm / 47 inch
 - 122 cm / 48 inch
 - 127 cm / 50 inch
 - 140 cm / 55 inch
 - 164 cm / 65 inch
- Display resolution : 1920x1080p

Input resolution for HD/FHD TVs

Video formats

Resolution — Refresh rate

- 480i - 60 Hz
- 480p - 60 Hz
- 576i - 50 Hz
- 576p - 50 Hz
- 720p - 50 Hz, 60 Hz
- 1080i - 50 Hz, 60 Hz
- 1080p - 24 Hz, 25 Hz, 30 Hz, 50 Hz, 60 Hz

Computer formats

Resolutions (amongst others)

- 640 x 480p - 60 Hz
- 800 x 600p - 60 Hz
- 1024 x 768p - 60 Hz
- 1280 x 768p - 60 Hz
- 1360 x 765p - 60 Hz
- 1360 x 768p - 60 Hz
- 1280 x 1024p - 60 Hz
- 1920 x 1080p - 60 Hz

Input resolution for UHD TVs

Video formats

Resolution — Refresh rate

- 480i - 60 Hz
- 480p - 60 Hz
- 576i - 50 Hz
- 576p - 50 Hz
- 720p - 50 Hz, 60 Hz
- 1080i - 50 Hz, 60 Hz

- 1080p - 24 Hz, 25 Hz, 30 Hz, 50 Hz, 60 Hz
- 2160p - 24 Hz, 25 Hz, 30 Hz

Computer formats

Resolutions (amongst others)

- 640 × 480p - 60 Hz
- 800 × 600p - 60 Hz
- 1024 × 768p - 60 Hz
- 1280 × 768p - 60 Hz
- 1360 × 765p - 60 Hz
- 1360 × 768p - 60 Hz
- 1280 × 1024p - 60 Hz
- 1920 × 1080p - 60 Hz
- 3840 × 2160p - 24 Hz, 25 Hz, 30 Hz

24.5

Power

Product specifications are subject to change without notice. For more specification details of this product, see www.philips.com/support

Power

- Mains power : AC 220-240V +/-10%
- Ambient temperature : 5°C to 35°C
- Standby power consumption : < 0.3W
- Power saving features : Energy saving, Screen off, Light sensor*, Switch off timer, Inactive devices off.

The power rating stated on the product typeplate is the power consumption for this product during normal household use (IEC 62087 Ed.2). The maximum power rating, stated between brackets, is used for electrical safety (IEC 60065 Ed. 7.2).

24.6

Dimensions and weights (7500 series)

42PFx7509

- without TV stand:
Width 950 mm - Height 554 mm - Depth 35.8 mm - Weight ±11.5 kg
- with TV stand:
Width 950 mm - Height 647 mm - Depth 240 mm - Weight ±12.8 kg

47PFx7509

- without TV stand:
Width 1061 mm - Height 616 mm - Depth 35.8 mm - Weight ±13.7 kg
- with TV stand:
Width 1061 mm - Height 676 mm - Depth 240 mm - Weight ±15 kg

55PFx7509

- without TV stand:

Width 1230.6 mm - Height 712 mm - Depth 35.8 mm - Weight ±19.5 kg

- with TV stand:

Width 1230.6 mm - Height 772 mm - Depth 280 mm - Weight ±21 kg

65PFx75x9

- without TV stand:

Width 1445.9 mm - Height 829.4 mm - Depth 54.5 mm - Weight ±25 kg

- with TV stand:

Width 1445.9 mm - Height 882.7 mm - Depth 315 mm - Weight ±26 kg

24.7

Dimensions and weights (7100 series)

42PFx7109

- without TV stand:

Width 949 mm - Height 551 mm - Depth 53 mm - Weight ±10.8 kg

- with TV stand:

Width 949 mm - Height 612 mm - Depth 213 mm - Weight ±12 kg

42PFx7179/7189

- without TV stand:

Width 950 mm - Height 554 mm - Depth 35.8 mm - Weight ±11.5 kg

- with TV stand:

Width 950 mm - Height 647 mm - Depth 240 mm - Weight ±12.8 kg

42PFx7199

- without TV stand:

Width 950 mm - Height 554 mm - Depth 35.8 mm - Weight ±11.5 kg

- with TV stand:

Width 950 mm - Height 690 mm - Depth 240 mm - Weight ±14 kg

47PFx7109

- without TV stand:

Width 1060 mm - Height 620 mm - Depth 53 mm - Weight ±12.9 kg

- with TV stand:

Width 1060 mm - Height 677 mm - Depth 222 mm - Weight ±14.2 kg

47PFx7179/7189

- without TV stand:

Width 1061 mm - Height 616 mm - Depth 35.8 mm - Weight ±13.7 kg

- with TV stand:

Width 1061 mm - Height 676 mm - Depth 240 mm - Weight ±15 kg

47PFx7199

- without TV stand:

Width 1061 mm - Height 616 mm - Depth 35.8 mm - Weight ± 13.7 kg

- with TV stand:

Width 1061 mm - Height 676 mm - Depth 240 mm - Weight ± 16.4 kg

55PFx7109

- without TV stand:

Width 1230.6 mm - Height 716.1 mm - Depth 53.5 mm -

Weight ± 17.4 kg

- with TV stand:

Width 1230.6 mm - Height 770 mm - Depth 280 mm - Weight ± 18.9 kg

55PFx7179/7189

- without TV stand:

Width 1230.6 mm - Height 712 mm - Depth 35.8 mm - Weight ± 19.5 kg

- with TV stand:

Width 1230.6 mm - Height 772 mm - Depth 280 mm - Weight ± 21 kg

55PFx7199

- without TV stand:

Width 1230.6 mm - Height 712 mm - Depth 35.8 mm - Weight ± 19.5 kg

- with TV stand:

Width 1230.6 mm - Height 772 mm - Depth 246 mm - Weight ± 22.4 kg

24.8

Dimensions and weights (6600/6700 series)

40PFx6719

- without TV stand:

Width 911.3 mm - Height 528 mm - Depth 61.8 mm - Weight ± 8.1 kg

- with TV stand:

Width 911.3 mm - Height 587.3 mm - Depth 213.1 mm - Weight ± 9.3 kg

48PFx6719

- without TV stand:

Width 1082 mm - Height 625 mm - Depth 57 mm - Weight ± 10.8 kg

- with TV stand:

Width 1082 mm - Height 683 mm - Depth 223 mm - Weight ± 12.2 kg

40PFx6609

- without TV stand:

Width 911.3 mm - Height 528 mm - Depth 61.8 mm - Weight ± 8.1 kg

- with TV stand:

Width 911.3 mm - Height 587.3 mm - Depth 213.1 mm - Weight ± 9.3 kg

48PFx6609

- without TV stand:

Width 1082 mm - Height 625 mm - Depth 57 mm - Weight ± 10.8 kg

- with TV stand:

Width 1082 mm - Height 683 mm - Depth 223 mm - Weight ± 12.2 kg

55PFx6609

- without TV stand:

Width 1230.6 mm - Height 714.8 mm - Depth 53.5 mm -

Weight ± 17.4 kg

- with TV stand:

Width 1230.6 mm - Height 774.8 mm - Depth 280 mm - Weight ± 18.9 kg

65PFx6659

- without TV stand:

Width 1445.9 mm - Height 829.4 mm - Depth 54.5 mm - Weight ± 25 kg

- with TV stand:

Width 1445.9 mm - Height 882.7 mm - Depth 315 mm - Weight ± 26 kg

24.9

Dimensions and weights (6500 series)

32PFx6500

- without TV stand:

Width 725.7 mm - Height 429.2 mm - Depth 55.4 mm - Weight ± 5.2 kg

- with TV stand:

Width 725.7 mm - Height 484.6 mm - Depth 179.4 mm - Weight ± 6.4 kg

42PFx6500

- without TV stand:

Width 957 mm - Height 554.5 mm - Depth 61.8 mm - Weight ± 8.6 kg

- with TV stand:

Width 957 mm - Height 615.5 mm - Depth 213.1 mm - Weight ± 9.8 kg

47PFx6500

- without TV stand:

Width 1068 mm - Height 623 mm - Depth 61.8 mm - Weight ± 8 kg

- with TV stand:

Width 1068 mm - Height 676.8 mm - Depth 222 mm - Weight ± 9 kg

55PFx6500

- without TV stand:

Width 1230.6 mm - Height 714.8 mm - Depth 53.5 mm - Weight ± 17.4 kg

- with TV stand:

Width 1230.6 mm - Height 774.8 mm - Depth 280 mm - Weight ± 18.9 kg

Connectivity for three side connector

TV Rear

- Audio In (DVI to HDMI): Stereo mini-jack 3.5mm
- CVBS: Audio L/R, CVBS in, RGB
- SCART: Audio L/R, CVBS in, RGB
- YPbPr : Y Pb Pr, Audio L/R : Stereo mini-jack 3.5mm
- Digital Audio out: Optical, Toslink
- Network LAN : RJ45

TV Downside

- HDMI in with ARC
- USB 2.0

TV Side

- HDMI in with ARC
- USB 2.0
- Common interface slot: CI+/CAM
- Headphones: Stereo mini-jack 3.5mm

- Containers : 3GP, AVCHD, AVI, MPEG-PS, MPEG-TS, MPEG-4, Matroska (MKV), Quicktime (MOV, M4V, M4A), Windows Media (ASF/WMV/WMA)
- Video Codecs : MPEG-1, MPEG-2, MPEG-4 Part 2, MPEG-4 Part 10 AVC (H264), VC-1, WMV9
- Audio Codecs : AAC, HE-AAC (v1/v2), AMR-NB, Dolby Digital, Dolby Digital Plus, DTS 2.0 + Digital Out™, MPEG-1/2/2.5 Layer I/II/III (includes MP3), WMA (v2 to v9.2), WMA Pro (v9/v10)
- Subtitles :
 - Formats : SAMI, SubRip (SRT), SubViewer (SUB), MicroDVD (TXT), mplayer2 (TXT), TMPlayer (TXT)
 - Character encodings : UTF-8, Central Europe and Eastern Europe (Windows-1250), Cyrillic (Windows-1251), Greek (Windows-1253), Turkish (Windows-1254), Western Europe (Windows-1252)
- Image Codecs : JPEG
- Limitations :
 - Maximum supported total bit rate for a media file is 30Mbps.
 - Maximum supported video bit rate for a media file is 20Mbps.
 - MPEG-4 AVC (H.264) is supported up to High Profile @ L4.1.
 - VC-1 is supported up to Advanced Profile @ L3.

Wi-Fi Certified Miracast™*

This TV supports WiDi 4.x devices.

Supported media server software (DMS)*

- PC - Microsoft Windows XP, Vista or Windows 7
 - You can use any DLNA certified® media server software.
 - Microsoft - Windows Media Player
- Mac OS X
 - You can use any DLNA certified® media server software.
- Mobile devices
 - Philips MyRemote - iOS, Android
 - Interoperability and performance may vary, depending on the capabilities of the mobile device and the software used.

ESD regulations

This apparatus meets performance criteria A for ESD. In case the apparatus does not recover in file sharing mode due to electrostatic discharge, user interference is required.

* Only for Smart TVs.

Connectivity for two side connector

TV Rear

- Audio In (DVI to HDMI): Stereo mini-jack 3.5mm
- CVBS: Audio L/R, CVBS in, RGB
- SCART: Audio L/R, CVBS in, RGB
- YPbPr : Y Pb Pr, Audio L/R : Stereo mini-jack 3.5mm
- Digital Audio out: Optical, Toslink
- Network LAN : RJ45
- HDMI in with ARC
- USB

TV Side

- HDMI in with ARC
- USB 2.0
- Common interface slot: CI+/CAM
- Headphones: Stereo mini-jack 3.5mm

Multimedia

Connections

- USB 2.0
- Ethernet LAN RJ-45*
- Wi-Fi 802.11b/g/n (built-in)*

Supported USB file systems

- FAT 16, FAT 32, NTFS

Playback formats

Software

25.1

Software update

Update from USB

It might be necessary to update the TV software. You need a computer with an high-speed Internet connection and a USB memory device to upload the software on the TV. Use a USB memory device with 256MB free space. Make sure that write protection is switched off.

1 - Start the update on TV

Press **▲**, select **Setup** and press **OK**.

Select **Update software > USB** and press **OK**.

2 - Identify the TV

Insert the USB memory into one of the USB connections of the TV.

Select **Start** and press **OK**. An identification file is written on the USB memory device.

3 - Download the TV software

Insert the USB memory into your computer.

On the USB memory device, locate the file **update.htm** and double click it.

Click on **Send ID**.

If new software is available, download the .zip file.

After the download, unzip the file and copy the file **autorun.upg** onto the USB memory device.

Do not place this file in a folder.

4 - Update the TV software

Insert the USB memory into the TV again. The update starts automatically.

The TV switches itself off for 10 seconds and then back on again. Please wait.

Do not . . .

- use the remote control
- remove the USB memory device from the TV

If a power cut occurs during the update, never remove the USB memory device from the TV. When the power returns, the update will continue.

At the end of the update, the message **Operation successful** appears on screen. Remove the USB memory device and press **⏻** on the remote control.

Do not . . .

- press **⏻** twice
- press the power switch on the TV

The TV switches itself off (for 10 seconds) and then back on again. Please wait.

The TV software has been updated. You can use the TV again. To prevent an accidental update of the TV software, delete the **autorun.upg** file from the USB memory device.

Update from Internet

If the TV is connected to the Internet, you may receive a message from TP Vision to update the TV software. You need a high-speed (broadband) Internet connection.

If you receive this message, we recommend you carry out the update.

Select **Update**. Follow the instructions on screen.

You can also look for new updates yourself.

To look for an update . . .

1 - Press **▲** and select **Setup** and press **OK**.

2 - Select **Update software > TV with Internet**, then press **OK**. Follow the instructions on screen.

When the update is complete, the TV switches off and back on again automatically.

Wait for the TV to switch itself back on.

Do not press the Power switch **⏻** on the TV.

25.2

Software version

To view the current TV software version . . .

1 - Press **▲** and select **Setup** and press **OK**.

2 - Select **Software settings** and press **OK**.

3 - Select **Current software info** and see **Release Version**.

4 - Press **⏻**, repeatedly if necessary, to close the menu.

25.3

Open source software

This television contains open source software. TP Vision Europe B.V. hereby offers to deliver, upon request, a copy of the complete corresponding source code for the copyrighted open source software packages used in this product for which such offer is requested by the respective licences.

This offer is valid up to three years after product purchase to anyone in receipt of this information.

To obtain the source code, please write in English to . . .

Intellectual Property Dept.

TP Vision Europe B.V.

Prins Bernhardplein 200

1097 JB Amsterdam

The Netherlands

Open source license

Acknowledgements and License Texts for any open source software used in this Philips TV.

This is a document describing the distribution of the source code used on the Philips TV, which fall either under the GNU General Public License (the GPL), or the GNU Lesser General Public License (the LGPL), or any other open source license. Instructions to obtain source code for this software can be found in the user manual.

PHILIPS MAKES NO WARRANTIES WHATSOEVER, EITHER EXPRESS OR IMPLIED, INCLUDING ANY WARRANTIES OF MERCHANTABILITY OR FITNESS FOR A PARTICULAR PURPOSE, REGARDING THIS SOFTWARE. Philips offers no support for this software. The preceding does not affect your warranties and statutory rights regarding any Philips product(s) you purchased. It only applies to this source code made available to you.

Freetype (2.4.3)

FreeType is a software font engine that is designed to be small, efficient, highly customizable, and portable while capable of producing high-quality output (glyph images). This piece of software is made available under the terms and conditions of the FreeType Project license, which can be found below.

Source: <http://freetype.sourceforge.net>

zlib (1.2.3)

The 'zlib' compression library provides in-memory compression and decompression functions, including integrity checks of the uncompressed data.

This piece of software is made available under the terms and conditions of the zlib license, which can be found below.

Source: <http://www.zlib.net/>

Fraunhofer AAC Ecnoder (3.3.3)

AAC Ecnoder.

Source: Android JB source code

unicode (3.2)

This library is used to perform UNICODE string manipulation.

This piece of software is made available under the terms and conditions of the ICU license, which can be found below.

Source: <http://www.icu-project.org/>

libpng (1.2.43)

PNG decoder.

This piece of software is made available under the terms and conditions of the libpng license, which can be found below.

Source: <http://www.libpng.org/pub/png/libpng.html>

libjpg (6b)

This library is used to perform JPEG decoding tasks.

This piece of software is made available under the terms and conditions of the libjpg license, which can be found below.

Source: <http://www.ijg.org/>

libmng (1.0.10)

libmng -THE reference library for reading, displaying, writing and examining Multiple-Image Network Graphics.MNG is the animation extension to the popular PNG image-format.

This piece of software is made available under the terms and conditions of the libmng license, which can be found below.

Source: <http://sourceforge.net/projects/libmng/files/>

u-Boot loader (1.3.4)

Used by boot loader and only linked with boot loader, GPL license.

This piece of software is made available under the terms and conditions of the u-Boot loader license, which can be found below.

Source: <http://sourceforge.net/projects/u-boot/files/u-boot/U-Boot-1.1.4/u-boot-1.1.4.tar.bz2/download>

Libcurl (7.21.7)

HTTP client;libcurl is a free and easy-to-use client-side URL transfer library, supporting FTP, FTPS, HTTP, HTTPS, SCP, SFTP, TFTP, TELNET, DICT, LDAP, LDAPS, FILE, IMAP, SMTP, POP3 and RTSP. libcurl supports SSL certificates, HTTP POST, HTTP PUT, FTP uploading, HTTP form based upload, proxies, cookies, user+password authentication (Basic, Digest, NTLM, Negotiate, Kerberos4), file transfer resume, http proxy tunneling and more!

This piece of software is made available under the terms and conditions of the Libcurl license, which can be found below.

Source: <http://curl.haxx.se/>

c-ares (1.7.4)

c-ares is a C library that performs DNS requests and name resolves asynchronously.

This piece of software is made available under the terms and conditions of the c-ares license, which can be found below.

Source: <http://c-ares.haxx.se/c-ares-1.7.1.tar.gz>

openssl (1.0.0d)

OpenSSL is an open source implementation of the SSL and TLS protocols. The core library (written in the C programming language) implements the basic cryptographic functions and provides various utility functions. Wrappers allowing the use of the OpenSSL library in a variety of computer languages are available.

This piece of software is made available under the terms and conditions of the 1.7.4 license, which can be found below.

Source: <http://www.openssl.org/source/openssl-1.0.0.tar.gz>

Expat (2.01)

xml parser; Expat is an XML parser library written in C. It is a stream-oriented parser in which an application registers handlers for things the parser might find in the XML document (like start tags). An introductory article on using.

This piece of software is made available under the terms and conditions of the Expat license, which can be found below.

Source: <http://expat.sourceforge.net/>

DirectFB include SAWMAN (1.4.0)

It is a software library for GNU/Linux/UNIX based operating system with a small memory footprint that provides graphics acceleration, input device handling and abstraction layer, and integrated windowing system with support for translucent windows and multiple display layers on top of the Linux framebuffer without requiring any kernel modifications.

This piece of software is made available under the terms and conditions of the DirectFB license, which can be found below.

Source: http://sourceforge.net/projects/jointspace/files/remote_applications_SDK/remote_applications_SDK_v1.3.1/DirectFB141_source_1.3.1.7z/download

SAWMAN

SquashFS is a compressed read-only file system for Linux.

SquashFS compresses files, inodes and directories, and supports block sizes up to 1 MB for greater compression. SquashFS is also the name of free/open software, licensed under the GPL, for accessing SquashFS filesystems.

Source: <http://squashfs.sourceforge.net/>

Linux Kernel (3.0)

The Linux kernel is an operating system kernel used by the Linux family of Unix-like operating systems.

This piece of software is made available under the terms and conditions of the Linux Kernel license, which can be found below.

Source: <http://www.kernel.org>

SQLite (3.7.2)

SQLite is a in-process library that implements a self-contained, serverless, zero-configuration, transactional SQL database engine.

This piece of software is made available under the terms and conditions of the SQLite license, which can be found below.

Source: <http://www.sqlite.org/download.html>

SquashFS (3.4)

SquashFS is a compressed read-only file system for Linux.

SquashFS compresses files, inodes and directories, and supports block sizes up to 1 MB for greater compression. SquashFS is also the name of free/open software, licensed under the GPL, for accessing SquashFS filesystems.

This piece of software is made available under the terms and conditions of the SquashFS license, which can be found below.

Source: <http://squashfs.sourceforge.net/>

glibc (2.6.1)

Any Unix-like operating system needs a C library: the library which defines the "system calls" and other basic facilities such as open, malloc, printf, exit...The GNU C library is used as the C library in the GNU system and most systems with the Linux kernel

This piece of software is made available under the terms and conditions of the glibc license, which can be found below.

Source: <http://www.gnu.org/software/libc/>

mtd-utils (1)

The aim of the system is to make it simple to provide a driver for new hardware, by providing a generic interface between the hardware drivers and the upper layers of the system. Hardware drivers need to know nothing about the storage formats used, such as FTL, FFS2, etc., but will only need to provide simple routines for read, write and erase. Presentation of the device's contents to the user in an appropriate form will be handled by the upper layers of the system.

This piece of software is made available under the terms and conditions of the mtd-utils license, which can be found below.

Source: <http://www.linux-mtd.infradead.org/index.html>

libusb (1.0.6)

This is the home of libusb, a library that gives user level applications uniform access to USB devices across many different operating systems. libusb is an open source project licensed under the GNU Lesser General Public License version 2.1. Many participants in the libusb community have helped and continue to help with ideas, implementation, support and improvements for libusb.

This piece of software is made available under the terms and conditions of the libusb license, which can be found below.

Source:

<http://libusb.wiki.sourceforge.net>

<http://www.libusb.org/>

libusb-compat (0.1.3)

Library to enable user space application programs to communicate with USB devices.

This piece of software is made available under the terms and conditions of the libusb-compat license, which can be found below.

Source: <http://libusb.wiki.sourceforge.net/LibusbCompat0.1>

NTFS-3G Read/Write Driver (2010.5.22)

NTFS-3G is an open source cross-platform implementation of the Microsoft Windows NTFS file system with read-write support. NTFS-3G often uses the FUSE file system interface, so it can run unmodified on many different operating systems. It is runnable on Linux, FreeBSD, NetBSD, OpenSolaris, BeOS, QNX, WinCE, Nucleus, VxWorks, Haiku, MorphOS, and Mac OS X It is licensed under either the GNU General Public License or a proprietary license. It is a partial fork of ntfsprogs and is under active maintenance and development.

This piece of software is made available under the terms and conditions of the NTFS-3G Read/Write Driver license, which can be found below.

Source: <http://www.tuxera.com>

WPA Supplicant (0.5.10 & 0.6.7)

These packages are used to provide WiFi access. The supplier for these tools is Atheros. These pieces of software are made available under the terms and conditions of the GPL v2 license, which can be found below.

This piece of software is made available under the terms and conditions of the WPA Supplicant license, which can be found below.

Source: http://hostap.epitest.fi/wpa_supplicant/

ntfsprogs (2.0.0)

Some useful tool for ntfs file system.

This piece of software is made available under the terms and conditions of the ntfsprogs license, which can be found below.

Source: <http://sourceforge.net/projects/linux-ntfs>

fuse (2.8.4)

Fuse is a simple interface for userspace programs to export a virtual filesystem to the linux kernel.

This piece of software is made available under the terms and conditions of the fuse license, which can be found below.

Source: <http://fuse.sourceforge.net/>

libiconv (1.11.1)

This library provides an iconv() implementation, for use on systems which don't have one, or whose implementation cannot convert from/to Unicode. .

This piece of software is made available under the terms and conditions of the libiconv license, which can be found below.

Source: <http://ftp.gnu.org/pub/gnu/libiconv>

electric-fence (2.1.13)

Used for memory corruption detection.

This piece of software is made available under the terms and conditions of the electric-fence license, which can be found below.

Source: http://perens.com/FreeSoftware/ElectricFence/electric-fence_2.1.13-0.1.tar.gz

liveMedia

When Wifi Display or streaming RtspPlayer are enabled.

This piece of software is made available under the terms and conditions of the electric-fence license, which can be found below.

Source: www.live555.com

QT (4.7.0)

Netflix skype besttv pandora picasa? will use QT.

This piece of software is made available under the terms and conditions of the QT license, which can be found below.

Source: <http://qt.nokia.com/>

e2fsprogs (1.41.14)

e2fsprogs provides the filesystem utilities for use with the ext2 filesystem, it also supports the ext3 and ext4 filesystems.

This piece of software is made available under the terms and conditions of the e2fsprogs license, which can be found below.

Source: <http://e2fsprogs.sourceforge.net/>

alsa (1.0.24.1)

Advanced Linux Sound Architecture (ALSA).

This piece of software is made available under the terms and conditions of the alsa license, which can be found below.

Source: <http://www.alsa-project.org>

lvm2 (2.02.89)

DM_VERITY.

This piece of software is made available under the terms and conditions of the lvm2 license, which can be found below.

Source: <ftp://sources.redhat.com/pub/lvm2/releases/>

encfs (1.3.2)

A library provides an encrypted filesystem in user-space.

Source: <http://www.arg0.net/encfs>

boost (1.15.0)

A library provides free peer-reviewed portable C++ source libraries is used for encfs.

Source: <http://www.boost.org>

rlog (1.4)

A library that provides a flexible message logging facility for C programs and libraries is used for encfs.

Source: <http://www.arg0.net/rlog>

iptables (1.4.15)

For Cross connection.

Source: <http://www.netfilter.org/projects/iptables/>

bash (3.2.48)

Bash is the shell, or command language interpreter, that will appear in the GNU operating system.

Bash is an sh-compatible shell that incorporates useful features from the Korn shell (ksh) and C shell (csh).

It is intended to conform to the IEEE POSIX P1003.2/ISO 9945.2 Shell and Tools standard.

It offers functional improvements over sh for both programming and interactive use.

In addition, most sh scripts can be run by Bash without modification.

Source: <http://www.gnu.org/software/bash/>

coreutils (6.9)

The GNU Core Utilities are the basic file, shell and text manipulation utilities of the GNU operating system.

These are the core utilities which are expected to exist on every operating system.

Source: <http://www.gnu.org/software/coreutils/>

findutils (4.2.31)

The GNU Find Utilities are the basic directory searching utilities of the GNU operating system.

These programs are typically used in conjunction with other programs to provide modular and powerful directory search and file locating capabilities to other commands.

Source: <http://www.gnu.org/software/findutils/>

gawk (3.1.5)

If you are like many computer users, you would frequently like to make changes in various text files wherever certain patterns appear, or extract data from parts of certain lines while discarding the rest.

To write a program to do this in a language such as C or Pascal is a time-consuming inconvenience that may take many lines of

code.

The job is easy with awk, especially the GNU implementation:

gawk.

Source: <http://www.gnu.org/software/gawk/>

grep (2.5.1a)

The grep command searches one or more input files for lines containing a match to a specified pattern. By default, grep prints the matching lines.

Source: <http://www.gnu.org/software/grep/>

gzip (1.3.12)

GNU Gzip is a popular data compression program originally written by Jean-loup Gailly for the GNU project. Mark Adler wrote the decompression part.

Source: <http://www.gnu.org/software/gzip/>

inetutils (1.4.2)

Inetutils is a collection of common network programs.

Source: <http://www.gnu.org/software/inetutils/>

iputils (s20101006)

The iputils package is set of small useful utilities for Linux networking. It was originally maintained by Alexey Kuznetsov.

Source: <http://www.skbuff.net/iputils/>

module-init-tools (3.12)

Provides developer documentation for the utilities used by Linux systems to load and manage kernel modules (commonly referred to as "drivers").

Source: https://modules.wiki.kernel.org/index.php/Main_Page

ncurses (5.7)

The Ncurses (new curses) library is a free software emulation of curses in System V Release 4.0, and more.

It uses Terminfo format, supports pads and color and multiple highlights and forms characters and function-key mapping, and has all the other SYSV-curses enhancements over BSD Curses.

Source: <http://www.gnu.org/software/ncurses/>

net-tools (1.6)

The Net-tools?package is a collection of programs for controlling the network subsystem of the Linux kernel.

Source: <http://www.linuxfromscratch.org/blfs/view/6.3/basicnet/net-tools.html>

procps (ps, top) (3.2.8)

procps is the package that has a bunch of small useful utilities that give information about processes using the /proc filesystem.

The package includes the programs ps, top, vmstat, w, kill, free, slabtop, and skill.

Source: <http://procps.sourceforge.net/index.html>

psmisc (22.13)

This PSmisc package is a set of some small useful utilities that use the proc filesystem. We're not about changing the world, but providing the system administrator with some help in common tasks.

Source: <http://psmisc.sourceforge.net/>

sed (4.1.5)

sed (stream editor) isn't an interactive text editor. Instead, it is used to filter text, i.e., it takes text input, performs some operation (or set of operations) on it, and outputs the modified text.

sed is typically used for extracting part of a file using pattern matching or substituting multiple occurrences of a string within a file.

Source: <http://www.gnu.org/software/sed/>

tar (1.17)

GNU Tar provides the ability to create tar archives, as well as various other kinds of manipulation.

For example, you can use Tar on previously created archives to extract files, to store additional files, or to update or list files which were already stored.

Source: <http://www.gnu.org/software/tar/>

util-linux-ng (2.18)

Various system utilities.

Source: <http://userweb.kernel.org/~kzak/util-linux-ng/>

udhcpd (0.9.8cvs20050303-3)

Udhcpd is a very small?DHCP?client geared towards?embedded systems.

Source:

<http://udhcp.sourceforge.com/downloads/0.9.8cvs20050303-3/>

Libxml2 (2.7.8)

The "libxml2" library is used in AstroTV as a support for the execution of NCL application. This library was developed for the GNOME software suite and is available under a "MIT" license.

Source: <http://www.xmlsoft.org>

uriparser (0.7.7)

For MPEG-DASH

Source: <http://uriparser.sourceforge.net/>

xerces-c++ (3.1.1)

For MPEG-DASH

Source: <http://xerces.apache.org/>

webp (0.2.1)

For Netflix

Source: <https://code.google.com/p/webp/>

wget (1.10.2)

GNU Wget is a free software package for retrieving files using HTTP, HTTPS and FTP, the most widely-used Internet protocols.

It is a non-interactive commandline tool, so it may easily be called from scripts,?cron?jobs, terminals without X-Windows support, etc.

Source: <http://ftp.gnu.org/gnu/wget/wget-1.10.2.tar.gz>

wireless_tools (0.29)

The Wireless Tools (WT) is a set of tools allowing to manipulate the Wireless Extensions. They use a textual interface and are rather crude, but aim to support the full Wireless Extension.
Source: http://www.hpl.hp.com/personal/Jean_Toumihes/Linux/Tools.html

ezxml (0.8.6)
ezXML is a C library for parsing XML documents. Used inside Philips libraries.
Source: <http://sourceforge.net/projects/ezxml/>

SQLite (3.7.7.1)
SQLite is a in-process library that implements a self-contained, serverless, zero-configuration, transactional SQL database engine.
Source: <http://www.sqlite.org/download.html>

AES (aes-src-29-04-09.zip)
Advanced Encryption Standard (AES) is a specification for the encryption of electronic data. Used inside Philips libraries.
Source: <http://gladman.plushost.co.uk/oldsite/AES/>

microhttpd (libmicrohttpd-0.9.9.tar.gz)
GNU libmicrohttpd is a small C library that is supposed to make it easy to run an HTTP server as part of another application. The original download site for this software is :
<http://www.gnu.org/software/libmicrohttpd/> This piece of software is made available under the terms and conditions of the LGPL v2.1 license
Source:
<http://ftp.gnu.org/gnu/libmicrohttpd/libmicrohttpd-0.9.9.tar.gz>

yajl (lloyd-yajl-2.0.1-0-gf4b2b1a.tar.gz)
YAJL is a small event-driven (SAX-style) JSON parser written in ANSI C, and a small validating JSON generator. YAJL is released under the ISC license.
The original download site for this software is :
<http://lloyd.github.com/yajl/> This piece of software is made available under the terms and conditions of the ISC license
Source: <http://pkgs.fedoraproject.org/repo/pkgs/yajl/lloyd-yajl-2.0.1-0-gf4b2b1a.tar.gz/df6a751e7797b9c2182efd91b5d64017/lloyd-yajl-2.0.1-0-gf4b2b1a.tar.gz>

HMAC-SHA1 (0.1)
keyed-hash message authentication code (HMAC) is a specific construction for calculating a message authentication code (MAC) involving a cryptographic hash function in combination with a secret cryptographic key.
As with any MAC, it may be used to simultaneously verify both the data integrity and the authentication of a message.
Any cryptographic hash function, such as MD5 or SHA-1, may be used in the calculation of an HMAC; the resulting MAC algorithm is termed HMAC-MD5 or HMAC-SHA1 accordingly.
Source: http://www.deadhat.com/wlancrypto/hmac_sha1.c

gSoap (2.7.15)

The gSOAP toolkit is an open source C and C++ software development toolkit for SOAP/XML Web services and generic (non-SOAP) C/C++ XML data bindings.
Part of the software embedded in this product is gSOAP software. Portions created by gSOAP are Copyright 2000-2011 Robert A. van Engelen, Genivia inc. All Rights Reserved.
Source: <http://sourceforge.net/projects/gsoap2/>

jquery (1.10.2)
jQuery is a fast and concise JavaScript Library that simplifies HTML document traversing, event handling, animating, and Ajax interactions for rapid web development.
Source: <http://jquery.com/>

Libupnp (1.2.1)
The Linux* SDK for UPnP* Devices (libupnp) provides developers with an API and open source code for building control points, devices, and bridges that are compliant with Version 1.0 of the UPnP Device Architecture Specification.
Source: <http://upnp.sourceforge.net/>

mDNSResponder (mDNSResponder-320.10.80)
The mDNSResponder project is a component of Bonjour, Apple's ease-of-use IP networking initiative: <<http://developer.apple.com/bonjour/>>
In our project, Bonjour is used for the automatic discovery of devices and services
Source: <http://developer.apple.com/bonjour/>

Troubleshooting and support

26.1

Troubleshooting

Channels

No digital channels found during the installation

See the technical specifications to make sure that your TV supports DVB-T or DVB-C in your country. Make sure that all cables are properly connected and that the correct network is selected.

Previously installed channels are not in the channel list

Make sure that the correct channel list is selected.

General

The TV does not switch on

- Disconnect the power cable from the power outlet. Wait for one minute then reconnect it.
- Make sure that the power cable is securely connected.

Creaking sound at startup or switch off

When you are turning the TV on, off or to standby, you hear a creaking sound from the TV chassis. The creaking sound is due to the normal expansion and contraction of the TV as it cools and warms up. This does not affect performance.

TV does not respond to the remote control

The TV requires some time to start up. During this time, the TV does not respond to the remote control or TV controls. This is normal behaviour.

If the TV continues to be unresponsive to the remote control, you can check if the remote control is working by means of a mobile phone camera. Put the phone in camera mode and point the remote control to the camera lens. If you press any key on the remote control and you notice the infra red LED flicker through the camera, the remote control is working. The TV needs to be checked.

If you do not notice the flickering, the remote control might be broken or its batteries are low.

This method of checking the remote control is not possible with remote controls which are wirelessly paired with the TV.

The TV goes back to standby after showing the Philips startup screen

When the TV is in standby, a Philips startup screen is displayed, then the TV returns to standby mode. This is normal behaviour.

When the TV is disconnected and reconnected to the power supply, the startup screen is displayed at the next startup. To switch on the TV from standby, press on the remote control or the TV.

The standby light keeps on blinking

Disconnect the power cable from the power outlet. Wait 5 minutes before you reconnect the power cable. If the blinking reoccurs, contact Philips TV Consumer Care.

Wrong menu language

Change the language back to your language.

- 1 - Press **▲** and select **Setup** and press **OK**.
- 2 - Select **TV settings** > **General settings** > **Menu language** and press **OK**.
- 3 - Select the language you want and press **OK**.
- 4 - Press **↵**, repeatedly if necessary, to close the menu.

Picture

No picture / distorted picture

- Make sure that the antenna is properly connected to the TV.
- Make sure that the correct device is selected as the display source.
- Make sure that the external device or source is properly connected.

Sound but no picture

- Make sure that the picture settings are set correctly.

Poor antenna reception

- Make sure that the antenna is properly connected to the TV.
- Loud speakers, unearthed audio devices, neon lights, high buildings and other large objects can influence reception quality. If possible, try to improve the reception quality by changing the antenna direction or moving devices away from the TV.
- If reception on only one channel is poor, fine-tune this channel.

Poor picture from a device

- Make sure that the device is connected properly.
- Make sure that the picture settings are set correctly.

Picture settings change after a while

Make sure that **[Location]** is set to **[Home]**. You can change and save settings in this mode.

A commercial banner appears

Make sure that **[Location]** is set to **[Home]**.

Picture does not fit the screen

Change to a different picture format. Press **📺**.

Picture format keeps changing with different channels

Select a non 'Auto' picture format.

Picture position is incorrect

Picture signals from some devices may not fit the screen correctly. Check the signal output of the connected device.

Computer picture is not stable

Make sure that your PC uses the supported resolution and refresh rate.

Sound

No sound or poor sound quality

If no audio signal is detected, the TV automatically switches the audio output off — this does not indicate malfunction.

- Make sure that the sound settings are correctly set.
- Make sure that all cables are properly connected.
- Make sure that the volume is not muted or set to zero.
- Make sure that the TV audio output is connected to the audio input on the Home Theatre System.

Sound should be heard from the HTS speakers.

- Some devices may require you to manually enable HDMI audio output. If HDMI audio is already enabled, but you still do not hear audio, try changing the digital audio format of the device to PCM (Pulse Code Modulation). Refer to the documentation accompanying your device for instructions.

Connections

HDMI

- Note that HDCP (High-bandwidth Digital Content Protection) support can delay the time taken for a TV to display content from an HDMI device.
- If the TV does not recognise the HDMI device and no picture is displayed, switch the source from one device to another and back again.
- If there are intermittent sound disruptions, make sure that output settings from the HDMI device are correct.
- If you use an HDMI-to-DVI adapter or HDMI-to-DVI cable, make sure that an additional audio cable is connected to AUDIO IN (mini-jack only), if available.

EasyLink does not work

- Make sure that your HDMI devices are HDMI-CEC compatible. EasyLink features only work with devices that are HDMI-CEC compatible.

No volume icon shown

- When a HDMI-CEC audio device is connected this behaviour is normal.

Photos, videos and music from a USB device do not show

- Make sure that the USB storage device is set to Mass Storage Class compliant, as described in the storage device's documentation.
- Make sure that the USB storage device is compatible with the TV.
- Make sure that the audio and picture file formats are supported by the TV.

Choppy playback of USB files

- The transfer performance of the USB storage device may limit the data transfer rate to the TV which causes poor playback.

26.2

Register

Register your TV and enjoy a range of benefits including full support (including downloads), privileged access to information about new products, exclusive offers and discounts, the chance to win prizes and even participate in special surveys about new releases.

Go to www.philips.com/welcome

26.3

Help

This TV offers help on screen.

Open Help

- 1 - Press  to open the Home menu.
- 2 - Select **Help** and press **OK**.

To look up topics alphabetically, select **Keywords**.

To read the Help as a book, select **Book**.

Before you execute the Help instructions, close Help.

To close Help, press .

Direct help

Press the  key (blue) to open Help immediately. Help will open on the chapter that is most relevant to what you are doing or what is selected on TV.

For some activities, like Text (Teletext), the colour keys have specific functions and cannot open Help.

TV Help on your tablet, smartphone or computer

To carry out extended sequences of instructions more easily, you can download the TV Help in PDF format to read on your smartphone, tablet or computer. Alternatively, you can print the relevant Help page from your computer.

To download the Help (user manual) go to

www.philips.com/support

26.4

Online help

To solve any Philips TV related problem, you can consult our online support. You can select your language and enter your product model number.

Go to www.philips.com/support .

On the support site you can find your country's telephone number to contact us as well as answers to frequently asked questions (FAQs). In some countries, you can chat with one of our collaborators and ask your question directly or send a question by email.

You can download new TV software or the manual to read on your computer.

26.5

Consumer Care / Repair

For support and repair, call the Consumer Care hotline in your country. Find the telephone number in the printed documentation that came with the TV.

Or consult our website www.philips.com/support .

TV model number and serial number

You might be asked to provide the TV product model number and serial number. Find these numbers on the packaging label or on the type label on the back or bottom of the TV.

Warning

Do not attempt to repair the TV yourself. This may cause severe injury, irreparable damage to your TV or void your warranty.

Safety and care

27.1

Safety

Important

Read and understand all safety instructions before you use the TV. If damage is caused by failure to follow instructions, the warranty does not apply.

Secure the TV from falling over

Always use the supplied wall bracket to secure the TV from falling over. Mount the bracket and secure the TV onto the bracket, even if you put the TV on the floor.

You can find the mounting instructions in the Quick Start Guide that came with the TV. In case you lost this guide, you can download the guide from www.philips.com. Use the product type number of the TV to look for the Quick Start Guide to download.

Risk of electric shock or fire

- Never expose the TV to rain or water. Never place liquid containers, such as vases, near the TV. If liquids are spilt on or into the TV, disconnect the TV from the power outlet immediately. Contact Philips TV Consumer Care to have the TV checked before use.
- Never expose the TV, remote control or batteries to excessive heat. Never place them near burning candles, naked flames or other heat sources, including direct sunlight.
- Never insert objects into the ventilation slots or other openings on the TV.
- Never place heavy objects on the power cord.
- Avoid force coming onto power plugs. Loose power plugs can cause arcing or fire. Ensure that no strain is exerted on the power cord when you swivel the TV screen.
- To disconnect the TV from the mains power, the power plug of the TV must be disconnected. When disconnecting the power, always pull the power plug, never the cord. Ensure that you have full access to the power plug, power cord and outlet socket at all times.

Risk of injury or damage to the TV

- Two people are required to lift and carry a TV that weighs more than 25 kg or 55 lbs.
- If you mount the TV on a stand, only use the supplied stand. Secure the stand to the TV tightly. Place the TV on a flat, level surface that can support the weight of the TV and the stand.
- When wall mounted, ensure that the wall mount can safely bear the weight of the TV set. TP Vision bears no responsibility for improper wall mounting that results in accident, injury or damage.
- Parts of this product are made of glass. Handle with care to avoid injury or damage.

Risk of damage to the TV !

Before you connect the TV to the power outlet, ensure that the power voltage matches the value printed on the back of the TV. Never connect the TV to the power outlet if the voltage is different.

Risk of injury to children

Follow these precautions to prevent the TV from toppling over and causing injury to children:

- Never place the TV on a surface covered by a cloth or other material that can be pulled away.
- Ensure that no part of the TV hangs over the edge of the mounting surface.
- Never place the TV on tall furniture, such as a bookcase, without anchoring both the furniture and TV to the wall or a suitable support.
- Teach children about the dangers of climbing on furniture to reach the TV.

Risk of swallowing batteries !

The remote control may contain coin-type batteries which can easily be swallowed by small children. Keep these batteries out of reach of children at all times.

Risk of overheating

Never install the TV in a confined space. Always leave a space of at least 10 cm or 4 inches around the TV for ventilation. Ensure curtains or other objects never cover the ventilation slots on the TV.

Lightning storms

Disconnect the TV from the power outlet and antenna before lightning storms.

During lightning storms, never touch any part of the TV, power cord or antenna cable.

Risk of hearing damage

Avoid using earphones or headphones at high volumes or for prolonged periods of time.

Low temperatures

If the TV is transported in temperatures below 5°C or 41°F, unpack the TV and wait until the TV temperature reaches room temperature before connecting the TV to the power outlet.

Humidity

In rare occasions, depending on temperature and humidity, minor condensation can occur on the inside of the TV glass front (on some models). To prevent this, do not expose the TV to direct sunlight, heat or extreme humidity. If condensation occurs, it will disappear spontaneously while the TV is playing for a few hours.

The condensation moisture will not harm the TV or cause malfunction.

27.2

Screen care

- Never touch, push, rub or strike the screen with any object.
- Unplug the TV before cleaning.
- Clean the TV and frame with a soft damp cloth and wipe gently. Avoid touching the Ambilight LEDs on the backside of the TV. Never use substances such as alcohol, chemicals or household cleaners on the TV.
- To avoid deformations and colour fading, wipe off water drops as quickly as possible.
- Avoid stationary images as much as possible. Stationary images are images that remain onscreen for extended periods of time. Stationary images include onscreen menus, black bars, time displays, etc. If you must use stationary images, reduce screen contrast and brightness to avoid screen damage.

Terms of use, copyrights and licenses

28.1

Terms of use

2014 © TP Vision Europe B.V. All rights reserved.

This product was brought to the market by TP Vision Europe B.V. or one of its affiliates, hereinafter referred to as TP Vision, which is the manufacturer of the product. TP Vision is the warrantor in relation to the TV with which this booklet was packaged. Philips and the Philips Shield Emblem are registered trademarks of Koninklijke Philips N.V.

Specifications are subject to change without notice. Trademarks are the property of Koninklijke Philips N.V or their respective owners. TP Vision reserves the right to change products at any time without being obliged to adjust earlier supplies accordingly.

The written material packaged with the TV and the manual stored in the memory of the TV or downloaded from the Philips website are believed to be adequate for the intended use of the system.

The material in this manual is believed adequate for the intended use of the system. If the product, or its individual modules or procedures, are used for purposes other than those specified herein, confirmation of their validity and suitability must be obtained. TP Vision Europe B.V. warrants that the material itself does not infringe any United States patents. No further warranty is expressed or implied. TP Vision Europe B.V. cannot be held responsible neither for any errors in the content of this document nor for any problems as a result of the content in this document. Errors reported to Philips will be adapted and published on the Philips support website as soon as possible. Terms of warranty Risk of injury, damage to TV or void of warranty! Never attempt to repair the TV yourself. Use the TV and accessories only as intended by the manufacturer. The caution sign printed on the back of the TV indicates risk of electric shock. Never remove the TV cover. Always contact Philips TV Customer Care for service or repairs. Any operation expressly prohibited in this manual, or any adjustments and assembly procedures not recommended or authorised in this manual, shall void the warranty. Pixel characteristics This LCD/LED product has a high number of colour pixels. Although it has effective pixels of 99.999% or more, black dots or bright points of light (red, green or blue) may appear constantly on the screen. This is a structural property of the display (within common industry standards) and is not a malfunction. CE compliance This product is in compliance with the essential requirements and other relevant provisions of Directives 2006/95/EC (Low Voltage), 2004/108/EC (EMC) and 2011/65/EU (ROHS). Compliance with EMF TP Vision Europe B.V. manufactures and sells many products targeted at

consumers which, like any electronic apparatus, in general have the ability to emit and receive electromagnetic signals. One of Philips' leading Business Principles is to take all necessary health and safety measures for our products, to comply with all applicable legal requirements and to stay well within the Electro Magnetic Field (EMF) standards applicable at the time of producing the products. Philips is committed to develop, produce and market products that cause no adverse health effects. TP Vision confirms that, as long as its products are handled properly for their intended use, they are safe to use according to scientific evidence available today. Philips plays an active role in the development of international EMF and safety standards, enabling Philips to anticipate further developments in standardisation for early integration in its products.

28.2

Copyrights and licenses

HDMI



HDMI®

The terms HDMI and HDMI High-Definition Multimedia Interface, and the HDMI Logo are trademarks or registered trademarks of HDMI Licensing LLC in the United States and other countries.

Dolby



Dolby®

Manufactured under license from Dolby Laboratories. Dolby and the double-D symbol are trademarks of Dolby Laboratories.

DTS 2.0 + Digital Out™



DTS 2.0 + Digital Out™

Manufactured under license under U.S. Patent Nos: 5,956,674; 5,974,380; 6,487,535 and other U.S. and worldwide patents issued and pending. DTS, the Symbol, and DTS and the Symbol together are registered trademarks and DTS 2.0+Digital Out is a trademark of DTS, Inc. Product includes software. © DTS, Inc.

Skype



Skype™

© 2013 Skype and/or Microsoft. The Skype name, associated trade marks and logos and the "S" logo are trade marks of Skype or related entities.

Skype is a trademark of Skype or its related companies. Although this product has been tested and met our certification standards for audio and video quality, it is not endorsed by Skype, Skype Communications S.a.r.l. or any of their related companies.

DLNA Certified®



© 2013 Digital Living Network Alliance. All rights reserved.
© 2013 DLNA. All rights reserved.

DTV_i



The DTV_i brand and logo are registered marks of Pontifical Catholic University of Rio de Janeiro (PUC-Rio) and the Federal University of Paraíba (UFPB).

Java



Java and all Java based trademarks are registered trademarks of Oracle and/or its affiliates, in the United States and other countries.

Microsoft



Windows Media

Windows Media is either a registered trademark or trademark of Microsoft Corporation in the United States and/or other countries.

Microsoft PlayReady

Content owners use Microsoft PlayReady™ content access technology to protect their intellectual property, including copyrighted content.

This device uses PlayReady technology to access PlayReady-protected content and/or WMDRM-protected content. If the device fails to properly enforce restrictions on content usage, content owners may require Microsoft to revoke the device's ability to consume PlayReady-protected content. Revocation should not affect unprotected content or content protected by other content access technologies. Content owners may require you to upgrade PlayReady to access their content. If you decline an upgrade, you will not be able to access content that requires the upgrade.

Wi-Fi Alliance



Wi-Fi®, the Wi-Fi CERTIFIED logo, the Wi-Fi logo are registered trademarks of the Wi-Fi Alliance. **Wi-Fi CERTIFIED Miracast™**, **Miracast™** are trademarks of the Wi-Fi Alliance.

MHEG software

The copyright in MHEG software ("the Software") comprised in this television ("this product") and included to enable you to use interactive television features is owned by S&T CLIENT SYSTEMS LIMITED ("the Owner"). You are permitted to use the Software only in conjunction with this product.

Kensington



Kensington and Micro Saver are registered US trademarks of ACCO World Corporation with issued registrations and

pending applications in other countries throughout the world.

Other trademarks

All other registered and unregistered trademarks are the property of their respective owners.

Index

3

- 3D backlight contrast 79
- 3D, 2D to 3D conversion 51
- 3D, health warning 52
- 3D, optimal viewing 52

A

- Active control 79
- Activity style 82
- Ambilight+hue 86
- Ambilight, ISF 88
- Ambilight, Lounge light 88
- Ambilight, mode 86
- Ambilight, TV placement 7
- Ambilight, TV switch off 88
- Ambilight, wall colour 88
- Amplifier, audio system 84
- Antenna connection 8
- Antenna connection, tips 12
- App, gallery 69
- App, rental videos 69
- Apps, feedback 69
- Apps, lock 71
- Apps, open 73
- Apps, recommended 75
- Apps, search 77
- Audio commentary 89
- Audio description 91
- Audio language 34
- Audio Out - Optical 13
- Audio to video sync 16
- Auto subtitle shift 14
- Auto surround 3D 83
- Auto volume levelling 84
- Automatic channel update 35

B

- Backlight contrast 81
- Bass 83
- Blu-ray Disc, connect 17
- Brightness 81
- Brightness, word mark 23

C

- CAM - Conditional Access Module 14
- CAM, install 15
- Channel list copy 36
- Channel list copy 36
- Channel lock 31
- Channel package, update 42
- Channel packages 41
- Channel update message 37
- Channel, favourite 30
- Channel, options 31
- Channel, problems 102
- Channel, status 33
- Channel, switch 30
- Channels, rename 31
- Channels, update 39
- Child lock code 33

- CI+ 16
- Clear LCD 82
- Clear sound 84
- Clock 49
- Colour 79
- Colour, Colour enhancement 80
- Colour, Colour temperature 80
- Common Interface slot 17
- Connectivity guide 12
- Consumer Care 104
- Contact Philips 106
- Contrast 83
- Contrast, Brightness 83
- Contrast, Contrast modes 80
- Contrast, Dynamic contrast 81
- Contrast, Gamma 81
- Contrast, Light sensor 81
- Contrast, Perfect contrast 81
- Contrast, Video contrast 81

D

- Digital Text 32
- Disposal of TV or batteries 91
- DVB (Digital Video Broadcast) 36
- DVB, settings 37
- DVI, connect 12

E

- EasyLink 13
- EasyLink, connection 14
- EasyLink, settings 16
- Eco settings 91
- End of use 93
- ESD 95
- European Ecolabel 91
- European Energy Label 91

F

- Facebook 68
- Favourite channel list 32
- Frequency scan 37

G

- Game console, connect 18
- Game or computer 84
- Game or computer, game 53
- Game, play 55
- Gamma 83

H

- HbbTV 34
- HD Natural Motion 82
- HDCP, copy protection 16
- HDMI ARC 12
- HDMI CEC 15
- HDMI connection, tips 18
- HDMI Ultra HD 12
- Headphones 21
- Headphones volume 84
- Hearing impaired 89

- Help 103
- Home Theatre System, connect 16
- Home Theatre System, multichannel 16
- Home Theatre System, problems 17
- Home Theatre System, sound 85
- Home Theatre System, volume leveling 17

I

- Incredible surround 83
- Infrared sensor 28
- Interactive TV, about 34
- Interactive TV, what you need 36
- Internet memory, clear 10
- ISF® Calibration 80

I

- iTV 36

J

- JointSpace 74

K

- Keyboard, connect 19

L

- Language, audio 36
- Language, menus and messages 34
- Language, original 38
- Light sensor 83
- Location 83
- Lounge light 90

M

- Manual installation 38
- Media servers, supported 97
- Menu language 36
- Miracast, block/unblock 57
- Miracast, share a screen 57
- Miracast, stop sharing 57
- Miracast™ 56
- Motion, Clear LCD 84
- Motion, HD Natural Motion 84
- Motion, Perfect Natural Motion 82
- Mouse, connect 19
- MPEG artefact reduction 82
- Multi room, about 71
- Multi room, setup 71
- Multi room, use 71
- Music, playback 56
- MyRemote App, about 74
- MyRemote App, channel bar 77
- MyRemote App, control 76
- MyRemote App, download 75
- MyRemote App, JointSpace 76
- MyRemote App, network 74
- MyRemote App, recording 75
- MyRemote App, SimplyShare 75
- MyRemote App, TV guide 77
- MyRemote App, TV name 75
- MyRemote App, watch TV 77
- MyRemote App, Wi-Fi smart screen 76

N

- Network frequency 37
- Network frequency mode 37
- Network router 9

- Network, DHCP 11
- Network, password 13
- Network, problems 10
- Network, settings 12
- Network, Static IP 15
- Network, wired 10
- Network, wireless 9
- Noise reduction 82

O

- On and Off 23
- On screen Help 105
- Online support 103
- Online TV 70
- Open source software 96
- Options, on a channel 35
- Original language 40

P

- Parental rating 35
- Pause TV 58
- Perfect Natural Motion 84
- Philips hue 88
- Photo camera, connect 20
- Photos, slideshow 55
- Photos, videos and music 55
- Picture style 79
- Picture, backlight contrast 85
- Picture, colour 81
- Picture, problems 102
- Picture, sharpness 79
- Pixel Plus link 18
- Playback formats 99
- Pointer, about 27
- Pointer, speed 28
- Pointer, switch off 28
- Pointer, use 27
- Power connection 7
- Power consumption, check 93
- PTA209, wireless audio adapter 85

Q

- Quick picture settings 78

R

- Radio channel 32
- Reception quality 37
- Recording, list of recordings 59
- Recording, record now 59
- Recording, schedule a recording 59
- Recording, Skype calls 65
- Recording, watch a 60
- Recording, what you need 59
- Recording, what you need 18
- Red button 38
- Remote control, accents and symbols 27
- Remote control, azerty 27
- Remote control, keyboard 26
- Remote control, pairing 28
- Remote control, pointer 29
- Remote control, qwerty 29
- Remote control, qwerty and azerty 26
- Remote control, qwerty and cyrillic 26
- Remote control, uppercase 26
- Rename channels 33

Rental videos 71

Repair 108

S

Safety instructions 105

Satellite, add 42

Satellite, age rating 40

Satellite, channel list 39

Satellite, channel update 43

Satellite, connection 8

Satellite, hearing impaired 44

Satellite, installation 41

Satellite, lock channels 40

Satellite, Multi-Dwelling-Unit 41

Satellite, packages 43

Satellite, remove 43

Satellite, rename channels 43

Satellite, Unicable 42

SCART connection, tips 13

Screen care 106

Screen off 95

Screen off 58

Sharpness 81

Sharpness, MPEG artefact reduction 84

Sharpness, Noise reduction 84

Sharpness, super resolution 81

Sharpness, ultra resolution 82

Shop location 85

Skype, auto sign in 65

Skype, camera zoom, pan and tilt 67

Skype, contacts 63

Skype, during recording 67

Skype, install camera 61

Skype, menu 62

Skype, Microsoft account 62

Skype, missed calls 65

Skype, new account 61

Skype, receiving a call 69

Skype, rental movies and Pause TV 71

Skype, sign in 61

Skype, video call 64

Skype, what you need 61

Skype™, what 61

Sleep timer 49

Smart TV, about 68

Smart TV, internet 79

Smart TV, open 70

Smart TV, overview 68

Smart TV, PIN code 68

Smart TV, register 70

Smart TV, start page 70

Software, current version 95

Sound style 83

Sound, problems 103

Standby 25

Subtitles 33

Subtitles, pause TV 60

Subtitles, recording 59

Support, online 105

Surround mode 85

Switch off timer 49

Switching on 27

Symbol rate 37

Symbol rate mode 39

Synchronise audio and video 18

T

Teletext 34

Text 36

Treble 83

TV clock 51

TV guide 47

TV guide, clock 53

TV network name 14

TV on Demand 72

TV placement 86

TV speakers 86

Twitter 72

U

Ultra HD 4

Ultra HD, connection 14

Unicable 44

Universal access 89

Universal access, audio effect 89

Universal access, hearing impaired 91

Universal access, mixed volume 89

Universal access, Speakers / Headphones 89

Universal access, speech 89

USB flash drive, connect 20

USB Hard Drive, disc space 20

USB Hard Drive, installation 19

USB keyboard 21

USB mouse 21

V

Video selection 37

Videos, playback 56

Viewing distance 9

Visually impaired 93

W

Watch TV 34

Wi-Fi 11

Wi-Fi Certified Miracast™ 58

Wi-Fi smart screen 78

Wi-Fi smart screen, channel bar 79

Wi-Fi smart screen, tool bar 77

Wired network 12

Wireless installation 17

Wireless speakers, about 87

Wireless speakers, connect 22

Wireless speakers, remove 85

Wireless speakers, select 85

Wireless speakers, subwoofer settings 85

Word mark, brightness 25

World Wide Web 81

WPS - PIN code 19

WPS - Wi-Fi Protected Setup 21

Y

YPbPr connection, tips 13



Contact information

Argentina

0800 444 7749

Buenos Aires 0810 444 7782

België / Belgique

070 700 035 (0,15€/min.)

Bosna i Hercegovina

033 941 251 (Lokalni poziv)

Brazil

0800 701 0245

Sao Paulo 2938 0245

България

02 4916 273 (Национален номер)

Česká republika

228880895 (Místní tarif)

Danmark

3525 8314

Deutschland

0180 501 04 69 (0,14€/Min.)

Ελλάδα

2111983028 (Εθνική κλήση)

España

902 88 10 83 (0,10€ + 0,08€/min.)

Estonia

6683061 (Kohalikud kõned)

France

01 57 32 40 50 (local)

Hrvatska

01 777 66 01 (Lokalni poziv)

Italia

0245 28 70 14 (chiamata nazionale)

Ireland

0818 210 140 (national call)

Northern Ireland

0844 338 04 88 (5p/min BT landline)

Казакстан

8 10 800 2000 00 04 (free)

Latvia

6616 3263 (Vietējais tarifs)

Lithuania

8 5 214 0293 (Vietiniais tarifais)

Luxembourg / Luxemburg

2487 1100 (Nationale Ruf / appel national)

Magyarország

06 1 700 8151 (Belföldi hívás)

Nederland

0900 202 08 71 (0,10€/min.)

Norge

22 97 19 14

Österreich

0820 40 11 33 (0,145€/Min.)

Polska

22 397 15 04 (Połączenie lokalne)

Portugal707 78 02 25 (0,12€/min. - Móvel
0,30€/min.)**Română**

031 6300042 (Tarif local)

Россия

8-800-22 00004 (бесплатно)

Suisse / Schweiz / Svizzera

0848 000 291 (0,081 CHF/Min.)

Србија

011 321 6840 (Lokalni poziv)

Slovakia

2 332 154 93 (Vnútroštátny hovor)

Slovenija

1 888 83 12 (Lokalni klic)

Suomi

09 88 62 50 40

Sverige

08 5792 9096 (lokalsamtal)

ประเทศไทย (Thailand)

02 652 7650

Türkiye

444 8 445

United Kingdom

0844 338 04 88 (5p/min BT landline)

Україна

0-800-500-480 (безкоштовно)

www.philips.com/support

Non-contractual images / Images non contractuelles / Außervertragliche Bilder

Specifications are subject to change without notice.

Philips and the Philips' shield emblem are registered trademarks of Koninklijke Philips N.V. and are used under license from Koninklijke Philips Electronics N.V.

All registered and unregistered trademarks are property of their respective owners.

2014 © TP Vision Europe B.V. All rights reserved.

www.philips.com

