

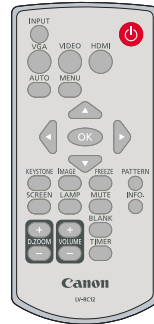

MULTIMEDIA PROJECTOR LV-WU360/LV-WX370/LV-X350 User's Manual

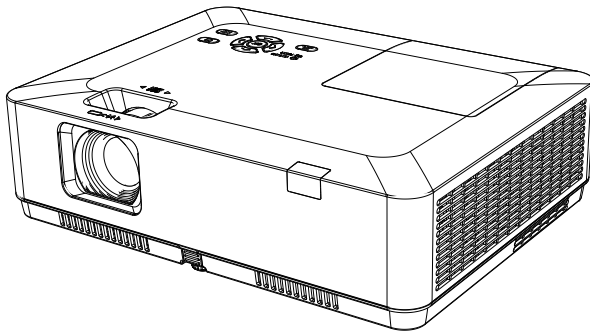

Features and design

This Projector is designed for portability, durability, and ease of use. This projector has built-in multimedia features, and support the LCD technology by using the color depth of 1.07 billion color.

Simple Computer System Setting

The projector has the Multi-scan system to conform to many computer output signals quickly. Up to WUXGA resolution can be accepted.

Useful Functions for Presentations

The digital zoom function allows you to focus on the crucial information during a presentation.

Lamp Control

Brightness of the projection lamp can be selected.

Logo Function (LV-WX370, LV-X350)

The Logo function allows you to customize the screen logo. You can capture any image on the screen.

Multilanguage Menu Display

The screen menu of the projector is available in 26 languages: English, German, French, Italian, Spanish, Polish, Swedish, Dutch, Portuguese, Japanese, Simplified Chinese, traditional Chinese, Korean, Russian, Arabic, Turkish, Finnish, Norwegian, Danish, Indonesian, Hungarian, Czech, Kazakh, Vietnamese, Thai, Farsi.

Convenient Maintenance Functions

Lamp and filter maintenance functions provide for better and proper maintenance of the projector.

Security Function

The Security function helps you to ensure security of the projector. With the Key lock function, you can lock the operation on the control panel or remote control. Passcode lock function prevents unauthorized use of the projector.

Auto Setup Function

This function enables input source search, AUTO PC adjust and AUTO Keystone by simple pressing the AUTO button on the remote control.

Colorboard Function

At the time of simple projection on the colored wall, you can get the close color image to the color image projected on a white screen by selecting the similar color to the wall color from the preset four colors.

Power Management

The Power management function reduces power consumption and maintains the lamp life.

Closed Caption

This is a printed version of the program sound or other information displayed on the screen. You can turn on the feature and switch the channels.

✓Note:

- The screen menu and images in the manual may slightly differ from the real product.
- The manual is subject to change without prior notice.

Content

Features and design	2	Remote controller operation.....	46
Content	3	Input selection	48
Safety Precautions	5	Display	50
Safety Precautions	5	Auto PC adj.....	50
CAUTION ON HANGING FROM THE CEILING.....	5	Fine sync.....	50
READ AND KEEP THIS OWNER'S MANUAL FOR LATER USE.....	6	H position	50
AC Power Cord Requirement.....	8	V position	51
Federal Communication Commission Notice	9	H size	51
Safety Symbols in this Manual	10	Aspect	51
Precautions for Use	11	Image Flip H/V	52
For Safe Use	18	Menu position.....	53
Before Installation	21	Background display	53
Open Source Software	25	Signal Format	54
Accessory	26	Color adjust	56
Name and function of your projector 27		Image mode	56
Front/top.....	27	Color adjust.....	57
Rear	27	Setting	58
Bottom.....	27	Direct Power On.....	58
Terminal.....	28	Standby mode.....	58
Top control panel and indicators	29	High altitude	59
Remote controller.....	30	Lamp control	59
Install battery of remote controller... 31		Cooling Fast.....	60
Remote controller operation range... 31		Closed caption	60
Installation	32	Key lock	61
Set up your projector.....	32	IRIS	61
Adjust the projected image.....	33	Sound	61
Connect to PC.....	34	HDMI Input Range.....	62
Connect to video equipment	35	Advanced	63
Connect to audio equipment	36	Language	63
Connect to USB	37	Auto setup.....	64
Connect the AC power cord	38	keystone.....	64
Basic operation	39	Logo	67
Power on your projector	39	Security	68
Power off your projector	40	Power management.....	69
How to use the OSD	41	Filter counter	70
Menu item overview	42	Test pattern	71
Adjust the Projector Zoom and Focus	43	Network.....	72
Auto setting function.....	44	Factory default	72
Keystone adjustment	44	Lamp counter	73
H/VKeystone	44	Memory Viewer	74
Volume adjustment	45	Start slide	74
Menu operation	45	Slide transition effect.....	74
		Sort order	74
		Rotate	75
		Best fit	75
		Repeat	75

Content

Apply	75
Info	76
Network control	77
Useful function	91
Memory Viewer	91
USB display function	93
Maintenance and cleaning	96
WARNING light indicator.....	96
Clean the lens	97
Clean casing of your projector	97
Clean the filter	98
Reset the filter counter	98
Lamp replacement	99
Lamp unit	99
Appendix	101
Troubleshooting	101
Menu tree.....	102
Light indicator status	107
Supported Signal Types	108
Terminal configuration	109
Dimensions	110
Specifications	111
RS232 control mode	113

Safety Precautions

Safety Precautions

WARNING:

- **THIS APPARATUS MUST BE GROUNDED.**
- **TO REDUCE THE RISK OF FIRE OR ELECTRIC SHOCK, DO NOT EXPOSE THIS APPLIANCE TO RAIN OR MOISTURE.**

- This projector produces intense light from the projection lens. Do not stare directly into the lens, otherwise eye damage could result. Be especially careful that children do not stare directly into the beam.
- Install the projector in a proper position. Otherwise it may result in a fire hazard.
- Do not cover the ventilation slots on the projector. Heat build-up can reduce the service life of your projector, and can also be dangerous.
- If the projector is unused for an extended time, unplug the projector from the power outlet.
- Do not project the same image for a long time.

An afterimage may remain on the LCD panels due to the characteristics of the panels of the projector.

CAUTION ON HANGING FROM THE CEILING

When hanging the projector from the ceiling, clean the air intake vents and top of the projector periodically with a vacuum cleaner. If you leave the projector unclean for a long time, the cooling fans can be clogged with dust, and it may cause a breakdown or a disaster.

DO NOT SET THE PROJECTOR IN GREASY, WET, OR SMOKY CONDITIONS SUCH AS IN A KITCHEN TO PREVENT A BREAKDOWN OR A DISASTER. IF THE PROJECTOR COMES IN CONTACT WITH OIL OR CHEMICALS, IT MAY BECOME DETERIORATED.

Safety Precautions

■ READ AND KEEP THIS OWNER'S MANUAL FOR LATER USE.

All the safety and operating instructions should be read before beginning to operate the product.

Read all of the instructions given here and retain them for later use. Unplug this projector from the AC power supply before cleaning. Do not use liquid or aerosol cleaners on the projector. Use a damp cloth for cleaning.

Follow all warnings and instructions marked on the projector.

For added protection of the projector during a lightning storm, or when it is left unattended or unused for long periods of time, unplug it from the wall outlet. This will prevent damage due to lightning and power surges.

Do not expose this unit to rain or use near water... for example, in a wet basement, near a swimming pool, etc...

Do not use attachments not recommended by the manufacturer as they may result in hazards.

Do not place this projector on an unstable cart, stand, or table. The projector may fall, causing serious injury to a child or adult, and serious damage to the projector. Use only with a cart or stand recommended by the manufacturer, or sold with the projector. Wall or shelf mounting should be carried out in accordance with the manufacturer's directions, and should use a mounting kit approved by the manufacturers.

An appliance and cart combination should be moved with care. Sudden stops, excessive force, and uneven surfaces may cause the appliance and cart combination to overturn.



Slots and openings in the rear and front of the cabinet are provided for ventilation, to insure reliable operation of the equipment and to protect it from overheating.

The openings should never be covered with cloth or other materials, and the bottom opening should not be blocked by placing the projector on a bed, sofa, rug, or other similar surface. This projector should never be placed near or over a radiator or heat register.

This projector should not be placed in a built-in installation such as a book case unless proper ventilation is provided.

Safety Precautions

Never push objects of any kind into this projector through cabinet slots as they may touch dangerous voltage points or short out parts that could result in a fire or electric shock. Never spill liquid of any kind onto the projector.

Do not install the projector near the ventilation duct of air-conditioning equipment.

This projector should be operated using only the type of power source indicated on the marking label. If you are not sure of the type of power supplied, contact the Canon Customer Support Center or local power company.

Do not overload wall outlets and extension cords as this can result in fire or electric shock. Do not allow anything to rest on the power cord. Do not locate this projector where the cord may be damaged by people walking on it.

Do not attempt to service this projector yourself as opening or removing covers may expose you to dangerous voltages or other hazards. Refer all servicing to qualified service personnel.

Unplug this projector from the wall outlet and refer servicing to qualified service personnel under the following conditions:

- a. When the power cord or plug is damaged or frayed.
- b. If liquid has been spilled into the projector.
- c. If the projector has been exposed to rain or water.
- d. If the projector does not operate normally after following the operating instructions. Adjust only those controls that are covered in the operating instructions as improper adjustment of other controls may result in damage and will often require extensive work by a qualified technician to restore the projector to normal operating condition.
- e. If the projector has been dropped or the cabinet has been damaged.
- f. When the projector exhibits a distinct change in performance-this indicates a need for servicing.

When replacement parts are required, be sure the service technician uses replacement parts specified by the manufacturer that have the same characteristics as the original parts. Unauthorized substitutions may result in fire, electric shock, or injury.

Upon completion of any service or repairs to this projector, ask the service technician to perform routine safety checks to determine that the projector is in safe operating condition.

AC Power Cord Requirement

The AC Power Cord supplied with this projector meets the requirements for use in the country you purchased it.

AC Power Cord for the United States and Canada:

The AC Power Cord used in the United States and Canada is listed by the Underwriters Laboratories (UL) and certified by the Canadian Standard Association (CSA).

The AC Power Cord has a grounding-type AC line plug. This is a safety feature to ensure the plug fits into the power outlet. Do not try to tamper with this safety feature. Should you be unable to insert the plug into the outlet, contact your electrician.

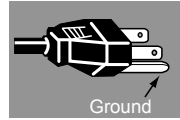

THE SOCKET-OUTLET SHOULD BE INSTALLED NEAR THE EQUIPMENT AND EASILY ACCESSIBLE.



For the U.S. and Canada, LAMP (S) INSIDE THIS PRODUCT CONTAIN MERCURY AND MUST BE RECYCLED OR DISPOSED OF ACCORDING TO LOCAL, MUNICIPAL, STATE, PROVINCIAL, OR FEDERAL LAWS. For lamp recycling and disposal information please call 1-800-OK-CANON for the U.S. and Canada.



Only for European Union and EEA (Norway, Iceland and Liechtenstein)

These symbols indicate that this product is not to be disposed of with your household waste, according to the WEEE Directive (2012/19/EU), the Battery Directive (2006/66/EC) and/or national legislation implementing those Directives.



If a chemical symbol is printed beneath the symbol shown above, in accordance with the Battery Directive, this indicates that a heavy metal (Hg = Mercury, Cd = Cadmium, Pb = Lead) is present in this battery or accumulator at a concentration above an applicable threshold specified in the Battery Directive.

This product should be handed over to a designated collection point, e.g., on an authorized one-for-one basis when you buy a new similar product or to an authorized collection site for recycling waste electrical and electronic equipment (EEE) and batteries and accumulators. Improper handling of this type of waste could have a possible impact on the environment and human health due to potentially hazardous substances that are generally associated with EEE. Your cooperation in the correct disposal of this product will contribute to the effective usage of natural resources.

For more information about the recycling of this product, please contact your local city office, waste authority, approved scheme or your household waste disposal service or visit

www.canon-europe.com/weee, or www.canon-europe.com/battery.

Federal Communication Commission Notice

This device complies with Part 15 of the FCC Rules. Operation is subject to the following two conditions:

- (1) This device may not cause harmful interference, and
- (2) this device must accept any interference received, including interference that may cause undesired operation.

Note: This equipment has been tested and found to comply with the limits for a Class B digital device, pursuant to Part 15 of the FCC Rules. These limits are designed to provide reasonable protection against harmful interference in a residential installation. This equipment generates, uses and can radiate radio frequency energy and, if not installed and used in accordance with the instructions, may cause harmful interference to radio communications. However, there is no guarantee that interference will not occur in a particular installation. If this equipment does cause harmful interference to radio or television reception, which can be determined by turning the equipment off and on, the user is encouraged to try to correct the interference by one or more of the following measures:

- Reorient or relocate the receiving antenna.
- Increase the separation between the equipment and receiver.
- Connect the equipment into an outlet on a circuit different from that to which the receiver is connected.
- Consult the dealer or an experienced radio/TV technician for help.

The cable with a ferrite core provided with the projector must be used with this equipment in order to comply with Class B limits in Subpart B of Part 15 of the FCC Rules.

Use of a shielded cable is required to comply with class B limits in Subpart B of Part 15 of FCC Rules.

Do not make any changes or modifications to the equipment unless otherwise specified in the instructions.

If such changes or modifications should be made, you could be required to stop operation of the equipment.







Canon U.S.A. Inc.

One Canon Park, Melville, New York 11747. U.S.A.

Tel No. 1-800-OK-CANON(1-800-652-2666)

Safety Symbols in this Manual

This section describes the safety symbols used in this manual. Important projector safety information is identified by the following symbols. Always observe the safety information by these symbols.

 Warning	Denotes the risk of death or serious injury from improper handling if the information is not observed. To ensure safe use, always observe this information.
 Caution	Denotes the risk of injury from improper handling if the information is not observed. To ensure safe use, always observe this information.
	Denotes the risk of electric shock from improper handling if the information is not observed. To ensure safe use, always observe this information.
	Denotes the risk of burns from improper handling if the information is not observed. To ensure safe use, always observe this information.
 Prohibition	Denotes prohibited actions.
 Caution	Denotes required actions or information that must be observed.

Precautions for Use

As this section contains important safety-related information, be sure to read the following carefully beforehand in order to use your projector correctly and safely.

Warning

Power Supply

During installation, keep the projector plug easily accessible so that the projector can be unplugged immediately if necessary, or keep a circuit breaker within reach. If the following situations occur, turn the power off, remove the power plug from the power outlet and contact the Canon Customer Support Center. Failure to do so could cause a fire or result in an electric shock.



- If smoke is emitted
- If an unusual smell or noise is emitted
- If water or other liquid has entered the projector
- If metal or any other foreign material has entered the projector
- If the projector is knocked over or dropped and the cabinet is damaged

Pay attention to the following points regarding the power source, power plug and handling of the connector. Failure to do so may cause a fire or electric shock.



Prohibition



- Do not place any objects on the power cord and do not allow it to become trapped under the projector.
- Do not cover the power cord with a carpet.
- Do not modify or excessively bend, twist, pull, wind, or bundle the power cord.
- Keep the power cord away from heaters and other sources of heat.
- Do not use a damaged power cord. If the power cord is damaged, contact the Canon Customer Support Center.
- Do not use any power source with a voltage other than the voltage indicated (AC 100 – 240 V).
- Do not insert any metal objects into the contact parts of the power plug or connector.
- The power cord included with this projector is for use exclusively with this product. Do not use this cord for other products.



- Do not remove the power plug or connector with wet hands.

Warning

Pay attention to the following points regarding the power source, power plug and handling of the connector. Failure to do so may cause a fire or electric shock.



- Insert the power plug and connector securely up to the base. Additionally, do not use a damaged power plug or an outlet that is loose.
- Do not pull the power cord and be sure to hold the power plug or connector when removing. Incorrect handling may damage the power cord.
- When using an extension cord, do not exceed the cord's rated capacity.
- Do not exceed the rated capacity of the outlet (as by using it for more than one piece of equipment), which poses a risk of fire from overheating.
- Periodically inspect the power plug and outlet and remove any dust or dirt from between the plug and the outlet.
- Do not touch the projector itself, the power cord, or the cable if lightening strikes.
- Do not move the projector until you have switched off the power, removed the power plug from the power outlet and unplugged any other cables.
- Unplug the projector before cleaning or maintenance.

Warning

Installation and Use

Pay attention to the following points regarding installation and handling of the projector. Failure to do so may cause a fire, electric shock or personal injury.



- Do not use the projector where it might get wet, such as outdoors or by bathtubs or showers.
- Do not place containers containing a liquid on top of the projector.
- Do not install the projector in a location that is damp or dusty, or where there is a lot of oily smoke or steam. Oil can degrade the plastic, which could result in a ceiling-mounted projector falling from its mounting.
- Make sure to implement anti-fall measures such as an anti-fall wire when installing the projector in high places, for example, installing it on the ceiling.
- Do not remove the cabinet from the projector or disassemble it. The interior of the projector contains high-voltage components as well as parts that are hot. If inspection, maintenance or repair is required, contact the Canon Customer Support Center.
- Do not disassemble or modify the projector (including consumable parts) or the remote control.
- Do not look directly into the exhaust vents during use.
- Do not insert any object into vents in the projector, such as the air intake vent or exhaust vents.
- Do not place a pressurized can in front of the exhaust vents. The pressure of the contents of the can may increase due to heat from the exhaust vents and this could result in an explosion.
- When cleaning off dust or dirt from projector parts such as the lens or filter, never use any spray that is flammable. Internal parts that become hot may ignite and cause a fire.
- Do not use adhesives, lubricants, oils, or alkaline detergents for maintenance of the projector. They could adhere to the cabinet and damage it, possibly resulting in the projector falling from its mounting and causing an accident or personal injury.
- As strong light beams are emitted while the projector is in use, do not look directly into the projector lens. Doing so could cause an eye injury. Pay particular attention to prevent small children from doing so.



Prohibition

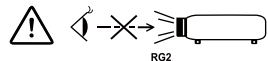

Warning

Pay attention to the following points regarding installation and handling of the projector. Failure to do so may cause a fire, electric shock or personal injury.



Prohibition



Caution

- Light from the projector is classified as Risk Group 2 (RG2) according to IEC 62471-5:2015.
- Do not hold or install optical instruments (such as magnifying glasses, reflectors, or glasses) in the path of light from the projector. If projected light is refracted or reflected and enters people's eyes, it may result in eye injury.
- No direct exposure to the beam shall be permitted.
- When setting the projector on a high surface for projection, be sure the surface is flat and stable.
- Do not use the projector on a soft surface such as carpet or sponge mat, etc.
- For ceiling mounting or other installation work, request service from a qualified technician or the Canon Customer Support Center. Poor installation work could result in an accident.
- To avoid hazards such as parts falling when the lens of a ceilingmounted projector is replaced, request service from a qualified technician or the Canon Customer Support Center.
- Do not use where combustible or explosive gases may occur. The lamp in the projector becomes hot and poses a risk of fire if it ignites.

Warning

Lamp

This projector uses a high-pressure mercury lamp. The mercury lamp has the following characteristics.

- The lamp will gradually become darker over time.
- Impact, abrasion, or use of worn-out lamps may cause lamps to rupture (accompanied by a loud noise) or burn out.
- Lamps are more likely to rupture after the lamp replacement message is displayed (see “Lamp replacement” ([Page 99](#))). Replace the lamp with a new one as soon as possible.
- Useful life of lamps varies widely from lamp to lamp and depending on the environment of use. Some lamps may fail or rupture soon after they are first used.
- Be prepared by keeping a spare lamp.

Note the following precautions during lamp replacement or when a lamp has ruptured.



Caution

- If the lamp ruptures, dust and gas (containing mercury vapor) may come out of the exhaust vents. If this happens, immediately open the windows and doors to provide ventilation to the room. Ruptured lamps may scatter shards of glass inside the projector. Contact a qualified technician or the Canon Customer Support Center for cleaning and inspection of the projector interior and lamp replacement.
- If you accidentally inhale gas from the lamp or get any pieces in your eyes or mouth, consult a doctor immediately.

Note the following precautions when replacing lamps that stop working. Failure to do so could result in personal injury.



Caution

- If illumination suddenly stops, either when you turn the projector on or after it has been on for a while, the lamp may have ruptured. In this case, never attempt to replace the lamp by yourself. Always request service from a qualified technician or the Canon Customer Support Center.
- With ceiling-mounted projectors, the lamp may fall out when you open the lamp cover, or during replacement. During replacement, make sure no one is under the projector, and stand to the side of the lamp cover, not directly under it.

Warning

Remote Control Batteries

Pay attention to the following points regarding handling of batteries. Failing to do so could result in a fire or personal injury.



Prohibition



Caution

- Do not heat, short circuit or disassemble the batteries, or place them in a fire.
- Do not attempt to recharge the batteries that are included with the remote control.
- Remove the batteries when they are flat or when the remote control will not be used for a long period of time.
- When replacing the batteries, replace both at the same time. Also, do not use two batteries of a different type at the same time.
- Insert the batteries with the + and – terminals in the correct directions.
- If any liquid from inside the batteries leaks out and contacts your skin, be sure to wash the liquid off thoroughly.

Caution

Handling

Pay attention to the following points regarding installation and handling of the projector.



Caution



- If the projector will not be used for a long period of time, be sure to remove the power plug from the power outlet to ensure safety. Failure to do so presents a risk of fire if dust accumulates on the plug or outlet.
- Do not plug headphones or earphones into the AUDIO OUT terminal. Doing so may cause hearing impairment.
- Do not set the volume too high initially. Doing so may cause hearing impairment from sudden sounds played at high volume. Lower the volume before turning off the projector, and after startup, raise it gradually.
- Do not touch parts of the cabinet around and above the exhaust vents, which may become hot during projection. Pay particular attention in preventing young children from touching these parts. Additionally, do not place any metal objects around or above the exhaust vents. Such objects may become hot from the projector, which may result in burns or other injury.

Safety Precautions

Caution

Pay attention to the following points regarding installation and handling of the projector.



Prohibition

- Do not place any heavy objects on top of the projector or sit/stand on it. Pay particular attention to prevent small children from doing so. The projector may be knocked over and this could result in damage or a personal injury.
- Do not place the projector on an unstable or slanted surface. Doing so may cause the projector to fall or be knocked over and could result in a personal injury.
- Do not place any objects in front of the lens during projection. Doing so could cause a fire. 

When handling the lamp, pay attention to the following points.



Caution



- Be sure not to handle the lamp immediately after it has been used. Be sure to switch off the power and wait for approximately 1 hour for the lamp and the projector to cool down sufficiently. Failure to do so could result in a burn due to heat from the lamp or projector.

Caution

Carrying and Installation

Pay attention to the following points when carrying or transporting the projector.



Caution

- This projector is a precision instrument. Do not knock it over or subject it to impacts. Doing so may cause a malfunction.
- Retract the adjustable feet before moving the projector. Leaving the feet extended may cause damage.
- Do not touch the lens with bare hands. Any smudges or fingerprints on the lens may affect image quality.
- Protection of the projector cannot be guaranteed if used packaging or shockabsorbent materials are reused. Fragments from shock-absorbent material may also enter the interior of the projector which could cause a malfunction.

Caution

Pay attention to the following points when installing or using the projector.

- Be careful of condensation.

If the projector is abruptly taken to a warmer location, or if the room temperature rises abruptly, moisture in the air may condense on the lens or mirror and affect projected images. In this case, wait a while and make sure the moisture has evaporated before resuming use.

- Do not install the projector in a location where the temperature is high or low. Doing so may cause a malfunction. Ranges for the environment of use and storage are as follows.
 - Environment of use: 0°C (32°F) to 40°C (104°F), 20% to 85% RH
 - Storage temperature: -20°C (-4°F) to 60°C (140°F)

- When using the projector at altitudes above 1,400 m (4,593.2'):

Adjust projector installation settings from the menu (P147). Failure to adjust the settings may shorten the lamp life or damage the lamp.

- Do not install the projector facing the wrong direction. Install the projector so that it is not tilted front or back / left or right by more than 10°. Failure to do so may shorten the lamp life or damage the lamp.

- Do not block the air intake or exhaust vents. Blocking the vents may trap heat inside the projector, which may shorten the useful life of optical components or other parts and damage the projector.



Caution

- Install the projector leaving at least 50cm (1.6') / 100cm(3.3') between air intake/exhaust vents and walls on each side of the projector. Leave a gap of at least 0.5 cm (0.2") from the bottom of the projector. There is an air intake underneath the projector. Failure to leave enough space may trap heat inside the projector and damage it.

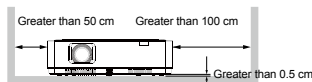

Sides and bottom

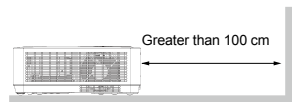

Rear

- Do not place any objects on top of the projector that may change shape or color due to heat.
- Do not install the projector near high-voltage electrical power lines or an electrical power source. This may cause malfunction.
- Clean the air filter regularly (P207). Dust that accumulates inside over long periods without cleaning may eventually damage the projector or affect picture quality.

For Safe Use

- Afterimages may occur when the image changes after the same image has been projected for some time. This is due to the nature of the LCD panels and does not indicate a problem. The afterimage will dissipate after a while during normal projection.

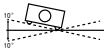

DO NOT tilt your projector more than 10 degrees.

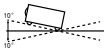

DO NOT tilt your projector more than 10 degrees.



DO NOT put the projector on a vertical projection.



DO NOT put the projector upside down to make a projection.



DO NOT put the projector on a horizontal projection.

Precautions When Carrying / Shipping the Projector

Prepare the projector as described below before carrying it.



Caution

- Disconnect the cables connected to the projector. Carrying the projector with the cables attached may cause an accident.
- Retract the adjustable feet before moving the projector. Leaving the feet extended may cause damage.
- Do not subject the projector to strong impacts or vibrations.

Precautions for Installation

Be sure to read “Safety Precautions” and “For Safe Use” (P5 – P20). Also take the following precautions during installation.



Caution

- Do not strike the projector or subject it to impact. Doing so may cause a malfunction.
- Do not install the projector standing on one side or in other unsteady positions. The projector may be damaged if it tips over.

■ Do Not Use in the Following Environments

- **Locations with excessive humidity, dust, oily smoke or tobacco smoke**
Adhesion to the lens, mirrors or other optical parts may reduce image quality.
In addition, oil can degrade the plastic, which could result in a ceiling-mounted projector falling from its mounting.
- **Near high-voltage power lines or sources of electrical power**
This may cause malfunction.
- **On soft surfaces such as carpets or cushioned mats**
This may cause a fire or damage the projector.
- **Locations with excessive temperature or humidity**
- **Locations subject to vibration or impact**
- **Near heat or smoke detectors**
- **Near the ocean, or near air conditioner vents**
- **Locations where corrosive gases occur, such as sulfur gas from hot springs**
This may damage the projector. Acceptable ranges for operating and storage temperature and humidity are as follows.
* Operating temperature and humidity applies to when the projector is projecting or in standby mode.



Caution

Operating temperature	Operating humidity	Storage temperature
0°C (32°F) – 40°C (104°F)	20% – 85%	-20°C (-4°F) – 60°C (140°F)

■ Do Not Touch the Lens with Bare Hands



Caution

Do not touch the lens with bare hands. Any smudges or fingerprints on the lens may affect image quality.

■ Install at a Sufficient Distance from Walls and Other Obstructions



Caution

If the air intake or exhaust vent is blocked, heat will accumulate inside the projector, possibly resulting in a shortened projector lifetime or a malfunction. Similarly, do not install in narrow, enclosed spaces with poor ventilation.

Install the projector leaving at least 50cm (1.6') / 100cm(3.3') between air intake/exhaust vents and walls. Leave a gap of at least 0.5 cm (0.2") from the bottom of the projector.



Air intake

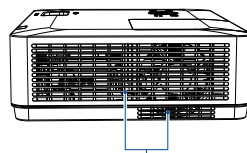

Air outlet
(For heat exhaust)

■ Be Careful of Condensation

If the temperature of the room rises suddenly, moisture in the air may condense on the projector lens and mirror, causing the image to become blurred. Wait until the condensation has evaporated for the image projected to return to normal.

■ At Altitudes above 1,400 m (4,593.2'), Adjust the Settings

Projector settings must be adjusted when using the projector at altitudes of 1,400 m (4,593.2') or higher. Specifically, refer to instructions for [High altitude] (P59) in the [Setting] menu.

■ When Using Mounted on the Ceiling



When the projector is used mounted on the ceiling or installed in a high location, it is necessary to periodically clean the air intake and exhaust vents, and the area around the air filter. Dust that accumulates in intake or exhaust vents may impair ventilation, raising the temperature inside and posing a risk of damage or fire. Use a vacuum cleaner or similar means to remove dust from the intake vent and exhaust vent.

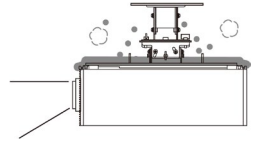

Copyright Notice

Please note that enlarging or reducing the size of an image for commercial purposes or public presentation may infringe on the legally protected copyright or the copyright holder of the original material.

Ensure Network Security

Take measures to ensure network security. Note that Canon is not liable in any way for direct or indirect loss from network security incidents, such as unauthorized access.

Before use, configure projector, computer, and network security settings appropriately.

- Set up the projector for connections only within your protected network, behind a firewall or the like, instead of direct Internet connections.

About Trademarks

- Ethernet is a registered trademark of Xerox Corporation.
- Microsoft and Windows are registered trademarks or trademarks of Microsoft Corporation in the United States and/or other countries.
- Mac, Mac OS and Macintosh are trademarks of Apple Inc., registered in the United States and/or other countries.
- HDMI, the HDMI logo and High-Definition Multimedia Interface are trademarks or registered trademarks of HDMI Licensing, LLC.
- PJLink is a registered trademark of JBMIA and pending trademark in some countries.
- PJLink is a registered trademark, or an application has been submitted for trademark, in Japan, the United States and/or other countries or regions.
- AMX is a registered trademark of Harman International Industries, Inc.
- Crestron®, Crestron RoomView®, and Crestron Connected™ are registered trademarks of Crestron Electronics, Inc.
- All other trademarks are the property of their respective owners.

Open Source Software

The product contains Open Source Software modules.

For details, check the files obtained from “Software Used in This Product” on the download site (<https://global.canon/iprj/>). Please refer to the license information for each module, which is contained in the corresponding file.

Some third-party software permits the distribution of software modules in executable form only under the condition that the source code of such modules be made available freely. For information on how to acquire the source code for such third-party software, contact the distributor from whom the product was purchased.

Accessory

Before use, make sure the following items are included in the package.

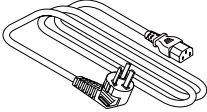
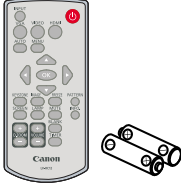
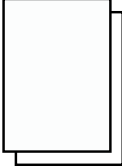
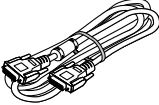
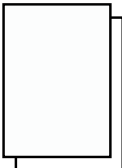
<p>Power code 1.8m(70.8")</p>	<p>Remote control (type number:LV-RC12) Batteries(AAA*2)</p>
 <p>Note: the AC power cord specification depends on the location of your projector.</p>	
<p>Important Information</p>	<p>Computer Cable 1.5m(59.1")</p>
	
<p>Warranty card</p>	
	

Name and function of your projector

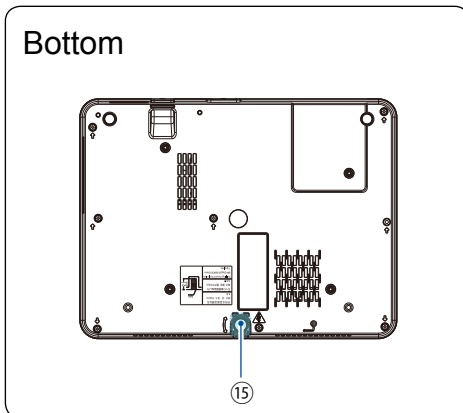
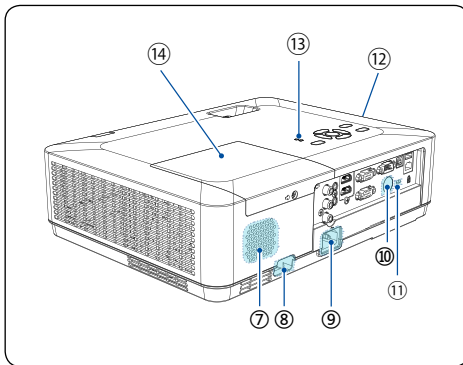
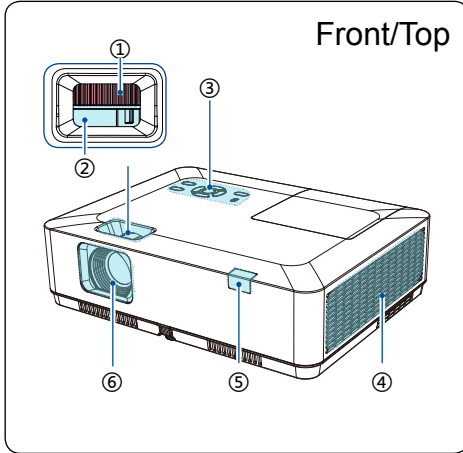

 Note:

Do not place your hands or other objects near the Exhaust vent:

- Vent will shed heat. Do not put your hands or face, or thermolabile objects placed near the outlet . You need keep at least a distance of 3" (100cm) away, or it may cause it burning or damage.

Name and function of your projector

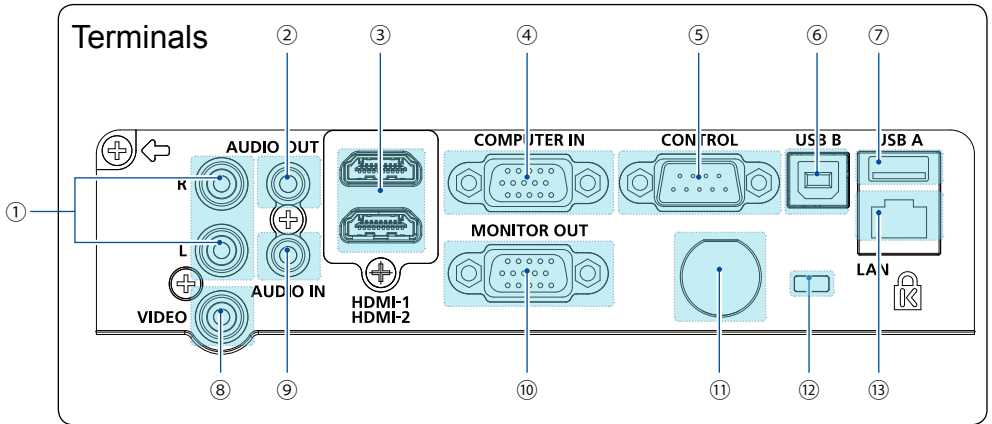

- ① **MONO(L/R) terminal**
A MoNo audio signal (A single audio terminal) should be connected to the MONO (R / L) interface.
- ② **AUDIO OUT terminal**
Connect external audio devices to this terminal.
- ③ **HDMI-1/HDMI-2 terminal**
Connect HDMI1 digital output signals or HDMI2 digital output signals to this terminal.
- ④ **COMPUTER IN**
Connect RGB to this terminal.
- ⑤ **CONTROL**
When using the RS232 functional to operate the projector, connect the serial communication to this terminal.
- ⑥ **USB B terminal**
When using the "USB display" function, connect your computer to this terminal via the USB cable.
- ⑦ **USB A terminal**
When using the Memory Viewer function, insert the USB memory directly to this.
- ⑧ **VIDEO IN terminal**
Connect video output signal to this terminal.
- ⑨ **AUDIO IN terminal**
Connect audio signal of the PC to this terminal.
- ⑩ **MONITOR OUT terminal**
For monitor output , output the signal from ④ to other monitors.
- ⑪ **Remote Receiver (rear)**
Use the remote control to operate the projector.
- ⑫ **Anti-theft lock hole**
An anti-theft wire cable (not included) can be connected.
- ⑬ **LAN terminal**
Connect mesh cable to this terminal when using network control and operate your projector.

Name and function of your projector

Top control panel and indicators

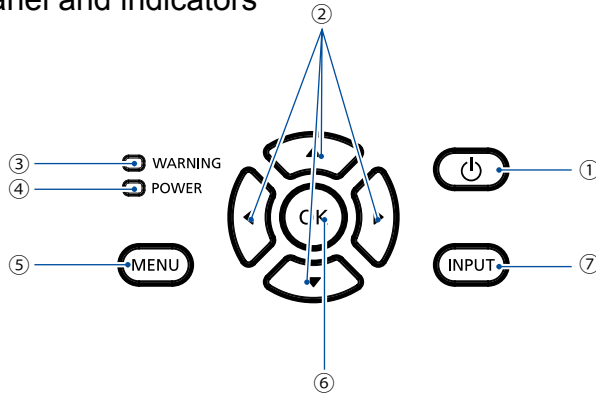

① POWER

Turn the projector on or off.

② Arrow ▲ ▼ ◀ ▶ /UP/DOWN/VOL-/VOL+

- Select items or adjust the data in the OSD menu.
- Shift the image in the "Digital zoom +/-" mode.
- Adjust the volume.

③ WARNING indicator

- The indicator is flashing red, when the internal temperature of the projector exceeds the operating range.

④ POWER indicator

- The POWER indicator turns steady red, when the projector is in standby mode.
- The POWER indicator turns steady green, during the working time.
- The POWER indicator is flashing green, when the projector is in power management mode.
- The POWER indicator is flashing red, when the projector is in cooling mode.
- The POWER indicator turns steady orange, when the projector power is abnormal.

⑤ MENU

Open or close the OSD menu.

⑥ OK

- Select options in the OSD menu .

⑦ INPUT

Open or close the INPUT menu.

Name and function of your projector

Remote controller

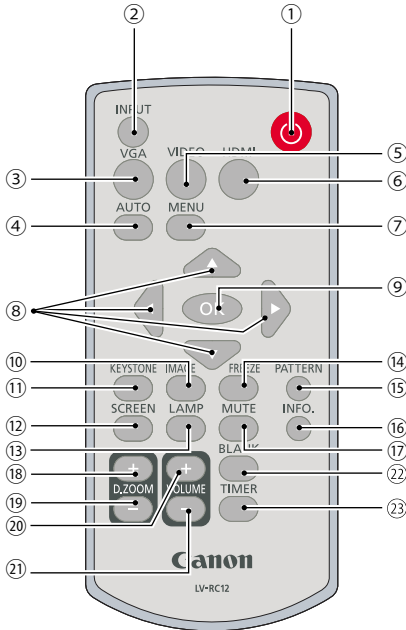

① **POWER**
Power on or off your projector .

② **INPUT**
Open or close the INPUT menu .

③ **VGA**
Select VGA input source .

④ **AUTO**
Enter auto adjustment mode .

⑤ **VIDEO**
Select VIDEO input source .

⑥ **HDMI**
Select HDMI 1/HDMI 2 input source.

⑦ **MENU**
Open or close the OSD menu .

⑧ **Arrow** ▲▼◀▶
–Select items or adjust data in the OSD menu .
–Select display area in digital zoom+ mode .

⑨ **OK**
Enter the OSD menu or select options in it .

⑩ **IMAGE**
Select image mode .

⑪ **KEYSTONE**
Keystone calibration .

⑫ **SCREEN**
Enter the screen size adjustment menu.

⑬ **LAMP**
Select LAMP mode.

⑭ **FREEZE**
Freeze projected images.

⑮ **PATTERN**
Select built-in test pattern of your projector.

⑯ **INFO.**
Display current status info. of your projector .

⑰ **MUTE**
Turn off the sound Temporarily.

⑱ **D.ZOOM +**
Zoom in projected image .

⑲ **D.ZOOM -**
Zoom out projected image .

⑳ **VOLUME +**
Increase volume.

㉑ **VOLUME -**
Decrease volume .

㉒ **BLANK**
Dark out screen images temporarily.

㉓ **TIMER**
Enable the timer function .



PATTERN button on the remote controller is invalid when you choose USB display, Memory viewer and Network as input signal.

Name and function of your projector

Install battery of remote controller

1 Open the battery cover.



2 Insert a new battery in it.



Two AAA batteries

Place batteries with its anode and cathode (+ and -) in correct direction. Keep both poles in good connection to the contacts within the compartment.

3 Put the cover back.



Please follow the following rules for safety operation:



- Use two of AAA batteries.
- Replace both batteries at the same time.
- Do not mix new and old batteries as one pair.
- Keep your remote controller away from water or other liquids.
- Do not expose your remote controller to environments with high humidity or temperature.
- Do not drop your remote controller.
- In case of any battery solution leaking in the compartment, clear it thoroughly before placing new batteries in it.
- Using battery of other types than what specified on this manual may lead to risks of explosion. "Lamp replacement"(Page 99)
- Please dispose your old battery by following instructions given in tag of the battery or local regulations.

Remote controller operation range

Point your remote controller to the IR receiver of your projector.

Maximum operation range of your remote controller is about arc 30° and with about an area of about 8 meters in straight line.

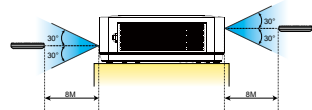
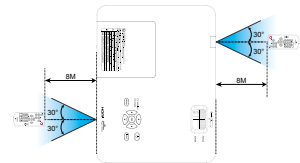

Installation

Set up your projector

- Ambient brightness may affect your projection image quality. For the optimal image effect, it is recommended to control brightness in your environment.
- Values shown in figure below are approximates only. They may differ from the actual ones.

LV-WU360

Screen size(WxH)m 16:10 aspect	30"	80"	100"	120"	150"	200"	300"
	0.65x0.40	1.72x1.08	2.15x1.35	2.59x1.62	3.23x2.02	4.31x2.69	6.46x4.04
Projection distance(Max.)	0.87m	2.36m	2.96m	3.56m	4.45m	5.95m	8.93m
Projection distance(Min.)	1.05m	2.85m	3.56m	4.28m	5.36m	7.15m	10.74m

Screen size(WxH)m 16:9 aspect	30"	80"	100"	120"	150"	200"	300"
	0.66x0.37	1.77x1.00	2.21x1.25	2.66x1.49	3.32x1.87	4.43x2.49	6.64x3.74
Projection distance(Max.)	0.90m	2.43m	3.04m	3.66m	4.58m	6.11m	9.18m
Projection distance(Min.)	1.08m	2.92m	3.66m	4.40m	5.51m	7.35m	11.03m

LV-WX370

Screen size(WxH)m 16:10 aspect	30"	80"	100"	120"	150"	200"	300"
	0.65x0.40	1.72x1.08	2.15x1.35	2.59x1.62	3.23x2.02	4.31x2.69	6.46x4.04
Projection distance(Max.)	0.94m	2.55m	3.20m	3.84m	4.81m	6.42m	9.65m
Projection distance(Min.)	1.14m	3.07m	3.85m	4.62m	5.79m	7.72m	11.60m

Screen size(WxH)m 16:9 aspect	30"	80"	100"	120"	150"	200"	300"
	0.66x0.37	1.77x1.00	2.21x1.25	2.66x1.49	3.32x1.87	4.43x2.49	6.64x3.74
Projection distance(Max.)	0.97m	2.63m	3.29m	3.95m	4.95m	6.60m	9.92m
Projection distance(Min.)	1.17m	3.16m	3.96m	4.75m	5.95m	7.94m	11.92m

LV-X350

Screen size(WxH)m 4:3 aspect	30"	80"	100"	120"	150"	200"	300"
	0.61x0.46	1.63x1.22	2.03x1.52	2.44x1.83	3.05x2.29	4.06x3.05	6.10x4.57
Projection distance(Max.)	0.89m	2.41m	3.02m	3.63m	4.54m	6.06m	9.10m
Projection distance(Min.)	1.07m	2.90m	3.63m	4.36m	5.46m	7.28m	10.94m

Screen size(WxH)m 16:9 aspect	30"	80"	100"	120"	150"	200"	300"
	0.66x0.37	1.77x1.00	2.21x1.25	2.66x1.49	3.32x1.87	4.43x2.49	6.64x3.74
Projection distance(Max.)	0.97m	2.63m	3.29m	3.95m	4.95m	6.60m	9.92m
Projection distance(Min.)	1.17m	3.16m	3.96m	4.75m	5.95m	7.94m	11.92m

Installation

Adjust the projected image

Adjust the position of the projected image

1. Place the projector so that it is perpendicular to the screen, just show.

2. Raise the front of the projector and press the foot lock on the projector.

Loosen the foot lock can lock the adjustable foot. Rotate the adjustable foot to adjust the height.

Rotating the adjustable foot in the direction shown in the Image (2) to lengthens it, and rotating in the opposite direction retracts it, thus adjusting the projection angle of the vertical direction.

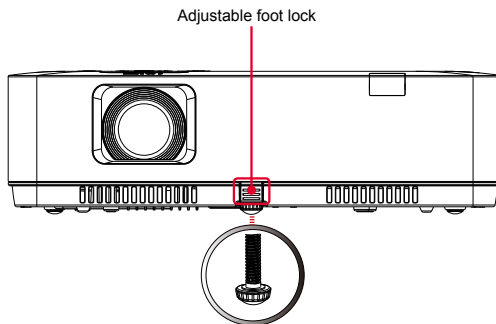
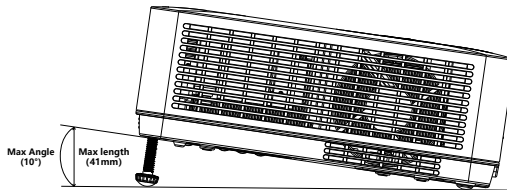

Image (1)

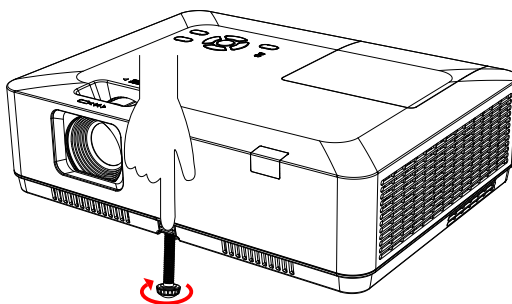

Image (2)

Installation

Connect to PC (Digital and Analog RGB)

Cables for connection:

- Computer cable
- HDMI cable*
- Serial cable (Cross type)*

(* This cable is not included.)

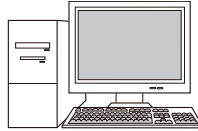

VGA Signal Input

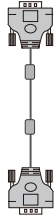

HDMI Digital Signal Output



VGA Signal Output



RS232 Output

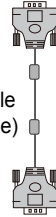

Serial cable (Cross type)

VGA Signal Output

HDMI Digital Signal Input

VGA Signal Input

RS232 Input

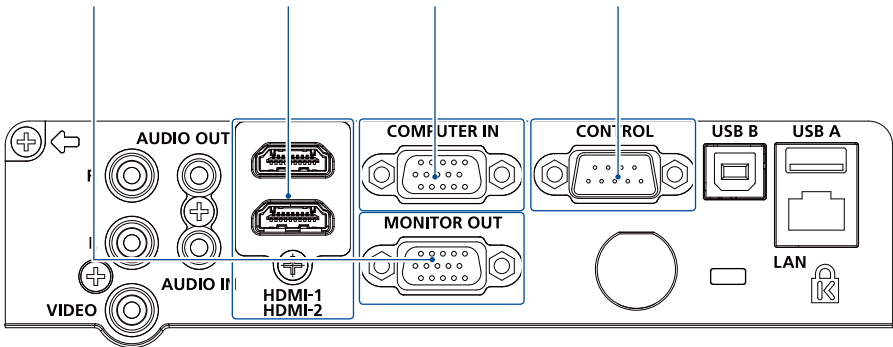

Unplug power cords of your projector and all external equipment before connecting any cable to them.

Installation

Connect to video equipment

Cables for connection:

- VIDEO cable*

(* This cable is not included.)



VIDEO Output
Signal



VIDEO Input
Signal

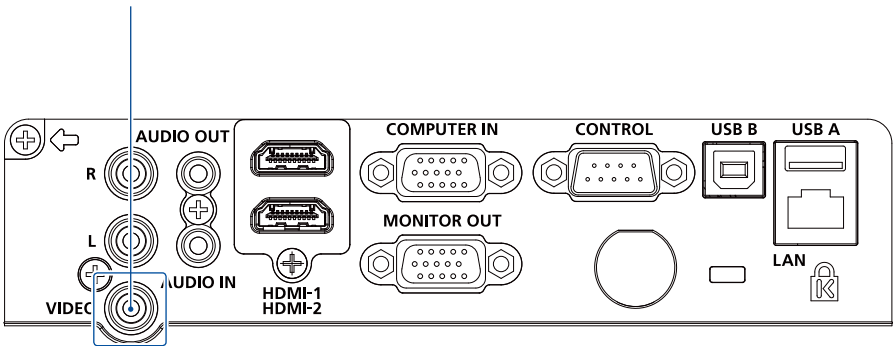

Unplug power cords of your projector and all external equipment before connecting any cable to them.

Installation

Connect to audio equipment

Cables for connection:

- Audio cable*

(* This cable is not included.)

External audio devices

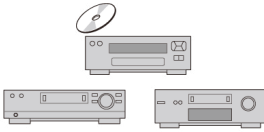

Audio Output
(R) (L)



Audio Input



Audio Output

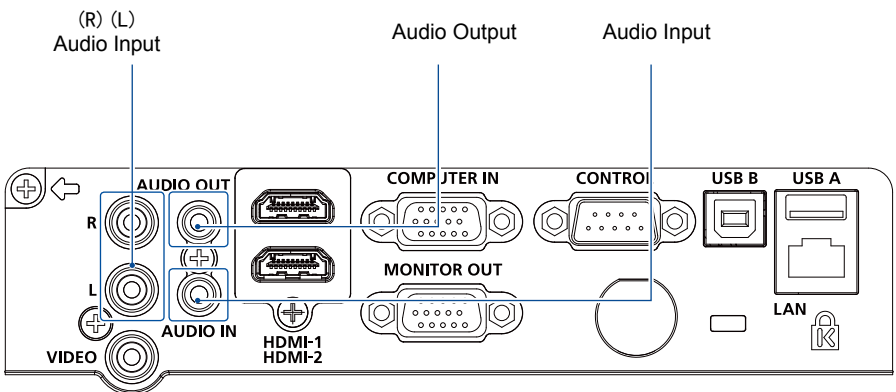
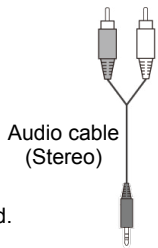
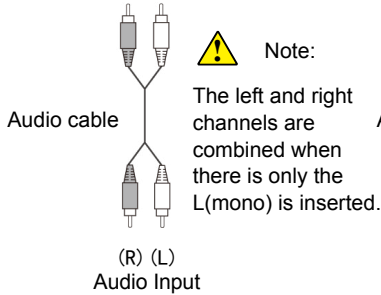

Unplug power cords of your projector and all external equipment before connecting any cable to them.

Installation

Connect to USB

Cables for connection:

- USB-A or USB-B cable*
- (* This cable is not included.)

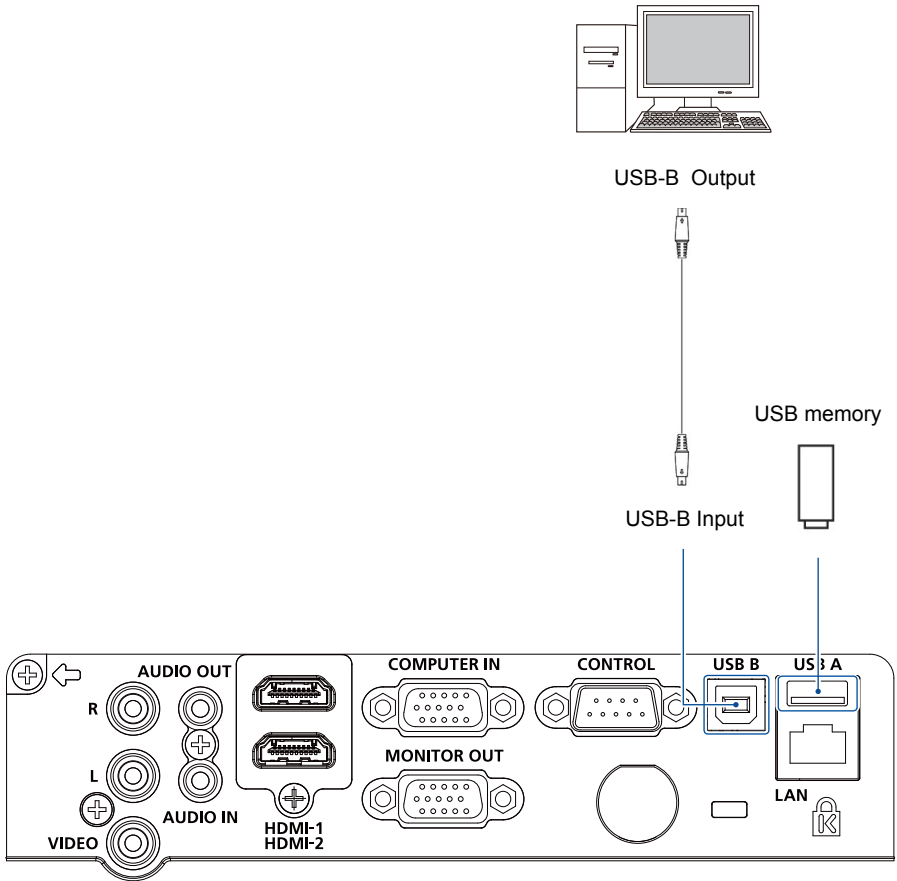

Unplug power cords of your projector and all external equipment before connecting any cable to them.

Installation

Connect the AC power cord

Standard voltage employed by your projector is AC 100-240V. It adapts to different input voltage automatically. Your projector employs single-phase power cord with neutral ground cable. Do not use any other type of power cords or you may face the risks of electric shock. In case you have any doubt on type of power cord you are using, please call authorized dealer or service center for help. Before powering on your projector, get all external equipment connected in advance.



Note:

Keep your AC power socket close to your projector for easy plugging and unplugging.

✓ Note:

For safety reasons, unplug the AC power cord when your projector is not in use. Your projector will consume a small amount of power when it is connected to AC grid power and in standby mode.

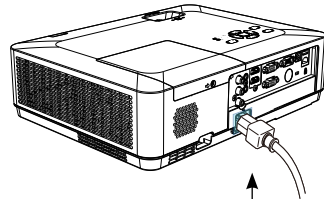

Connect included AC power cord to your projector.

Precautions on power cord

Your AC power cord should meet regulations of the country/district where your projector is used.

Please make sure the type of the power plug is compliant with those given in figure below. Make sure you are using a valid AC power cord.

In case the included AC power cord does not comply with the AC power socket in your location, call your dealer for replacement.

The projector side

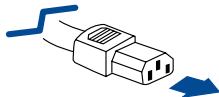

Connect to power cord connector of your projector

Connect to the AC power socket

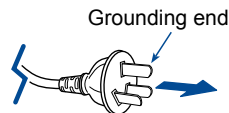

Connect to AC power socket

✓ Note:

- Use of invalid power cord may hamper product performance or even lead to electric shock, fire, and other incidents. Please use power cord compliant with the included one to ensure product performance and operation safety.

Power on your projector

1. Connect all external equipment to your projector (e.g. computer or camera) before powering it on.
2. Connect AC power cord of your projector to an AC power socket. The Power indicator turns on in red.
3. Press the Power button on the top control panel or the remote controller.
The Power indicator lights in green and the cooling fan starts running.
4. If your projector is setting as password protected, the password dialog box displays. Enter your password as instructed below.

✓ Note:

- In case the "Logo Select" option is set to OFF, then no welcome image will display in screen.
- You can do nothing but powering off your projector during the welcome image is displaying.

Enter Passcode

Press ▲▼ button to select a number, press ► button to enter it and move the cursor. The number you typed is displayed as "*". To edit number you have entered, press ◀ button to move the cursor to the number you want to change, press ▲▼ button to select the correct one.

Repeat this step to type in a 3-digit number.

Move the cursor to SET after you have typed the 3-digit number. Press the OK button and now you are ready to use your projector.

If the password is invalid, the password displayed as "*:*:" will be in red. Please try again with a valid one.

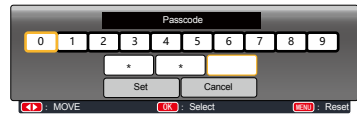
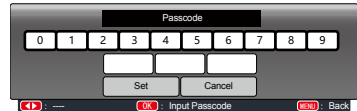

Move the cursor to Set button, then press the OK button.



You Passcode code is a 3-digit number. To find out more about protecting your projector with a Passcode, please refer to the Passcode Lock function in the Setup menu on [Page 68](#) for details.

Precautions on Passcode operation

You cannot operate a Passcode protected projector without correct Passcode. Please set up a new Passcode and keep your operation manual in safe place. In case the Passcode is lost or forgotten, please refer to the To Cancel the Passcode on [Page 68](#).

Power off your projector

1. Press the Power button at the top control panel or the remote controller, the “Power off?” message displays.
2. Press the Power button again within 4 seconds after the “Power off?” message prompted to you. The POWER indicator flashes red while the cooling fan continues running. Do not unplug the power cord until the fan stops running. Failure to do so may shorten life cycle of your projector or lead to power on failures or operation abnormalities.
3. The POWER indicator stops flashing once the projector has been cooled down to ready for power on again.

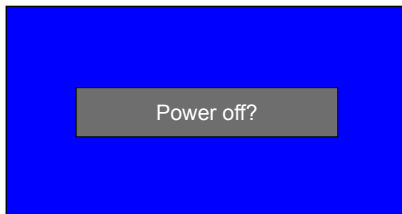

“Power off?” message disappears in 4 seconds.



To maintain the life cycle of the lamp, power off your projector after it has been turn on for at least 5 minutes.

Do not use your projector without stop. As it may hurt the life cycle of your lamp. Power off your projector at least once every 24 hours and have it idle for an hour.

✓ Note:

- If the “Direct Power On” function is set to “On”, your projector will power on once it is connected to an AC power socket. (Refer to [page 58](#))
- Speed of the cooling fan varies with internal temperature of your projector.
- Do not place your projector in any box before it is fully cooled down.
- In case the Warning indicator flashes or turns red, refer to the “Status light indicator ” for instructions. (Refer to [page 107](#))
- The POWER indicator flashes when the lamp is cooling down. Do not power on your projector at this time. Power on your projector only after the POWER indicator turns red.
- Unplug the power cord after the fan stops running..

Basic operation

How to operate the OSD

You can adjust or set up the projector on the on-screen menu .

The menu has a multilayer structure. Each main menu is divided into several sub-level menus, then each submenu is divided into several submenus.

Please refer to the appropriate section of this manual for the procedure for the adjustment and settings.

Top control panel

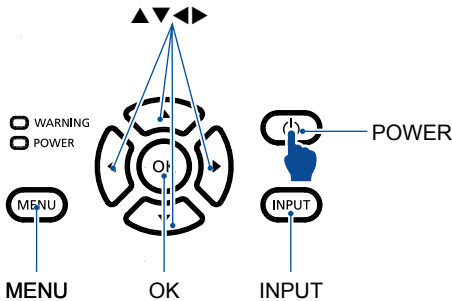

1. Press the MENU button on the top control panel or remote controller and the OSD displays.
2. Press ▲▼ button to act on or select one main menu item. Press ► button or OK button to enter a submenu.
3. Press ▲▼ button to select required submenu, then press OK button or ► button to set up or enter an option.
4. Press ▲▼ button to select settings or navigate options, then press OK button to act on the item and exit.
5. Press ◀ button to return to main menu. Press the MENU button on remote controller or control panel to exit the OSD.

Remote controller

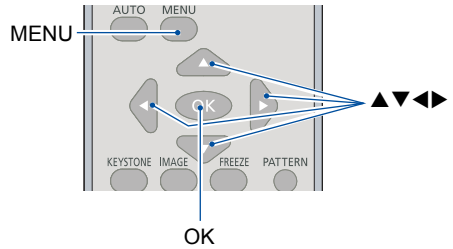

OSD Menu

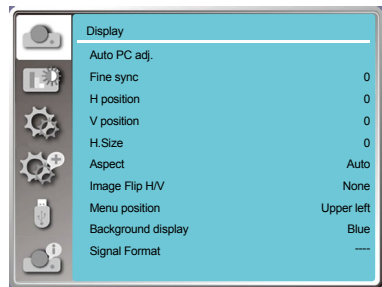

Menu item overview

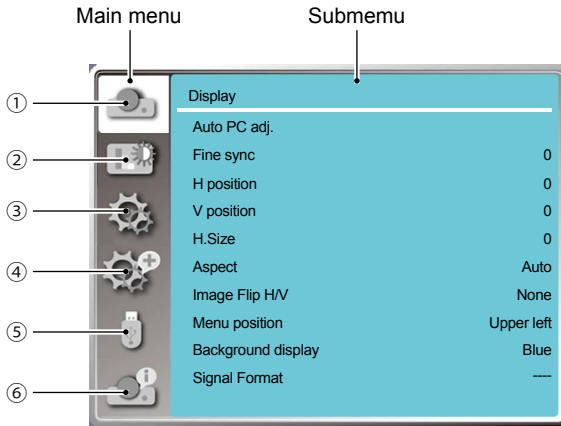

① Display menu

- Select Auto PC adj., Fine sync, H Position, V Position, H. size to adjust the parameters to match the VGA format.
- Aspect : Auto, 16:9(*), Advanced(*), Full. *Only for LV-WX370/LV-X350
- Image Flip H/V: Choose None / Rear / Ceiling mounted / Rear, Ceiling / Auto Ceiling / Auto Ceiling, Rear.
- Menu position: Set screen menu display position on the screen.
- Background display: Sets the background color of the projection screen.
- Signal Format: Select the compatible system signal format with input source .

② Color adjust menu

Available options in the Image mode menu are Presentation, Standard, Movie, Blackboard (Green), Colorboard, or User Image.

- For video signal input ,the available color adjust options : Contrast, Brightness, Color level, Color balance, White balance(Red, Green, Blue) and Sharpness.
- For other signal input ,the available color adjust options :Contrast, Brightness, Color temp, White balance(Red, Green, Blue) and Sharpness.

③ Setting menu

Configuration of the basic function operation on the projector: Direct Power On, Standby mode, High altitude, Lamp control, Cooling fast , Closed caption, Key lock, Iris, Sound and HDMI Setup.

④ Advanced menu

Available adjust options are Language, Auto Setup, Keystone, Logo , Security, Power management, Filter counter, Test pattern, Network, Factory default and Lamp counter.

⑤ Memory Viewer menu

Select Parameter Of Start slide, Slide transition effect, Sort order, Rotate, Best fit, Repeat, Apply.

⑥ Information menu

Display information about the projector.

Basic operation

Adjust the Projector Zoom and Focus

1. Adjust the projected image to the size that you need using the zoom ring.
2. Rotate the focus ring to adjust the focal length of the image, and adjust it to be clear according to the display content of the screen.

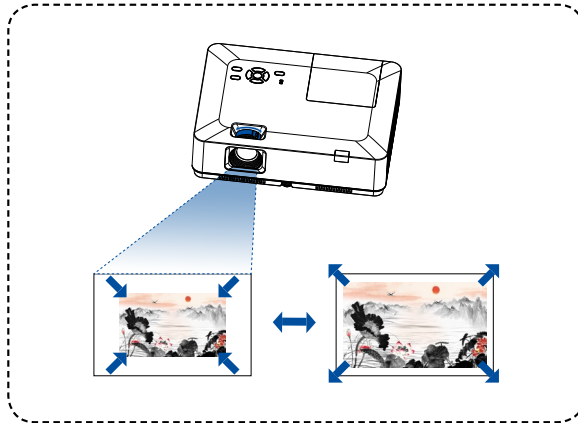
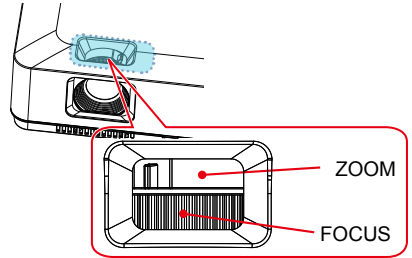

Adjust the projector Zoom

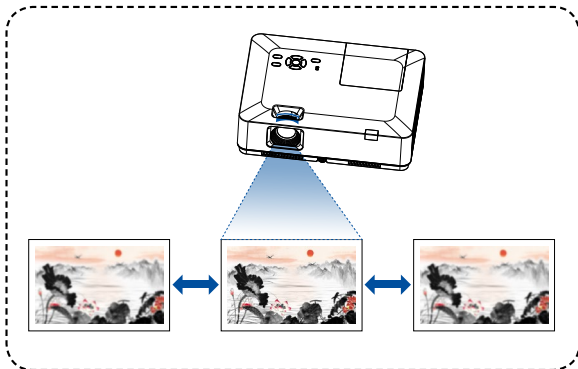

Adjust the projector Focus

Basic operation

Auto setting function

Press the AUTO button on your remote controller to auto execute settings given in the Auto Setup on the Advanced menu (including input search, Auto PC adj. and Auto keystone).

Keystone adjustment

Follow steps below to adjust keystone distortion of projected image manually.

Press the KEYSTONE button on your remote controller. The keystone adjustment dialog box displays (including H/V Keystone, Corner adjustment, Curved correction, Reset value) , press ▲▼◀▶ button to adjust keystone distortion.

You may save your settings for keystone adjustment.

H/V keystone.....Adjust the projected image when the projector is on the horizontal or vertical keystone distortion.

Corner adjustment.....Adjust the projected image when the projector is on keystone distortion of four corners .

Curved correction.....Adjust the projected image when the projector linearity is uneven or the projected images bent vertically and horizontally.

Reset value.....The correction values will be restored to the factory defaults.

Remote controller



Remote controller

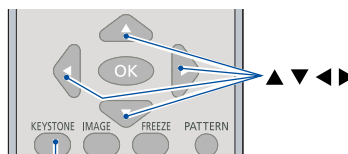

KEYSTONE

H/V Keystone



- The arrow mark looks white when there is no keystone adjustment in existence.
- The arrow mark indicating the adjustment direction turns red.
- The arrow mark disappears when the maximum adjustment limit reaches.

H/V Keystone

- Corner correction
- Curved correction
- Rest value

LV-WX370/LV-X350

Basic operation

- The keystone prompt box will disappear if you press the KEYSTONE button again when it is displaying. Press the OK button again to switch the correction items.
- The adjustable range is subject to source of signal input.

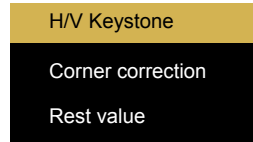

LV-WU360

Volume adjustment

Volume

Press the remote control Volume +/- buttons to adjust the volume.

MUTE

Press the mute button on the remote control to select "ON", you can temporarily turn off the sound. Press the mute button again to select "Off" or press the volume +/- keys to re-open the audio effects.

Mute function is also effective for audio output interfaces.

Remote controller

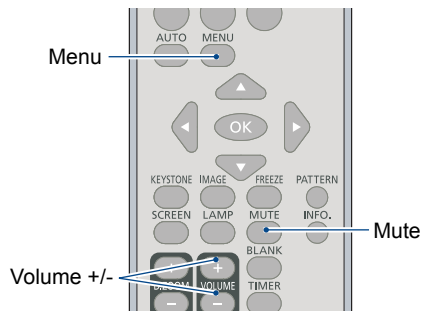

Menu operation

1. Press the MENU button on the top control panel or remote controller and the OSD displays. Press ▲▼ button to enter setting menu, then press OK or ► button.
2. Press ▲▼ button to select sound, press OK or ► button to enter.
3. Press ▲▼ button to select volume or mute.
 - Volume.....Press ▲ button to increase volume. Press ▼ button to decrease volume.
 - Mute.....Press ▲▼ button to switch to On or Off .
4. Press OK button to select.

Sound menu

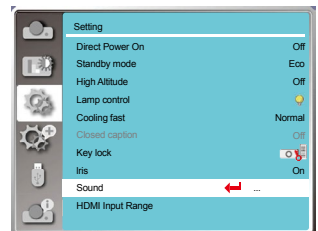
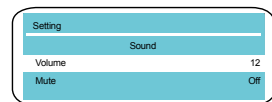

Basic operation

Remote controller operation

Freeze (FREEZE)

Press the FREEZE button on remote controller to freeze image and mute the audio. Freeze icon appears on the screen. Press the FREEZE button or any button to cancel the freeze function, then the image replay and the sound is restored.

Mute (MUTE)

Press the mute button on the remote control to turn off the sound. To remove the mute function, please press the mute button or volume +/- button to cancel the mute function.

VOLUME +/- (VOLUME +/-)

press the Volume +/- on remote controller to increase or decrease volume.

IMAGE (IMAGE)

Press the IMAGE button on remote controller to select required image mode.

LAMP (LAMP)

Press the Lamp button on remote controller to change screen brightness.



Normal.....Normal brightness.



Economical.....Lower the brightness and reduce energy consumption, thus prolonging the lampservice life.

INFO.(INFO.)

Press the information button on the remote control to display the information of the projected image and the projector's operating status.

BLANK (BLANK)

Press the BLANK button on remote controller; a blank screen displays to replace existing image. Press the BLANK button or any other button to restore the image.

Press the BLANK to toggle switch your screen as shown below:

BLANK → Normal → BLANK → Normal →

✓ Note:

For some other buttons' description, please refer to the next page.

Remote controller

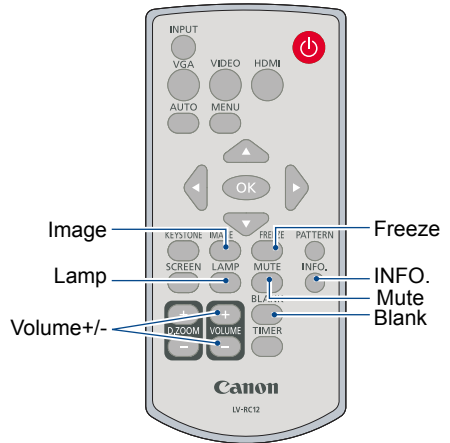

Basic operation

Timer (TIMER)

Press the TIMER button on remote controller. A timer animation (00:00) displays on the bottom right corner and starts timing in format of (00:00-59:59).

Press the TIMER button to stop timing. Press the TIMER button again to disable the timing function.



Timer display

Digital Zoom + (D.ZOOM+)

Press the D.ZOOM+ button on remote controller to enter the Digital Zoom mode.

When OSD menu disappear, the screen display digital zoom + information.

*Only for input as VGA, RGBHV, and the screen size setting as Normal or Wide.

Digital Zoom - (D.ZOOM-)

Press the D.ZOOM- button on remote controller to enter the Digital Zoom mode.

When OSD menu disappear, the screen display digital zoom - information.

Press any other key to exit the Digital Zoom + / - mode

Screen size selection (SCREEN)

Press the SCREEN button on remote controller to select required ASPECT.

Remote controller

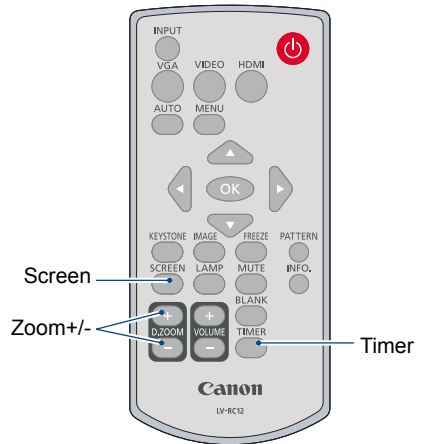

Basic operation

Input selection

Basic operation

Press the INPUT button on the control panel or on the remote control to select one of the following input: Computer, Video, HDMI-1, HDMI-2, Memory Viewer, Network, USB Display. Alternatively, you may press the VGA, HDMI, VIDEO button on remote controller to select Computer, HDMI-1, HDMI-2, Video.

Menu operation

- 1 Press the INPUT button on remote controller to enter the Input menu.
- 2 Press ▲▼ button to select one of the following input: Computer, Video, HDMI-1, HDMI-2, Memory Viewer, Network, USB Display, and then press the OK button to select the input source.

Computer

Select input Computer if a PC is connected to the COMPUTER IN terminal.

HDMI-1

Select input HDMI-1 if a device is connected to the HDMI-1 terminal.

HDMI-2

Select input HDMI-2 if a device is connected to the HDMI-2 terminal.

Video

Select input Video if a device is connected to the VIDEO terminal.

Remote controller

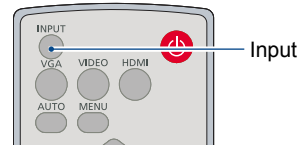

Top Control Panel

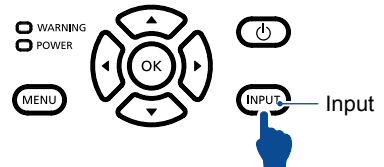

Input menu

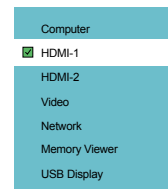

Basic operation

Network

Select input Network if a device is connected to the LAN terminal.

Memory Viewer

Select input Memory Viewer if a device is connected to the USB-A terminal.

USB Display

Select input USB Display if a device is connected to the USB-B terminal.

✓ **Note:**

- If the "input search" function in the Auto Setup option is set to "On", once you press the AUTO button, the projector will search for input signals automatically. The AUTO searching function maybe invalid for input of "USB Display", "Memory Viewer" and "Network".
- The following function will be invalid : Freeze, Aspect, Auto setup, Test pattern and Digital zoom, once "USB Display", "Memory Viewer", "Network" has been selected as signal input.
- For further details about Memory Viewer function, please turn to page 74-75,91-93.
- For further details about USB Display function, please turn to page 93-95.

Display

Auto PC adj.

Select Auto PC Adj. function can adjusts Fine sync, H position, V position , H size to be compatible with the computer automatically.

Menu operation

AUTO PC adj.

Press < MENU > button on the remote controller or on the top control panel to display the OSD menu. Press ▲▼button to select the Display menu ,then press <OK> or ►button.

- 1) Press ▲▼ button to select [Auto PC adj.] menu.
- 2) Press <OK> button.

AUTO PC adj. menu

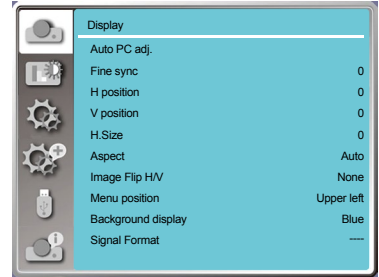

Fine sync

(Only for PC signal input)

Adujust image to the best state When the image jitters, or the image outline dims.

- 1) Press ▲▼ button to select [Fine sync] menu.
- 2) Press <OK> button.
- 3) Press ▲▼ button to adjust Fine sync .

Adjustment range is from 0 to +31. Please adjust to the least interference state.

H Position

(Only for PC signal input)

On the premise that the relative position of both projector and the screen is set up right,you can move the image horizontal position,if the position of the projected image on the screen is deviated.

- 1) Press ▲▼ button to select [H Position] menu.
- 2) Press <OK> button.
- 3) Press ▲▼ button to adjust image H position.

Adjustment range is from -5 to +5.

✓ Note:

- The projector will perform Auto PC Adjustment function automatically,when its signal is input for the first time.
- Auto PC Adjustment function may fail to work if computer models is not compatible with the input signal .
- Auto PC adjustment function does not work when HDMI input.
- Auto PC Adjustment function may fail to work if you select the following system signal format : 720 x 480i, 720 x 576i, 720 x 480p, 720 x 576p, 1280 x 720p, 1920 x 1080i, 1920 x 1080p.

Display

V Position

(Only for PC signal input)

On the premise that the relative position of both projector and the screen is set up right, you can move the image vertical position, if the position of the projected image on the screen is deviated.

- 1) Press ▲▼ button to select [V Position] menu.
- 2) Press <OK> button.
- 3) Press ▲▼ button to adjust image V position.

Adjustment range is from -5 to +5.

H size

(Only for PC signal input)

You can adjust and reduce the interference caused by patterns of the projected vertical stripes. The following projected patterns may cause a circular pattern (Noise). Adjust the amount of interference to the minimum. Users can point the clock to adjust images.

- 1) Press ▲▼ button to select [H size] menu.
- 2) Press <OK> button.
- 3) Press ▲▼ button to adjust H size level .

Adjustment range is from -15 to +15.

Aspect

Adjust the image to fit the screen size, while keeping aspect of input signal's unchanged.

Press < MENU > button on the remote controller or on the top control panel to display the OSD menu. Press ▲▼ button to select the Display menu , then Press <OK> or ► button.

- 1) Press ▲▼ button to select [Aspect] menu.
- 2) press <OK> button.
- 3) Press ▲▼ button to select the required item.

Auto....Use the maximum to project while keeping the aspect of input signal's unchanged.

16:9...Project images to aspect ratio 16:9.

Full.....Project images to the maximum.

- Only for PC (VGA) signal input .

Advanced Splicing screen.

- Only for PC (VGA) signal input .

Aspect menu

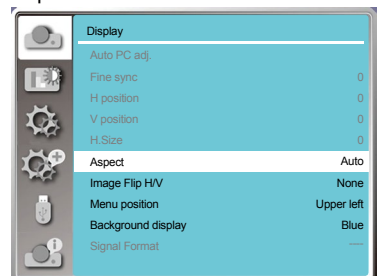

Display

- 1) Press ▲▼ button to select [Aspect] menu.
- 2) Press <OK> button.
- 3) Press ▲▼ button to select [Advanced] menu.
- 4) Press <OK> button.
- 5) Press ▲▼ button to select the required item.

H Total.....Set the H total ,and images will be vertical division by the set value. Adjustment range is from 1 to 5 of widescreen .

V Total.....Set the V total ,and images will be horizontal division by the set value. Adjustment range is from 1 to 5 of widescreen .

H Position....Set the projector in horizontal position. Adjustment range is from 1 to the current H Total value .

V Position....Set the projector in horizontal position. Adjustment range is from 1 to the current V Total value .

Image Flip H/V

Select this function to set the project way . Please change the projection way,if the OSD displays inversely or reversedly.

Press < MENU > button on the remote controller or on the top control panel to display the OSD menu. Press ▲▼button to select the Display menu ,then press <OK> or ►button.

- 1) Press ▲▼ button to select [Image Flip H/V] menu.
- 2) press <OK> button.
- 3) Press ▲▼ button to switch .

None : when the projector is installed on the table and projected in front of the screen.

Rear : when the projector is installed on the table and projected in rear of the screen (using translucent screen)

Ceiling mounted : when use the bracket to lift the projector (optional) in front of the screen.

Rear_Ceiling : when use the bracket to lift the projector (optional) in rear of the screen(using translucent screen).

Auto Ceiling : when use the bracket to lift the projector in front of the screen, automatically set to the ceiling mounted mode.

Auto ceiling,Rear : when use the bracket to lift the projector in rear of the screen, automatically set to the ceiling mounted mode.

Project way menu

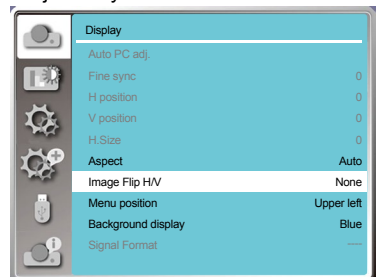

Display

Menu position

Select this function to set the OSD menu position . Press < MENU > button on the remote controller or on the top control panel to display the OSD menu.Press ▲▼button to select the Display menu ,then press <OK> or ►button.

- 1) Press ▲▼ button to select [Menu position] menu.
- 2) Press <OK> button.
- 3) Press ▲▼ button to change menu position.

Upper leftThe Menu display on the Upper left corner of the screen.

Upper right ...The Menu display on the Upper right corner of the screen.

Center.....The OSD display in the Center of the screen.

Lower leftThe Menu display on the lower left corner of the screen.

Lower rightThe Menu display on the lower right corner of the screen.

Menu position menu

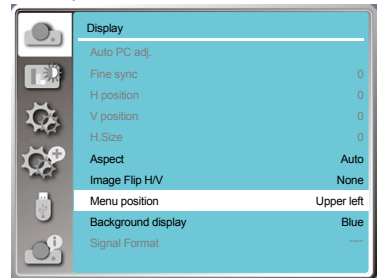

Background display

Select this function can adjusts background color. Press < MENU > button on the remote controller or on the top control panel to display the OSD menu.Press ▲▼button to select the Display menu ,then press <OK> or ►button.

- 1) Press ▲▼ button to select [Background display] menu.
- 2) Press <OK> button.
- 3) Press ▲▼ button to select required item .

Blue..... The entire projection area display blue.

Black.....The entire projection area display black.

Background display menu

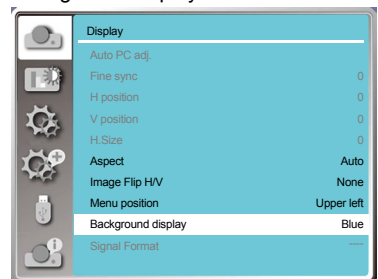

✓ Note:

This function will be invalid once you select input signal as USB Display,Memory viewer and Network.

Signal Format

Signal Format selection

If a PC is selected as the input signal source, your projector will detect and adapt to its signal format automatically. Correct image can be displayed without any setup operation.

Your projector will display one of the following:

Auto

The Auto PC Adjusting function will make necessary adjustment to your projector to project valid images. If images are displayed incorrectly, adjust it manually.

No PC signals detected. Check the connection between PC and your projector.

signal format menu

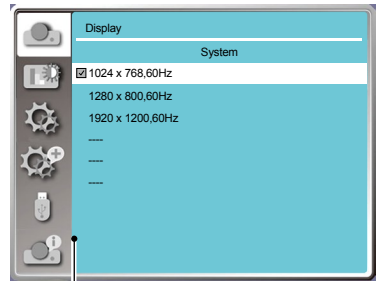

The selected input signal displays in the signal format menu.

✓ Note:

Your projector may save data generated by the Auto PC Adjusting function.

Select the signal format manually.

- 1 Press the MENU button on remote controller and the OSD displays. Press ◀▶ button to point to the Input icon, press ▲▼ button or OK button and the Input menu displays.
- 2 Press ▲▼ button to select Signal Format, then press OK button.

✓ Note:

The signal format menu will be disabled once HDMI-1, HDMI-2, Memory Viewer, LAN, USB Display has been selected.

Display

Video

Select this function to set resolution of input signal is compatible with the PC.

Set Video input signal color system or Component input signal scanning mode.

- 1) Press ▲▼ button to select [Signal Format] menu.
- 2) Press <OK> button.
- 3) Press ▲▼ button to select wanted system.

Computer input signal

1024x768 60HZ, etc:display the compatible name input signal name.

Auto: When projector has no compatible input signal with one from connected PC ,the PC can adjust automatically to run and Auto appear on the system. If the image is not projected out correctly, please adjust it to match your computer manually.

- - - -: No signal input come from PC. Please check the connections.

Video input signal

Auto: When projector select the input signal color system automatically. set [PAL-M] or [PAL-N] manually .

[PAL]/[SECAM]/[NTSC]/[NTSC4.43]/[PAL-M]/[PAL-N]/[PAL60]:When projector can not display images correctly in [Auto], please set input signal format manually.

Signal Format menu

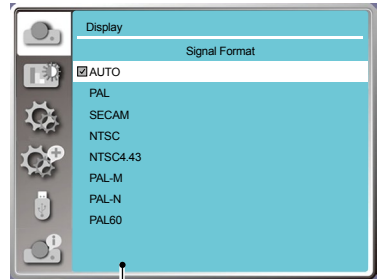

Signal Format menu, when Video input.

Color adjust

Image mode

Select color Adjustment to set the image mode and adjust the quality of the projected image

Direct operation

Press the Image Select button on remote controller to select required image mode.

Menu operation

Press < MENU > button on the remote controller or on the top control panel to display the OSD menu. Press ▲▼ button to select the Color adjust menu ,then press <OK> or ► button.

- 1) Press ▲▼ button to select [Image mode] menu.
- 2) Press <OK> button.
- 3) Press ▲▼ button to select required item.

Presentation

An image mode suitable for viewing mainly texts in bright room.

Standard

The default mode of your projector ,can come to national color.

Movie

Enriched grayscale for viewing movies.

Blackboard (Green)

An image mode designed for displaying on a blackboard (Green). It boosts quality of image projected on blackboard (Green). This is designed for a board in green rather than black as indicated by its name.

Colorboard

A image mode suitable for image projecting on surface of wall in red, blue, yellow or green. Press <OK> button. to enter colorboard menu, then press ▲▼ button to select Red ,Blue ,Yellow or Green, Press <OK> button.

User Image

Users can customize the color adjustment.

Remote controller

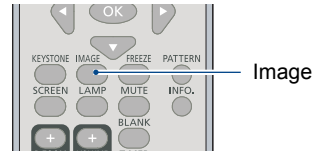
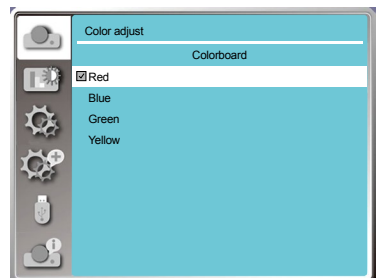

Image mode (For PC)



Colorboard



Color adjust

Color adjust

Press < MENU > button on the remote controller or on the top control panel to display the OSD menu. Press ▲▼ button to select the Color adjust menu, then press <OK> or ► button.

- 1) Press ▲▼ button to select required item.
- 2) Press <OK> button.
- 3) Press ▲▼ button to adjust setpoint.

Contrast

Press ▼ button to decrease contrast, range from 0 - +63.
press ▲ button to increase contrast, range from 0 - +63.

Brightness

Press ▼ button to decrease brightness, range from 0 - +63.
press ▲ button to increase brightness, range from 0 - +63.

Color temp.(For PC/HDMI input)

Press ▲▼ button to select required color temperature (Low, Mid. and High)

High temp: Become blue gradually.
Mid temp: Suitable natural color.
Low temp: Become red gradually.

Color level(For Video input)

Press ▼ button to decrease saturation, press ▲ button to increase saturation.

Color balance(For Video input)

Press ▲▼ button to select required tint.

Red

Press ▼ button to decrease red tint and ▲ button to increase it.

Green

Press ▼ button to decrease green tint and ▲ button to increase it.

Blue

Press ▼ button to decrease blue tint and ▲ button to increase.

Sharpness

Press ▼ button to soften image and ▲ button to sharpen, range from 0 - +15.

Color adjust(For PC/HDMI)

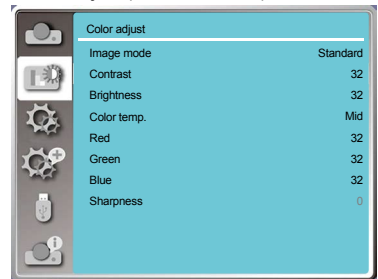

Color adjust(For Video)

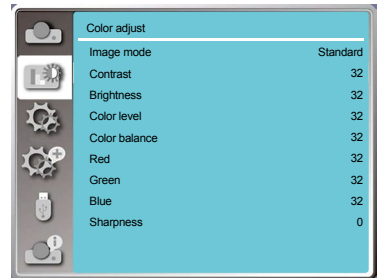

Setting

The projector has Setting function, you can select other functions as described below.

Menu operation

Press < MENU > button on the remote controller or on the top control panel to display the OSD menu. Press ▲▼button to select the Setting menu ,then press <OK> or ►button.

- 1) Press ▲▼ button to select required item.
- 2) Press <OK> button.
- 3) Press ▲▼ button to set options.

Direct Power On

You can turn on the projector by connecting the power cord only.

- 1) Press ▲▼ button to select [Direct Power On] menu.
- 2) Press <OK> button.
- 3) Press ▲▼ button to select required item.

Off..... Get into Standby mode.

On.....Start up immediately.

Standby mode

Set power consumption in standby mode,no matter whenever your projector is operated through network

- 1) Press ▲▼ button to select [Standby mode] menu.
- 2) Press <OK> button.
- 3) Press ▲▼ button to adjust levels.

Normal Even in standby mode,there are no restraint on network function and serial communication function.

Wake On Lan..This mode is to reduce power consumption and wait for Wake on Lan magic packet.

Network and RS-232C serial communication will be unavailable except the POWER ON command during that mode.

Eco.....Only RS-232C serial communication will be available .

Setting menu



Direct Power On

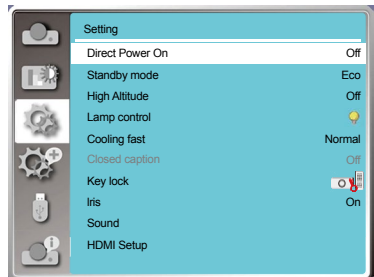

Standby mode

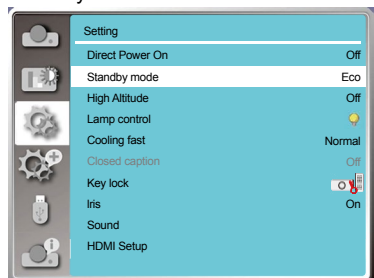

High altitude

You can change the setting about speed of cooling fan according to the altitude your projector is operating at.

- 1) Press ▲▼ button to select [High altitude] menu.
- 2) Press <OK> button.
- 3) Press ▲▼ button to select required menu.

Off: Normal speed. Set the option OFF when operating the projector, if the altitude is not too high .

On: Faster than when in Off mode .Set the option ON when operating the projector in high land .

✓ Note:

- Set high altitude option ON when you operate the operator at an altitude of 1400-2700 meters.

Lamp control

Change lamp brightness according to the environment and aim your projector is operating.

- 1) Press ▲▼ button to select [Lamp control] menu.
- 2) Press <OK> button.
- 3) Press ▲▼ button to switch required menu.



Normal.....Normal brightness.



Eco.....Lower the brightness and reduce energy consumption, thus prolonging the lamp replacement period .

High altitude

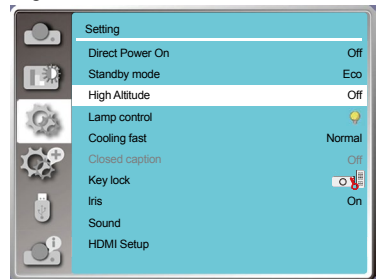

Lamp control

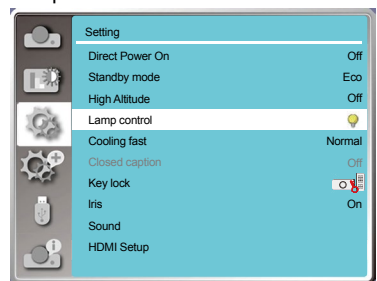

Cooling fast

Select the cooling time after projector is turned off.

- 1) Press ▲▼ button to select [Cooling fast] menu.
- 2) Press <OK> button.
- 3) Press ▲▼ button to switch required menu.

Normal.....Running in normal way.

60 Sec.....Running faster than in normal mode with shorter time but a louder sound.

immediate.....Select this function allow you to unplug the AC power directly after the shutdown, without waiting for the projector cooling off.

✓ Note:

- When select [Immediate], the time to restart the projector after turning off will be longer than usual.
- While sometimes, the lamp may take a longer time to cool off than usual to light again for high temperature.

Closed caption

Closed Caption is used for displaying the program sound or other information on the screen. Select this function to switch channel with input signal of closed caption .

- 1) Press ▲▼ button to select [Closed caption] menu.
- 2) Press <OK> button.
- 3) Press ▲▼ button to switch required menu.

OFF:No closed caption.

CC1.....Display CC1 data.

CC2.....Display CC2 data.

CC3.....Display CC3 data.

CC4.....Display CC4 data.

✓ Note:

- The icon display gray if the Closed caption function is invalid.
- The Closed caption function is invalid when the OSD menu and Timer display on the screen.

Cooling fast

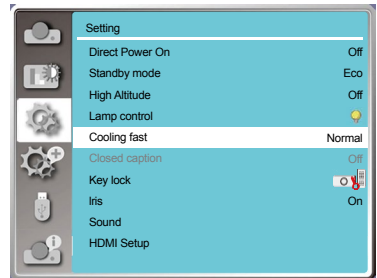

Closed caption

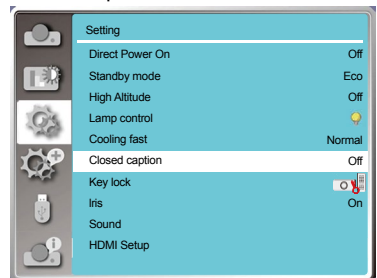



Key lock

Select this function to lock and unlock the control panel or remote controller keypad.

- 1) Press ▲▼ button to select [Key lock] menu.
- 2) Press <OK> button.
- 3) Press ▲▼ button to switch required menu.

 Off.....The control panel or remote controller keypad are effective.

 Projector.....Control panel keypad is invalid.

 Remote controller.....Remote controller keypad is invalid.

✓ Note:

- If you lock the top control panel, but without a remote controller or something wrong with the remote controller, please contact your dealer or service center.

Key lock

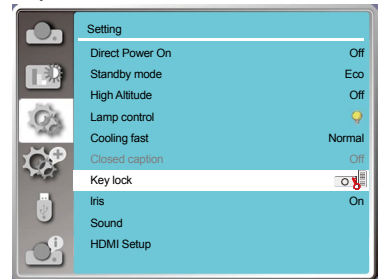

IRIS

Adjust the light output to the image signal and perform projection with emphasis on contrast.

- 1) Press ▲▼ button to select [Iris] menu.
- 2) Press <OK> button.
- 3) Press ▲▼ button to adjust levels.

OFF.....NO correction.

ON.....Correct iris.

Iris

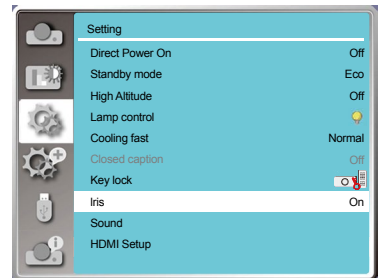

Sound

Select this function to adjust the sound.

- 1) Press ▲▼ button to select [Sound] menu.
- 2) Press <OK> button.
- 3) Press ▲▼ button to switch required menu.

Volume.....Press ▼ button to increase volume, range from 0~+25.

Press ▲ button to decrease volume, range from 0~+25.

Mute..... Press ▲▼ button to switch on or off Mute function.

On:No audio output.

Off:Audio output.

Sound

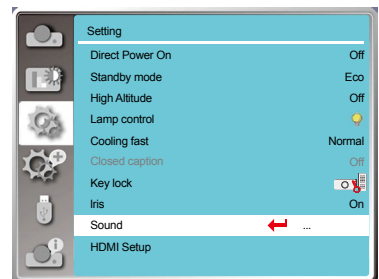

HDMI Setup

When the external device is connected to the HDMI terminal of the projector, and the images can not be projected normally, please switch on the Image or Sound setting.

Press < MENU > button on the remote controller or on the top control panel to display the OSD menu. Press ▲▼ button to select the Setting menu ,then press <OK> or ► button to enter the sub-menu.

- 1) Press ▲▼ button to select [HDMI Setup] menu.
- 2) Press <OK> button.
 - Display [HDMI Setup] instantly.
- 3) Press ▲▼ button to select [Image] or [Sound] .
- 4) Press <OK> button.

✓ Note:

- HDMI option can be chosen only in HDMI-1 and HDMI-2 channel.

HDMI Setup

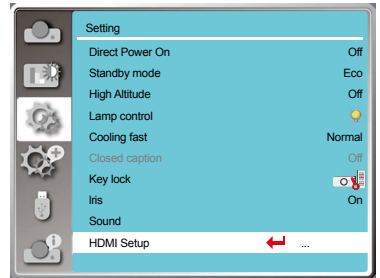

HDMI Input Range

Auto	Set the signal level automatically.
Limited	Input the limited signal level from 16 to 235.
Full	Input the full signal level from 0 to 255.

✓ Note:

- The best settings about projectors may differ slightly from your external output device .
- For external output, please refer to the instructions for use of the external device.

Sound

HDMI	When connect to the HDMI cable to tansmit images and audio while the users don't need connect to audio signal separately.
Audio I/F	When the external audio signal would be input through AUDIO IN terminal.

EQ Setting

MODE1-4	Change the HDMI reception level according to the AV device connected to the HDMI input terminal. If noise appears in the image or the image does not appear, change the settings.
---------	---

Advanced

The projector has Advanced function, you can select other functions as described below.

Menu operation

Press < MENU > button on the remote controller or on the top control panel to display the OSD menu. Press ▲▼ button to select the Advanced menu, then press <OK> or ► button.

- 1) Press ▲▼ button to select required item.
- 2) Press <OK> button.
- 3) Press ▲▼ button to set options.
- 4) Press <OK> button.

Advanced menu

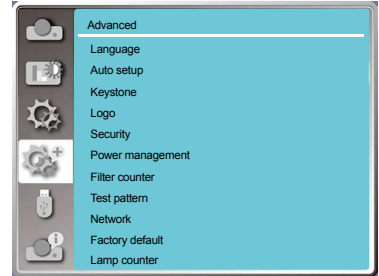

Language

Users can select the language displayed on the screen .

- 1) Press ▲▼ button to select [Language] menu.
- 2) Press <OK> button.
- 3) Press ▲▼ button to select required language.
- 4) Press <OK> button.

The name of menus, setting, the OSD, button etc., can displayed by the selected language.

Your projector comes with multiple language support. You may select required one from them, such as: English, German, French, Italian, Spanish, Polish, Swedish, Dutch, Portuguese, Japanese, Simplified Chinese, traditional Chinese, Korean, Russian, Arabic, Turkish, Finnish, Norwegian, Danish, Indonesian, Hungarian, Czech, Kazakh, Vietnamese, Thai, Farsi.

Language

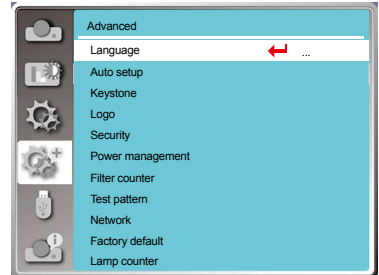

Advanced

Auto setup

Press the AUTO button on your remote controller to execute the following functions : Input search, Auto PC adj. , and Auto keystone.

- 1) Press ▲▼ button to select [Auto setup] menu.
- 2) Press <OK> button.
- 3) Press ▲▼ button to select required items.

Input search : Select this function to detect the signal, then project images automatically.

Auto PC adj. : Select this function to adjust [Fine sync], [H Position], [V Position] and [H Size] automatically, when projector input analog signals.

Auto keystone:Select this function to correct vertical distortion of the projected image automatically.

✓ **Note:**

- One of Input search, Auto PC Adj. and Auto keystone option should be set to On at least .
- Please adjust the projector manually ,if the image is displayed abnormal even if you have select Auto keystone function.
- When you set Image Flip H/V as Ceiling mounted or Rear Ceiling, and users put their projector in ceiling state, the Auto keystone function will be invalid.
- When you set Image Flip H/V as Auto Ceiling or Auto Ceiling,Rear , and users put their projector in ceiling state, the Auto keystone function will be invalid.

Keystone

Press < MENU > button on the remote controller or on the top control panel to display the OSD menu.Press ▲▼button to select the Advaned menu ,then press <OK> or ►button to enter

- 1) Press ▲▼ button to select [Keystone] menu.
- 2) Press <OK> button.
- 3) Press ▲▼ button to select required item.
- 4) Press <OK> button.

Auto setup

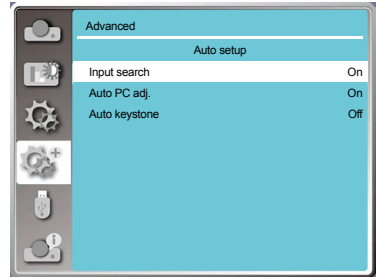

Keystone

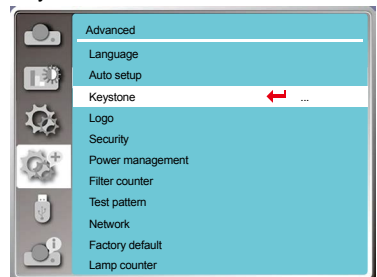

Advanced

Keystone

- This function is only when the option about Auto keystone is not set On.

Store.....Store Keystone after closing the projector or unplugging the AC power .

ResetKeystone function will be cancelled after closing the projector or unplugging the AC power when reset is set.

Keystone sub-menu

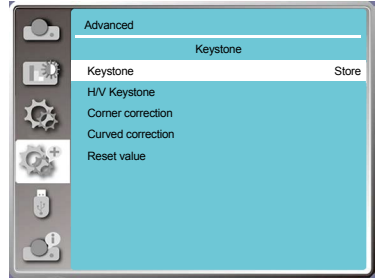

H/V Keystone

Select this function to correct the projected images horizontally or vertically

Press ▲button to reduce upper width

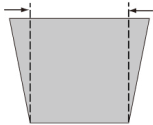

Press ▼button to reduce bottom width

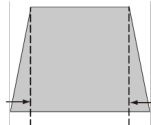

Press ◀button to reduce left width

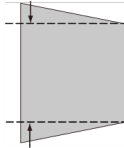

Press ▶button to reduce right width

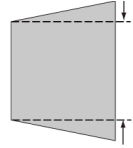

Corner adjustment

Select this function to correct the projected images of four corners distorted.

Press ▲▼◀▶ button to keystone at four corners of the screen. The four corners are looped in sequence shown below:

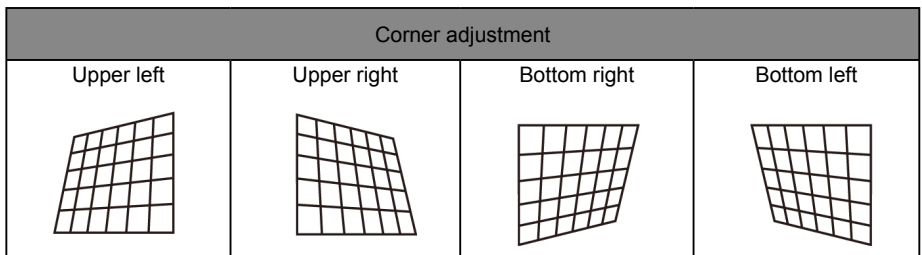

✓ Note:

- White arrow indicates no correction.
- Red arrow indicates Keystone direction .
- The arrow disappears when the correction come to the maximum.

Advanced

Curved correction(LV-WX370, LV-X350)

Select this function to correct the projected images with linearity uneven or vertical and horizontal bending deformation.

Press ▲▼◀▶ button to adjust options.

Item	Operation	Adjustment	
Curved correction X/Y gain	Press ▶	Adjust from the state of B to A	
	Press ◀	Adjust from the state of A to B	
	Press ▲	Adjust from the state of B to A	
	Press ▼	Adjust from the state of A to B	
Curved correction X compensation	Press ▶	Adjust distortion on the right	
	Press ◀	Adjust distortion on the left	
Curved correction Y compensation	Press ▲	Adjust distortion on the top	
	Press ▼	Adjust distortion on the bottom	

✓ Note:

- After adjusting values about H/V Keystone , if users adjust Corner adjustment and Curved correction, values about H/V Keystone will be reset . And after adjusting values about Corner adjustment and Curved correction, if users adjust about H/V Keystone, values about Corner adjustment will be reset.
- Curved correction X compensation and Curved correction Y compensation can not be adjusted individually. Adjust Curved correction X compensation and Curved correction Y compensation after adjusting the X/Y Curved correction.
- Press KEYSTONE button on the remote control, then the Keystone OSD menu appears (includes: H / V keystone , Corner adjustment, Curved correction and Reset value), and press ▲▼ button to to switch the four options .
- Maximum Keystone range up to $\pm 30^\circ$ vertically and $\pm 15^\circ$ horizontally. However, the image quality will deteriorate, and become more difficult to focus. Install the projector with the minimal correction value.
- The screen size will be changed with various H/V Keystone adjustments .
- Keystone may influence image aspect .

Reset value

Select this function to make adjustment value back to the factory default .

1) Press ▲▼◀▶ button to select [Reset value] option.

2) Press <OK> button.

- The value adjusted by the keystone is reset.

Logo

Logo (including Logo and Logo Passcode lock setup)
You may use this function to select Logo screen, Logo Passcode lock, change power on password, and set up default logo screen.

- 1) Press ▲▼ button to select [Logo] menu.
- 2) Press <OK> button.
- 3) Press ▲▼ button to select required items.

Logo Select

Select this to set up the logo screen when power on your projector:

Canon(default)....Display factory default logo screen.

User*.....Display capture logo screen.

Off.....Display countdown logo screen.

*Only for LV-WX370 / LV-X350

Capture(LV-WX370 / LV-X350)

Enable us to capture images being projected and use it for a startup display or interval of presentations. Upon capturing the projected image, press OK button, then a confirmation box appears, Select Yes to capture it .

After capturing the projected images, go to "select a logo", and set it to "User". Then, the captured image is displayed when the projector is turned on next time.

Logo Passcode lock

LOGO Passcode lock

This function helps preventing unauthorized personnel from changing the Logo screen.

Off.....The Logo screen may be changed with the Logo menu..

On.....You may not alter the logo screen without the Logo Passcode.

To change the Logo Passcode protection, press OK key, and the Logo Passcode change popup dialog box prompts. Follow steps below to enter a logo screen password.

- Press arrow ◀▶ button to select a number, then press OK button to enter it and move the cursor. The number you typed is displayed as “ * ”. To edit number you have entered, press MENU button to move the cursor to the number you want to change, press ▲▼ button to select the correct one.
- Repeat this step to type in a 3-digit number. Move the cursor to SET after you have typed the 3-dit number. Press OK button.
- If the password is invalid, the password displayed as “ *** ” will be in red. Please try again with a valid one.
- After you have entered valid logo screen Passcode, you may press ◀▶ button to toggle switch Off and On.

Logo Passcode Change

You may change the Logo Passcode to any 3-digit number you like. Press OK key to select Logo Passcode change. The Logo Passcode change dialog box prompts, press arrow ◀▶ button to give a valid new code. The New Logo Passcode dialog box prompts. Set up a new Logo Passcode, check contents contained in the dialog box, select Yes and the new password is set now. Please remember your new password and keep it safe.

To cancel the logo pass code, set the factory default settings.

Logo menu

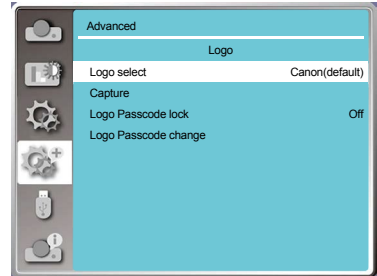

✓ Note:

- After changing the Logo Passcode to a new number, please remember it and keep it safe. The Logo Passcode cannot be changed again if the new password is lost or forgotten.

Security

Set a passcode to lock the usage of the projector to prevent unauthorized personnel from operating your projector. Once the projector is on, the [passcode] screen will be displayed.

- 1) Press ▲▼ button to select [Security] menu.
- 2) Press <OK> button.
- 3) Press ▲▼ button to switch required item.

Passcode lock

Passcode lock

This function helps preventing unauthorized personnel from using the projector.

Off.....Passcode lock function is not available.

On..... The [Passcode] screen will appear when the projector is on.If you want to change the PassCode Lock or Passcode (for three digits), you must enter the Passcode. The factory default password is "111."

Security menu

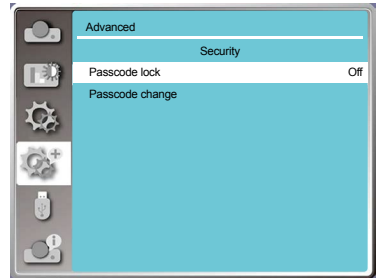

Passcode Change

- You can change the Passcode. Click the [OK] button and select [Change Passcode]. When the [Passcode] dialog box is displayed, press the [← / →] button to enter a valid Passcode, and select [Set] to display the [New Passcode] dialog box. Set a new Passcode, confirm the contents in the dialog box, and select Set to set a new Passcode.
- The number you typed is displayed as “ * ”. To edit number you have entered, press MENU button to move the cursor to the number you want to change, press ◀▶ button to select the correct one.
- Repeat this step to type in a 3-digit number.
- Enter a three-digit number, move the cursor to "set" . Press the OK button, you can start to operate the projector.
- If the Passcode is invalid, the Passcode displayed as “ *** ” will be in red. Please try again with a valid one.
- Please remember your new password and keep it safe.

To Cancel the Passcode

- (1) While simultaneously pressing the [POWER] button and [OK] button on the main unit, plug the power cord into the main unit and wait until the LED changes from blinking to lighting.
- (2) When the [POWER] button is pressed and lit, the pass code input screen appears. Enter "111".
- (3) Select OSD menu security >> passcode >> "on". As the input screen appears again, enter the default value (111) and set the pass code to "off" or set a new pass code.

Power management

To reduce power consumption and maintain life cycle of lamp, the power management function will turn off the projection lamp if your projector has no signals for a period of time.

- 1) Press ▲▼ button to select [Power management] menu.
- 2) Press <OK > button.
- 3) Press ▲▼ button to switch required item.

Ready.....The POWER light indicator flashes green when the lamp is fully cooled down. The lamp turns on again if an input signal is connected or any key (except the  power button) on the rear panel and remote controller is pressed during this period of time.

Shut down....The projector shut down after the lamp is fully cooled down.

Disable.....Disable the power management function.

Timer.....Once the input signal is interrupted and no keys has been pressed for 30 seconds afterwards, the "No signal" message displays in the timer. The timer counts down until the lamp turns off. Press arrow key to set up the timer in range of 1~30 minutes.

Ready Countdown... Set up the interval from ready mode change to standby (0 to 30 minutes). A setting of zero minute keeps your projector from auto transition.
· Press the Power key to change your projector from ready to standby mode and any other key to power it on.

Power management menu

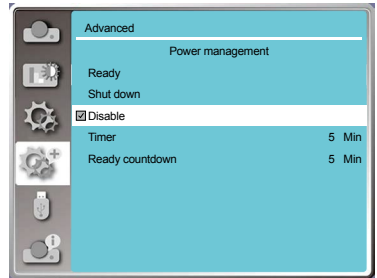

Power management

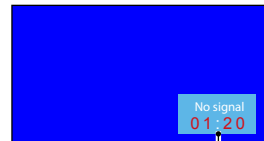

Remaining time before poweroff the lamp.

✓ **Note:**

- Factory default for standby time: 5 minutes. Count down for ready mode: 5 minutes.

Filter counter

Set this function to reset the filter usage time and set up warning display.

- 1) Press ▲▼ button to select [Filter counter] menu.
- 2) Press <OK> button.
- 3) Press ▲▼ button to switch required item.

When the projector reaches the user-set cleaning time, filter warning icon will appear on the screen to notify the user needs to clean the projector filter. Please make sure to select the initial state and set the timer after cleaning it. once resetting filter counter, filter warning icon will be closed.

Filter.....Displays the filter usage time.

Timer.....Set the time to display a warning icon.

Filter counter resetreset filter counter.

Filter check..Check the temperature inside the projector and make reactions.

On: Check filter.

- Once the projector has checked any filter problem , the screen will display a warning icon"Filter warning! Please change the filter! " .

Off: DONOT check filter.

Filter counter menu

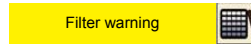
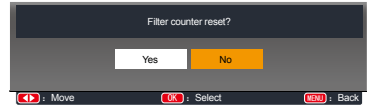
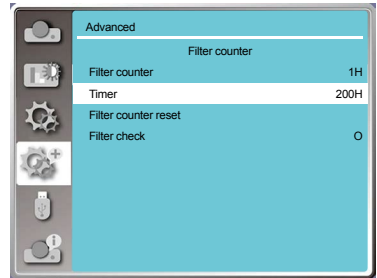

✓ Note:

- The screen will display the icon "Filter warning! Please change the filter! " when the projector has checks one warning. And the the warning icon will disappear 30S later atuomatically, while only the POWER button is effective during that period.

Test pattern

Select this function to display the projector's built-in test pattern.

- 1) Press ▲▼ button to select [Test pattern] menu.
- 2) Press <OK> button.
- 3) Press ▲▼ button to switch required item.
- 4) Press <OK> button.

Gray scale 1 / Gray scale 2 / Gray scale 3 / Gray scale 4 / Color bar / Red / Green / Blue / Cross hatch / White / Black / Raster gray: Use The OSD menu to display the test pattern.

Test pattern menu

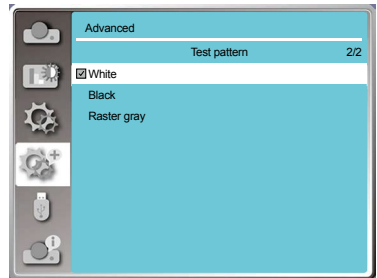
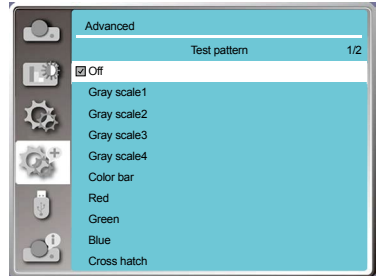

Network

Preparation

- 1 Required equipment: Projector, computer, network cable
- 2 Connection:
Connect your projector to a router or switch in the LAN with normal or jumper network cable. In case a normal network cable failed to connect successfully, use a jumper cable instead.
- 3 Turn on the computer. The LAN port on computer and projector are flashing after power on the projector.

Operation steps

- 1 Power on your projector.
- 2 Acquire the IP address, with DHCP set to on and auto IP allocation set to On. (You may set DHCP to Off and set up IP address manually.)
- 3 Enter the network setup menu
 - (1) Press MENU button on remote controller or top control panel, press ▲▼ button to select network icon.
 - (2) Press ▲▼ button select network settings and press OK button to enter.
MAC address.....Display the MAC address of wired network.
IP address.....Display the IP address of wired network.
 - (3) Press ▲▼ button to set DHCP On to obtain an IP address, subnet , gateway and DNS automatically , and press OK button to confirm.

Press ▲▼ button to set DHCP Off, then press OK button to enter an IP address, then press ▼ button to select subnet , gateway and DNS automatically. And press OK button to confirm.

Network menu

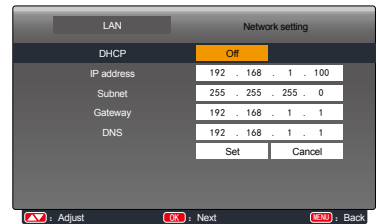
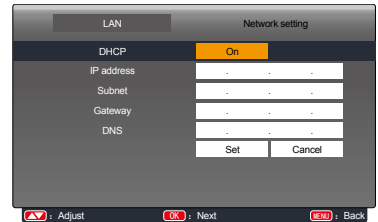
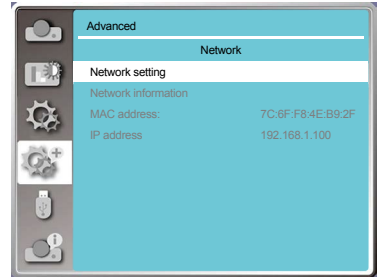

Factory default

This function resets all your settings to factory default .

- 1) Press ▲▼ button to select [Factory default] menu.
- 2) Press <OK or ►> button.
- 3) Press ◀▶ button to select YES ,then press <OK> button.

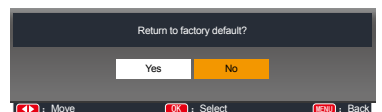

Lamp counter

Make sure to reset the lamp counter, when replacing the lamp. Then the WARNING indicator goes out and the lamp replacement icon will disappears.

- 1) Press ▲▼ button to select [Lamp counter] menu.
- 2) Press < OK or ► > button.
- 3) Press ▲▼ button to select the "Lamp replacement Reset? ", and press the < OK > button. The "Lamp replacement counter Reset ?" message displays. Select Yes to proceed.
- 4) In another pop-up dialog box, select Yes to reset the Lamp counter.

✓ Note:

- DONOT reset the lamp counter, unless you need to replace the lamp.

Filter counter menu

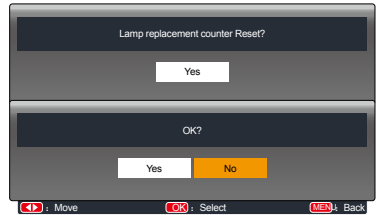
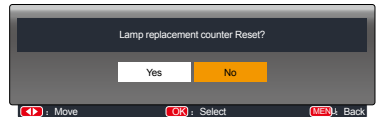
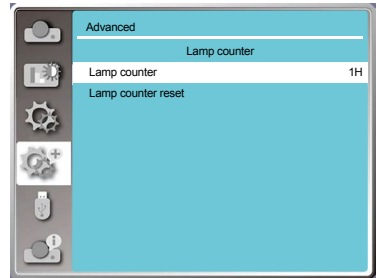

Memory Viewer

When the USB memory is inserted into the projector, the viewer memory function can project the video and pictures stored in the USB memory. Press < MENU > button on the remote controller to display the OSD menu. Press ▲▼ button to select the Memory Viewer menu, then press <OK> or ► button.

- 1) Press ▲▼ button to select required item.
- 2) Press <OK> button.
- 3) Press ▲▼ button to set options.
- 4) Press <OK> button.

Start slide

Select this function to play slides.

- 1) Press ◀▶ button to select a file.
- 2) Press ▲▼ button to select [Start slide] menu.
- 3) Press <OK> or ► > button.
 - Full screen display
 - Press <OK> to return the thumbnail.

Slide transition effect

Select this function to set the slide's playback, when switching slides.

- 1) Press ▲▼ button to select [Slide Transition effect] menu.
- 2) Press <OK> or ► > button.
- 3) Press ▲▼ button to switch required item.
 - Slide down.....Switch slides from the upper to the lower .
 - Slide right..... Switch slides from left to the right.

Sort order

Select this function to set the slide's order.

- 1) Press ▲▼ button to select [Sort order] menu.
- 2) Press < OK > button.
- 3) Press ▲▼ button to switch required item.
 - Expand order.....Sort by expand names of file or folder.
 - Size order.....Sort by size of file or folder.
 - Time order.....Sort by the time of file or folder.
 - Name order..... Sort by names of file or folder.

Memory Viewer menu

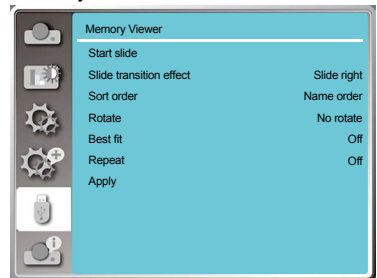

Note:

- When selecting [Memory Viewer] as input signal, the "Memory Viewer" menu is available.
- In addition to "Start slide" menu, even change the settings, If you do not implement the [Application], the setting value of the change is invalid.

Memory Viewer

Rotate

Set the rotation direction of images.

- 1) Press ▲▼ button to select [Rotate] menu.
- 2) Press < OK > button.
- 3) Press ▲▼ button to switch required item.

No rotateRotation is invalid.

270 Degree.....Rotate counterclockwise by 270 degrees.

180 Degree.....Rotate clockwise by 180 degrees.

90 Degree..... Rotate clockwise by 90 degrees.

Best fit

Set the image to be compatible with projection screen.

- 1) Press ▲▼ button to select [Best fit] menu.
- 2) Press < OK > button.
- 3) Press ▲▼ button to switch required item.

On.....Display images by the aspect ratio of the screen.

Off.....Display image by the normal pixels.

Repeat

Select this function to play slides repeatedly.

- 1) Press ▲▼ button to select [Repeat] menu.
- 2) Press <OK or ► > button.
- 3) Press ▲▼ button to switch required item.

On.....Replay the first document,after playing the last one.

Off.....Return to the thumbnail display screen,after playing the last one.

Apply

Only be used in playing slides.

- 1) Press ▲▼ button to select [Apply] menu.
- 2) Press <OK or ► > button.

Info.

Select Info. function to detect the projected image signal and the projector operating status.

Menu operation

Press <Info. > button on the remote controller or < MENU > button on the control panel to display the OSD menu. Press ▲▼ button to select the Info. menu, then press <OK> or ► button.

Info. display as follows:

Input : Display selected input source.

H- sync. Freq. ...Display H- sync. Freq. of input signal in unit of KHz. Show “---KHz” when no signals are in existence.

V- sync. Freq....Display V- sync. Freq of input signal in unit of KHz. Show “---KHz” when no signals are in existence.

Lamp status.....Display selected Lamp.

Lamp counter.....Display the lamp's usage time.

Power management... Display selected Power management mode.

Image mode...Display selected Image Mode.

Info. menu

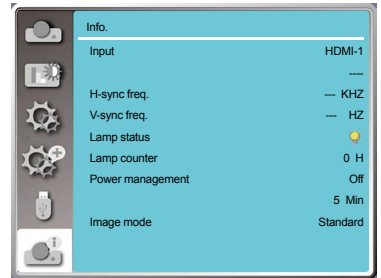

Network control operation

Function: This function is designed to remote control computer in the same LAN.

Preparation

- 1 Required equipment: Projector, computer, network cable
- 2 Connection:
Connect your projector to a router or switch in the LAN with normal or jumper network cable. In case a normal network cable failed to connect successfully, use a jumper cable instead.
- 3 Turn on the computer. The LAN port on computer and projector are flashing after power on the projector.

Operation steps

- 1 Power on your projector.
- 2 Acquire the IP address, with DHCP set to on and auto IP allocation set to On. (You may set DHCP to Off and set up IP address manually if you are somehow familiar with networking.)
- 3 Enter the network setup menu
 - (1) Press MENU button on remote controller or top control panel, press ▲▼ button to select network icon.
 - (2) Press ENTER button or ► button and the network menu displays.
 - (3) Press ▲▼ button select network settings and press ENTER to confirm.
 - (4) Press ▲▼ button to set DHCP On and press OK button to confirm.
 - (5) Press ▲▼ button to select Set, press OK button to wait until the "Please wait.." message disappears.

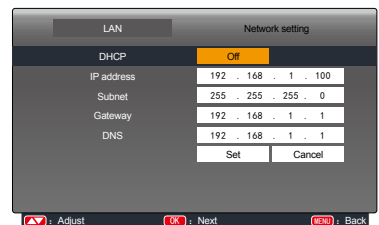
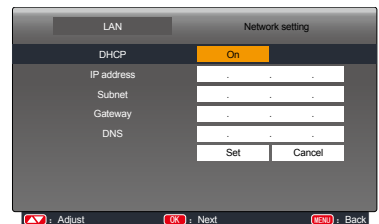
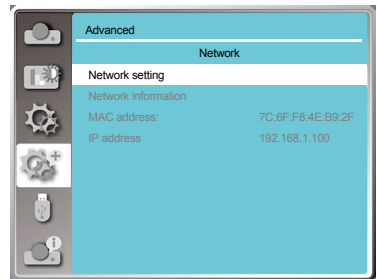

✓ Note:

- If you are using the wireless network connection, please check the SSID / ESSID and wireless IP address in the Network Setting status, and write down the information.

Network control

Enter through a Web browser

- 1) Start the computer's Web browser.
- 2) Enter the IP address on the projector set in the URL input field of the Web browser.
- 3) Enter the password in the [Password], then click [Login].
** "the factory default setting is the user name: "admin" (administrator privileges), password: "admin".

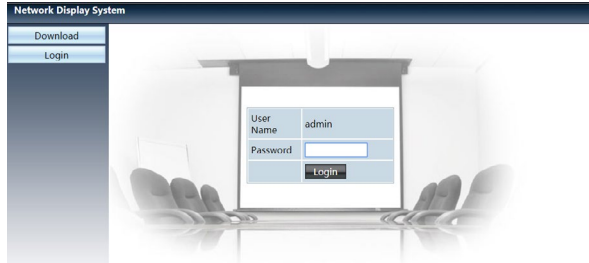

- 4) Click the [Login]

NOTE:

Users can click on the top right corner of the Web browser screen to select the display language.

Do not start multiple Web browser settings or control. Do not use more than one computer set or control the projector.

Please change your password.

If the network does not appear on screen controls, please consult your network administrator. Description of each option

Network Display System > System Status	
① System Status	Model Name: Solo WUXGA
② General Setup	Versions
③ Picture Setup	Firmware Version: 1.00 .1004
④ Image Setup	LAN Status
⑤ Network Setup	IP Address: 192.168.0.26
	Subnet: 255.255.255.0
	Gateway: 192.168.0.1
	Wire MAC Address: 7c:6f:f8:4d:1c:b6

- ① System Status: Click this option to display the [System status] page.
- ② General Setup: Click this option to display the [General Setup] page.
- ③ Picture Setup: Click this option to display the [Picture Setup] page.
- ④ Image Setup: Click this option to display the [Image Setup] page.
- ⑤ Network Setup: Click this option to display [Network Setup] page.

[System Status] page

Network Display System > System Status	
System Status	Model Name: Solo WUXGA
General Setup	Versions
Picture Setup	Firmware Version: 1.00 .1004
Image Setup	LAN Status
Network Setup	IP Address: 192.168.0.26
	Subnet: 255.255.255.0
	Gateway: 192.168.0.1
	Wire MAC Address: 7c6ff84d1c66

- ① Versions: Displays the firmware version of the projector.
- ② LAN Status: Displays the LAN connection status.

[General Setup] page

Network Display System > General Setup	
System Status	Change Password for Webpage
General Setup	Enter Old password: <input type="text"/>
Picture Setup	Enter New password: <input type="text"/>
Image Setup	Confirm New password: <input type="text"/> <input type="button" value="Apply"/>
Network Setup	Power & Source
	Power: <input type="checkbox"/> On <input type="checkbox"/> Off
	Source Select: HDMI-2

- ① Enter old password: Enter the password for the configuration.
- ② Enter new password: Enter a new password.
- ③ Confirm new password: Re-enter the new password to confirm.
- ④ Power & Source: Update settings.
- ⑤ Power: Switch on the power of the projector on / off.
- ⑥ Source select: Switch the input source of the projector.

[Picture Setup] page

Network Display System > Picture Setup	
System Status	Brightness (0 --- 63): <input type="text" value="32"/>
General Setup	Contrast (0 --- 63): <input type="text" value="32"/>
Picture Setup	Sharpness (0 --- 15): <input type="text" value="8"/>
Image Setup	Color level (0 --- 63): <input type="text" value="0"/>
Network Setup	Color balance (0 --- 63): <input type="text" value="0"/>
	Color Temperature
	Red (0 --- 63): <input type="text" value="32"/>
	Green (0 --- 63): <input type="text" value="32"/>
	Blue (0 --- 63): <input type="text" value="32"/>

- ① Brightness: Adjust the brightness of the projected image.
- ② Contrast: Adjust the contrast of the projected image.
- ③ Sharpness: Adjust the sharpness of the projected image.
- ④ Saturation: Adjusts color saturation of the projected image.
- ⑤ Tint: Adjusts the tint of the projected image.
- ⑥ Color Temperature: Adjust the color temperature of the projected image.

[Image Setup] page

Parameter	Value	Unit
Aspect	Normal	
Fine sync (0 ~ 31)	0	
H Position	0	
V Position	0	
H Size (15 ~ 15)	0	
Freeze	On / Off	
Auto PC adj.		
V Keystone (-60 ~ 60)	0	
H Keystone (-30 ~ 30)	0	
Curved correction XGain (-40 ~ 40)	0	
Curved correction YGain (-40 ~ 40)	0	
Curved correction XOffset_x (0 ~ 1279)	512	
Curved correction XOffset_y (0 ~ 799)	84	
Curved correction YOffset_x (0 ~ 1279)	512	
Curved correction YOffset_y (0 ~ 799)	84	
Corner correction TopLeft_x (0 ~ 1279)	0	
Corner correction TopLeft_y (0 ~ 799)	0	
Corner correction TopRight_x (0 ~ 1279)	1023	
Corner correction TopRight_y (0 ~ 799)	0	
Corner correction BottomLeft_x (0 ~ 1279)	0	
Corner correction BottomLeft_y (0 ~ 799)	767	
Corner correction BottomRight_x (0 ~ 1279)	1023	
Corner correction BottomRight_y (0 ~ 799)	767	

- ① Aspect: Switch the aspect ratio of the projected image.
- ② Fine sync: Adjust the phase of the projected image.
- ③ H position: Adjust the horizontal position of the projected image.
- ④ V position: Adjust the vertical position of the projected image.
- ⑤ H Size: Adjust the horizontal dimension of the projected image.
- ⑥ Freeze: Select the function to switch the screen freeze on and off.
- ⑦ Auto PC adj.: Implement the automatic computer adjustment function.
- ⑧ V keystone: Correct trapezoidal distortion in vertical direction.
- ⑨ H keystone: Correct horizontal distortion in horizontal direction.
- ⑩ Curved correction*: Correct pincushion and barrel of the projected image.
- ⑪ Corner correction: Correct four angles of the projected image.

*Only for LV-WX370/LV-X350

[Network Setup] page

Obtain an IP address automatically		Use the following IP address	
IP Address	192	168	0 26
Subnet	255	255	255 0
Gateway	192	168	0 1
DNS	192	168	0 1

① Network Setup

If you want to enable the DHCP client, select the IP address automatically.

IP address:

Please enter the IP address when you do not use the DHCP server.

Subnet :

Please enter a subnet shield,when you do not use the DHCP server .

Gateway:

Please enter the gateway ,when you do not use the DHCP server.

DNS:

Please enter the DNS address, when you do not use the DHCP server.

Available characters : digital (0 - 9), a period (.)

(For example: 192.168.0.253)

② Apply

Update settings.

Network Display

When the input signal source is chosen as the LAN, the network will be used to project computer image.

After entering the IP address of the projector in the web page to the main interface, click "Download", and download the corresponding PwPresenter software with your projector.

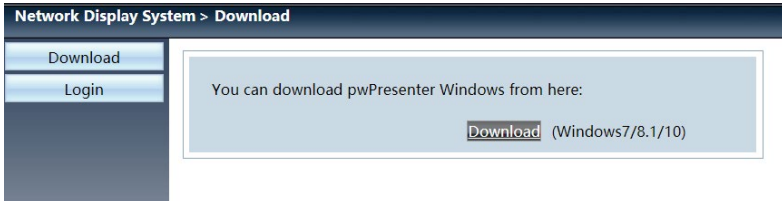

Click  the icon to enter into pwPresenter software.

Windows Firewall

The following alert may be displayed the first time you start the software, depending on your Windows Firewall settings.

To enable communication with projectors, select all check boxes and click the [Allow access].

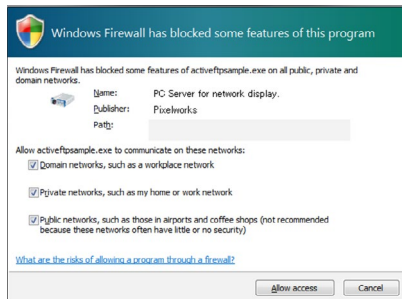

To change the settings after closing the alert, open the [Start] menu and select [Control Panel] > [System and Security] > [Windows Firewall] > [Allow an app through Windows Firewall].

Select [pwpresenter.exe] in the list of allowed apps and features, and then select each check box.

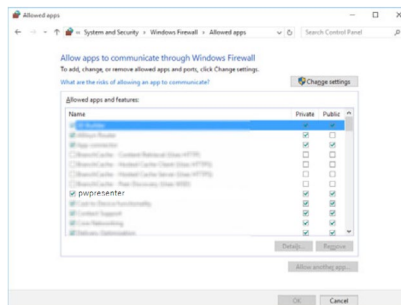

Network control

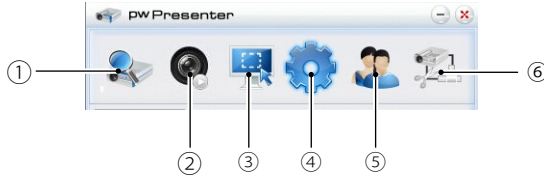

① Search for network display

With the search conditions empty, click "Search" to search, select the required projector and connect. Alternatively, enter the IP address of the projector (example: 192.168.1.100) and click "Connect".

✓ NOTE

- Before using the pwPresenter search, please switch to network signal source.

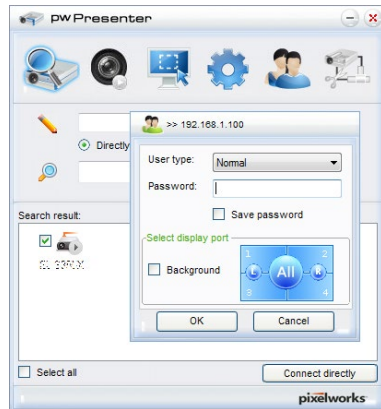
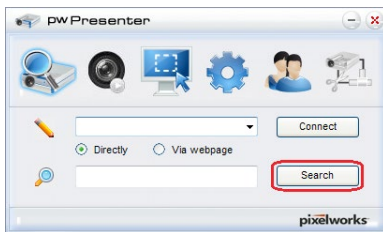

② Screenshot start or pause

Start or pause the selected pictures.

③ Chose capture mode

Select the screen shot mode from "full range", "fixed size" or "variable size", and set the projection size.

Network control

④ Parameters setting

Basic setting: Language, Capture region size etc.

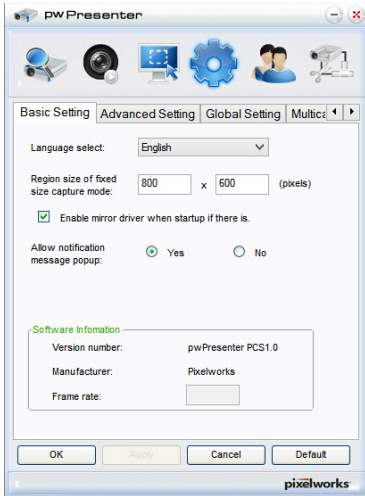

Advanced setting: JPEG image setting, Network port setting, White list and Black list etc.

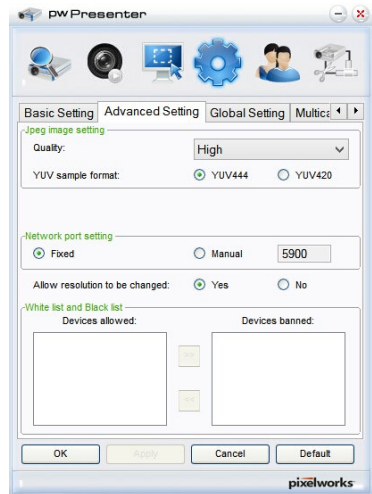

Global setting: Remote control setting, Sound capture and Screen capture, etc.

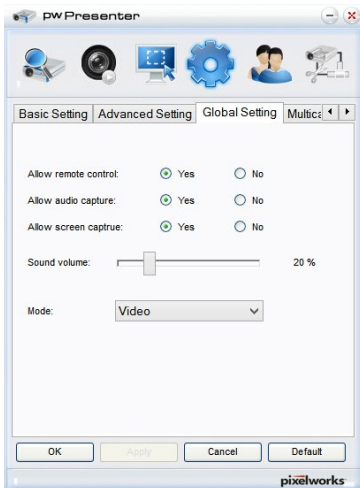

Multicast setting: Volume setting, Bandwidth, Sampling frequency, etc.

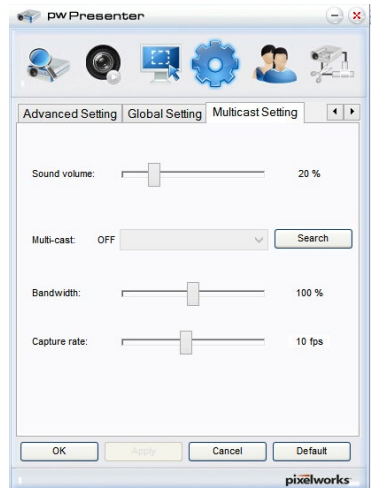

Network control

- ⑤ Network display Management
Set pwPresenter network user name and password etc.

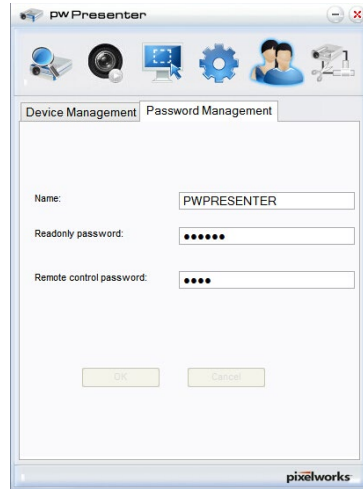
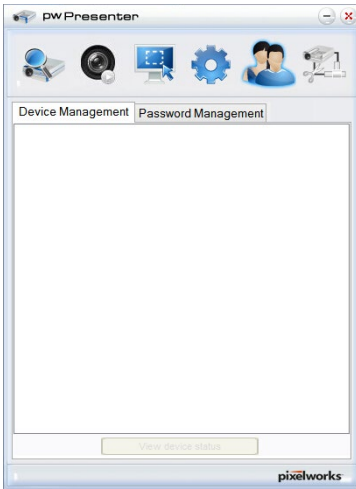

- ⑥ Stop all the connections

Controlling the projector remotely through a web browser (e-Control®)

Once you have the correct IP address for the projector and the projector is on or in standby state, you can use any computer that is on the same local area network to control the projector. When using this function, Adobe Flash Player has to be installed in your computer. Please download the latest version of Adobe Flash Player from the website of Adobe Systems Incorporated.

Recommended operating systems: Win7, Win8.1, Win10, Mac OS X v10.5 ~ v10.14.

1. Enter the IP address of the projector in the address bar of your browser and press enter. (for example, <http://192.168.0.146>)



Recommended web browsers: IE11, Chrome 44.0 and below.

2. The remote network operation page is displayed. This page allows you to operate the projector as if you were using the remote control or control panel on the projector.

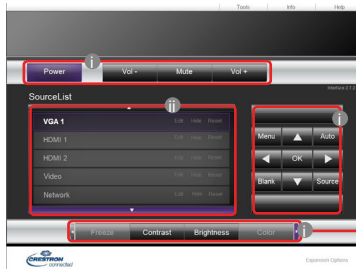

Press ◀ / ▶ to reveal more buttons.

- i. These buttons function the same as the ones on the OSD menu or remote control. See "2.PICTURE menu" on [page 41](#) and "Remote control" on [page 30](#) for details.
- ii. To switch input source, click on your desired source.

When you use the projector control panel or remote control to change the OSD menu settings, it may take a while for the web browser to synchronize these changes with the projector.

3. The Tools page allows you to manage the projector, configure the LAN control settings and secure access of remote network operation on this projector.

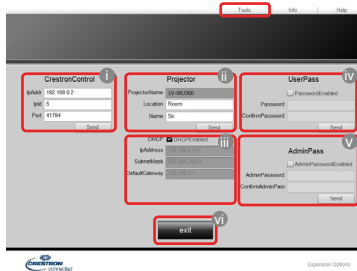

- i. When using the Crestron Control System, please refer to the user manual of Crestron Control system for setup information.
- ii. You can name the projector, keep track of its location and the person in charge of it. This column allows a maximum of 22 single-byte characters.

Network control

- iii. You can adjust the LAN Settings.
 - iv. Once set, access to the remote network operation page on this projector has been passwordprotected.
 - To enable this function, check the box in front of "Enable" and type in your desired password in the New Password column and confirm the new password by re-entering the new password at the Confirm column. To disable password protection, uncheck the box.
 - v. Once set, access to the Tools page has been password-protected. Refer to step iv for how to use the password function.
 - vi. Press Exit to go back to the remote network operation page.
- After making the adjustments, press the Send button and the data will be saved in the projector.
 - Once the password is set, the Log Out button will display beside the Tools button.
 - Write down your selected password in advance or right after the password is entered so that it is available to you should you ever forget it.
 - If you did not write down your password, and you absolutely do not remember it you can reset the password by following procedure.
 - Open log in screen of e-Control. by your web browser.
 - Long press MENU and ► Right on the projector for 3 seconds.
 - Now the password has been reset.
 - The software is available in English language.
 - When DHCP is turned on, there is a possibility of stopping the webpage connection. If this happens, please check the new IP address of the projector and enter the new address to connect again.
4. The Info page displays the information and status of this projector.

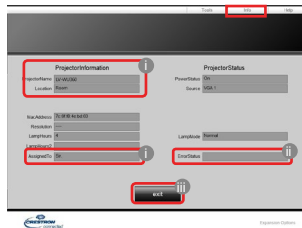

- i. The information you entered in the Tools page will display here and these columns are empty when you use e-Control™ for the first time.
- ii. When the projector is in abnormal conditions, the following information will display.

When the projector is in normal conditions or in any abnormal conditions other than the ones mentioned below, the Error Status column will be "0:No Error".

Error Status	Description
3: Lamp fail	The lamp fails to ignite or turns off during operation.
3: Over Temp	The projector temperature is too high or cannot be detected.
3: Fan Lock	The fan rotation speed cannot be set or detected.
3: Over Lamp	Usage Time The lamp is still in use after the lamp warning messages display.

Network control

(3 = error)

- iii. Press Exit to go back to the remote network operation page.
5. After pressing the button 'Help', the Title window will appear at the upper right corner. You will be able to deliver messages to RoomView™ software which is connected to the same local area network.



For more information, visit <http://www.crestron.com> & www.crestron.com/getroomview.

Controlling the projector using PJLink™ application

This projector supports standard protocol PJLink™ for projector control and you can control and monitor projector's operations using the same application among projectors of different models and different manufacturers.

About PJLink™

- To use PJLink™ function, the PJLink™ application software is required.
- For the specifications of PJLink™, access to the Web site of Japan Business Machine and Information System Industries Association (JBMIA). (<http://pjlink.jbmia.or.jp/english>)
- This projector is fully compliant to the specifications of JBMA PJLink™ Class 1. It supports all the commands defined by PJLink™ Class 1, and the compliance has been verified with the PJLink™ standard specifications Version 1.4.

Utilizing the password function

To prevent unauthorized connection to the projector via PJLink™ application, the projector includes an option for setting up password security. To set the password:

1. Open the link to the website and enter **Network Display System**: select **Network Setup** menu.
2. In **PJLink Setup** options, select **Password Enable**.
3. Enter the password in the column after **Input Password** option.
4. Enter the password you need to change and select from the number 0-9.
5. Enter the change password again in the column after the **Confirm Password** option and Press **Apply** to confirm.

If you forget the password, please use the password "projectorcontroller".



Network control

PJLink™ supported commands

The table below shows commands to control the projector using the PJLink™ protocol.

Command	Description	Remark (Parameter)
POWR	Power control	0 = Power off 1 = Power on
POWR?	Inquiry about the power state	0 = Standby 1 = Power on 2 = Cooling down 3 = Warming up
INPT	Input switching	11 = COMPUTER 21 = VIDEO 31 = HDMI-1 32 = HDMI-2
INPT?	Inquiry about input switching	41 = USB Viewer 51 = USB Display 52 = LAN
AVMT	Mute control	10 = BLANK disable 11 = BLANK enable 20 = Audio mute disable
AVMT?	Inquiry about the mute state	21 = Audio mute enable 30 = BLANK and audio mute disable 31 = BLANK and audio mute enable
ERST?	Inquiry about the error state	1st byte: Fan error, 0 or 2 2nd byte: Lamp error, 0 or 2 3rd byte: Temperature error, 0 or 2 4th byte: Always 0 5th byte: Always 0 6th byte: Other errors, 0 or 2 * 0 or 2 mean as follows: 0 = No error detected, 2 = Error
LAMP?	Inquiry about the lamp state	1st value (1 to 4 digits): Cumulative lamp operating time (This item shows a lamp operating time (hour) calculated based on that Lamp Mode is Economic.) 2nd value: 0 = Lamp off, 1 = Lamp on
INST?	Inquiry about the available	The following value is returned. "11 21 31 32 41 51 52"
NAME?	Inquiry about the projector	The command responds with the projector name specified in the Tools page.
INF1?	Inquiry about the manufacturer name	"Canon" is returned.
INF2?	Inquiry about the model name	"LV-WU360" or "LV-WX370" or "LV-X350" is returned.
INFO?	Inquiry about other information	"Version number" is returned.
CLSS?	Inquiry about the class information	"1" is returned.

• The PJLink "INPT?" will be replied only when the source is displayed on screen. When there is no signal, only "ERR3 Time!" will be answered.

Network control

- The above-mentioned control may not be performed correctly or the monitoring data may not be obtained correctly in the following conditions:
 - During standby
 - During input source switching
 - During command processing
 - During AUTO PC execution
 - Before the splash screen disappears after the power is turned on.
- Use 1 computer to control/monitor 1 projector.
- For how to control/monitor using PJLink™, see the operation manual of the PJLink™ application you use.
- When you monitor the projector's operating state using this function by issuing inquiry commands successively, issue an inquiry command after receiving the response to the previous inquiry command from the projector.

Using the Network Function when the projector is in standby mode

When the Standby LAN in the SYSTEM SETUP: Advanced > LAN Settings menu is activated, the projector is able to provide the network function when it is in standby mode.

Glossary

For more detail of the glossary below, refer to the technical book that is commercially available.

Term	Description
DHCP	Abbreviation for Dynamic Host Configuration Protocol. This protocol automatically assigns IP Address to networked devices.
IP Address	Numerical address to identify networked computers.
Subnet Mask	A numeric value to define the number of bits used for a network address of a divided network (or subnet) in an IP Address.
Default Gateway	A server (or router) to communicate across networks (subnets) that are divided by Subnet Mask.

Useful function

Memory Viewer function

When the USB memory is inserted into the projector, the viewer memory function can project the video and pictures stored in the USB memory.

■ The projected content of Memory Viewer function
Memory Viewer function supports the following picture files.

Video	Extension name	Video Codec	Audio Codec	Video Format
	avi	MotionJPEG	ADPCM	Maximum 1280x720,30fps

Maps	Extension name	Format	Description
	jpg/jpeg	Baseline encoder 24 Progressive RGB24 bit	Max resolution: 10000x10000 Max resolution: Panel Resolution
	bmp	1,4,8 bit palette-based RGB24,32 bit	Max resolution: 1280X800
	png	24, 48-bit True Color	
	gif	1,4,8-bit palette-based	
	tiff		

Display memory viewer screen

When the USB memory is inserted into the projector, the viewer memory function can project the video and pictures stored in the USB memory.

- 1) Press INPUT button on the control panel and on the top control panel and select the input source of [Memory Viewer].
- 2) Insert the USB memory into the <USB (browser) > terminal directly.
 - Press RC enter to display standby screen instantly, while the USB memory icon displays in the left corner of the screen.
 - When the USB memory is independent of the partition, it will display more than one USB icon.
- 3) Press ▲▼ button to switch required items.
 - The root directory of the USB memory is displayed in a thumbnail.

Play image

Only one image shows on the screen when you play it.

- 1) Press ◀▶ button to select a file.
- 2) Press <OK or ▶ > button.
 - Full screen display
- 3) Press <OK > button.
 - Press <OK> to return the thumbnail.

Useful function

Play slide

The Slide Show Mode in the Memory Viewer menu is set to a special setting ,all images in the same folder can play automatically.

- 1) Press ◀▶ button to select a file.
- 2) Press ▲▼ button to select [Memory Viewer] menu,then select [Start slide] menu.
- 3) Press <OK > button.
 - Full screen display
 - Press <OK> button to return the thumbnail.

Play video

Play video files.

- 1) Press ◀▶ button to select a file.
- 2) Press <OK> button.
 - Full screen display
 - Use the remote control to operate the controller that appears at the bottom of the screen.



	Stop playing the video and return to the thumbnail
	Pause / play the video
	Video fast forward / backward
	Video fast forward / backward at the twice speed.
	Each time press the icon , the box switches . When the box appears, the video can playback.

The termination of Memory Viewer

The Slide Show Mode in the Memory Viewer menu is set to a special setting ,all images in the same folder can play automatically.

- 1) Press ◀▶ button to select  ,displayed in the left corner of the screen.
- 2) Press <OK > button.
- 3) Unplug the USB memory directly.

Useful function



Note

- Only USB memory up to FAT32 (32GB) can be read.
- When you insert a USB memory, please make sure insertion direction to avoid damaging the port.
- Please note the following points when inserting and removing USB memory:
 - a. The indicator flashes, when the USB memory insert into the projector or the projector is reading data. DO NOT remove the USB memory When the light is flashing.
 - b. If you use a USB memory device without indicator, the projector will not recognize when reading data. Please close its browse function on and turn off the projector , then remove the USB memory.
 - c. Do not insert and remove USB memory frequently. Then remove it after the installation of at least 5 seconds. After removing at least 5 seconds and then reinsert it.

Precautions on processing and storage of USB memory

- If smoke or produce abnormal smell, close the external device and contact the dealer.
- DO NOT put foreign matter or metal items in the USB port. Static electricity may cause data loss or data damage.

USB display function

Select this function to can project the image and audio from the computer through the USB converter cable.

When using Windows:

■ Windows operating environment

Operating System	Win7, Win8.1, Win10
CPU	Intel Core 2 Duo 2.0 GHZ or faster compatible processors
Memory Capacity	256MB or above (512MB or above)
Disk Space Available	20MB or above
Monitor	Resolution 640x480 or above, 1600x1200 or above

Useful function

CAN NOT guarantee that the PC meeting the above conditions can operate normally .

Project USB display

- 1) Using USB-B cable to connect the projector to the USB display terminals.
- 2) Press the information source menu on the remote control or the INPUT button on the control panel, then select [USB display] in the input source menu.
- 3) Press the driver icon in the computer drive in the computer's task bar , then select one item in the pop-up menu bar.
 - Pop-up menu only display in English.

[Active audio] / [Disable audio]	Sets up the output from the computer's audio.
[Play video] / [Pause video]	Switch on playing and pausing images.
[Start / Stop]	Sets up the output from the computer's image.
[Exit]	Gray means not optional



NOTE

- Resolution of the computer screen will be switched.
- If the drive is not installed on the computer, the driver will be removed when the USB cable is disconnected .
- You need wait for a moment, if you want project computer screen.
- Connect the USB cable directly to the computer's USB connector. When connecting the USB hub, it may be abnormal.

The termination of USB display

- 1) Remove the USB cable directly, when terminate USB monitor.
 - You never need follow "Remove Hardware Safely, when USB cable is not connected.

Useful function

When using Mac OS

■ Mac OS operating environment

Operating System	Mac OS X v10.5 ~ 10.14
CPU	Power PC G4 1GHz or faster compatible processors
Memory Capacity	512MB or above
Disk Space Available	20MB or above
Monitor	Resolution 640x480 or above, 1600x1200 or above

CAN NOT guarantee that the PC meeting the above conditions can operate normally .

Project USB display

- 1) Using USB-B cable to connect the projector to the USB display terminals.
- 2) Press the information source menu on the remote control or the INPUT button on the control panel, then select [USB Monitor] in the input source menu.
- 3) Double-click "Monitor.app" button installed on the virtual disk.
 - Projecte image on the computer screen.
- 4) Press the driver icon in the computer drive in the computer's task bar , the select one item in the pop-up menu bar.
 - Pop-up menu only display in Chinese.

[Active audio] / [Disable audio]	Sets up the output from the computer's audio.
[Play video] / [Pause video]	Switch on playing and pausing images.
[Start / Stop]	Sets up the output from the computer's image.
[Exit]	Terminate USB Monitor



NOTE

- Resolution of the computer screen will be switched.
- You need wait for a moment,if you want project computer screen.
- Connect the USB cable directly to the computer's USB connector. When connecting the USB hub, it may be abnormal.

The termination of USB display

- 1) Remove the USB cable directly,when terminate USB display.

Maintenance and cleaning

WARNING light indicator

The WARNING light indicator shows status of projector protection function. Check warning and POWER light indicator for good maintenance operation.

The projector turns off and the WARNING indicator flashes red.

Your projector powers off automatically to protect components within it when it is overheated. The POWER indicator flashes when your projector is cooling down. Press the POWER button to power your projector on again when it is cooled down to normal operation temperature.

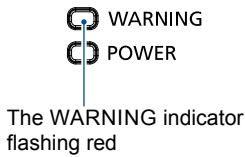

✓ Note:

The POWER indicator stops flashing when your projector's internal temperature cooled down to normal and it is powered on again.

Check the following:

- Is adequate clearance provided for your projector's ventilation? Check the installation status and any air outlet block.
- Is your projector installed at location close to outlet of air conditioning equipment? Keep your projector away from air outlet of air conditioning equipment.
- Is the filter in clean condition? Please clean the filter regularly.

The power is abnormal and the POWER indicator turns steady yellow.

The POWER indicator turns steady yellow and your projector powers off to protect its internal components whenever an abnormality is detected. Unplug the AC power cord and connect again. Restart your projector and run checkup routine. If the problem persists, unplug the AC power cord and call your service center for checkup and repair.

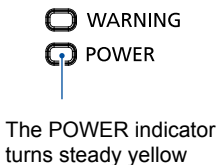

Maintenance and cleaning

Clean your projector when it is contaminated by foreign matter or its display effects are getting worse.



Note:

Please be sure to turn off the projector and let it cool down completely before cleaning.

Clean the lens

Blow away dust and dirt from the lens lightly with a blower. And wipe off the dirt with a soft cloth. Do not use cleaners that contain organic solvents.

Abrasive cleaner, solution, or other rough chemical may scratch the lens.

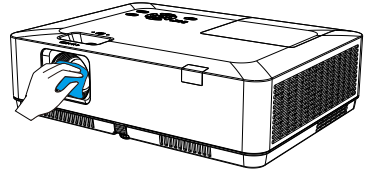

Clean casing of your projector

Wipe the casing surface with clean and soft cloth. Gently wipe the casing with clean and soft cloth dampened with small amount of neutral detergent to remove heavy dirt. Do not over apply cleaner to the casing. Abrasive cleaner, solution, or other rough chemical may scratch the casing surface.

Place your projector in proper container after use to protect it from dirt and dust and being scratched.

Do not use adhesives, lubricants, oils, or alkaline detergents for maintenance of the projector. They could adhere to the cabinet and damage it, possibly resulting in the projector falling from its mounting and causing an accident or personal injury.

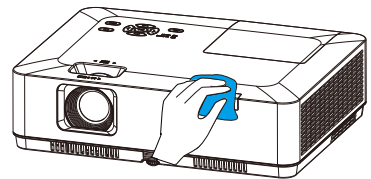

Clean the filter

The filter is designed to keep dust from entering in your projector. Clogged filter may reduce cooling fan effects, which, in turn, will overheat your projector and shorten its life cycle. Clean the filter immediately whenever the Filter Warning icon displays.

Please follow these steps to clean your filter:

1. Power off your projector and unplug from AC power source.
2. Remove the filter cover and remove the filter.
3. Gently clean it with a brush.
4. Install the fuzz side of the new filter toward the filter cover.
5. Install the filter cover and turn on the power supply.

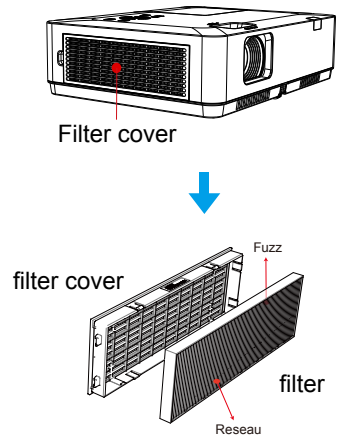

Reset the filter counter

- 1 Press MENU button and the OSD displays. Press ◀▶ button to select Setup menu, press ▶ button or OK.
- 2 Press ▲▼ button to select "Filter Counter", press ▶ button or OK. Press ▲▼ button to select "Reset the filter counter" and press OK. The "Reset filter counter?" message displays. Select Yes to proceed.
- 3 In another pop-up dialog box, select Yes to reset the filter counter.

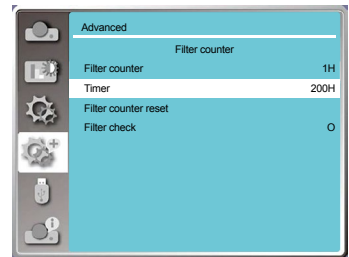

Recommendations

Please do not use your projector at place of dust and smoke. This may affects image quality. Using your projector in place of dust and smoke may lead to piling dusts on lens, LCD panel, and lens components within it. In case like this, call your dealer or service center for correct cleaning.



Note:

Reset the filter counter after its cleaning or replacement.



Note:

Do not operate your projector during its filter is removed. Dust may attach to the lens assembly and deteriorate image quality.

Do not insert any small object in the air outlet. It may fail your projector.

Lamp replacement

This projector uses the following lamps.
Replacement Lamp LV-LP43
Contact the Canon Customer Support Center when purchasing a replacement lamp.

The lamp warning icon displays when its usage time are more than the replacement period of the lamp minus 300H and less than the life of the projector.

The lamp replacement icon displays when its usage time are more than the replacement period of the lamp.

Lamp unit

Your projector's lamp is a consumable. You can confirm your usage time according to "Lamp counter" on the Info. menu in [Page 76](#). You'd better ask a professional technician to replace the lamp. Contact your dealer for help.
Please call your dealer to replace the lamp .

■ Caution

DO NOT replace the lamp when it is so hot .Make sure to replace it at least 1hour later after using it.
The lamp unit is getting hot in use. Take care, or you may get burned.

The lamp warning icon



The lamp replacement icon

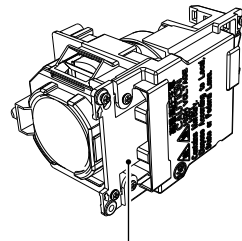
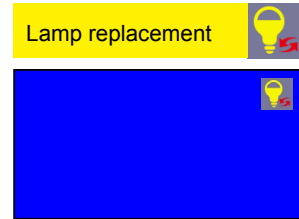

The lamp unit

Maintenance and cleaning



Precautions when replacing lamps that stop working

If the illumination suddenly stops when the projector is in use or after you turn it on, the lamp may be broken. In this case, never attempt to replace the lamp by yourself. Always request service from a qualified technician or the Canon Customer Support Center. Additionally, with ceiling-mounted projectors, the lamp may fall out when you open the lamp cover or while you are attempting to replace it. During replacement, make sure no one is under the projector, and stand to the side of the lamp cover, not directly under it.



Note:

Let your projector cool for at least 1 hour before opening the lamp cover, as temperature within your projector is high.



Note:

Replace the lamp with a new one of the same model only when it is necessary. Do not drop or touch the lamp! It may break and lead to personal injuries.

Follow steps below to replace the lamp:

1. Power off your projector and unplug the AC power cord. Let it cool down for at least 1 hour.
2. Open the lamp cover after removing screws holding the cover.
3. Loosen all 3 screws fixing the lamp. Remove the lamp by holding its handle.
4. Replace with a new lamp and tighten all 3 screws. Make sure the lamp has been installed correctly. Close the lamp cover and tighten the screw.
5. Connect your projector to an AC power source and power it on.

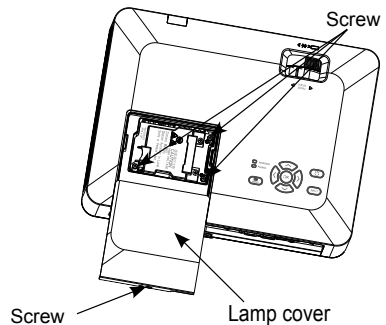

Precautions on lamp operation

Your projector employs high voltage lamp, which requires careful and correct operation. Failure to do so may lead to accidents, personal injuries, or fire.

- Useful life of lamps varies widely from lamp to lamp and depending on the environment of use. Some lamps may fail or rupture soon after they are first used.
- If your projector prompts you to replace lamp (by showing a lamp replacing icon) then replace it with a new one after powering it off and it is fully cooled down. (Please replace lamp by strictly following steps given in this manual.)
If you keep on using the lamp after being prompted to replace it then you are exposed to greater risks of lamp explosion.
- Lamp may explode due to external impact and shock. Risks of explosion vary with projector and use environment and status of the lamp.

In case of lamp explosion, take the following safety measures:

Disconnect your projector from power source immediately in case of lamp explosion. Call authorized service center to inspect your projector and replace lamp. Make a thorough inspection to ensure every piece of debris after explosion has been removed. Remove every piece of debris after explosion. No one else may inspect the internal of your projector except those authorized and well trained technician who also are familiar with its maintenance. Or we shall not be held liable for the consequences.

Troubleshooting

Check the following before calling your dealer or service center:

Troubleshooting	Solution
Power on failure	<ul style="list-style-type: none">– Plug the power cord of your projector in an AC socket.– Make sure the POWER indicator turns red.– Restart your projector until the POWER indicator turns red. It indicates your projector is ready for power on again.– Check the lamp.– Disable the Key Lock function of your projector.
Logo screen display failure	<ul style="list-style-type: none">– Make sure the Off and Countdown Off is selected in the Display function.
The Logo screen differs from the standard settings.	<ul style="list-style-type: none">– Make sure you did not select User or Off in the Logo Screen.
Input signal switch (or do not switch) automatically.	<ul style="list-style-type: none">– Make sure you have correctly set up the Input Search function.
Image looks fuzzy	<ul style="list-style-type: none">– Adjust focus of your projector.– Provide proper projection distance.– The projection lens requires cleaning.– Moving your projector from a colder environment to a hotter one may result in condensing on the lens. If this is the case, wait until the condensing water evaporated before powering on your projector.
Image mirror reflected	<ul style="list-style-type: none">– Check the Ceiling and Rear settings.
Image turns upside down	<ul style="list-style-type: none">– Check the Ceiling settings.
Image looks dim	<ul style="list-style-type: none">– Check for contrast and brightness settings.– Check for correct image mode settings– Check for lamp brightness settings.– Check for lamp replacement alert. The lamp replacement alert suggests the lamp is reaching the end of its life cycle. Please replace it with a new one of the same model immediately.

Appendix

No image displays	<ul style="list-style-type: none">– Check for the connection between your projector and computer or image equipment.– Check for correct input signal from computer. Connection with certain notebook computer may mandate changes to its display output settings. See the user manual included with the computer for details on settings.– It takes about 30 seconds for your projector to show the first image.– Check for mode of signal, color system, image system, or computer system.– Make sure the ambient temperature is within given range [0°C–40°C].– Image does not display in BLANK mode. Check the BLANK button or other buttons on the remote controller.
Abnormal color	<ul style="list-style-type: none">– Check for mode of signal, color system, image system, or computer system.– Make sure Blackboard mode is not selected in Image Select.
Auto PC Adjusting function failure	<ul style="list-style-type: none">– Check input signal. Auto PC adjustment function does not work when HDMI input. Auto PC Adjustment function may fail to work if you select the following system signal format: 720 x 480i, 720 x 576i, 720 x 480p, 720 x 576p, 1280 x 720p, 1920 x 1080i, 1920 x 1080p
Keystone settings do not save after power off	<ul style="list-style-type: none">– Make sure you have selected Store after Keystone settings adjustment. Keystone settings do not keep without selecting Store.
Power management failure	<ul style="list-style-type: none">– In case of Freeze or Blank operation, the power management function does not work.
Auto Setting does not work	<ul style="list-style-type: none">– Make sure it is not set to "Off" in each setup menu.– Make sure "On" is not set in Ceiling function.
Image distorted or disappeared	<ul style="list-style-type: none">– Check and revise the PC Adj. menu or Screen menu.
A password prompt displays after power on	<ul style="list-style-type: none">– You have set up the Logo Passcode lock function
Remote controller does not work	<ul style="list-style-type: none">– Check the battery.– Make sure there is no obstacles stand in between your projector and the remote controller.– Make sure the remote controller is not too far away from your projector. The maximum operation range is 8m.– Disable the key lock of the remote controller in the Setup menu.

Appendix

Light indicator turns on or flashes	– Check status of your projector according to the light indicator status.
"X " mark displays	– Invalid operation, please operate your projector correctly.
Control panel does not function	– Disable the key lock on control panel function in the Safety option of the Setup menu.

- Make sure your projector is correctly connected to external equipment.
- Make sure all devices have plugged in an AC power source and have been powered on.
- If your projector fails to project image of the connected computer, restart the computer.



Note:

Your projector employs high voltage power for operation. Do not open its casing. If the problem persists, call your dealer or service center. Along with model number of your projector and a description to your problem. You will be advised on getting our services.

Menu tree

Main menu	Sub-menu	Setting		Remarks
Display	Auto PC adj.			
	Fine sync	0-31		
	H Position	-5 - 5		
	V Position	-5 - +5		
	H Size	-15 - +15		The range of H Size differs from signals.
	Aspect	Auto*		
		16:9		
		Advanced	H Total V Total Position H Position V	
	Full			
	Image Flip H/V	None* Auto Ceiling Rear Auto Ceiling Rear Ceiling Ceiling mounted Rear		
Menu position	Upper Left* Upper Right Center Lower Left Lower Right			
Background display	Blue*/Black			
Signal Format	Auto*/PAL/SECAM/NTSC/NTSC4.43/ PAL-M//PAL-60/PAL-N/1080i/1035i/ 720p/480p/480i/576p/576i/ ----		Video Input	
Color adjust	Image mode	Standard* Presentation User Image Colorboard Blackboard (Green) Movie		
	Contrast	0-63		
	Brightness	0-63		
	Color temp	High/Middle/Low		PC/HDMI Input
	Color level	0-63		Video Input
	Color balance	0-63		Video Input
	Red	0-63		
	Green	0-63		
	Blue	0-63		
Sharpness	0-15			

* Indicates an item that is factory-set.

Appendix

Main menu	Sub-menu	Setting	Remarks	
Setting	Direct Power On	On/Off*		
	Standby Mode	Normal/Wake On Lan/ECO*		
	High altitude	On/Off*		
	Lamp control	💡* (Normal) / 💡 (ECO)		
	Cooling fast	Normal*/Immediate/60 Sec		
	Closed caption	Off*/CC1/CC2/CC3/CC4		
	Key lock	🔒*(Off) / 🖨️ (Projector)/ 🖱️ (Remote controller)		
	Iris	On*/Off		
	Sound	Volume	0-25	
		Mute	On/Off*	
	HDMI Setup	HDMI Input Range	Auto*/Full/Limited	
Sound		Audio I/F		
EQ Setting		HDMI* Mode1*/2/3/4		
Advanced	Language	26 languages		
	Auto Setup	Input Search	On*/Off	
		Auto PC Adj.	On*/Off	
		Auto Keystone	Off/AUTO*/Manual	
	Keystone	Keystone	Store*/Reset	
		H/V Keystone		
		Corner Correction		
		Curved correction		
	Logo	Reset value		
		Logo select	CANON(Default)*/ User/Off	
		Capture		
		Logo Passcode Lock	On/Off*	
	Security	Logo Passcode Change		
		Passcode lock	On/Off*	
	Power management	Passcode change		
		Ready*		
		Shut down		
		Disable		
	Filter counter	Timer	1-30 Min	
		Ready Countdown	0-30 Min	
		Filter counter		
		Timer	Off/300H*	
	Test pattern	Filter counter reset		
		Filter check	On*/Off	
		Off*		
		Gray scale (1-4) Color bar Red Green Blue Cross hatch White Black Raster gray		

* Indicates an item that is factory-set.

Appendix

Main menu	Sub-menu	Setting		Remarks	
Advanced	Network	Network setting	DHCP IP address Subnet Gateway DNS Set Cancel		
			Network information		
			MAC address		
		IP address			
	Factory default				
Lamp counter	Lamp counter Lamp counter reset				
Memory Viewer	Start slide				
	Slide transition effect	Slide right* Slide down			
	Sort order	Name order* Time order Size order Extend order			
	Rotate	No rotate* 270° rotate 180° rotate 90°rotate			
	Best fit	On/Off*			
	Repeat	On/Off*			
	Apply				
Info.	Input				
	H- sync. Freq.				
	V- sync. Freq.				
	Lamp status				
	Lamp counter				
	Power management				
	Image mode				

* Indicates an item that is factory-set.

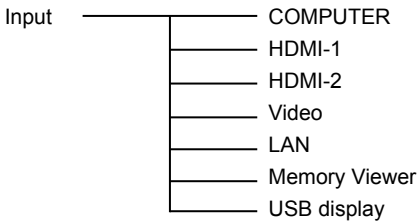

LED indicator status

Check light indicator to learn status of your projector.

Light indicator		Status of your projector
POWER	WARNING	
		Your projector is in Off status (without AC power supply).
		Your projector is in standby status. Press Standby button to turn it on.
		Your projector is in normal status.
		It is in ready status or the lamp is cooling.
		Your projector is in Ready mode.
		Your projector detects the temperature abnormality and switches into cooling mode.
		Your projector detects the temperature abnormality and switches into standby mode.
		Your projector detects the lamp abnormality and switches into cooling mode.
		Your projector detects the lamp abnormality and switches into standby mode.
		Your projector detects its usage time is more than or equal to the the replacement period of the lamp and less than 1.1 times of the replacement period of the lamp.
		Your projector detects its usage time ≥ 1.1 times the replacement period of the lamp.



... Green



... Red



... Yellow



... Turns off



... Flashing green



... Flashing red



... Flashing yellow

Supported Signal Types

Your projector is designed to accept every computer signal below Dot Clock 160MHz . See table below for details on resolution and relevant frequency.

序号	OSD Display	Input Source				Signal type/ resolution	Horizontal frequency [kHz]	Vertical frequency [Hz]	Dot clock (MHz)
		RGB	Component	HDMI	Video				
1	NTSC	--	--	--	○	NTSC	15.734	59.940	--
	NTSC-443	--	--	--	○	NTSC 4.43			
	PAL-60	--	--	--	○	PAL60			
	PAL-M	--	--	--	○	PAL-M			
2	PAL	--	--	--	○	PAL	15.625	50.000	--
	PAL-N	--	--	--	○	PAL-N			
	SECAM	--	--	--	○	SECAM			
3	720x480i 60Hz	○	○	--	--	720x480i	15.734	59.940	13.500
4	720x480i 60Hz	○	--	○	--	720 (1440) x480i	15.734	59.940	27.000
5	720x576i 50Hz	○	○	--	--	720x576i	15.625	50.000	13.500
6	720x576i 50Hz	--	--	○	--	720 (1440) x576i	15.625	50.000	27.000
7	720x483 60Hz	○	○	○	--	720x483(480P)	31.469	59.940	27.000
8	720x576 50Hz	○	○	○	--	720x576(576P)	31.250	50.000	27.000
9	1280x720p 60Hz	○	○	○	--	1280x720p	45.000	60.000	74.250
							44.955	59.940	74.176
10	1280x720p 50Hz	○	○	○	--		37.500	50.000	74.250
11	1920x1080i 60Hz	○	○	○	--	1920x1080i	33.750	60.000	74.250
							33.716	59.940	74.176
12	1920x1080i 50Hz	○	○	○	--		28.125	50.000	74.250
13	1920x1080p 24Hz	--	--	○	--	1920x1080p	27.000	24.000	74.250
							26.970	23.980	74.176
14	1920x1080p 60Hz	○	○	○	--		67.500	60.000	148.500
15	1920x1080p 50Hz	○	○	○	--	1920x1080p	67.433	59.940	148.352
							66.250	50.000	148.500
16	640x480 60Hz	○	--	○	--		31.469	59.940	25.175
17	640x480 67Hz	○	--	○	--		35.000	66.667	30.240
18	640x480 72Hz	○	--	○	--		37.861	72.809	31.500
19	640x480 75Hz	○	--	○	--		37.500	75.000	31.500
20	640x480 85Hz	○	--	○	--		43.269	85.008	36.000
21	800x600 56Hz	○	--	○	--		35.156	56.250	36.000
22	800x600 60Hz	○	--	○	--		37.879	60.317	40.000
23	800x600 72Hz	○	--	○	--		48.077	72.188	50.000
24	800x600 75Hz	○	--	○	--		46.875	75.000	49.500
25	800x600 85Hz	○	--	○	--		53.674	85.061	56.250
26	832x624 75Hz	○	--	○	--	832x624	49.725	74.550	57.283
27	1024x768 60Hz	○	--	○	--		48.363	60.004	65.000
28	1024x768 70Hz	○	--	○	--		56.476	70.069	75.000
29	1024x768 75Hz	○	--	○	--		60.023	75.029	78.750
30	1024x768 85Hz	○	--	○	--		68.678	84.997	94.500
31	1152x864 70Hz	○	--	○	--		63.995	70.020	94.200
32	1152x864 75Hz	○	--	○	--	1152x864	67.500	75.000	108.000
33	1280x720 60Hz	○	--	○	--	1280x720	44.772	59.855	74.500
34	1280x768 60Hz	○	--	○	--		47.776	59.870	79.500
35	1280x768 75Hz	○	--	○	--	1280x768	60.289	74.893	102.250
36	1280x768 85Hz	○	--	○	--		68.630	84.840	117.500
37	1280x800 60Hz	○	--	○	--		49.702	59.810	83.500
38	1280x800 75Hz	○	--	○	--	1280x800	62.795	74.934	106.500
39	1280x800 85Hz	○	--	○	--		71.554	84.880	122.500
40	1280x960 60Hz	○	--	○	--	1280x960	60.000	60.000	108.000
41	1280x1024 60Hz	○	--	○	--		63.981	60.020	108.000
42	1280x1024 72Hz	○	--	○	--		78.16	71.87	135.060
43	1280x1024 75Hz	○	--	○	--	1280x1024	79.976	75.025	135.000
44	1280x1024 85Hz	○	--	○	--		91.146	85.024	157.500
45	1366x768 60Hz	○	--	○	--	1366x768	47.720	59.799	84.750
46	1400x1050 60Hz	○	--	○	--	1400x1050	65.317	59.878	121.750
47	1400x1050 75Hz	○	--	○	--		82.278	74.867	156.000
48	1440x900 60Hz	○	--	○	--	1440x900	55.935	59.887	106.500
49	1600x900 60Hz	○	--	○	--	1600x900	55.920	60.000	118.998
50	1600x1200 60Hz	○	--	○	--	1600x1200	75.000	60.000	162.000
51	1680x1050 60Hz	○	--	○	--	1680x1050	65.290	59.954	146.250
52	1920x1080 60Hz	○	--	○	--	1920x1080	66.587	59.934	138.500
53	1920x1200 60Hz	○	--	○	--	1920x1200	74.038	59.950	154.000

“○” shows input signal source support this format ; “--” shows input signal source DONOT support.

✓ Note:
Changes to this manual may be made without notice.

Terminal configuration

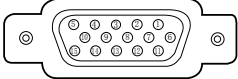
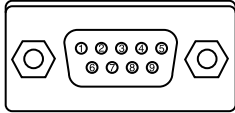
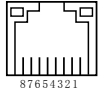
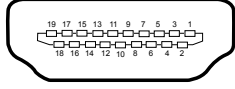
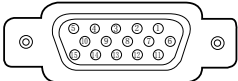
VGA IN / MONITOR OUT Terminal (D-sub 15)				
	1	Red (Input/output)	9	----
	2	Green(Input/output)	10	Grounding(field synchronizing)
	3	Blue(Input/output)	11	Grounding
	4	----	12	DDC data
	5	Grounding (line synchronizing)	13	Horizontal synchronizing(compound sync.) input/output
	6	Grounding(red)	14	Vertical synchronizing input/output
	7	Grounding(green)	15	DDC Clock
	8	Grounding(blue)		
SERIAL Terminal(D-SUB 9)				
	1	----	6	----
	2	RXD	7	----
	3	TXD	8	----
	4	----	9	----
	5	GND		
LAN Terminal				
 87654321	1	TX +	5	----
	2	TX -	6	RX -
	3	RX +	7	----
	4	----	8	----
HDMI Terminal (HDMI Type A 19)				
	1	TMDS Data2+	11	TMDS Clock Shield
	2	TMDS Date2 Shield	12	TMDS Clock-
	3	TMDS Date2-	13	CEC
	4	TMDS Date1+	14	Reserved(N.C. on device)
	5	TMDS Date1 Shield	15	SCL
	6	TMDS Date1-	16	SDA
	7	TMDS Date0+	17	DDC/CEC Ground
	8	TMDS Date0 Shield	18	+5V Power
	9	TMDS Date0-	19	Hot Plug Detect
	10	TMDS Clock+		
VGA IN 1 Terminal				
	1	Red/Pr/S-C input	9	----
	2	Green/Y/S-Y input	10	Grounding(field synchronizing)
	3	B/Pb/- input	11	Grounding
	4	----	12	DDC data
	5	Grounding(line synchronizing)	13	Horizontal synchronizing (compound sync.)input
	6	Grounding(red)	14	Vertical synchronizing input
	7	Grounding(green)	15	DDC clock
	8	Grounding(blue)		

Appendix

Dimensions



Support frame for Ceiling Mount
Screw: M4
Depth: 10.0

Unit: mm

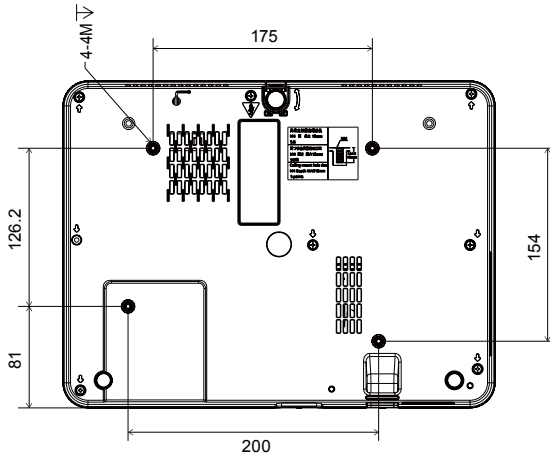
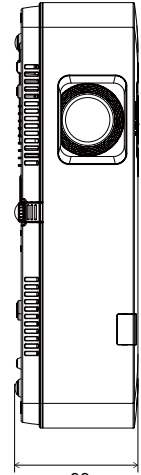
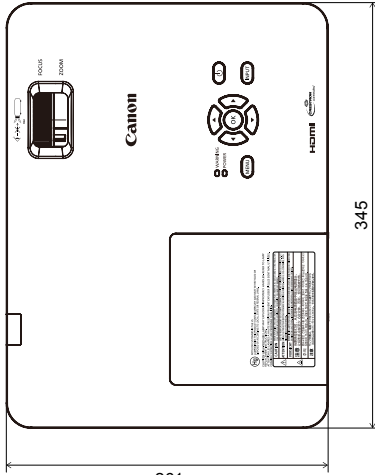
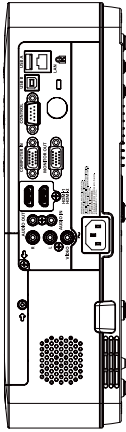
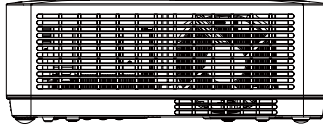

Appendix

Specifications

Model name	LV-WU360	LV-WX370	LV-X350
Display system	Transmitting LCD : 3 panels		
Optical system	Three primary color liquid crystal shutter projection method		
Display device			
Effective display area size	0.64"/16: 10	0.59"/16: 10	0.63"x3/4: 3
Effective number of pixels	2,304,000 (1920x1200)x3	1,024,000 (1280x800)x3	786,432 (1024x768)x3
Projection lens			
Zoom	1.2x (Manual)		
Focus	Manual		
Focal length	f=19.2~23.0mm		
F number	F:1.6~1.76		
Light source(Normal/Eco)	High pressure mercury lamp 225W/150W		
Image size / Projection distance	30~300inch / 0.87~10.74m	30~300inch / 0.94~11.60m	30~300inch / 0.89~10.94m
Number of colors	1,073,000,000 colors		
Light output(*1)(*2)	3600lm	3700lm	3500lm
Contrast ratio(*1)(*2)(*3)	15000: 1		
Ratio of brightness at periphery to center(*2)	80%		
Speaker	10W		
Supported input signal types	See "Supported Signal Types"(P108)		
Displayable scanning frequency			
Horizontal	15 kHz~100 KHz		
Vertical	28Hz~85 Hz		
Display resolution			
Computer signal input	Maximum input resolution 1920x1200 dots	Maximum input resolution 1920x1200 dots(resizing display) Panel display resolution 1280 x 800 dots	Maximum input resolution 1920x1200 dots(resizing display) Panel display resolution 1024 x 768 dots
Video signal input	NTSC, NTSC4.43, PAL, SECAM, PAL-M, PAL-N,		
Video signals			
Mini D-sub 15-pin	Analog PC (WUXGA/FHD/UXGA/WSXGA+/SXGA+/SXGA/WXGA+/WXGA/XGA/SVGA/VGA/Mac16 ") Component video(1080p/1080i/720p/576p/576i/480p/480i)		
HDMIx2	Digital PC (WUXGA/FHD/UXGA/WSXGA+/SXGA+/SXGA/WXGA+/WXGA/XGA/SVGA/VGA/Mac16 ") Digital Video (1080p/1080i/720p/576p/576i/480p/480i)		
RCA	Video input		
RJ-45	Network connection(100 Base-TX (100Mbps)/10 Base-T (10Mbps)、 Network Display)		
USB Type B	USB connection(USB Display、 Service Port)		
USB Type A	USB connection(USB Memory Viewer)		
Other terminals and connectors			
Dsub 9	RS-232 connection		
Mini D-sub 15-pin	Analog PC/Component video output		
Mini jack	Audio input		
Mini jack	Audio output		
2RCA	Audio input		
Noise (Normal/Eco)	37dB / 30dB		
Operating temperature	0°C ~40°C		

Appendix

Model name	LV-WU360	LV-WX370	LV-X350
Power supply	AC 100-240V 50/60Hz		
Maximum power consumption (Normal/Eco)	320W/224W	310W/217W	
Standby mode power consumption(LAN OFF/ON)	0.4W / 2W		
Dimensions Not including protrusion	W345mm×H261mm×D99mm W345mm×H261mm×D94mm		
Weight	Approx. 3.3kg	Approx. 3.2kg	Approx. 3.2kg
Accessories	Remote control, remote control dry-cell batteries, power cord, Computer cable, Important Information and Warranty Card		

(*1)Lamp: Normal、Image mode: Presentation

(*2) Compliance with ISO21118-2012

(*3)Iris:ON

- ※ 99.99% or more of the LCD panel pixels are effective. During projection, 0.01% or less of pixels may stay lit or unlit due to the characteristics of the LCD panel.
- ※ Using the projector continuously for an extended period of time may accelerate the deterioration of optical parts.
- ※ Product specifications and appearance are subject to change without prior notice.

Remote control

Battery	AAA ALKALINE TYPE x 2
Operating Range	±30° about 8 m straight
Dimensions	110mm(L)X50mm(W)X20mm(H)
Net Weight	38g

RS232 control mode

Serial connection

1.1 Port setting

Project	Setpoint
Communication method	Asynchronous communication
Communication rate	19200
Length	8-bit
Parity check	NO
Stop position	1
Flow control	NO

1.2 Connection mode

Can only use RS232 serial cross connect PC and projector.

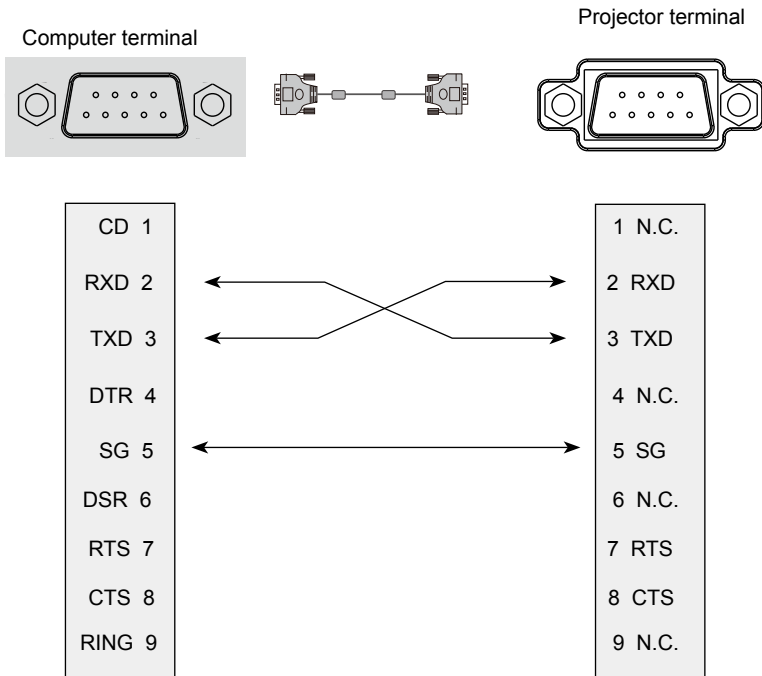

Appendix

User commands

Commands		ASCII representation	Binary representation
Power supply	Power on	POWER=ON<CR>	50h 4Fh 57h 45h 52h 3Dh 4Fh 4Eh 0Dh
	Power off	POWER=OFF<CR>	50h 4Fh 57h 45h 52h 3Dh 4Fh 46h 46h 0Dh
Power status acquisition		GET=POWER<CR>	47h 45h 54h 3Dh 50h 4Fh 57h 45h 52h 0Dh
Input source	Computer	INPUT=DSUB<CR>	49h 4Eh 50h 55h 54h 3Dh 44h 53h 55h 42h 0Dh
	HDMI-1	INPUT=HDMI1<CR>	49h 4Eh 50h 55h 54h 3Dh 48h 44h 4Dh 49h 31h 0Dh
	HDMI-2	INPUT=HDMI2<CR>	49h 4Eh 50h 55h 54h 3Dh 48h 44h 4Dh 49h 32h 0Dh
	Video	INPUT=VIDEO<CR>	49h 4Eh 50h 55h 54h 3Dh 56h 49h 44h 45h 4Fh 0Dh
	LAN	INPUT=LAN<CR>	49h 4Eh 50h 55h 54h 3Dh 4Ch 41h 4Eh 0Dh
	USB-MEM	INPUT=USB_M<CR>	49h 4Eh 50h 55h 54h 3Dh 55h 53h 42h 5Fh 4Dh 0Dh
	USB-Display	INPUT=USB_D<CR>	49h 4Eh 50h 55h 54h 3Dh 55h 53h 42h 5Fh 44h 0Dh
Input source acquisition		GET=INPUT<CR>	47h 45h 54h 3Dh 49h 4Eh 50h 55h 54h 0Dh
Input list acquisition		GET=INPUTL<CR>	47h 45h 54h 3Dh 49h 4Eh 50h 55h 54h 4Ch 0Dh
Image mode	Standard	IMAGE=STANDARD<CR>	49h 4Dh 41h 47h 45h 3Dh 53h 54h 41h 4Eh 44h 41h 52h 44h 0Dh
	Presentation	IMAGE=PRESENTATION<CR>	49h 4Dh 41h 47h 45h 3Dh 50h 52h 45h 53h 45h 4Eh 54h 41h 54h 49h 4Fh 4Eh 0Dh
	Cinema	IMAGE=MOVIE<CR>	49h 4Dh 41h 47h 45h 3Dh 4Dh 4Fh 56h 49h 45h 0Dh
	User 1	IMAGE=USER_1<CR>	49h 4Dh 41h 47h 45h 3Dh 55h 53h 45h 52h 5Fh 31h 0Dh
	Black board	IMAGE=BLACKBD<CR>	49h 4Dh 41h 47h 45h 3Dh 42h 4Ch 41h 43h 4Bh 42h 44h 0Dh
	Color board	IMAGE=COLORBD<CR>	49 4D 41 47 45 3D 43 4F 4C 4F 52 42 44 0D
Image mode acquisition		GET=IMAGE<CR>	47h 45h 54h 3Dh 49h 4Dh 41h 47h 45h 0Dh
Aspect	Auto	ASPECT=AUTO<CR>	41h 53h 50h 45h 43h 54h 3Dh 41h 55h 54h 4Fh 0Dh
	16:9	ASPECT=16:9<CR>	41h 53h 50h 45h 43h 54h 3Dh 31h 36h 3Ah 39h 0Dh
	CUSTOM	ASPECT=CUSTOM<CR>	41h 53h 50h 45h 43h 54h 3Dh 43h 55h 53h 54h 4Fh 4Dh 0Dh
	Full	ASPECT=Full<CR>	41h 53h 50h 45h 43h 54h 3Dh 46h 75h 6Ch 6Ch 0Dh
Aspect value acquisition		GET=ASPECT<CR>	47h 45h 54h 3Dh 41h 53h 50h 45h 43h 54h 0Dh

Appendix

Commands		ASCII representation	Binary representation
Lamp mode	Full power	LIGHT=NORMAL<CR>	4Ch 49h 47h 48h 54h 3Dh 4Eh 4Fh 52h 4Dh 41h 4Ch 0Dh
	Power saver 1	LIGHT=ECO<CR>	4Ch 49h 47h 48h 54h 3Dh 45h 43h 4Fh 0Dh
Lamp mode value acquisition		GET=LIGHT<CR>	47h 45h 54h 3Dh 4Ch 49h 47h 48h 54h 0Dh
Projector usage time acquisition		GET=PJUSGT<CR>	47h 45h 54h 3Dh 50h 4Ah 55h 53h 47h 54h 0Dh
Lamp usage time acquisition		GET=LMPT<CR>	47h 45h 54h 3Dh 4Ch 4Dh 50h 54h 0Dh
Blank	Blank On	BLANK=ON<CR>	42h 4Ch 41h 4Eh 4Bh 3Dh 4Fh 4Eh 0Dh
	Blank Off	BLANK=OFF<CR>	42h 4Ch 41h 4Eh 4Bh 3Dh 4Fh 46h 46h 0Dh
Blank acquisition		GET=BLANK<CR>	47h 45h 54h 3Dh 42h 4Ch 41h 4Eh 4Bh 0Dh
Audio mute	Mute On	MUTE=ON<CR>	4Dh 55h 54h 45h 3Dh 4Fh 4Eh 0Dh
	Mute Off	MUTE=OFF<CR>	4Dh 55h 54h 45h 3Dh 4Fh 46h 46h 0Dh
Audio mute status acquisition		GET=MUTE<CR>	47h 45h 54h 3Dh 4Dh 55h 54h 45h 0Dh
Auto input search On		QAS=ON<CR>	51h 41h 53h 3Dh 4Fh 4Eh 0Dh
Auto input search Off		QAS=OFF<CR>	51h 41h 53h 3Dh 4Fh 46h 46h 0Dh
Auto input search acquisition		GET=QAS<CR>	47h 45h 54h 3Dh 51h 41h 53h 0Dh
Freeze	Freeze On	FREEZE=ON<CR>	46h 52h 45h 45h 5Ah 45h 3Dh 4Fh 4Eh 0Dh
	Freeze Off	FREEZE=OFF<CR>	46h 52h 45h 45h 5Ah 45h 3Dh 4Fh 46h 46h 0Dh
Freeze acquisition		GET=FREEZE<CR>	47h 45h 54h 3Dh 46h 52h 45h 45h 5Ah 45h 0Dh
Product code acquisition		GET=PRODCODE<CR>	47h 45h 54h 3Dh 50h 52h 4Fh 44h 43h 4Fh 44h 45h 0Dh
Serial number acquisition		GET=PRODSN<CR>	47h 45h 54h 3Dh 50h 52h 4Fh 44h 53h 4Eh 0Dh
High land mode	High land mode On	HIGHALT=ON<CR>	48h 49h 47h 48h 41h 4Ch 54h 3Dh 4Fh 4Eh 0Dh
	High land mode Off	HIGHALT=OFF<CR>	48h 49h 47h 48h 41h 4Ch 54h 3Dh 4Fh 46h 46h 0Dh
High land mode acquisition		GET=HIGHALT<CR>	47h 45h 54h 3Dh 48h 49h 47h 48h 41h 4Ch 54h 0Dh
Image Flip	Image flip Normal	IMAGEFLIP=NONE<CR>	49h 4Dh 41h 47h 45h 46h 4Ch 49h 50h 3Dh 4Eh 4Fh 4Eh 45h 0Dh
	Image flip Rear	IMAGEFLIP=REAR<CR>	49h 4Dh 41h 47h 45h 46h 4Ch 49h 50h 3Dh 52h 45h 41h 52h 0Dh
	Image flip Ceiling	IMAGEFLIP=CEILING<CR>	49h 4Dh 41h 47h 45h 46h 4Ch 49h 50h 3Dh 43h 45h 49h 4Ch 49h 4Eh 47h 0Dh
	Image flip Rear Ceiling	IMAGEFLIP=REAR_CEIL<CR>	49h 4Dh 41h 47h 45h 46h 4Ch 49h 50h 3Dh 52h 45h 41h 52h 5Fh 43h 45h 49h 4Ch 0Dh
	Image flip Auto Ceiling	IMAGEFLIP=AUTO_CEILING<CR>	49h 4Dh 41h 47h 45h 46h 4Ch 49h 50h 3Dh 41h 55h 54h 4Fh 5Fh 43h 45h 49h 4Ch 49h 4Eh 47h 0Dh
	Image flip Auto Rear Ceiling	IMAGEFLIP=AUTO_REAR_CEIL<CR>	49h 4Dh 41h 47h 45h 46h 4Ch 49h 50h 3Dh 41h 55h 54h 4Fh 5Fh 52h 45h 41h 52h 5Fh 43h 45h 49h 4Ch 0Dh
Image flip status acquisition		GET=IMAGEFLIP<CR>	47h 45h 54h 3Dh 49h 4Dh 41h 47h 45h 46h 4Ch 49h 50h 0Dh



CANON INC.

30-2, Shimomaruko 3-chome, Ohta-ku, Tokyo 146-8501, Japan

CANON U.S.A. INC.

One Canon Park, Melville, New York 11747, U.S.A.

For all inquires concerning this product, call toll free in the U.S. 1-800-OK-CANON

CANON EUROPE LTD.

3 The Square, Stockley Park, Uxbridge, Middlesex, UB11 1ET United Kingdom

CANON EUROPA N.V.

Bovenkerkerweg 59, 1185 XB Amstelveen, The Netherlands