

# User's Manual

**Qosmio G40**

**TOSHIBA**

Leading Innovation >>>

## Copyright

© 2007 by TOSHIBA Corporation. All rights reserved. Under the copyright laws, this manual cannot be reproduced in any form without the prior written permission of TOSHIBA. No patent liability is assumed, with respect to the use of the information contained herein.

*TOSHIBA Qosmio G40 Portable Personal Computer User's Manual*

First edition May 2007

Copyright authority for music, movies, computer programs, databases and other intellectual property covered by copyright laws belongs to the author or to the copyright owner. Copyrighted material can be reproduced only for personal use or use within the home. Any other use beyond that stipulated above (including conversion to digital format, alteration, transfer of copied material and distribution on a network) without the permission of the copyright owner is a violation of copyright or author's rights and is subject to civil damages or criminal action. Please comply with copyright laws in making any reproduction from this manual.

Please note that you may infringe the owner's rights protected by the copyright laws if you use the screen mode switching functions (e.g. Wide mode, Wide Zoom mode, etc.) of this product to display enlarged images/video at coffee shops or hotels for the purposes of profits or providing these to the public.

## Disclaimer

This manual has been validated and reviewed for accuracy. The instructions and descriptions it contains are accurate for the TOSHIBA Qosmio G40 Portable Personal Computer at the time of this manual's production. However, succeeding computers and manuals are subject to change without notice. TOSHIBA assumes no liability for damages incurred directly or indirectly from errors, omissions or discrepancies between the computer and the manual.

## Trademarks

IBM is a registered trademark and IBM PC is a trademark of International Business Machines Corporation.

Intel, Intel SpeedStep, Intel Core, Celeron and Centrino are trademarks or registered trademarks of Intel Corporation.

Windows and Microsoft are registered trademarks and Windows Vista is a trademark of Microsoft Corporation.

Photo CD is a trademark of Eastman Kodak.

Bluetooth is a trademark or registered trademark owned by its proprietor and used by TOSHIBA under license.

Memory Stick is a registered trademark and i.LINK is a trademark of Sony Corporation.

DVD MovieFactory is a registered trademarks of Ulead Systems, Inc.

Manufactured under license from Dolby Laboratories.

"Dolby" and the double-D symbol are trademarks of Dolby Laboratories. Confidential unpublished works. Copyright 1992-1997 Dolby Laboratories. All rights reserved.

EdgeMotion, PalmCheck, TouchPad and Synaptics are trademarks or registered trademarks of Synaptics Incorporated.

Other trademarks and registered trademarks not listed above may be used in this manual.

## Macrovision License

This product includes copyright protection technology and intellectual property that are patented in the U.S. and other countries. These patents are the property of Macrovision Corporation. The use of copyright protection must be authorized by Macrovision Corporation. It is intended for home and other restricted-use applications, unless Macrovision Corporation expressly authorizes otherwise. All forms of reverse engineering or decompiling are forbidden.

## EU Declaration of Conformity



This product is carrying the CE-Mark in accordance with the related European Directives. The party responsible for CE-Marking is TOSHIBA Europe GmbH, Hammfelddamm 8, 41460 Neuss, Germany.

The complete and official EU Declaration of Conformity can be found on TOSHIBA's web site <http://epps.toshiba-teg.com> on the Internet.

## GOST

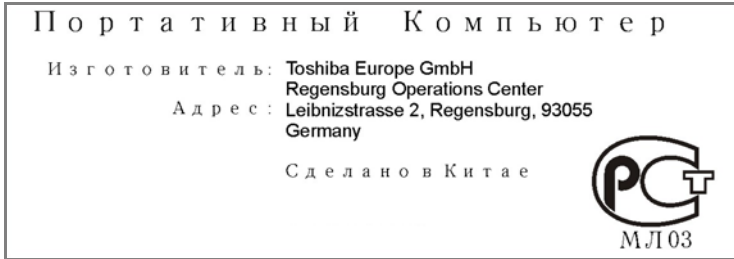

## Important Safety Information for Computers with TV tuner

IEC60950-1/EN60950-1 Information technology equipment - Safety -  
Coaxial cable connection to this computer must only be used if the cable outer conductive shielding has been grounded by the cable installer at the building premises as close to the point of cable entrance, or attachment, as practicable and the connection complies with all local cable installation requirements that are applicable in your area.

## Modem warning notice

### Conformity Statement

The equipment has been approved to [Commission Decision “CTR21”] for pan-European single terminal connection to the Public Switched Telephone Network (PSTN).

However, due to differences between the individual PSTNs provided in different countries/regions the approval does not, of itself, give an unconditional assurance of successful operation on every PSTN network termination point.

In the event of problems, you should contact your equipment supplier in the first instance.

## Network Compatibility Statement

This product is designed to work with, and is compatible with the following networks. It has been tested to and found to conform with the additional requirements conditional in EG 201 121.

|                             |   |
|-----------------------------|---|
| Germany                     | ATAAB AN005,AN006,AN007,AN009,AN010 and DE03,04,05,08,09,12,14,17 |
| Greece                      | ATAAB AN005,AN006 and GR01,02,03,04                               |
| Portugal                    | ATAAB AN001,005,006,007,011 and P03,04,08,10                      |
| Spain                       | ATAAB AN005,007,012, and ES01                                     |
| Switzerland                 | ATAAB AN002   |
| All other countries/regions | ATAAB AN003,004   |

Specific switch settings or software setup is required for each network, please refer to the relevant sections of the user guide for more details.

The hookflash (timed break register recall) function is subject to separate national type approvals. It has not been tested for conformity to national type regulations, and no guarantee of successful operation of that specific function on specific national networks can be given.

### Following information is only for EU-member states:



The use of the symbol indicates that this product may not be treated as household waste. By ensuring this product is disposed of correctly, you will help prevent potential negative consequences for the environment and human health, which could otherwise be caused by inappropriate waste handling of this product. For more detailed information about recycling of this product, please contact your local city office, your household waste disposal service or the shop where you purchased the product.



*This symbol may not stick depending on the country and region where you purchased.*

## Optical disc drive safety instructions



Be sure to check the international precautions at the end of this section.

### TOSHIBA

#### HD DVD-ROM drive TS-L802A



- The HD DVD-ROM drive employs a laser system. To ensure proper use of this product, please read this instruction manual carefully and retain for future reference. Should the unit ever require maintenance, contact an authorized service location.
- Use of controls, adjustments or the performance of procedures other than those specified may result in hazardous radiation exposure.
- To prevent direct exposure to the laser beam, do not try to open the enclosure.

#### Location of the required label

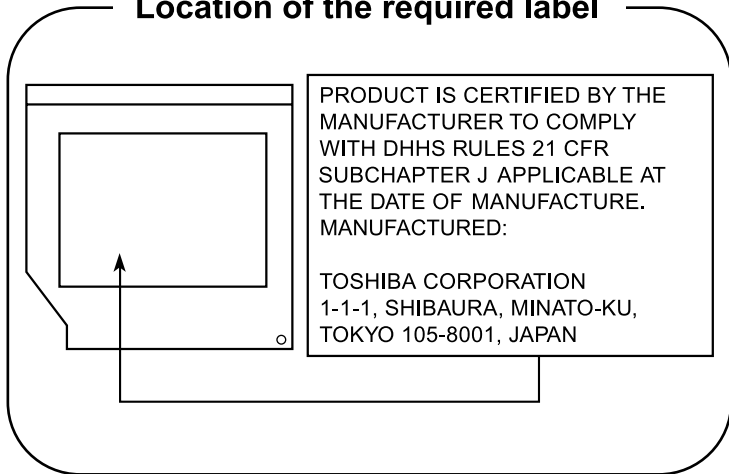

## TOSHIBA

### HD DVD-R drive SD-L902A



- *The HD DVD-R drive employs a laser system. To ensure proper use of this product, please read this instruction manual carefully and retain for future reference. Should the unit ever require maintenance, contact an authorized service location.*
- *Use of controls, adjustments or the performance of procedures other than those specified may result in hazardous radiation exposure.*
- *To prevent direct exposure to the laser beam, do not try to open the enclosure.*

### Location of the required label

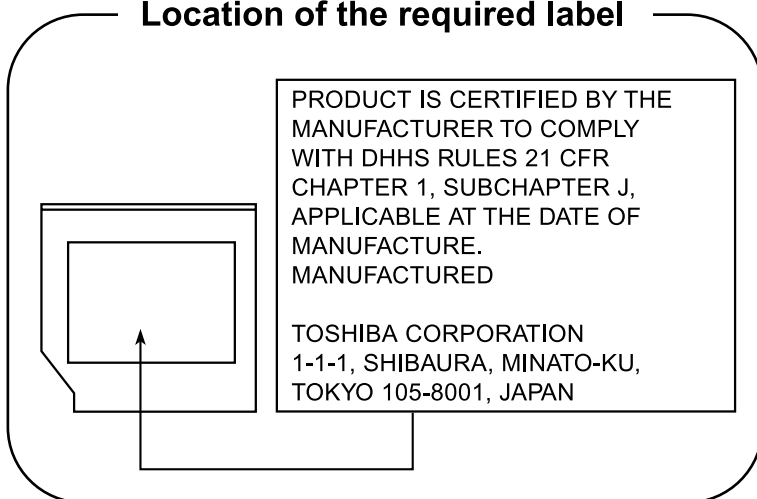

## International precautions

|  |
|--|
| CLASS 1 LASER PRODUCT<br>LASER KLASSE 1 PRODUKT<br>TO EN 60825-1<br>クラス1レーザー製品 |
|--|

**CAUTION:** *This appliance contains a laser system and is classified as a “CLASS 1 LASER PRODUCT.” To use this model properly, read the instruction manual carefully and keep this manual for your future reference. In case of any trouble with this model, please contact your nearest “AUTHORIZED service station.” To prevent direct exposure to the laser beam, do not try to open the enclosure.*

**CAUTION:** *USE OF CONTROLS OR ADJUSTMENTS OR PERFORMANCE OF PROCEDURES OTHER THAN THOSE SPECIFIED IN THE OWNER'S MANUAL MAY RESULT IN HAZARDOUS RADIATION EXPOSURE.*



# Table of Contents

## Preface

## General Precautions

### Chapter 1 Introduction

|                                       |      |
|---------------------------------------|------|
| Equipment checklist . . . . .         | 1-1  |
| Hardware . . . . .                    | 1-3  |
| Special features . . . . .            | 1-12 |
| TOSHIBA Value Added Package . . . . . | 1-14 |
| Utilities and Applications . . . . .  | 1-15 |
| Options . . . . .                     | 1-17 |

### Chapter 2 The Grand Tour

|   |      |
|---|------|
| Front with the display closed . . . . . | 2-1  |
| Left side . . . . .                     | 2-2  |
| Right side . . . . .                    | 2-4  |
| Back . . . . .                          | 2-6  |
| Underside . . . . .                     | 2-8  |
| Front with the display open . . . . .   | 2-9  |
| System indicators . . . . .             | 2-12 |
| Optical disc drives . . . . .           | 2-15 |
| AC adaptor . . . . .                    | 2-18 |

### Chapter 3 Getting Started

|  |      |
|--|------|
| Connecting the AC adaptor . . . . .      | 3-2  |
| Opening the display . . . . .            | 3-4  |
| Turning on the power . . . . .           | 3-5  |
| Starting up for the first time . . . . . | 3-5  |
| Turning off the power . . . . .          | 3-6  |
| Restarting the computer . . . . .        | 3-9  |
| System Recovery Options . . . . .        | 3-10 |

*Chapter 4* **Operating Basics**

Using the Touch Pad ..... 4-1

AV Controller ..... 4-2

Using the Fingerprint Sensor ..... 4-3

Web Camera ..... 4-11

Using HD DVD-ROM drive and HD DVD-R drives ..... 4-12

HD DVD ..... 4-16

Writing CD/DVD/HD DVDs on HD DVD-R drives ..... 4-17

Media care..... 4-27

TV Tuner ..... 4-28

Sound system..... 4-30

Modem..... 4-32

Wireless communications..... 4-36

LAN ..... 4-40

Cleaning the computer ..... 4-42

Moving the computer..... 4-42

*Chapter 5* **The Keyboard**

Typewriter keys ..... 5-1

Function keys: F1 ... F12 ..... 5-2

Soft keys: FN key combinations..... 5-2

Hot keys ..... 5-3

Windows special keys ..... 5-5

Keypad overlay..... 5-6

Generating ASCII characters..... 5-7

*Chapter 6* **Power**

Power conditions ..... 6-1

Power indicators ..... 6-2

Battery types..... 6-4

Care and use of the battery pack ..... 6-6

Replacing the battery pack ..... 6-11

TOSHIBA Password Utility ..... 6-13

Starting the computer by password ..... 6-14

Power-up modes ..... 6-15

Panel power on/off ..... 6-16

System Auto Off ..... 6-16

*Chapter 7* **HW Setup & BIOS Setup**

Accessing HW Setup ..... 7-1

HW Setup window ..... 7-1

BIOS Setup Program ..... 7-7

|                   |  |       |
|-------------------|--|-------|
| <i>Chapter 8</i>  | <b>AV functions</b>  |       |
|                   | Media Center . . . . .   | 8-1   |
|                   | Front operation panel . . . . .  | 8-2   |
|                   | Qosmio AV Controller . . . . .   | 8-4   |
|                   | Remote Controller . . . . .  | 8-5   |
|                   | Using the Remote Controller . . . . .  | 8-9   |
|                   | Installing/Removing batteries . . . . .  | 8-10  |
|                   | Set-top box Connection Method and Watching TV on<br>the Media Center . . . . . | 8-12  |
|                   | Connecting the Video devices . . . . .   | 8-15  |
| <i>Chapter 9</i>  | <b>Optional Devices</b>  |       |
|                   | PC Card . . . . .  | 9-2   |
|                   | ExpressCard . . . . .  | 9-4   |
|                   | Bridge media slot . . . . .  | 9-6   |
|                   | Memory expansion . . . . .   | 9-11  |
|                   | Battery Packs . . . . .  | 9-15  |
|                   | Universal AC Adaptor . . . . .   | 9-15  |
|                   | Battery Charger . . . . .  | 9-16  |
|                   | USB floppy disk drive . . . . .  | 9-16  |
|                   | External monitor . . . . .   | 9-18  |
|                   | TV . . . . .   | 9-19  |
|                   | HDMI . . . . .   | 9-21  |
|                   | S-Video-in . . . . .   | 9-22  |
|                   | i.LINK (IEEE1394) . . . . .  | 9-23  |
|                   | Security lock . . . . .  | 9-25  |
| <i>Chapter 10</i> | <b>Troubleshooting</b>   |       |
|                   | Problem solving process . . . . .  | 10-1  |
|                   | Hardware and system checklist . . . . .  | 10-3  |
|                   | TOSHIBA support . . . . .  | 10-26 |
| <i>Chapter 11</i> | <b>Legal Footnotes</b>   |       |
| <i>Appendix A</i> | <b>Specifications</b>  |       |
|                   | Physical Dimensions . . . . .  | A-1   |
| <i>Appendix B</i> | <b>Display Controller and Video modes</b>                                      |       |
|                   | Display controller . . . . .   | B-1   |
|                   | Video modes . . . . .  | B-1   |
| <i>Appendix C</i> | <b>Wireless LAN</b>  |       |
|                   | Card Specifications . . . . .  | C-1   |
|                   | Radio Characteristics . . . . .  | C-1   |
|                   | Supported Frequency Sub-bands . . . . .  | C-2   |
| <i>Appendix D</i> | <b>Bluetooth wireless technology Interoperability</b>                          |       |
|                   | Bluetooth wireless technology and your Health . . . . .                        | D-2   |
|                   | Regulatory statements . . . . .  | D-2   |

*Appendix E* **AC Power Cord and Connectors**  
**Certification agencies** ..... **E-1**

*Appendix F* **Usage Restrictions**

*Appendix G* **If your computer is stolen**

**Glossary**

**Index**

# Preface

Congratulations on your purchase of the Qosmio G40 series computer. This powerful notebook computer provides excellent expansion capability, includes multimedia functionality, and is designed to provide years of reliable, high-performance computing.

This computer family includes a model with a built-in TV tuner. When you wish to display a TV program or play CD/DVD with this model before Windows starts, touch the TV panel or the CD/DVD panel (or the same panels on the remote control) respectively during Windows startup. When Windows is running, you can display or record a TV program using the My TV feature of Media Center.

This manual tells how to set up and begin using your Qosmio G40 computer. It also provides detailed information on configuring your computer, basic operations and care, using optional devices and troubleshooting.

If you are a new user of computers or if you're new to portable computing, first read over the *Introduction* and *The Grand Tour* chapters to familiarize yourself with the computer's features, components and accessory devices. Then read *Getting Started* for step-by-step instructions on setting up your computer.

If you are an experienced computer user, please continue reading the preface to learn how this manual is organized, then become acquainted with this manual by browsing through its pages. Be sure to read the *Special features* section of the Introduction, to learn about features that are uncommon or unique to this computer, as well as the section on *HW Setup & BIOS Setup*, to understand how to setup and configure these features.

If you are going to install PC Cards or connect external devices such as a monitor, be sure to read Chapter 9, *Optional Devices*.

## Conventions

This manual uses the following formats to describe, identify, and highlight terms and operating procedures.

### Abbreviations

On first appearance, and whenever necessary for clarity, abbreviations are enclosed in parentheses following their definition. For example: Read Only Memory (ROM). Acronyms are also defined in the Glossary.

### Icons

Icons identify ports, dials, and other parts of your computer. The indicator panel also uses icons to identify the components it is providing information on.

### Keys

The keyboard keys are used in the text to describe many computer operations. A distinctive typeface identifies the key top symbols as they appear on the keyboard. For example, **ENTER** identifies the **ENTER** key.

### Key operation

Some operations require you to simultaneously use two or more keys. We identify such operations by the key top symbols separated by a plus sign (+). For example, **CTRL + C** means you must hold down **CTRL** and at the same time press **C**. If three keys are used, hold down the first two and at the same time press the third.

**ABC**

When procedures require an action such as clicking an icon or entering text, the icon's name or the text you are to type in is represented in the typeface you see to the left.

### Display



**ABC**

Names of windows or icons or text generated by the computer that appear on its display screen are presented in the type face you see to the left.

## Messages

Messages are used in this manual to bring important information to your attention. Each type of message is identified as shown below.



*Pay attention! A caution informs you that improper use of equipment or failure to follow instructions may cause data loss or damage your equipment.*



*Please read. A note is a hint or advice that helps you make best use of your equipment.*



*Indicates a potentially hazardous situation, which could result in death or serious injury, if you do not follow instructions.*

## Terminology

This term is defined in this document as follows:

### Start

The word “**Start**” refers to the “” button in Microsoft® Windows Vista™.





# General Precautions

TOSHIBA computers are designed to optimize safety, minimize strain and withstand the rigors of portability. However, certain precautions should be observed to further reduce the risk of personal injury or damage to the computer.

Be certain to read the general precautions below and to note the cautions included in the text of the manual.

## Creating a computer-friendly environment

Place the computer on a flat surface that is large enough for the computer and any other items you are using, such as a printer.

Leave enough space around the computer and other equipment to provide adequate ventilation. Otherwise, they may overheat.

To keep your computer in prime operating condition, protect your work area from:

- Dust, moisture, and direct sunlight.
- Equipment that generates a strong electromagnetic field, such as stereo speakers (other than speakers that are connected to the computer) or speakerphones.
- Rapid changes in temperature or humidity and sources of temperature change such as air conditioner vents or heaters.
- Extreme heat, cold, or humidity.
- Liquids and corrosive chemicals.

## Stress injury

Carefully read the *Instruction Manual for Safety and Comfort*. It contains information on the prevention of stress injuries to your hands and wrists that can be caused by extensive keyboard use. *Instruction Manual for Safety and Comfort* also includes information on work space design, posture and lighting that can help reduce physical stress.

## Heat injury

- Avoid prolonged physical contact with the computer. If the computer is used for long periods, its surface can become very warm. While the temperature will not feel hot to the touch, if you maintain physical contact with the computer for a long time, for example if you rest the computer on your lap or if you keep your hands on the palm rest, your skin might suffer a low-heat injury.
- If the computer has been used for a long time, avoid direct contact with the metal plate supporting the various interface ports as this can become hot.
- The surface of the AC adaptor can become hot when in use but this condition does not indicate a malfunction. If you need to transport the AC adaptor, you should disconnect it and let it cool before moving it.
- Do not lay the AC adaptor on a material that is sensitive to heat as the material could become damaged.

## Pressure or impact damage

Do not apply heavy pressure to the computer or subject it to any form of strong impact as this can damage the computer's components or otherwise cause it to malfunction.

## PC Card overheating

Some PC Cards can become hot during prolonged use which may result in errors or instability in the operation of the device in question. In addition, you should also be careful when you remove a PC Card that has been used for a long time.

## Mobile phones

Please be aware that the use of mobile phones can interfere with the audio system. The operation of the computer will not be impaired in any way, but it is recommended that a minimum distance of 30cm is maintained between the computer and a mobile phone that is in use.

## Instruction Manual for Safety and Comfort

All important information on the safe and proper use of this computer is described in the enclosed Instruction Manual for Safety and Comfort. Be sure to read it before using the computer.

## Cooling

1. Clean any dust accumulated on the computer's cooling vents. The cooling vents are located on the back and underside of the computer.



*When you use your computer in a dusty area, dirt and debris may accumulate on the cooling vents at the under side of your unit. If this occurs, the accumulated dust can cause insufficient heat dissipation which may result in the computer shutting down during use. Carefully clean the dust from the vents using a vacuum cleaner.*

2. Cooling vents on the underside and back of the computer.

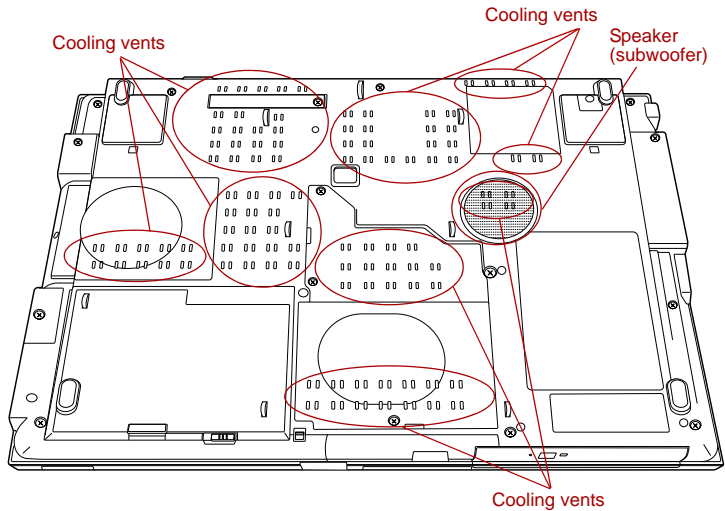

*The above illustration is of the subwoofer equipped model. Models without the subwoofer have cooling vents in the subwoofer location pictured above. Models with the subwoofer do not have cooling vents in the subwoofer location pictured above.*

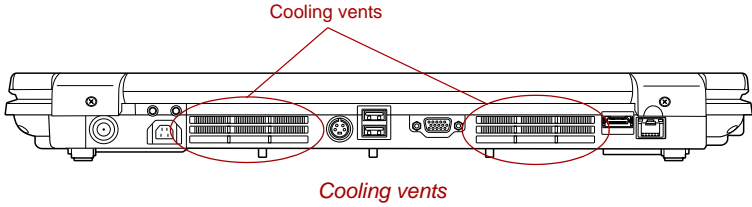

*To prevent possible overheating of the CPU, make sure the cooling fan's air intake is not blocked. The fan draws in air by creating a vacuum. If the fan is blocked, it could cause the CPU to run at a lower performance level or cause the computer to shut down. Loose items such as notebook and tissue paper, plastic wrappers, or other similar materials can block the air intake, preventing air from reaching the CPU. Do not use the computer on surfaces with objects that can be drawn in by the cooling fan.*

# Chapter 1

## Introduction

This chapter provides an equipment checklist, and it identifies the computer's features, options and accessories.



*Some of the features described in this manual may not function properly if you use an operating system that was not pre-installed by TOSHIBA.*

## Equipment checklist

Carefully unpack your computer, taking care to save the box and packaging materials for future use.

### Hardware

Check to make sure you have all the following items:

- Qosmio G40 Portable Personal Computer
- AC adaptor and power cord (2-pin plug or 3-pin plug)
- Battery pack (Is pre-installed in some computer)
- Modular cable (optional)
- VIDEO-IN cable
- HDMI OUT cable
- DVB-T Antenna (optional)
- Remote Controller
- Infrared transmitter cable
- Two AA manganese batteries (for Remote Controller)

## Software

The following Windows® operating system and utility software are pre-installed.

- Microsoft® Windows Vista™
- TOSHIBA Value Added Package
- Ulead DVD MovieFactory®
- Fingerprint Utility
- Windows Mobility Center
- TOSHIBA Disc Creator
- TOSHIBA ConfigFree
- TOSHIBA Assist
- TOSHIBA SD Memory Utilities
- CD/DVD Drive Acoustic Silencer
- TOSHIBA Password Utility
- TOSHIBA HD DVD PLAYER



*Please refer to the included Qosmio HD DVD Guide for more information on using the TOSHIBA HD DVD PLAYER.*

## Documentation

- Qosmio G40 Portable Personal Computer User's Manual
- Qosmio G40 Quickstart
- Qosmio G40 HD DVD Guide
- Microsoft® Windows Vista™ Quickstart Guide (provided with some models)
- Instruction Manual for Safety and Comfort
- Warranty information

If any of the items are missing or damaged, contact your dealer immediately.

## Backup media

- Product Recovery DVD-ROM

## Hardware

This section describes the hardware of your computer.

The actual specifications may vary depending on the model you purchased.

### Processor

|                 |  |
|-----------------|--|
| <b>Built-in</b> | <p>The computer is equipped with one of the following Intel® processor.</p> <ul style="list-style-type: none"> <li>■ Intel® Core™ 2 Duo Processor, which incorporates 2MB Level-2 cache memory and supports Enhanced Intel® SpeedStep® Technology.</li> <li>■ Intel® Core™ 2 Duo Processor, which incorporates 4MB Level-2 cache memory and supports Enhanced Intel® SpeedStep® Technology.</li> </ul> |
|-----------------|--|



*Some models in this series use Intel® Centrino® Duo processor technology which is based on three separate components, the Intel® Core™ 2 Duo processor, Intel® PRO/Wireless network connection and the Mobile Intel® 965 Express Chipset family.*

### Legal Footnote (CPU)\*1

For more information on the CPU, please refer to the [Legal Footnotes](#) section in Chapter 11 or Click the \*1 above.

### Memory

|              |   |
|--------------|---|
| <b>Slots</b> | <p>512, 1,024 or 2,048MB memory modules can be installed in the computer's two memory slots for a maximum of 4,096MB system memory.</p> <p>This computer can be equipped with memory modules of a maximum size of 4,096MB. The actual amount of useable system memory will be less than the installed memory modules.</p> |
|--------------|---|

---

**Video RAM**

The amount of Video RAM available is dependent on the computer's system memory.

**Start -> Control Panel -> Appearance and Personalization -> Personalization -> Display Settings.**

The amount of Video RAM can be verified by clicking the **Advanced Settings...** button in the Display Settings window.

---

***Legal Footnote (Memory (Main System))\*2***

For more information regarding Memory (Main System), please refer to the [Legal Footnotes](#) section in Chapter 11 or click the \*2 above.

---

***Power***

---

**Battery pack**

The computer is powered by one rechargeable lithium-ion battery pack.

---

***Legal Footnote (Battery Life)\*3***

For more information regarding Battery Life, please refer to the [Legal Footnotes](#) section in Chapter 11 or click the \*3 above.

---

**RTC battery**

The internal RTC battery backs up the Real Time Clock and calendar.

---

**AC adaptor**

The AC adaptor provides power to the system and recharges the batteries when they are low. It comes with a detachable power cord which will either have a 2-pin or 3-pin plug enclosure.

As the AC adaptor is universal, it can receive a range of AC voltages from 100 to 240 volts, however you should note that the output current varies among different models. Using the wrong adaptor can damage your computer. Refer to the [AC adaptor](#) section in Chapter 2, *The Grand Tour*.

---



## ***Disks***

### **Hard disk drive**

The following 6 types of hard disk drives can be installed in this computer. The capacity of each hard disk drive model is different.

- 80.0 billion bytes (74.53 GB)
- 100.0 billion bytes (93.16 GB)
- 120.0 billion bytes (111.79 GB)
- 160.0 billion bytes (149.05 GB)
- 200.0 billion bytes (186.32 GB)
- 250.0 billion bytes (232.90 GB)

Two computer models are available, a model with a single hard disk drive and a model with two hard disk drives.

Please note that part of the hard disk drive's overall capacity is reserved as administration space.

### ***Legal Footnote (Hard Disk Drive (HDD) Capacity)\*4***

For more information regarding Hard Disk Drive (HDD) Capacity, please refer to the [Legal Footnotes](#) section in Chapter 11 or click the \*4 above.

## **Optical disc drive**

### **HD DVD-ROM drive**

Some models are equipped with a full-size HD DVD-ROM drive module that lets you run CD's or DVD's without using an adaptor. The drive reads DVD-ROM's at a maximum 8x speed and CD-ROM's at a maximum 24x speed, and HD DVD's at a maximum 1x speed and writes CD-R's at up to 16x speed, CD-RW's at up to 10x speed, DVD-R's and DVD+R's at up to 4x speed, DVD-RW's and DVD+RW's at up to 4x speed, DVD-R (Dual layer) at up to 2x speed, DVD+R (Double Layer) at up to 2.4x speed and DVD-RAM at up to 3x speed, and supports the following formats:

- CD-R
  - CD-RW
  - DVD-ROM
  - DVD-Video
  - CD-DA
  - CD-Text
  - Photo CD™ (single/multi-session)
  - CD-ROM Mode 1, Mode 2
  - CD-ROM XA Mode 2 (Form1, Form2)
  - Enhanced CD (CD-EXTRA)
  - Addressing Method 2
  - DVD-R
  - DVD-R (Dual Layer)
  - DVD-RW
  - DVD+R
  - DVD+R (Double Layer)
  - DVD+RW
  - DVD-RAM
  - HD DVD-ROM
-

**HD DVD-R drive**

Some models are equipped with a full-size HD DVD-R drive module that lets you run CD's or DVD's without using an adaptor.

The drive reads DVD-ROM's at a maximum 8x speed and CD-ROM's at a maximum 24x speed, and HD DVD's at a maximum 1x speed and writes CD-R's at up to 16x speed, CD-RW's at up to 10x speed, DVD-R's and DVD+R's at up to 4x speed, DVD-RW's and DVD+RW's at up to 4x speed, DVD-R (Dual layer) at up to 2x speed, DVD+R (Double Layer) at up to 2.4x speed and DVD-RAM at up to 3x speed, HD DVD-R at up to 1x speed, and supports the following formats in addition to HD DVD-ROM drive:

- HD DVD-R



*The optical drive installed on this computer cannot write multiple sessions on HD DVD-R Dual Layer disc sessions. Once a disc has been written to once, it will be finalized. Once finalized, no further writing to the disc will be possible regardless of what portion of the total disc capacity was used.*

### **Legal Footnote (General HD DVD technology and playback)\*5**

For more information regarding the General HD DVD technology and playback, please refer to the [Legal Footnotes](#) section in Chapter 11 or click the \*5 above.

### **Display**

The computer's internal display panel supports high-resolution video graphics and can be set to a wide range of viewing angles for maximum comfort and readability.

**Built-in**

17" TFT LCD screen, 32 million colors, with a resolution of 1920 horizontal x 1200 vertical pixels WUXGA.

### **Legal Footnote (LCD)\*6**

For more information regarding the LCD, please refer to the [Legal Footnotes](#) section in Chapter 11 or click the \*6 above.



**Graphics controller**

Graphics controller maximizes display performance. Refer to [Display Controller and Video modes](#) section in Appendix B for more information.

**Legal Footnote (Graphics Processor Unit (“GPU”))\*7**

For more information regarding the Graphics Processor Unit (“GPU”), please refer to the [Legal Footnotes](#) section in Chapter 11 or click the \*7 above.

**Keyboard**

|                 |  |
|-----------------|--|
| <b>Built-in</b> | The internal keyboard provides the embedded numeric overlay keys, dedicated cursor control overlay keys,  and  Keys. The keyboard is compatible with the IBM® enhanced keyboard. Refer to Chapter 5, <a href="#">The Keyboard</a> , for details. |
|-----------------|--|

**Pointing Device**

|                             |  |
|-----------------------------|--|
| <b>Built-in Touch Pad</b>   | The integrated Touch Pad and control buttons in the palm rest allow control of the on-screen pointer and support functions such as the scrolling of windows. |
| <b>Qosmio AV Controller</b> | This button allows you to operate the Media Center.  |

**Ports**

|                                       |  |
|---------------------------------------|--|
| <b>External monitor</b>               | The analog VGA port provides support for VESA DDC2B compatible functions.  |
| <b>Universal Serial Bus (USB 2.0)</b> | The computer supports multiple Universal Serial Bus ports that comply with the USB 2.0 standard.                                 |
| <b>i.LINK™ (IEEE1394)</b>             | This port allows high-speed data transfer to take place between the computer and external devices such as digital video cameras. |

**Slots**

|                     |  |
|---------------------|--|
| <b>PC Card</b>      | The internal PC Card slot accommodates a single Type II (5mm) card.  |
| <b>ExpressCard</b>  | The internal ExpressCard slot is a Universal slot. This slot supports ExpressCard/54 and ExpressCard/34 modules.   |
| <b>Bridge media</b> | This slot lets you insert SD/SDHC memory card, miniSD/microSD Card, Memory Stick (PRO/PRO Duo), xD picture card and MultiMediaCard. Refer to Chapter 9, <a href="#">Optional Devices</a> . |

---

## Multimedia

|                                |   |
|--------------------------------|---|
| <b>Sound system</b>            | The integrated sound system provides support for the computer's internal speakers and microphone, as allowing an external microphone and headphones to be connected via the appropriate jacks.  |
| <b>Web Camera</b>              | <b>Web Camera</b> is a device that allows you to record video or take photographs with your computer. You can use it for video chatting or video conferences using a communication tool such as <b>Windows Live Messenger</b> . Camera Assistant Software will help you to add various video effects to your video or photograph. Please refer to the <a href="#">Web Camera</a> section in Chapter 4, <a href="#">Operating Basics</a> . |
| <b>TV antenna port</b>         | Connect the antenna cable to this port to watch TV programs on your computer or record them. The dimensions and shape of the TV antenna port vary for different regions.  |
| <b>S-Video-in Port</b>         | A camcorder or other recording device can be connected to this port via the S-Video-in cable (optional) for importing video data. Refer to the <a href="#">S-Video-in</a> section in Chapter 9, <a href="#">Optional Devices</a> .  |
| <b>S-Video out port</b>        | This S-Video out port lets you transfer NTSC or PAL data to external devices. Refer to the <a href="#">TV</a> section in Chapter 9, <a href="#">Optional Devices</a> .  |
| <b>VIDEO-IN port</b>           | With the bundled VIDEO-IN cable, the CATV or satellite set top boxes can be connected to the computer to view the channels. Please refer to Chapter 8, <a href="#">Connecting the VIDEO-IN port</a> for details on how to connect the computer with the VIDEO-IN cable.   |
| <b>HDMI out port</b>           | HDMI out port can connect with Type A connector HDMI cable. One HDMI cable can send and receive video, audio and control signals.   |
| <b>Headphone (S/PDIF) jack</b> | This jack lets you connect digital speakers or a stereo headphone (16 ohm minimum). When you connect a digital speaker or headphones, the internal speaker is automatically disabled. This jack can be used also as S/PDIF jack and enables connection of optical digital correspondence apparatus.   |

---

|  |   |
|--|---|
| <b>Headphone jack</b>                  | A 3.5mm mini headphone jack enables connection of stereo headphones or powered speakers.  |
| <b>Microphone jack</b>                 | A 3.5mm mini microphone jack enables connection of a three-conductor microphone for monaural input.   |
| <b>Line-in jack</b>                    | A standard 3.5 mm mini line-in jack enables connection of a stereo device for audio input.  |
| <b>Built-in TV Tuner</b>               | Built-in TV Tuner enables watching and recording TV programs. Some models are capable of simultaneously recording 2 different television programs.  |
| <b>Infrared receiver window</b>        | This is a sensor window that receives signals from the Remote Controller which is provided with your computer.  |
| <b>Infrared transmitter cable port</b> | Connect the Infrared transmitter cable to this port.<br><br>Connecting the set top box or other external device to the computer using the infrared transmitter cable allows the external device to be operated using the computer and specialized remote control. |
| <b>Remote Controller</b>               | Use this device to navigate when watching TV or playing CDs/DVDs/HD DVDs.   |

---

## ***Communications***

|                  |   |
|------------------|---|
| <b>Modem</b>     | An internal modem provides capability for data and fax communication. It supports V.90 or V.92 depending on the region. The speed of data transfer and fax depends on analog telephone line conditions. It has a modem jack for connecting to a telephone line.   |
| <b>LAN</b>       | The computer has built-in support for Ethernet LAN (10 megabits per second, 10BASE-T), Fast Ethernet LAN (100 megabits per second, 100BASE-TX) and Gigabit Ethernet LAN (1000 megabits per second, 1000BASE-T).   |
| <b>Bluetooth</b> | Some computers in this series offer Bluetooth wireless communication functionality which eliminates the need for cables between electronic devices such as computers and printers. When implemented, Bluetooth provides a fast, reliable and secure means to achieve wireless communication in a small space. |

---

**Wireless LAN**

Some computers in this series are equipped with a Wireless LAN card that is compatible with other LAN systems based on Direct Sequence Spread Spectrum/Orthogonal Frequency Division Multiplexing radio technology that complies with the IEEE 802.11 Standard (Revision A, B, G or N Draft Ver. 1.0).



- *The transmission speed over the wireless LAN and the distance over which wireless LAN can reach may vary depending on surrounding electromagnetic environment, obstacles, access point design and configuration, and client design and software/hardware configurations. The Transmit Rate (at X Mbit/s) is the theoretical maximum speed under the IEEE802.11 (a/b/g) standard. The actual transmission speed will be lower than the theoretical maximum speed.*
- *The Wake-up on Wireless LAN function is effective only when it is connected with an Access Point. This function becomes invalid when the connection is broken.*

**Legal Footnote (Wireless LAN)\*8**

For more information regarding Wireless LAN, please refer to the [Legal Footnotes](#) section in Chapter 11 or click the \*8 above.

**Wireless communication switch**

This switch turns the Wireless LAN and Bluetooth functions on and off. Please note that all models are provided with a Wireless communication switch and some models are equipped with both Wireless LAN and Bluetooth functionality.

**Security****Security lock slot**

Connects a security lock to anchor the computer to a desk or other large object.

## Special features

The following features are either unique to TOSHIBA computers or are advanced features which make the computer more convenient to use.

Access each function using the following procedures.

\*1 To access the Power Options, click **Start -> Control Panel -> System and Maintenance -> Power Options**.

|   |   |
|---|---|
| <b>Hot keys</b>                                   | Hot keys are specific key combinations that let you quickly change the system configuration directly from the keyboard without running a system program.  |
| <b>Display automatic power off</b> *1             | This feature automatically cuts off power to the computer's display panel when there is no keyboard input for a specified time, with power being restored the next time a key is pressed. This can be specified in the Power Options.   |
| <b>HDD automatic power off</b> *1                 | This feature automatically cuts off power to the hard disk drive when it is not accessed for a specified time, with power being restored when the hard disk drive is next accessed. This can be specified in the Power Options.   |
| <b>System automatic Sleep/Hibernation Mode</b> *1 | This feature automatically shuts down the system into either Sleep Mode or Hibernation Mode when there is no input or hardware access for a specified time. This can be specified in the Power Options.   |
| <b>Keypad overlay</b>                             | A ten-key numeric keypad is integrated into the keyboard. Please refer to the <a href="#">Keypad overlay</a> section in Chapter 5, <i>The Keyboard</i> , for information on using this feature.   |
| <b>Power on password</b>                          | Two levels of password security, supervisor and user, are available to prevent unauthorized access to your computer.  |
| <b>Instant security</b>                           | A specific hot key function automatically locks the system providing data security.   |
| <b>Intelligent power supply</b> *1                | A microprocessor in the computer's intelligent power supply detects the battery's charge, automatically calculates the remaining battery capacity and protects electronic components from abnormal conditions such as a voltage overload from the AC adaptor. This can be specified in the Power Options. |



---

|  |  |
|--|--|
| <b>Battery save mode</b> *1                      | This feature lets you configure the computer in order to save battery power. This can be specified in the Power Options.   |
| <b>Panel power on/off</b> *1                     | This feature automatically turns power to the computer off when the display panel is closed, and turns it back on when the display panel is opened. This can be specified in the Power Options.  |
| <b>Low battery automatic Hibernation Mode</b> *1 | When battery power is exhausted to the point that computer operation cannot be continued, the system automatically enters Hibernation Mode and shuts itself down. This can be specified in the Power Options.  |
| <b>Heat dispersal</b> *1                         | To protect against overheating, the processor has an internal temperature sensor so that, if the computer's internal temperature rises to a certain level, the cooling fan is turned on or the processing speed is lowered. This can be specified in the Power Options.  |
| <b>Hibernation Mode</b>                          | This feature lets you turn off the power to the computer without exiting from your software. The contents of main memory are automatically saved to the hard disk drive so that when you next turn the power on again, you can continue working right where you left off. Refer to the <a href="#">Turning off the power</a> section in Chapter 3, <a href="#">Getting Started</a> , for more details. |
| <b>Sleep Mode</b>                                | If you have to interrupt your work, you can use this feature to allow you to turn off power to the computer without exiting from your software. Data is maintained in the computer's main memory so that when you next turn on the power, you can continue working right where you left off.   |

---

## TOSHIBA Value Added Package

This section describes the TOSHIBA Component features pre-installed on the computer.

|                                   |   |
|-----------------------------------|---|
| <b>TOSHIBA Power Saver</b>        | TOSHIBA Power Saver provides you with the features of more various power supply managements.  |
| <b>TOSHIBA Button Support</b>     | <p>This utility controls the following computer panel functions.</p> <p>The applications associated with each of the following panels can be assigned by the user.</p> <ul style="list-style-type: none"> <li>■ Panels: Assign applications to the REC, Brightness, Illumination On/Off, DOLBY, TV-out panels.</li> </ul>   |
| <b>TOSHIBA Zooming Utility</b>    | This utility allows you to enlarge or reduce the icon size on the Windows Desktop, or the zoom factor associated with specific supported applications.  |
| <b>TOSHIBA PC Diagnostic Tool</b> | The TOSHIBA PC Diagnostic Tool will display basic system configuration information and allow the functionality of some of the computer's built-in hardware devices to be tested.  |
| <b>TOSHIBA Password Utility</b>   | The TOSHIBA Password utility allows you to set a password in order to restrict access to the computer.  |
| <b>TOSHIBA Flash Cards</b>        | <p>The TOSHIBA Flash Cards provide a quick way to modify selected system functions and to launch applications.</p> <ul style="list-style-type: none"> <li>■ Hot key function</li> <li>■ TOSHIBA utility launcher function</li> </ul>  |
| <b>HW Setup</b>                   | This utility allows you to customize your hardware settings according to the way you work with the computer and the peripherals you use.  |
| <b>TOSHIBA Accessibility</b>      | The TOSHIBA Accessibility utility provides support to movement impaired users when they need to use the TOSHIBA Hot-key functions. In use, the utility allows you to make the <b>FN</b> key "sticky", that is you can press it once, release it, and they press one of the " <b>F</b> " keys in order to access its specific function. When set, the <b>FN</b> key will remain active until another key is pressed. |

## Utilities and Applications

This section describes the pre-installed utilities that come with the computer and details how to start them. For further information on their operation, please refer to each utility's online manual, help files or README.TXT file.

### Fingerprint Utility

This product has a fingerprint utility installed for the purpose of enrolling and recognizing fingerprints which can then be linked to a username and password in order to remove the need to input these details from the keyboard. Just by swiping an enrolled finger against the fingerprint sensor, the following functions will be enabled:

- Logon to Windows and access a security enabled homepage through Internet Explorer.
- Files and folders can be encrypted/decrypted and third party access to them is prevented.
- Disable the password-protected screen-saver when returning from a power-saving mode such as Sleep Mode.
- Authentication of the User Password (and, if applicable, the HDD(Hard Disk Drive) Password) when booting up the computer (Power-on Security).
- Single Sign-on feature

### Bluetooth Stack for Windows by Toshiba

This software enables communication between the computer and external Bluetooth devices such as printers and mobile phones.



*Bluetooth functions cannot be used in models that do not have a Bluetooth module installed.*

### TOSHIBA Assist

TOSHIBA Assist is a graphical user interface that provides access to specific tools, utilities and applications that make the use and configuration of the computer easier.

### TOSHIBA ConfigFree

TOSHIBA ConfigFree is a suite of utilities that improve the ease and control of communication devices and network connections, help in the identification of communication problems and allow the creation of profiles if you need to switch between different locations and communication networks. To access this utility, click **Start -> All Programs -> TOSHIBA -> Networking -> ConfigFree.**

|   |   |
|---|---|
| <b>TOSHIBA Disc Creator</b>               | <p>You can create CD's and DVD's in a number of formats including audio CD's that can be played on a standard CD player, and data CD's/DVD's which can store copies of the files and folders on your computer's hard disk drive. This software can be used on models with either a HD DVD-ROM drive or a HD DVD-R drive.</p> <p>To access this utility, click <b>Start -&gt; All Programs -&gt; TOSHIBA -&gt; CD&amp;DVD Applications -&gt; Disc Creator</b>.</p>   |
| <b>TOSHIBA DVD-RAM Utility</b>            | <p>TOSHIBA DVD-RAM Utility has the function of Physical Format and Write-Protect to DVD-RAM. This utility is contained the setup module of TOSHIBA Disc Creator. To access this utility, click <b>Start -&gt; All Programs -&gt; TOSHIBA -&gt; CD&amp;DVD Applications -&gt; DVD-RAM Utility</b>.</p>   |
| <b>Ulead DVD MovieFactory for TOSHIBA</b> | <p>Ulead DVD MovieFactory for TOSHIBA allows users to instantly create DVD video or slideshow discs via a user-friendly wizard interface with specific task oriented features.</p>  |
| <b>TOSHIBA SD Memory Card Format</b>      | <p>This utility allows you to format an SD memory card by the SD standard format.</p>   |
| <b>Windows Mobility Center</b>            | <p>This section describes the Windows Mobility Center. Mobility Center is a utility for accessing several mobile PC settings quickly in one window. A default maximum of eight tiles are provided by the operating system, and the additional two tiles are added to your Mobility Center.</p> <ul style="list-style-type: none"> <li>■ <b>Lock Computer:</b><br/>This can be used to lock your computer without turning it off. This has the same function as the <b>Lock</b> button at the bottom of the right pane in the start menu.</li> <li>■ <b>TOSHIBA Assist:</b><br/>This can be used to open <b>TOSHIBA Assist</b> if it is already installed in your computer.</li> </ul> |
| <b>TOSHIBA HD DVD PLAYER</b>              | <p>This software is provided for playback of HD DVD Video.</p> <p>Please refer to the included Qosmio HD DVD Guide for more information on using the TOSHIBA HD DVD PLAYER.</p>   |

---

|                                       |  |
|---------------------------------------|--|
| <b>CD/DVD Drive Acoustic Silencer</b> | The CD/DVD Drive Acoustic Silencer utility allows you to configure the read speed at which the optical disc drive will operate. In use you can select either <b>Normal Mode</b> , which will operate the drive at its maximum speed for quick data access, or <b>Quiet Mode</b> , which operates the drive at single speed for audio CD playback and which can lessen the operational noise. This utility does not have any function when using DVD's. |
|---------------------------------------|--|

---

## Options

You are able to add a number of options and accessories in order to make your computer even more powerful and convenient to use. For reference, the following list details some of the items that are available from your reseller or TOSHIBA dealer:

---

|                              |   |
|------------------------------|---|
| <b>Memory expansion</b>      | A 512MB, 1,024MB or 2,048MB memory module (DDR2-667) can easily be installed in the computer.   |
| <b>Battery Pack</b>          | An additional battery pack can be purchased for use as either a spare or replacement. Please refer to Chapter 6, <a href="#">Power</a> for further information.   |
| <b>Universal AC Adaptor</b>  | If you frequently use your computer at more than one site, it may be convenient to purchase an additional AC adaptor to be kept at each site in order to remove the need to always carry the adaptor with you.  |
| <b>USB FDD kit</b>           | The USB floppy disk drive accommodates either a 1.44MB or 720KB floppy disk through connection to one of the computer's USB ports. In use, please be aware that, while you cannot format 720KB floppy disks under Windows Vista™, you are able to read and write to disks that have already been formatted. |
| <b>Battery Charger</b>       | The optional battery charger allows you to charge extra battery packs outside of having to use the computer.  |
| <b>Bluetooth USB Adaptor</b> | A Bluetooth adaptor that has a USB connector. Wireless communications can be carried out with Bluetooth-compatible equipment by connecting to the USB port of the computer. You can buy the module from a TOSHIBA dealer.   |

---

---

**Bluetooth Wireless Mouse**

The Bluetooth Wireless Mouse is a wireless optical mouse compatible with Bluetooth. You can buy the Bluetooth Wireless Mouse from a TOSHIBA dealer.

---

**Bluetooth Wireless Stereo**

The Bluetooth Wireless Stereo is a wireless stereo headphone set compatible with Bluetooth. You can buy the Bluetooth Wireless Stereo from a TOSHIBA dealer.

---

# Chapter 2

## The Grand Tour

This chapter identifies the various components of your computer. Become familiar with each component before you operate the computer.

### **Legal Footnote (Non-applicable Icons)\*9**

For more information regarding Non-applicable Icons, please refer to the [Legal Footnotes](#) section in Chapter 11 or click the \*9 above.

## Front with the display closed

The following figures show the computer's front with its display panel in the closed position.

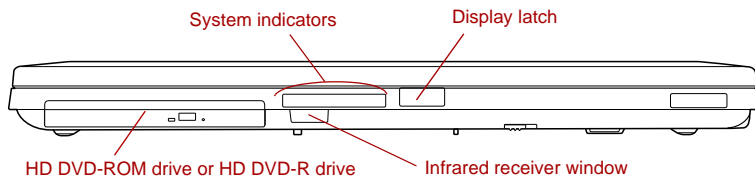

*Front of the computer with display closed*

|                                     |   |
|-------------------------------------|---|
| <b>HD DVD-ROM or HD DVD-R drive</b> | The computer is configured with a HD DVD-ROM or HD DVD-R drive.   |
| <b>System indicators</b>            | These LED indicators allow you to monitor the status of various computer functions and are described in more detail within the <a href="#">System indicators</a> section. |
| <b>Display latch</b>                | This latch secures the display panel in its closed position - push the latch in order to open the display for use.  |
| <b>Infrared receiver window</b>     | This is a sensor window that receives signals from the remote control which is provided with your computer.   |

## Left side

The following figure shows the computer's left side.

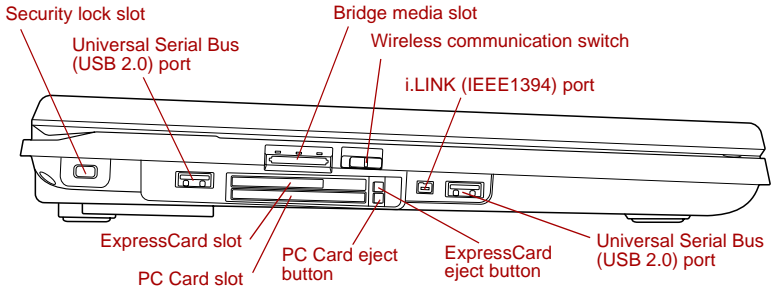

*The left side of the computer*



### Security lock slot

A security cable can be attached to this slot and then connected to a desk or other large object in order to deter theft of the computer.



### ExpressCard slot

This slot allows you to install a single ExpressCard device.



### ExpressCard eject button

This button is used in order to remove an ExpressCard from within the computer.



### PC Card slot

This slot can accommodate a single Type II, 16-bit or 32-bit (CardBus) PC Card device.

### PC Card eject button

This button is used in order to remove a PC Card from within the computer.



*Keep foreign metal objects, such as screws, staples and paper clips, out of the ExpressCard slot and PC Card slot. Foreign metal objects can create a short circuit, which can cause damage and fire, possibly resulting in serious injury.*



### Universal Serial Bus (USB 2.0) ports

Two Universal Serial Bus ports, which comply with the USB 2.0 standard, are provided on the left hand side of the computer. The ports with the icon ( ⚡ ) has USB Sleep and Charge function.



*Keep foreign metal objects, such as screws, staples and paper clips, out of the USB connectors. Foreign metal objects can create a short circuit, which can cause damage and fire, possibly resulting in serious injury.*





Please note that it is not possible to confirm the operation of all functions of all USB devices that are available. In view of this it may be noted that some functions associated with a specific device might not operate properly.

**Bridge media slot**

This slot lets you insert an SD/SDHC memory card, miniSD/microSD Card, Memory Stick (PRO/PRO Duo), xD picture card and MultiMediaCard. Refer to Chapter 9, *Optional Devices*.



Keep foreign metal objects, such as screws, staples and paper clips, out of the Bridge media slot. Foreign metal objects can create a short circuit, which can cause damage and fire, possibly resulting in serious injury.

On

**Wireless communication switch**

Slide this switch to the right to turn off Wireless LAN and Bluetooth functions. Slide it to the left to turn on the functions.

All models are provided with a Wireless communication switch although only some models are equipped with both Wireless LAN and Bluetooth functions.



- Turn Wi-Fi® and Bluetooth functionalities off when near a person who may have a cardiac pacemaker implant or other medical electric device. Radio waves may affect pacemaker or medical device operation, possibly resulting in serious injury. Follow the instruction of your medical device when using any Wi-Fi or Bluetooth functionality.
- Always turn off Wi-Fi or Bluetooth functionality if the computer is near automatic control equipment or appliances such as automatic doors or fire detectors. Radio waves can cause malfunction of such equipment, possibly resulting in serious injury.
- Do not use the Wi-Fi or Bluetooth functionalities near a microwave oven or in areas subject to radio interference or magnetic fields. Interference from a microwave oven or other source can disrupt Wi-Fi or Bluetooth operation.



S400

**i.LINK (IEEE1394) port**

This port allows you to connect an external device, such as a digital video camera, to the computer for high-speed data transfer.

## Right side

The following figure shows the computer's right side.

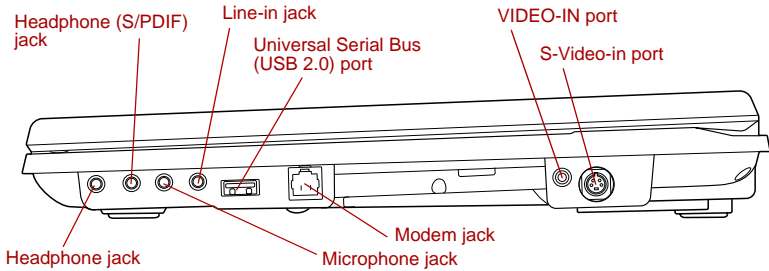

*The right side of the computer*



### Headphone jack

A 3.5 mm mini headphone jack enables connection of stereo headphones.



### Headphone (S/PDIF) jack

This jack lets you connect digital speakers or a stereo headphone (16 ohm minimum). When you connect a digital speaker or headphones, the internal speaker is automatically disabled. This jack can be used also as S/PDIF jack and enables connection of optical digital correspondence apparatus.



### Microphone jack

A 3.5 mm mini microphone jack enables connection of a three-conductor mini jack for monaural microphone input.



### Line-in jack

A standard 3.5 mm mini line-in jack enables connection of a stereo device for audio input.



### Universal Serial Bus (USB 2.0) port

The Universal Serial Bus port, which complies with the USB 2.0 standard, is provided on the right side of the computer.



### Modem jack

The modem jack allows you use to attach a modular cable in order to connect the internal modem directly to a telephone line.



- *Connection to any communication line other than an analog phone line could cause a computer system failure.*
  - *Connect the built-in modem only to ordinary analog phone lines.*
  - *Never connect the built-in modem to a digital line (ISDN).*
  - *Never connect the built-in modem to the digital connector on a public telephone or to a digital private branch exchange (PBX).*
  - *Never connect the built-in modem to a key telephone system for residences or offices.*
- *Never operate your computer on AC power during a thunderstorm. If you see lightning or hear thunder, immediately turn off the computer. An electric surge caused by the storm, may result in a system failure, loss of data or hardware damage.*

**VIDEO-IN port**

With the bundled VIDEO-IN cable, the CATV or satellite set top boxes can be connected to the computer to view the channels.

Please refer to Chapter 8, [AV functions](#) for details on how to connect the computer with the VIDEO-IN cable.

**S-Video-in port**

A camcorder or other recording device can be connected to your computer via the S-Video-in cable for importing video data. Connect the cable to this port for this operation. Refer to the [S-Video-in](#) section in Chapter 9, [Optional Devices](#).

## Back

The following figure shows the computer's back.

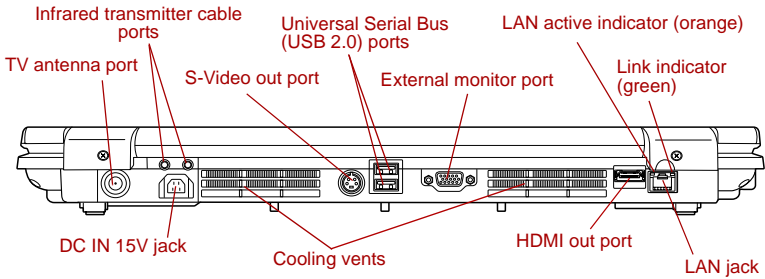

*The back of the computer*



### TV antenna port

Connect the antenna cable to this port to watch TV programs on your computer or record them. The dimensions and shape of the TV antenna port vary for different regions.



### DC IN 15V jack

The AC adaptor connects to this jack in order to power the computer and charge its internal batteries. Please note that you should only use the model of adaptor supplied with the computer at the time of purchase - using the wrong adaptor can cause damage to the computer.

### Cooling vents

The computer's cooling vents help keep the processor from overheating.



*Do not block the cooling vents. Keep foreign metal objects, such as screws, staples and paper clips, out of the cooling vents. Foreign metal objects can create a short circuit, which can cause damage and fire, possibly resulting in serious injury.*



### Infrared transmitter cable ports

Connect the infrared transmitter cable to the infrared transmitter cable port on the computer and to the set-top box.



### S-Video out port

The S-Video out port supports the connection of an optional S-Video cable to attach the computer to a television or similar device.



### Universal Serial Bus (USB 2.0) ports

Two Universal Serial Bus ports, which comply with the USB 2.0 standard, are provided on the back of the computer.

**External monitor port**

This port allows you to connect an external video display to the computer.

**HDMI out port**

HDMI out port can connect with Type A connector HDMI cable.

One HDMI cable can send and receive video, audio and control signals.

**LAN jack**

This jack lets you connect to a LAN. The adaptor has built-in support for Ethernet LAN (10 megabits per second, 10BASE-T), Fast Ethernet LAN (100 megabits per second, 100BASE-TX) and Gigabit Ethernet LAN (1000 megabits per second, 1000BASE-T). The LAN has two indicators. Refer to Chapter 4, [Operating Basics](#), for details.



- *Do not connect any cable other than a LAN cable to the LAN jack. It could cause damage or malfunction.*
- *Do not connect the LAN cable to a power supply. It could cause damage or malfunction.*

**Link indicator (green)**

This indicator glows green when the computer is connected to a LAN and the LAN is functioning properly.

**LAN active indicator (orange)**

This indicator glows orange when data is being exchanged between the computer and the LAN.

## Underside

The following figure shows the underside of the computer. You should ensure that the display is closed before the computer is turned over to avoid causing any damage.

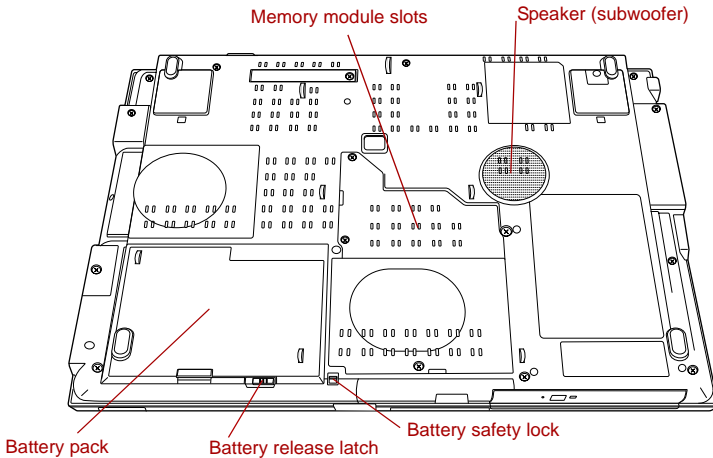

*The underside of the computer*



*The above illustration is of the subwoofer equipped model. Models without the subwoofer have cooling vents in the subwoofer location pictured above. Models with the subwoofer do not have cooling vents in the subwoofer location pictured above.*



### Memory module slots

The memory module slots are located here. The memory module slots allow for the installation, replacement and removal of additional memory modules. Please refer to the [Memory expansion](#) section in Chapter 9, [Optional Devices](#) for more information.

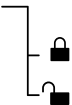

### Battery safety lock

Slide this latch into its “Unlock” position in order to release the battery pack ready for removal.



### Battery release latch

Slide and hold this latch into its “Unlock” position in order to release the battery pack ready for removal.

For more detailed information on removing the battery pack please refer to Chapter 6, [Power](#).

**Battery pack**

The battery pack provides power to the computer when the AC adaptor is not connected. For more detailed information on the use and operation of the battery pack please refer to Chapter 6, [Power](#).

**Speaker (subwoofer)**

The subwoofer will reproduce of the low frequency sounds generated. Some models are equipped with a subwoofer.

## Front with the display open

This section shows the computer with the display panel open. In order to open the display, simply push the display latch on the front of the computer, lift the display panel up and position it at a comfortable viewing angle for you.

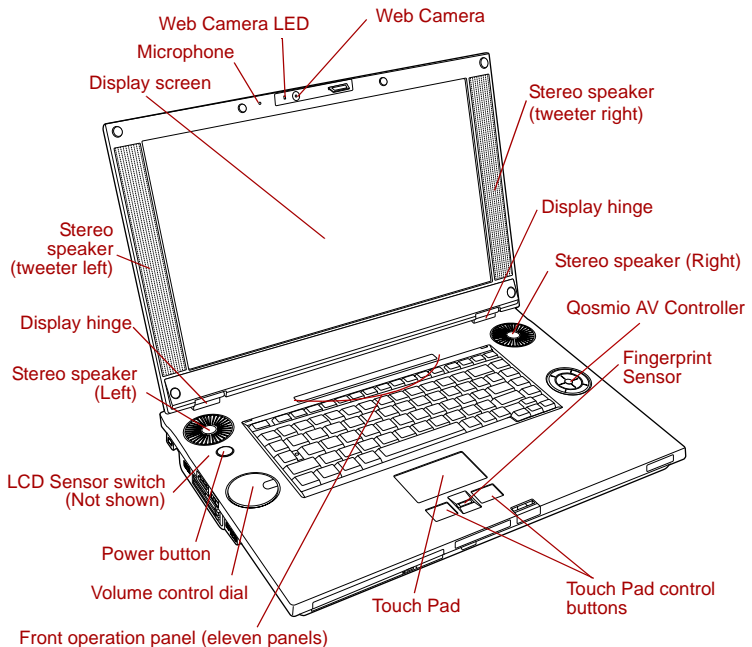

*The front of the Touch Pad model with the display open*

**Display hinge**

The display hinges allow the display panel to be position at a variety of easy-to-view angles.

harman / kardon

**Stereo speakers**

The speakers will reproduce all of the sounds generated through the installed software, together with any alarms, such as that accompanying a low battery condition, that are generated by the system.



*Keep foreign objects out of the speakers. Never allow metal objects, such as screws, staples and paper clips, to enter the computer or keyboard. Foreign metal objects can create a short circuit, which can cause computer damage and fire, possibly resulting in serious injury.*

**Speakers (tweeter)**

The tweeter will reproduce of the high-frequency sounds generated.

**Display screen**

The internal screen displays high-contrast text and graphics images up to the maximum resolution supported by the model in question. For example, an WUXGA compatible model will support resolutions between 800x600 and 1920x1200 pixels.

Please be aware that, when the computer is operating on the AC adaptor, the image displayed on the internal screen will be somewhat brighter than when it operates on battery power. This difference in brightness levels is intended to save power when operating on batteries. For more information on the computer's display, please refer to the [Display Controller and Video modes](#) section in Appendix B.

**Front operation panel (eleven panels)**

Eleven panels are available for use: TV, CD/DVD, Play/Pause, Stop, Previous, Next, Record, Brightness, Illumination On/Off, DOLBY, TV-out.

These panels allow you to manage Audio/Video, run applications and access utilities.

Refer to Chapter 8, [AV functions](#) for details.

**Power button**

Press this button to turn the computer's power on and off. The Power button will glow blue when the computer's power is on.

**Touch Pad**

The Touch Pad mouse control device located in the center of the palm rest is used to control the movement of the on-screen pointer. For more information, please refer to the [Using the Touch Pad](#) section in Chapter 4, [Operating Basics](#).



## 2.0M

|                                  |   |
|----------------------------------|---|
| <b>Touch Pad control buttons</b> | The control buttons located below the Touch Pad allow you to select menu items or manipulate text and graphics as designated by the on-screen pointer.  |
| <b>Fingerprint Sensor</b>        | <p>Just by swiping a valid and enrolled finger against the fingerprint sensor, the following functions will be enabled:</p> <ul style="list-style-type: none"> <li>■ Logon to Windows and access a security enabled homepage through Internet Explorer.</li> <li>■ Files and folders can be encrypted/decrypted and third party access to them prevented.</li> <li>■ Disable the password-protected screen-saver when returning from a power-saving mode such as Sleep Mode.</li> <li>■ Power-on security and single sign-on facilities.</li> </ul>   |
| <b>Web Camera</b>                | <p><b>Web Camera</b> is a device that allows you to record video or take photographs with your computer. You can use it for video chatting or video conferences using a communication tool such as <b>Windows Live Messenger</b>. <b>Camera Assistant Software</b> will help you to add various video effects to your video or photograph.</p> <p>Enables the transmission of video and use of video chat via the internet using specialized applications.</p> <p>The effective pixel count for this web camera is 1.92 million.</p> <p>Please refer to the <a href="#">Web Camera</a> section in Chapter 4, <i>Operating Basics</i>.</p> |
| <b>Web Camera LED</b>            | The Web Camera LED lights up when the Web Camera is operating.  |
| <b>Qosmio AV Controller</b>      | <p>This button allows you to operate the Media Center.</p> <p>Please refer to the <a href="#">Qosmio AV Controller</a> section in Chapter 8, <i>AV functions</i> for more information.</p>  |

---

**LCD Sensor switch** This switch senses when the display panel is either closed or opened and activates the Panel Power Off/On feature as appropriate. For example, when you close the display panel the computer enters Hibernation Mode and shuts itself down and then, when you next open the display, the computer will automatically start up and return you to the application you were previously working on.

You can specify within the Power Options. To access it, click **Start -> Control Panel -> System and Maintenance -> Power Options**.

---



*Do not put any magnetic objects close to this switch as they may cause the computer to automatically enter Hibernation Mode and shut down even if the Panel Power Off feature is disabled.*

---



**Volume control dial** Use this dial to adjust the volume of the internal stereo speakers and optional external stereo headphones (if connected).

Turn the dial clockwise to increase the volume and turn it counter-clockwise to decrease the volume.

---

**Microphone** A built-in microphone allows you to import and record sounds for your applications - please refer to the [Sound system](#) section in Chapter 4, [Operating Basics](#) for more information.

---

## System indicators

The LED system indicators for specific computer operations glow when those operations are in progress.



*System indicators*



**DC IN** The **DC IN** indicator normally glows blue when power is being correctly supplied from the AC power adaptor. However, If the output voltage from the adaptor is abnormal, or if the computer's power supply malfunctions, this indicator will flash orange.

---

**Power**

The **Power** indicator normally glows blue when the computer is turned on. However, if you turn the computer off into Sleep Mode, this indicator will flash orange - approximately one second on, two seconds off - both while the system is shutting down and while it remains turned off.

**Battery**

The **Battery** indicator shows the condition of the battery's charge - blue indicates the battery is fully charged, orange indicates the battery is charging, and flashing orange indicates a low battery condition. Please refer to Chapter 6, [Power](#) for more information on this feature.

**Hard Disk Drive**

The **Hard Disk Drive** indicator glows blue whenever the computer is accessing the built-in hard disk drive.

**Optical Disc Drive**

The **Optical Disc Drive** indicator glows blue when the computer is accessing a disc in the optical disc drive.

**Bridge media slot**

The **Bridge media slot** indicator glows blue when the computer is accessing the Bridge media slot.

**Wireless communication**

The **Wireless communication** indicator glows orange when the Bluetooth and wireless LAN functions are turned on.

All models are provided with a Wireless Communication switch although only some models are equipped with both Wireless LAN and Bluetooth functions.

## Keyboard indicators

The following figures show the positions of the CAPS LOCK indicator and the keypad overlay indicators which show the following conditions:

- When the CAPS LOCK indicator glows, the keyboard will produce capitals when any letter is typed.
- When the Arrow Mode indicator glows, the keypad overlay allows you to use cursor functions.
- When the Numeric Mode indicator glows, the keypad overlay allows you to enter numbers.

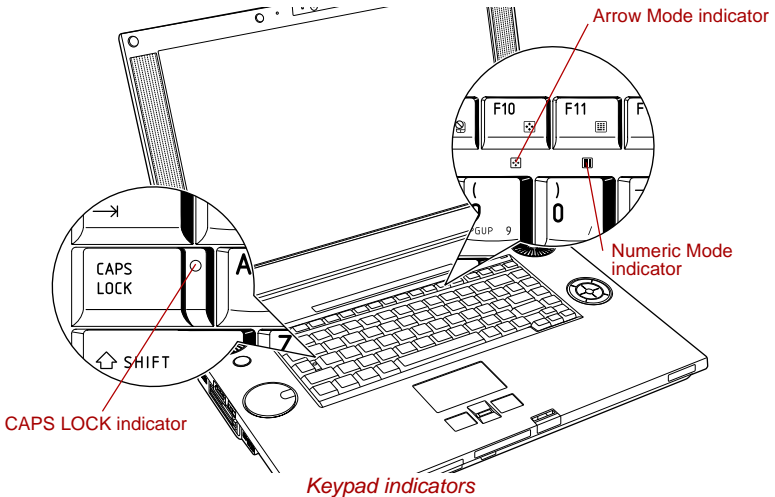

---

### CAPS LOCK

This indicator glows green when letter keys are locked into their uppercase format.



### Arrow Mode

When the **Arrow Mode** indicator lights green, you can use the gray labeled keys on the keypad overlay as cursor keys. Please refer to the [Keypad overlay](#) section in Chapter 5, [The Keyboard](#) for more information.



### Numeric Mode

When the **Numeric Mode** indicator lights green, you can use the gray labeled keys on the keypad overlay for number entry. Please refer to the [Keypad overlay](#) section in Chapter 5, [The Keyboard](#) for more information.

---

## Optical disc drives

One of the following optical disc drives is provided in the computer: HD DVD-ROM and HD DVD-R drives. This optical drive uses an ATAPI interface controller for CD and DVD operation and has an indicator at its front which will glow to indicate that it is in use.

For further information on loading and unloading discs, please refer to the [Using HD DVD-ROM drive and HD DVD-R drives](#) section in Chapter 4, *Operating Basics*.

### Region codes for DVD drives and media

HD DVD-ROM drive, HD DVD-R drives and their associated media are manufactured according to the specifications of six marketing regions. When you purchase DVD Video media you should ensure that it matches the specification of your drive, otherwise it will not play properly.

| Code | Region   |
|------|--|
| 1    | Canada, United States  |
| 2    | Japan, Europe, South Africa, Middle East   |
| 3    | South East Asia, East Asia   |
| 4    | Australia, New Zealand, Pacific Islands, Central America, South America, Caribbean |
| 5    | Russia, Indian Subcontinent, Africa, North Korea, Mongolia                         |
| 6    | China  |

### Writable discs

This section describes the types of writable CD, DVD and HD DVD media available, and should be used in conjunction with the specification of your computer/optical drive in order to understand the type of discs that can be written. Please refer to Chapter 4, [Operating Basics](#) for further information.

#### CDs

- CD-R media can only be written to once - the recorded data cannot subsequently be erased or changed.
- CD-RW media, including multi-speed CD-RW discs, high-speed CD-RW discs and ultra-speed CD-RW discs, can be recorded to more than once.

## DVDs

- DVD-R, DVD+R, DVD-R (Dual Layer) and DVD+R (Double Layer) media discs can only be written to once - the recorded data cannot subsequently be erased or changed.
- DVD-RW, DVD+RW and DVD-RAM media can be recorded to more than once.

## HD DVDs

- HD DVD-R and HD DVD-R (Dual Layer) media discs can only be written to once - the recorded data cannot subsequently be erased or changed.

## Formats

The drives support the following formats:

- |                        |                                    |  |
|------------------------|------------------------------------|--|
| ■ CD-ROM               | ■ CD-R                             | ■ Addressing Method 2                    |
| ■ DVD-ROM              | ■ CD-RW                            | ■ HD DVD-ROM (Single-sided Single-Layer) |
| ■ DVD-R                | ■ CD-DA                            | ■ HD DVD-ROM (Single-sided Dual-Layer)   |
| ■ DVD-R (Dual Layer)   | ■ CD-Text                          | ■ HD DVD (Twin format disc)              |
| ■ DVD-RW               | ■ CD-ROM XA Mode 2 (Form1, Form2)  | ■ HD DVD-Video                           |
| ■ DVD+R                | ■ CD-ROM Mode 1, Mode 2            |  |
| ■ DVD+R (Double Layer) | ■ Photo CD™ (single/multi-session) |  |
| ■ DVD+RW               | ■ Enhanced CD (CD-EXTRA)           |  |
| ■ DVD-RAM              |                                    |  |
| ■ DVD-Video            |                                    |  |



*Some types and formats of DVD-R (Dual Layer) and DVD+R (Double Layer) discs may be unreadable.*

## HD DVD-ROM drive

The full-size HD DVD-ROM module allows you to record data to recordable CD's and DVD's as well as run either 12cm (4.72") CD's, DVD's and HD DVD's, and 8cm (3.15") CD's and DVD's without using an adaptor.



*The speed is slower at the center of a disc and faster at the outer edge.*

|                                   |  |
|-----------------------------------|--|
| <b>HD DVD read</b>                | 1 speed (maximum)                        |
| <b>DVD read</b>                   | 8 speed (maximum)                        |
| <b>DVD-R write</b>                | 4 speed (maximum)                        |
| <b>DVD-R (Dual Layer) write</b>   | 2 speed (maximum)                        |
| <b>DVD-RW write</b>               | 4 speed (maximum)                        |
| <b>DVD+R write</b>                | 4 speed (maximum)                        |
| <b>DVD+R (Double Layer) write</b> | 2.4 speed (maximum)                      |
| <b>DVD+RW write</b>               | 4 speed (maximum)                        |
| <b>DVD-RAM write</b>              | 3 speed (maximum)                        |
| <b>CD read</b>                    | 24 speed (maximum)                       |
| <b>CD-R write</b>                 | 16 speed (maximum)                       |
| <b>CD-RW write</b>                | 10 speed (maximum,<br>Ultra-speed media) |

## HD DVD-R drive



*The optical drive installed on this computer cannot write multiple sessions on HD DVD-R Dual Layer disc sessions. Once a disc has been written to once, it will be finalized. Once finalized, no further writing to the disc will be possible regardless of what portion of the total disc capacity was used.*

The full-size HD DVD-R module allows you to record data to recordable CD's and DVD's as well as run either 12cm (4.72") CD's, DVD's and HD DVD's, and 8cm (3.15") CD's and DVD's without using an adaptor.



*The speed is slower at the center of a disc and faster at the outer edge.*

|                                    |  |
|------------------------------------|--|
| <b>HD DVD read</b>                 | 1 speed (maximum)                        |
| <b>HD DVD-R write</b>              | 1 speed (maximum)                        |
| <b>HD DVD-R (Dual Layer) write</b> | 1 speed (maximum)                        |
| <b>DVD read</b>                    | 8 speed (maximum)                        |
| <b>DVD-R write</b>                 | 4 speed (maximum)                        |
| <b>DVD-R (Dual Layer) write</b>    | 2 speed (maximum)                        |
| <b>DVD-RW write</b>                | 4 speed (maximum)                        |
| <b>DVD+R write</b>                 | 4 speed (maximum)                        |
| <b>DVD+R (Dual Layer) write</b>    | 2.4 speed (maximum)                      |
| <b>DVD+RW write</b>                | 4 speed (maximum)                        |
| <b>DVD-RAM write</b>               | 3 speed (maximum)                        |
| <b>CD read</b>                     | 24 speed (maximum)                       |
| <b>CD-R write</b>                  | 16 speed (maximum)                       |
| <b>CD-RW write</b>                 | 10 speed (maximum,<br>Ultra-speed media) |

## AC adaptor

The AC adaptor can automatically adjust to any voltage ranging from 100 to 240 volts and to a frequency of either 50 or 60 hertz, enabling you to use this computer in almost any country/region. The adaptor converts AC power to DC power and reduces the voltage supplied to this computer.

To recharge the battery, simply connect the AC adaptor to a power source and to the computer. Please refer to Chapter 6, [Power](#) for further information.

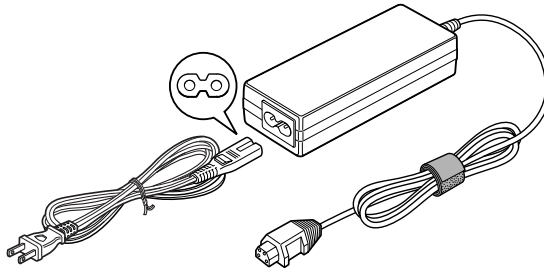

*The AC adaptor (2-pin plug)*

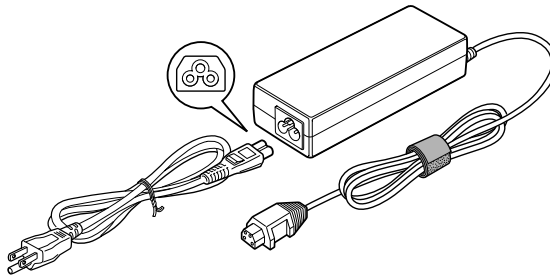

*The AC adaptor (3-pin plug)*



- Depending on the model in question, either a 2-pin or 3-pin adaptor/power lead will be bundled with the computer.
- Do not use a 3-pin to 2-pin conversion plug.
- The supplied power cord conforms to safety rules and regulations in the region the product is bought and should not be used outside of this region. In order to use the adaptor/computer in other regions, you should please buy a power cord that conforms to the safety rules and regulations in that particular region.



Always use the TOSHIBA AC adaptor that was provided with your computer and the TOSHIBA Battery Charger (that may have been provided with your computer), or use AC adaptors and battery chargers specified by TOSHIBA to avoid any risk of fire or other damage to the computer. Use of an incompatible AC adaptor or Battery Charger could cause fire or damage to the computer possibly resulting in serious injury.



# Chapter 3

## Getting Started

This chapter provides basic information to start using your computer. It covers the following topics:



- All users should be sure to read the section [Starting up for the first time](#).
- Be sure to read the enclosed *Instruction Manual for Safety and Comfort* for information on the safe and proper use of this computer. It is intended to help you be more comfortable and productive while using a notebook computer. By following the recommendations in it you may reduce your chance of developing a painful or disabling injury to your hand, arms, shoulders or neck.

- Connecting the AC adaptor
- Opening the display
- Turning on the power
- Starting up for the first time
- Turning off the power
- Restarting the computer
- System Recovery Options



- Use a virus-check program and make sure it is updated regularly.
- Never format storage media without checking its content. Formatting destroys all stored data.
- It is a good idea to periodically back up the internal hard disk drive or other main storage device to external media. General storage media is not durable or stable over long periods of time and under certain conditions may result in data loss.
- Before you install a device or application, save any data in memory to the hard disk drive or other storage media. Failure to do so may result in the loss of data.

## Connecting the AC adaptor

Attach the AC adaptor when you need to charge the battery or you want to operate from AC power. It is also the fastest way to get started, because the battery pack will need to be charged before you can operate from battery power.

The AC adaptor can be connected to any power source supplying from 100 to 240 volts and 50 or 60 hertz. For details on using the AC adaptor to charge the battery pack, refer to Chapter 6, [Power](#).



- *Always use the TOSHIBA AC adaptor that was provided with your computer and the TOSHIBA Battery Charger (that may have been provided with your computer), or use AC adaptors and battery chargers specified by TOSHIBA to avoid any risk of fire or other damage to the computer. Use of an incompatible AC adaptor or Battery Charger could cause fire or damage to the computer possibly resulting in serious injury. TOSHIBA assumes no liability for any damage caused by use of an incompatible adaptor or Battery Charger.*
- *Never plug the AC adaptor or Battery Charger into a power source that does not correspond to both the voltage and the frequency specified on the regulatory label of the unit. Failure to do so could result in a fire or electric shock, possibly resulting in serious injury.*
- *Always use or purchase power cables that comply with the legal voltage and frequency specifications and requirements in the country of use. Failure to do so could result in a fire or electric shock, possibly resulting in serious injury.*
- *The supplied power cord conforms to safety rules and regulations in the region the product is bought and should not be used outside this region. For use in other regions, please buy power cords that conform to safety rules and regulations in the particular region.*
- *Do not use a 3-pin to 2-pin conversion plug.*
- *When you connect the AC adaptor to the computer, always follow the steps in the exact order as described in the User's Manual. Connecting the power cable to a live electrical outlet should be the last step otherwise the adaptor DC output plug could hold an electrical charge and cause an electrical shock or minor bodily injury when touched. As a general safety precaution, avoid touching any metal parts.*
- *Never place your computer or AC adaptor on a wooden surface, furniture, or any other surface that could be marred by exposure to heat since the computer base and AC adaptor's surface increase in temperature during normal use.*
- *Always place your computer or AC adaptor on a flat and hard surface that is resistant to heat damage.*

*Refer to the enclosed Instruction Manual for Safety and Comfort for detailed precautions and handling instructions.*

1. Connect the power cord to the AC adaptor.

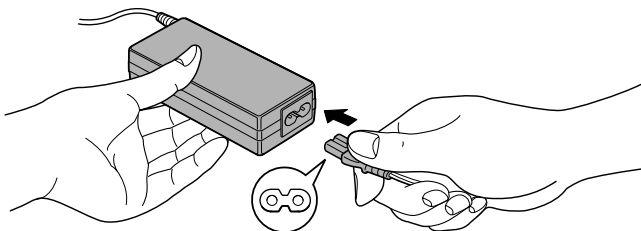

*Connecting the power cord to the AC adaptor (2-pin plug)*

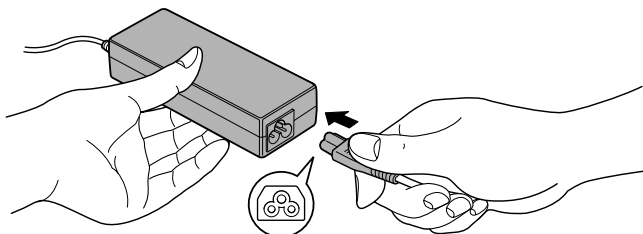

*Connecting the power cord to the AC adaptor (3-pin plug)*



*Either a 2-pin or 3-pin adaptor/cord will be included with the computer depending on the model.*

2. Connect the AC adaptor's DC output plug to the DC IN 15V jack on the back of the computer.

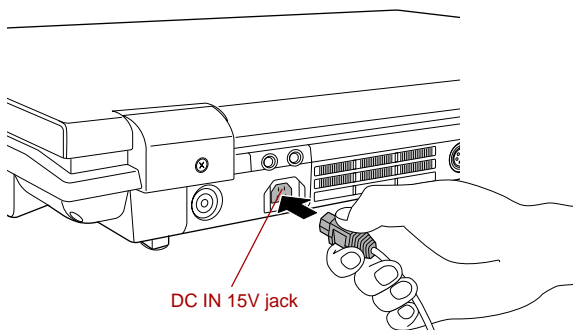

*Connecting the adaptor to the computer*

3. Plug the power cord into a live wall outlet - the **Battery** and **DC IN** indicators on the front of the computer should glow.

## Opening the display

The computer's display panel can be opened to a wide range of angles for optimal viewing.

1. Push the display latch on the front of the computer to unlatch the display panel.
2. While holding down the palm rest with one hand so that the main body of the computer is not raised, slowly lift the display panel - this will allow the angle of the display panel to be adjusted to provide optimum clarity.

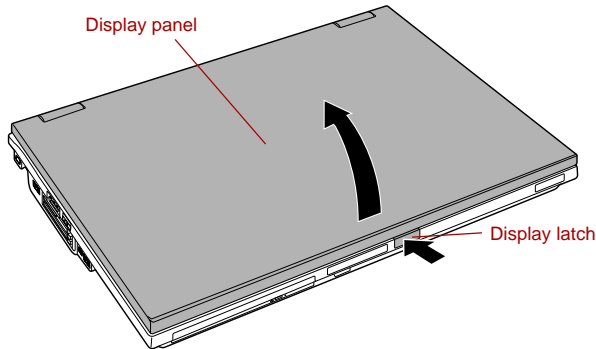

*Opening the display*



*Use reasonable care when opening and closing the display panel. Opening it vigorously or slamming it shut could damage the computer.*



- *As the display panel cannot be opened until 180 degrees, please be careful of the angle when flipping open the display panel.*
- *Be careful not to open the display panel too far as this could put stress on the display panel's hinges and cause damage.*
- *Do not press or push on the display panel.*
- *Do not lift the computer by the display panel.*
- *Do not close the display panel with pens or any other objects left in between the display panel and the keyboard.*
- *When opening or closing the display panel, place one hand on the palm rest to hold the computer in place and use the other hand to slowly open or close the display panel (Do not use excessive force when opening or closing the display panel).*

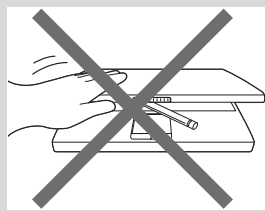
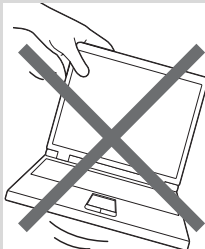
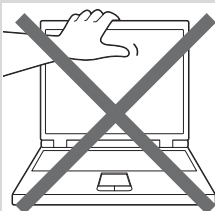

## Turning on the power

This section describes how to turn on the power - the **Power** indicator will then indicate the status. Please refer to the [Power indicators](#) section in Chapter 6, [Power](#) for more information.



- *After you turn on the power for the first time, do not turn it off until you have set up the operating system. Please refer to the section [Starting up for the first time](#) for more information.*
- *Volume cannot be adjusted during Windows Setup.*

1. Open the computer's display panel.
2. Press and hold the computer's power button for two or three seconds.

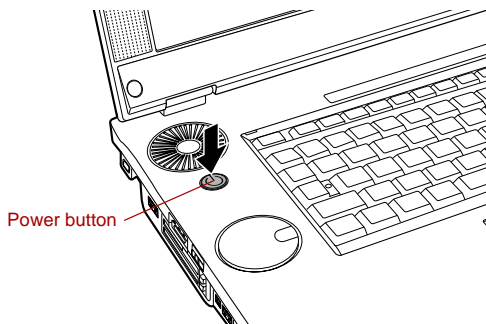

*Turning on the power*

## Starting up for the first time

The Microsoft Windows Vista™ Startup Screen will be the first screen displayed when you turn on the power. Follow the on-screen instructions on each screen in order to properly install the operating system.



*When it is displayed, be sure to read the **Software License Terms** carefully.*

## Turning off the power

The power can be turned off in one of three modes, either Shut Down (Boot) Mode, Hibernation Mode or Sleep Mode.

### Shut Down mode (Boot Mode)

When you turn off the power in Shut Down Mode no data will be saved and the computer will boot to the operating system's main screen the next time it is turned on.

1. If you have entered data, either save it to the hard disk drive or to other storage media.
2. Make sure all disk/disc activity has stopped before removing the CD/DVD/HD DVD or floppy disk.

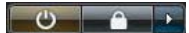

- *Make sure the **Hard Disk Drive** indicator is off. If you turn off the power while a disk (disc) is being accessed, you may lose data or damage the disk.*
- *Never turn off the power while an application is running. Doing so could cause loss of data.*
- *Never turn off the power, disconnect an external storage device or remove storage media during data read/write. Doing so can cause data loss.*

3. Click **Start**.
4. Click the arrow button (  ) located in the power management buttons (  ) and select **Shut Down** from the menu.
5. Turn off any peripheral devices connected to your computer.



*Do not turn the computer or peripheral devices back on immediately - wait a short period to avoid any potential damage.*

### Sleep Mode

If you have to interrupt your work, you are able to turn off the power without exiting from your software by placing the computer into Sleep Mode. In this mode data is maintained in the computer's main memory so that, when you turn on the power again, you can continue working right where you left off.



*Turning Off Your Computer where Electronic Devices are Regulated or Controlled.*

*When you have to turn off your computer aboard an aircraft or in places where electronic devices are regulated or controlled, always shut down the computer completely or put the computer into Hibernation Mode. Instead of allowing it to go into Sleep Mode and turn off any wireless communication switches or devices. While in Sleep Mode the computer operating system may reactivate itself to run pre-programmed tasks or to preserve unsaved data, and might interfere with aviation or other systems, possibly causing serious injury.*



- Before entering Sleep Mode, be sure to save your data.
- Do not install or remove a memory module while the computer is in Sleep Mode. The computer or the memory module could be damaged.
- Do not remove the battery pack while the computer is in Sleep Mode (unless the computer is connected to an AC power source). Data in memory could be lost.



- When the AC adaptor is connected, the computer will go into Sleep Mode according to the settings in the Power Options (to access it, **Start** -> **Control Panel** -> **System and Maintenance** -> **Power Options**).
- To restore the operation of the computer from Sleep Mode, press and hold the power button or any key on the keyboard for a short amount of time. Please note that keyboard keys can only be used if the Wake-up on Keyboard option is enabled within the HW Setup utility.
- If the computer enters Sleep Mode while a network application is active, the application might not be restored when the computer is next turned on and the system returns from Sleep Mode.
- To prevent the computer from automatically entering Sleep Mode, disable Sleep Mode within the Power Options (to access it, **Start** -> **Control Panel** -> **System and Maintenance** -> **Power Options**).
- To use the Hybrid Sleep function, configure it in the Power Options.

### **Benefits of Sleep Mode**

The Sleep Mode feature provides the following benefits:



- Restores the previous working environment more rapidly than does the Hibernation Mode feature.
- Saves power by shutting down the system when the computer receives no input or hardware access for the time period set by the System Sleep Mode feature.
- Allows the use of the panel power off feature.

### **Executing Sleep Mode**



You can also enable Sleep Mode by pressing **FN + F3** - please refer to Chapter 5, [The Keyboard](#), for further details.

You can enter Sleep Mode in one of four ways:

- Click **Start** then click the power button (  ) located in the power management buttons (  ).  
Please note that this feature must be enabled within the Power Options (to access it, click **Start** -> **Control Panel** -> **System and Maintenance** -> **Power Options**).
- Click **Start** then click the arrow button (  ) and select **sleep** from the menu.

- Close the display panel. Please note that this feature must be enabled within the Power Options (to access it, click **Start -> Control Panel -> System and Maintenance -> Power Options**).
- Press the power button. Please note that this feature must be enabled within the Power Options (to access it, click **Start -> Control Panel -> System and Maintenance -> Power Options**).

When you turn the power back on, you can continue where you left when you shut down the computer.



- *When the computer is in Sleep Mode, the **Power** indicator will blink orange.*
- *If you are operating the computer on battery power, you can lengthen the overall operating time by turning it off into Hibernation Mode - Sleep Mode will consume more power while the computer is off.*

### **Sleep Mode limitations**

Sleep Mode will not function under the following conditions:

- Power is turned back on immediately after shutting down.
- Memory circuits are exposed to static electricity or electrical noise.

### **Hibernation Mode**

The Hibernation Mode feature saves the contents of memory to the hard disk drive when the computer is turned off so that, the next time it is turned on, the previous state is restored. Please note that the Hibernation Mode feature does not save the status of any peripheral devices connected to the computer.



- *Save your data. While entering Hibernation Mode, the computer saves the contents of memory to the hard disk drive. However, for safety sake, it is best to save your data manually.*
- *Data will be lost if you remove the battery or disconnect the AC adaptor before the save is completed. Wait for the **Hard Disk Drive** indicator to go out.*
- *Do not install or remove a memory module while the computer is in Hibernation Mode. Data will be lost.*

### **Benefits of Hibernation Mode**

The Hibernation Mode feature provides the following benefits:

- Saves data to the hard disk drive when the computer automatically shuts down because of a low battery condition.
- You can return to your previous working environment immediately when you turn on the computer.
- Saves power by shutting down the system when the computer receives no input or hardware access for the time period set by the System Hibernate feature.
- Allows the use of the panel power off feature.



## Starting Hibernation Mode



You can also enable Hibernation Mode by pressing **FN + F4** - please refer to Chapter 5, [The Keyboard](#), for further details.

To enter Hibernation Mode, follow the steps below.

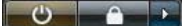
1. Click **Start**.
2. Click the arrow button (  ) in the power management buttons (  ) and select **Hibernate** from the menu.

## Automatic Hibernation Mode

The computer can be configured to enter Hibernation Mode automatically when you press the power button or close the lid. In order to define these settings, you can follow the steps as described below:

1. Click **Start** and click the **Control Panel**.
2. Click **System and Maintenance** and click **Power Options**.
3. Click **Choose what the power button does** or **Choose what closing the lid does**.
4. Enable the desired Hibernation Mode settings for **When I press the power button** and **When I close the lid**.
5. Click the **Save changes** button.

## Data save in Hibernation Mode

When you turn off the power in Hibernation Mode, the computer will take a moment to save the current data in memory to the hard disk drive. During this time, the **Hard Disk Drive** indicator will glow.

After you turn off the computer, and the content of memory has been saved to the hard disk drive, turn off the power to any peripheral devices.



*Do not turn the computer or devices back on immediately. Wait a moment to let all capacitors fully discharge.*

## Restarting the computer

Certain conditions require that you reset the computer, for example if:

- You change certain computer settings.
- An error occurs and the computer does not respond to your keyboard commands.

If you need to restart the computer, there are three ways this can be achieved:

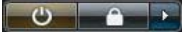
- Click **Start** then click the arrow button (  ) in the power management buttons (  ) and select **Restart** from the menu.
- Press **CTRL, ALT** and **DEL** simultaneously (once) to display the menu window, then select **Restart** from the **Shut down options**.
- Press the power button and hold it down for five seconds. Once the computer has turned itself off, wait between ten and fifteen seconds before turning the power on again by pressing the power button.

## System Recovery Options

About 1.5 GB hidden partition is allocated on the hard disk drive for the System Recovery Options.

This partition stores files which can be used to repair the system in the event of a problem.



*The System Recovery Options feature will be unusable if this partition is deleted.*

### System Recovery Options

The System Recovery Options feature is installed on the hard disk when shipped from the factory. The System Recovery Options menu includes tools to repair startup problems, run diagnostics or restore the system.

See the **Windows Help and Support** content for more information about **Startup Repair**.

The System Recovery Options can also be run manually to repair problems.

The procedure is as follows. Follow the instructions shown on the on-screen menu.

1. Turn off the computer.
2. While holding the **F8** key, turn on the computer.
3. The **Advanced Boot Options** menu will be displayed.  
Use the arrow keys to select **Repair Your Computer** and press **ENTER**.
4. Follow the on-screen instructions.

The Windows Vista™ CompletePC Backup feature can be used on Windows Vista™ Business Edition and Ultimate Edition.

# Chapter 4

## Operating Basics

This chapter describes the basic operations of your computer, highlights the precautions that should be taken when using it, and details the considerations that should be made when handling CD/DVD/HD DVD media.

### Using the Touch Pad

To use the Touch Pad, simply touch and move your fingertip across it in the direction you want the on-screen pointer to go.

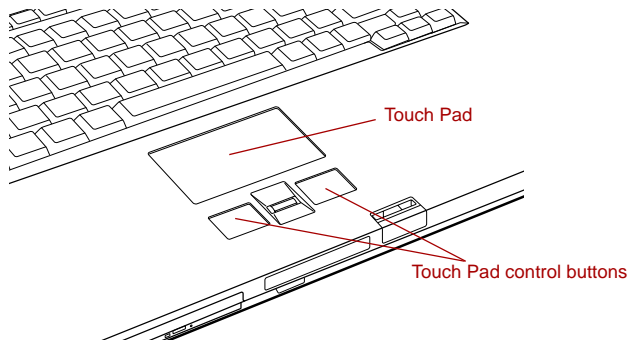

*Touch Pad and Touch Pad control buttons*

The two buttons below the Touch Pad are used like the buttons on a standard mouse - press the left button to select a menu item or to manipulate text or graphics designated by the pointer, and press the right button to display a menu or other function depending on the software you are using.



*You can also tap the Touch Pad to perform functions similar to those of the left button on a standard mouse.*

**Click:** Tap once

**Double-click:** Tap twice

**Drag and drop:** Tap to select the item(s) you want to move, leave your finger on the Touch Pad after the second tap and then move the item(s) to their new destination.

## AV Controller

The following functions are available in this computer for operating the Media Center.

This section describes an overview of each function. Please refer to the [Qosmio AV Controller](#) section in Chapter 8, *AV functions* for more information.

- Front operation panel
- Qosmio AV Controller
- Remote Controller

### Front operation panel

The Front operation panel is located above the keyboard.

AV related functions, such as TV, CD/DVD, Play/Pause, Stop, Previous, Next, Record, Illumination On/Off and DOLBY are available.

### Qosmio AV Controller

The Qosmio AV Controller is located at the right of the keyboard.

Buttons in the inner circle of Qosmio AV Controller are the Arrow buttons and OK button.

Buttons in the outer circle are the More info button, Back button and Fast move buttons.



- *The inner button group (Arrow buttons and OK button) and the outer button group (More info button, Back button, Fast move buttons) cannot function at the same time. If both the inner and outer button groups are pressed simultaneously, the outer buttons will function.*
- *If a function of either button group is operating, functions of the other button group will not function.*

## Setting Qosmio AV Controller

The Qosmio AV Controller Manager is used to change the settings of the Qosmio AV Controller functions and the Front operation panel.

To access this utility, click **Start -> All Programs -> TOSHIBA -> Utilities -> Qosmio AV Controller Manager**.

- **ON/OFF setting of Qosmio AV Controller**  
Select the “Enable Qosmio AV Controller” check box to enable (ON) the functions of the Qosmio AV Controller and the Front operation panel. Deselect the check box to disable (OFF) the functions of the Qosmio AV Controller and the Front operation panel. The default is ON.
- **LED ON/OFF setting**  
Select the “Turn on LED” check box to always turn on (light up) LEDs. When buttons are pressed, the LEDs of these buttons will turn off. Deselect the check box to always turn off LEDs. When buttons are pressed, the LEDs of these buttons will light up. The default is ON.
- **Click volume setting**  
Use the slider to change the click volume of the Qosmio AV Controller and the Front operation panel.
- **Sensitivity setting**  
Use the slider to change the sensitivity of the Qosmio AV Controller and the Front operation panel.
- **Scroll speed setting**  
Use the slider to change the cursor moving speed of the Fast move buttons.

## Remote Controller

Provided with all models. It can operate AV related functions.

## Using the Fingerprint Sensor

This product has a fingerprint utility installed for the purpose of enrolling and recognizing fingerprints. By enrolling the ID and password onto the fingerprint authentication feature, it is no longer necessary to input the password from the keyboard. Fingerprint feature enables you to:

- Logon to Windows and access a security enabled homepage through Internet Explorer.
- Files and folders can be encrypted/decrypted and third party access to them prevented.
- Disable the password-protected screen-saver when returning from a power-saving mode such as Sleep Mode.
- Authentication of the User Password (and, if applicable, the HDD(Hard Disk Drive) Password) when booting up the computer (Power-on Security).
- Single Sign-on facility

## How to Swipe the Finger

Using the following steps when swiping fingers for fingerprint registration or authentication will help to minimize authentication failures:

Align the first joint of the finger at the center of the sensor, then lightly touch the sensor and swipe finger horizontally towards you until the sensor surface becomes visible. In performing this process, you should also take care to ensure that the center of your fingerprint is on the sensor.

The following illustrations show the recommended way to swipe your finger over the fingerprint sensor.

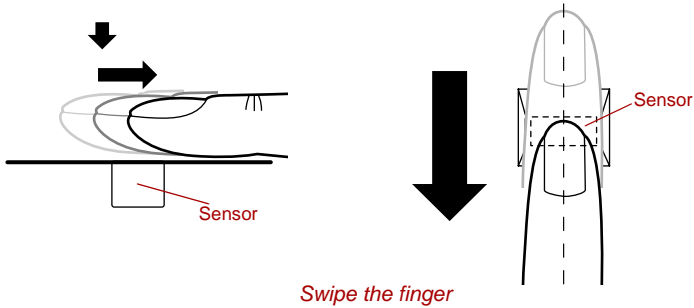

*Swipe the finger*



- *Avoid swiping with your finger stiff or pressed too hard onto the sensor, and take care to ensure that the center of the fingerprint is touching the sensor before swiping. Either of these conditions may cause fingerprint reading to fail.*
- *Check the center of the fingerprint whirl before swiping and then ensure this is swiped along the center line of the sensor.*
- *There is a possibility of authentication failures if the finger is swiped too quickly or too slowly - follow any on-screen instructions to adjust the speed used during the swipe process.*

## Points to note about the Fingerprint Sensor

Please be aware of the following considerations when using the fingerprint sensor. A failure to follow these guidelines might result in damage to the sensor, sensor failure, fingerprint recognition problems or a lower fingerprint recognition success rate.

- Do not scratch or poke the sensor with your nails or any hard or sharp objects.
- Do not press the sensor strongly.
- Do not touch the sensor with a wet finger or any wet objects - keep the sensor surface dry and free from water vapor.
- Do not touch the sensor with a soiled or dirty finger as minute foreign particles of dust and dirt may scratch it.
- Do not paste stickers or write on the sensor.
- Do not touch the sensor with a finger or any other object which may have a build-up of up static electricity on it.

Observe the following before you place your finger on the sensor whether for fingerprint enrollment/registration or recognition.

- Wash and dry your hands thoroughly.
- Remove static electricity from your fingers by touching any metal surface. Static electricity is a common cause of sensor failures, especially when the weather is dry.
- Clean the sensor with a lint-free cloth - do not use detergent or any other chemicals to clean the sensor.
- Avoid the following finger conditions for enrollment or recognition as they may result in fingerprint enrollment errors or a drop in the fingerprint recognition success rate
  - Soaked or swollen finger, for example as may occur after taking a bath.
  - Injured finger
  - Wet finger
  - Soiled or oily finger
  - Extremely dry skin condition on finger

Observe the following to improve the fingerprint recognition success rate.

- Enroll two or more fingers.
- Enroll additional fingers if a recognition failure often occurs when using already enrolled fingers.
- Check the condition of your finger - any conditions which have changed since enrollment, such as injury, rough skin, and extremely dry, wet, soiled, dirty, oily, soaked or swollen fingers, may lower the recognition success rate. Also if the fingerprint is worn down or the finger becomes thinner or fatter, the recognition success rate may be lowered.
- As the fingerprint for each finger is different and unique you should ensure that only the registered or enrolled fingerprint or fingerprints are used for identification.

- Check the position and speed at which you slide your finger across the sensor - please refer to the preceding drawing.
- The fingerprint sensor compares and analyzes the unique characteristics in a fingerprint. However, there may be instances where certain users are unable to register their fingerprints due to insufficient unique characteristics in their fingerprints.
- The recognition success rate may differ from user to user.

### ***How to Delete the Fingerprint Data***

Saved fingerprint data is stored in special non-volatile memory inside the fingerprint sensor. Therefore, if you give the computer to someone else, or dispose of it in any way, the following process is recommended to delete your fingerprint information:

1. To run this program, click **Start -> All Programs -> Protector Suite QL -> Control Center**.
2. The **Protector Suite Software** screen is displayed.
3. Click **Fingerprints** and click **Delete**.
4. Click **Settings** and click **Fingerprint Storage Inspector**.
5. The **Fingerprint Storage Inspector** screen will be displayed.  
If fingerprint data is displayed as part of the list, simply select all of this information and then **Remove**.
6. Check whether all of the fingerprint data was deleted on the **Fingerprint Storage Inspector** screen.

In use, please be aware of the following limitations of the fingerprint sensor:

- A warning message will be displayed when recognition is abnormal or recognition is not successful within a fixed duration.
- The fingerprint sensor compares and analyzes the unique characteristics in a fingerprint. However, there may be instances where certain users are unable to register their fingerprints due to insufficient unique characteristics in their fingerprints.
- The recognition success rate may differ from user to user.
- Toshiba does not guarantee that this fingerprint recognition technology will be error-free.
- Toshiba does not guarantee that the fingerprint sensor will recognize the enrolled user or accurately screen out unauthorized users at all times. Toshiba is not liable for any failure or damage that might arise out of the use of this fingerprint recognition software or utility.



## Points to note about the Fingerprint Utility software



*You are able to backup saved fingerprint data and information within the PasswordBank by using the Import or Export User Data facility under the fingerprint management software. However, please be aware that any encrypted files cannot be backup within FileSafe using this function - in these instances it is recommended that you backup these files to external media using standard file copy processes.*

The Encrypting File System (EFS) is a Windows Vista™ feature.

If a file is encrypted using EFS, it cannot be encrypted further using the fingerprint authentication function.

In the Help File, it is stated that this software's PasswordBank function can be used for managing security relating to the Internet as well as for general applications. However, please be aware that the Internet PasswordBank function within the fingerprint utility provided on this computer can only be used with Microsoft's Internet Explorer software.

## Set Up Procedure

Please use the following procedure when first using fingerprint authentication.

### **Fingerprint Registration**

You should initially enroll the required authentication data using the **User Enrollment Wizard**.



- *In use, the fingerprint authentication system will use the same username and password as defined within the Windows operating system. If no Windows password has been configured, you must do this before starting the fingerprint registration process.*
- *Up to twenty-one fingerprint patterns can be registered on this sensor.*

1. To run this program, click **Start -> All Programs -> Protector Suite QL -> User Enrollment**.



*You are also able to start the User Enrollment Wizard by using the following methods.*

- *Click the Protector Suite QL icon in the Task Bar.*
- *Swipe your finger across the Fingerprint Sensor.*

2. Click **Next**.
3. At the **User's Password** screen which is then displayed, you should ensure that the same Windows username is displayed before entering the appropriate password into the **Enter your password** field. Once this has been done, click **Next**.
4. At the **Hints for Fingerprint Enrollment** screen, confirm the message displayed and ensure that there is a check mark in the **Run Interactive Tutorial** box. Once this has been done, click **Next**.

5. At the **Correct Swipe Procedure** screen, confirm the message that is displayed and then click **Next**.
6. At the **Scanning Practice** screen, you are able to practice swiping your finger to ensure you use the correct method. Once you have finished practicing, click **Next**.
7. At the **User's Fingers** screen, select the finger that you wish to enroll from the illustration and then click **Next**. On this screen please be aware that any previously enrolled fingerprints would have green check marks, while the fingerprint that you are about to enroll will have a red check mark. If any of the previously enrolled fingerprints is selected again, the latest information will be enrolled and any previous information over-written.
8. At **Advanced Security** screen, select whether you wish to enable the security function, and then click **Next**.
9. At **Finalization** screen, click **Finish** - this will complete the fingerprint registration process.

## Windows Logon via Fingerprint Authentication

If required, you are also able to use fingerprint authentication in place of the usual Windows logon process using your username and password. This method is especially useful where there are many users using the same computer as it removes the need for actual user selection when the system is started.

### ***Fingerprint Authentication Procedure***

1. Start up the computer.
2. At the **Logon Authorization** screen, choose any of the enrolled fingers and swipe the fingerprint on the sensor - if the authentication process is successful, the user will automatically be logged in to Windows.



*If the fingerprint authentication process fails you will need to log into Windows using the appropriate username and password. In addition, you should use this manual login process if fingerprint authentication fails for three consecutive tries - a warning message will be displayed when authentication is not normal or is not successful within a fixed duration.*

## Fingerprint Power-on Security

### General

The fingerprint authentication system can be used to replace the keyboard based password authentication system that is used when the computer is turned on.

If you do not want to use the fingerprint authentication system for password authentication when the computer is turned on, but instead prefer to use the keyboard entry method instead, simply press the **BACK SPACE** key when the Fingerprint Power-on Security screen is displayed. Using this process will switch the password input screen across to the keyboard based entry screen.



- *You must ensure that you use the TOSHIBA Password Utility to register a User Password before using the Fingerprint Power-on Security and its extended function to allow fingerprints to be used to access the computer when it is turned on.*
- *If the fingerprint authentication process fails five times, a preset time limit is exceeded, or you press the **BACK SPACE** key, [Password =] will be displayed on the screen and you will have to enter either the User Password or Supervisor Password manually in order to start the computer.*
- *When swiping your finger, please ensure that you do it slowly and at a constant speed. If you find that this does not improve the authentication rate, you should try to adjust the speed at which the finger is swiped.*
- *If there are any changes in the environment or settings related to authorization, you will be required to provide authorization information such as a User Password (and, if applicable, the HDD(Hard Disk Drive) password).*

### How to Enable Fingerprint Power-on Security Settings

It is necessary to first enroll your fingerprint with the Protector Suite QL application prior to enabling and configuring the Fingerprint Power-on Security System. You should check that your fingerprint is enrolled before configuring the settings (please refer to the Manual for Fingerprint Registration/Enrollment for further instructions).

1. Swipe your finger across the fingerprint sensor.
2. MENU will appear in the lower right corner of the screen. Swipe your finger on the fingerprint sensor and then select Control Center from the items presented in this menu.
3. At the **Fingerprint Software Management** screen, click **Settings** and then click **Power-on Security**.
4. At the **Power-on Security** screen, place a check mark in the Replace the power-on and hard disk drive passwords with the fingerprint sensor setting and then click **OK**.

## Fingerprint Single Sign-on Feature

### General

This is a feature that allows the user to complete the authentication for both the User/BIOS Password and logging onto Windows using only one fingerprint authentication when booting up. It is necessary to register the User/BIOS Password and Windows Logon Password before using the Fingerprint Power-on Security and this Fingerprint Single Sign-on Feature. Please use the TOSHIBA Password Utility to register your User/BIOS Password. If Windows Logon is not the default for your system, see Manual to register your Windows Logon Password.

Only one fingerprint authentication is required to replace the User/BIOS Password and the Windows Logon Password.

### How to Enable Fingerprint Single Sign-on Feature

It is necessary to first enroll your fingerprint with the Protector Suite QL application prior to enabling and configuring the Fingerprint Single Sign-on feature. You should check that your fingerprint is enrolled before configuring the settings (please refer to the Manual for Fingerprint Registration/Enrollment for further instructions).

1. Swipe your finger across the fingerprint sensor.
2. MENU will appear in the lower right corner of the screen. Swipe your finger on the fingerprint sensor and then select Control Center from the items presented in this menu.
3. At the **Fingerprint Software Management** screen, click **Settings** and then click **System Settings**.
4. At the **Protector Suite Settings** screen, place a check mark in the Allow power-on security single sign-on setting within Enable logon support and then click **OK**.

### Fingerprint utility limitations

TOSHIBA does not guarantee that the fingerprint utility technology will be completely secure or error-free, or that it will accurately screen out unauthorized users at all times. TOSHIBA is not liable for any failure or damage that might arise out of the use of the fingerprint software.



- *The fingerprint sensor compares and analyzes the unique characteristics in a fingerprint. However, there may be instances where certain users are unable to register their fingerprints due to insufficient unique characteristics in their fingerprints.*
- *The recognition success rate may differ from user to user.*

## Web Camera

**Web Camera** is a device that allows you to record video or take photographs with your computer. You can use it for video chatting or video conferences using a communication tool such as **Windows Live Messenger**. **Camera Assistant Software** will help you to add various video effects to your video or photograph.

Enables the transmission of video and use of video chat via the internet using specialized applications.

The effective pixel count for this web camera is 1.92 million.

Please refer to the Camera Assistant Software Online Help for details.

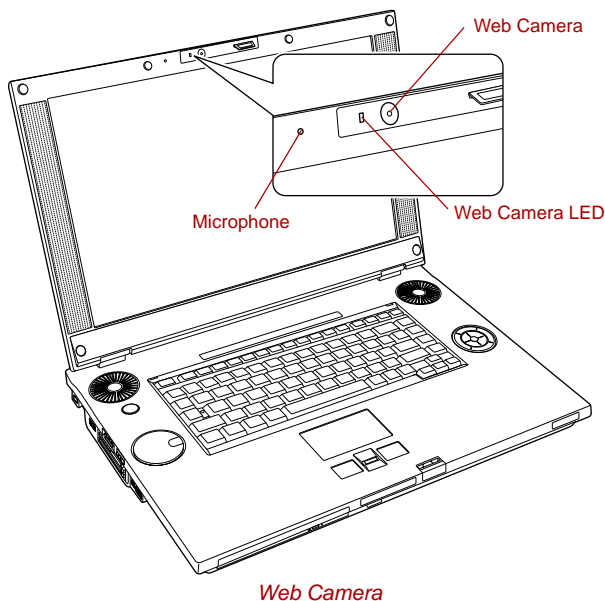



- Do not point the web camera directly at the sun.
- Do not touch or press strongly on the web camera lens. Doing so may reduce image quality. Use an eyeglass cleaner (cleaner cloth) or other soft cloth to clean the lens if it becomes dirty.
- Setting the [Size] to more than “800x600” will cause a larger amount of data to be written to the hard disk drive and may interfere with smooth recording.
- When recording in dimly lit environments, the following procedure can be used to select “Night Mode” which allows for brighter images with less noise.
  1. Click the **Properties** button on the [Web Camera] menu.
  2. Check **Night Mode** on the [Options] tab.
  3. Click the **OK** button.

The number of frames per second is lowered when “video recording” in “Night Mode”. This may result in the playback of the recorded video file seeming unsmooth.

## Using HD DVD-ROM drive and HD DVD-R drives

This section describes the features and use of HD DVD-ROM drive and HD DVD-R drives.



Please refer to the included Qosmio HD DVD Guide for more information on using the HD DVD-ROM drive and HD DVD-R drives.

This computer is equipped with a full-size HD DVD-ROM drive or a HD DVD-R drive module that lets you record data to rewritable CD/DVDs as well as run 12cm (4.72") CD/DVD/HD DVDs and 8cm (3.15") CD/DVDs without using an adaptor.



You should use the HD DVD playback software in order to view HD DVD Video media.

If you have a HD DVD-ROM drive or a HD DVD-R drive, please also refer to the [Writing CD/DVD/HD DVDs on HD DVD-R drives](#) section for precautions on writing to CD's, DVD's and HD DVD's.

If you have a HD DVD-ROM drive or a HD DVD-R drive, please refer to the Qosmio HD DVD Guide for playback to HD DVD.

## Loading discs

To load CD/DVD/HD DVD's, follow the steps as listed below.

1. When the computer's power is on, press the eject button to open the disc tray slightly.

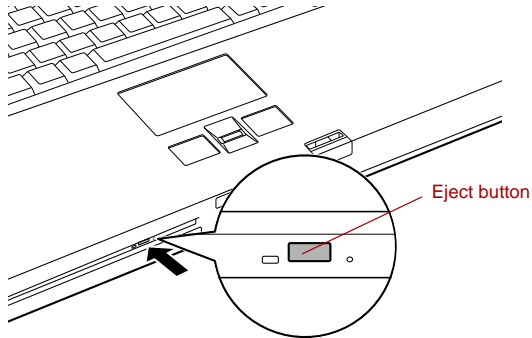

*Pressing the eject button*

2. Grasp the disc tray gently and pull until it is fully opened.

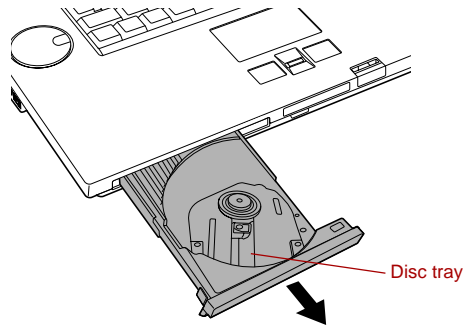

*Pulling the disc tray open*

3. Lay the CD/DVD/HD DVD, label side up, in the disc tray.

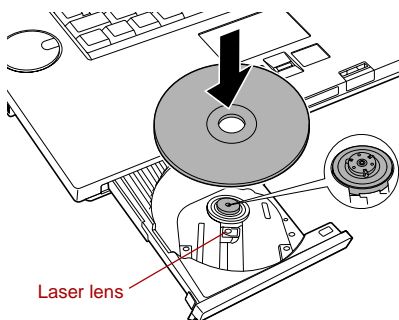

*Inserting a CD/DVD/HD DVD*



*When the disc tray is fully opened, the edge of the computer will extend slightly over the area where you insert the media. Therefore, when loading a CD, DVD, or HD DVD you will need to turn it slightly at an angle when you place it in the disc tray. After loading the CD/DVD/HD DVD you should ensure that it is properly positioned over the central spindle and that it lies flat within the tray.*



- *Do not touch either the laser lens or the area immediately around it - doing so could cause misalignment and may damage the drive.*
- *Make sure that no foreign objects are inserted into or otherwise enter the drive.*  
*Check the disc tray, especially the area behind the front edge, to ensure that there are no foreign objects or material present before closing the drive.*

4. Press the center of the CD/DVD/HD DVD gently until you feel it click into place on the center spindle. The disc should be slightly below the top of the spindle and flush with the spindle base.
5. Press the center of the disc tray in order to close it - the tray will click into place when it is locked.



*If the CD/DVD/HD DVD is not seated properly when the disc tray is closed, you may find that the media itself might become damaged, and/or the disc tray might not open fully when you next press the eject button.*

## Removing discs

To remove CD/DVD/HD DVD's, follow the steps as listed below.



*Do not press the eject button while the computer is accessing the media in the drive, instead wait for the indicator to go out before you open the disc tray. In addition, if the CD/DVD/HD DVD media is spinning when you open the tray, wait for it to fully stop before you remove it.*

1. When the computer's power is on, press the eject button to open the disc tray slightly and then gently pull it out of the system until it is fully opened.



*After the disc tray has opened slightly, you should wait for a moment to ensure the CD/DVD/HD DVD media has stopped spinning before you fully open the tray.*



- The CD/DVD/HD DVD media will extend slightly over the sides of the disc tray in order that you can hold it. Grasp it carefully by its edges and lift it vertically off of the central spindle and out of the tray.

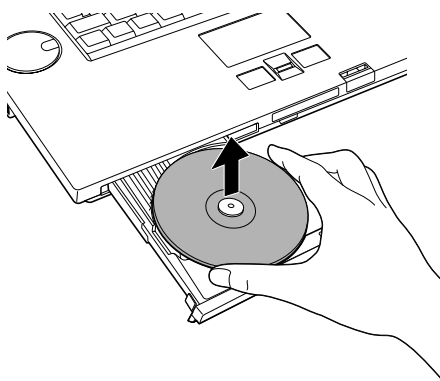

*Removing a CD/DVD/HD DVD*

- Press the center of the disc tray in order to close it - the tray will click in place when it is locked.

### How to remove a CD/DVD/HD DVD when the disc tray will not open

Pressing the eject button will not open the disc tray when the computer is turned off although, in these circumstances, you can open the tray by inserting a slender object such as a straightened paper clip about 15mm into the eject hole just to the right of the drive's eject button.

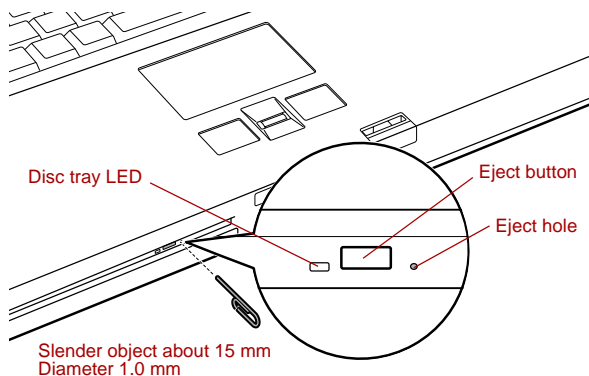

*Manual release with the eject hole*



*You must ensure that you turn off the power before you use the eject hole. If the CD/DVD/HD DVD media is spinning when you open the disc tray, it may fly off of the spindle and cause injury.*

## HD DVD

This section describes the features and use of HD DVD.



*Please refer to the included Qosmio HD DVD Guide for more information on the HD DVD.*

### Summary

HD DVD allows users to enjoy video, concerts and other packaged content by taking advantage of its large amount of storage space and high-quality audio and video. HD DVD also allows for the storage of long video when combined with the latest video compression technologies.

The storage capacity and data transfer rate of HD DVD is superior to standard DVD, with two types of playback-only discs in single-sided single-layer 15GB and single-sided dual-layer 30GB (Gigabyte) formats.



- *Unfinalized DVDs created on home DVD recorders may not be playable on the computer.*
- *When inserting an unfinalized DVD-R DL disc into the computer, Windows Vista™ may automatically finalize the disc and prevent further writing.*

### HD DVD Media

- Like CD and DVD, HD DVD is divided into the read-only and recordable formats listed below.
- Some media cannot be used with this product. Be sure to thoroughly read section the HD DVD-ROM drive, Chapter 2, before using this product.
- HD DVD-Video: For video playback. Used to store movies and other video.
- HD DVD-ROM: Read-only media.
- HD DVD-R: A recordable media which can be written to only once.
- HD DVD (Twin format disc): Has both HD DVD and DVD recordable layers.

## Media Structures and Capacity

| HD DVD                    |                              |          |
|---------------------------|------------------------------|----------|
| Recordable Surface        | Recordable Layer Structure   | Capacity |
| Single-sided Single-Layer | HD DVD Recordable Layer Only | 15GB     |
| Single-sided Dual-Layer   | HD DVD Recordable Layer Only | 30GB     |
| Double-sided Single-Layer | HD DVD Recordable Layer Only | 30GB     |
| Double-sided Dual-Layer   | HD DVD Recordable Layer Only | 60GB     |
| HD DVD (Twin format disc) |                              |          |
| Recordable Surface        | Recordable Layer Structure   | Capacity |
| Single-sided Dual-Layer   | HD DVD Recordable Layer      | 15GB     |
|                           | DVD Recordable Layer         | 4.7GB    |

## Writing CD/DVD/HD DVDs on HD DVD-R drives



*The optical drive installed on this computer cannot write multiple sessions on HD DVD-R Dual Layer disc sessions. Once a disc has been written to once, it will be finalized. Once finalized, no further writing to the disc will be possible regardless of what portion of the total disc capacity was used.*

You can use the HD DVD-R drive to write data to either CD-R, CD-RW, DVD-R, DVD-R (Dual Layer), DVD-RW, DVD+R, DVD+R (Double Layer), DVD+RW, DVD-RAM, HD DVD-R or HD DVD-R (Dual Layer) discs.

TOSHIBA Disc Creator and Ulead DVD MovieFactory are provided as writing software with this computer.



- Please refer to the [Writable discs](#), Chapter 2 for details about the types of writable CD, DVD and HD DVD discs that can be supported by this computer.
- Do not turn off the power to the optical disc drive while the computer is accessing it as this may cause you to lose data.
- CD-R/RW media cannot be accessed using the **Create CD/DVD** option in Media Center.
- To write data to CD-R/-RW media, use the **TOSHIBA Disc Creator** feature that is installed on your computer.



*When writing information to media using an optical drive, you should always ensure that you connect the AC adaptor to a live power socket. It is possible that, if data is written while powered by the battery pack, the write process may sometimes fail due to low battery power - in these instances data loss may occur.*

## Important message

Before you write or rewrite to any of the media supported by the HD DVD-R drive, please read and follow all of the setup and operating instructions in this section. If you fail to do so, you may find that the HD DVD-R drive may not function properly, and you may fail to write or rewrite information successfully - this may cause you to either lose data or incur other damage to the drive or media.

## Legal Footnotes

TOSHIBA does not bear responsibility for the following:

- Damage to any CD-R, CD-RW, DVD-R, DVD-R (Dual Layer), DVD-RW, DVD+R, DVD+R (Double Layer), DVD+RW, DVD-RAM or HD DVD-R disc that may be caused by writing or rewriting with this product.
- Any change or loss of the recorded contents of CD-R, CD-RW, DVD-R, DVD-R (Dual Layer), DVD-RW, DVD+R, DVD+R (Double Layer), DVD+RW, DVD-RAM or HD DVD-R media that may be caused by writing or rewriting with this product, or for any business profit loss or business interruption that may be caused by the change or loss of the recorded contents.
- Damage that may be caused by using third party equipment or software.

Given the technological limitations of current optical disc writing drives, you may experience unexpected writing or rewriting errors due to disc quality or problems with hardware devices. In view of this, it is good practice to make two or more copies of important data, in case of any undesired change or loss of the recorded contents.

## Before writing or rewriting

- Based on TOSHIBA's limited compatibility testing, we suggest the following manufacturers of CD-R, CD-RW, DVD-R, DVD-R (Dual Layer), DVD-RW, DVD+R, DVD+R (Double Layer), DVD+RW, DVD-RAM, HD DVD-R (Single Layer) or HD DVD-R (Dual Layer) media, however, it must be noted that disc quality can affect write or rewrite success rates. Please also be aware that in no event does TOSHIBA guarantee the operation, quality or performance of any disc.

---

### CD-R:

TAIYO YUDEN CO., LTD.  
MITSUBISHI CHEMICAL CORPORATION  
RICOH Co., Ltd.

---

### CD-RW: (Multi-Speed and High-Speed)

MITSUBISHI CHEMICAL CORPORATION  
RICOH Co., Ltd.

---

### CD-RW: (Ultra-Speed)

MITSUBISHI CHEMICAL CORPORATION

---

### DVD-R:

**DVD Specifications for Recordable Disc for General Version 2.0**  
TAIYO YUDEN CO., LTD.  
Matsushita Electric Industrial Co., Ltd

---

### DVD-R (Dual Layer):

MITSUBISHI CHEMICAL CORPORATION

---

### DVD+R:

MITSUBISHI CHEMICAL CORPORATION  
RICOH Co., Ltd.

---

### DVD+R (Double Layer): (Double Layer Recordable drive only)

MITSUBISHI CHEMICAL CORPORATION

---

### DVD-RW:

**DVD Specifications for Recordable Disc for Version 1.1 or version 1.2**  
VICTOR COMPANY OF JAPAN.LIMITED  
MITSUBISHI CHEMICAL CORPORATION

---

### DVD+RW:

MITSUBISHI CHEMICAL CORPORATION  
RICOH Co., Ltd.

---

**DVD-RAM:****DVD Specifications for DVD-RAM Disc for Version 2.0, Version 2.1 or Version 2.2**

Matsushita Electric Industrial Co., Ltd.  
Hitachi Maxell Ltd.

**HD DVD-R (Single Layer):**

MITSUBISHI CHEMICAL CORPORATION (Verbatim)  
Hitachi Maxell Ltd.

**HD DVD-R: (Dual Layer)**

MITSUBISHI CHEMICAL CORPORATION (Verbatim)



- *This drive cannot use discs that allow writing faster than 16x speed (DVD-R and DVD+R media), 6x speed (DVD-RW media), 8x (DVD+RW media), 5x speed (DVD-RAM media), 4x speed (DVD-R (Dual Layer) media) and 8x speed (DVD+R (Double Layer media)).*
- *Some types and formats of DVD-R (Dual Layer) and DVD+R (Double Layer) discs may be unreadable.*
- *2.6GB and 5.2GB DVD-RAM media cannot be read from or written to.*
- *DISC created in DVD-R (Dual Layer) format4 (Layer Jump Recording) cannot be read.*
- If the disc is poor in quality, or is dirty or damaged, writing or rewriting errors may be noted - ensure that you check all discs for dirt or damage before you use them.
- The actual number of rewrites to CD-RW, DVD-RW, DVD+RW or DVD-RAM media will be affected by the quality of the disc itself and the way in which it is used.
- There are two types of DVD-R media available, authoring discs and general use discs. Do not attempt to use authoring discs as only general use discs can be written to by a computer drive.
- You can use both DVD-RAM discs that can be removed from a cartridge and DVD-RAM discs designed without a cartridge.
- You may find that other computer DVD-ROM drives or other DVD players may not be able to read DVD-R, DVD-R (Dual Layer), DVD-RW, DVD+R, DVD+R (Double Layer), DVD+RW or HD DVD-R discs.
- Data written to a CD-R, DVD-R, DVD-R (Dual Layer), DVD+R, DVD+R (Double Layer) or HD DVD-R discs cannot be deleted either in whole or in part.
- Data deleted/erased from a CD-RW, DVD-RW, DVD+RW, DVD-RAM or HD DVD-R disc cannot be recovered. You must check the content of the disc carefully before you delete it, taking care that, if multiple drives that can write data to discs are connected, you do not delete data from the wrong one.

- In writing to DVD-R, DVD-R (Dual Layer), DVD-RW, DVD+R, DVD+R (Double Layer), DVD+RW, DVD-RAM or HD DVD-R media, some space is required for file management, so you may not be able to write to the full capacity of the disc.
- Since the disc is based on the DVD standard, it might be filled with dummy data if the written data is less than about 1GB. Therefore, in these circumstance, even if you write only a small amount of data, it might take additional time to fill in the dummy data.
- When multiple drives that can write data to discs are connected, be sure that you do not write to or delete data from the wrong drive.
- Be sure to connect the AC adaptor to the computer before you write or rewrite any information.
- Before you enter either Sleep Mode or Hibernation Mode, take care to ensure that any DVD-RAM writing has been completed. In this instance, writing is finished if you can eject the DVD-RAM media.
- Be sure to close all other software programs except for the writing software itself.
- Do not run software such as a screen saver which can put a heavy load on the processor.
- Operate the computer at its full power settings - do not use any power-saving features.
- Do not write information while virus checking software is running, instead wait for it to finish, then disable the virus protection applications, including any software that checks files automatically in the background.
- Do not use any hard disk utilities, including those that are intended to enhance hard disk drive access speeds, as they may cause unstable operation and damage data.
- CD-RW (Ultra Speed +) media should not be used as data may be lost or damaged.
- You should always write from the computer's hard disk drive onto the CD/DVD/HD DVD - do not try to write from shared devices such as a server or any other network device.
- Writing with software other than TOSHIBA Disc Creator has not been confirmed, therefore operation with other software applications cannot be guaranteed.

## When writing or rewriting

Please observe the following points while you write or rewrite data to CD-R, CD-RW, DVD-R, DVD-R (Dual Layer), DVD-RW, DVD+R, DVD+R (Double Layer), DVD+RW, DVD-RAM or HD DVD-R media:

- Always copy data from the hard disk drive to the optical media - do not use the cut-and-paste function as the original data will be lost if there is a write error.
- Do not perform any of the following actions:
  - Change users in the Windows Vista™ operating system.
  - Operate the computer for any other function, including such tasks as using a mouse or Touch Pad, or closing/opening the display panel.
  - Start a communication application such as a modem.
  - Apply impact or vibration to the computer.
  - Install, remove or connect external devices, including such items as a PC Card, SD/SDHC memory card, miniSD/microSD Card, ExpressCard, Memory Stick/Memory Stick PRO/Memory Stick PRO Duo, xD picture card, MultiMediaCard, USB device, external monitor, i.LINK device, or an optical digital device.
  - Use the audio/video control button to reproduce music or voice.
  - Open the optical disc drive.
- Do not use shut down, log off, Sleep Mode or Hibernation Mode functions while writing or rewriting.
- Make sure that the write/rewrite operation is completed before going into either Sleep Mode or Hibernation Mode (writing is completed if you can remove an optical media on the HD DVD-R drive).
- If the media is of poor quality, or is dirty or damaged, writing or rewriting errors may occur.
- Set the computer on a level surface and avoid places subject to vibration such as airplanes, trains or cars. In addition, do not use the computer on an unstable surface such as a stand.
- Keep mobile phones and other wireless communication devices away from the computer.



## TOSHIBA Disc Creator

Please be aware of the following limitations when you use the TOSHIBA Disc Creator:

- DVD Video cannot be created using TOSHIBA Disc Creator.
- DVD Audio cannot be created using TOSHIBA Disc Creator.
- You cannot use TOSHIBA Disc Creator's "Audio CD for Car or Home CD Player" function to record music to DVD-R, DVD-R (Dual Layer), DVD-RW, DVD+R, DVD+R (Double Layer), DVD+RW or HD DVD-R media.
- Do not use the "Disc Backup" function of TOSHIBA Disc Creator in order to copy DVD Video, DVD-ROM or HD DVD-R material that has copyright protection.
- DVD-RAM discs cannot be backed up using the "Disc Backup" function of TOSHIBA Disc Creator.
- You cannot back up CD-ROM, CD-R or CD-RW media to DVD-R, DVD-R (Dual Layer), DVD-RW or HD DVD-R media using the "Disc Backup" function of TOSHIBA Disc Creator.
- You cannot back up CD-ROM, CD-R or CD-RW media to DVD+R, DVD+R (Double Layer) or DVD+RW media using the "Disc Backup" function of TOSHIBA Disc Creator.
- You cannot back up DVD-ROM, DVD Video, DVD-R, DVD-R (Dual Layer), DVD-RW, DVD+R, DVD+R (Double Layer), DVD+RW or HD DVD-R to CD-R or CD-RW media using the "Disc Backup" function of TOSHIBA Disc Creator.
- TOSHIBA Disc Creator cannot record in packet format.
- You might not be able to use the "Disc Backup" function of TOSHIBA Disc Creator to back up a DVD-R, DVD-R (Dual Layer), DVD-RW, DVD+R, DVD+R (Double Layer), DVD+RW or HD DVD-R disc that was made with other software on a different optical media recorder.
- If you add data to a DVD-R, DVD-R (Dual Layer), DVD+R, DVD+R (Double Layer) or HD DVD-R disc that you have already recorded to, you might not be able to read the added data under some circumstances. For example, it cannot be read under 16-bit operating systems, such as Windows 98SE and Windows Me, while in Windows NT4 you will need Service Pack 6 or later, and in Windows 2000, you will need Service Pack 2. In addition to this, some DVD-ROM and DVD-ROM / CD-R/RW drives cannot read this added data regardless of the operating system.
- TOSHIBA Disc Creator does not support recording to DVD-RAM discs - to achieve this you should use Windows Explorer or another similar utility.
- When you back up a DVD disc, be sure that the source drive supports recording to DVD-R, DVD-R (Dual Layer), DVD-RW, DVD+R, DVD+R (Double Layer) or DVD+RW media - if this is not the case then the source disc might not be backed up correctly.

- When you back up a DVD-R, DVD-R (Dual Layer), DVD-RW, DVD+R, DVD+R (Double Layer), DVD+RW or HD DVD-R disc, be sure to use the same type of disc.
- You cannot partially delete any data written to a CD-RW, DVD-RW, DVD+RW disc.

### ***Data Verification***

To verify that data has been written or rewritten correctly to a data CD/DVD/HD DVD you should follow the steps below before you begin the write/rewrite process:

1. Display the setting dialog box by one of the following two steps:
  - Click the **Recording settings** button (  ) for writing on the main toolbar in the **Data Disc** mode.
  - Select **Setting for Each Mode** -> **Data Disc** in the **Setting** menu.
2. Mark the **Verify written data** check box.
3. Select **File Open** or **Full Compare** mode.
4. Click the **OK** button.

### ***How to learn more about TOSHIBA Disc Creator***

Please refer to the Help files for additional TOSHIBA Disc Creator information.

## **When Using Ulead DVD MovieFactory® for TOSHIBA**

### ***How to make a DVD-Video***

There are two ways to create DVD-Video. Use Method 2 when using HD DVD-R media.

Method 1: Simplified steps for making a DVD-Video from video data captured from a DV-Camcorder:

1. Click **Start** -> **All Programs** -> **DVD MovieFactory for TOSHIBA** -> **Ulead DVD MovieFactory for TOSHIBA Launcher** to launch DVD MovieFactory.
2. Insert a DVD-RW or DVD+RW disc in Burner.
3. Click **Video Disc** -> **Burn Video to Disc** to launch **Direct Recording** dialog box, choose **DVD-Video/+VR** to invoke **Straight Capture to Disc** Page.
4. Choose **DVD-Video** format.
5. Choose the capture source is **DV**.
6. Press **Capture** button.

Method 2: Simplified steps for making a DVD-Video from adding video source:

1. Click **Start** -> **All Programs** -> **DVD MovieFactory for TOSHIBA** -> **Ulead DVD MovieFactory for TOSHIBA Launcher** to launch DVD MovieFactory.
2. DVD: Click **Video Disc** -> **New Project** to invoke 2nd Launcher, choose your project type, then invoke DVD MovieFactory.  
HD DVD: Click **Video Disc** -> **New Project** to invoke 2nd Launcher, choose **Create an HD DVD**, then invoke DVD MovieFactory.
3. Add source from HD Disk by click **Add Video files** button to invoke browser dialog box.
4. Choose the source video then go to Next page to apply Menu.
5. After choose the menu template, press **Next** button to go to **Burning Page**.
6. Choose the output type then press **Burn** button.

### ***How to learn more about Ulead DVD MovieFactory®***

Please refer to the Help and Manual files for additional Ulead DVD MovieFactory information.

### ***Important information for use***

Note the following limitations when you write Video DVD:

1. Editing digital video
  - Log in with Administrator rights to use DVD MovieFactory.
  - Make sure that your computer is running on AC power when using DVD MovieFactory.
  - Operate the computer at Full Power. Do not use power-saving features.
  - While you are editing DVD, you can display preview. However, if another application is running. The preview might not display properly.
  - DVD MovieFactory cannot edit or play copy protected content.
  - Do not enter Sleep or Hibernation Mode while using DVD MovieFactory.
  - Do not operate DVD MovieFactory immediately after turning on the computer. Please wait until all Disc Drive activity has stopped.
  - When recording to a DV-Camcorder, to ensure you capture all of your data, let the camcorder record for a few seconds before you begin recording your actual data.
  - CD recorder, JPEG functions, DVD-Audio, mini DVD and Video CD functions are not supported in this version.
  - While recording video to DVD, please close all other programs.
  - Do not run software like a screen saver because it can put a heavy load on the CPU.
  - Do not support mp3 decode and encode.

2. Before recording the video to DVD

- When you record DVD disc, please use only discs recommended by the Drive manufacturer.
- Do not set the working drive to a slow device like a USB1.1 hard disk drive or it will fail to write DVD.
- Do not perform any of the following actions:
  - Operate the computer for any other function, including using a mouse or Touch Pad, or closing/opening the display panel.
  - Bump or cause vibration to the computer.
  - Use the Mode control button and Audio/Video control button to reproduce music or voice.
  - Open the DVD drive.
  - Install, remove or connect external devices, including the following: PC card, SD/SDHC memory card, USB device, external display, i.LINK devices, optical digital devices.
- Please verify your disc after recording important data.
- DVD-R/+R/+RW disc cannot be written in VR format.
- Not support to output VCD and SVCD format.

3. About Straight to Disc

- Not support to record on DVD-R/+R disc
- Not support to record DVD+VR format by HDV
- HDV support to burn DVD-Video only
- DVD-VR format not support to add Menu

4. About recorded DVDs

- Some DVD-ROM drives for personal computers or other DVD players may not be able to read DVD-R/+R/-RW/-RAM discs.
- If you use an over-used rewritable disc, the full formatting might be locked. Please use a brand new disc.

## Media care

This section provides tips on protecting data stored on your CD's, DVD's, HD DVD's and floppy disks. Handle your media with care. Following the simple precautions listed below will increase the lifetime of your media and protect the data stored on it.

### CD/DVD/HD DVD

1. Store your CD's, DVD's and HD DVD's in the containers they originally came in to protect them and keep them clean.
2. Do not bend the CD's, DVD's or HD DVD's.
3. Do not write on, apply a sticker to, or otherwise mar the surface of the CD, DVD or HD DVD that contains the data.
4. Hold the CD, DVD or HD DVD by its outside edge or the edge on the center hole - any fingerprints on the surface of the disc can prevent the drive from properly reading data.
5. Do not expose the CD, DVD or HD DVD to direct sunlight, extreme heat or cold.
6. Do not place heavy objects on your CD's, DVD's or HD DVD's.
7. If your CD's, DVD's or HD DVD's become dusty or dirty, wipe them with a clean dry cloth from the center hole outwards - do not wipe in a circular direction. If necessary, you can use a cloth that has been lightly dampened in water or a neutral cleaner but you must not use benzine, thinner or any similar cleaning solution.

### Floppy disks



*The USB floppy disk drive is available only as an option.*

1. Store your floppy disks in the container they came in to protect them and keep them clean. If a floppy disk becomes dirty, clean it with a soft, lightly dampened cloth - do not use cleaning fluid.
2. Never open the shutter or touch the magnetic surface of your floppy disk - doing this could permanently damage it and lose data.
3. Always handle floppy disks with care to prevent the loss of stored data.
4. Always apply the floppy disk label in the correct location and never apply a new label on top of an existing one - in this instance the label could come loose and damage the floppy drive.
5. Never use a pencil for writing on a floppy disk label as the dust from the pencil lead could cause a system malfunction if it found its way onto the computer's components. In this instance, always use a felt-tipped pen and write the label first before applying it to the floppy disk.
6. Never put a floppy disk in a location where water or other liquid may make contact with it, or where it is excessively damp - either of these conditions could cause data loss.
7. Never use a wet or damp floppy disk - this could damage the floppy disk drive or other devices within the computer.

8. Data may be lost if the floppy disk is twisted, bent, or exposed to direct sunlight, extreme heat or cold.
9. Do not place heavy objects on your floppy disks.
10. Do not eat, smoke, or use items such as erasers near your floppy disks as foreign particles inside the jacket of the floppy disk can damage the magnetic surface.
11. Magnetic energy can destroy the data on your floppy disks. In view of this you should keep your floppy disks away from speakers, radios, televisions and other sources of magnetic fields.

## TV Tuner

Use the My TV feature of Media Center in Windows mode to watch TV programs or record them.

The dimensions and shape of the TV antenna port vary for different regions.

Some models are capable of simultaneously recording 2 different television programs.



- *Some computer models are equipped with a tuner capable of receiving digital broadcasts. These tuners can receive DVB-T digital broadcasts. Digital broadcasts cannot be received in regions where DVB-T digital broadcasts are not available.*
- *Simultaneous reception and recording cannot be used when an external video device is connected and the above settings are made. Once the external video device is disconnected, simultaneous reception and recording can again be used by following the instructions in [Configuring 2 tuners to receive simultaneously](#).*
- *Simultaneous reception and recording cannot be used when the set-top box is connected and the above settings are made.*
- *According to the government regulations, it is not permitted to bring PAL/SECAM TV tuners into Korea.*

## Using the TV Tuner

### Antenna

- The quality of sounds and pictures greatly depends on the radio propagation conditions.
- When you use your computer in areas where the radio waves are weak, which results in poor radio receiving conditions, contact the dealer you purchased it from, or use a commercially available antenna booster. Please refer to the manual provided with the booster for details.

## Connecting the Cable

This section describes how to connect the antenna cable to your computer.

### Connecting the antenna cable



*When lightning occurs, do not touch the antenna line. This may cause an electric shock.*



*If you have to operate your computer during a thunderstorm and are connecting the TV tuner to an outside antenna, you should operate your computer using AC power mode. The AC adaptor offers some protection against (but does not entirely prevent) possible electric shock caused by lightning. For complete protection, do not operate your computer during a thunderstorm.*

1. Save data, shutdown Windows and turn off the power.
2. Connect the antenna cable to the TV antenna port of your computer.

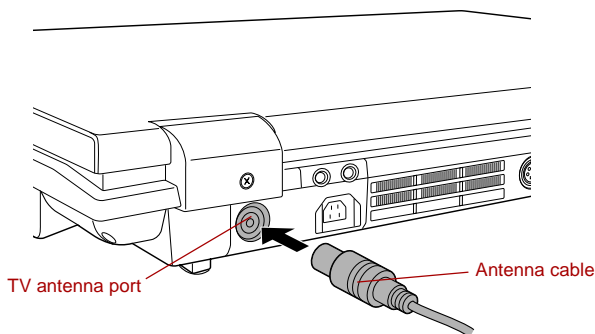

*Connecting the antenna cable*



*When you have been using a descrambler to receive the programs on cable TV or satellite broadcasting, connect the descrambler to the antenna cable.*

## Sound system

This section describes some of the audio control functions.

### Adjusting System Volume

You can control the overall level of sound using Windows **Volume Mixer**.

To launch Volume Mixer, follow the steps below.

1. Locate the **Speaker** icon on the task tray.
2. Right-click the **Speaker** icon on the task tray.
3. Select **Open Volume Mixer** from the menu.

Click the **Device** button to display available playback devices. Select **Speakers** to use the internal speakers for listening. Adjust speaker volume by moving the slider up or down to raise or lower the volume. Click the

**Mute** button  to mute the sound.

You may see another control under **Applications** in **Volume Mixer**. It is the control for an application which is currently running. The **Windows Sounds** is always displayed since it controls the system sounds' volume.

### Changing System Sounds

System sounds are assigned to inform you when certain events happen.

This section explains how select an existing scheme or save one you have modified.

To launch the configuration dialog window for system sounds, follow the steps below.

1. Right-click the **Speaker** icon on the task tray.
2. Select **Sounds** from the menu.

### Realtek HD Audio Manager

You can confirm and change the audio configuration using the **Realtek Audio Manager**. To launch the **Realtek Audio Manager**, click **Start -> Control Panel -> Hardware and Sound -> Realtek HD Audio Manager**.

When you first launch the Realtek Audio Manager, you will see four device tabs. **Speakers** is the default output device. **Microphone** is the default input device. To change the default device, click the **Set Default Device** button under the chosen device tab.

- **Speakers** is the default output device. Select it when using the internal speakers or headphones.
- **Digital Output** should be selected when connecting the optical cable to the S/PDIF jack for playing digital sound on digital audio equipment.
- **HDMI Output** should be selected when connecting the HDMI cable to the HDMI jack for playing digital sound on digital audio equipment.



- **Microphone** is the default input device. It should be selected when using the computer's internal microphone or an external microphone connected to the microphone jack to record sound.
- **Line In** should be selected when connecting the audio cable to the Line In jack for recording analog sound from audio equipment.

### **Information**

Click the **information button**  to view hardware information, software information, and language setting.

### **Power Management**

The audio controller in your computer can be turned off when the audio function is not used. To adjust the configuration of audio power

management, click the **battery button** .

- When audio power management is enabled, the circle button at the upper left of the Power Management is blue and convex.
- When audio power management is disabled, the button is black and concave.

### **Speaker Configuration**

Click the **playback button**  to confirm the internal speakers or the headphone sound is coming from the right direction.

### **Sound Effects**

This section explains how to select various sound effects.

- **Environment** - simulates reverberations of sound for familiar environments around us. You can select an existing preset in the menu.
- **Equalizer** - raises or lowers a frequency of sound to simulate a popular genre of music. You can select an existing preset in the menu.
- **Karaoke** - cancels the specific frequency of sound and results in the **Vocal Cancellation**. Clicking the **Karaoke** icon, lowers the vocal sound within music. Using the arrow buttons will adjust the musical key of the sound.

## Dolby® Home Theater

Dolby Home Theater enhances sound quality when you listen to audio of a music CD or a DVD on your computer.

- **Dolby® Virtual Speaker** simulates a 5.1-speaker surround sound listening environment from just two speakers. To enable Dolby Virtual Speaker, click **Control Panel** -> **Hardware and Sound** -> **Sound** -> **Speakers** -> **Dolby** -> **Dolby Home Theater** -> **On**.
- **Dolby® Headphone** lets you enjoy a simulated 5.1-channel surround sound experience from any set of headphones without disturbing others. To enable Dolby Virtual Speaker, click **Control Panel** -> **Hardware and Sound** -> **Sound** -> **Speakers** -> **Dolby** -> **Dolby Home Theater** -> **On**.

## Microphone Effects

**Microphone Effects** are only found within **Microphone** window.

- **Noise Suppression** reduces background noise and fan noise.
- **Acoustic Echo Cancellation** reduces feedback and feedback echo.

## Default Format

You can change the sample rate and bit depth of sound.

## Modem

This section describes how to connect and disconnect the internal modem to and from a telephone jack.



- *Connection to any communication line other than an analog phone line could cause a computer system failure.*
  - *Connect the built-in modem only to ordinary analog phone lines.*
  - *Never connect the built-in modem to a digital line (ISDN).*
  - *Never connect the built-in modem to the digital connector on a public telephone or to a digital private branch exchange (PBX).*
  - *Never connect the built-in modem to a key telephone system for residences or offices.*
- *Never operate your computer on AC power during a thunderstorm. If you see lightning or hear thunder, immediately turn off the computer. An electric surge caused by the storm, may result in a system failure, loss of data or hardware damage.*
- *Modem functions cannot be used in models which are not equipped with a modem.*

## Region selection

Telecommunication regulations vary from one region to another, so you will need to make sure the internal modem's settings are correct for the region in which it will be used.



*The built-in modem can be used only in specified countries and regions. Using the modem in an area not specified for use may cause a system failure. Check the specified areas carefully before using it.*

To select a region, follow the steps as detailed below:

1. Click **Start -> All Programs -> TOSHIBA -> Networking -> Modem Region Select.**



*If it is available, do not use the Country/Region Select function included as part of the modem setup utility within the Control Panel - if you change the country/region setting this way you may find that the change does not take effect.*

2. The Region Selection icon will appear in the Windows Task Bar.
3. Click the icon with the primary (left) mouse button to display a list of regions that the modem supports, together with a sub-menu which details telephony location information - a check mark will appear next to the currently selected region and telephony location.
4. Select either a region from the region menu or a telephony location from the sub-menu.
  - When you click a region it becomes the modem's default selection for any new dialling locations that are created within the Windows Control Panel (Phone and Modem Options).
  - When you select a telephony location, the corresponding region is automatically selected and becomes the modem's default setting.

## Properties menu

Click the icon with the secondary (right) mouse button in order to display a Properties menu on the screen.

## Setting

Within the Properties menu you can are able to either enable or disable the following settings:

### ***AutoRun Mode***

Allows you to configure whether the Modem Region Select utility starts automatically whenever you start up the operating system.

### ***Open the Dialing Properties dialog box after selecting region.***

Allows you to configure whether the dialing properties dialog box will be displayed automatically after you have selected a region.

### ***Location list for region selection.***

Displays a sub-menu appears which details location information.

### ***Open dialog box, if the modem and Telephony Current Location region code do not match.***

Displays a warning if the current settings for both region code and telephony location are different.

## Modem Selection

If the computer cannot recognize the internal modem, a dialog box is displayed from which you should select the appropriate communications port for your modem to use.

## Dialing Properties

You should select this item in order to display the dialing properties.



*If you are using the computer in Japan, the Telecommunications Business Law requires that you select Japan region mode. It is illegal to use the modem in Japan with any other selection.*

## Connecting the modular cable

To connect the modem's modular cable, follow the steps as detailed below:



- *Connection to any communication line other than an analog phone line could cause a computer system failure.*
  - *Connect the built-in modem only to ordinary analog phone lines.*
  - *Never connect the built-in modem to a digital line (ISDN).*
  - *Never connect the built-in modem to the digital connector on a public telephone or to a digital private branch exchange (PBX).*
  - *Never connect the built-in modem to a key telephone system for residences or offices.*
- *Never operate your computer on AC power during a thunderstorm. If you see lightning or hear thunder, immediately turn off the computer. An electric surge caused by the storm, may result in a system failure, loss of data or hardware damage.*

1. Plug the end of the modular cable into the computer's modem jack.
2. Plug the other end of the modular cable into a telephone jack.

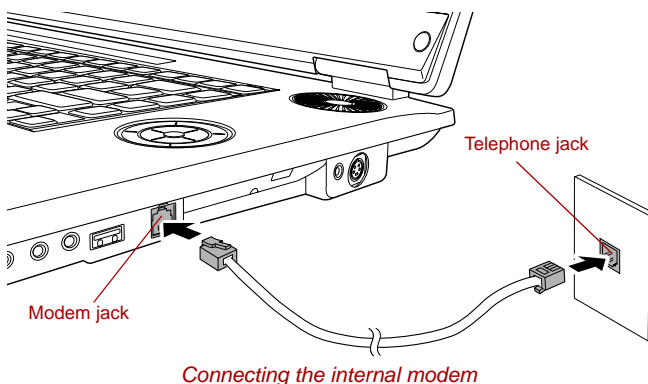

*Do not pull on the cable or move the computer while the cable is connected.*



*If you use a storage device such as an optical drive or hard disk drive connected to a 16-bit PC Card, you might experience the following problems with the operation of the modem:*

- *The modem speed is slow or communication is periodically interrupted.*
- *Skips or jumps may be noted in sound.*

## Disconnecting the modular cable

To disconnect the modular cable, follow the steps as detailed below:

1. Pinch the lever on the plug in the telephone jack and pull it out from within the connector.
2. Pinch the lever on the plug in the computer's modem jack and pull it out from within the computer.

## Wireless communications

The computer's wireless communication function supports both Wireless LAN and Bluetooth devices.

All models are provided with Wireless Communication switch. Some models are equipped with both Wireless LAN and Bluetooth functions.

### Wireless LAN

The Wireless LAN is compatible with other LAN systems based on Direct Sequence Spread Spectrum/Orthogonal Frequency Division Multiplexing radio technology that complies with IEEE802.11 Wireless LAN standard (Revision A, B, G or N Draft Ver. 1.0).



*Do not install or remove a memory module while Wake-up on Wireless LAN is enabled.*



■ *The Wake-up on Wireless LAN function consumes power even when the system is off. Leave the AC adaptor connected while using this feature.*

■ *The Wake-up on Wireless LAN function is effective only when it is connected with an Access Point. This function becomes invalid when the connection is broken.*

- Frequency Channel Selection of 5GHz for IEEE 802.11a or 2.4GHz for 802.11b/g
- Roaming over multiple channels
- Card power management
- Wired Equivalent Privacy (WEP) data encryption, based on the 128 bit encryption algorithm
- Wi-Fi Protected Access (WPA) support
- Advanced Encryption Standard (AES) data encryption
- Wake-up on Wireless LAN



*The transmission speed over the wireless LAN, and the distance over which the wireless LAN can reach, may vary depending on surrounding electromagnetic environment, obstacles, access point design and configuration, client design and software/hardware configurations. The transmission rate described is the theoretical maximum speed as specified under the appropriate standard - the actual transmission speed will be lower than the theoretical maximum speed.*

## Setting

1. Please make sure that the **Wireless Communication Switch** is turned on.
2. Click **Start** and then click **Connect To** to display **Connect to a network** window.
3. Click **Set up a connection or network**.
4. Follow the wizard. You will need the name of the wireless network together with security settings. Consult the documentation accompanied with your router or ask your wireless network administrator for the settings.

## Security

- TOSHIBA strongly recommend that you enable encryption functionality, otherwise your computer will be open to illegal access by an outsider using a wireless connection. If this occurs, the outsider may illegally access your system, eavesdrop, or cause the loss or destruction of stored data.
- TOSHIBA is not liable for the loss of data due to eavesdropping or illegal access through the wireless LAN and the damage thereof.

## Bluetooth wireless technology

Bluetooth® wireless technology eliminates the need for cables between electronic devices such as desktop computers, printers and mobile phones. You cannot use the computer's built-in Bluetooth functions and an optional Bluetooth devices simultaneously. For reference, Bluetooth wireless technology has the following features:

### **Worldwide operation**

The Bluetooth radio transmitter and receiver operate in the 2.4GHz band, which is license-free and compatible with radio systems in most countries in the world.

### **Radio links**

You can easily establish links between two or more devices, with these links being maintained even if the devices are not within a line-of-sight of each other.

## Security

Two advanced security mechanisms ensure a high level of security:

- Authentication prevents access to critical data and makes it impossible to falsify the origin of a message.
- Encryption prevents eavesdropping and maintains link privacy.

## Bluetooth® Stack for Windows® by TOSHIBA

Please note that this software is specifically designed for the following operating systems:

- Microsoft® Windows Vista™

Information regarding the use of this software with these operating systems is listed below, with further details being contained with the electronic help files supplied with the software.



*This Bluetooth® Stack is based on the Bluetooth® Version 1.1/1.2/2.0+EDR specification. However, TOSHIBA cannot confirm the compatibility between any computing products and/or other electronic devices that use Bluetooth®, other than TOSHIBA notebook computers.*

## Release Notes related to the Bluetooth® Stack for Windows® by TOSHIBA

1. Fax application software:  
Please be aware that there is some fax application software that you cannot use on this Bluetooth® Stack.
2. Multi-user considerations:  
On Windows Vista™, the use of Bluetooth is not supported in a multi-user environment. This means that, when you use Bluetooth, other users that are logged into the same computer will not be able to use this type of functionality.

## Product Support:

The latest information regarding operating system support, language support or available upgrades can be found on our web site <http://www.toshiba-europe.com/computers/tnt/bluetooth.htm> in Europe or [www.pcsupport.toshiba.com](http://www.pcsupport.toshiba.com) in the United States.



## Wireless communication switch

You can enable or disable Wireless communication function, with the on/off switch. No transmissions are sent or received when the switch is off. Slide the switch to the left to turn it on and to the right to turn it off.



- *Do not use the Wireless LAN (Wi-Fi) or Bluetooth functionalities near a microwave oven or in areas subject to radio interference or magnetic fields. Interference from a microwave oven or other source can disrupt Wi-Fi or Bluetooth operation.*
- *Turn Wi-Fi and Bluetooth functionalities off when near a person who may have a cardiac pacemaker implant or other medical electric device. Radio waves may affect pacemaker or medical device operation, possibly resulting in serious injury. Follow the instruction of your medical device when using any Wi-Fi or Bluetooth functionality.*
- *Always turn off Wi-Fi or Bluetooth functionality if the computer is near automatic control equipment or appliances such as automatic doors or fire detectors. Radio waves can cause malfunction of such equipment, possibly resulting in serious injury.*
- *It may not be possible to make a network connection to a specified network name using the ad hoc network function. If this occurs, the new network(\*) will have to be configured for all computers connected to the same network in order to re-enable network connections.*  
\* Please be sure to use new network name.

## Wireless communication indicator

The wireless communication indicator shows the status of the computer's wireless communication functions.

| Indicator status | Indication   |
|------------------|--|
| Indicator off    | The wireless communication switch is off - no wireless functionality is available.             |
| Indicator glows  | Wireless communication switch is on. Wireless LAN or Bluetooth is turned on by an application. |

If you used the Task Bar to disable the Wireless LAN you will need to restart the computer or follow the procedures below to enable the system to once again recognize and use wireless communications. Open or click the following: **Start -> Control Panel -> System and Maintenance -> System -> Device Manager -> Network adapters**, and right click the wireless device then choose **enable**.

## LAN

The computer has built-in support for Ethernet LAN (10 megabits per second, 10BASE-T), Fast Ethernet LAN (100 megabits per second, 100BASE-TX) and Gigabit Ethernet LAN (1000 megabits per second, 1000BASE-T). This section describes how to connect/disconnect to a LAN.



*Do not install or remove a memory module while Wake-up on LAN is enabled.*



- *The Wake-up on LAN function consumes power even when the system is off. Leave the AC adaptor connected while using this feature.*
- *The Link speed (10/100/1000 megabits per second) changes automatically depending on the network conditions (connected device, cable or noise and so on).*

### LAN cable types



*The computer must be configured properly before connecting to a LAN. Logging onto a LAN using the computer's default settings could cause a malfunction in LAN operation. Check with your LAN administrator regarding set-up procedures.*

If you are using Gigabit Ethernet LAN (1000 megabits per second, 1000BASE-T), be sure to connect with a CAT5E cable or higher. You cannot use a CAT3 or CAT5 cable.

If you are using Fast Ethernet LAN (100 megabits per second, 100BASE-TX), be sure to connect with a CAT5 cable. You cannot use a CAT3 cable.

If you are using Ethernet LAN (10 megabits per second, 10BASE-T), you can connect with either a CAT5 or a CAT3.

## Connecting the LAN cable

To connect the LAN cable, follow the steps as detailed below:



- *Connect the AC adaptor before connecting the LAN cable. The AC adaptor must remain connected during LAN use. If you disconnect the AC Adaptor while the computer is accessing a LAN, the system may hang up.*
- *Do not connect any other cable to the LAN jack except the LAN cable. Otherwise, malfunctions or damage may occur.*
- *Do not connect any power supplying device to the LAN cable that is connected to the LAN jack. Otherwise, malfunctions or damage may occur.*

1. Turn off the power to the computer and to all external devices connected to the computer.
2. Plug one end of the cable into the LAN jack. Press gently until you hear the latch click into place.

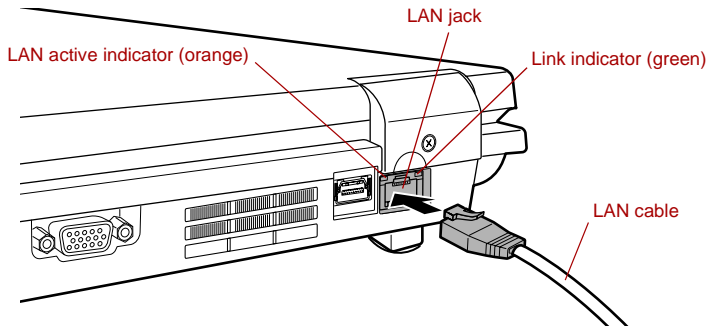

Connecting the LAN cable

3. Plug the other end of the cable into a LAN hub connector. Check with your LAN administrator before connecting to a hub.



*When the computer is exchanging data with the LAN, the **LAN Active** indicator glows orange. When the computer is connected to a LAN hub but is not exchanging data, the **Link** indicator glows green.*

## Disconnecting the LAN cable

To disconnect the LAN cable, follow the steps as detailed below:



*Make sure the **LAN Active** indicator (orange LED) is out before you disconnect the computer from the LAN.*

1. Pinch the lever on the connector in the computer's LAN jack and pull out the connector.
2. Disconnect the cable from the LAN hub in the same manner. Check with your LAN administrator before disconnecting from the hub.

## Cleaning the computer

To help ensure long, trouble-free operation, keep the computer free of dust and dirt, and use care with all liquids around it.

- Be careful not to spill liquids into the computer. If the computer does get wet, turn the power off immediately and let the computer dry completely - in these circumstance you should get the computer inspected by an authorized service provider in order to assess the scope of any damage.
- Clean the plastics of the computer using a slightly water dampened cloth.
- You can clean the display screen by spraying a small amount of glass cleaner onto a soft, clean cloth and then wiping the screen gently with the cloth.



*Never spray cleaner directly onto the computer or let liquid run into any part of it. Never use harsh or caustic chemical products to clean the computer.*

## Moving the computer

The computer is designed for rugged durability. However, a few simple precautions taken when moving the computer will help ensure trouble-free operation.

- Make sure all disk activity has ended before moving the computer - check the indicators on the front of the computer.
- If a CD, DVD or HD DVD is in the drive, remove it and make sure that the disc tray is securely closed.
- Turn off (shut down) the computer.
- Disconnect the AC adaptor and all peripherals before moving the computer.
- Close the display panel.
- Do not pick up the computer by its display panel.
- Before carrying your computer, shut it down, disconnect the AC adaptor and allow it to cool down - a failure to follow this instruction may result in minor heat injury.
- Be careful not to subject the computer to impact or shock - a failure to follow this instruction could result in damage to computer, computer failure or loss of data.
- Never transport your computer with any cards installed - this may cause damage to either the computer and/or the card resulting in product failure.
- Always use a suitable carry case when transporting the computer.
- When carrying your computer, be sure to hold it securely so that it does not fall or hit anything.
- Do not carry your computer by holding any of its protruding elements.

# Chapter 5

## The Keyboard

The computer's keyboard layouts are compatible with a 104/105-key enhanced keyboard - by pressing some keys in combination, all of the 104/105-key enhanced keyboard functions can be performed on the computer.

The number of keys available on your keyboard will depend on which country/region your computer is configured for, with keyboards being available for numerous languages.

In use there are six different types of keys, specifically typewriter keys, function keys, soft keys, Hot keys, Windows special keys and the keypad overlay.

### Typewriter keys

The typewriter keys produce the upper-case and lower-case letters, numbers, punctuation marks, and special symbols that appear on the screen. However, there are some differences between using a typewriter and using a computer keyboard:

- Letters and numbers produced in computer text vary in width. Spaces, which are created by a "space character" may also vary depending on line justification and other factors.
- The lowercase l (el) and the number 1 (one), together with the uppercase O (oh) and the 0 (zero), are not interchangeable on computers as they are on a typewriter.
- The **CAPS LOCK** function key locks only the alphabetic characters into upper-case while the Shift Lock function on a typewriter places all keys in the shifted position.
- The **SHIFT** keys, the **Tab** key, and the **BACK SPACE** key perform the same function as their typewriter counterparts but also have special computer functions.



*Never remove the key caps on your keyboard. Doing so could cause damage to the parts under the key caps.*

## Function keys: F1 ... F12

The function keys (not to be confused with the special **FN** key) are the twelve keys at the top of your keyboard - these keys function differently from other keys.

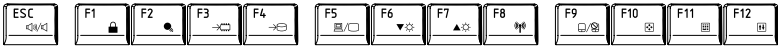

**F1** through **F12** are called function keys because they execute programmed functions when pressed and, when used in combination with the **FN** key, those keys marked with icons also execute specific functions on the computer. Please refer to the section, [Soft keys: FN key combinations](#), in this chapter for further information, taking care to note that the function executed by individual keys will depend on the software you are using.

## Soft keys: FN key combinations

The **FN** (function) is unique to TOSHIBA computers and is used in combination with other keys to form soft keys. Soft keys are key combinations that enable, disable or configure specific features.



*Please note that some software may disable or interfere with soft-key operations, and that the soft-key settings are not restored when the computer returns from Sleep Mode.*

## Emulating keys on an enhanced keyboard

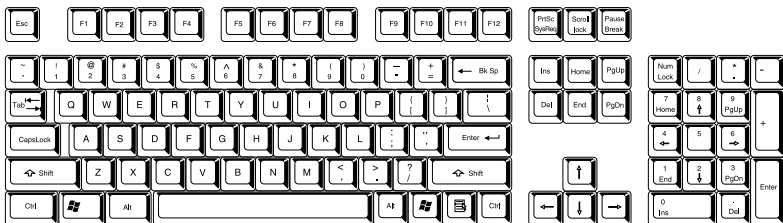

*A 104-key enhanced keyboard layout*

This computer's keyboard is designed to provide all the features of the 104-key enhanced keyboard.

Since the keyboard is smaller and has fewer keys, some of the enhanced keyboard functions must be simulated using two keys instead of one on the larger keyboard.

The **FN** key can be combined with the following keys to simulate functions similar to those of keys on the 104/105 key enhanced keyboard which are not on this computer's keyboard.

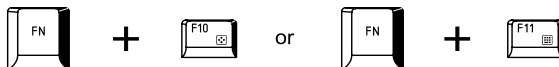

Press **FN + F10** or **FN + F11** to access the computer's integrated keypad. When activated, the keys with grey markings on their bottom edge become either numeric keypad keys (**FN + F11**) or cursor control keys (**FN + F10**). Please refer to the [Keypad overlay](#) section in this chapter for more information on how to operate these keys, taking care to note that the power on default for both settings is off.



Press **FN + F12 (ScrLock)** to lock the cursor on a specific line. The power on default is off.

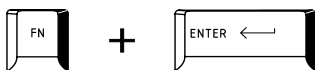

Press **FN + ENTER** to simulate **ENTER** on the enhanced keyboard's numeric keypad.

## Hot keys

Hot keys (pressing **FN** + a function or **ESC** key) let you enable or disable certain features of the computer.



**Mute:** Pressing **FN + ESC** turns the volume on and off.



**Lock:** Pressing **FN + F1** enters "Lock computer mode". To restore your desktop, you need to log on again.



**Power Plan:** Pressing **FN + F2** changes the power settings.



**Sleep:** Pressing **FN + F3** switches the system to Sleep mode.

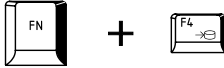

**Hibernate:** Pressing **FN + F4** switches the system to Hibernate mode.



**Output:** Pressing **FN + F5** changes the active display device.



**Brightness (Down):** Pressing **FN + F6** decreases the computer's display panel brightness in individual steps.



**Brightness (Up):** Pressing **FN + F7** increases the computer's display panel brightness in individual steps.



**Wireless:** Pressing **FN + F8** switches the active wireless devices if the wireless communication switch is switched on.



*If no wireless communication device is installed, no dialog box will appear.*

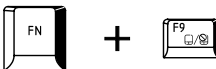

**Touch Pad:** Pressing **FN + F9** enables or disables the Touch Pad function.



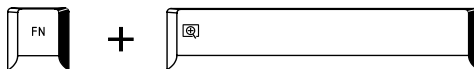

**Zoom:** Pressing **FN + Space** changes the display resolution.



**TOSHIBA Zooming Utility (reduce):** Pressing **FN + 1** reduces the icon size on the desktop or the font sizes within one of the supported application windows.



**TOSHIBA Zooming Utility (enlarge):** Pressing **FN + 2** enlarges the icon size on the desktop or the font sizes within one of the supported application windows.

## FN Sticky key

You can use the TOSHIBA Accessibility Utility to make the **FN** key sticky, that is, you can press it once, release it, and then press an “**F Number**” key. To start the TOSHIBA Accessibility utility, click **Start -> All Programs -> TOSHIBA -> Utilities -> Accessibility**.

## Windows special keys

The keyboard provides two keys that have special functions in Windows: Windows Start Button activates the **Start** menu and the other, the application key, has the same function as the secondary mouse button.



This key activates the Windows **Start** menu.



This key has the same function as the secondary (right) mouse button.

## Keypad overlay

Your computer's keyboard does not have a separate numeric keypad but includes a numeric keypad overlay which functions like one - this is located in the center of the keyboard with the relevant keys having grey letters at their front edge. The overlay provides the same functions as the numeric keypad on a standard 101/102-key enhanced keyboard.

### Turning on the overlays

The numeric keypad overlay can be used for numeric data input or cursor and page control.

#### Arrow mode

To turn on Arrow Mode, press **FN + F10** - the Arrow mode indicator lights and you are able to access cursor and page control functions by using the keys. You are able to press **FN + F10** again to turn off this overlay function.

#### Numeric mode

To turn on Numeric Mode, press **FN + F11** - the Numeric Mode indicator lights and you are able to access numeric characters by using the keys. You are able to press **FN + F11** again to turn off this overlay function.

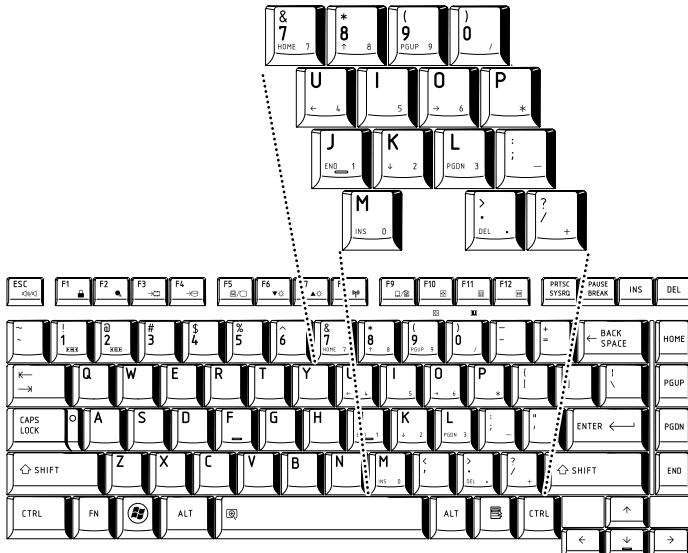

*The numeric keypad overlay*

## Temporarily using normal keyboard (overlay on)

While using the overlay, you can temporarily access the normal keyboard functions without having to turn the overlay off:

1. Hold **FN** and press any other key - this key will operate as if the overlay were off.
2. Type upper-case characters by holding **FN + SHIFT** and pressing a character key.
3. Release **FN** to continue using the selected overlay function.

## Temporarily using overlay (overlay off)

While using the normal keyboard function, you can temporarily use the keypad overlay without having to turn it on:

1. Press and hold down **FN**.
2. Check the keyboard indicators as pressing the **FN** key will turn on the most recently used overlay function - if the Numeric Mode indicator lights you can use the overlay for numeric entry, while if the Arrow Mode indicator lights, you can use the overlay for cursor and page control function.
3. Release **FN** to return to normal keyboard operation.

## Temporarily changing modes

If the computer is in **Numeric Mode**, you can switch temporarily to **Arrow Mode** by pressing a **SHIFT** key, while if it is in **Arrow Mode**, you can switch temporarily to **Numeric Mode** by also pressing a **SHIFT** key.

## Generating ASCII characters

Not all ASCII characters can be generated using normal keyboard operation, but you are able to generate these characters using their specific ASCII codes.

With the overlay on:

1. Hold down **ALT**.
2. Using the overlay keys, type the ASCII code of the character you require.
3. Release **ALT** - the ASCII character will appear on the display screen.

With the overlay off:

1. Hold down **ALT + FN**.
2. Using the overlay keys, type the ASCII code of the character you require.
3. Release **ALT + FN** - the ASCII character will appear on the display screen.



# Chapter 6

## Power

The computer's power resources include the AC adaptor, battery pack and any internal batteries. This chapter provides details on making the most effective use of these resources, and includes information on charging and changing batteries, tips for saving battery power, and information on the different power-up modes.

### Power conditions

The computer's operating capability and battery charge status are affected by different power conditions, including whether an AC adaptor is connected, whether a battery pack is installed and what the charge level is for that battery.

#### *Power conditions*

|                         |  | Power on   | Power off<br>(no operation)  |
|-------------------------|--|--|--|
| AC adaptor<br>connected | Battery fully<br>charged                     | <ul style="list-style-type: none"> <li>Operates</li> <li>LED: <b>Battery</b> blue<br/><b>DC IN</b> blue</li> </ul>                         | <ul style="list-style-type: none"> <li>LED: <b>Battery</b> blue<br/><b>DC IN</b> blue</li> </ul>                         |
|                         | Battery partially<br>charged or no<br>charge | <ul style="list-style-type: none"> <li>Operates</li> <li>Quick Charge</li> <li>LED: <b>Battery</b> orange<br/><b>DC IN</b> blue</li> </ul> | <ul style="list-style-type: none"> <li>Quick charge</li> <li>LED: <b>Battery</b> orange<br/><b>DC IN</b> blue</li> </ul> |
|                         | No battery<br>installed                      | <ul style="list-style-type: none"> <li>Operates</li> <li>No charge</li> <li>LED: <b>Battery</b> off<br/><b>DC IN</b> blue</li> </ul>       | <ul style="list-style-type: none"> <li>No charge</li> <li>LED: <b>Battery</b> off<br/><b>DC IN</b> blue</li> </ul>       |

*Power conditions continued*

|                                 |   | Power on   | Power off<br>(no operation) |
|---------------------------------|---|--|-----------------------------|
| <b>AC adaptor not connected</b> | Battery charge is above low battery trigger point | <ul style="list-style-type: none"> <li>Operates</li> <li>LED: <b>Battery</b> off</li> <li><b>DC IN</b> off</li> </ul>            |                             |
|                                 | Battery charge is below low battery trigger point | <ul style="list-style-type: none"> <li>Operates</li> <li>LED: <b>Battery</b> flashes orange</li> <li><b>DC IN</b> off</li> </ul> |                             |
|                                 | Battery charge is exhausted                       | Computer goes into Sleep Mode and shuts down   |                             |
|                                 | No battery installed                              | <ul style="list-style-type: none"> <li>Cannot operate</li> <li>LED: <b>Battery</b> off</li> <li><b>DC IN</b> off</li> </ul>      |                             |

## Power indicators

As shown in the below table, the **Battery**, **DC IN** and **Power** indicators on the system indicator alert you to the computer's operating capability and battery charge status.

### Battery indicator

Check the **Battery** indicator to determine the status of the battery pack - the following indicator conditions should be noted:

|                        |   |
|------------------------|---|
| <b>Flashing orange</b> | The battery charge is low, the AC adaptor must be connected in order to recharge the battery. |
| <b>Orange</b>          | Indicates the AC adaptor is connected and the battery is charging.                            |
| <b>Blue</b>            | Indicates the AC adaptor is connected and the battery is fully charged.                       |
| <b>No light</b>        | Under any other conditions, the indicator does not light.                                     |



*If the battery pack becomes too hot while it is being charged, the charge will stop and the **Battery** indicator will go out. When the battery pack's temperature falls to a normal range, charging will resume - this process will occur regardless of whether the computer's power is on or off.*

## DC IN indicator

Check the **DC IN** indicator to determine the power status with the AC adaptor connected - the following indicator conditions should be noted:

|                        |  |
|------------------------|--|
| <b>Blue</b>            | Indicates the AC adaptor is connected and is correctly supplying power to the computer.  |
| <b>Flashing orange</b> | Indicates a problem with the power supply. You should initially try plugging the AC adaptor into another power outlet - if it still does not operate properly, you should contact your reseller or dealer. |
| <b>No light</b>        | Under any other conditions, the indicator does not light.  |

## Power indicator

Check the **Power** indicator to determine the power status of the computer - the following indicator conditions should be noted:

|                        |  |
|------------------------|--|
| <b>Blue</b>            | Indicates power is being supplied to the computer and the computer is turned on.   |
| <b>Blinking orange</b> | Indicates that the computer is in Sleep Mode and that there is sufficient power available (AC adaptor or battery) to maintain this condition. In Sleep Mode, this indicator will turn on for one second and off for two seconds. |
| <b>No light</b>        | Under any other conditions, the indicator does not light.  |

## Battery types

The computer has two different types of batteries:

- Battery pack
- Real Time Clock (RTC) battery

### Battery pack

When the AC adaptor is not connected, the computer's main power source is a removable lithium ion battery pack, also referred to in this manual as the battery. You can purchase additional battery packs for extended use of the computer away from an AC power source although you should not change the battery pack while the AC adaptor is connected.

Before you remove the battery pack, save your data and shut down the computer, or place the computer into Hibernation Mode. Please be aware that, when placing the computer into Hibernation Mode, the contents of memory will be saved to the hard disk drive, although for safety sake, it is best to also save your data manually.



- *The battery pack is a lithium ion battery, which can explode if not properly replaced, used, handled or disposed of. Dispose of the battery as required by local ordinances or regulations. Use only batteries recommended by TOSHIBA as replacements.*
- *Always use the battery pack supplied as an accessory or an equivalent battery pack specified in the User's Manual. Other battery packs have different voltage and terminal polarities. Use of non-conforming battery packs could generate smoke or cause fire or rupture, possibly resulting in serious injury.*
- *Always dispose of used battery packs in compliance with all applicable laws and regulations. Put insulating tape, such as cellophane tape, on the electrode during transportation to avoid a possible short circuit, fire or electric shock. Failure to do so could possibly result in serious injury.*
- *Do not remove the battery pack while the computer is in Sleep Mode. Data is stored in RAM, so if the computer loses power it will be lost. When the computer is powered off in Sleep Mode, and the AC adaptor is not connected, the battery pack supplies power to maintain data and programs in memory. If the battery pack is completely discharged, Sleep Mode will not function and the computer loses all data in memory.*

To ensure that the battery pack maintains its maximum capacity, operate the computer on battery power at least once a month until the battery pack is fully discharged - please refer to [Extending battery life](#) in this chapter for details of the procedure.

If the computer is continuously operated on AC power through connection to an AC adaptor for an extended period, for example more than a month, the battery may fail to retain a charge, it may not function efficiently over its expected life and the **Battery** indicator may not properly indicate a low-battery condition.



## Real Time Clock battery

The Real Time Clock (RTC) battery provides power for the internal real time clock and calendar function and also maintains the system configuration while the computer is turned off. If the RTC battery becomes completely discharged, the system will lose this information and the real time clock and calendar will stop working - in this instance the following message will be displayed when you turn on the power:



```
**** RTC battery is low or CMOS checksum is  
inconsistent ****  
Press [F1] key to set Date/Time.
```

You can change the Real Time Clock settings by turning the computer on while pressing the **ESC** key and then the **F1** key when prompted. Please refer to Chapter 10, [Troubleshooting](#) for further information.



*The computer's RTC battery is a Ni-MH battery and should be replaced only by your dealer or by a TOSHIBA service representative. The battery can explode if not properly replaced, used, handled or disposed of. Dispose of the battery as required by local ordinances or regulations.*



*The RTC battery does not charge while the computer is turned off even if the AC adaptor is attached.*

## Care and use of the battery pack

The battery pack is a vital component of portable computing and, as such, taking proper care of it will help ensure a longer operating time on battery power as well as deliver a longer life for your battery pack. The instructions detailed in this section will help to ensure safe operation and maximum performance.

Refer to the enclosed ***Instruction Manual for Safety and Comfort*** for detailed precautions and handling instructions.



- *Make sure the battery is securely installed in the computer before attempting to charge the battery pack. Improper installation could generate smoke or fire, or cause the battery pack to rupture.*
- *Keep the battery pack out of reach of infants and children. It can cause injury.*
- *Never expose a battery pack to abnormal shock, vibration or pressure. Never use a battery pack which has been exposed to abnormal shock even if the appearance is normal. The battery pack's internal protective device could fail, causing it to overheat or ignite resulting in caustic liquid leakage, or explosion or fire, possibly resulting in death or serious injury.*
- *Always immediately turn the power off and disconnect the power cable/cord plug from the plug socket and stop using the battery pack if you observe any of the following conditions:*
  - *Offensive or unusual odor*
  - *Excessive heat*
  - *Discoloration*
  - *Deformation, cracks or leaks*
  - *Smoke*
  - *Other unusual event during use, such as abnormal sound*

*In such an event, carefully and immediately remove the battery pack from the computer. In some instances, you might have to wait for the computer to cool down before removing the battery pack, in order to avoid any possible minor injury due to heat exposure. Do not turn on the computer's power again until an authorized Toshiba service provider has checked it for safety. Continued use could cause a fire or rupture possibly resulting in serious injury or computer failure including but not limited to the loss of data.*



- *Use only battery packs recommended by TOSHIBA as replacements.*
- *Charge the battery pack only in an ambient temperature between 5 and 35 degrees Celsius. Otherwise, the electrolyte solution might leak, battery pack performance might deteriorate and the battery life might be shortened.*
- *Never install or remove the battery pack without first turning off the power and disconnecting the AC adaptor. Never remove the battery pack while the computer is in Sleep Mode. Data will be lost.*



- *Never remove the battery pack while the Wake-up on LAN function is enabled. Data will be lost. Before you remove a battery pack, disable the Wake-up on LAN function.*
- *Never remove the battery pack while the Wake-up on Wireless LAN function is enabled. Data will be lost. Before you remove a battery pack, disable the Wake-up on Wireless LAN function.*

## Charging the batteries

When the power in the battery pack becomes low, the **Battery** indicator will flash orange to indicate that only a few minutes of battery power remain. If you continue to use the computer while the **Battery** indicator flashes, the computer will enable Hibernation Mode so that you do not lose any data, and automatically turn itself off.

You must recharge a battery pack when it becomes discharged.

### Procedures

To recharge a battery pack while it is installed in the computer, connect the AC adaptor to the DC IN 15V jack and plug the other end into a working outlet - the **Battery** indicator will glow orange while the battery is being charged.



*Use only the computer connected to an AC power source or the optional TOSHIBA Battery charger to charge the battery pack. Never attempt to charge the battery pack with any other charger.*

### Time

The following table shows the approximate time required to fully charge a discharged battery.

#### Charging time (hours)

| Battery type           | Power on                   | Power off      |
|------------------------|----------------------------|----------------|
| Battery Pack (7050mAh) | about 3.0 to 5.0 or longer | about 3.0      |
| RTC battery            | 24                         | Doesn't charge |



*Please be aware that the charging time when the computer is on is affected by ambient temperature, the temperature of the computer and how you are using the computer - if you make heavy use of external devices for example, the battery might scarcely charge at all during operation. Please refer to the section [Maximizing battery operating time](#) for further information.*

## Battery charging notice

The battery may not begin charging immediately under the following conditions:

- The battery is extremely hot or cold (if the battery is extremely hot, it might not charge at all). To ensure the battery charges to its full capacity, you should charge it at room temperature of between 10° to 30°C (50° to 86°F).
- The battery is nearly completely discharged. In this instance you should leave the AC adaptor connected for a few minutes and the battery should begin charging.

The **Battery** indicator may show a rapid decrease in battery operating time when you try to charge a battery under the following conditions:

- The battery has not been used for a long time.
- The battery has completely discharged and been left in the computer for a long time.
- A cool battery is installed in a warm computer.

In such cases you should follow the steps as detailed below:

1. Fully discharge the battery by leaving it in the computer with the power on until the system automatically turns itself off.
2. Connect the AC adaptor to the DC IN 15V jack of the computer, and to a wall outlet that is supplying power.
3. Charge the battery until the **Battery** indicator glows blue.

Repeat these steps two or three times until the battery recovers normal capacity.

## Monitoring battery capacity

Remaining battery power can be monitored using the following methods.

- Clicking the battery icon on the task bar
- Via the Battery Status in the Windows Mobility Center window



- *You should wait at least 16 seconds after turning on the computer before trying to monitor the remaining operating time. This is because the computer needs this time to check the battery's remaining capacity and then calculate the remaining operating time, based on this together with the current power consumption.*
- *Please be aware that the actual remaining operating time may differ slightly from the calculated time.*
- *With repeated discharges and recharges, the battery's capacity will gradually decrease. In view of this it will be noted that an often used, older battery will not operate for as long as a new battery even when both are fully charged.*

## Maximizing battery operating time

A battery's usefulness depends on how long it can supply power on a single charge, while how long the charge lasts in a battery depends on:

- Processor speed
- Screen brightness
- System Sleep Mode
- System Hibernation Mode
- Display power off period
- Hard disk drive power off period
- How often and for how long you use the hard disk drive, optical disc and floppy disk drives.
- How much charge the battery contained to begin with.
- How you use optional devices, such as a PC Cards, to which the battery supplies power.
- Whether you enable Sleep Mode, which can conserve battery power if you are frequently turning the computer off and on.
- Where you store your programs and data.
- Whether you close the display panel when you are not using the keyboard - closing the display saves power.
- The environmental temperature - operating time decreases at low temperatures.
- The condition of the battery terminals - you should always ensure the terminals stay clean by wiping them with a clean dry cloth before installing the battery pack.

## Retaining data with power off

When you turn off your computer with fully charged batteries, the batteries retain data for the following approximate time periods.

### Retention Time

| Battery type           | State and Retention Time                               |
|------------------------|--|
| Battery Pack (7050mAh) | about 5 days (Sleep Mode)<br>about 25 days (Boot Mode) |
| RTC battery            | 30 days  |

## Extending battery life

To maximize the life of your battery packs:

- At least once a month, disconnect the computer from a power source and operate it on battery power until the battery pack fully discharges. Before doing so, follow the steps as detailed below.
  1. Turn off the computer's power.
  2. Disconnect the AC adaptor and turn on the computer's power - if it does not turn on then go to Step 4.
  3. Operate the computer on battery power for five minutes. If you find that the battery pack has at least five minutes of operating time, continue operating until the battery pack is fully discharged, however, if the **Battery** indicator flashes or there is some other warning to indicate a low battery condition, go to Step 4.
  4. Connect the AC adaptor to the DC IN 15V jack of the computer, and to a wall outlet that is supplying power. The **DC IN** indicator should glow blue, and the **Battery** indicator should glow orange to indicate that the battery pack is being charged, however, in the event that **DC IN** indicator does not glow this indicates that power is not being supplied - check the connections for the AC adaptor and the power cord.
  5. Charge the battery pack until the **Battery** indicator glows blue.
- If you have extra battery packs, rotate their use.
- If you will not be using the system for an extended period, for example for more than one month, remove the battery pack from the computer.
- Disconnect the AC adaptor when the battery is fully charged - overcharging will make the battery hot and can shorten its operating life.
- If you are not going to use the computer for more than eight hours, disconnect the AC adaptor.
- Store spare battery packs in a cool dry place out of direct sunlight.

## Replacing the battery pack

Please be aware that the battery pack is classified as a consumable item. The operating life of the battery pack will gradually reduce through repeated charging and discharging, and will need to be replaced when it reaches the end of its operating life. In addition to this, you might also replace a discharged battery pack with a charged spare when you are operating your computer away from an AC power source for an extended period of time.

This section explains how to remove and install the battery pack, and begins with the removal process which is detailed through the following steps.



- *Do not remove the battery pack while the computer is in Sleep Mode. Data is stored in RAM, so if the computer loses power it will be lost.*
- *In Hibernation Mode, data will be lost if you remove the battery pack or disconnect the AC adaptor before the save is completed. Wait for the **Hard Disk Drive** indicator to go out.*
- *Do not touch the battery release latch while holding the computer or the battery pack might fall out due to the unintentional release of the battery release latch and cause injuries.*

To remove a discharged battery, follow the steps as detailed below:

1. Save your work.
2. Turn the computer's power off - ensure that the **Power** indicator is off.
3. Remove all cables and peripherals that are connected to the computer.
4. Close the display panel and turn the computer upside down.
5. Slide the battery safety lock towards the release (  ) position to make the battery release latch movable.

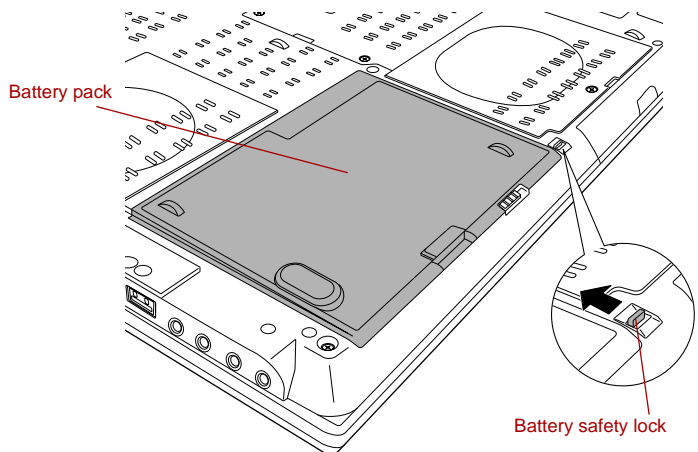

*Releasing the battery pack (1)*

- Slide and hold the battery release latch (1) to disengage the battery pack and then remove it from the computer (2).

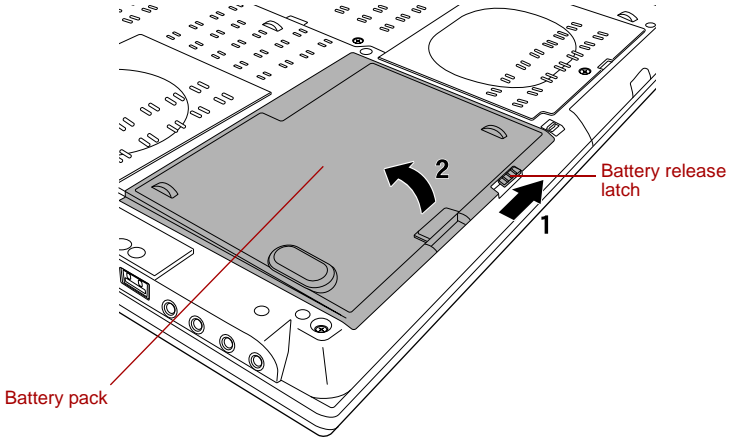

*Releasing the battery pack (2)*

To install a battery, follow the steps as detailed below:

- Insert the battery pack as far as it will go into the computer (1).
- Ensure that the battery pack is securely in place and the battery safety lock (2) is in its (  ) position.

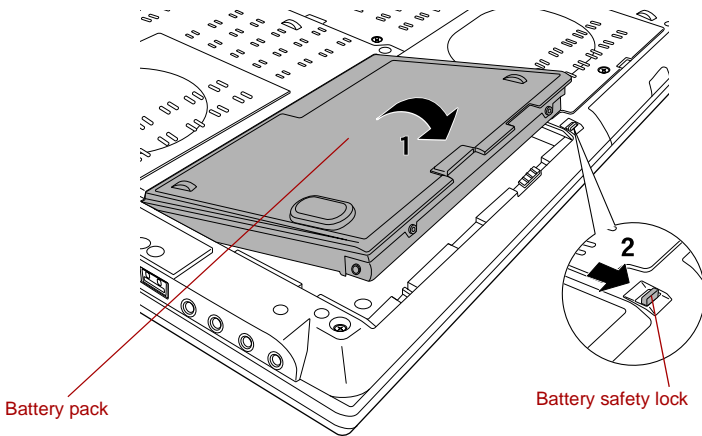

*Securing the battery pack*

- Turn your computer over.



## TOSHIBA Password Utility

The TOSHIBA Password Utility provides two levels of password security: User and Supervisor.



*Passwords set by the TOSHIBA Password Utility function are different from the Windows password.*

### User Password

To start the utility, point to or click the following items:

**Start -> All Programs -> TOSHIBA -> Utilities -> Password Utility**

#### *User Password field*

- **Set** (button)

Click this button to register a password of up to 50 characters. After a password is set, you will be prompted to enter it when you start the computer.



- *After you set the password, a dialog box will be displayed asking whether you want to save it to a floppy disk or other media. If you forget the password, you can open the password file on another computer. Be sure to keep the media in a safe place.*

- *When entering the character string to register the password, enter from the keyboard character by character and do not enter as ASCII code or copy-and-paste the character string. In addition, ensure that the registered password is correct by outputting the character string to the password file.*

- *When entering a password, do not enter any characters (for example "!" or "#") produced by pressing the **SHIFT** or **ALT** keys and so on.*

- **Delete** (button)

Click this button to delete a registered password. Before you can delete a password, you must first enter the current password correctly.

- **Change** (button)

Click this button to change a registered password. Before you can change a password, you must first enter the current password correctly.

- **Owner String** (text box)

You can use this box to associate text with the password. After you enter text, click **Apply** or **OK**. When the computer is started, this text will be displayed together with the prompt asking you to enter a password.



- *If you forget your HDD User Password, TOSHIBA will NOT be able to assist you, and your HDD will be rendered COMPLETELY and PERMANENTLY INOPERABLE. TOSHIBA will NOT be held responsible for any loss of any data, any loss of use or access to your HDD, or for any other losses to you or any other person or organization that result from the loss of access to your HDD. If you can't accept this risk, don't register the HDD User Password.*
- *When saving the HDD User Password shut down or restart the computer. If the computer is not shut down or restarted, the saved data may not be correctly reflected. For more information on shutting down or restarting the computer, refer to [Turning on the power](#) in Chapter 3.*



Refer to [Starting and Ending the BIOS Setup Program](#) section in Chapter 7 for more information.

## Supervisor password

If you set a Supervisor Password, some functions might be restricted when a user logs on with the User Password. To set a Supervisor Password, execute the file TOSPU.EXE. The file is located at:

`C:\Program Files\Toshiba>PasswordUtility\TOSPU.exe`

This utility lets you do the following:

- Register, delete or change the Supervisor Password.
- Specify restrictions for general users.

## Starting the computer by password

If you have already registered a password, there are two ways to start the computer:

- Swipe your fingerprint on the sensor if you have already registered the fingerprint with the Fingerprint utility and enabled Fingerprint System Boot Authentication. If you would not like to swipe your finger or cannot authenticate the fingerprint for some reasons, push the **BACK SPACE** key to skip the fingerprint authentication screen. You can try to swipe the fingerprint up to five times. If you failed fingerprint authentication five times, you must enter the password manually to start the computer.
- Enter the password manually.



*The password is necessary only if the computer was Shutdown and Hibernation in Boot Mode.*

*It is not needed in Sleep Mode and Restart.*

To enter a password manually, follow these steps:

1. Turn on the power as described in Chapter 3, [Getting Started](#). The following message will appear in the screen:



Password=

2. Enter the Password.
3. Press **ENTER**.



*If you enter the password incorrectly three times in a row, the computer shuts off. In this case, you must turn the computer back on to retry password entry.*

## Power-up modes

The computer has three different power-up modes as follows:

- **Boot Mode:** The computer will shut down without saving data - in view of this you must always save your work before you turn the computer off.
- **Hibernation Mode:** Data in memory will be saved to the hard disk drive.
- **Sleep Mode:** Data will be maintained in the computer's memory.



*Please refer to the sections [Turning on the power](#) and [Turning off the power](#) in Chapter 3, [Getting Started](#) for further information.*

## Windows utilities

You can configure various settings associated with both Sleep Mode and Hibernation Mode within the Power Options (to access it, **Start** -> **Control Panel** -> **System and Maintenance** -> **Power Options**).

## Hot keys

You can use the **FN + F3** hot key to enter Sleep Mode or **FN + F4** to enter Hibernation Mode - please refer to Chapter 5, [The Keyboard](#) for further details.

## Panel power on/off

You can set up your computer so that power is turned off automatically when you close the display panel, and turned on again when you open it. Please note that this function is only available for Sleep Mode or Hibernation Mode, not for Boot Mode.



*If the panel power off function is enabled, and you manually shut down Windows, do not close the computer's display panel until the shut down process has been completed.*

## System Auto Off

This feature turns the system off automatically if it is not used for a set period of time, and can be configured for both Sleep Mode or Hibernation Mode.

# Chapter 7

## HW Setup & BIOS Setup

This chapter explains how to use the TOSHIBA HW Setup program to configure your computer, and provides information on settings for various functions.

### Accessing HW Setup

To run the HW Setup program, click **Start -> All Programs -> TOSHIBA -> Utilities -> HWSetup**.

### HW Setup window

The HW Setup window contains a number of tabs (General, Boot Priority, Keyboard, CPU, LAN, Device Config, USB and Button Setting) to allow specific functions of the computer to be configured.

In addition there are also three buttons: **OK**, **Cancel** and **Apply**.

|               |   |
|---------------|---|
| <b>OK</b>     | Accepts your changes and closes the HW Setup window.          |
| <b>Cancel</b> | Closes the window without accepting your changes.             |
| <b>Apply</b>  | Accepts all your changes without closing the HW Setup window. |

#### *General*

This window displays the BIOS version and contains two buttons: **Default** and **About**.

|                |   |
|----------------|---|
| <b>Default</b> | Return all HW Setup values to the factory settings. |
| <b>About</b>   | Display the HW Setup version.                       |

#### *Setup*

This field displays the installed **BIOS version** and date.

## Boot Priority

### Boot Priority Options

This tab allows you to select the priority for booting the computer - the following settings are available:

“HDD” here refers to the Built-in HDD that is defined in the HDD Priority Option so that it should be recognized first.

---

|   |   |
|---|---|
| <b>FDD</b> → <b>HDD</b> →<br><b>CD-ROM</b> → <b>LAN</b> | The computer looks for bootable files on devices in the following order: 1. floppy diskette drive <sup>1</sup> , 2. hard disk drive, 3. CD-ROM <sup>2</sup> , 4. LAN. |
|---|---|

---

|   |   |
|---|---|
| <b>HDD</b> → <b>FDD</b> →<br><b>CD-ROM</b> → <b>LAN</b> | The computer looks for bootable files on devices in the following order: 1. hard disk drive, 2. floppy diskette drive <sup>1</sup> , 3. CD-ROM <sup>2</sup> , 4. LAN. |
|---|---|

---

|   |   |
|---|---|
| <b>FDD</b> → <b>CD-ROM</b> →<br><b>LAN</b> → <b>HDD</b> | The computer looks for bootable files on devices in the following order: 1. floppy diskette drive <sup>1</sup> , 2. CD-ROM <sup>2</sup> , 3. LAN, 4. hard disk drive. |
|---|---|

---

|   |   |
|---|---|
| <b>HDD</b> → <b>CD-ROM</b> →<br><b>LAN</b> → <b>FDD</b> | The computer looks for bootable files on devices in the following order: 1. hard disk drive, 2. CD-ROM <sup>2</sup> , 3. LAN, 4. floppy diskette drive <sup>1</sup> . |
|---|---|

---

|   |   |
|---|---|
| <b>CD-ROM</b> → <b>LAN</b> →<br><b>FDD</b> → <b>HDD</b> | The computer looks for bootable files on devices in the following order: 1. CD-ROM <sup>2</sup> , 2. LAN, 3. floppy diskette drive <sup>1</sup> , 4. hard disk drive. |
|---|---|

---

|   |   |
|---|---|
| <b>CD-ROM</b> → <b>LAN</b> →<br><b>HDD</b> → <b>FDD</b> | The computer looks for bootable files on devices in the following order: 1. CD-ROM <sup>2</sup> , 2. LAN, 3. hard disk drive, 4. floppy diskette drive <sup>1</sup> . |
|---|---|

---

You can override the settings and manually select a boot device by pressing one of the following keys while the computer is booting:

---

|          |  |
|----------|--|
| <b>U</b> | Selects the USB floppy diskette drive.               |
| <b>N</b> | Selects the network.                                 |
| <b>1</b> | Selects the primary hard disk drive.                 |
| <b>2</b> | Selects the primary hard disk drive 2 <sup>3</sup> . |
| <b>C</b> | Selects the CD-ROM <sup>2</sup> .                    |
| <b>M</b> | Selects the USB memory drive.                        |

---

<sup>1</sup> The floppy diskette drive is looked for when the boot disk is contained in external floppy diskette drive.

<sup>2</sup> In this computer, CD-ROM refers to the Fixed optical disc drive.

<sup>3</sup> Only the model with two HDDs is supported.

To change the boot drive, follow the steps below.

1. Hold down **F12** and turn the computer on.
2. The following menu will be displayed with, from left to right, icons to allow you to start from (a) the built-in hard disk drive 1, (b) the built-in hard disk drive 2, (c) the optical drive, (d) a floppy diskette drive, (e) the network and (f) USB Memory boot.



*Please note that a highlighted bar will only appear under the selected device.*

3. Use the left/right cursor keys to highlight the boot device you want and press **ENTER**.



*If a Supervisor Password has been set, manual boot device selection functions may be restricted.*

*The boot device selection methods described above will not change the boot priority settings that have been configured in HW Setup. In addition, if you press a key other than one of those listed, or if the selected device is not installed, the system will continue to boot according to the current and available settings in HW Setup.*

### **HDD Priority Options**

If more than one hard disk drive is installed in the computer, this option allows you to set the priority associated with hard disk drive detection - the first hard disk drive detected that has a valid boot command on it will be the device from which the computer will start.

---

**Built-in HDD1 ->** The priority is set as built-in HDD1 -> built-in  
**Built-in HDD2 ->** HDD2 -> USB (Default).  
**USB**

---

**Built-in HDD2 ->** The priority is set as built-in HDD2 -> built-in  
**Built-in HDD1 ->** HDD1 -> USB.  
**USB**

---

**Built-in HDD1 ->** The priority is set as built-in HDD1 -> USB ->  
**USB -> Built-in** built-in HDD2.  
**HDD2**

---

**Built-in HDD2 ->** The priority is set as built-in HDD2 -> USB ->  
**USB -> Built-in** built-in HDD1.  
**HDD1**

---

**USB -> Built-in**      The priority is set as USB -> built-in HDD1 ->  
**HDD1 -> Built-in**      built-in HDD2.  
**HDD2**

**USB -> Built-in**      The priority is set as USB -> built-in HDD2 ->  
**HDD2 -> Built-in**      built-in HDD1.  
**HDD1**



- *If a boot command is not found on the first detected hard disk drive, the system will not boot from next hard disk drive in the list, instead it will search for the next device in the Boot Priority list and startup from this as appropriate.*
- *Although, generally, most models have two hard disk drives installed, some models have only one hard disk drive. In the case of models with one hard disk drive, this setting item will not be displayed.*

### USB Memory BIOS Support Type

This option allows you to set the type of the USB memory to be used as a startup device.

**HDD**                      Sets the USB memory to be the equivalent of a hard disk drive (default). With this setting, the USB memory device can be used to start the computer as though it were a hard disk drive based on the hard disk drive settings within both the Boot Priority and HDD Priority options detailed previously.

**FDD**                      Sets the USB memory to be the equivalent of a floppy diskette drive. With this setting, the USB memory device can be used to start the computer as though it were a floppy diskette based on the floppy diskette drive settings within the Boot Priority option detailed previously.

### Keyboard

#### Wake-up on Keyboard

When this feature is enabled, and the computer is in Sleep Mode, you can turn on the system by pressing any key. However, please be aware that this option will only work with the internal keyboard and only when the computer is in Sleep Mode.

**Enabled**                      Enables the Wake-up on Keyboard function.

**Disabled**                      Disables the Wake-up on Keyboard function (Default).



## CPU

This function allows you to set the processor's operating mode.

### Dynamic CPU Frequency Mode

This option allows you to configure the power saving modes associated with the processor - the following settings are available:

|                               |  |
|-------------------------------|--|
| <b>Dynamically Switchable</b> | The processor's power consumption and automatic clock speed switching functions are enabled - in use the processor's operation is automatically switched when necessary (default).                   |
| <b>Always High</b>            | The processor's power consumption and automatic clock speed switching functions are disabled - in use the processor will always run at its highest level of power consumption and its highest speed. |
| <b>Always Low</b>             | The processor's power consumption and automatic clock speed switching functions are disabled - in use the processor will always run at a lower level of power consumption and a low speed.           |

## LAN

### Wake-up on LAN

This feature lets the computer's power be turned on when it receives a wake-up signal from the LAN.



*Do not install or remove a memory module while Wake-up on LAN is enabled.*



*The Wake-up on LAN function consumes power even when the system is off. Leave the AC adaptor connected while using this feature.*

Power will be automatically turned on when a signal is received from an administrator's computer which is connected via a network.

The following settings can be changed when the Built-in LAN is **Enabled**.

Connect the AC adaptor when using the Wake-up on LAN function. The battery retention time will be shorted than the times listed in this manual when this function is enabled. Refer to the section in Chapter 6, [Retaining data with power off](#).

|                 |                                    |
|-----------------|------------------------------------|
| <b>Enabled</b>  | Enables Wake-up on LAN.            |
| <b>Disabled</b> | Disables Wake-up on LAN (Default). |

### ***Built-in LAN***

This feature enables or disables the Built-in LAN.

---

|                 |   |
|-----------------|---|
| <b>Enabled</b>  | Enables Built-in LAN functions (Default). |
| <b>Disabled</b> | Disables Built-in LAN functions.          |

---

### ***Device Config***

#### ***Device Configuration***

This option allows you to set how the computer's hardware devices will be configured.

---

|                    |   |
|--------------------|---|
| <b>All Devices</b> | The computer's BIOS will setup and configure all devices.                                       |
| <b>Setup by OS</b> | The operating system will setup and configure all of the devices that it can control (default). |

---

### ***USB***

#### ***USB KB/Mouse Legacy Emulation***

You can use this option to enable or disable USB keyboard/mouse legacy emulation so that, even if your operating system does not support USB devices, you can still use a standard USB mouse and keyboard - to achieve this you should set the appropriate option(s) to Enabled.

---

|                 |   |
|-----------------|---|
| <b>Enabled</b>  | Enables the USB Keyboard/Mouse Legacy Emulation function (Default). |
| <b>Disabled</b> | Disables the USB Keyboard/Mouse Legacy Emulation function.          |

---

#### ***USB-FDD Legacy Emulation***

You can use this option to enable or disable USB floppy diskette drive legacy emulation so that, even if your operating system does not support USB devices, you can still use a USB floppy diskette drive - to achieve this you should set this option to Enabled.

---

|                 |  |
|-----------------|--|
| <b>Enabled</b>  | Enables the USB floppy diskette drive legacy emulation function (Default). |
| <b>Disabled</b> | Disables the USB floppy diskette drive legacy emulation function.          |

---

## Button Setting

### Start Up Logo

This option lets you select from the following two types of logos which is displayed at computer start up.

|                  |  |
|------------------|--|
| <b>Animation</b> | The Logo appears as an animated image (Default). |
| <b>Picture</b>   | The Logo appears as a static image.              |

### Sound Logo

Use this option to enable or disable sound to sound, when a personal computer is started.

|                 |                                   |
|-----------------|-----------------------------------|
| <b>Enabled</b>  | Enables sound to sound (Default). |
| <b>Disabled</b> | Disables sound to sound.          |

## BIOS Setup Program

This section explains items and procedures other than those setup using the HW Setup program.

### Starting and Ending the BIOS Setup Program



#### Notes Before Using the BIOS Setup Application

- *In most cases, changes to the system's configuration should be made within Windows by using applications such as **TOSHIBA HW Setup**, **TOSHIBA Password Utility**, **Windows Device Manager** and so forth. If you make changes to the configuration through the BIOS setup program, please be aware that the configuration set through the Windows applications will take priority.*
- *Changes to the settings within the BIOS setup program will not be erased even if the power supply is turned off and the main battery removed. However, if the built-in Real Time Clock (RTC) battery runs out of power, most of the settings will revert back to their default values. However, please note that the following items will not be affected in this instance:*
  - Password
  - Hard Disk Drive Password
  - Fingerprint patterns

## Starting the BIOS Setup Program

1. Turn on the computer while pressing the **ESC** key - if the **Password =** prompt is displayed, enter either the Supervisor Password, if one is set, or the User Password and press the **ENTER** key. Please refer to Chapter 6, the *TOSHIBA Password Utility* for further details about the User Password.
2. At the **Check system. Then press [F1] key.** prompt, press the **F1** key - the BIOS setup application will start up.

## Ending the BIOS Setup Program

In order to save the changes you have made and end the BIOS setup application, follow the steps as detailed below:

1. Press the **END** key - this will cause the **Are you sure? (Y/N). The changes you made will cause the system to reboot.** prompt to be displayed at the bottom of the screen.
2. Press the **Y** key - this will save the configuration changes and end the BIOS setup application, automatically restarting the computer.

## Ending the BIOS Setup Program Halfway

The configuration settings can be terminated halfway without saving any of the changes made by following the steps detailed below:

1. Press the **ESC** key - the **Exit without saving? (Y/N)** prompt to be displayed at the bottom of the screen.
2. Press the **Y** key - the BIOS setup application will exit and the computer will automatically restart.

## Supervisor Password

This setting, which is displayed on the first page of the setup screen, Allows you to register a Supervisor Password of the computer.

---

|                       |  |
|-----------------------|--|
| <b>Not Registered</b> | Supervisor Password has not been registered (Default). |
|-----------------------|--|

---

|                   |  |
|-------------------|--|
| <b>Registered</b> | Supervisor Password has been registered. |
|-------------------|--|

---



*The User Password and Supervisor Password configured in BIOS SETUP can also be changed or deleted using the TOSHIBA Password Utility.*

*When unable to perform the following operations, use the TOSHIBA Password Utility to change the configuration or delete the Supervisor Password.*

- *Configuration changes in the BIOS Setup Program*
- *Configuration changes in the HW Setup utility*
- *Selection of the startup device during computer recovery*

## Core Multi - Processing

The Core Multi-Processing sets the CPU operating mode.

The configuration for the Core Multi - Processing is carried out in the BIOS setup program. This setting is displayed on the first page of the setup screen.

|                 |  |
|-----------------|--|
| <b>Enabled</b>  | Enables Core Multi - Processing functions (Default). |
| <b>Disabled</b> | Disables Core Multi - Processing functions.          |

## Virtualization Technology

Virtualization Technology sets enable or disable of the Intel® Virtualization Technology installed in the CPU.

Intel® Virtualization Technology is the technique that allows one machine to operate as multiple virtual machines.



*The Virtualization Technology is supported with some models.*

The Disabled command does not allow use of the Intel® Virtualization Technology.

The Enabled command allows use of the Intel® Virtualization Technology.

|                 |   |
|-----------------|---|
| <b>Enabled</b>  | Enables Virtualization Technology.            |
| <b>Disabled</b> | Disables Virtualization Technology (Default). |

## Enhanced C-States

This feature enables or disables the Enhanced C-States.

The configuration for the Enhanced C-States is carried out in the BIOS setup program. This setting is displayed on the second page of the setup screen.

|                 |  |
|-----------------|--|
| <b>Enabled</b>  | This lowers the power consumption (Default). |
| <b>Disabled</b> | This does not lower the power consumption.   |

## Execute-Disable Bit Capability

This setting, which is displayed on the first page of the setup screen, configures the Execute-Disable Bit function of the computer's processor. This function is specific to Intel® processors and, when activated, helps to reduce security threats to the computer by preventing certain classes of malicious "buffer overflow" attacks when combined with a supporting operating system such as Windows Vista™.

---

|                      |  |
|----------------------|--|
| <b>Available</b>     | Makes the processor's Execute-Disable Bit Capability available for use (Default).            |
| <b>Not Available</b> | Disables the processor's Execute-Disable Bit Capability so that it is not available for use. |

---

## Auto Power On

This is a function for automatically turning on the computer. This item shows the current Auto Power On setting. When Alarm Time, Wake-up on LAN, or Critical Battery Wake-up are Enabled, Auto Power On is also Enabled.

Alarm Time, Wake-up on LAN, on Battery and Critical Battery Wake-up can be configured under OPTIONS.

---

|                 |   |
|-----------------|---|
| <b>Enabled</b>  | Either Alarm Time, Wake-up on LAN, or Critical Battery Wake-up is set to Enabled (Default). |
| <b>Disabled</b> | Alarm Time, Wake-up on LAN, and Critical Battery Wake-up are Disabled.                      |

---

### *on Battery*

The setting is available when the Wake-up on LAN is Enabled.

---

|                 |   |
|-----------------|---|
| <b>Enabled</b>  | Enables Wake-up on LAN function when operating from the battery.            |
| <b>Disabled</b> | Disables Wake-up on LAN function when operating from the battery (Default). |

---

### Critical Battery Wake-up

Configures what action is taken when the remaining battery power is close to running out while the system is in Sleep Mode.

This setting is only available when the Critical battery action in Windows is set to Hibernate (Default).

To access it, **Start -> Control Panel -> System and Maintenance -> Power Options -> Edit Plan Settings -> Change advanced power settings -> Battery.**

The operation of this function is dependent upon battery status.

|                 |   |
|-----------------|---|
| <b>Enabled</b>  | When the remaining battery power is about to run out while the system is in Sleep Mode, the system is automatically woken up and then switched to Hibernation Mode (Default). |
| <b>Disabled</b> | No action is taken even if the remaining battery power is about to run out while the system is in Sleep Mode.   |

### PCI Express Link ASPM

This feature lets you set the PCI Express power-saving configuration.

|                 |   |
|-----------------|---|
| <b>Auto</b>     | Power-saving is enabled when the computer is operating from battery power and the PCI Express device is not being used. |
| <b>Disabled</b> | Disables power-saving for performance.  |
| <b>Enabled</b>  | Enables power-saving when the PCI Express device is not being used.   |

### Qosmio AV Controller

This feature enables or disables the Qosmio AV Controller and the Front operation panel.

|                 |  |
|-----------------|--|
| <b>Enabled</b>  | Enables the Qosmio AV Controller and the Front operation panel function for use (Default). |
| <b>Disabled</b> | Disables the Qosmio AV Controller and the Front operation panel function for use.          |





# Chapter 8

## AV functions

This chapter explains how to use the AV functions.



- *Please refer to the included Qosmio HD DVD Guide for more information on using the HD DVD-ROM drive or HD DVD-R drive model.*
- *The state where Windows Vista™ is active is referred to as Windows mode.*

## Media Center

This section describes the Media Center.



- *You can record TV programs and pictures/movies from external input devices using the TV tuner. To do this, please use the recommended software below:  
To record pictures/movies from external input devices:
  - *Windows Media Center*You cannot use **Windows Movie Maker** or any other software for this purpose.*

Windows Vista™ has the following function.

- Watch TV or a DVD movie.
- Pause, rewind, and fast forward TV programs using the Media Center time shifting feature.
- Watch an instant replay.
- Play back your digital videos.
- View your digital pictures, or play them as a slide show.
- Browse, select, and play music CDs and DVD movies.
- Update the Television Program Guide from the Internet.

When the Media Center is going to be used, be sure that the computer is hooked up to an AC adaptor, and please use the AC power. If this is used under battery power, you are in danger of experiencing recording failures, sound fades, or frames being dropped from videos due to battery depletion.

For more information, refer to the manual in the Microsoft® Windows Vista™.

## Front operation panel

This section describes the panels of the front operation panel in Windows mode.



*Only touch the panels with your fingers. Do not press the panels too strongly, or use a ballpoint pen or any other pointed object to touch the panels. Doing so may damage the panels.*

Eleven panels are available for use:

TV, CD/DVD, Play/Pause, Stop, Previous, Next, Record, Brightness, Illumination On/Off, DOLBY, TV-out.

These panels allow you to manage Audio/Video functions, run applications and access utilities.



*Front operation panel*



### TV panel

Starts Live TV.

If the application you wish to run is not selected as the active window when these panels are touched, please switch to the application manually. For example, by clicking the taskbar item for the application window you wish to make active.



### CD/DVD panel

Touching this panel will launch an application program that allows you to watch a DVD or listen to a CD.

Touching this panel while the computer is on or in Sleep Mode, will launch Media Center. My Music is started when a music CD is inserted in the optical disc drive and My Video is started when a DVD video is in the drive.

If the application you wish to run is not selected as the active window when these panels are touched, please switch to the application manually. For example, by clicking the taskbar item for the application window you wish to make active.









### Play/Pause panel







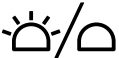

This panel allows you to play/pause chapters or tracks.



### STOP panel

Touch this panel to stop playing a track or chapter.

|   |                                  |   |
|---|----------------------------------|---|
|  | <b>Previous panel</b>            | Touch this panel to move to the previous audio track, DVD chapter or recorded data.   |
|  | <b>Next panel</b>                | Touch this panel to move to the next audio track, DVD chapter or recorded data.   |
|  | <b>Record panel</b>              | Touching this panel when Windows starts to display Manual Recording while using Live TV.  |
|  | <b>Brightness panel</b>          | Touching this panel to change the brightness of the built-in LCD.   |
|  | <b>Illumination On/Off panel</b> | Touch this panel to switch the lighting of indicators (e.g. Front operation panel, power button, Qosmio AV Controller, volume dial, etc). |
| <b>DOLBY</b>  | <b>DOLBY panel</b>               | Touching this panel, to display the windows of a Sound function.  |
|  | <b>TV-out panel</b>              | Touching this panel while Windows is running will switch the display output to a TV.  |

| Icon  | Front operation panel | Windows Media Center  |                               |                                     |
|---|-----------------------|---|-------------------------------|-------------------------------------|
|   |                       | Media Center - My TV (TV)   | Media Center - Play DVD (DVD) | Media Center - My Music (CD)        |
|    | TV                    | Start Live TV   | -                             | -                                   |
|    | CD/DVD                | -   | Run Media Center and play DVD | Run Media Center and start My Music |
|  | Play/Pause            | -   | Play/Pause                    | Play/Pause                          |
|  | Stop                  | -   | Stop                          | Stop                                |
|  | Previous              | -   | Previous chapter              | Previous track                      |
|  | Next                  | -   | Next chapter                  | Next track                          |
|  | Rec                   | Start Recording   | -                             | -                                   |
|  | Brightness            | Changes the brightness level of LCD:<br>1 -> 2 -> ... -> 7 -> 8 -> 1 -> 2 |                               |                                     |

|              |                     |   |
|--------------|---------------------|---|
|              | Illumination On/Off | Switch the lighting of indicators       |
| <b>DOLBY</b> | DOLBY               | Display the windows of a Sound function |
|              | TV-out              | Switch the display output to TV         |

## Qosmio AV Controller

This section describes the Qosmio AV Controller buttons and panels.

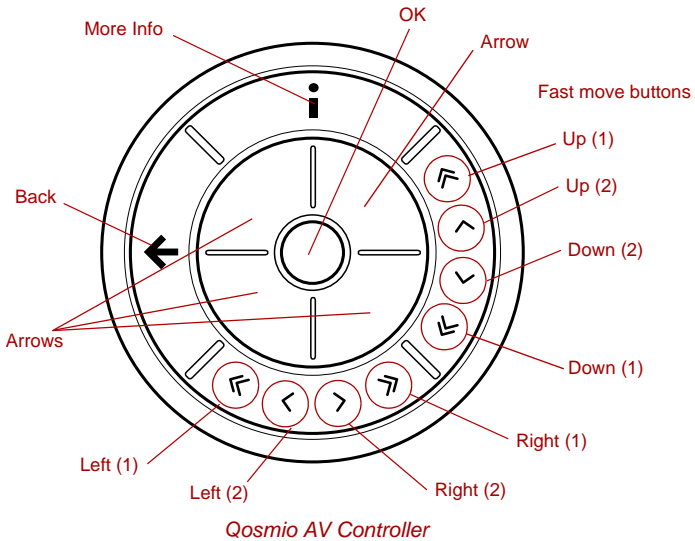

|           |                  |  |
|-----------|------------------|--|
|           | <b>Back</b>      | Displays the previous window.  |
|           | <b>More Info</b> | The button provides more details on a TV program than is listed in the Guide.  |
|           | <b>Arrows</b>    | Moves the cursor to navigate within Media Center windows.  |
| <b>OK</b> | <b>OK</b>        | Selects the desired action or window option. It acts like the <b>ENTER</b> Key. If watching TV in full screen mode, pressing <b>OK</b> switches back to the previous viewed channel. Press again to toggle back. It acts the same way as a Jump button on some TV remote controls. |



### Fast move buttons

Moves the cursor at high speed on the Media Center screen.

Lightly touch the button to move the cursor.

- Up (1) button: Moves the cursor up. This button moves the cursor at a faster speed than the Up (2) button.
- Up (2) button: Moves the cursor up.
- Down (1) button: Moves the cursor down. This button can move the cursor at a faster speed than the Down (2) button.
- Down (2) button: Moves the cursor down.
- Right (1) button: Moves the cursor right. This button can move the cursor at a faster speed than the Right (2) button.
- Right (2) button: Moves the cursor right.
- Left (1) button: Moves the cursor left. This button can move the cursor at a faster speed than the Left (2) button.
- Left (2) button: Moves the cursor to left.

## Remote Controller

Your computer includes a TV Remote Controller which enables you to perform some functions of your computer from a distant location.

The following figure shows the buttons on the Remote Controller.

You can use your Remote Controller with Media Center to play CDs, DVDs and videos, to view pictures and to watch and record television programs.

The Remote Controller helps you navigate through Media Center just as a cable TV remote control navigates cable TV options or controls the playback of a movie in a VCR or DVD player.







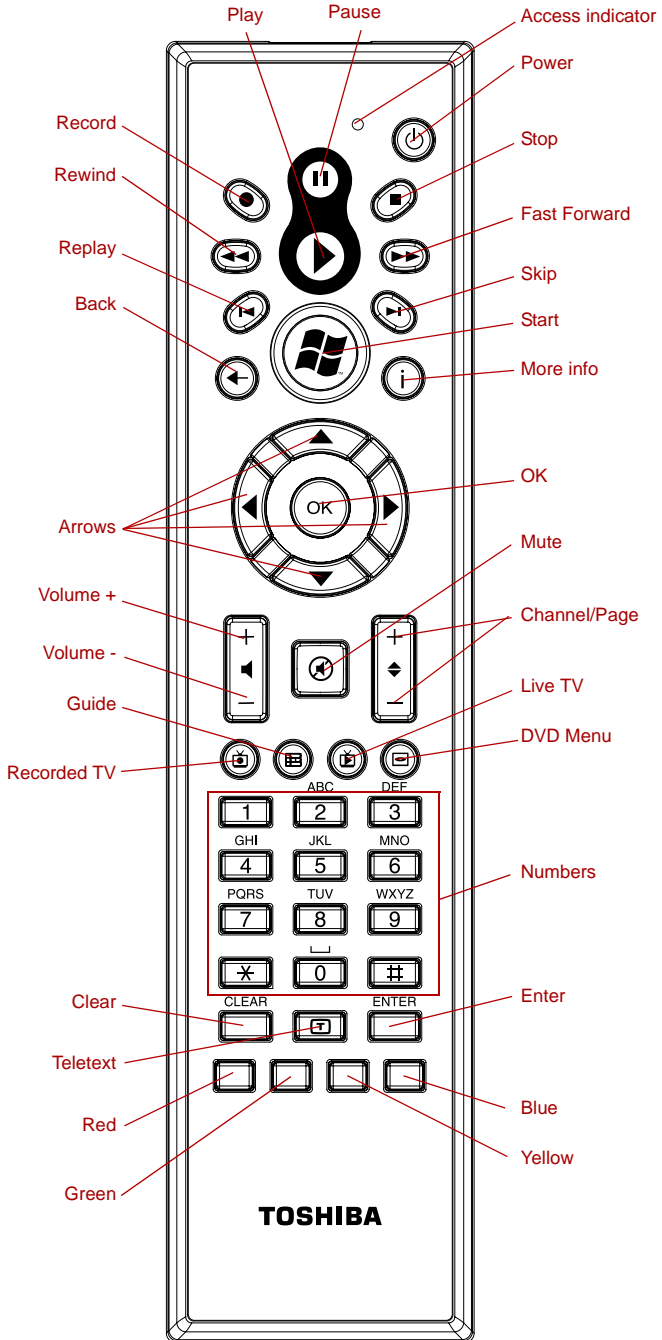



Using the Remote Controller, you can:







- Navigate and control all Media Center windows.
- Control the video or live TV display.
- Place the computer in and out of Sleep Mode.

Refer to the [Using the Remote Controller](#) section in this chapter for information on how to use the Remote Controller as well as how to install and remove its batteries.



Remote Controller

|   |                           |  |
|---|---------------------------|--|
|    | <b>Power</b>              | Starts or terminates the operating system.<br>This button functions like the Power button of your computer. By default, the Sleep Mode is equivalent to the Power Off state of your computer. To change the setting, click <b>Start</b> , select <b>Control panel</b> -> <b>System and Maintenance</b> -> <b>Power Options</b> . The following four options are available: Do nothing, Sleep, Hibernate and Shut down. |
|   | <b>Access indicator</b>   | This indicator will glow while the Remote Controller is sending signals to the computer. Please note that this indicator will not light after the battery has been completely discharged.  |
|    | <b>Record</b>             | Records the selected television program and stores it on your hard disk drive.   |
|    | <b>Stop</b>               | Stops the media currently playing.   |
|    | <b>Pause</b>              | Pauses an audio or video track, and live or recorded TV programs.  |
|    | <b>Play</b>               | Plays the selected media.  |
|    | <b>REW (Rewind)</b>       | Moves the media (video, DVD, music, and so on) backwards.  |
|    | <b>FWD (Fast Forward)</b> | Moves the media (video, DVD, music, and so on) forwards.   |
|   | <b>Replay</b>             | Moves media backward (seven seconds for videos and live TV, one music track or one DVD chapter at a time).   |
|  | <b>Skip</b>               | Moves media forward (30 seconds for videos and live TV, one music track or one DVD chapter).   |
|  | <b>Back</b>               | Displays the previous window.  |
|  | <b>More Info</b>          | The button provides more details on a TV program than is listed in the Guide.  |
|   | <b>Arrows</b>             | Moves the cursor to navigate within Media Center windows.  |

|  |                                |   |
|--|--------------------------------|---|
| OK   | OK                             | Selects the desired action or window option. It acts like the <b>ENTER</b> Key. If watching TV in full screen mode, pressing <b>OK</b> switches back to the previous viewed channel. Press again to toggle back. It acts the same way as a Jump button on some TV remote controls.                                |
|  | Volume +                       | Increases the volume while watching TV, viewing DVD's or replaying CD's.  |
|  | Volume -                       | Decreases the volume while watching TV, viewing DVD's or replaying CD's.  |
|   | Start                          | Opens Media Center to the main window.  |
|  | Channel/Page up(+) and down(-) | Changes the TV channel or moves a page up and down, depending on the available options.   |
|   | Mute                           | Turns your computer sound off.  |
|   | Recorded TV                    | Allows you to start recording of TV programs. The Recorded TV feature of Media Center will be activated.  |
|   | Guide                          | Opens the Television Program Guide to display available TV channels and programs to watch and record.   |
|   | Live TV                        | A shortcut to the full screen view. It also takes you to the current point in a live TV program after pausing live TV.  |
|  | DVD Menu                       | Opens the main menu on a DVD movie, if available.   |
|  | Numbers                        | Allows you to select a channel or chapter number while watching TV, or CD/DVD replay. Numbers, letters or symbols can be entered. To select a channel or chapter number of two or more digits, press the buttons sequentially. For example, press the "1" button and then the "0" button to select the number 10. |
|  | Clear                          | Deletes entered numbers, letters or symbols.  |
|  | Enter                          | The OK button on the Remote Controller has the same functions.  |



|  |  |
|--|--|
| <b>Red, Green, Yellow and Blue buttons</b> | It jumps to a registration link.<br>These buttons are not provided with some models.     |
| <b>Teletext</b>                            | Starts or terminates the Teletext mode.<br>This button is not provided with some models. |

## Using the Remote Controller

This computer includes a remote control unit, which allows you to control some of your computer's functions from a distant location.



- *The Remote Controller is designed specifically for this computer.*
- *Some application programs may not support remote control functions.*

### Operational range of the Remote Controller

Point the Remote controller at your computer and press a button. The operational angle and distance are described below.

|                 |   |
|-----------------|---|
| <b>Distance</b> | Within 5 m from the infrared receiver window.   |
| <b>Angle</b>    | Within a 30 degree horizontal and 15 degree vertical range of the infrared receiver window. |

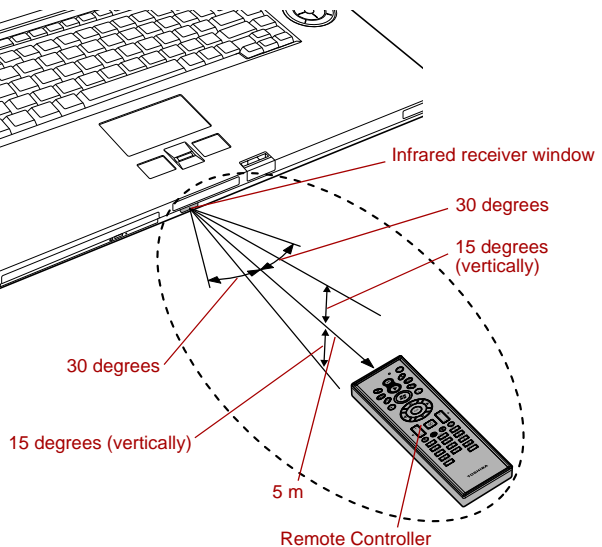

*Operational range of the remote control*

\* The appearance of the provided Remote Controller may vary from model to model.



*Even if within the effective scope as described above, the remote control may malfunction or not work correctly in the following cases.*

- *When an obstacle stands between the infrared receiver window of your computer and the Remote Controller.*
- *When direct sunlight or strong fluorescent light strikes the infrared receiver window.*
- *When the infrared receiver window or the infrared emission part of the Remote Controller is dirty.*
- *When other computers which use an infrared remote controller are used near to your computer.*
- *When a low battery condition is present*

## Installing/Removing batteries

Be sure to install the dry batteries provided with this product before using the Remote Controller.

The procedures for installing and removing the batteries vary depending on the type of the Remote Controller. Check the type and then install or remove the batteries as instructed.



*Store the battery for the remote control beyond the reach of children.*

*If a child swallows a battery, this might result in choking. If it happens, contact a doctor immediately.*



*Observe the following precautions when using the battery of the Remote Controller.*

- *Do not use batteries other than those specified.*
- *Ensure that you insert the batteries with their polarities correctly aligned (+ or -).*
- *Do not recharge, heat, disassemble or short the battery, or put it into a fire or flame.*
- *Do not use a battery whose "recommended expiration date" has been reached, or which is completely discharged.*
- *Do not use different types of batteries or old and new batteries at the same time.*
- *Do not carry the battery together with metal necklaces, hairpins or other metal accessories.*
- *When storing or disposing of used batteries, make sure to put some insulation tape on their terminals (+ and -) to avoid short-circuits.*

*If these precautions are not followed, heating, fluid leakage or explosion may occur. This may cause burns or personal injury. If battery fluid gets on your skin or clothes, wash immediately with clean water. If battery fluid gets in your eyes, rinse your eyes with clean water immediately and see a doctor. Do not touch the battery fluid on instruments or devices with bare hands. Wipe off with a cloth or paper towel.*

## Type of battery that can be used for the Remote Controller

When the batteries shipped with the Remote Controller are discharged, replace them with commercially available AA manganese batteries or AA alkaline batteries. Other types or battery should not be used.

## Installing the batteries

1. Open the battery cover on the back of the Remote Controller.  
Slide the cover in the direction of the arrow to remove the cover.

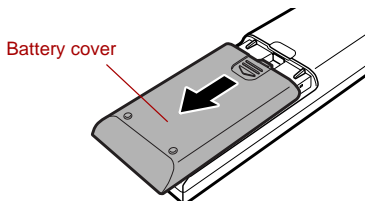

*Opening the battery cover*

2. Insert the batteries in place.  
Be sure to place the batteries with their polarities (+ and -) in the correct position.

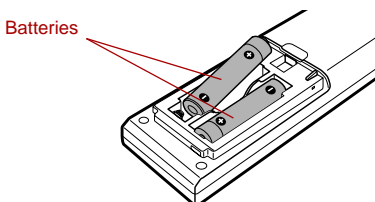

*Inserting the batteries*

3. Close the battery cover.  
Close the cover securely until it clicks.

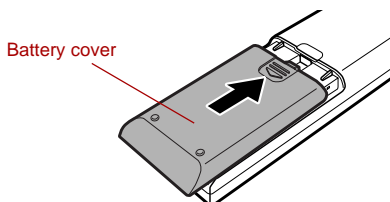

*Closing the battery cover*

## Replacing the batteries

When the batteries in the Remote Controller reach the end of their life, the Remote Controller may not operate correctly or work only within a short distance from your computer. In this instance, you should purchase new batteries and replace the discharged ones.

1. Open the battery cover on the back of the Remote Controller.
2. Replace the batteries.  
Be sure to place the batteries with their polarities (+ and -) in the correct position.

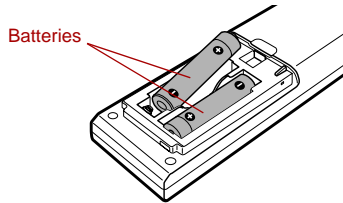

*Removing the batteries*

3. Close the battery cover.  
Close the cover securely until it clicks.

## Set-top box Connection Method and Watching TV on the Media Center

This section explains how to connect the set-top box and configure settings for watching TV.

### Connecting the set-top box

Connect the computer and set-top box using the following procedure to watch TV using the set-top box.

1. Connect the infrared transmitter cable to the computer. Please note that the infrared remote control for your set-top box must be compatible in order to function.

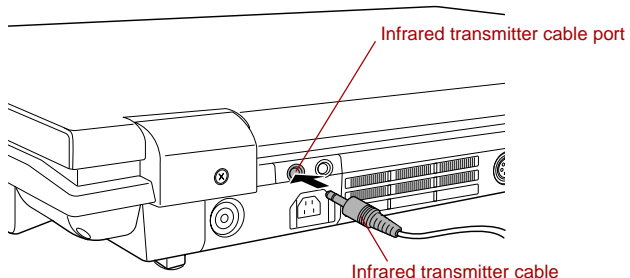

*Connecting the infrared transmitter cable*

2. Connect the VIDEO-IN cable that is bundled with some models.
3. Insert the output cable plug for connecting to the set-top box to the audio input terminals (red: audio right, white: audio left) and the video input connector (yellow) of the VIDEO-IN cable.

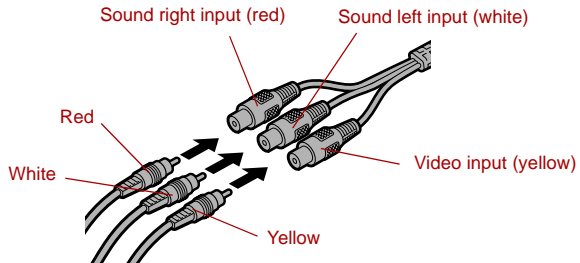

*Connecting the cable*

4. Insert one end of the VIDEO-IN cable into the VIDEO-IN port of your computer.

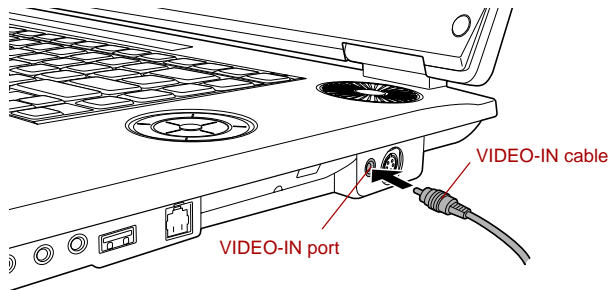

*Connecting the VIDEO-IN port*

5. Connect the other end of the output cable plug to the output terminals of the set-top box.

Use the bundled VIDEO-IN cable and connect to VIDEO-IN port on the right side of the computer.

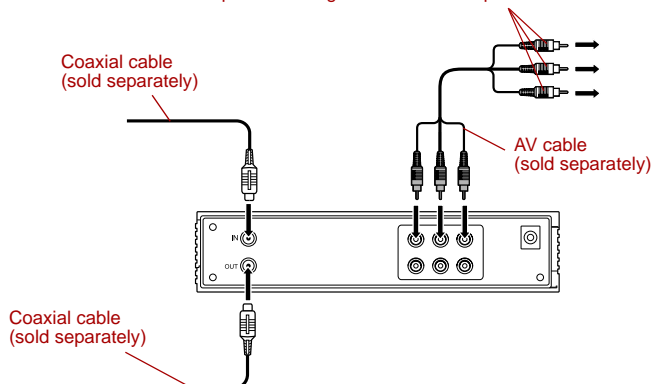

*Connection method for the computer and set-top box*

## Media Center Environment Settings

### **Activating Media Center for the first time**

1. Activate Media Center.

The setup screen appears. Configure settings according to your environment.

Follow the screen instructions and configure settings according to the environment used.

### **Changing settings**

Refer to the following procedures to change settings that are already configured.

1. Activate Media Center.
2. Click in the following order: click **Tasks** -> **settings** -> **TV** -> **Set Up TV Signal**.
3. The Set Up Your TV Signal window is displayed, and click **Next**.
4. Follow the screen instructions and configure settings according to the environment used.



*Image data cannot be imported, edited, watched or saved to DVD by connecting the Media Center model to external devices such as TV, video deck or analog video camera.*

### **Dual Tuner configurations**

Use the following procedure to configure Media Center environment settings for dual tuner models.



*Some computer models are equipped with a tuner capable of receiving digital broadcasts. These tuners can receive DVB-T digital broadcasts. Digital broadcasts cannot be received in regions where DVB-T digital broadcasts are not available.*

### **Configuring 2 tuners to receive simultaneously**

This computer is equipped with 2 tuners, the TOSHIBA TV Tuner and the TOSHIBA TV Tuner w/o AV-in. Both tuners can receive TV broadcasts.

In order to simultaneously receive broadcasts on both tuners, check both the TOSHIBA TV Tuner and TOSHIBA TV Tuner w/o AV-in items on the "TV Signal screen" configuration screen in Media Center.



*If only one item is checked, only the tuner which corresponds to the checked item will be configured, and simultaneous reception and recording will not be possible.*

## Settings for connecting an external video device, the set-top box or other external device

When connecting an external video device, the set-top box or other analog device to the computer S-VIDEO or AV-IN ports, check the TOSHIBA TV Tuner item on the “TV Signal screen” configuration screen in Media Center, and uncheck the TOSHIBA TV Tuner w/o AV-in item.



- *Simultaneous reception and recording cannot be used when an external video device is connected and the above settings are made. Once the external video device is disconnected, simultaneous reception and recording can again be used by following the instructions in [Configuring 2 tuners to receive simultaneously](#).*
- *Simultaneous reception and recording cannot be used when the set-top box is connected and the above settings are made.*

Refer to the [Connecting the set-top box](#) for set-top box connection methods.

Refer to Chapter 9, [Optional Devices](#), when connecting an analog video camera, video deck, or other external video device.

## Connecting the Video devices

This section explains configuration methods for connecting the video devices.

### Connecting the VIDEO-IN port

This port allows you to import video data from analog video cameras or video decks by connecting your computer to this type of device. Imported video can be edited or written to a DVD disc.

1. Insert one end of the VIDEO-IN cable into the VIDEO-IN port of your computer.

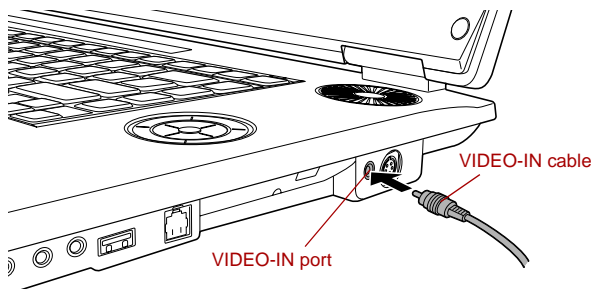

*Connecting the VIDEO-IN port*

2. Insert the other end of the VIDEO-IN cable into the output port of the analog device you wish to connect.





# Chapter 9

## Optional Devices

Optional devices can expand the computer's capabilities and its versatility. This chapter describes the connection or installation of the following devices which should be available from your reseller or TOSHIBA dealer:



*To connect optional devices (such as USB device or External monitor) to the computer, be sure to check the shape and orientation of the connector before connecting.*

### **Cards/memory**

- PC Card
- ExpressCard
- Bridge media slot
  - Secure Digital (SD) Card (SD memory card, SDHC memory card, miniSD Card, microSD Card)
  - Memory Stick (Memory Stick, Memory Stick PRO, Memory Stick PRO Duo)
  - xD picture card
  - MultiMediaCard
- Memory expansion

### **Power devices**

- Battery packs
- Universal AC Adaptor
- Battery Charger

### **Peripheral devices**

- Hard disk drive pack
- USB floppy disk drive
- External monitor
- TV
- HDMI
- S-Video-in
- i.LINK (IEEE1394)

### **Other**

- Security lock

## PC Card

The computer is equipped with a single PC Card slot that can accommodate a Type II format card. Any PC Card that meets industry standards, either manufactured by TOSHIBA or another vendor, can be installed as the slot supports 16-bit PC Cards and 32-bit CardBus cards. For reference, CardBus supports the newer standard of 32-bit PC Cards and provides superior performance for the greater demands of applications such as multimedia data transmission.



*PC Cards can sometimes become hot during computer operation. Before you remove a PC Card always wait for it to cool. You could get burned removing a hot PC Card.*

### Inserting a PC Card

The Windows hot-install feature allows you to insert PC Cards while the computer is turned on.



*Do not insert a PC Card while the computer is in Sleep Mode or Hibernation Mode as you may find that some cards do not work properly.*

To insert a PC Card, follow the steps as detailed below:

1. Press the PC Card eject button to partially extend it out of the computer.
2. Press the extended PC Card eject button in order to eject the Dummy card partially out of the computer.
3. Grasp the Dummy card and draw it.
4. Insert the PC Card into the PC Card slot on the side of the computer.
5. Press the PC Card gently to ensure a firm connection is made.

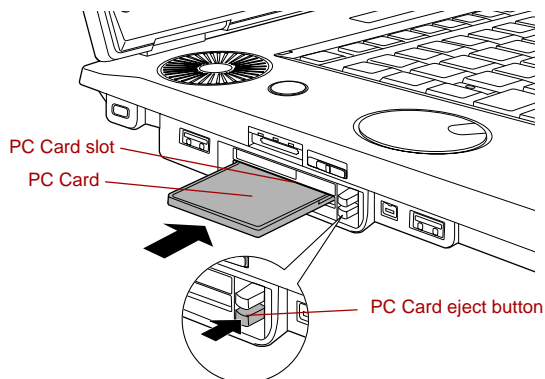

*Inserting the PC Card*

6. After inserting the PC Card you should refer to its documentation and also check the configuration in Windows in order to ensure that it is correct.

## Removing a PC Card

To remove a PC Card, follow the steps as detailed below:

1. Open the **Safely Remove Hardware** icon on the Windows Task Bar.
2. Point to **PC Card** and click the left Touch Pad control button.
3. Press the PC Card eject button to partially extend it out of the computer.



*If the PC Card is not inserted all the way into the computer, the eject button may not cause it to pop out sufficiently to allow it to be grasped. In this instance, simply push the PC Card firmly back into the computer and then press the eject button again.*

4. Press the extended eject button in order to eject the PC Card partially out of the computer.
5. Grasp the PC Card and remove it.

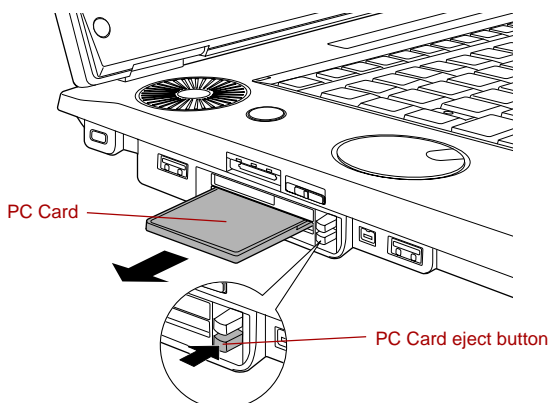

*Removing the PC Card*

6. Insert the Dummy card into the PC Card slot.



*When you do not use a PC card, please be sure to insert a Dummy card.*

## ExpressCard

The computer is equipped with a single ExpressCard slot into which any ExpressCard device that meets industry standards, either manufactured by TOSHIBA or another vendor, can be installed. The slot supports hot plug connection and utilizes the PCI Express interface that supports the reading and writing of data at a theoretical maximum rate of 2.5Gbps.

### Inserting an ExpressCard

The Windows hot-install feature allows you to insert ExpressCards while the computer is turned on.



- *Do not insert an ExpressCard while the computer is in Sleep Mode or Hibernation Mode as you may find that some cards do not work properly.*
- *Please note that the ExpressCard slot is the top one of the two slots located on the left hand side of the computer - please confirm this with the following illustration in order to avoid any confusion with the PC Card slot.*

To insert an ExpressCard, follow the steps as detailed below:

1. Press the PC Card eject button to partially extend it out of the computer.
2. Press the extended PC Card eject button in order to eject the Dummy card partially out of the computer.
3. Grasp the Dummy card and draw it.
4. Insert the ExpressCard into the ExpressCard slot on the side of the computer.
5. Press the ExpressCard gently to ensure a firm connection is made.

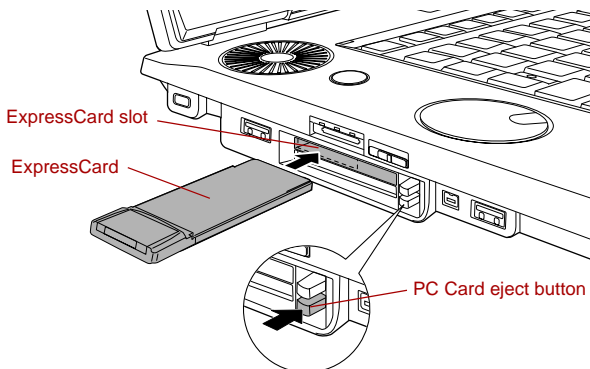

*Inserting the ExpressCard*

6. After inserting the ExpressCard you should refer to its documentation and also check the configuration in Windows in order to ensure that it is correct.

## Removing an ExpressCard

To remove an ExpressCard, follow the steps as detailed below.

1. Open the **Safely Remove Hardware** icon on the Windows Task Bar.
2. Point to **ExpressCard** and click the left Touch Pad control button.
3. Press the ExpressCard eject button to partially extend it out of the computer.



*If the ExpressCard is not inserted all the way into the computer, the eject button may not cause it to pop out sufficiently to allow it to be grasped. In this instance, simply push the ExpressCard firmly back into the computer and then press the eject button again.*

4. Press the extended eject button in order to eject the ExpressCard partially out of the computer.
5. Grasp the ExpressCard and remove it.

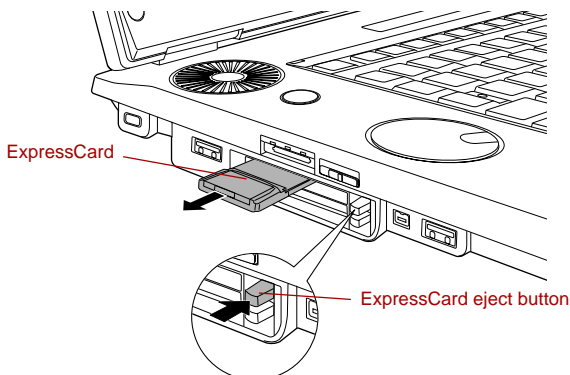

*Removing the ExpressCard*

6. Insert the Dummy card into the PC Card slot.



*When you do not use a PC card, please be sure to insert a Dummy card.*

## Bridge media slot

The computer is equipped with a Bridge media slot that can accommodate some kinds of memory media with various memory capacities so that you can easily transfer data from devices, such as digital cameras and Personal Digital Assistants.



- *Keep foreign objects out of the Bridge media slot. Never allow metal objects, such as screws, staples and paper clips, to enter the computer or Keyboard. Foreign metal objects can create a short circuit, which can cause computer damage and fire, possibly resulting in serious injury.*
- *Memory Stick Duo is not compatible with the Bridge media slot. Do not insert Memory Stick Duo into the slot or you may not be able to remove it. Data may be lost or damaged if you use any memory media other than those supported.*



- *This Bridge media slot supports the following memory media.*
  - *Secure Digital (SD) Card (SD memory card, SDHC memory card, miniSD Card, microSD Card)*
  - *Memory Stick (Memory Stick, Memory Stick PRO, Memory Stick PRO Duo)*
  - *xD picture card*
  - *MultiMediaCard (MMC)*
- *Please note that an adaptor is required to use miniSD/microSD Card.*
- *Please note that an adaptor is required to use Memory Stick PRO Duo.*
- *Please note that not all memory media have been tested and verified to work correctly. Therefore, it is not possible to guarantee that all memory media will operate properly.*
- *The slot does not support Magic Gate functions.*



Secure Digital (SD) Card



Memory Stick



xD picture card



MultiMediaCard (MMC)

*Examples of memory media*

## Memory media

This section provides the important safety precautions in order to handle your memory media.

### Points to note about the SD/SDHC memory card

SD/SDHC memory cards comply with SDMI (Secure Digital Music Initiative), which is a technology adopted to prevent unlawful copy or playback of digital music. For this reason, you cannot copy or playback protected material on another computer or other device, and you may not reproduce any copyrighted material except for your personal enjoyment.

Below is a simple explanation for distinguishing SD memory cards from SDHC memory cards.

- SD and SDHC memory cards appear the same externally.
- The logo on SD and SDHC memory cards is different, so pay careful attention to the logo when purchasing.



■ The SD memory card logo is () .

■ The SDHC memory card logo is () .

- The maximum capacity of SD memory cards is 2GB. The maximum capacity of SDHC memory cards is 8GB.

| Card Type | Capacities   |
|-----------|--|
| SD        | 8MB, 16MB, 32MB, 64MB, 128MB, 256MB, 512MB, 1GB, 2GB |
| SDHC      | 4GB, 8GB   |

### Memory media format

New media cards are formatted according to specific standards. If you wish to reformat a media card, be sure to do so with a device that uses media cards.

#### Formatting an SD/SDHC memory card

SD/SDHC memory cards are sold already formatted in conformity to specific standards. If you format the SD/SDHC memory card again, be sure to format it with the TOSHIBA SD Memory Card Format utility, not with the format command provided within Windows.

In order to run the TOSHIBA SD Memory Card Format utility, click **Start -> All Programs -> TOSHIBA -> Utilities -> SD Memory Card Format**.



*The TOSHIBA SD Memory Card Format utility does not format the protected area of the SD/SDHC memory card - should you need to format all areas of the memory card, including the protected area, you will need to obtain an appropriate application that applies the copy protection system.*

## **Memory media care**

Observe the following precautions when handling the memory media.

- Memory media have a limited lifespan, so it is important to backup important data.
- Do not write to memory media if the battery power is low. Low power could affect writing accuracy.
- Do not remove memory media while read/write is in progress.
- Memory media is designed so that it can be inserted only one way. Do not try to force the media into the slot.
- Do not leave memory media partially inserted in the slot. Press the memory media until you hear it click into place.
- Do not twist or bend memory media.
- Do not expose memory media to liquids or store in humid areas or lay the media close to containers of liquid.
- After using memory media, return it to its case.
- Do not touch the metal part or expose it to liquids or let it get dirty.



*For more details on using memory media, see manuals accompanying the media.*

## **About the write-protect**

The following memory media have a function for protect.

- SD Card (SD memory card, SDHC memory card)
- Memory Stick (Memory Stick, Memory Stick PRO, Memory Stick PRO Duo)
- MultiMediaCard (MMC)



*Set the write-protect switch to the lock position, if you do not want to record data.*



## Inserting a memory media

The following instructions apply to all types of supported media devices. To insert a memory media, follow the steps as detailed below:

1. Turn the memory media so that the contacts (metal areas) are face down.
2. Insert the memory media into the Bridge media slot on the side of the computer.
3. Press the memory media gently to ensure a firm connection is made.

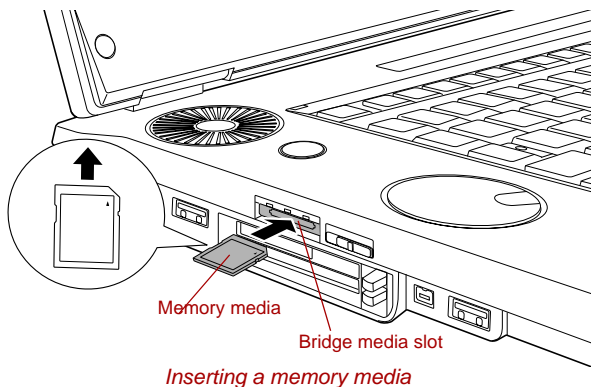

- *Make sure memory media is oriented properly before you insert it. If you insert the media in wrong direction, you may not be able to remove it.*
- *When inserting memory media, do not touch the metal contacts. You could expose the storage area to static electricity, which can destroy data.*
- *Do not turn the computer off or switch to Sleep Mode or Hibernation Mode while files are being copied - doing so may cause data to be lost.*

## Removing a memory media

The following instructions apply to all types of supported media devices. To remove a memory media, follow the steps as detailed below:

1. Open the **Safely Remove Hardware** icon on the Windows Task Bar.
2. Point to **memory media** and click the left Touch Pad control button.
3. Press the memory media to partially extend it out of the computer.
4. Grasp the media and remove it.

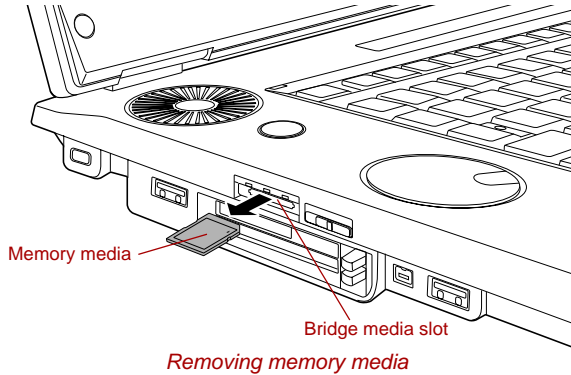

- *Make sure the **Bridge Media** slot indicator is out before you remove the memory media or turn off the computer's power. If you remove the memory media or turn off the power while the computer is accessing the memory media, you may lose data or damage the media.*
- *Do not remove the memory media while the computer is in Sleep or Hibernation Mode. The computer could become unstable or data in the memory media could be lost.*
- *Do not remove only the miniSD/microSD Card while leaving the adaptor in the Bridge Media slot.*

## Memory expansion

You can install additional memory into the computer in order to increase the amount of system memory that is available. This section describes how to install and remove optional memory modules.



- *You should place a mat beneath the computer in order to prevent the computer's lid from becoming scratched or damaged when you are installing/replacing the memory module. In this instance you should avoid mats that are made of materials that hold or generate static electricity.*
- *When installing or removing a memory module, you must ensure that you do not touch any other internal areas of the computer.*
- *Insert the two memory modules into Slot A and Slot B respectively. The computer will operate in dual channel mode. You can access the inserted memory modules efficiently in dual channel.*



- *Use only memory modules approved by TOSHIBA.*
- *Do not try to install or remove a memory module under the following conditions.*
  - a. *The computer is turned on.*
  - b. *The computer was shut down in either Sleep or Hibernation Mode.*
  - c. *Wake-up on LAN is enabled.*
  - d. *Wake-up on Wireless LAN is enabled.*
  - e. *The wireless communication switch is turned on.*
- *Be careful not to let screws or other foreign matter fall into the computer. It could cause malfunction or electric shock.*
- *Expansion memory is a precision electronic component that may be fatally damaged by static electricity. Since the human body can carry static electricity, it is important that you discharge yourself before touching or installing any expansion memory modules. To discharge your body's static electricity, simply touch any metal close to you with bare hands.*
- *In order to ensure that the computer power is not turned on while working, set the Wireless communication switch to OFF.*

## Point to note about memory module error

If you install a memory module that is not compatible with the computer, the **Power** indicator will flashes (on for 0.5 seconds, off for 0.5 seconds) in the following ways;

- If there is an error in only Slot A or no memory module is inserted in Slot A: repeatedly flashes orange twice, then green.
- If there is an error in Slot B: repeatedly flashes orange, then green twice.
- If there are errors in both Slot A and Slot B: repeatedly flashes orange twice, then green twice.

In all instances you should shut down the computer and remove the incompatible module(s).



*Use a #0 point Phillips screwdriver to remove and fasten the screws - the use of an incorrect screwdriver can damage the screw heads.*

## Installing a memory module

The computer contains slots for two memory modules, one positioned immediately over the other - the procedures are the same for installing either module.

1. Set the computer to Boot Mode and turn its power off - make sure the **Power** indicator is off (refer to the [Turning off the power](#) section in Chapter 3, [Getting Started](#), if required).
2. Remove the AC adaptor and all cables and peripherals connected to the computer.
3. Turn the computer upside down and remove the battery pack (refer to [Replacing the battery pack](#) section in Chapter 6, [Power](#), if required).
4. Loosen the two screws securing the memory module cover in place - please note that this screw is attached to the cover in order to prevent it from being lost.
5. Slide your fingernail or a thin object under the cover and lift it off.

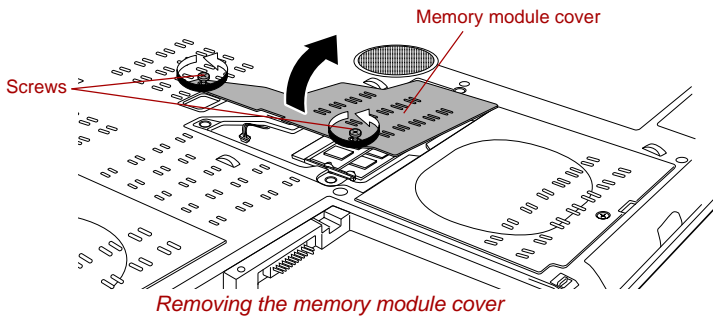

- Align the notch of the memory module with that of the memory slot and gently insert the module into the slot at about a 45 degree angle before pressing it down until the latches on either side snap into place.

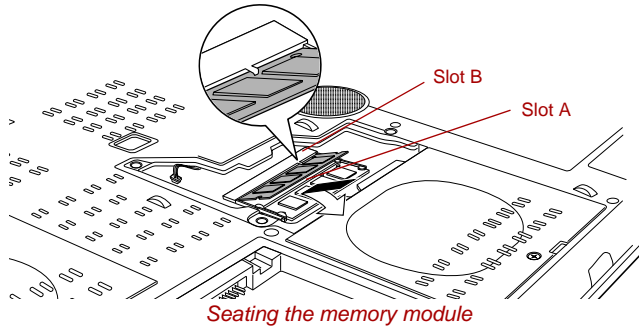

- *Slot A is reserved for the first memory module. Use slot B for expansion memory modules. If only one module is installed, use slot A.*
- *When inserting or removing memory modules, make sure to use the correct slot (A or B). On this computer the lower slot is slot A.*
- *Align the grooves along the edges of the memory module with the locking tabs on the connector and insert the module into the connector firmly - if you find it difficult to install the memory module, gently prise the locking tabs outwards using the tip of your finger. Please also ensure that you hold the memory module along its left and right hand edges - the edges with the grooves in.*



- *Never allow metal objects, such as screws, staples and paper clips, to enter the computer or keyboard. Foreign metal objects can create a short circuit, which can cause computer damage and fire, possibly resulting in serious injury.*
- *Do not touch the connectors on the memory module or on the computer. Debris on the connectors may cause memory access problems.*

7. Seat the memory module cover in place and secure it with two screws.



*Take care to ensure that the memory module cover is firmly closed.*

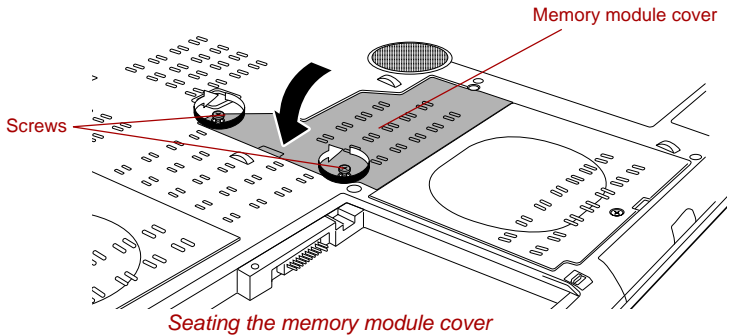

8. Install the battery pack - refer to [Replacing the battery pack](#) section in Chapter 6, [Power](#), if required.
9. Turn your computer over.
10. Turn the computer on and make sure the added memory is recognized - to confirmed it, **Start** -> **Control Panel** -> **System and Maintenance** -> **System** icon.

## Removing a memory module



*The slot A is reserved for main memory. Use the slot B for expanded memory. If only one card is installed, use the slot A.*

To remove the memory module, follow the steps as detailed below:

1. Set the computer to Boot Mode and turn its power off - make sure the **Power** indicator is off (refer to the [Turning off the power](#) section in Chapter 3, [Getting Started](#), if required).
2. Remove the AC adaptor and all cables and peripherals connected to the computer.
3. Turn the computer upside down and remove the battery pack (refer to [Replacing the battery pack](#) section in Chapter 6, [Power](#), if required).
4. Loosen the two screws securing the memory module cover in place - please note that this screw is attached to the cover in order to prevent it from being lost.
5. Slide your fingernail or a thin object under the cover and lift it off.
6. Push the latches away from the module in order to release it - a spring will force one end of the module up at an angle.

- Grasp the module by its edges and remove it from the computer.



- *If you use the computer for a long time, the memory modules and the circuits located close to the memory modules will become hot. In this case, let them cool to room temperature before you replace them.*
- *Do not touch the connectors on the memory module or on the computer. Debris on the connectors may cause memory access problems.*

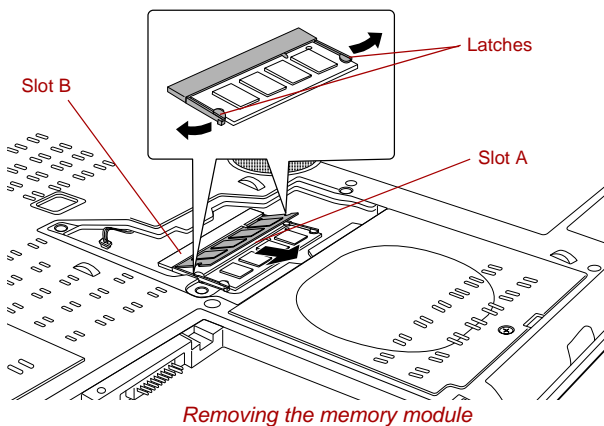

- Seat the memory module cover in place and secure it with two screws.



*Take care to ensure that the memory module cover is firmly closed.*

- Install the battery pack - refer to [Replacing the battery pack](#) section in Chapter 6, [Power](#), if required.
- Turn your computer over.

## Battery Packs

You can increase the portability of the computer with additional battery packs so that, if you're away from an AC power source and your battery runs low, you can replace it with a freshly charged battery. Please refer to Chapter 6, [Power](#) for further information.

## Universal AC Adaptor

If you frequently use your computer at more than one site, it may be convenient to purchase an additional AC adaptor to be kept at each site in order to remove the need to always carry the adaptor with you.

## Battery Charger

The battery charger provides a convenient way to charge up to two Lithium Ion battery packs without requiring the use of your computer.

## USB floppy disk drive

The USB floppy disk drive accommodates either a 1.44MB or 720KB a 3 2/1" floppy disk and connects to one of the computer's USB ports.



*The USB floppy disk drive is available only as an option.*

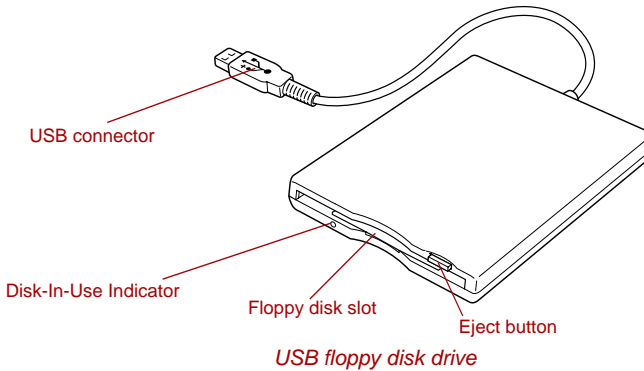

|                              |   |
|------------------------------|---|
| <b>USB connector</b>         | Insert this connector into one of the free USB ports of your computer.  |
| <b>Disk-In-Use Indicator</b> | This indicator glows when the floppy disk is being accessed.  |
| <b>Floppy disk slot</b>      | Insert a floppy disk into this slot.  |
| <b>Eject button</b>          | When a floppy disk is fully seated in the drive, the eject button will pop out. In order to remove the disk, push the eject button in order to cause it to partially pop out of the drive and then remove it. |



*Check the **Disk-In-Use** indicator when you use the floppy disk drive. Do not press the eject button or turn off the computer while the light is glowing. Doing so could destroy data and damage the floppy disk or the drive.*





*In use, the following should be noted regarding the operation of the USB floppy disk drive:*

- *The drive should be placed on a flat, horizontal surface.*
- *Do not set the drive on an incline greater than 20° while it is operating.*
- *Do not place anything on top of the drive.*

## Using the USB floppy disk drive

The USB floppy disk drive accommodates either a 1.44MB or 720KB floppy disk and connects to one of the computer's USB ports.

### Connecting the USB floppy disk drive

To connect the drive, plug the floppy disk drive's USB connector into one of the computer's free USB ports.



*Make sure the connector is right side up and properly aligned with the socket. Do not try to force the connection; doing so can damage the connecting pins.*

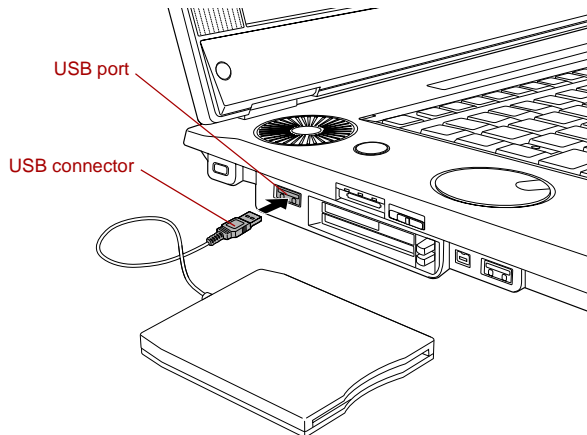

*Connecting the USB floppy disk drive*



*If you connect the USB floppy disk drive after the computer has already been turned on, it will take about ten seconds for it to be recognized by the computer. Do not attempt to disconnect and reconnect the drive before this period has elapsed.*

## Disconnecting the USB floppy disk drive

When you have finished using the USB floppy disk drive, you can follow the procedures below in order to disconnect it:

1. Wait for the Disk-In-Use Indicator light to go out to make sure all floppy disk activity has stopped.



*If you disconnect the floppy disk drive or turn off the power while the computer is accessing the drive you may lose data or damage the floppy disk or the drive.*

2. Click the **Safely Remove Hardware** icon on the Task Bar.
3. Click the USB floppy disk drive device that you want to remove.
4. Carefully pull the floppy disk drive's USB connector out from within the computer's USB port.

## External monitor

An external analog monitor can be connected to the computer's external monitor port, with the computer supporting WUXGA video mode. In order to connect a monitor, follow the steps as detailed below:

1. Turn the computer's power off.
2. Connect the monitor cable to the external monitor port and tighten the screws on the left and right hand side of the connector as required.

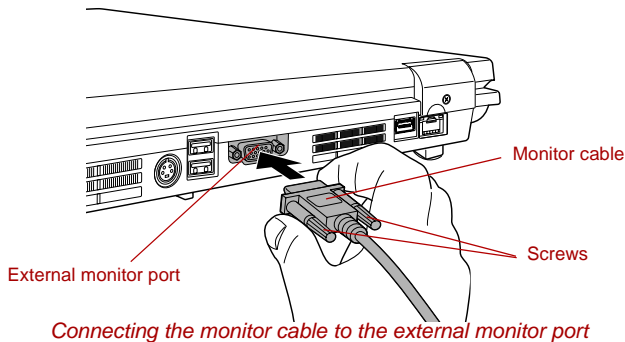

3. Turn the external monitor's power on.
4. Turn the computer's power on.

When you turn on the power, the computer will automatically recognize the monitor and determine whether it is a color or monochrome device. In the event that you find that there are issues getting an image displayed on the correct monitor, you should consider using the **FN + F5** hot key to change the display settings (if you then disconnect the external monitor before you turn the computer's power off, be sure to press **FN + F5** hot key again to switch to the internal display).

Please refer to Chapter 5, [The Keyboard](#), for further details on using hot keys to change the display setting.



*Do not disconnect the external monitor while in Sleep or Hibernation Mode. Turn off the computer before disconnecting the external monitor.*

## TV

The S-Video data on your computer can be viewed on a TV set. To do so, connect your computer's S-Video out port to the TV using the S-Video out cable.

You can use the hotkeys **FN + F5** to change the display device. Refer to Chapter 5, *The Keyboard*.

### Installation

#### **Connection via the S-Video out port**

1. Plug one end of the S-Video out cable into the S-Video out port of your computer.

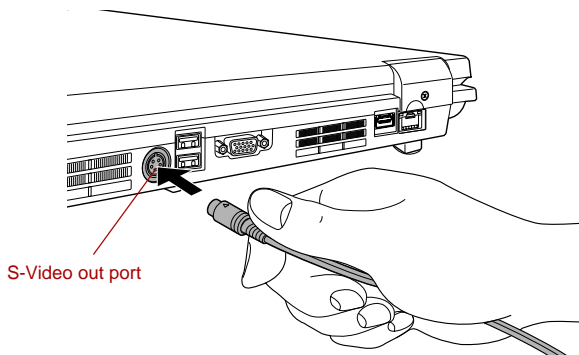

*Connecting the S-Video out port*

2. Insert the other end of the S-Video out cable into the S1-/S2 video input of the TV set. You can then either use the computer's speakers or a set of headphones connected to the headphone jack to get sound.

## Settings for display video on TV

To view video on the TV set, be sure to configure the following settings otherwise you may find that nothing is displayed.



- *Be sure to use the **FN + F5** Hot Key to select the display device before starting to play video. Do not change the display device while playing video.*
- *Do not change the display device under the following conditions.*
  - *While data is being read or written*
  - *While communication is being carried out*

Before changing TV Type, please set to Internal Flat Panel plus TV Dual View or Clone mode by **FN + F5**.

1. Click **Start** and click **Control Panel**.
2. Click **Additional Options**.
3. Click **NVIDIA Control Panel**.
4. Click **Video & Television**.
5. Click **Change the signal** or **HD format**.
6. Select one of the connector type "S-Video - NTSC or PAL standard definition televisions" or "Auto detected".
  - \*Other selection may be listed but please don't select them.
7. Select the one of the below selection at "3. Select the signal format you would like to use".

| Country/Region | Signal Format |
|----------------|---------------|
| Any            | M/NTSC        |
| Any            | M(Japan)/NTSC |
| Any            | B/PAL         |

\*Other selection may be listed but please don't select them.

8. Click **Apply** button.

## Changing the resolution

After you connect an NTSC format television, follow the steps detailed below in order to set the display resolution to 640x480 pixels.

1. Click **Start** and click **Control Panel**.
2. Click **Appearance and Personalization**, click **Personalization** and click the **Display Settings** to open the **Display Settings** window.
3. Click the **Advanced Settings...** button.
4. Select the **Adapter** tab, then select **List All Modes...** button.
5. Select **640 by 480, True Color (32 bit), 60 Hertz**.

## HDMI

A HDMI monitor can be connected to the HDMI out port on the computer. To connect monitor, follow the steps as detailed below:



*As the port operation of all HDMI (High-Definition Multimedia Interface) monitors have not been confirmed, some HDMI monitors may not function properly.*

1. Click **Start** and click **Control Panel**.
2. Click **Additional Options**.
3. Click **NVIDIA Control Panel**.
4. Click **Video & Television**.
5. Click **Change the signal** or **HD format**.
6. Select the one of the below selection at "3. Select the signal format you would like to use".

| Country/Region | Signal Format* |
|----------------|----------------|
| Any            | 1080p HDTV     |
| Any            | 1080i HDTV     |
| Any            | 720p HDTV      |
| Any            | 576p EDTV      |
| Any            | 480p EDTV      |

\* Lists the actual Signal Formats supported by the HDMI monitor you are using.

7. Click **Apply** button.

### Connecting the HDMI out port

1. Plug one end of the HDMI cable into the HDMI out port of the HDMI device.

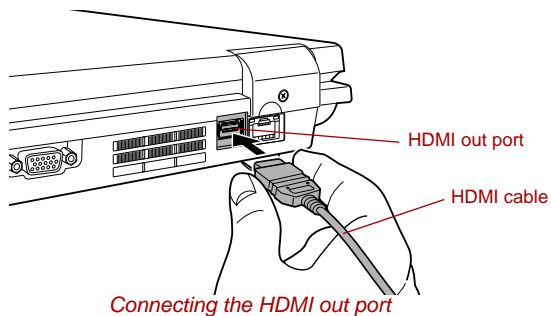

2. Plug the other end of the HDMI cable into the HDMI out port on your computer.

## Settings for display video on HDMI

To view video on the HDMI device, be sure to configure the following settings otherwise you may find that nothing is displayed.



- *Be sure to use the **FN + F5** HotKey to select the display device before starting to play video. Do not change the display device while playing video.*
- *Do not change the display device under the following conditions.*
  - *While data is being read or written.*
  - *While communication is being carried out.*

## VIDEO-IN

Refer to Chapter 8, [Connecting the VIDEO-IN port](#) for details on how to connect and use the computer with the VIDEO-IN cable.

## S-Video-in

This port allows you to import video data from analog video cameras or video decks by connecting your computer to this type of device. Imported video can be edited or written to a DVD disc.

1. Insert one end of the S-Video-in cable into the S-Video-in port of your computer.

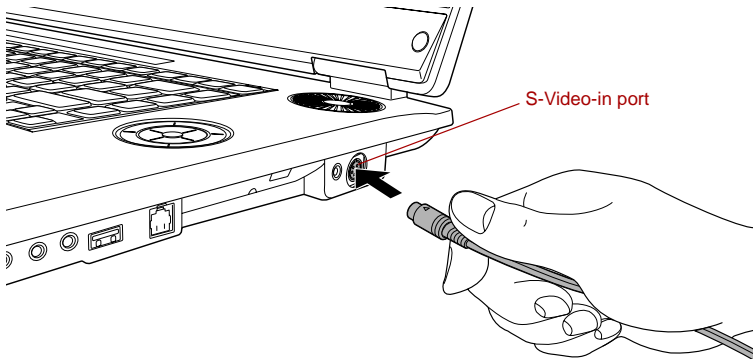

*Connecting the S-Video-in port*

2. Insert the other end of the S-Video-in cable into the output port of the analog device you wish to connect. To hear sounds, use a video cable to connect the sound terminals of the audio device and your computer (red: sound, right channel, white: sound, left channel).

After connecting an analog video camera or a video deck to your computer, run Ulead DVD MovieFactory for TOSHIBA. Ulead DVD MovieFactory for TOSHIBA is started by selecting **Start -> All Programs -> Ulead DVD MovieFactory for TOSHIBA**.

## i.LINK (IEEE1394)

i.LINK, also known as IEEE1394, is used for high-speed data transfer between a range of compatible devices such as:

- Digital video cameras
- Hard disk drives
- Magneto Optical drives
- Writable optical disc drives



*Please note that i.LINK uses a four-pin connector which does not carry any power - therefore, any external device will need its own power supply in order to operate.*

### Precautions

- Make a back-up of your data before transferring it to the computer in order to avoid the possibility that the original data will be damaged. With regard to this, there is a particular risk that some frames will be deleted in the case of digital video transfer - TOSHIBA assumes no liability for such loss of data.
- Do not transfer data in areas where static electricity is easily generated or in areas subjected to electronic noise - this can result in data being destroyed.
- If you are transferring data through an IEEE1394 hub, do not connect or disconnect other devices from the hub during the transfer operation - there is a likelihood that data will be damaged. In addition, you should connect all required devices to the hub before you turn on the computer's power.
- You may not use any copyrighted video or music data copied from a video camera except for your personal enjoyment.
- If you connect/disconnect an i.LINK device to/from another i.LINK device that is currently exchanging data with the computer, data frames may be dropped.
- Make sure data transfer has ended or turn off the computer, before you:
  - Connect/disconnect an i.LINK device to/from the computer.
  - Connect/disconnect an i.LINK device to/from another i.LINK device that is connected to the computer.

## Connecting

1. Make sure the connectors are properly aligned before you plug the i.LINK (IEEE1394) cable into the computer.

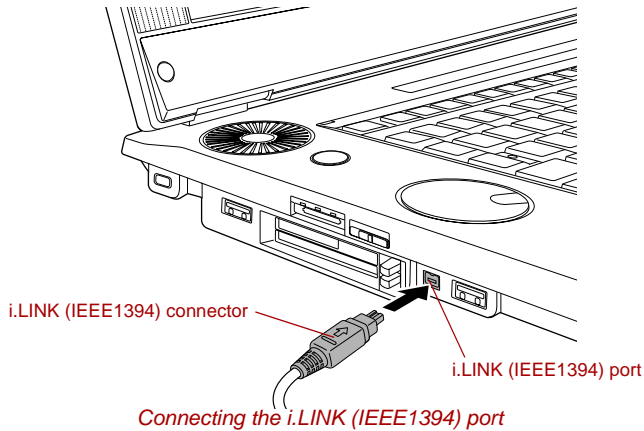

2. Plug the other end of the cable into the i.LINK device.

Please take note of the following when you use i.LINK devices:

- You may need to install drivers for your i.LINK devices to function.
- Not all i.LINK devices have been tested, therefore compatibility with all i.LINK devices cannot be guaranteed.
- Some devices might not function such as Sleep Mode or automatic power off.
- Do not connect or disconnect an i.LINK device while it is using an application or when the computer is automatically shutting it down to save power - doing so might cause data to be destroyed.

## Disconnecting

To remove an i.LINK device, follow the steps as detailed below:

1. Open the **Safely Remove Hardware** icon on the Windows Task Bar.
2. Point to **i.LINK (IEEE1394) device** and click the left Touch Pad control button.
3. Disconnect the cable from the computer and then from the i.LINK device.



*Please be aware that you should also refer to the documentation that was supplied with your i.LINK device.*



## Security lock

A security locks enable you to anchor your computer to a desk or other heavy object in order to help prevent unauthorized removal or theft. The computer has a security lock slot on its left side into which you can attach one end of the security cable, while the other end attaches to a desk or similar object. The methods used for attaching security cables differ from product to product. Please refer to the instructions for the product you are using for more information.

### Connecting the security lock

In order to connect a security cable to the computer, follow the steps as detailed below:

1. Turn the computer so its left hand side faces you.
2. Align the security cable with the “lock hole” and secure it in place.

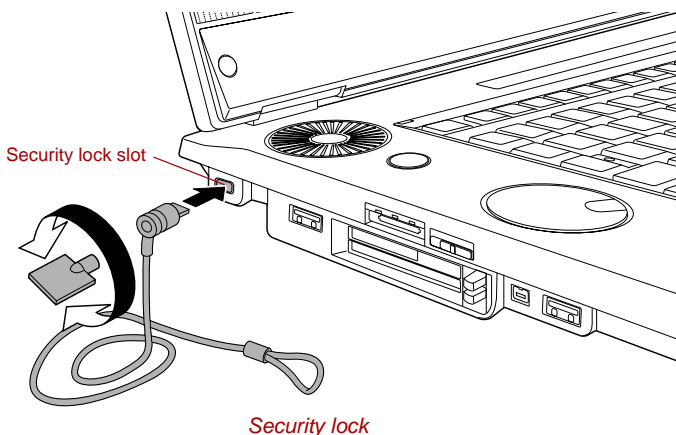



# Chapter 10

## Troubleshooting

TOSHIBA have designed this computer for durability, however, should problems occur you are able to use the procedures detailed in this chapter to help determine the cause.

All users should become familiar with this chapter as knowing what might go wrong can help prevent problems from occurring in the first place.

### Problem solving process

Resolving problems will be much easier if you observe the following guidelines:

- Stop immediately when you recognize a problem exists as taking further action may result in data loss or damage, or you may destroy valuable problem related information that can help solve the problem.
- Observe what is happening - write down what the system is doing and what actions you performed immediately before the problem occurred. If you have a printer attached, print a copy of the screen using the computer's **PRTS** key.

Please also be aware that the questions and procedures described in this chapter are meant only as a guide, they are not definitive problem solving techniques. In reality many problems can be solved simply, but a few may require help from your reseller, dealer or service provider - if you find you need to consult others, be prepared to describe the problem in as much detail as possible.

## Preliminary checklist

You should always consider the simplest solution first - the items detailed in this checklist are easy to fix and yet can cause what appears to be a serious problem:

- Make sure you turn on all peripheral devices before you turn on the computer - this includes your printer and any other external device you are using.
- Before you attach an external device you should first turn the computer off, then when you turn the computer back on again it will recognize the new device.
- Make sure all options are configured properly in the computer's setup program and that all required driver software has been loaded (please refer to the documentation provided with the option for further information on its installation and configuration).
- Check all cables to ensure they are correctly and firmly attached to the computer - loose cables can cause signal errors.
- Inspect all connecting cables for loose wires and all connectors for loose pins.
- Check that your floppy disk, CD, DVD or HD DVD media is correctly loaded and, in the case of a floppy disk, that its write protect tab is correctly set.

Always try to make detailed notes of your observations and keep them in a permanent error log - this will help you to describe your problems to your reseller, dealer or service provider. In addition, if a problem recurs, the log you have made will help to identify the problem faster.

## Analyzing the problem

Sometimes the computer will give you clues that can help you identify why it is malfunctioning. In view of this you should keep the following questions in mind:

- Which part of the computer is not operating properly - keyboard, floppy disk drive, hard disk drive, optical disc drive, display, touch pad, touch pad control buttons - as each device will produce different symptoms.
- Check the options within the operating system to ensure that its configuration is set properly.
- What appears on the display? Does it display any messages or random characters? If you have a printer attached, print a copy of the screen using the **PRTSC** key and, if possible, look up the messages in the documentation provided with the computer, software or operating system.
- Check that all connecting cables are correctly and firmly attached as loose cables can cause erroneous or intermittent signals.
- Do any indicators light, if so, which ones, what color are they and do they stay on or blink? Write down what you see.

- Do you hear any beeps, if so how many, are they long or short and are they high pitched or low pitched? In addition, is the computer making any unusual noises? Write down what you hear.

Record your observations so you can describe them in detail to your reseller, dealer or service provider.

**Software** The problems may be caused by your software or disk. If you cannot load a software package, the media may be damaged or the program might be corrupted - in these instances try loading another copy of the software if possible.

If an error message appears while you are using a software package you should refer to the documentation supplied with it as this will usually include a problem solving section or a summary of error messages.

Next, you should check any error messages against the operating system documentation.

**Hardware** If you cannot find a software problem, you should then check the setup and configuration of your hardware. First run through the items in the preliminary checklist as described previously then, if you still cannot correct the problem, try to identify the source - the next section provides checklists for individual components and peripherals.



*Before using a peripheral device or application software that is not an authorized Toshiba part or product, make sure the device or software can be used with your computer. Use of incompatible devices may cause injury or may damage your computer.*

## Hardware and system checklist

This section discusses problems caused by your computer's hardware or attached peripherals. Basic problems may occur in the following areas:

- System start-up
- Self test
- Power
- Password
- Keyboard
- Internal display panel
- Hard disk drive
- HD DVD-ROM drive
- HD DVD-R drive
- USB floppy disk drive
- PC Card
- ExpressCard
- SD/SDHC memory card, miniSD/microSD Card
- Memory Stick/Memory Stick PRO/Memory Stick PRO Duo
- xD picture card
- MultiMediaCard
- Infrared receiver window
- Pointing device
- Fingerprint Sensor
- USB device
- Memory expansion
- Sound system
- External monitor
- Modem
- LAN
- Wireless LAN
- Bluetooth
- TV output function
- i.LINK (IEEE1394) device
- Video Playback

## System start-up

When the computer does not start properly, check the following items:

- Self Test
- Power Sources
- Power-on Password

## Self test

When the computer starts up, the self test will be run automatically, and the following will be displayed:



# Qosmio

This message remains on the screen for a few seconds.

If the self test is successful, the computer tries to load the operating system according to how the **Boot Priority** option is set within the TOSHIBA HW Setup program.

If any of the following conditions are present, the self test has failed:

- The computer stops and does not proceed to display information or messages except for the TOSHIBA logo.
- Random characters appear on the screen and the system does not function normally.
- The screen displays an error message.

In these instances, turn off the computer, check all cable connections and then restart it - if the self test fails again, contact your reseller, dealer or service provider.

## Power

When the computer is not plugged into an AC power outlet, the battery pack is the primary power source. However, your computer also has a number of other power resources, including an intelligent power supply and a Real Time Clock (RTC) battery, all of which are interrelated with any one having the ability to produce apparent power problems.

This section provides checklists for AC power and the battery. If you cannot resolve a problem after following them, the cause may lie with another power related resource - in such an instance you should contact your reseller, dealer or service provider.

## Overheating power down

In the event that the computer's internal operating temperature becomes too high, the system will automatically enter either Hibernation Mode or Sleep Mode and shut itself down.

| Problem  | Procedure   |
|--|---|
| Computer shuts down and <b>DC IN</b> indicator blinks orange | Leave the computer off until the <b>DC IN</b> indicator stops blinking. |



*It is recommended to leave the computer off until the its interior reaches room temperature even though the **DC IN** indicator stops blinking.*

If the computer has reached room temperature and it still does not start, or if it starts but shuts down quickly, contact your reseller, dealer or service provider.

|  |   |
|--|---|
| Computer shuts down and its <b>DC IN</b> indicator is flashing in orange | This indicates a problem with the heat dispersal system - you should contact your reseller, dealer or service provider. |
|--|---|

## AC power

If you have trouble turning on the computer with the AC adaptor connected you should check the status of the **DC IN** indicator. Please refer to Chapter 6, [Power](#) for further information.

| Problem  | Procedure  |
|--|--|
| AC adaptor doesn't power the computer ( <b>DC IN</b> indicator does not glow blue) | <p>Check the connections to make sure that the power cord/adaptor is firmly connected to the computer and a working power outlet.</p> <hr/> <p>Check the condition of the cord and terminals. If the cord is frayed or damaged it should be replaced, while if the terminals are soiled, they should be cleaned with a clean cotton cloth.</p> <hr/> <p>If the AC adaptor still does not power the computer, you should contact your reseller, dealer or service provider.</p> |

## Battery

If you suspect a problem with the battery, you should check the status of the **DC IN** indicator as well as the **Battery** indicator. Please refer to Chapter 6, *Power* for more information on these indicators, together with general battery operation.

| Problem  | Procedure  |
|--|--|
| Battery doesn't power the computer   | The battery may be discharged - connect the AC adaptor to recharge the battery.  |
| Battery doesn't charge when the AC adaptor is attached ( <b>Battery</b> indicator does not glow orange). | <p>If the battery is completely discharged, it will not begin charging immediately, in these instances you should wait a few minutes before trying again. If the battery still does not charge, you should check that the power outlet the AC adaptor is connected to is supplying power - this can be tested by plugging another appliance into it.</p> <p>Check whether the battery is hot or cold to the touch - if so, it will not charge properly and should be allowed to reach room temperature before you try again.</p> <p>Unplug the AC adaptor and remove the battery to make sure its connecting terminals are clean - if necessary wipe them with a soft dry cloth lightly dipped in alcohol.</p> <p>Connect the AC adaptor and replace the battery, taking care to ensure that it is securely seated in the computer.</p> <p>Check the <b>Battery</b> indicator - if it does not glow, allow the computer to charge the battery for at least twenty minutes. If the <b>Battery</b> indicator starts to glow after this period, allow the battery to continue to charge for at least another twenty minutes before turning on the computer. However, if the indicator still does not glow, the battery may be at the end of its operating life and should be replaced. However, if you do not believe the battery is at the end of its operating life, you should speak to your reseller, dealer or service provider.</p> |
| Battery doesn't power the computer as long as expected   | <p>If you frequently recharge a partially charged battery, the battery might not charge to its full potential - in these instances you should fully discharge the battery and then attempt to charge it again.</p> <p>Check the <b>Power saver</b> option under <b>Select a power plan</b> in the <b>Power Options</b>.</p>  |



## Real Time Clock

| Problem   | Procedure  |
|---|--|
| The following message is Displayed on the LCD screen:<br><b>RTC battery is low or CMOS checksum is inconsistent. Press [F1] key to set Date/Time.</b> | The charge in the Real Time Clock (RTC) battery has run out - you will need to set the date and time in the BIOS setup application by using the following steps: <ol style="list-style-type: none"> <li>1. Press the <b>F1</b> key - the BIOS setup application will load.</li> <li>2. Set the date in the <b>System Date</b> field.</li> <li>3. Set the time in the <b>System Time</b> field.</li> <li>4. Press the <b>END</b> key - a confirmation message will be displayed.</li> <li>5. Press the <b>Y</b> key - the BIOS setup application will end and the computer will restart.</li> </ol> |

## Password

| Problem               | Procedure   |
|-----------------------|---|
| Cannot enter password | Please refer to the <a href="#">TOSHIBA Password Utility</a> section in Chapter 6, <a href="#">Power</a> , for further information. |

## Keyboard

Keyboard problems can be caused by the setup and configuration of the computer - please refer to Chapter 5, [The Keyboard](#), for further information.

| Problem                          | Procedure  |
|----------------------------------|--|
| Some letter keys produce numbers | Check that the numeric keypad overlay is not activated - press the <b>FN + F11</b> hot key and try typing again.   |
| Output to screen is garbled      | Please refer to your software's documentation to ensure that its is not remapping the keyboard in any way (remapping involves changing or reassigning the function of each key).<br><br>If you are still unable to use the keyboard, you should contact your reseller, dealer or service provider. |

## Internal display panel

Apparent display panel problems may be related to the computer's setup and configuration - please refer to Chapter 7, *HW Setup & BIOS Setup*, for further information.

| Problem  | Procedure   |
|--|---|
| No display   | Press the <b>FN + F5</b> hot keys to adjust the display priority, and to make sure it is not set for output to an external monitor.   |
| Markings appear on the LCD screen.                       | These marks may have come from contact with the keyboard, Touch Pad while the display has been closed. You should try to remove the marks by gently wiping the display panel with a clean dry cloth or, if this fails, with a good quality LCD screen cleaner. In this latter instance you should always follow the instructions with the screen cleaner and always ensure you let the LCD screen dry properly before closing it. |
| Problems above remain unresolved or other problems occur | You should initially refer to the documentation supplied with you software to determine if it is this that is causing the problems. Alternatively you may wish to run the TOSHIBA PC Diagnostic Tool to check the general operation of the computer.<br><br>If you are still unable to resolve the problem, contact your reseller, dealer or service provider.  |

## Hard disk drive

| Problem                                     | Procedure  |
|---|--|
| Computer does not boot from hard disk drive | <p>Check to see whether that is a floppy disk in the floppy disk drive or a CD-ROM/DVD-ROM in the optical disc drive - if so remove it and try to start the computer again.</p> <p>If this has no effect, check the <b>Boot Priority</b> setting within the TOSHIBA HW Setup utility - please refer to the <i>Boot Priority</i> section in Chapter 7, <i>HW Setup &amp; BIOS Setup</i>, for further information.</p> <p>Please refer to your operating system documentation in order to determine whether there is a problem with any of the operating system files or settings.</p> |

| Problem          | Procedure   |
|------------------|---|
| Slow performance | <p>The files on the hard disk drive may be fragmented - in this instance you should run the disk Defragmentation utility to check the condition of your files and the hard disk drive. Please refer to the operating system's documentation or online Help File for further information on operating and using the Defragmentation utility.</p> <hr/> <p>As a last resort you should reformat the hard disk drive and then reload the operating system and all other files and data. If you are still unable to resolve the problem, contact your reseller, dealer or service provider.</p> |

## HD DVD-ROM drive

For further information, please refer to Chapter 4, [Operating Basics](#).

| Problem  | Procedure  |
|--|--|
| You cannot access a CD/DVD/HD DVD in the drive | <p>Make sure the drive's disc tray is securely closed - press it gently into the computer until it clicks into place.</p> <hr/> <p>Open the drive's disc tray and ensure the CD, DVD, or HD DVD is properly seated - it should lie flat with the label facing upwards.</p> <hr/> <p>A foreign object in the drive's disc slot could block laser light from reading the CD, DVD, or HD DVD - remove any foreign objects or obstructions that may be present.</p> <hr/> <p>Check whether the CD, DVD, or HD DVD is dirty - if it is, wipe it with a clean cloth lightly dipped in water or a neutral cleaner. Please refer to the <a href="#">Media care</a> section in Chapter 4 for further details on cleaning the media.</p> |

| Problem   | Procedure   |
|---|---|
| <p>Some CD/DVD/HD DVDs run correctly, but others do not</p> | <p>The computer's software or hardware configuration may be causing a problem - ensure that these configurations match the requirements of the CD/DVD/HD DVD media (refer to the CD's, DVD's, or HD DVD's documentation if available).</p> <hr/> <p>Check the type of CD, DVD, or HD DVD media that you are using - the drive supports the following:</p> <p>HD DVD: HD DVD-ROM (Single-sided Single-Layer), HD DVD-ROM (Single-sided Dual-Layer), HD DVD-Video, HD DVD (Twin format disc)</p> <p>DVD: DVD-ROM, DVD-Video</p> <p>CD: CD-DA, CD-Text, Photo CD™ (single/multi-session), CD-ROM Mode 1, Mode 2, CD-ROM XA Mode 2 (Form1, Form2), Enhanced CD (CD-EXTRA), Addressing Method 2</p> <hr/> <p>For DVD Videos, you should check the region coding on the DVD to ensure that it matches that on the HD DVD-ROM drive. For reference, region codes are listed in the <a href="#">Optical disc drives</a> section in Chapter 2, <a href="#">The Grand Tour</a>.</p> |

### HD DVD-R drive

For further information, please refer to Chapter 4, [Operating Basics](#).



*The optical drive installed on this computer cannot write multiple sessions on HD DVD-R Dual Layer disc sessions. Once a disc has been written to once, it will be finalized. Once finalized, no further writing to the disc will be possible regardless of what portion of the total disc capacity was used.*

| Problem   | Procedure  |
|---|--|
| <p>You cannot access a CD/DVD/HD DVD in the drive</p> | <p>Make sure the drive's disc tray is securely closed - press it gently into the computer until it clicks into place.</p> <hr/> <p>Open the drive's disc tray and ensure the CD, DVD, or HD DVD is properly seated - it should lie flat with the label facing upwards.</p> |

| Problem  | Procedure  |
|--|--|
|  | <p>A foreign object in the drive's disc slot could block laser light from reading the CD, DVD, or HD DVD - remove any foreign objects or obstructions that may be present.</p> <hr/> <p>Check whether the CD, DVD, or HD DVD is dirty - if it is, wipe it with a clean cloth lightly dipped in water or a neutral cleaner. Please refer to the <a href="#">Media care</a> section in Chapter 4 for further details on cleaning the media.</p>  |
| Some CD/DVD/HD DVDs run correctly, but others do not | <p>The computer's software or hardware configuration may be causing a problem - ensure that these configurations match the requirements of the CD/DVD/HD DVD media (refer to the CD's, DVD's, or HD DVD's documentation if available).</p> <hr/> <p>Check the type of CD, DVD, or HD DVD media that you are using - the drive supports the following:</p> <p>HD DVD: HD DVD-ROM (Single-sided Single-Layer), HD DVD-ROM (Single-sided Dual-Layer), HD DVD-R (Single-sided Single-Layer), HD DVD-R (Single-sided Dual-Layer), HD DVD-Video, HD DVD (Twin format disc)</p> <p>DVD: DVD-ROM, DVD-Video, DVD-R/-R (Dual Layer), DVD+R/+R (Double Layer), DVD-RW, DVD+RW, DVD-RAM</p> <p>CD: CD-DA, CD-Text, Photo CD™ (single/multi-session), CD-ROM Mode 1, Mode 2, CD-ROM XA Mode 2 (Form1, Form2), Enhanced CD (CD-EXTRA), Addressing Method 2</p> <hr/> <p>For DVD Videos, you should check the region coding on the DVD to ensure that it matches that on the HD DVD-ROM drive. For reference, region codes are listed in the <a href="#">Optical disc drives</a> section in Chapter 2, <a href="#">The Grand Tour</a>.</p> |

## USB floppy disk drive

The USB floppy disk drive is available only as an option.

For further information, please refer to Chapter 4, [Operating Basics](#).

| Problem  | Procedure   |
|--|---|
| Drive does not operate                           | Check the connection between the computer and the drive to ensure that it is properly attached.   |
| Some programs run correctly but others do not    | The computer's software or hardware configuration may be causing a problem - ensure that these configurations match your requirements (refer to any relevant documentation, for example that supplied with any software in use, for further information).                   |
| You cannot access the external floppy disk drive | Try another floppy disk in the drive - if you are able to access this disk then it indicates the original disk and not the drive is probably causing the problem.<br><br>If you are still unable to resolve the problem, contact your reseller, dealer or service provider. |

## PC Card

For further information, please refer to Chapter 9, [Optional Devices](#).

| Problem              | Procedure  |
|----------------------|--|
| PC Card error occurs | Remove the PC Card from the computer and then reinsert it in order to ensure it is firmly connected.<br><br>In the event that the PC Card is attached to an external peripheral device, ensure that this connection is properly made.<br><br>If the problem persists, then you should refer to the documentation supplied with your PC Card for further information.<br><br>If you are still unable to resolve the problem, contact your reseller, dealer or service provider. |

## ExpressCard

For further information, please refer to Chapter 9, *Optional Devices*.

| Problem                  | Procedure   |
|--------------------------|---|
| ExpressCard error occurs | <p>Remove the ExpressCard from the computer and then reinsert it in order to ensure it is firmly connected.</p> <hr/> <p>In the event that the ExpressCard is attached to an external peripheral device, ensure that this connection is properly made.</p> <hr/> <p>If the problem persists, then you should refer to the documentation supplied with your ExpressCard for further information.</p> <p>If you are still unable to resolve the problem, contact your reseller, dealer or service provider.</p> |

## SD/SDHC memory card, miniSD/microSD Card

For further information, please refer to Chapter 9, *Optional Devices*.

| Problem   | Procedure  |
|---|--|
| SD/SDHC memory card, miniSD/microSD Card error occurs | <p>Remove the SD/SDHC memory card, miniSD/microSD Card from the computer and then reinsert it in order to ensure it is firmly connected.</p> <p>If the problem persists, then you should refer to the documentation supplied with your SD/SDHC memory card, miniSD/microSD Card for further information.</p> |
| You cannot write to an SD/SDHC memory card            | <p>Remove the SD/SDHC memory card from the computer and check to ensure that it is not write protected.</p>  |
| You cannot read a file                                | <p>Check to ensure the required file is actually on the SD/SDHC memory card, miniSD/microSD Card that is inserted into the computer.</p> <p>If you are still unable to resolve the problem, contact your reseller, dealer or service provider.</p>   |

## Memory Stick/Memory Stick PRO/Memory Stick PRO Duo

For further information, please refer to Chapter 9, [Optional Devices](#).

| Problem   | Procedure  |
|---|--|
| Memory Stick/Memory Stick PRO/Memory Stick PRO Duo error occurs           | <p>Remove the Memory Stick/Memory Stick PRO/Memory Stick PRO Duo from the computer and then reinsert it in order to ensure it is firmly connected.</p> <p>If the problem persists, then you should refer to the documentation supplied with your Memory Stick/Memory Stick PRO/Memory Stick PRO Duo for further information.</p> |
| You cannot write to an Memory Stick/Memory Stick PRO/Memory Stick PRO Duo | <p>Remove the Memory Stick/Memory Stick PRO/Memory Stick PRO Duo from the computer and check to ensure that it is not write protected.</p>   |
| You cannot read a file  | <p>Check to ensure the required file is actually on the Memory Stick/Memory Stick PRO/Memory Stick PRO Duo that is inserted into the computer.</p> <p>If you are still unable to resolve the problem, contact your reseller, dealer or service provider.</p>   |

## xD picture card

For further information, please refer to Chapter 9, [Optional Devices](#).

| Problem                      | Procedure  |
|------------------------------|--|
| xD picture card error occurs | <p>Remove the xD picture card from the computer and then reinsert it in order to ensure it is firmly connected.</p> <p>If the problem persists, then you should refer to the documentation supplied with your xD picture card for further information.</p> |
| You cannot read a file       | <p>Check to ensure the required file is actually on the xD picture card that is inserted into the computer.</p> <p>If you are still unable to resolve the problem, contact your reseller, dealer or service provider.</p>                                  |



## MultiMediaCard

For further information, please refer to Chapter 9, *Optional Devices*.

| Problem                              | Procedure   |
|--------------------------------------|---|
| MultiMediaCard error occurs          | Remove the MultiMediaCard from the computer and then reinsert it in order to ensure it is firmly connected.<br><br>If the problem persists, then you should refer to the documentation supplied with your MultiMediaCard for further information. |
| You cannot write to a MultiMediaCard | Remove the MultiMediaCard from the computer and check to ensure that it is not write protected.   |
| You cannot read a file               | Check to ensure the required file is actually on the MultiMediaCard that is inserted into the computer.<br><br>If you are still unable to resolve the problem, contact your reseller, dealer or service provider.                                 |

## Infrared receiver window

If you are using a USB mouse, you should also refer to both the USB device section in this chapter, and the documentation supplied with your mouse.

| Problem                                  | Procedure  |
|--|--|
| Infrared devices do not work as expected | Make sure there is no obstruction blocking communication between the computer and the target device.<br><br>If you are still unable to resolve the problem, contact your reseller, dealer or service provider. |

## Pointing device

If you are using a USB mouse, you should also refer to both the [USB device](#) section in this chapter, and the documentation supplied with your mouse.

### Touch Pad

| Problem   | Procedure  |
|---|--|
| On-screen pointer does not respond to pointing device operation | In this instance the system might be busy - Try moving the mouse again after waiting a short while.  |
| Double-tapping does not work                                    | <p>In this instance, you should initially try changing the double-click speed setting within the Mouse Control utility.</p> <ol style="list-style-type: none"> <li>1. To access this utility, click <b>Start -&gt; Control Panel -&gt; Hardware and Sound -&gt; Mouse</b> icon.</li> <li>2. Within the Mouse Properties window, click the <b>Buttons</b> tab.</li> <li>3. Set the double-click speed as required and click <b>OK</b>.</li> </ol>   |
| The mouse pointer moves too fast or too slow                    | <p>In this instance, you should initially try changing the speed setting within the Mouse Control utility.</p> <ol style="list-style-type: none"> <li>1. To access this utility, click <b>Start -&gt; Control Panel -&gt; Hardware and Sound -&gt; Mouse</b> icon.</li> <li>2. Within the Mouse Properties window, click the <b>Pointer Options</b> tab.</li> <li>3. Set the pointer speed as required and click <b>OK</b>.</li> </ol> <p>If you are still unable to resolve the problem, contact your reseller, dealer or service provider.</p> |

| Problem  | Procedure   |
|--|---|
| The reaction of Touch pad is either too sensitive or not sensitive enough. | <p>Adjust the touch Sensitivity.</p> <ol style="list-style-type: none"> <li>1. Click <b>Start</b> -&gt; <b>Control Panel</b> -&gt; <b>Hardware and Sound</b> -&gt; <b>Mouse</b> icon.</li> <li>2. Within the Mouse Properties window, click the <b>Device Settings</b> tab.</li> <li>3. Click the <b>Settings</b> button.</li> <li>4. Properties for Synaptics TouchPad V6.3 on PS/2 Port window is displayed.</li> <li>5. Select <b>Sensitivity</b> from the <b>Select an item</b> list.</li> <li>6. Select <b>Touch Sensitivity</b> and move the slider bar to adjust the sensitivity.</li> <li>7. Click the <b>OK</b> button.</li> </ol> |

### USB mouse

| Problem   | Procedure   |
|---|---|
| On-screen pointer does not respond to mouse operation | <p>In this instance the system might be busy - Try moving the mouse again after waiting a short while.</p> <p>Remove the mouse from the computer and then reconnect it to a free USB port it in order to ensure it is firmly attached.</p>  |
| Double-clicking does not work                         | <p>In this instance, you should initially try changing the double-click speed setting within the Mouse Control utility.</p> <ol style="list-style-type: none"> <li>1. To access this utility, click <b>Start</b> -&gt; <b>Control Panel</b> -&gt; <b>Hardware and Sound</b> -&gt; <b>Mouse</b> icon.</li> <li>2. Within the Mouse Properties window, click the <b>Buttons</b> tab.</li> <li>3. Set the double-click speed as required and click <b>OK</b>.</li> </ol> |
| The mouse pointer moves too fast or too slow          | <p>In this instance, you should initially try changing the speed setting within the Mouse Control utility.</p> <ol style="list-style-type: none"> <li>1. To access this utility, click <b>Start</b> -&gt; <b>Control Panel</b> -&gt; <b>Hardware and Sound</b> -&gt; <b>Mouse</b> icon.</li> <li>2. Within the Mouse Properties window, click the <b>Pointer Options</b> tab.</li> <li>3. Set the pointer speed as required and click <b>OK</b>.</li> </ol>           |

| Problem                             | Procedure   |
|-------------------------------------|---|
| The mouse pointer moves erratically | <p>The elements of the mouse responsible for detecting movement might be dirty - please refer to the documentation supplied with the mouse for instructions on how to clean it.</p> <p>If you are still unable to resolve the problem, contact your reseller, dealer or service provider.</p> |

## Fingerprint Sensor

| Problem   | Procedure   |
|---|---|
| Reading of the fingerprint was not successful.                | <p>In this instance you should try the fingerprint reading operation again using the correct finger position - please refer to <a href="#">Using the Fingerprint Sensor</a> in Chapter 4, <a href="#">Operating Basics</a> for further information.</p> <p>Alternatively, you should try the recognition process again using another enrolled finger.</p> <p>The fingerprint sensor compares and analyzes the unique characteristics in a fingerprint.</p> <p>However, there may be instances where certain users are unable to register their fingerprints due to insufficient unique characteristics in their fingerprints.</p> <p>The recognition success rate may differ from user to user.</p> |
| The fingerprint cannot be read due to injuries to the finger. | <p>In this instance you should try the recognition process again using another enrolled finger. However, if fingerprints from all the enrolled fingers cannot be read, you should instead log into the computer by using the keyboard to input the password.</p> <p>If you are still unable to resolve the problem, contact your reseller, dealer or service provider.</p>  |

## USB device

In addition to the information in this section, please also refer to the documentation supplied with your USB device.

| Problem                  | Procedure  |
|--------------------------|--|
| USB device does not work | <p>Remove the USB device from the computer and then reconnect it to a free port it in order to ensure it is firmly attached.</p> <hr/> <p>Ensure that any required USB device drivers are properly installed - to achieve this you should refer to both the device documentation and the operating system documentation.</p> <hr/> <p>If you are using an operating system that does not support USB, you are still able to use a USB mouse and/or USB keyboard by setting the <b>USB KB/Mouse Emulation</b> option within the TOSHIBA HW Setup utility to <b>Enabled</b>.</p> <p>If you are still unable to resolve the problem, contact your reseller, dealer or service provider.</p> |

## Memory expansion

Please also refer to Chapter 9, *Optional Devices*, for further information on installing and removing memory modules.

| Problem  | Procedure  |
|--|--|
| <p>If there is a memory malfunction, the power LED will repeatedly flash (on for 0.5 seconds, off for 0.5 seconds) in the following patterns;</p> <p>If there is an error in only slot A or no memory module is inserted in Slot A: orange twice, then green once.</p> <p>If there is an error in Slot B: orange once, then green twice.</p> <p>If there are errors in both Slot A and Slot B: orange twice, then green twice.</p> | <p>In the event of power LED flashes when the computer is turned on you should initially ensure that the installed memory module(s) are compatible with the computer. If you determine that an incompatible module has been installed, you should follow the steps as detailed below:</p> <ol style="list-style-type: none"> <li>1. Turn off the computer.</li> <li>2. Disconnect the AC adaptor and all peripheral devices.</li> <li>3. Remove the battery pack.</li> <li>4. Remove the incompatible memory module.</li> <li>5. Install the battery and/or connect the AC adaptor.</li> <li>6. Turn on the computer.</li> </ol> <p>If you are still unable to resolve the problem, contact your reseller, dealer or service provider.</p> |

| <b>Problem</b>   | <b>Procedure</b>  |
|--|---|
| An error will occur if a memory module is inserted into Slot B while no memory module is inserted in Slot A. | Remove the memory module from Slot B and insert it into Slot A. |

---

## Sound system

In addition to the information in this section, please also refer to the documentation supplied with your audio device.

| <b>Problem</b>    | <b>Procedure</b>  |
|-------------------|---|
| No sound is heard | Adjust the volume control dial.<br>Check the software volume settings.<br>Please check to see if Mute is turned to Off.<br>Check to make sure the headphone connection is secure.<br>Check within the Windows Device Manager application to ensure the sound function is enabled.<br>If you are still unable to resolve the problem, contact your reseller, dealer or service provider. |

---

## External monitor

Please also refer to Chapter 9, *Optional Devices*, and to the documentation supplied with your monitor for further information.

| Problem                  | Procedure  |
|--------------------------|--|
| Monitor does not turn on | After confirming that the monitor's power switch is on, you should check the connections to make sure that the power cord/adaptor is firmly connected to the monitor and to a working power outlet.  |
| No display               | <p>Try adjusting the contrast and brightness controls on the external monitor.</p> <p>Press the <b>FN + F5</b> hot key in order to change the display priority and ensure that it is not set for the internal display panel only.</p> <p>Check to see if the external monitor is connected. When the external monitor is set as the primary display device in extended desktop mode, it will not display when the computer wakes up from Sleep Mode if the external monitor has been disconnected while in Sleep Mode. To keep this from happening, do not disconnect the external monitor while the computer is in Sleep or Hibernation Mode. Remember to turn off the computer before disconnecting the external monitor.</p> <p>When the display panel and an external monitor are set to clone mode and the monitors are turned off by the timer, the display panel or the external monitor may not display when turned on again. If this occurs, press <b>FN + F5</b> to re-set the display panel and external monitor to clone mode.</p> |
| Display error occurs     | <p>Check that the cable connecting the external monitor to the computer is firmly attached. If you are still unable to resolve the problem, contact your reseller, dealer or service provider.</p>   |

## Modem

For additional information, please also refer to Appendix C, [Wireless LAN](#) and Appendix D, [Bluetooth wireless technology Interoperability](#).

| Problem   | Procedure   |
|---|---|
| Communication software can't initialize modem                     | Make sure the computer's internal modem settings are correct - please refer to the Phone and Modem Options link within the Windows Control Panel.   |
| You can hear a dial tone but can't make a call                    | If the call is going through a Private Branch Exchange (PBX), take care to ensure that the communication application's tone dial detection feature is disabled.<br>You are also able to use the ATX command.                                    |
| You place a call, but a connection can't be made                  | Make sure that the settings are correct within your communication application.  |
| After making a call you can't hear a ring                         | Ensure that the communication application's tone or pulse dialling selection feature is set correctly.<br>You are also able to use the ATD command.   |
| Communication is cut off unexpectedly                             | The computer will automatically cut off communication when connection with the carrier is not successful for a set time interval - try lengthening this time interval within your communication application.                                    |
| A <b>CONNECT</b> display is quickly replaced by <b>NO CARRIER</b> | Ensure that the communication application's error control feature is set correctly.<br>You are also able to use the ATN command.  |
| Character display becomes garbled during a communication          | When transmitting data you should ensure that the parity bit and stop bit settings correspond with those of the remote computer - you should check the flow control and communication protocol settings within your communication application.  |
| You cannot receive an incoming call                               | Ensure that the communication application's rings before auto answer feature is set correctly.<br>You are also able to use the ATS0 command. If you are still unable to resolve the problem, contact your reseller, dealer or service provider. |



## LAN

| Problem                      | Procedure  |
|------------------------------|--|
| Cannot access LAN            | Check for a firm cable connection between the LAN jack and the LAN HUB.  |
| Wake-up on LAN does not work | Make sure the AC adaptor is connected. The Wake-up on LAN function consumes power even when the system is off.<br>If problems persist, consult your LAN administrator. |

## Wireless LAN

If the following procedures do not restore LAN access, consult your LAN administrator. For more information on wireless communication, refer to Chapter 4, [Operating Basics](#).

| Problem                               | Procedure   |
|---------------------------------------|---|
| Cannot access Wireless LAN            | Make sure the computer's wireless communication switch is set to on.  |
| Wake-up on Wireless LAN does not work | Make sure the AC adaptor is connected. The Wake-up on Wireless LAN function consumes power even when the system is off.<br>If problems persist, consult your LAN administrator. |

## Bluetooth

For further information on Bluetooth wireless communication, please refer to Chapter 4, [Operating Basics](#).

| Problem                        | Procedure  |
|--------------------------------|--|
| Cannot access Bluetooth device | Check to ensure the computer's wireless communication switch is set to on.   |
|                                | Check to ensure the Bluetooth Manager application is running on the computer and that power to the external Bluetooth device is turned on.   |
|                                | Check to ensure that no optional Bluetooth Adaptor is installed in the computer - the built-in Bluetooth hardware cannot operate simultaneously with another Bluetooth controller.<br>If you are still unable to resolve the problem, contact your reseller, dealer or service provider. |

## TV output function

| Problem               | Procedure   |
|-----------------------|---|
| Display on TV is poor | Check to ensure the television type is set correctly your region - NTSC should be used for the United States and Japan, while PAL should be used for Europe.  |
| No display            | <p>Try adjusting the contrast and brightness controls on the television.</p> <p>Press the <b>FN + F5</b> hot key in order to change the display priority and ensure that it is not set for the internal display panel only.</p> <p>If you are still unable to resolve the problem, contact your reseller, dealer or service provider.</p> |



*If you turn the computer off into Sleep Mode while the display is on TV, the computer will select either the internal LCD or an external computer CRT as the display device the next time is switched on.*

### i.LINK (IEEE1394) device

| Problem                         | Procedure   |
|---------------------------------|---|
| i.LINK device does not function | <p>Check that the cable connecting the external device to the computer is firmly attached.</p> <p>Check to ensure that power is being supplied to the device and that the device is turned on.</p> <p>Reinstall the drivers required for the device - this can be achieved by clicking <b>Start, Control Panel, Hardware and Sound</b> and then clicking the <b>Add Hardware</b> icon at the left-hand side of the screen and following the on-screen instructions.</p> <p>Restart the computer and the Windows operating system to re-initialize the device.</p> <p>If you are still unable to resolve the problem, contact your reseller, dealer or service provider.</p> |

## Video Playback

| Problem  | Procedure  |
|--|--|
| DVD does not play smoothly when using the Windows Media Center of the DVD playing software | <p>Try setting the configuration in the BIOS setup. However, note that when the BIOS setup configuration is modified, the power saving function of PCI Express becomes disabled. Refer to Chapter 7, <i>HW Setup &amp; BIOS Setup</i>, for more information.</p> <p>Set the PCI Express Link ASPM in the BIOS setup using the following steps:</p> <ol style="list-style-type: none"> <li>1. Press the <b>F1</b> key. The BIOS setup screen will appear.</li> <li>2. Set the PCI Express Link ASPM to <b>Disabled</b> in BATTERY.</li> <li>3. Press the <b>END</b> key. A confirmation message will appear.</li> <li>4. Press the <b>Y</b> key. The BIOS setup will terminate and the computer will reboot.</li> </ol> <p>If you are still unable to resolve the problem, contact your reseller, dealer or service provider.</p> |

## Disposing of computer and computer batteries

- Discard this computer in accordance with applicable laws and regulations. For further information, contact your local government.
- This computer contains rechargeable batteries. After repeated use, the batteries will finally lose their ability to hold a charge and you will need to replace them. Under certain applicable laws and regulation, it may be illegal to dispose of old batteries by placing them in the trash.
- Please be kind to our shared environment. Check with your local government authority for details regarding where to recycle old batteries or how to dispose of them properly. This product contains mercury. Disposal of this material may be regulated due to environmental considerations. For disposal, reuse or recycling information, please contact your local government.
- If your hard disk drive or other storage media contains sensitive data, you should be aware that standard deletion procedures do not remove data from the media. These standard deletion procedures include:
  - Selecting Delete for a target file
  - Putting files in the Recycle Bin and emptying the Recycle Bin
  - Reformatting the media
  - Reinstalling an operating system from the recovery CD-ROM

The procedures above delete only the initial part of the data used for file management. This makes the file invisible to the operating system, but the data can still be read by specialized utilities. If you dispose of the computer, please delete all the data on its hard disk drive. Doing so prevents unauthorized use of such data. To ensure your data is not used for unauthorized purposes, you can:

- Physically destroy the hard disk drive
- Use a proven specialized utility to overwrite all data
- Take the hard disk drive to a professional deletion service

All data deletion costs will be borne by you.

## TOSHIBA support

If you require any additional help using your computer or if you are having problems operating the computer, you may need to contact TOSHIBA for additional technical assistance.

### Before you call

Some problems you experience may be related to software or the operating system so it is important that you investigate other sources of assistance first. Before contacting TOSHIBA, try the following:

- Review troubleshooting sections in the documentation supplied with your software and/or peripheral devices.
- If a problem occurs when you are running software applications, consult the software documentation for troubleshooting suggestions and consider calling the software company's technical support department for assistance.
- Consult the reseller or dealer from where you purchased your computer and/or software - they are your best resource for current information and support.

### Where to write

If you are still unable to solve the problem and suspect that it is hardware related, write to TOSHIBA at the location listed in the accompanying warranty booklet or visit [www.toshiba-europe.com](http://www.toshiba-europe.com) on the internet.

# Chapter 11

## Legal Footnotes

This chapter states the Legal Footnotes information applicable to TOSHIBA computers. In the text in this manual, \*XX is used to show which Legal Footnotes description is related to TOSHIBA computers.

Description(s) related to this computer are marked with a blue \*XX in this manual. Clicking on \*XX will display the related description.

### CPU\*1

Central Processing Unit (“CPU”) Performance Legal Footnotes.

CPU performance in your computer product may vary from specifications under the following conditions:

- use of certain external peripheral products
- use if battery power instead of AC power
- use of certain multimedia, computer generated graphics or video applications
- use of standard telephone lines or low speed network connections
- use of complex modeling software, such as high end computer aided design applications
- use of several applications or functionalities simultaneously
- use of computer in areas with low air pressure (high altitude > 1,000 meters or > 3,280 feet above sea level)
- use of computer at temperatures outside the range of 5°C to 30°C (41°F to 86°F) or >25°C (77°F) at high altitude (all temperature references are approximate and may vary depending on the specific computer model - please refer to your computer documentation or visit the Toshiba website at [www.pcsupport.toshiba.com](http://www.pcsupport.toshiba.com) for details).

CPU performance may also vary from specifications due to design configuration.

Under some conditions, your computer product may automatically shut-down. This is a normal protective feature designed to reduce the risk of lost data or damage to the product when used outside recommended conditions. To avoid risk of lost data, always make back-up copies of data by periodically storing it on an external storage medium. For optimum performance, use your computer product only under recommended conditions. Read additional restrictions under “Environmental Conditions” in your computer documentation.

Contact Toshiba Technical Service and Support for more information.

## 64-Bit Computing

The following section applies only to Intel® Core™ 2 Duo Processor equipped models.

64-bit processors are designed to take advantage of 32 and 64 bit computing.

64-bit computing requires that the following hardware and software requirements are met:

- 64-bit Operating System
- 64-bit CPU, Chipset and BIOS (Basic Input/Output System)
- 64-bit Device drivers
- 64-bit applications

Certain device drivers and/or applications may not be compatible with a 64-bit CPU and therefore may not function properly. A 32-bit version of the operating system is preinstalled on your computer unless explicitly stated that the operating system is 64-bit.

Core™ 2 Duo or Core™ Duo Processor.

Intel® Dual Core Technology is a new technology designed to deliver improved performance to the notebook PC. Performance or compatibility may vary. For more information on Intel's Core 2 Duo processors, visit: <http://www.intel.com/core2duo/>

See 64-Bit Computing Legal Footnote, if applicable.

## Memory (Main System)\*2

Part of the main system memory may be used by the graphics system for graphics performance and therefore reduce the amount of main system memory available for other computing activities. The amount of main system memory allocated to support graphics may vary depending on the graphics system, applications utilized, system memory size and other factors. For computer's configured with 4 GB of system memory, the full system memory space for computing activities will be considerably less and will vary by model and system configuration.

## Battery Life\*3

Battery life may vary considerably depending on product model, configuration, applications, power management settings and features utilized, as well as the natural performance variations produced by the design of individual components. Published battery life numbers are achieved on select models and configurations tested by Toshiba at the time of publication. Recharge time varies depending on usage. Battery may not charge while computer is consuming full power.

After a period of time, the battery will lose its ability to perform at maximum capacity and will need to be replaced. This is normal for all batteries. To purchase a new battery pack, see the accessories information that shipped with your computer.

## Hard Disk Drive (HDD) Capacity\*4

1 Gigabyte (GB) means  $10^9 = 1,000,000,000$  bytes using powers of 10. The computer operating system, however, reports storage capacity using powers of 2 for the definition of  $1 \text{ GB} = 2^{30} = 1,073,741,824$  bytes, and therefore shows less storage capacity. Available storage capacity will also be less if the product includes one or more pre-installed operating systems, such as Microsoft Operating System and/or pre-installed software applications, or media content. Actual formatted capacity may vary.

## General HD DVD technology and playback\*5

Because HD DVD is a new format that makes use of new technologies, certain disc, digital connection and other compatibility and/or performance issues are possible. Advanced interactive and navigation features of the HD DVD Video format including, but not limited to, Picture in Picture (PIP) and network streaming features are not supported by this product. See Toshiba HD DVD model "Detailed Specs" at [www.computers.toshiba.com](http://www.computers.toshiba.com) for important information on HD DVD playback capabilities. HD DVD Application Logo (HD DVD-ROM) represents the optical drive's conformity with the DVD Forum's verification criteria for HD DVD physical format, and does not represent compliance with the HD DVD Video specification defined by the DVD Forum.

Advanced Access Content System (AACs) keys are integrated into your PC for copy protection purposes. Occasional renewal of the AACs key is required, and easily done by connecting to the Internet.

AACs key renewal will be provided at no charge to purchasers. If the AACs key is not renewed, the TOSHIBA HD DVD PLAYER software will stop playing AACs-protected HD DVD content. However, it will continue to play other forms of content, such as DVD discs or non-protected HD DVD content.

For more information on AACs, visit [www.aacsla.com/home](http://www.aacsla.com/home).

Depending on HD DVD content, you may experience “frame dropping” or lower performance.

HD DVD viewing on external display requires an HDCP capable HDMI™ or DVI input.

External power required for viewing of HD DVD content.

Since CPU power is dedicated to support HD DVD playback function, you must close all other applications before launching HD DVD playback.

Audio content with a high sampling (>48 kHz) rate will be down sampled when using Dolby Virtualizer with the internal speakers or the analog audio output or digital audio output (HDMI and S/PDIF).

Some content and/or discs may not be compatible.

## LCD\*6

Over a period of time, and depending on the usage of the computer, the brightness of the LCD screen will deteriorate. This is an intrinsic characteristic of LCD technology.

Maximum brightness is only available when operating in AC power mode. Screen will dim when the computer is operated on battery power and you will not be able to increase the brightness of the screen.

## Graphics Processor Unit (“GPU”)\*7

Graphics processor unit (“GPU”) performance may vary depending on product model, design configuration, applications, power management settings and features utilized. GPU performance is only optimized when operating in AC power mode and may decrease considerably when operating in battery power mode.

## Wireless LAN\*8

The transmission speed over the wireless LAN and the distance over which wireless LAN can reach may vary depending on surrounding electromagnetic environment, obstacles, access point design and configuration, and client design and software/hardware configurations.

The Intel® Next-Gen Wireless-N adaptor is based on a draft release version of the IEEE 802.11n specification, also known as “Draft-N”, which may not be compatible with, or support all features (e.g., security) of, certain Wi-Fi equipment.



---

## Non-applicable Icons\*9

Certain notebook chassis are designed to accommodate all possible configurations for an entire product series. Your selected model may not have all the features and specifications corresponding to all of the icons or switches shown on the notebook chassis, unless you have selected all those features.

## Copy Protection\*10

Applicable copy protection standards included in certain media may prevent or limit recording or viewing of the media.

## TV Tuner\*11

TV Tuner will function only in the country where the computer was purchased.

## Images\*12

All images are simulated for purposes of illustration.

## LCD Brightness and Eye Stain\*13

Your display panel has a brightness approaching that of a TV device. We recommend that you adjust the brightness of your LCD to a comfortable level to prevent possible strain on your eyes.

## Safety Use for TV Tuner\*14

If you have to operate your computer during a thunderstorm and are connecting the TV tuner to an outside antenna, you should operate your computer using AC power mode. The AC adaptor offers some protection against (but does not entirely prevent) possible electric shock caused by lightning. For complete protection, do not operate your computer during a thunderstorm.



# Appendix A

## Specifications

This appendix summarizes the computer's technical specifications.

### Physical Dimensions

|                         |   |
|-------------------------|---|
| <b>Weight (maximum)</b> | 4.8 kilograms, configured with: 17" WUXGA, 2GB x 2, 250GB HDD x 2, HD DVD-ROM drive, modem, LAN (1G bps), Wireless LAN, Bluetooth, TV tuner.<br>Weight will vary with other configurations. Above weights are measured at specific criteria. They are not guaranteed as the maximum weight of the actual product. |
| <b>Size</b>             | 440 (w) x 299.4 (d) x 38.1/45.3 (h) millimeters (not including parts that extend beyond the main body)  |

### Environmental Requirements

| Conditions                              | Ambient temperature          | Relative humidity |
|---|------------------------------|-------------------|
| <b>Operating</b>                        | 5°C (41°F) to 35°C (95°F)    | 20% to 80%        |
| <b>Non-operating</b>                    | -20°C (-4°F) to 65°C (149°F) | 10% to 90%        |
| <b>Thermal Gradient (operating)</b>     | 15°C per hour maximum        |                   |
| <b>Thermal Gradient (non-operating)</b> | 20°C per hour maximum        |                   |
| <b>Wet-bulb temperature</b>             | 26°C maximum                 |                   |
| Conditions                              | Altitude (from sea level)    |                   |
| <b>Operating</b>                        | -60 to 3,000 meters          |                   |
| <b>Non-operating</b>                    | -60 to 10,000 meters maximum |                   |

## Power Requirements

|                   |  |
|-------------------|--|
| <b>AC adaptor</b> | 100-240 volts AC<br>50 or 60 hertz (cycles per second) |
| <b>Computer</b>   | 15 VDC<br>8.0 amperes                                  |

## Built-in Modem

|                                     |   |   |
|-------------------------------------|---|---|
| <b>Network control unit (NCU)</b>   |   |   |
| <b>Type of NCU</b>                  | AA  |   |
| <b>Type of line</b>                 | Telephone line (analog only)  |   |
| <b>Type of dialing</b>              | Pulse<br>Tone   |   |
| <b>Control command</b>              | AT commands<br>EIA-578 commands   |   |
| <b>Monitor function</b>             | Computer's speaker  |   |
| <b>Communication specifications</b> |   |   |
| <b>Communication system</b>         | Data:   | Full duplex                               |
|                                     | Fax:  | Half duplex                               |
| <b>Communication protocol</b>       | Data  |   |
|                                     | ITU-T-Rec<br>(Former CCITT)   | V.21/V.22/V.22bis/V.32/V.32 bis/V.34/V.90 |
|                                     | Bell  | 103/212A                                  |
|                                     | Fax   |   |
|                                     | ITU-T-Rec<br>(Former CCITT)   | V.17/V.29/V.27ter/V.21 ch2                |
| <b>Communication speed</b>          | Data transmission and reception<br>300/1200/2400/4800/7200/9600/12000/14400/<br>16800/19200/21600/24000/26400/28800/31200/<br>33600 bps<br>Data reception only with V.90<br>28000/29333/30666/32000/33333/34666/36000/<br>37333/38666/40000/41333/42666/44000/45333/<br>46666/48000/49333/50666/52000/53333/54666/<br>56000 bps<br>Fax<br>2400/4800/7200/9600/12000/14400 bps |   |

---

|                               |                               |
|-------------------------------|-------------------------------|
| <b>Transmitting level</b>     | -10 dBm                       |
| <b>Receiving level</b>        | -10 to -40 dBm                |
| <b>Input/output impedance</b> | 600 ohms $\pm$ 30%            |
| <b>Error correcting</b>       | MNP class 4 and ITU-T V.42    |
| <b>Data compression</b>       | MNP class 5 and ITU-T V.42bis |
| <b>Power supply</b>           | +3.3V (supplied by computer)  |

---



# Appendix B

## Display Controller and Video modes

### Display controller

The display controller interprets software commands into hardware commands that turn particular parts on the screen on or off.



*Due to the display panel's increased resolution, lines may appear broken in when displaying images in full-screen text mode.*

The display controller also controls the video mode and uses industry standard rules to govern the screen resolution and the maximum number of colors that can be displayed at any one time. Therefore, software written for a given video mode will run on any computer that supports that mode.

### Video modes

Video mode settings are configured via the **Display Properties** dialog.

To open the **Display Properties** dialog, click **Start -> Control Panel -> Appearance and Personalization -> Personalization -> Display Settings**.



*If you are running some applications (for example a 3D application or video playback and so on), you may see some disturbance, flickering or frame dropping on your screen.*

*If that occurs, adjust the resolution of display, lowering it until the screen is displayed properly.*

*You could also disable Windows Aero™ to help correct this situation.*





# Appendix C

## Wireless LAN

This appendix is intended to help you get your Wireless LAN network up and running, with a minimum of parameters.

### Card Specifications

|                                 |  |
|---------------------------------|--|
| <b>Form Factor</b>              | PCI Express Mini Card  |
| <b>Compatibility</b>            | <ul style="list-style-type: none"> <li>■ IEEE 802.11 Standard for Wireless LANs</li> <li>■ Wi-Fi (Wireless Fidelity) certified by the Wi-Fi Alliance. The “Wi-Fi CERTIFIED” logo is a certification mark of the Wi-Fi Alliance.</li> </ul> |
| <b>Network Operating System</b> | <ul style="list-style-type: none"> <li>■ Microsoft Windows® Networking</li> </ul>  |
| <b>Media Access Protocol</b>    | <ul style="list-style-type: none"> <li>■ CSMA/CA (Collision Avoidance) with Acknowledgment (ACK)</li> </ul>  |

### Radio Characteristics

Radio Characteristics of Wireless LAN Cards may vary according to:

- Country/region where the product was purchased
- Type of product

Wireless communication is often subject to local radio regulations. Although Wireless LAN wireless networking products have been designed for operation in the license-free 2.4GHz and 5GHz band, local radio regulations may impose a number of limitations to the use of wireless communication equipment.



*Refer to the sheet “Information to the User” for regulatory information that may apply in your country/region.*

---

|                      |  |
|----------------------|--|
| <b>R-F Frequency</b> | ■ Band 5GHz (5150-5850 MHz)<br>(Revision A, N Draft Ver. 1.0)        |
|                      | ■ Band 2.4GHz (2400-2483.5 MHz)<br>(Revision B, G, N Draft Ver. 1.0) |

---

The range of the wireless signal is related to the transmit rate of the wireless communication. Communications at lower transmit range may travel larger distances.

- The range of your wireless devices can be affected when the antennas are placed near metal surfaces and solid high-density materials.
- Range is also impacted due to “obstacles” in the signal path of the radio that may either absorb or reflect the radio signal.

## Supported Frequency Sub-bands

Subject to the radio regulations that apply in the countries/regions, your Wireless LAN card may support a different set of 5 GHz/2.4 GHz channels. Consult your Authorized Wireless LAN or TOSHIBA Sales office for information about the radio regulations that apply in the countries/regions.

### Wireless IEEE 802.11 Channels Sets (Revision B, G and N Draft Ver. 1.0)

---

| Frequency Range<br><b>Channel ID</b> | 2400-2483.5 MHz |
|--------------------------------------|-----------------|
| 1                                    | 2412            |
| 2                                    | 2417            |
| 3                                    | 2422            |
| 4                                    | 2427            |
| 5                                    | 2432            |
| 6                                    | 2437            |
| 7                                    | 2442            |
| 8                                    | 2447            |
| 9                                    | 2452            |
| 10                                   | <b>2457*1</b>   |
| 11                                   | 2462            |

---

|    |                |
|----|----------------|
| 12 | <b>2467</b> *2 |
| 13 | <b>2472</b> *2 |

\*1 Factory-set default channels

\*2 Refer to the sheet *Approved Countries/Regions for use* for the countries/regions that in which these channels can be used. When installing Wireless LAN cards, the channel configuration is managed as follows:

- For wireless clients that operate in a Wireless LAN Infrastructure, the Wireless LAN card will automatically start operation at the channel identified by the Wireless LAN Access Point. When roaming between different access points the station can dynamically switch to another channel if required.
- For Wireless LAN cards installed in wireless clients that operating in a peer-to-peer mode, the card will use the default channel 10.
- In a Wireless LAN Access Point, the Wireless LAN card will use the factory-set default channel (printed in bold), unless the LAN Administrator selected a different channel when configuring the Wireless LAN Access Point device.

### Wireless IEEE 802.11 Channels Sets (Revision A and N Draft Ver. 1.0)

| Frequency Range<br>Channel ID | 5150-5850 MHz |
|-------------------------------|---------------|
| 36                            | 5180          |
| 40                            | 5200          |
| 44                            | 5220          |
| 48                            | 5240          |
| 52                            | 5260          |
| 56                            | 5280          |
| 60                            | 5300          |
| 64                            | 5320          |
| 100                           | 5500          |
| 104                           | 5520          |
| 108                           | 5540          |

|     |      |
|-----|------|
| 112 | 5560 |
| 116 | 5580 |
| 120 | 5600 |
| 124 | 5620 |
| 128 | 5640 |
| 132 | 5660 |
| 136 | 5680 |
| 140 | 5700 |
| 149 | 5745 |
| 153 | 5765 |
| 157 | 5785 |
| 161 | 5805 |
| 165 | 5825 |

# Appendix D

## Bluetooth wireless technology Interoperability

Bluetooth® Cards from TOSHIBA are designed to be interoperable with any product with Bluetooth wireless technology that is based on Frequency Hopping Spread Spectrum (FHSS) radio technology, and is compliant to:

- Bluetooth Specification Ver. 2.0+EDR, as defined and approved by The Bluetooth Special Interest Group.
- Logo certification with Bluetooth wireless technology as defined by The Bluetooth Special interest Group.



- *Bluetooth wireless technology is a new innovative technology, and TOSHIBA has not confirmed compatibility of its Bluetooth® products with all computers and/or equipment using Bluetooth wireless technology other than TOSHIBA portable computers. Always use Bluetooth® Cards from TOSHIBA in order to enable wireless networks over two or more (up to a total of seven) TOSHIBA portable computers using these cards. Please contact TOSHIBA PC product support on Web site <http://www.toshiba-europe.com/computers/tnt/bluetooth.htm> in Europe*
- *When you use Bluetooth® Cards from TOSHIBA close to 2.4 GHz Wireless LAN devices, Bluetooth transmissions might slow down or cause errors. If you detect certain interference while you use Bluetooth® Cards from TOSHIBA, always change the frequency, move your computer to the area outside of the interference range of 2.4 GHz Wireless LAN devices (40 meters/43.74 yards or more) or stop transmitting from your computer. Please contact TOSHIBA PC product support on Web site <http://www.toshiba-europe.com/computers/tnt/bluetooth.htm> in Europe*
- *Bluetooth® and Wireless LAN devices operate within the same radio frequency range and may interfere with one another. If you use Bluetooth® and Wireless LAN devices simultaneously, you may occasionally experience a less than optimal network performance or even lose your network connection. If you should experience any such problem, immediately turn off either one of your Bluetooth® or Wireless LAN. Please contact TOSHIBA PC product support on web site <http://www.toshiba-europe.com/computers/tnt/bluetooth.htm> in Europe*

## Bluetooth wireless technology and your Health

The products with Bluetooth wireless technology, like other radio devices, emit radio frequency electromagnetic energy. The level of energy emitted by devices with Bluetooth wireless technology however is far much less than the electromagnetic energy emitted by wireless devices like for example mobile phones.

Because products with Bluetooth wireless technology operate within the guidelines found in radio frequency safety standards and recommendations, TOSHIBA believes Bluetooth wireless technology is safe for use by consumers. These standards and recommendations reflect the consensus of the scientific community and result from deliberations of panels and committees of scientists who continually review and interpret the extensive research literature.

In some situations or environments, the use of Bluetooth wireless technology may be restricted by the proprietor of the building or responsible representatives of the organization. These situations may for example include:

- Using the equipment with Bluetooth wireless technology on board of airplanes, or
- In any other environment where the risk of interference to other devices or services is perceived or identified as harmful.

If you are uncertain of the policy that applies on the use of wireless devices in a specific organization or environment (e.g. airports), you are encouraged to ask for authorization to use the device with Bluetooth wireless technology prior to turning on the equipment.

## Regulatory statements

### General

This product complies with any mandatory product specification in any country/region where the product is sold. In addition, the product complies with the following.

### European Union (EU) and EFTA

This equipment complies with the R&TTE directive 1999/5/EC and has been provided with the CE mark accordingly.

# Appendix E

## AC Power Cord and Connectors

The power cord's AC input plug must be compatible with the various international AC power outlets and the cord must meet the standards for the country/region in which it is used. All cords must meet the following specifications:

|                        |   |
|------------------------|---|
| <b>Length:</b>         | Minimum 1.7 meters  |
| <b>Wire size:</b>      | Minimum 0.75 mm <sup>2</sup>                                      |
| <b>Current rating:</b> | Minimum 2.5 amperes   |
| <b>Voltage rating:</b> | 125 or 250 VAC<br>(depending on country/region's power standards) |

### Certification agencies

|                         |  |                         |       |
|-------------------------|--|-------------------------|-------|
| <b>U.S. and Canada:</b> | UL listed and CSA certified<br>No. 18 AWG, Type SVT or SPT-2 |                         |       |
| <b>Australia:</b>       | AS   |                         |       |
| <b>Japan:</b>           | DENANHO  |                         |       |
| <b><i>Europe:</i></b>   |  |                         |       |
| <b>Austria:</b>         | OVE  | <b>Italy:</b>           | IMQ   |
| <b>Belgium:</b>         | CEBEC  | <b>The Netherlands:</b> | KEMA  |
| <b>Denmark:</b>         | DEMKO  | <b>Norway:</b>          | NEMKO |
| <b>Finland:</b>         | FIMKO  | <b>Sweden:</b>          | SEMKO |
| <b>France:</b>          | LCIE   | <b>Switzerland:</b>     | SEV   |
| <b>Germany:</b>         | VDE  | <b>United Kingdom:</b>  | BSI   |

In Europe, two conductors power cord must be VDE type, H05VVH2-F or H03VVH2-F and for three conductors power cord must be VDE type, H05VV-F.

For the United States and Canada, two pin plug configuration must be a 2-15P (250V) or 1-15P (125V) and three pin plug configuration must be 6-15P (250V) or 5-15P (125V) as designated in the U.S. National Electrical code handbook and the Canadian Electrical Code Part II.

The following illustrations show the plug shapes for the U.S.A. and Canada, the United Kingdom, Australia and Europe.

**USA and Canada**

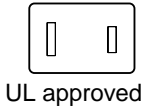

**United Kingdom**

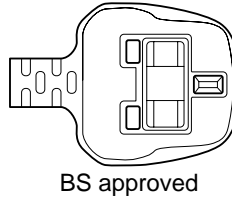

**Australia**

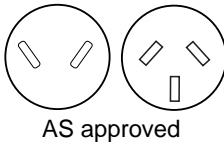

**Europe**

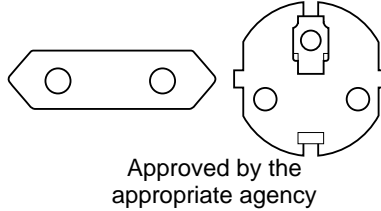

**Canada**

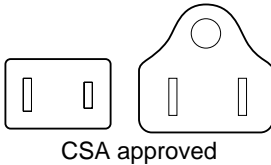



# Appendix F

## Usage Restrictions

This appendix describes the Usage Restrictions.

- This configuration is designed to work with a signal from a conventional (standard or analog) TV antenna.
- TOSHIBA does not guarantee that signals received by satellite or cable TV receivers will work properly and does not provide technical support for them.
- The TOSHIBA Qosmio's AC power adaptor must be connected to get the best possible audio and video performance.
- For copyright protection reasons, TOSHIBA has incorporated CGMS (Copy Generation Management System) restrictions into this product. This allows a broadcasting channel to send a signal to prevent a motion picture from being copied.
- The Microsoft® Windows Vista™'s radio features cannot be used because the TV feature does not include a radio receiver (FM tuner).
- If your computer is equipped with single tuner, it is not possible to record a TV program on one channel and simultaneously view a TV program on another channel because the computer only has one TV feature. However, it is possible to view one recorded TV program and simultaneously record another.
- The TV feature lets you capture and record a video stream (S-Video/Composite Video) from a camcorder, DVD player, etc. Because of the large number of peripherals currently on the market, TOSHIBA does not guarantee that this type of configuration will work properly and does not provide support for this functionality.



# Appendix G

## If your computer is stolen



*Always take care of your computer and try to prevent it from being stolen. You are the owner of a valuable technical device, which may be highly attractive to thieves, so please do not leave it unattended in a public place. To further help protect against theft, security cables can be bought for use with your notebook when it is being used at home or in the office.*

*Make a note of your computer's machine type, model number, and serial number, and put it in a safe place. You will find this information on the underside of your notebook. Please also keep the receipt of the computer you purchased.*

**Should your computer be stolen**, however, we'll help you try to find it. Before contacting TOSHIBA, please prepare the following information which is necessary to uniquely identify your computer:

- In which country was your computer stolen?
- What type of machine do you have?
- What was the model number (PA number)?
- What was the serial number (8 digits)?
- When was it stolen, i.e. date?
- What is your address, phone, and fax number?

***To register the theft on paper, please follow these procedures:***

- Fill in the TOSHIBA Theft Registration form (or a copy of it) below.
- Attach a copy of your receipt showing where your computer was purchased.
- Either fax or send the receipt and registration form to the address below.

***To register the theft online, please follow these procedures:***

- Visit [www.toshiba-europe.com](http://www.toshiba-europe.com) on the Internet. In the product area, choose **Computer Systems**.
- In the Computer Systems page, open the **Support & Downloads** menu and choose the **Stolen Units Database** option.

Your entries are used to track your computer at our service points.

**TOSHIBA Theft Registration**

Send to: TOSHIBA Europe GmbH  
Technical Service and Support  
Leibnizstr. 2  
93055 Regensburg  
Germany

Fax number: +49 (0) 941 7807 921

---

Country stolen:

---

Machine type:  
(e.g. Qosmio G40)

---

Model number:  
(e.g. PSA50 YXT)

|  |  |  |  |  |  |  |  |  |  |  |  |  |  |  |  |  |  |  |  |
|--|--|--|--|--|--|--|--|--|--|--|--|--|--|--|--|--|--|--|--|
|  |  |  |  |  |  |  |  |  |  |  |  |  |  |  |  |  |  |  |  |
|--|--|--|--|--|--|--|--|--|--|--|--|--|--|--|--|--|--|--|--|

Serial number:  
(e.g. 12345678G)

|  |  |  |  |  |  |  |  |  |  |  |
|--|--|--|--|--|--|--|--|--|--|--|
|  |  |  |  |  |  |  |  |  |  |  |
|--|--|--|--|--|--|--|--|--|--|--|

Date stolen:

Year

Month

Day

|  |  |  |  |
|--|--|--|--|
|  |  |  |  |
|--|--|--|--|

|  |  |
|--|--|
|  |  |
|--|--|

|  |  |
|--|--|
|  |  |
|--|--|

**Owner's details**

---

Last name, first name:

---

Company:

---

Street:

---

Postal Code/City:

---

Country:

---

Phone:

---

Fax:

---

---

# Glossary

The terms in this glossary cover topics related to this manual. Alternate naming is included for reference.

## Abbreviations

- AC:** alternating current
- AGP:** accelerated graphics port
- ANSI:** American National Standards Institute
- APM:** advanced power manager
- ASCII:** American Standard Code for Information Interchange
- BIOS:** basic input output system
- CD-ROM:** Compact Disc Read Only Memory
- CD-RW:** Compact Disc ReWritable
- CMOS:** complementary metal-oxide semiconductor
- CPU:** central processing unit
- CRT:** cathode ray tube
- DC:** direct current
- DDC:** display data channel
- DMA:** direct memory access
- DOS:** disk operating system
- DVD:** digital versatile disc
- DVD-R:** Digital Versatile Disc Recordable
- DVD-RAM:** Digital Versatile Disc Random Access Memory
- DVD-R (Dual Layer):** Digital Versatile Disc Recordable Dual Layer
- DVD-ROM:** Digital Versatile Disc Read Only Memory
- DVD-RW:** Digital Versatile Disc ReWritable
- DVD+R (Double Layer):** Digital Versatile Disc Recordable Double Layer
- ECP:** extended capabilities port
- FDD:** floppy diskette drive
- FIR:** fast infrared
- HDD:** hard disk drive

**HD DVD-R:** High Definition Digital Versatile Disc Recordable  
**HD DVD-ROM:** High Definition Digital Versatile Disc Read Only Memory  
**IDE:** integrated drive electronics  
**I/O:** input/output  
**IrDA:** Infrared Data Association  
**IRQ:** interrupt request  
**KB:** kilobyte  
**LCD:** liquid crystal display  
**LED:** light emitting diode  
**LSI:** large scale integration  
**MB:** megabyte  
**OCR:** optical character recognition (reader)  
**PCB:** printed circuit board  
**PCI:** peripheral component interconnect  
**RAM:** random access memory  
**RGB:** red, green, and blue  
**ROM:** read only memory  
**RTC:** real time clock  
**SCSI:** small computer system interface  
**SIO:** serial input/output  
**TFT:** thin-film transistor  
**UART:** universal asynchronous receiver/transmitter  
**USB:** Universal Serial Bus  
**VESA:** Video Electronic Standards Association  
**VGA:** video graphics array  
**VRT:** voltage reduction technology  
**WUXGA:** wide ultra extended graphics array  
**XGA:** extended graphics array

## A

**adaptor:** A device that provides an interface between two dissimilar electronic devices. For example, the AC adaptor modifies the power from a wall outlet for use by the computer. This term also refers to the add-in circuit cards that control external devices, such as video monitors and magnetic tape devices.

**allocate:** To assign a space or function for a specific task.

**alphanumeric:** Keyboard characters including letters, numbers and other symbols, such as punctuation marks or mathematical symbols.

**alternating current (AC):** Electric current that reverses its direction of flow at regular intervals.

**analog signal:** A signal whose characteristics such as amplitude and frequency vary in proportion to (are an analog of) the value to be transmitted. Voice communications are analog signals.

**ANSI:** American National Standards Institute. An organization established to adopt and define standards for a variety of technical disciplines. For example, ANSI defined the ASCII standard and other information processing requirements.

**antistatic:** A material used to prevent the buildup of static electricity.

**application:** A group of programs that together are used for a specific task such as accounting, financial planning, spreadsheets, word processing and games.

**ASCII:** American Standard Code for Information Interchange. ASCII code is a set of 256 binary codes that represent the most commonly used letters, numbers, and symbols.

**async:** Short for asynchronous.

**asynchronous:** Lacking regular time relationship. As applied to computer communications, asynchronous refers to the method of transmitting data that does not require a steady stream of bits to be transmitted at regular time intervals.

## B

**backup:** A duplicate copy of files kept as a spare in case the original is destroyed.

**batch file:** A file that can be executed from the system prompt containing a sequence of operating system commands or executable files.

**binary:** The base two number system composed of zeros and ones (off or on), used by most digital computers. The right-most digit of a binary number has a value of 1, the next a value of 2, then 4, 8, 16, and so on. For example, the binary number 101 has a value of 5. *See also* ASCII.

**BIOS:** Basic Input Output System. The firmware that controls data flow within the computer. *See also* firmware.

**bit:** Derived from "binary digit," the basic unit of information used by the computer. It is either zero or one. Eight bits is one byte. *See also* byte.

**board:** A circuit board. An internal card containing electronic components, called chips, which perform a specific function or increase the capabilities of the system.

**boot:** Short for bootstrap. A program that starts or restarts the computer. The program reads instructions from a storage device into the computer's memory.

**bps:** Bits per second. Typically used to describe the data transmission speed of a modem.

**buffer:** The portion of the computer's memory where data is temporarily stored. Buffers often compensate for differences in the rate of flow from one device to another.

**bus:** An interface for transmission of signals, data or electric power.

**byte:** The representation of a single character. A sequence of eight bits treated as a single unit; also the smallest addressable unit within the system.

## C

**cache memory:** High speed memory which stores data that increases processor speed and data transfer rate. When the CPU reads data from main memory, it stores a copy of this data in cache memory. The next time the CPU needs that same data, it looks for it in the cache memory rather than the main memory, which saves time. The computer has two cache levels. Level one is incorporated into the processor and level two resides in external memory.

**capacity:** The amount of data that can be stored on a magnetic storage device such as a floppy diskette or hard disk drive. It is usually described in terms of kilobytes (KB), where one KB = 1024 bytes and megabytes (MB), where one MB = 1024 KB.

**card:** Synonym for board. See board.

**CardBus:** An industry standard bus for 32-bit PC Cards.

**CD-ROM:** A Compact Disc Read Only Memory is a high capacity disc that can be read from but not written to. The CD-ROM drive uses a laser, rather than magnetic heads, to read data from the disc.

**CD-R:** A Compact Disc Recordable disc can be written once and read many times. See also CD-ROM.

**CD-RW:** A Compact Disc ReWritable disc can be rewritten many times. See also CD-ROM.

**character:** Any letter, number, punctuation mark, or symbol used by the computer. Also synonymous with byte.

**chassis:** The frame containing the computer.

**chip:** A small semiconductor containing computer logic and circuitry for processing, memory, input/output functions and controlling other chips.



- CMOS:** Complementary Metal-Oxide Semiconductor. An electronic circuit fabricated on a silicon wafer that requires very little power. Integrated circuits implemented in CMOS technology can be tightly packaged and are highly reliable.
- cold start:** Starting a computer that is currently off (turning on the power).
- COM1, COM2, COM3 and COM4:** The names assigned to the serial and communication ports.
- commands:** Instructions you enter at the terminal keyboard that direct the actions of the computer or its peripheral devices.
- communications:** The means by which a computer transmits and receives data to and from another computer or device.
- compatibility:** 1) The ability of one computer to accept and process data in the same manner as another computer without modifying the data or the media upon which it is being transferred.  
2) the ability of one device to connect to or communicate with another system or component.
- components:** Elements or parts (of a system) which make up the whole (system).
- Composite Video (YUV):** A standard video signal used to transmit images, e.g. from a VCR to a TV.
- computer program:** A set of instructions written for a computer that enable it to achieve a desired result.
- computer system:** A combination of hardware, software, firmware, and peripheral components assembled to process data into useful information.
- configuration:** The specific components in your system (such as the terminal, printer, and disk drives) and the settings that define how your system works. You use the HW Setup program to control your system configuration.
- control keys:** A key or sequence of keys you enter from the keyboard to initiate a particular function within a program.
- controller:** Built-in hardware and software that controls the functions of a specific internal or peripheral device (e.g. keyboard controller).
- co-processor:** A circuit built into the processor that is dedicated to intensive math calculations.
- CPS:** Characters Per Second. Typically used to indicate the transmission speed of a printer.
- CPU:** Central Processing Unit. The portion of the computer that interprets and executes instructions.

**CRT:** Cathode Ray Tube. A vacuum tube in which beams projected on a fluorescent screen-producing luminous spots. An example is the television set.

**cursor:** A small, blinking rectangle or line that indicates the current position on the display screen.

## D

**data:** Information that is factual, measurable or statistical that a computer can process, store, or retrieve.

**data bits:** A data communications parameter controlling the number of bits (binary digits) used to make up a byte. If data bits = 7 the computer can generate 128 unique characters. If data bits = 8 the computer can generate 256 unique characters.

**DC:** Direct Current. Electric current that flows in one direction. This type of power is usually supplied by batteries.

**default:** The parameter value automatically selected by the system when you or the program do not provide instructions. Also called a preset value.

**delete:** To remove data from a disk or other data storage device. Synonymous with erase.

**device driver:** A program that controls communication between a specific peripheral device and the computer. The CONFIG.SYS file contains device drivers that MS-DOS loads when you turn the computer on.

**dialog box:** A window that accepts user input to make system settings or record other information.

**Digital Audio:** An audio compression standard that enables high-quality transmission and real-time playback of sound files.

**disk drive:** The device that randomly accesses information on a disk and copies it to the computer's memory. It also writes data from memory to the disk. To accomplish these tasks, the unit physically rotates the disk at high speed past a read-write head.

**disk storage:** Storing data on magnetic disk. Data is arranged on concentric tracks much like a phonograph record.

**display:** A CRT, LCD, or other image producing device used to view computer output.

**documentation:** The set of manuals and/or other instructions written for the users of a computer system or application. Computer system documentation typically includes procedural and tutorial information as well as system functions.

**DOS:** Disk Operating System. See operating system.

**driver:** A software program, generally part of the operating system, that controls a specific piece of hardware (frequently a peripheral device such as a printer or mouse).

**DVB-T (Digital Video Broadcasting - Terrestrial):** Also known as terrestrial digital TV. Digital TV broadcasting standard.

**DVD-R (+R, -R):** A Digital Versatile Disc Recordable disc can be written once and read many times. The DVD-R drive uses a laser to read data from the disc.

**DVD-RAM:** A Digital Versatile Disc Random Access Memory is a high-capacity, high performance disc that lets you store large volumes of data. The DVD-RAM drive uses a laser to read data from the disc.

**DVD-R (Dual Layer):** A disc having two layers on one side with the DVD-R storage capacity about 1.8 times larger than before. The DVD-RW drive uses a laser to read data from the disc.

**DVD-ROM:** A Digital Versatile Disc Read Only Memory is a high capacity, high performance disc suitable for play back of video and other high-density files. The DVD-ROM drive uses a laser to read data from the disc.

**DVD-RW (+RW, -RW):** A Digital Versatile Disc ReWritable disc can be rewritten many times.

**DVD+R (Double Layer):** A disc having two layers on one side with the DVD+R storage capacity about 1.8 times larger than before. The DVD-RW drive uses a laser to read data from the disc.

## E

**echo:** To send back a reflection of the transmitted data to the sending device. You can display the information on the screen, or output it to the printer, or both. When a computer receives back data it transmitted to a CRT (or other peripheral device) and then retransmits the data to printer, the printer is said to echo the CRT.

**erase:** See delete.

**escape:** 1) A code (ASCII code 27), signaling the computer that what follows are commands; used with peripheral devices such as printers and modems.

2) A means of aborting the task currently in progress.

**escape guard time:** A time before and after an escape code is sent to the modem which distinguishes between escapes that are part of the transmitted data, and escapes that are intended as a command to the modem.

**execute:** To interpret and execute an instruction.

**Extended Capability Port:** An industry standard that provides a data buffer, switchable forward and reverse data transmission, and run length encoding (RLE) support.

## F

**fast infrared:** An industry standard that enables cableless infrared serial data transfer at speeds of up to 4 Mbps.

**file:** A collection of related information; a file can contain data, programs, or both.

**fingerprint sensor:** The fingerprint sensor compares and analyzes the unique characteristics in a fingerprint.

**firmware:** A set of instructions built into the hardware which controls and directs a microprocessor's activities.

**floppy diskette:** A removable disk that stores magnetically encoded data.

**floppy diskette drive (FDD):** An electromechanical device that reads and writes to floppy diskettes.

**Fn-esse:** A TOSHIBA utility that lets you assign functions to hot keys.

**folder:** An icon in Windows used to store documents or other folders.

**format:** The process of readying a blank disk for its first use. Formatting establishes the structure of the disk that the operating system expects before it writes files or programs onto the disk.

**function keys:** The keys labeled **F1** through **F12** that tell the computer to perform certain functions.

## G

**gigabyte (GB):** A unit of data storage equal to 1024 megabytes. *See also* megabyte.

**graphics:** Drawings, pictures, or other images, such as charts or graphs, to present information.

## H

**hard disk:** A non-removable disk usually referred to as drive C. The factory installs this disk and only a trained engineer can remove it for servicing. Also called fixed disk.

**hard disk drive (HDD):** An electromechanical device that reads and writes a hard disk. *See also* hard disk.

**HD DVD-R:** A High Definition Digital Versatile Disc Recordable is a high-capacity, high performance disc that lets you store large volumes of data. The HD DVD-R drive uses a laser to read data from the disc.

**HD DVD-ROM:** A High Definition Digital Versatile Disc Read Only Memory is a high capacity, high performance disc suitable for play back of video and other high-density files. The HD DVD-ROM drive uses a laser to read data from the disc.

**hardware:** The physical electronic and mechanical components of a computer system: typically, the computer itself, external disk drives, etc. *See also* software and firmware.

**hertz:** A unit of wave frequency that equals one cycle per second.

**hexadecimal:** The base 16 numbering system composed of the digits 0 through 9 and the letters A, B, C, D, E, and F.

**host computer:** The computer that controls, regulates, and transmits information to a device or another computer.

**hot key:** The computer's feature in which certain keys in combination with the extended function key, **FN**, can be used to set system parameters, such as speaker volume.

**HW Setup:** A TOSHIBA utility that lets you set the parameters for various hardware components.

## I

**icon:** A small graphic image displayed on the screen or in the indicator panel. In Windows, an icon represents an object that the user can manipulate.

**i.LINK (IEEE1394):** This port enables high-speed data transfer directly from external devices such as digital video cameras.

**input:** The data or instructions you provide to a computer, communication device or other peripheral device from the keyboard or external or internal storage devices. The data sent (or output) by the sending computer is input for the receiving computer.

**instruction:** Statements or commands that specify how to perform a particular task.

**interface:** 1) Hardware and/or software components of a system used specifically to connect one system or device to another.

2) To physically connect one system or device to another to exchange information.

3) The point of contact between user, the computer, and the program, for example, the keyboard or a menu.

**interrupt request:** A signal that gives a component access to the processor.

**I/O:** Input/output. Refers to acceptance and transfer of data to and from a computer.

**I/O devices:** Equipment used to communicate with the computer and transfer data to and from it.

**IrDA 1.1:** An industry standard that enables cableless infrared serial data transfer at speeds of up to 4 Mbps.

## J

**jumper:** A small clip or wire that allows you to change the hardware characteristics by electrically connecting two points of a circuit.

## K

**K:** Taken from the Greek word kilo, meaning 1000; often used as equivalent to 1024, or 2 raised to the 10th power. *See also* byte and kilobyte.

**KB:** *See* kilobyte.

**keyboard:** An input device containing switches that are activated by manually pressing marked keys. Each keystroke activates a switch that transmits a specific code to the computer. For each key, the transmitted code is, in turn, representative of the (ASCII) character marked on the key.

**kilobyte (KB):** A unit of data storage equal to 1024 bytes. *See also* byte and megabyte.

## L

**level 2 cache:** *See* cache.

**Light Emitting Diode (LED):** A semiconductor device that emits light when a current is applied.

**Liquid Crystal Display (LCD):** Liquid crystal sealed between two sheets of glass coated with transparent conducting material. The viewing-side coating is etched into character forming segments with leads that extend to the edge of the glass. Applying a voltage between the glass sheets alters the brightness of the liquid crystal.

**LSI:** Large Scale Integration.

- 1) A technology that allows the inclusion of up to 100,000 simple logic gates on a single chip.
- 2) An integrated circuit that uses large scale integration.

## M

**main board:** See motherboard.

**megabyte (MB):** A unit of data storage equal to 1024 kilobytes. See also kilobyte.

**megahertz:** A unit of wave frequency that equals 1 million cycles per second. See also hertz.

**menu:** A software interface that displays a list of options on the screen. Also called a screen.

**microprocessor:** A hardware component contained in a single integrated circuit that carries out instructions. Also called the central processing unit (CPU), one of the main parts of the computer.

**mode:** A method of operation, for example, the Boot Mode, Sleep Mode or the Hibernation Mode.

**modem:** Derived from modulator/demodulator, a device that converts (modulates) digital data for transmission over telephone lines and then converts modulated data (demodulates) to digital format where received.

**monitor:** A device that uses rows and columns of pixels to display alphanumeric characters or graphic images. See also CRT.

**motherboard:** A name sometimes used to refer to the main printed circuit board in processing equipment. It usually contains integrated circuits that perform the processor's basic functions and provides connectors for adding other boards that perform special functions. Sometimes called a main board.

## N

**non-system disk:** A formatted floppy diskette you can use to store programs and data but you cannot use to start the computer. See system disk.

**nonvolatile memory:** Memory, usually read-only (ROM), that is capable of permanently storing information. Turning the computer's power off does not alter data stored in nonvolatile memory.

**numeric keypad overlay:** A feature that allows you to use certain keys on the keyboard to perform numeric entry, or to control cursor and page movement.

## O

**OCR:** Optical Character Recognition (reader). A technique or device that uses laser or visible light to identify characters and input them into a storage device.

**online state:** A functional state of a peripheral device when it is ready to receive or transmit data.

**operating system:** A group of programs that controls the basic operation of a computer. Operating system functions include interpreting programs, creating data files, and controlling the transmission and receipt (input/output) of data to and from memory and peripheral devices.

**output:** The results of a computer operation. Output commonly indicates data.

1) printed on paper, 2) displayed at a terminal, 3) sent through the serial port of internal modem, or 4) stored on some magnetic media.

## P

**PAL:** PAL (Phase Alternating Line) is the dominant video and broadcasting standard in Europe.

**parity:** 1) The symmetrical relationship between two parameter values (integers) both of which are either on or off; odd or even; 0 or 1.  
2) In serial communications, an error detection bit that is added to a group of data bits making the sum of the bits even or odd. Parity can be set to none, odd, or even.

**password:** A unique string of characters used to identify a specific user. The computer provides various levels of password protection such as user and supervisor.

**pel:** The smallest area of the display that can be addressed by software. Equal in size to a pixel or group of pixels. See pixel.

**peripheral component interconnect:** An industry standard 32-bit bus.

**peripheral device:** An I/O device that is external to the central processor and/or main memory such as a printer or a mouse.

**Péritel:** Péritel is a 21-pin connecting cable/port system that allows images and high-quality stereo sound (including Dolby® Pro-Logic sound formats) to be sent from one audio-visual device to another. It is also known as a “SCART connector” or “Euro connector”.

**pixel:** A picture element. The smallest dot that can be made on a display or printer. Also called a pel.



- plug and play:** A capability with Windows that enables the system to automatically recognize connections of external devices and make the necessary configurations in the computer.
- port:** The electrical connection through which the computer sends and receives data to and from devices or other computers.
- Power Saver Utility:** A TOSHIBA utility that lets you set the parameters for various power-saving functions.
- printed circuit board (PCB):** A hardware component of a processor to which integrated circuits and other components are attached. The board itself is typically flat and rectangular, and constructed of fiberglass, to form the attachment surface.
- program:** A set of instructions a computer can execute that enables it to achieve a desired result. *See also* application.
- prompt:** A message the computer provides indicating it is ready for or requires information or an action from you.

## R

- Radio frequency interference (RFI) shield:** A metal shield enclosing the printed circuit boards of the printer or computer to prevent radio and TV interference. All computer equipment generates radio frequency signals. The FCC regulates the amount of signals a computing device can allow past its shielding. A Class A device is sufficient for office use. Class B provides a more stringent classification for home equipment use. TOSHIBA portable computers comply with Class B computing device regulations.
- Random Access Memory (RAM):** High speed memory within the computer circuitry that can be read or written to.
- restart:** Resetting a computer without turning it off (also called “warm boot” or “soft reset”). *See also* boot.
- RGB:** Red, green and blue. A device that uses three input signals, each activating an electron gun for a primary additive color (red, green and blue) or port for using such a device. *See also* CRT.
- RJ11:** A modular telephone jack.
- RJ45:** A modular LAN jack.
- ROM:** Read Only Memory: A nonvolatile memory chip manufactured to contain information that controls the computer’s basic operation. You cannot access or change information stored in ROM.

## S

- S-Video:** Short for *Super-Video*, a type of connection used by S-VHS videocassette players, camcorders, DVD players, etc. to transmit high-quality video signals.
- SCSI:** Small Computer System Interface is an industry standard interface for connection of a variety of peripheral devices.
- SD/SDHC memory card:** Secure Digital cards are flash memory widely used in a variety of digital devices such as digital cameras and Personal Digital Assistants.
- SECAM L:** SECAM (Sequential Color Memory) is a broadcasting standard used in France.
- serial communications:** A communications technique that uses as few as two interconnecting wires to send bits one after another.
- serial interface:** Refer to a type of information exchange that transmits information sequentially, one bit at a time.
- SIO:** Serial Input/Output. The electronic methodology used in serial data transmission.
- soft key:** Key combinations that emulate keys on the IBM keyboard, change some configuration options, stop program execution, and access the numeric keypad overlay.
- software:** The set of programs, procedures and related documentation associated with a computer system. Specifically refers to computer programs that direct and control the computer system's activities. *See also* hardware.
- stop bit:** One or more bits of a byte that follow the transmitted character or group codes in asynchronous serial communications.
- subpixel:** Three elements, one red, one green and blue (RGB), that make up a pixel on the color LCD. The computer sets subpixels independently, each may emit a different degree of brightness. *See also* pixel.
- synchronous:** Having a constant time interval between successive bits, characters or events.
- system disk:** A disk that has been formatted with an operating system. For MS-DOS the operating system is contained in two hidden files and the COMMAND.COM file. You can boot a computer using a system disk. Also called an operating system disk.

## T

**terminal:** A typewriter-like keyboard and CRT display screen connected to the computer for data input/output.

**TFT display:** A liquid crystal display (LCD) made from an array of liquid crystal cells using active-matrix technology with thin film transistor (TFT) to drive each cell.

**Touch Pad:** A pointing device integrated into the TOSHIBA computer palm rest.

**TTL:** Transistor-transistor logic. A logic circuit design that uses switching transistors for gates and storage.

## U

**Universal Serial Bus:** This serial interface lets you communicate with several devices connected in a chain to a single port on the computer.

## V

**VGA:** Video Graphics Array is an industry standard video adaptor that lets you run any popular software.

**volatile memory:** Random access memory (RAM) that stores information as long as power is supplied to the computer.

## W

**warm start:** Restarting or resetting a computer without turning it off.

**window:** A portion of the screen that can display its own application, document or dialog box. Often used to mean a Microsoft Windows window.

**Wireless LAN:** Local Area Network (LAN) through wireless communication.

**write protection:** A method for protecting a floppy diskette from accidental erasure.



# Index

## A

- AC adaptor, 1-4
  - additional, 1-17
  - connecting, 3-2
  - DC IN 15V jack, 2-6
- ASCII characters, 5-7

## B

- Battery
  - charging, 6-7
  - extending battery life, 6-10
  - indicator, 2-13, 6-2
  - Monitoring capacity, 6-8
  - real time clock, 1-4, 6-5
  - save mode, 1-13
  - types, 6-4
- Battery Charger, 1-17, 9-16
- Battery pack, 1-4, 2-9
  - additional, 9-15
  - replacing, 6-11
- BIOS Setup, 7-7
- Bluetooth, 1-10, 4-37
  - Bluetooth Stack for Windows by Toshiba, 1-15
  - Bluetooth USB Adaptor, 1-17
  - Bluetooth Wireless Mouse, 1-18
  - Bluetooth Wireless Stereo, 1-18
  - problems, 10-23
- Boot Priority, 7-2
- Bridge media slot, 1-8, 2-3, 9-6
  - indicator, 2-13
  - using, 9-6

## C

- Cache memory, 1-3
- Cleaning the computer, 4-42
- Cooling vents, 2-6

## D

- DC IN indicator, 2-12, 6-3
- Display, 1-7, 2-9
  - automatic power off, 1-12
  - brightness (down), 5-4
  - brightness (up), 5-4
  - controller, B-1
  - hinge, 2-9
  - opening, 3-4
  - screen, 2-9
- Documentation list, 1-2

## E

- Equipment checklist, 1-1
- ExpressCard, 1-8, 9-4
  - inserting, 9-4
  - problems, 10-13
  - removing, 9-5
- External monitor, 1-8, 2-7, 9-18
  - problems, 10-21

## F

- Fingerprint Sensor
  - location, 2-9
  - problems, 10-18
  - using, 4-3
- FN + 1 (TOSHIBA Zooming Utility reduce), 5-5
- FN + 2 (TOSHIBA Zooming Utility enlarge), 5-5

- FN + ENTER, 5-3
- FN + ESC (Mute), 5-3
- FN + F1 (Lock), 5-3
- FN + F10 (Arrow mode), 5-6
- FN + F11 (Numeric mode), 5-6
- FN + F12 (ScrLock), 5-3
- FN + F2 (Power Plan), 5-3
- FN + F3 (Sleep), 5-4
- FN + F4 (Hibernate), 5-4
- FN + F5 (Output), 5-4
- FN + F6 (Brightness Down), 5-4
- FN + F7 (Brightness Up), 5-4
- FN + F8 (Wireless), 5-4
- FN + F9 (Touch Pad), 5-4
- FN + space (Zoom), 5-5
- Front operation panel, 8-2
- Function keys, 5-2

## G

- Graphics controller, 1-7

## H

- Hard disk drive, 1-5
  - automatic power off, 1-12
- HD DVD-R drive
  - problems, 10-10
  - using, 4-12
  - writing, 4-12
- HD DVD-ROM drive, 1-6, 1-7
  - problems, 10-9
  - using, 4-12
- Heat dispersal, 1-13
- Hibernation Mode, 1-13
- Hot keys, 1-12
  - Brightness (Down), 5-4
  - Brightness (Up), 5-4
  - Hibernate, 5-4
  - Lock, 5-3
  - Mute, 5-3
  - Output, 5-4
  - Power Plan, 5-3
  - Sleep, 5-4
  - TOSHIBA Zooming Utility (enlarge), 5-5
  - TOSHIBA Zooming Utility (reduce), 5-5

- Touch Pad, 5-4
- Wireless, 5-4
- Zoom, 5-5

## HW Setup

- accessing, 7-1
- Boot Priority, 7-2
- CPU, 7-5
- device config, 7-6
- general, 7-1
- keyboard, 7-4
- LAN, 7-5
- USB, 7-6
- window, 7-1

## I

- i.LINK, 1-8, 2-3, 9-23
  - connecting, 9-24
  - disconnecting, 9-24
  - precautions, 9-23
  - problems, 10-24

## Indicators

- Battery, 2-13, 6-2
- DC IN, 2-12
- Hard Disk Drive, 2-13
- Optical Disc Drive, 2-13
- Power, 2-13
- Wireless communication, 2-13
- Infrared receiver window, 1-10, 2-1
  - problems, 10-15

## K

- Keyboard, 1-8, 5-1
  - emulating keys on enhanced, 5-2
  - FN Sticky key, 5-5
  - Function keys F1 ... F12, 5-2
  - Hot keys, 5-3
  - problems, 10-7
  - Typewriter keys, 5-1
  - Windows special keys, 5-5
- Keypad overlay, 1-12, 5-6
  - arrow mode, 5-6
  - numeric mode, 5-6
  - temporarily using normal keyboard (overlay on), 5-7
  - temporarily using overlay (overlay off), 5-7
  - turning on the overlays, 5-6

**L**

- LAN, 1-10, 4-40
  - active indicator, 2-7
  - cable types, 4-40
  - connecting, 4-41
  - disconnecting, 4-41
  - jack, 2-7
  - Link indicator, 2-7
  - problems, 10-23

**M**

- Media care, 4-27
  - CD/DVDs, 4-27
  - floppy diskettes, 4-27
- Memory, 1-3
  - expansion, 1-17, 9-11
  - installing, 9-12
  - removing, 9-14
- Memory Stick/Memory Stick PRO/Memory Stick PRO Duo
  - problems, 10-14
- Modem, 1-10, 4-32
  - connecting, 4-35
  - disconnecting, 4-36
  - jack, 2-4
  - problems, 10-22
  - properties menu, 4-33
  - region selection, 4-33
- Moving the computer, 4-42
- MultiMediaCard
  - problems, 10-15

**P**

- Password
  - power on, 1-12
  - problems, 10-7
  - starting the computer by, 6-14
  - supervisor, 6-14
  - user, 6-13
- PC Card, 1-8, 9-2
  - inserting, 9-2
  - location of slot, 2-2
  - problems, 10-12
  - removing, 9-3
- Pointing device
  - Touch Pad, 2-10, 4-1
  - Touch Pad control buttons, 2-11, 4-1
- Ports, 1-8
  - External monitor, 1-8
  - i.LINK, 1-8
  - USB, 1-8
- Power
  - button location, 2-9
  - conditions, 6-1
  - Hibernation Mode, 3-8
  - indicator, 6-3
  - panel on/off, 1-13
  - panel power on/off, 6-16
  - Shut Down mode (Boot Mode), 3-6
  - Sleep Mode, 3-6
  - system auto off, 6-16
  - turning off, 3-6
  - turning on, 3-5
- Power-up modes, 6-15
- Problems
  - AC power, 10-5
  - Analyzing the problem, 10-2
  - Battery, 10-6
  - Bluetooth, 10-23
  - ExpressCard, 10-13
  - External monitor, 10-21
  - Fingerprint Sensor, 10-18
  - Hard disk drive, 10-8
  - Hardware and system checklist, 10-3
  - HD DVD-R drive, 10-10
  - HD DVD-ROM drive, 10-9
  - i.LINK (IEEE1394) device, 10-24
  - Infrared receiver window, 10-15
  - Internal display panel, 10-8
  - Keyboard, 10-7
  - LAN, 10-23
  - Memory expansion, 10-19
  - Memory Stick/Memory Stick PRO/Memory Stick PRO Duo, 10-14
  - Modem, 10-22
  - MultiMediaCard, 10-15
  - Overheating power down, 10-5
  - Password, 10-7
  - PC Card, 10-12
  - Pointing device, 10-16
  - Power, 10-4

- SD/SDHC memory card, miniSD/microSD Card, 10-13
- Self test, 10-4
- Sound system, 10-20
- System start-up, 10-4
- TOSHIBA support, 10-26
- Touch Pad, 10-16
- TV output signal, 10-24
- USB device, 10-19
- USB floppy diskette drive, 10-12
- USB mouse, 10-17
- USB Sleep and Charge, 10-7
- Video Playback, 10-25
- Wireless LAN, 10-23
- xD picture card, 10-14

Processor, 1-3

## Q

Qosmio AV Controller, 1-8

## R

Remote Controller, 8-5

Restarting the computer, 3-9

## S

SD/SDHC memory card, miniSD/microSD Card

- problems, 10-13

Security lock

- attaching, 9-25

Sleep Mode, 1-13

- setting, 3-6
- System automatic, 1-12

Soft keys

- emulating keys on enhanced keyboard, 5-2
- ENTER, 5-3
- ScrLock, 5-3

Sound system, 1-9, 4-30

- headphone jack, 1-9, 2-4
- Line-in jack, 1-10
- microphone, 2-12
- microphone jack, 1-10, 2-4
- Stereo speakers, 2-10
- Volume control dial, 2-12

## T

TOSHIBA Assist, 1-15

TOSHIBA ConfigFree, 1-15

TOSHIBA Disc Creator, 1-16, 4-23

TOSHIBA PC Diagnostic Tool, 1-14

TOSHIBA SD Memory Card Format, 1-16

TOSHIBA support, 10-26

TOSHIBA Theft Registration, G-2

TOSHIBA Zooming Utility, 1-14

Touch Pad, 1-8

- location, 2-9
- using, 4-1

TV Tuner, 1-10, 4-28

TV, 9-19

## U

USB device, 1-8

- location, 2-4
- problems, 10-19

USB floppy diskette drive, 9-16

- problems, 10-12
- using, 9-17

## V

Video modes, B-1

Video RAM, 1-4

Volume control dial, 2-12

## W

Web Camera, 1-9

Wireless communication, 4-36

- indicator, 2-13, 4-39

Wireless communication switch, 1-11, 2-3, 4-39

Wireless LAN, 1-11, 4-36

- problems, 10-23

## X

xD picture card

- problems, 10-14