



Refrigerator user manual

Planet
First

100 %
Recycled Paper

This manual is made with 100 % recycled paper.

imagine the possibilities

Thank you for purchasing this Samsung product.

Free Standing Appliance



Contents

| | |
|---|-----------|
| SAFETY INFORMATION | 2 |
| SETTING UP YOUR REFRIGERATOR | 12 |
| OPERATING YOUR REFRIGERATOR | 17 |
| TROUBLESHOOTING | 23 |
| INSTALLATION PART | 24 |

Safety information

SAFETY INFORMATION









- Before operating the appliance, please read this manual thoroughly and retain it for your reference.
- Use this appliance only for its intended purpose as described in this instruction manual. This appliance is not intended for use by persons (including children) with reduced physical, sensory or mental capabilities, or lack of experience and knowledge, unless they have been given supervision or instruction concerning use of the appliance by a person responsible for their safety.
- This appliance can be used by children aged from 8 years and above and persons with reduced physical, sensory or mental capabilities or lack of experience and knowledge if they have been given supervision or instruction concerning use of the appliance in a safe way and understand the hazards involved. Children shall not play with the appliance. Cleaning and user maintenance shall not be made by children without supervision.

English - 2

- Because these following operating instructions cover various models, the characteristics of your refrigerator may differ slightly from those described in this manual.
- It is hazardous for anyone other than an Authorised Service Person to service this appliance. In Queensland – the authorized Service Person MUST hold a Gas Work Authorisation or Licence for hydrocarbon refrigerants, to carry out Servicing or repairs which involve the removal of covers. (For Australia only)

Important safety symbols and precautions :

| | |
|---|--|
|  | <p>Hazards or unsafe practices that may result in severe personal injury or death.</p> |
|  | <p>Hazards or unsafe practices that may result in minor personal injury or property damage.</p> |

| | |
|---|--|
|  | Do NOT attempt. |
|  | Do NOT disassemble. |
|  | Do NOT touch. |
|  | Follow directions carefully. |
|  | Unplug the power plug from the wall socket. |
|  | Make sure the machine is grounded to prevent electric shock. |
|  | Call the contact center for help. |
|  | Note. |

These warning signs are here to prevent injury to you and others. Please follow them carefully. After reading this section, keep it in a safe place for future reference.

CE Notice

This product has been determined to be in compliance with the Low Voltage Directive (2006/95/EC), the Electromagnetic Compatibility Directive (2004/108/EC), RoHS Directive (2011/65/EU), Commission Delegated Regulation (EU) No 1060/2010 and the Eco-Design Directive(2009/125/EC) implemented by Regulation (EC) No 643/2009 of the European Union. (For products sold in European Countries only)



SEVERE WARNING SIGNS FOR INSTALLATION

- Do not install the refrigerator in a damp place or place where it may come in contact with water.
- Deteriorated insulation of electrical parts may cause an electric shock or fire.
- Do not place this refrigerator in direct sunlight or expose to the heat from stoves, room heaters or other appliance.
- Never use gas pipes, telephone lines or other potential lightning rods as ground.
- Improper use of the ground plug can result in electric shock.
- Do not plug several appliances into the same multiple power board. The refrigerator should always be plugged into its own individual electrical which has a voltage rating that matched the rating plate.
- This provides the best performance and also prevents overloading house wiring circuits, which could cause a fire hazard from overheated wires.
- If the wall socket is loose, do not insert the power plug.
- There is a risk of electric shock of fire.
- Do not use a cord that shows cracks or abrasion damage along its length or at either end.
- Do not bend the power cord excessively or place heavy articles on it.

-  • This refrigerator must be properly installed and located in accordance with the manual before it is used.
- Connect the power plug in proper position with the cord hanging down.
 - If you connect the power plug upside down, wire can get cut off and cause fire or electric shock.
- When moving the refrigerator, be careful not to roll over or damage the power cord.
 - This constitutes a fire hazard.
- Make sure that the power plug is not squashed or damaged by the back of the refrigerator.
- Keep the packing materials out of reach of children.
 - There is a risk of death from suffocation if children put them on their head.
- The appliance must be positioned so that the plug is accessible after installation.

-  • The refrigerator must be grounded.
 - You must ground the refrigerator to prevent any

power leakages or electric shocks caused by current leakage from the refrigerator.

-  • If the power cord is damaged, have it replaced immediately by the manufacturer or its service agent.
- The fuse on refrigerator must be changed by a qualified technician or service company.
 - Failing to do so may result in electric shock or personal injury.



CAUTION SIGNS FOR INSTALLATION

-  • Keep ventilation opening in the appliance enclosure or mounting structure clear of obstruction.
- Allow the appliance to stand for 2 hours after installation.



SEVERE WARNING SIGNS FOR USING

-  • Do not insert the power plug with wet hands.
- Do not store articles on the top of the appliance.
 - When you open or close the door, the articles may fall and cause personal injury and/or material damage.
- Do not put a container filled with water on the refrigerator.
 - If spilled, there is a risk of fire or electric shock.
- Do not let children hang on the door.
If not, a serious injury may occur.
- Do not let children enter inside of the refrigerator.
There is a risk of children entrapment.
- Never put fingers or other objects into the dispenser hole.
 - It may cause personal injury or material damage.
- Do not store volatile or flammable substances in the refrigerator.
 - The storage of benzene, thinner, alcohol, ether, LP gas and other such products

may cause explosions.

- Do not store pharmaceuticals products, scientific materials or temperature sensitive products in the refrigerator.
 - Products that require strict temperature controls must not be stored in the refrigerator.
- Do not place or use electrical appliance inside the refrigerator, unless they are of a type recommended by the manufacturer.
- Do not use mechanical devices or any other means to accelerate the defrosting process, other than those recommended by the manufacturer.
- Do not damage the refrigerant circuit.



- Do not disassemble or repair the refrigerator by yourself.
 - You run risk of causing a fire, malfunction and/or personal injury.



- Children should be supervised to ensure that they do not play with the appliance.

- Bottles should be stored tightly together so that they do not fall out.
- This product is intended only for the storage of food in a domestic environment.
- If a gas leak is detected, avoid any naked flames or potential sources of ignition and air the room in which the appliance is standing for several minutes.
- Use only the LED Lamps provided by manufacturer or service agents.



- If you smell pharmaceutical or smoke, pull out power plug immediately and contact your Samsung Electronics service center.
- If you experience difficulty when changing the light, contact service agents.
- If the products equipped with LED Lamp, do not disassemble Lamp Cover and LED Lamp by yourself.
- Please contact your service agents.



CAUTION SIGNS FOR USING



- To get Best performance of product,
 - Do not place foods too closely in front of the vents at the rear of the appliance as it can obstruct free air circulation in the refrigerator compartment.
 - Wrap the food up properly or place it in airtight containers before put it into the refrigerator.
- Fill water tank, ice tray, water cubes only with potable water.
- Do not apply strong shock or excessive force onto the surface of glass.
 - Broken glass may result in a personal injury and/or property damage.





- If the refrigerator is damaged by water, pull out the power plug and contact your Samsung Electronics service center.



CAUTION SIGNS FOR CLEANING

-  • Do not directly spray water inside or outside the refrigerator.
- There is a risk of fire or electric shock.
- Do not spray inflammable gas near the refrigerator.
- There is a risk of explosion or fire.
- Do not spray cleaning products directly on the display.
- Printed letters on the display may come off.

-  • Remove any foreign matter or dust from the power plug pins. But do not use a wet or damp cloth when cleaning the plug, remove any foreign material or dust from the power plug pins.
- Otherwise there is a risk of fire or electric shock.

-  • Unplug the refrigerator before cleaning and making repairs.



SEVERE WARNING SIGNS FOR DISPOSAL

-  • When disposing of this or other refrigerators, remove the door/door seals, door latch so that small children or animals cannot become trapped inside. Children should be supervised to ensure that they do not play with the appliance.
- Please dispose of the packaging material for this product in an environmentally friendly manner.
- Leave the shelves in place so that children may not easily climb inside. Ensure that none of the pipes on the back of the appliance are damaged prior to disposal.
- R-600a or R-134a is used as a refrigerant. Check the compressor label on the rear of the appliance or the rating label inside the refrigerator to see which refrigerant is used for your refrigerator.

When this product contains flammable gas (Refrigerant R-600a), contact your local authority in regard to safe disposal of this product. Cyclopentane is used as a insulation blowing gas. The gases in insulation material require special disposal procedure. Please contact your local authorities in regard to the environmentally safe disposal of this product.

Ensure that none of the pipes on the back of the appliances are damaged prior to disposal.

The pipes shall be broke in the open space.

- If the appliance contains iso-butane refrigerant (R-600a), a natural gas with high environmental compatibility that is, however, also combustible.

When transporting and installing the appliance, care should be taken to ensure that no parts of the refrigerating circuit are damaged.

- Refrigerant squirting out of the pipes could ignite or

cause an eye injury.

If a leak is detected, avoid any naked flames or potential sources of ignition and air the room in which the appliance is standing for several minutes.

- ☑ • In order to avoid the creation of a flammable gas-air mixture if a leak in the refrigerating circuit occurs, the size of the room in which the appliance may be sited depends on the amount of refrigerant used. Never start up an appliance showing any signs of damage. If in doubt, consult your dealer. The room must be 1 m³ in size for every 8 g of R-600a refrigerant inside the appliance. The amount of refrigerant in your particular appliance is shown on the identification plate inside the appliance.



ADDITIONAL TIPS FOR PROPER USAGE

- In the event of a power failure, call the local office of your Electricity Company and ask how long it is going to last.
- Most power failures that are corrected in an hour or two will not affect your refrigerator temperatures. However, you should minimize the number of door openings while the power is off.
- If the key is provided with refrigerator, the keys should be kept out of the reach of children and not in vicinity of the appliance.
- The appliance might not operate consistently (possibility of temperature becoming too warm in refrigerator) when sited for an extended period of time below the cold end of the range of temperatures for which the refrigerating appliance is designed.
- Do not store food which spoils easily at low temperature, such as

bananas, melons.

- Your appliance is frost free, which means there is no need to manually defrost your appliance, as this will be carried out automatically.
- The temperature of two star section (sections) or compartment (compartments) which have two star symbol (✱✱) is slightly higher than other freezer compartment (compartments). The two star section (sections) or compartment (compartments) is (are) based on the instruction and/ or the condition as delivered.

Saving Energy Tips

- Install the appliance in a cool, dry room with adequate ventilation. Ensure that it is not exposed to direct sunlight and never put it near a direct source of heat (radiator, for example).
- Never block any vents or grilles on the appliance.
- Allow warm food to cool

down before placing it in the appliance.

- Put frozen food in the refrigerator to thaw.
You can then use the low temperatures of the frozen products to cool food in the refrigerator.
- Do not keep the door of the appliance open for too long when putting food in or taking food out.
The shorter time for which the door is open, the less ice will form in the freezer.
- Clean the rear of the refrigerator regularly.
Dust increases energy consumption.
- Do not set temperature colder than necessary.
- Ensure sufficient air exhaust at the refrigerator base and at the back wall of the refrigerator.
Do not cover air vent openings.
- Allow clearance to the right, left, back and top when installing.
This will help reduce power consumption and keep your energy bills lower.
- For the most efficient use

of energy, please keep the all inner fittings such as baskets, drawers, shelves on the position supplied by manufacturer.

This appliance is intended to be used in household and similar applications such as

- staff kitchen areas in shops, offices and other working environments;
- farm houses and by clients in hotels, motels and other residential type environments;
- bed and breakfast type environments;
- catering and similar non-retail applications.

Setting up your refrigerator

GETTING READY TO INSTALL THE REFRIGERATOR

Congratulations on your purchase of this Samsung Refrigerator.

We hope you enjoy the state-of-art features and efficiencies that this new appliance offers.

- This refrigerator must be properly installed and located in accordance with the manual before it is used.
- Use this appliance only for its intended purpose as described in this instruction manual.
- We strongly recommend that any servicing be performed by a qualified individual.
- Please dispose of the packaging material for this product in an environmentally friendly manner.

- WARNING**  • Pull the power plug out of the socket before changing the interior light of the refrigerator.
- Otherwise, there is a risk of electric shock.

Selecting the best location for the refrigerator

- A location without direct exposure to sunlight.
- A location with flat floor surface.
- A location with enough space for the refrigerator door to open easily.
- Allow sufficient space to the right, left, back and top for air circulation. If the refrigerator does not have enough space, the internal cooling system may not work properly.
- Please ensure that appliance can be moved freely in the event of maintenance & service.

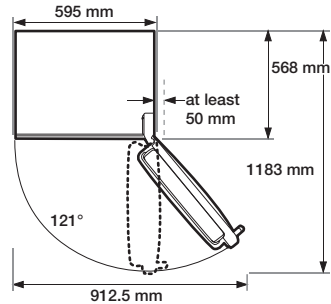
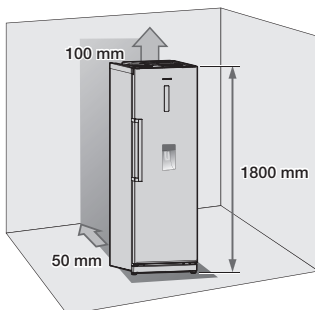

-  • Height of the product may be different depending on the models.
- Allow clearance to the right, left, back and top when installing. This will help reduce power consumption and keep your energy bills lower.
 - Do not install the refrigerator in a place with the temperature lower than 10 °C.

- CAUTION**  Pull the unit straight out when installing, servicing or cleaning behind the refrigerator and push it straight back after work is complete. Make sure your floor can support fully loaded refrigerator.

-  Remove paper on spacer and then attach two spacers (Gray block) on the back side of refrigerator for better performance. Make sure two spacers fix like below image when you install the refrigerator. It is improving the refrigerator performance.

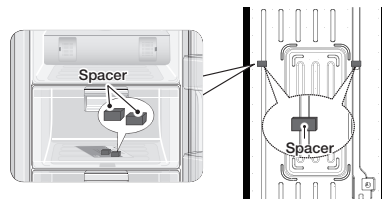

REVERSING THE REFRIGERATOR DOOR



Samsung recommends that reversing of the door opening is only completed by Samsung approved Service providers. This will be on a chargeable basis and at the customers expense.



Any damage caused while attempting to reverse the door opening is not covered under the appliance manufactures warranty. Any repairs requested due to this circumstance will be completed on a chargeable basis at the customers expense.

Required Tools (Not provided)

| | | |
|--------------------------------|---------------------------|--|
| | | |
| Phillips Head Driver (+) | Flat Head Driver (-) | 10 mm Socket Wrench (for bolts) |
| | | |
| 8 mm Socket Wrench (for bolts) | Spanner (for hinge shaft) | 5 mm Hex Wrench (for bottom hinge shaft) |

1. Remove 4 screws on the top of the refrigerator.

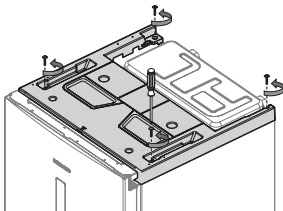

2. Remove the plastic cover and make sure to disconnect the wire connected to it. After removing the plastic cover, check the parts for reversing the door.

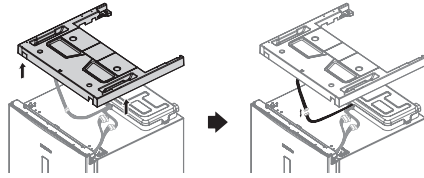

Be careful not to damage the electrical wires when removing the plastic cover.

3. Disconnect the wires and then remove 3 bolts.

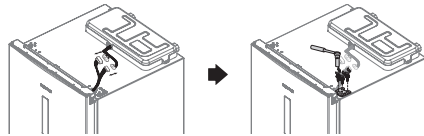

Make sure your refrigerator is unplugged before handling electrical wires.

4. Remove the door from the lower hinge by carefully lifting the door straight up.

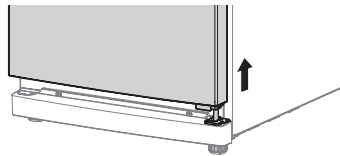

Refrigerator door is heavy, be careful not to injure yourself when removing the refrigerator door.

5. Separate the front leg cover after removing 2 screws.

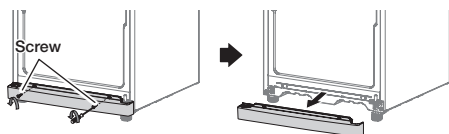

6. Unscrew 3 bolts tightening the hinge and also unscrew 3 bolts on the bottom left side by the front leg where removed hinge will be attached.

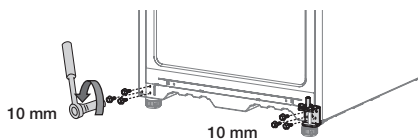

7. Separate the hinge shaft by using hex wrench first. Unscrew the bolt to remove the hinge riser and switch the side of the hinge shaft and the hinge riser.

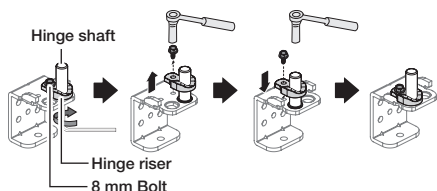

8. Attach the hinge on the bottom left side of the refrigerator where bolts were previously removed in step 6. Screw the bolts that were removed on the bottom right side of the refrigerator for the future usage. Switch the the Leg from the left to right.

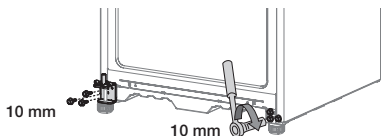

9. Remove the screws on the bottom left and right side of the refrigerator door. Switch the side of the door stopper from right to the left. Hinge riser should be switched as well.

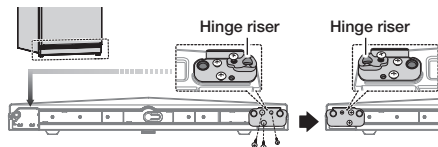

10. Remove the wire cover on top of the refrigerator door to switch the side of the wires.

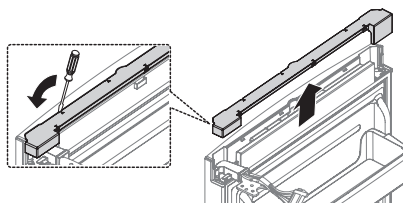

11. Remove the hinge and the grommet from the refrigerator door. Detach the right side hinge cover and pull the wires out of the hinge cover.

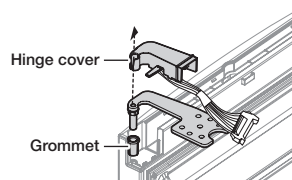

CAUTION Be careful not to damage the electrical wires when removing the hinge cover.

12. Use wrench to separate the hinge shaft and then flip the hinge and reattach the hinge shaft. And remove the shim at the top and attach it to the other side.

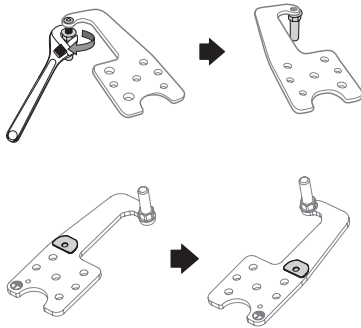

13. Reassemble the hinge on the refrigerator door by reversing the step 11. Make sure to use left side hinge cover (which can be found underneath the removed plastic cover from step 2) and remove the grommet. After reassembling the hinge, wire and the hinge cover, switch the side from right to the left.

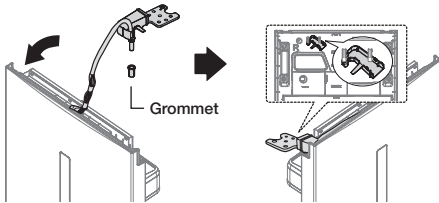

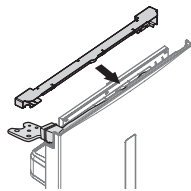

14. After switching the hinge, close it with the wire cover on the top of refrigerator door.

“Cover Wire Door R” can be found in the packaging

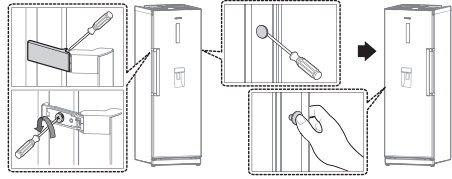

15. Take off the handle cover and remove the screws, make sure to detach the caps and the handle from the left to right side of the door. (Make sure to cover the left side with detached caps.)



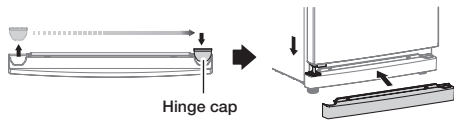

 Handles may not have cover depending on the models.

16. Switch the hinge cap and attach the front leg cover. Carefully put the refrigerator door back on.

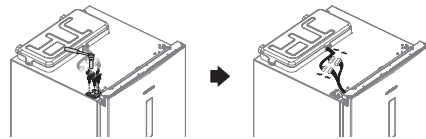

17. Tighten the 3 bolts and then connect the wires back together.



 **WARNING** Make sure your refrigerator is unplugged before handling electrical wires.

18. Connect the wire on the plastic cover and put the cover back to its original position.

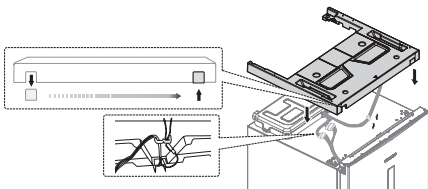

19. Tighten 4 screws back to its place.

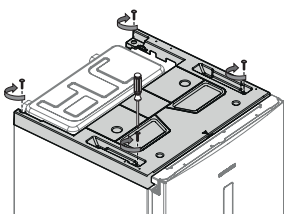

20. Detach the Fridge and the Freezer door gaskets and then attach them after rotating them 180°.

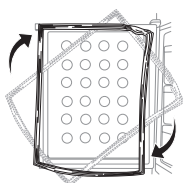

After reversing the doors, make sure the Fridge and Freezer door gaskets are properly arranged. If not, there might be a noise or dew formed which affects performance of the refrigerator.

LEVELLING THE REFRIGERATOR

If the front of the appliance is slightly higher than the rear, the door can be opened and closed more easily.

Turn the adjusting legs clockwise to raise and counter-clockwise to lower the height.

Case 1) The appliance tilts down to the left.

- Turn the left adjusting leg in the direction of the arrow until the appliance is level.

Case 2) The appliance tilts down to the right.

- Turn the right adjusting leg in the direction of the arrow until the appliance is level.

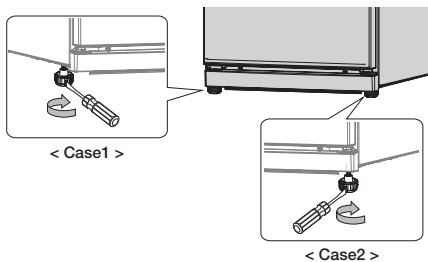

Operating your refrigerator

CHECKING THE CONTROL PANEL

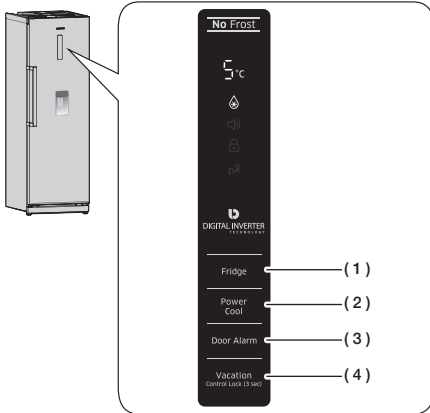

 Each time you press the button, a short beep will sound.

USING THE CONTROL PANEL

(1) Fridge

Press the Fridge button to set the desired temperature from the range between 1 °C and 7 °C.

Default set temperature is set on 3 °C and each time you press the button, temperature will change in following order and temperature indicator will display the desired temperature.

 °C

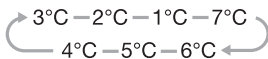

When the temperature setting is done, temperature indicator will display the current temperature of the refrigerator. If current temperature is higher than 9 °C, temperature indicator will be displayed as 9 °C.

(2) Power Cool

Press the Power Cool button to activate the Power Cool function.

Power Cool indicator will light up and the refrigerator will speed up the time to needed to cool products in the refrigerator. Power Cool function will operate for 2 hours and 30 minutes to quickly cool the refrigerator.

To deactivate the Power Cool function, press the Power Cool button again.



Power Cool function cannot be used together with Vacation function. Selecting Vacation function will automatically deactivate the Power Cool function.

(3) Door Alarm

1. Alarm

Press the Door Alarm button to activate the Alarm function. Alarm indicator will light up and the refrigerator will alert you with alarm sound if the refrigerator door is kept open for longer than 2 minutes.

To deactivate the Alarm function, press the Door Alarm button again.





2. Display Off

As standard, the temperature display is switched off, to switch between on and off mode, press Door Alarm button for 3 seconds.

(4) Vacation Control Lock (3 sec)

 Press the Vacation button to activate the Vacation function. Vacation indicator will light up and the refrigerator will set the temperature to 15 °C to minimize the power consumption while you are away (on vacation or business trip etc). Keep the refrigerator free from bacteria and odor.

 Press the Vacation button for 3 seconds to activate the child Lock function. Child lock indicator will light up and all the buttons on the control panel will be locked. To deactivate the Child Lock function, press the Vacation button again for 3 seconds.

-  • Vacation function will be automatically deactivated If you select Power Cool function or adjust temperature while Vacation function is on.
- Make sure to remove foods before using Vacation function.

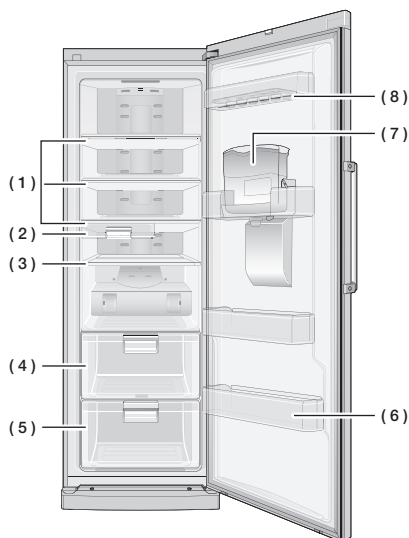

-  • Some of the features such as water tank and the beverage station can be different and may not be available depending on the model.
- To get more space, you can remove water (7) tank. It does not affect thermal and mechanical characteristics. A declared storage volume of refrigerator compartment is calculated with this part removed.

(1) Glass shelves

Shelves made out of glass are easy to clean and easy to see what is stored in the refrigerator. These shelves are designed to be crack-resistance and they can be used to store all types of food and drinks.

(2) Movable deli bin

A deli bin designed to be horizontally adjustable. You can move the bin left and right depends on the contents underneath. You can store beverages, dairy products or foods that need to be cooked soon.

(3) Foldable shelf

The shelf functions both a full depth shelf or can be tucked in to accommodate taller containers.

(4) Fresh drawer

Helps to preserve the taste of food and prolongs its freshness. Use to store bread and cake.

(5) Moisture control big box

You can use the moisture control big box to control the humidity for the fruits and vegetables to preserve its freshness.

(6) Deep door guard

Designed to handle large, bulky items such as gallons of milk or other large bottles and containers.

(7) Water tank

You can obtain chilled water in a water tank and get water from the water dispenser without opening the refrigerator.

(8) Egg tray

Best place to keep eggs. Place the Egg tray on the shelf to keep the eggs safely and access easily.



- If you plan to go away for a significant time, empty the refrigerator and turn it off. Wipe the excess moisture from the inside of the appliance and leave the door open. This helps keep odor and mold from developing.
- If the refrigerator is not to be used for a long period of time, pull out the power plug.

USING THE FOLDABLE SHELF

You can tuck in the foldable shelf if you need to accommodate taller containers or products on the shelf underneath.

1. Slightly lift up the shelf and slide it inward.
2. You can simply pull the tucked in shelf to use the fully extended shelf.

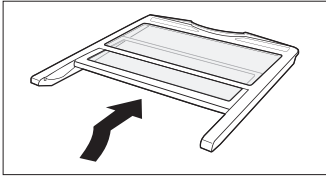

USING THE MOISTURE CONTROL BIG BOX

You can use the moisture control big box to control the humidity for the products which needs to be preserved its freshness.

Use the humidity control lever on the top of the drawer to adjust the humidity.
Move the lever to the right side to keep the humidity low within the drawer.
Move the lever to the left side to keep the humidity high. More holes will allow higher humidity within the drawer.

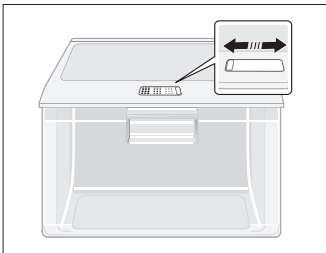

USING THE WATER DISPENSER

Filling the water

You can fill the water with the water tank sitting inside of the refrigerator or you can remove the water tank to fill the water.

Method 1

Fill the water through the hole on the top of the water tank.
If you pour the water too fast, water may overflow.



Method 2

1. Release the lock on the both side of the water tank to remove the lid on the water tank.
2. Fill the water in the water tank.

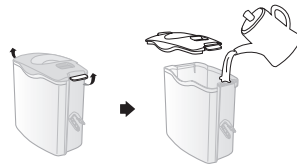

Do not put anything other than water in the water tank.

Getting water from the dispenser

Place a glass underneath the water outlet and push it gently against the water dispenser lever with your glass.

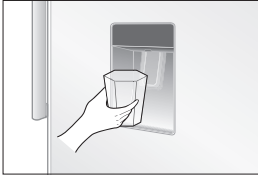

-  • Make sure the glass is in line with the dispenser to prevent the water from splashing out.
- Water dispenser may not be available depending on the model.

REMOVING THE INTERIOR PARTS

Moveable deli bin

Pull the deli bin out fully then slightly lift it up to remove it.

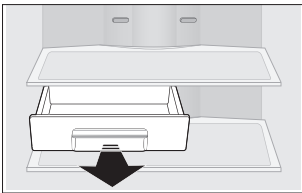

Shelves

Gently lift up the shelves with both hands and pull it toward you.
(Glass shelf/Foldable shelf)

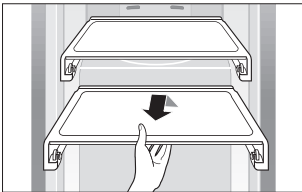

Drawers

Pull the drawers out fully then slightly lift it up to remove the drawers.
(Plastic drawer/Moisture control big box)

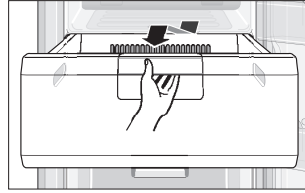

Door guards

Firmly grab the door guards with both hands and lift it up gently to remove the door guards.

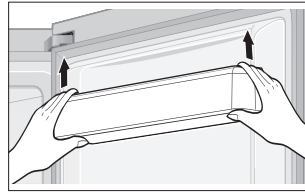

Water tank

Firmly grab the water tank with both hands and lift it up towards you gently to remove the water tanks.



-  Water tank may not be available depending on the model.

CLEANING THE REFRIGERATOR



WARNING Do not use Benzene, Thinner or Clorox™ for cleaning.

They may damage the surface of the appliance and can create a risk of fire.



CAUTION Do not spray the refrigerator with water while it is plugged in, as it may cause an electric shock.
Do not clean the refrigerator with benzene, thinner or car detergent for risk of fire.

REPLACING THE INTERIOR LIGHT



For LED lamp, please contact service engineer to replace it.

Troubleshooting

| PROBLEM | SOLUTION |
|---|--|
| The appliance is not operating at all or the temperature is too high. | <ul style="list-style-type: none"> • Check if the power plug is correctly connected. • Is the temperature control on the front panel correctly set? • Does sun shine on the appliance or are there any heat sources nearby? • Is the back of the appliance too close to the wall? |
| There are unusual noises. | <ul style="list-style-type: none"> • Check if the appliance is installed on a stable and even floor. • Is the back of the appliance too close to the wall? • Have any foreign objects fallen behind or under the appliance? • Is the noise coming from the compressor in the appliance? • A ticking sound may be heard inside the appliance; this is normal. This sound occurs when the various accessories contract or expand. |
| The front corners and sides of the appliance are warm and condensation starts to form. | <ul style="list-style-type: none"> • Heat-proof pipes are installed in the front corners of the appliance to prevent condensation from forming. When the surrounding temperature rises, this may not always be effective. However, this is not abnormal. • In very humid weather, condensation may form on the outer surface of the appliance when the moisture in the air comes into contact with the cool surface of the appliance. |
| You can hear a liquid bubbling in the appliance. | <ul style="list-style-type: none"> • This is the refrigerant, which cools the inside of the appliance. |
| There is a bad smell inside the appliance. | <ul style="list-style-type: none"> • Is there any spoiled food inside of the refrigerator? • Make sure that strong smelling food (for example, fish) is wrapped so that it is airtight. • Clean out your refrigerator periodically and throw away any spoiled or suspect food. |
| There is a layer of frost on the appliances walls. | <ul style="list-style-type: none"> • Are the air outlet vents blocked by food stored inside the refrigerator? • Space the food out as much as possible to improve ventilation. • Is the door fully closed? |
| Condensation forms on the inside wall of the appliance and around vegetables. | <ul style="list-style-type: none"> • Food with a high water content is stored uncovered with a high humidity level or the door has been left open for a long time. • Store the food with a cover or in sealed containers. |

Installation Part



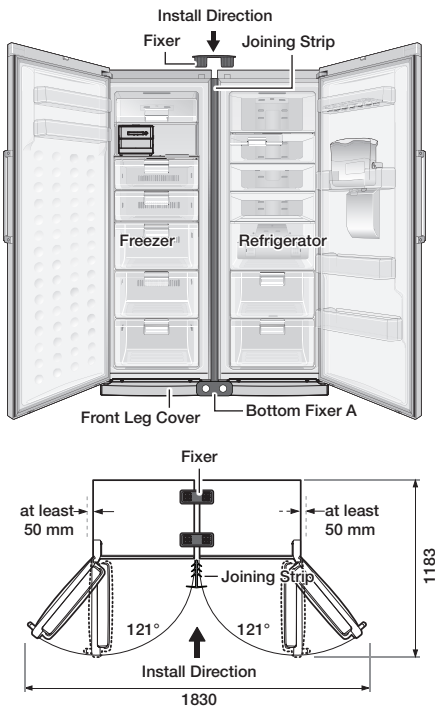

Installing the products together

Side by Side combination possible with Samsung Models starting with RZ**, RR**.
Please ask the shop for detail such as Color and Design.
For Side by Side arrangement, please make sure followings.

- Recommend to place the Fridge on the Right for best performance.
- For perfect finish, allow the following clearance and install SPACERS in installation Kit provided. (Only available on some models)
- Make the height of the refrigerator and the freezer same with referring the 16 page.



Required Tools

| | | | |
|---|---|---|---|
|  |  |  |  |
| Fixer | Joining Strip | Bottom Fixer A, B | Screws |

How to install the product

Make sure to turn off the power for both of the products.

1. Keep the distance between the refrigerator and the freezer about 5~7 mm.
2. Remove the front leg cover on both refrigerator and the freezer by removing the screws.

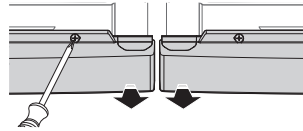

3. Remove the screw from the each of the product and attach them back after putting the bottom fixer.

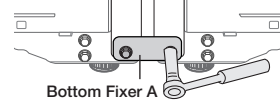

4. Insert the joining strip in between the refrigerator and the freezer.

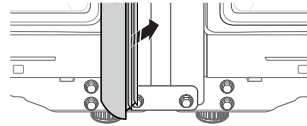

5. Insert two fixers firmly on the top of the products.

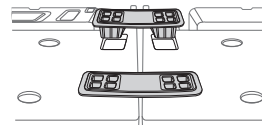

6. Place the front leg cover back on both of the products.

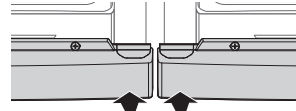

7. Join the bottom fixer B with screws at back of the products.

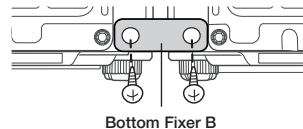

Circuit diagram

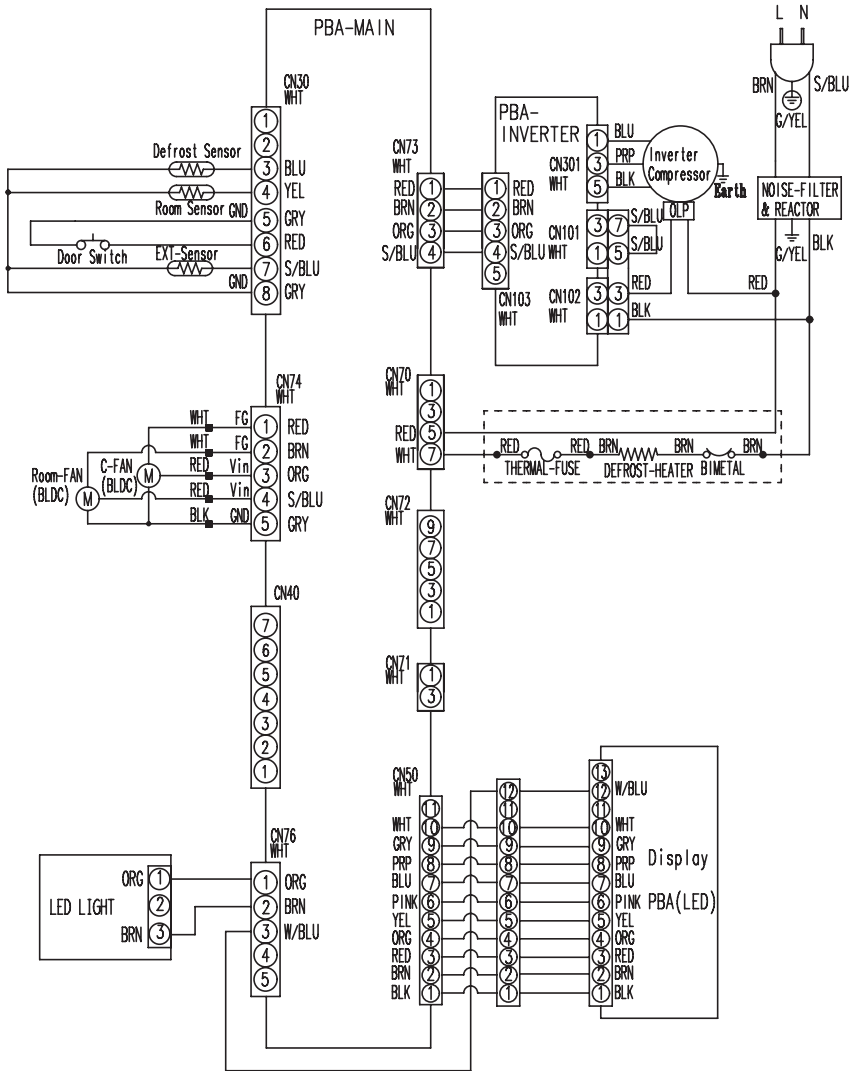

Memo

Memo

Ambient Room Temperature Limits

This refrigerator is designed to operate in ambient temperatures specified by its temperature class marked on the rating plate.

| Class | Symbol | Ambient Temperature range (°C) | |
|--------------------|--------|--------------------------------|------------|
| | | IEC 62552 (ISO 15502) | ISO 8561 |
| Extended Temperate | SN | +10 to +32 | +10 to +32 |
| Temperate | N | +16 to +32 | +16 to +32 |
| Subtropical | ST | +16 to +38 | +18 to +38 |
| Tropical | T | +16 to +43 | +18 to +43 |



Internal temperatures may be affected by such factors as the location of the refrigerator, ambient temperature and the frequency with which you open the door.

Adjust the temperature as required to compensate for these factors.

**Correct Disposal of This Product
(Waste Electrical & Electronic Equipment)**

English *(Applicable in countries with separate collection systems)*



This marking on the product, accessories or literature indicates that the product and its electronic accessories (e.g. charger, headset, USB cable) should not be disposed of with other household waste at the end of their working life. To prevent possible harm to the environment or human health from uncontrolled waste disposal, please separate these items from other types of waste and recycle them responsibly to promote the sustainable reuse of material resources.

Household users should contact either the retailer where they purchased this product, or their local government office, for details of where and how they can take these items for environmentally safe recycling.

Business users should contact their supplier and check the terms and conditions of the purchase contract. This product and its electronic accessories should not be mixed with other commercial wastes for disposal.

Contact SAMSUNG WORLD WIDE

If you have any questions or comments relating to Samsung products, please contact the SAMSUNG customer care center.

| COUNTRY | CALL | Web site |
|--------------|---|--|
| AUSTRIA | 0800-SAMSUNG (0800-7267864) [Only for Premium HA] 0800-366661 [Only for Dealers] 0810-112233 | www.samsung.com/at/support |
| COLOMBIA | Bogotá 600 12 72 Gratis desde cualquier parte del país 01 8000 112 112 ó desde su celular #SAM(726) | www.samsung.com/co/support |
| EIRE | 0818 717100 | www.samsung.com/ie/support |
| HONG KONG | (852) 3698-4698 | www.samsung.com/hk/support (Chinese) www.samsung.com/hk_en/support (English) |
| INDIA | 1800 3000 8282 - Toll Free 1800 266 8282 - Toll Free | www.samsung.com/in/support |
| MALAYSIA | 1800-88-9999 603-77137477 (Overseas contact) | www.samsung.com/my/support |
| NEW ZEALAND | 0800 726 786 | www.samsung.com/nz/support |
| PANAMA | 800-7267 800-0101 | www.samsung.com/latin/support (Spanish) www.samsung.com/latin_en/support (English) |
| PHILIPPINES | 1-800-10-7267864 [PLDT] 1-800-8-7267864 [Globe landline and Mobile] 02-4222111 [Other landline] | www.samsung.com/ph/support |
| SINGAPORE | 1800-SAMSUNG(726-7864) | www.samsung.com/sg/support |
| SOUTH AFRICA | 0860 SAMSUNG (726 7864) | www.samsung.com/support |
| UK | 0330 SAMSUNG (7267864) | www.samsung.com/uk/support |



DA68-03008C-04