

# **TOSHIBA**

Leading Innovation >>>

## **OWNERS MANUAL**

LCD DISPLAY

TD-E653 - TD-E653E

For information on warranties and service please visit [www.toshiba.eu/services](http://www.toshiba.eu/services)

## Contents

Important Safety Information .....	2
Vesa Wall Mount Measurements .....	7
When Using a Wall Bracket .....	7
Connecting to external equipment .....	7
Control Buttons on the Display .....	8
Turning the Display On/Off .....	9
Remote Control .....	10
First Time Installation .....	11
Media Playback via USB Input .....	11
CEC and CEC RC Passthrough .....	12
Display Menu Contents .....	13
Connectivity .....	18
Internet Browser .....	20
Internal USB Operations (*) .....	21
OSD Rotation Support (*) .....	21
DisplayPort .....	21
Controlling With An External PC .....	22
System Features .....	23
Notification .....	25
Trouble Shooting & Tips .....	26



## Important Safety Information



### CAUTION

RISK OF ELECTRIC SHOCK  
DO NOT OPEN



**CAUTION:** TO REDUCE THE RISK OF ELECTRIC SHOCK DO NOT REMOVE COVER (OR BACK). NO USER-SERVICEABLE PARTS INSIDE. REFER SERVICING TO QUALIFIED SERVICE PERSONNEL.

### Please read these instructions fully and carefully before use and keep for future reference

**WARNING:** This device is intended to be used by persons (including children) who are capable / experienced of operating such a device unsupervised, unless they have been given supervision or instruction concerning the use of the device by a person responsible for their safety.

- This product is for indoor use only.
- Use this product at an altitude of less than 2000 meters above the sea level and in dry locations and in regions with moderate or tropical climates.
- Please keep this manual for further use.
- Unplug your product before starting to clean. Do not clean the product when it is on. Do not use liquid or aerosol cleaners. Use a damp cloth for cleaning. If that does not help, please use LCD display cleansers. Do not apply the cleaner directly on the product.
- To prevent breakdown, do not use non-advised accessories.
- Please do not place your product near wash basins, sinks, water pans, pools etc.
- Do not expose the product to dripping or splashing of liquids and do not place objects filled with liquids, such as vases, cups, etc. on or over the product (e.g., on shelves above the unit).
- Please leave at least 5 cm of free space between the product and walls or other furnitures for ventilation purposes.
- That product can only be started by the defined power source on its rating plate. For further information, please contact with your dealer.
- As a safety precaution, a three-wired grounding plug is given with the product. Please do not make any change on the grounding plug. Always use earthed socket outlet for product.
- Please provide the correct power supply socket to power the appliance.

- Please place the product in a position that electric cables cannot be affected by the operations on the product.
- Follow all warnings and instructions marked on the product.
- Follow the on screen instructions for operating the related features.
- To prevent the risk of fire or electric shock, please do not overuse the plugs and extension cords. Do not remove the back cover. If service is required contact the authorized service centre.
- If you will not use the product for a long period of time, unplug the power cord from the mains.
- Put the product on a well-ventilated place and prevent from bright light, overheat and damp.
- The product should be kept in 0 C° - 40 C°. Otherwise, the appliance may be damaged permanently.
- Plug the appliance to a grounded outlet. Always use the grounded power cord supplied with your product. Manufacturer is not responsible for any damage caused unearthed usage.
- The socket-outlet shall be installed near the equipment and shall be easily accessible.
- Do not stay in contact with the parts of the product that become hot for long periods of time. Doing so may result in low-temperature burns.
- The LCD panel used in this product is made of glass. Therefore, it can break when the product is dropped or applied with impact. Be careful not to be injured by broken glass pieces in case the LCD panel breaks.
- Usage of the monitor must not be accompanied by fatal risks or dangers that, could lead directly to death, personal injury, severe physical damage or other loss, including nuclear reaction control in nuclear facility, medical life support system, and missile launch control in a weapon system.
- Do not expose the product to direct sunlight or do not place open flames such as lit candles on the top of or near the product.
- Do not place any heat sources such as electric heaters, radiators, etc. near the product.
- In order to prevent a potential electrical shock, in extreme weather (storms, lightning) disconnect the product from the mains.
- Do not touch the controls other than those described in the operating instructions. Improper adjustment of controls not described in the instructions can cause damage, which often requires extensive adjustment work by a qualified technician.
- Do not shake the product. Ensure that it stays in a balanced stance on its position.
- Do not throw or drop any object on your product.

- Do not interfere on your products screen or any other surface with a sharp object.
- Do not keep your product in a humid environment.
- Do not keep your product in an extremely cold environment.
- Do not keep your product in an extremely hot environment.
- Do not place the product on the floor and inclined surfaces.
- To avoid danger of suffocation, keep plastic bags out of the reach of the babies, children and domestic animals.

### **Vent holes of the product**

The vent holes are designed to provide the product to work constantly and prevent it from overheat. Do not block these openings in anyway. For the same reason, please do not place your product on beds, sofas, carpets and similar surfaces.

Never insert an object into the product through vents or openings. High voltage flows in the product, and inserting any objects in the vents or openings of the product may cause electric shock, short circuit of the internal parts and/or fire. For the same reason, do not spill water or liquid on the product.

### **Repair**

Unless a basic implementation on the product is specified by the producers' technical department on a document, do not repair your product by yourself. Otherwise, your guarantee may get suspended and you may risk your health or your product. In case of need, consult your authorized service.

- When the cable is worn off or harmed.
- If the product has been dropped or the cabinet has been damaged.
- If the performance of the product is changed or the appliance needs to be repaired.
- When a liquid was spilled on the product or when objects have fallen into the product.
- When the product has been exposed to rain or water.
- When the product does not operate properly as described in the operating instructions.

### **Replacement parts**

In case the product needs replacement parts, make sure that the service person uses replacement parts specified by the manufacturer, or those with the same characteristics and performance as the original parts. Use of unauthorized parts can result in fire, electric shock and/or other danger.

### **Safety checks**

Upon completion of service or repair work, request the service technician to perform safety checks to ensure that the product is in proper operating condition.

### **Wall mounting**

When mounting the product on a wall, be sure to install the product according to the method recommended by the manufacturer.

- Read the instructions before mounting the product on the wall.
- The wall mount kit is optional. You can obtain from your local dealer, if not supplied with the product.
- Do not install the product on a ceiling or on an inclined wall.
- Use the specified wall mounting screws and other accessories.
- Tighten the wall mounting screws firmly to prevent the product from fall. Do not over-tighten the screws.

### **Power Cord**

- The power cord is used to disconnect the product from the mains and therefore it must remain readily operable. If the product is not disconnected electrically from the mains, the device will still draw power for all situations even if the product is in standby mode or switched off.
- Use only the power cord supplied with the monitor.
- Do not damage the power cord nor place heavy objects on it, stretch it, over bend it or step on it. Also, do not add extension cords. Damage to the cord may result in fire or electric shock.
- When unplugging the appliance, always pull directly on the plug. Do not pull from the cable when unplugging the appliance.
- Do not use the power cord with a power tap. Adding an extension cord may lead to fire as a result of overheating.
- Do not remove or insert the power plug with wet hands. Doing so could result in electric shock.
- Unplug the power cord if it is not used for a long time.
- Do not attempt to repair the power cord if it is broken or malfunctioning. When damaged it must be replaced, this should only be done by qualified personnel.

### **Especially for child safety**

- Don't allow children to climb on or play with the monitor.
- Don't place the monitor above furniture that can easily be used as steps.
- Remember that children can become excited while watching a program, especially on a "larger than life" monitor. Care should be taken to place or install the

monitor where it cannot be pushed, pulled over, or knocked down.

- Care should be taken to route all cords and cables connected to the monitor so that they cannot be pulled or grabbed by curious children.

### Connections

 Be sure to turn off the main power switch and disconnect the plug from the power outlet before connecting/disconnecting cables. Also, read the manual of the equipment to be connected.

Be careful not to confuse the input terminal with the output terminal when connecting cables. Accidentally reversing cables connected to the input and output terminals may cause malfunctions and other problems.

### Positioning

If a monitor is positioned in an unstable or inclined location, it can be potentially hazardous due to falling. Many injuries, particularly to children, can be avoided by taking simple pre-cautions such as:

- Using fixing devices like wall mount brackets recommended or supplied by the manufacturer.
- Educating children about the dangers of climbing on furniture to reach the monitor or its controls. If your existing product is being retained and relocated, the same considerations as above should be applied

### Transport and Shipping

- Your device must be kept in its original package to protect from damage to its accessories during transport and shipping.
- Keep the product in normal position during transport.
- Do not drop the device during transport and protect it against impacts.
- Damages and faults that occur during transport after the delivery of the appliance to the customer are not included in the warranty cover.
- Product transportation, installation, repair and servicing must be done by qualified technical service personnel.

### Intended Use

- This product is intended to be used in public places such as schools, offices, theatres, places of worship but are also suitable for household and similar general use.
- Product is only suitable for connecting commercial mains socket outlets. Do not connect product industrial socket outlets.

### Foreseeable misuse and incorrect use

- For apparatus intended to be used in vehicles, ships or aircraft or at altitudes exceeding 2000m above sea level, for outdoor use or in general for the application

other than mentioned in user manual additional requirements may be necessary.



**CAUTION**



Do not leave a static image displayed for prolonged period of time. If a static image is displayed continuously for a long period of time, that image may cause image sticking on the display. This condition is not permanent, but may require a considerable amount of operational display time to dissipate, depending upon the degree of image stick. 120 minutes of continuous motion display will eliminate most image sticking effects at normal room temperature (not lower than 10 C).

As the nature of the TFT technology, you may see some amount of bright, dark, red, green and blue dots and sparklings on the screen, those do not affect the performance of the computer and are not accepted as a defect.

### Warning

This product is defined as Class A and is intended for commercial/industrial use.

### BATTERY SAFETY GUIDELINES

Used correctly, domestic batteries are a safe and dependable source of portable power. Problems can occur if they are misused or abused resulting in leakage or, in extreme cases, fire or explosion.

Here are some simple guidelines to safe battery use designed to eliminate any such problems.

- Take care to fit your batteries correctly, observing the plus and minus marks on the battery and appliance. Incorrect fitting can cause leakage or, in extreme cases, fire or even an explosion.
- Replace the whole set of batteries at one time, taking care not to mix old and new batteries or batteries of different types, since this can result in leakage or, in extreme cases, fire or even an explosion.
- Store unused batteries in their packaging and away from metal objects which may cause a short-circuit resulting in leakage or, in extreme cases, fire or even an explosion.
- Remove dead batteries from equipment and all batteries from equipment you know you are not going to use for a long time. Otherwise the batteries may leak and cause damage.
- Batteries must not be exposed to excessive heat such as sunshine, fire or the like.

- Never dispose of batteries in fire or with hazardous or flammable materials as this can cause them to explode. Please recycle dead batteries; do not put with the normal household waste.
- Never attempt to recharge ordinary batteries, either in a charger or by applying heat to them. They may leak, cause fire or even explode. There are special rechargeable batteries which are clearly marked as such.
- Supervise children if they are replacing batteries themselves in order to ensure these guidelines are followed.
- Do not ingest the battery, Chemical Burn Hazard.
- This product or the accessories supplied with the product may contain a coin/button cell battery. If the coin/button cell battery is swallowed, it can cause severe internal burns in just 2 hours and can lead to death.
- Remember that small button cell batteries such as used in some hearing aids, toys, games and other appliances, are easily swallowed by young children and this can be dangerous.
- Keep new and used batteries away from children.
- Make sure battery compartments are secure. If the battery compartment does not close securely, stop using the product and keep it away from children.
- Seek immediate medical attention if you believe batteries might have been swallowed or placed inside any part of the body.
- If leaked battery fluid gets on your skin or clothing, rinse immediately and thoroughly. If it gets into your eye, bathe your eye well rather than rubbing and seek medical treatment immediately. Leaked battery fluid that gets into your eye or your clothing may cause a skin irritation or damage your eye.

### CAUTION

RISK OF EXPLOSION IF BATTERY IS REPLACED BY AN INCORRECT TYPE. DISPOSE OF USED BATTERIES ACCORDING TO THE INSTRUCTIONS.

### Markings on the Product

The following symbols are used **on the product** as a marker for restrictions and precautions and safety instructions. Each explanation shall be considered where the product bears related marking only. Note such information for security reasons.



**Class II Equipment:** This appliance is designed in such a way that it does not require a safety connection to electrical earth.



**Class II Equipment With Functional Earthing:** This appliance is designed in such a way that it does not require a safety

connection to electrical earth, the earth connection is used for functional purposes.



**Protective Earth Connection:** The marked terminal is intended for connection of the protective earthing conductor associated with the supply wiring.



**Hazardous Live Terminal:** The marked terminal(s) is/are hazardous live under normal operating conditions.



**Caution, See Operating Instructions:** The marked area(s) contain(s) user replaceable coin or button cell batteries.

*Any issues which are caused by customer mis-adjustment of any software including the operating system are not covered by the warranty.*

*Depending on the model you buy, the actual appearance of the product may differ from the images used in this manual.*

*ABOVE ALL - NEVER let anyone, especially children, push or hit the screen, push anything into holes, slots or any other openings in the case.*

*WARNING - Excessive sound pressure from earphones or headphones can cause hearing loss.*

Using the special functions to change the size of the displayed image (i.e. changing the height / width ratio) for the purposes display or commercial gain may infringe on copyright laws.

### Exclusion Clause

Toshiba shall under no circumstances be liable for loss and/or damage to the product caused by:

- fire;
- earthquake;
- accidental damage;
- intentional misuse of the product;
- use of the product in improper conditions;
- loss and/or damage caused to the product whilst in the possession of a third party;
- any damage or loss caused as a result of the owner's failure and/or neglect to follow the instructions set out in the owner's manual;
- Any loss or damage caused directly as a result of misuse or malfunction of the product when used simultaneously with associated equipment;

Furthermore, under no circumstances shall Toshiba be liable for any consequential loss and/or damage including

but not limited to the following, loss of profit, interruption of business, the loss of recorded data whether caused during normal operation or misuse of the product.

### **UK Power Cord Warning**

In UK, use BS-approved power cord with molded plug having a black (10A) fuse installed for use with this monitor.

### **Children Warning**

**CAUTION** : Do not let children swallow any small parts included on or with the product or play the plastic bag. Keep the small parts and the plastic bag out of the reach of children.

### **Additional Safety Precautions**

**CAUTION** : If the monitor is dropped and the cabinet or enclosure surface has been damaged or the monitor does not operate normally, take the following precautions.

- **ALWAYS** turn off the monitor and unplug the power cord to avoid possible electric shock or fire.
- **NEVER** allow your body to come in contact with any broken glass or liquid from the damaged monitor. The LCD panel inside the monitor contains glass and a toxic liquid. If the liquid comes in contact with your mouth or eyes, or your skin is cut by broken glass, rinse the affected area thoroughly with water and contact your doctor immediately.
- **ALWAYS** contact a service technician to inspect the monitor any time it has been damaged or dropped.

## Vesa Wall Mount Measurements

Hole Pattern Sizes (mm)	W	H
	400	400
Screw Sizes		
Length (X)	min. (mm)	7
	max. (mm)	21
Thread (Y)	M6	

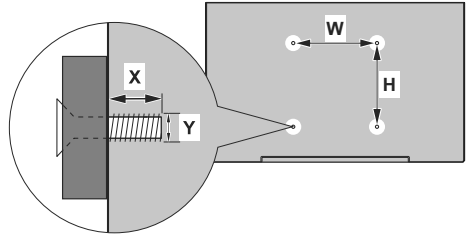

## When Using a Wall Bracket

Please use a wall bracket appropriate for the size and weight of the LCD display and two people are required for the installation.

- (1) Unplug and remove any cables and/or other component connectors from the rear of the LCD display.
- (2) Carefully lay the front of the unit face down on a flat, cushioned surface such as a quilt or blanket.
- (3) Follow the instructions provided with your wall bracket. Before proceeding, make sure the appropriate bracket(s) are attached to the wall and the back of the display as described in the instructions provided with the wall bracket.

Do not install the product on a ceiling or inclined Wall.

## Connecting to external equipment

### Rear Side (1)

1. VGA
2. Serial Communication Port
3. DVI
4. Display Port Input
5. Display Port Output
6. HDMI 1
7. Headphone
8. USB (2.0)
9. USB (3.0)
10. IR Input (IR receiver / LED cable supplied)
11. OPS Slot
12. Internal USB. 8Gb device supplied (dependent on model)
13. AC Power Switch
14. AC Inlet

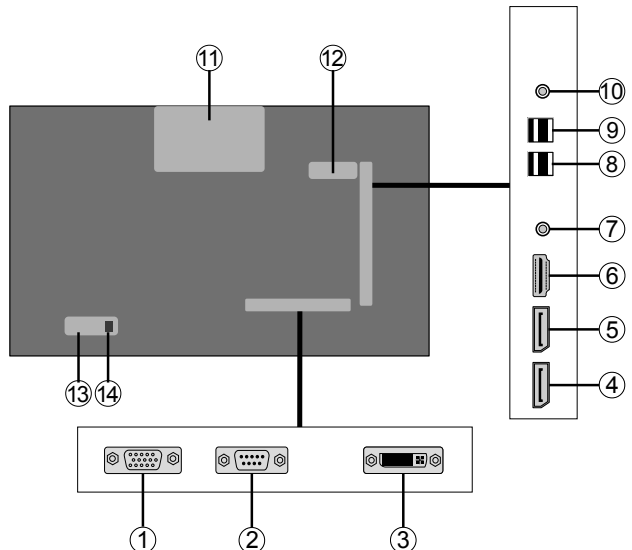



## Rear Side (2)

1. Audio Out
2. Audio In
3. Ethernet
4. RJ12 (service use only)
5. Video In
6. YPbPr
7. SPDIF Coaxial Out

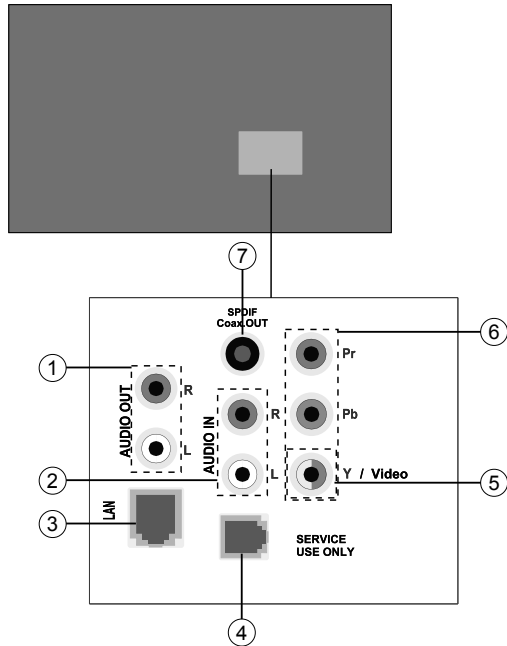

## Control Buttons on the Display

**To turn on the Display:** Press the centre of the joystick in, the Display will turn on.

**To turn the Display off:** Press the centre of the joystick in and hold it down for a few seconds, the Display will turn into standby mode.

**To change source:** Press the centre of the joystick in, the sources list will appear on the screen. Scroll through the available sources by pushing the joystick up or down.

**To change volume:** Increase the volume by pushing the joystick right. Decrease the volume by pushing the joystick left.

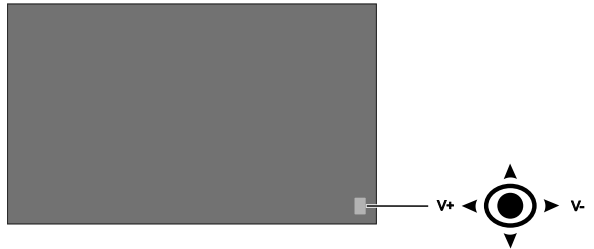

**Note:** Main menu OSD cannot be displayed via joystick.

## Connecting the IR Receiver

Before plugging the Display into the mains supply, connect the supplied IR receiver to the IR input on the Display. Place the IR receiver in sight of your own remote control. Simply operate your remote control whilst pointed at the IR receiver and it will relay the control signal to your Display.

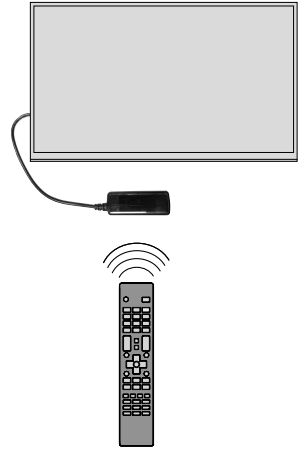

## Turning the Display On/Off

Press the **Standby** button on the remote or press the centre of the joystick in located on rear left side of the Display to switch it on from standby . Press the centre of the joystick in and hold it down for a few seconds or press the Standby button on the remote to switch display into standby mode.

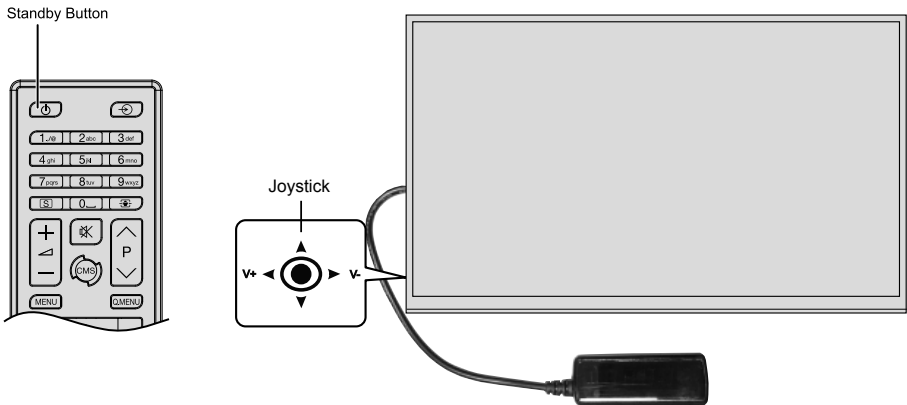

LED Status	Status of the monitor
Power led not lit	Power on
Power led lit	Power off (Standby mode)
Power led flashing (Slow)	Scheduler active
Power LED flashing (Fast)	Power up / down and Sw update

## Remote Control

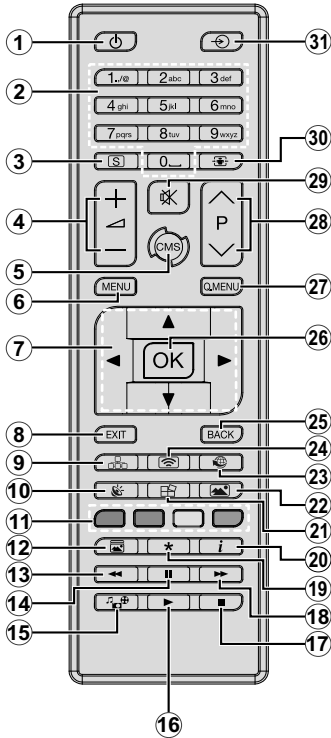

## Inserting the Batteries into the Remote

Remove the screw that secure the battery compartment cover on the back side of the remote control first. Lift the cover gently. Insert two **AAA** batteries. Make sure the (+) and (-) signs match (observe correct polarity). Place the cover back on. Then screw the cover back on again.

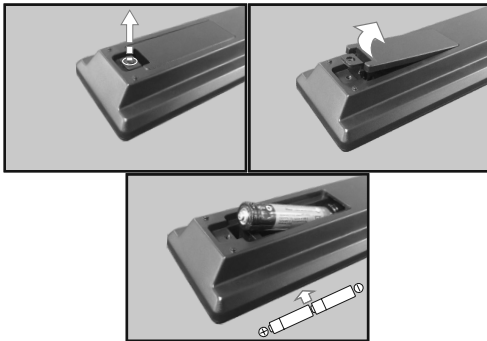

- Standby:** Switches On / Off the Display
- Numeric buttons:** Enters a number or a letter in the text box on the screen.
- Signage:** Displays Signage Settings menu
- Volume +/-:** Increases or decreases the volume
- CMS:** Opens the predefined Start url (in Signage Settings>Link options menu). Press and hold 3 seconds to open the predefined Settings url (in Signage Settings>Link options menu).
- Menu:** Displays the main menu
- Directional buttons:** Helps navigate menus, content etc.
- Exit:** Closes and exits from displayed menus or returns to previous screen
- Network:** Displays Network/Internet Settings menu
- Sound:** Displays Sound Settings menu
- Coloured Buttons:** Follow the on-screen instructions for coloured button functions
- Picture Mode:** Cycles between picture modes
- Rapid reverse:** Moves frames backwards in media such as movies
- Pause:** Pauses the media being played
- Media browser:** Opens the media browsing screen
- Play:** Starts to play selected media
- Stop:** Stops the media being played
- Rapid advance:** Moves frames forward in media such as movies
- No function
- Info:** Displays information about on-screen content
- Video Wall:** Displays Video Wall Settings menu
- Picture:** Displays Picture Settings menu
- Internet:** Opens the predefined Open browser initial page (in Signage Settings>Link options menu).
- Wireless Display:** Opens the wireless display connection screen
- Back/Return:** Returns to previous screen
- OK:** Confirms user selections
- Quick Menu:** Displays a list of menus for quick access
- No function
- Mute:** Completely turns off the volume of the Display
- Screen:** Changes the aspect ratio of the screen
- Source:** Shows all available content sources

## First Time Installation

When turned on for the first time, the language selection screen will be displayed. Select the desired language and press **OK**.

On the next screen, set your country preference and press **OK** to continue.

You will be asked to set and confirm a PIN at this point. For some **Country** options, the PIN cannot be set to **0000**, in this case you need to enter another 4-digit number combination.

The **Signage Settings** menu will be displayed next. **Set ID, OSD Orientation, Auto software update** options can be configured using this menu. **Model name, Serial number** and **Software version** options are for information only. They will be grayed out and not selectable. **Please note this information as it will be required if contacting Toshiba regarding your monitor** refer to the **Signage Settings Menu Contents** section for more information on the options of this menu. While this menu is displayed on the screen you can copy database files from a connected USB device to the Display by pressing the **Yellow** button. You can also save the model information data of the Display to a connected USB device by pressing the **Blue** button. After the settings are completed, press **OK** to continue.

On the next screen, the **Network/Internet Settings** menu will be displayed. Please refer to **Connectivity** section to configure a wired or a wireless connection. After the settings are completed press **OK** button to continue.

The **First Time Installation** is completed.

To repeat this process and reset the Display's settings to the factory defaults enter the **Signage Settings** menu, highlight **First time installation** and press **OK**. You will be asked to enter the PIN that you have defined in the **First Time Installation**. If the correct PIN is entered a confirmation message will be displayed asking whether you want to delete all settings and reset the Display. Select **Yes** and press **OK** to confirm.

**Note:** Do not turn off the Display while initializing first time installation. Note that, some options may not be available depending on the country selection.

## Media Playback via USB Input

If internal USB device is inserted and external device is also inserted, media player will use the external device only. You can connect 2.5" and 3.5" inch (hdd with external power supply) external hard disk drives or USB memory stick to your Display by using the USB input/s of the Display.

**IMPORTANT!** Back up the files on your storage devices before connecting them to the Display. Manufacturer will not be responsible for any file damage or data loss. Certain types of USB devices (e.g. MP3 Players) or USB hard disk drives/memory

sticks may not be compatible with this Display. The Display supports FAT32 and NTFS disk formatting.

Wait a little while before each plugging and unplugging as the player may still be reading files. Failure to do so may cause physical damage to the USB player and the USB device itself. Do not pull out your drive while playing a file.





You can use USB hubs with your Display's USB input/s. External power supplied USB hubs are recommended in such a case.

It is recommended to use the Display's USB input/s directly, if you are going to connect a USB hard disk.

**Note:** When viewing image files the **Media Browser** menu can only display 1000 image files stored on the connected USB device.

## Media Browser Menu

You can play photo, music and movie files stored on a USB disk by connecting it to your Display. Connect a USB disk to one of the USB inputs located on the side of the Display. Pressing the **Menu** button while in the **Media Browser** mode will access the **Picture, Sound** and **Settings** menu options. Pressing the **Menu** button again will exit from this screen. You can set your **Media Browser** preferences by using the **Settings** menu.

Loop/Shuffle Mode Operation	
Start playback with the <b>Play</b> button and activate 	All files in the list will be continuously played in original order
Start playback with the <b>OK</b> button and activate 	The same file will be played continuously (repeat)
Start playback with the <b>Play</b> button and activate 	All files in the list will be played once in random order
Start playback with the <b>Play</b> button and activate  	All files in the list will be continuously played in the same random order.

## USB Auto Play Feature

**Note:** USB autoplay function will only operate from AC cycle or if Quick standby is disabled".

USB AutoPlay feature is to start playing the media content in removable device, automatically. It uses the **Media Browser**. The media content types have different priorities in order to be played. The reducing priority order is as Photo, Video and Audio. That means, if there is Photo content in the root directory of the removable device, MediaBrowser will play the Photos in a sequence (in file name order) instead of Video or Audio files. If not, it will be checked for Video content and as last Audio.

But if the user presses the **Exit** button to go out from **Media Browser**, Display will go back to the previous source and will display the content.

This feature will only work if all of the following circumstances occur:

- The USB device is plugged in.
- **Auto Play** option is enabled. It is placed in the **Media Browser>Settings** menu.

### Failover Feature

If No Signal option in the Signage Settings menu is set as Failover the TV checks the connected USB device for available files to play. If no playable files are available or there is no USB device connected to the Display, the No Signal image will be displayed and the Display will turn itself off after a period of 5 minutes. If there isn't any No Signal Image available, No Signal OSD will be displayed on the screen and the Display will turn itself off after a period of 5 minutes.

Note: The setting of the Auto Play option in the Media Browser>Settings menu is not important, in Failover mode it will function anyway.

## CEC and CEC RC Passthrough

This function allows to control the CEC-enabled devices, that are connected through HDMI ports by using the remote control of the Display.

The **CEC** option in the **System>Settings>More** menu should be set as **Enabled** at first. Press the **Source** button and select the HDMI input of the connected CEC device from the **Sources List** menu. When new CEC source device is connected, it will be listed in source menu with its own name instead of the connected HDMI ports name(such as DVD Player, Recorder 1 etc.).

The Display remote is automatically able to perform the main functions after the connected HDMI source has been selected.

To terminate this operation and control the Display via the remote again, press the **Quick Menu** button on the remote if available, highlight the **CEC RC Passthrough** and set as **Off** by pressing Left or Right button. If the **Quick Menu** button is not available press and hold the "0-Zero" button on the remote control for 3 seconds. This feature(**CEC**) can also be enabled or disabled under the **System>Settings>More** menu.

The Display supports also ARC(Audio Return Channel) feature. This feature is an audio link meant to replace other cables between the Display and the audio system (A/V receiver or speaker system).

When ARC is active, Display does not mute its other audio outputs automatically. So you need to decrease Display volume to zero manually, if you want to hear audio from connected audio device only (same as other optical or co-axial digital audio outputs). If you want to change connected device's volume level, you should select that device from the source list. In that case volume control keys are directed to connected audio device.

*Note: ARC is supported only via the HDMI1 input.*

## System Audio Control

Allows an Audio Amplifier/Receiver to be used with the Display. The volume can be controlled using the remote control of the Display. To activate this feature set the **Speakers** option in the **System>Settings>More** menu as **Amplifier**. The Display speakers will be muted and the sound of the watched source will be provided from the connected sound system.

*Note: The audio device should support System Audio Control feature and **CEC** option should be set as **Enabled**.*

## Display Menu Contents

### System - Picture Menu Contents

<b>Mode</b>	You can change the picture mode to suit your preference or requirements. Picture mode can be set to one of these options: <b>Text</b> , <b>Game</b> , <b>Sports</b> , <b>Signage</b> and <b>Natural</b> . Signage mode has been developed to enhance Dynamic contrast, colors and sharpness levels.
<b>Contrast</b>	Adjusts the light and dark values on the screen.
<b>Brightness</b>	Adjusts the brightness values on the screen.
<b>Sharpness</b>	Sets the sharpness value for the objects displayed on the screen.
<b>Colour</b>	Sets the colour value, adjusting the colours.
<b>Energy Saving</b>	For setting the <b>Energy Saving</b> to <b>Custom</b> , <b>Minimum</b> , <b>Medium</b> , <b>Maximum</b> , <b>Auto</b> , <b>Screen Off</b> or <b>Off</b> . <i>Note: Available options may differ depending on the selected Mode.</i>
<b>Backlight</b>	This setting controls the backlight level. The backlight function will be inactive if the <b>Energy Saving</b> is set to an option other than <b>Custom</b> .
<b>Advanced Settings</b>	
<b>Dynamic Contrast</b>	You can change the dynamic contrast ratio to desired value.
<b>Noise Reduction</b>	If the signal is weak and the picture is noisy, use the <b>Noise Reduction</b> setting to reduce the amount of noise.
<b>Colour Temp</b>	Sets the desired colour temperature value. <b>Cool</b> , <b>Normal</b> and <b>Warm</b> options are available. Cool (13000K), Normal (9300K), Warm (8500K), Cool and Normal modes have a gamma setting of 2.2, warm mode has a gamma setting of 2.4.
<b>Picture Zoom</b>	Sets the desired image size format.
<b>Movie Sense</b>	Press left/right buttons to set <b>Movie Sense</b> to <b>Low</b> , <b>Medium</b> , <b>High</b> or <b>Off</b> . While <b>Movie Sense</b> is active, it will optimize the Display's video settings for motion images to acquire a better quality and readability. When <b>Movie Sense</b> option is set to <b>Low</b> , <b>Medium</b> or <b>High</b> , <b>Movie Sense</b> demo option will be available. If one of these options is selected and if you press <b>OK</b> button, then the demo mode starts. While demo mode is active, the screen will be divided into two sections, one displaying the movie sense activity, the other displaying the normal settings for Display screen. <i>Note: This feature may not be available depending on the model of your unit.</i>
<b>Film Mode</b>	Films are recorded at a different number of frames per second. Turn this feature on when you are watching films to see the fast motion scenes clearly.
<b>HDMI Full Range</b>	While watching from a HDMI source, this feature will be visible. You can use this feature to enhance blackness in the picture. Enabled = 0-255, Disabled = 0-235
<b>RGB Gain</b>	Adjust the strength of the red, green and blue colors. To enable fine adjustment of White balance.
<b>PC Position</b>	
<b>Autoposition</b>	Automatically optimizes the display. Press OK to optimize.
<b>H Position</b>	This item shifts the image horizontally to the right hand side or left hand side of the screen.
<b>V Position</b>	This item shifts the image vertically towards the top or bottom of the screen.
<b>Dot Clock</b>	Dot Clock adjustments correct the interference that appear as vertical banding in dot intensive presentations like spreadsheets or paragraphs or text in smaller fonts.
<b>Phase</b>	Depending on the input source(computer etc.) you may see a hazy or noisy picture on the screen. You can use phase to get a clearer picture by trial and error.
<b>Reset</b>	Resets the picture settings to factory default settings (except <b>Game</b> mode).

*While in VGA (PC) mode, some items in **Picture** menu will be unavailable. Instead, VGA mode settings will be added to the **Picture Settings** while in PC mode.*

System - Sound Menu Contents	
<b>Volume</b>	Adjusts the volume level.
<b>Equalizer</b>	Selects the equalizer mode. Custom settings can be made only when in <b>User</b> mode.
<b>Balance</b>	Adjusts whether the sound comes from the left or right speaker.
<b>Headphone</b>	Sets headphone volume. Please ensure before using headphones that the headphone volume is set to a low level, to prevent damage to your hearing. Only available if Headphone/lineout is set to headphone.
<b>AVL (Automatic Volume Limiting)</b>	Sets the sound to obtain fixed output level between sources.
<b>Headphone/Lineout</b>	When you connect an external amplifier to your Display using the headphone jack, you can select this option as <b>Lineout</b> . If you have connected headphones to the Display, set this option as <b>Headphone</b> . Please ensure before using headphones that this menu item is set to <b>Headphone</b> . If it is set to <b>Lineout</b> , the output from the headphone socket will be set to maximum which could damage your hearing.
<b>Digital Out</b>	Sets digital out audio type. PCM or Compressed
<b>Bass Gain</b>	Controls the bass gain level. Use Left or Right button to set. <b>Note:</b> This feature may not be available depending on the model of your unit.

System - Settings Menu Contents	
<b>Language</b>	Sets the OSD menu language preference.
<b>Date/Time</b>	Sets date and time.
<b>Sources</b>	Enables or disables selected source options.
<b>Network/Internet Settings</b>	Displays network/internet settings.
<b>More</b>	Displays other setting options of the Display.
<b>Menu Timeout</b>	Changes timeout duration for menu screens.
<b>Software upgrade</b>	Ensures that your Display has the latest firmware. Press <b>OK</b> to see the menu options.
<b>Application Version</b>	Displays current software version.
<b>Auto Display OFF</b>	Sets the desired time for the Display to automatically go into standby mode when not being operated.
<b>Audio Video Sharing</b>	<b>Audio Video Sharing</b> feature allows you to share files stored on your smartphone or tablet pc. If you have a compatible smartphone or tablet pc and the appropriate software is installed, you can share/play photos on your Display. See instructions of your sharing software for more information. <b>Audio Video Sharing</b> mode will not be available with internet portal feature.
<b>Power Up Mode</b>	This setting configures the power up mode preference. <b>Last State, Always On</b> and <b>Standby</b> options are available.
<b>CEC</b>	With this setting you can enable and disable CEC functionality completely. Press Left or Right button to enable or disable the feature.
<b>CEC Auto Power On</b>	This function allows the connected HDMI-CEC compatible device to turn on the Display and switch to its input source automatically. Press <b>Left</b> or <b>Right</b> button to enable or disable the feature.
<b>Speakers</b>	To hear the Display audio from the connected compatible audio device set as <b>Amplifier</b> . You can use the remote control of the Display to control the volume of the audio device.

<b>DP Stream Setting (*)</b>	Sets the DisplayPort stream type. <b>MST</b> and <b>SST</b> options are available. (* <i>This menu item appears only when the input source is set to DP.</i> )
<b>Quickstandby</b>	If this feature is enabled, control of the product through serial communication port and Ethernet port is possible. Enable if you wish to use the scheduler function.

### Signage Settings Menu Contents

<b>Set ID</b>	Sets the device ID. You can select a value between 0-100 using the numeric buttons on the remote in order to identify your Display.
<b>OSD Orientation</b>	Sets the OSD (On Screen Display) rotation of your Display. <b>Landscape</b> and <b>Portrait</b> options are available.
<b>Software upgrade</b>	Displays current software version. Press <b>OK</b> to see the <b>Upgrade options</b> menu. You can use these options to start a manual search for software updates and set your automatic scan preference.
<b>Serial number</b>	Displays serial number of the unit. (Cannot be changed by user)
<b>Model name</b>	Displays model name of the unit. (Cannot be changed by user)
<b>Save model information</b>	Copies the model information data of the unit to a connected USB device. This information will be required if you contact Toshiba about your monitor
<b>Clone to USB</b>	Copies the database files from the unit to a connected USB device.
<b>Clone from USB</b>	Copies the database files from a connected USB device to the unit.
<b>Internal USB operations</b>	Copies files from internal USB to the unit. <i>Note: This feature may not be available depending on the model of your unit. Only available when internal USB device is connected</i>
<b>Video Wall Settings</b>	Press <b>OK</b> to open the <b>Video Wall Settings</b> menu screen. <b>Row Count</b> , <b>Column Count</b> , <b>Cell</b> and <b>Offset</b> options are available.
<b>Power Up Mode</b>	Configures the power up mode preference. <b>Last state</b> , <b>Always on</b> and <b>Standby</b> options are available.
<b>Quick Standby</b>	If this feature is enabled, control of the product through serial communication port and Ethernet port is possible. Enable if you wish to use the scheduler function.
<b>OPS Settings</b>	Press OK to open the OPS Settings menu screen. Three sub-menu options are available.
<b>OPS Information</b>	Displays read-only information about the OPS unit, if supported.
<b>OPS Status</b>	Displays whether the OPS module is on or off. Allows the change of status via soft PSON signal (0.5s)
<b>Powerdown</b>	Turns the OPS off via hard PSON signal (5s) <i>Note: This menu will not be available if OPS is not supported or not connected to the unit.</i>
<b>Copy app cache from USB</b>	Copies app cache data from a connected USB device to the unit. <i>Note: This feature may not be available depending on the model of your unit.</i>
<b>Scheduler Settings</b>	Press <b>OK</b> to open the <b>Scheduler Settings</b> menu screen. Set the <b>Scheduler</b> option as <b>On</b> by using the <b>Left/Right</b> directional buttons. Using the sub-menu options you can set the unit to turn on automatically at defined time with the defined input source setting. It can also be set to turn off at defined time. If the <b>Source</b> option is set as <b>Last state</b> , the input source will not be changed at the power-up. If the <b>Source</b> option is set as <b>USB</b> , the media files in the connected USB device will be played back automatically as explained in the section entitled ' <b>USB Auto Play Feature</b> '.



<b>Link options</b>	<p>Press <b>OK</b> to open the <b>Link Options</b> menu screen. Current <b>Start url</b> and <b>Settings url</b> links will be displayed. These items are for information only and not selectable and can only be changed by USB operation command and RS232. See USB operation and RS232 command list <b>Open browser initial page</b> and <b>NTP server</b> link preferences can be configured using the remote control or RS232. The display clock function will only operate if an NTP server is used. To ensure correct operation, please change the NTP server to one that is more suitable for the location where the display is to be used.</p> <p><b>Note:</b> <i>Start URL and Settings URL availability is depending on model.</i></p>
<b>Pixel shift</b>	<p>Enables or disables pixel shifting. This option can be used to avoid image retention (after image effects) that can occur when displaying fixed patterns or still images for a long periods of time. If enabled, the picture and OSD (On-Screen Display) will be shifted at specified time intervals.</p>
<b>USB Information</b>	<p>Press <b>OK</b> to open the <b>USB information</b> menu screen. Current <b>Total space</b> and <b>Free space</b> informations of the connected USB device will be displayed. You can also format the connected USB device using the <b>Format Disk</b> option in this menu. (FAT32 format only)</p>
<b>Power on Delay</b>	<p>Sets a delay value at power on. This value can be set from 0 to 2000 ms in steps of 100 ms. The Display will turn on after the set delay time is expired.</p>
<b>USB operations</b>	<p>Highlight and press <b>OK</b> to perform USB operations. See separate USB operations command list for available functions available on your monitor.</p>
<b>No Signal</b>	<p>Sets the behavior preference of the Display, when no signal is detected from the currently set input source. <b>Failover</b> and <b>Input Search</b> options are available. Sets the behavior preference of the Display, when no signal is detected from the currently set input source. Failover and Input Search options are available.</p> <p>If Failover is selected the TV checks the connected USB device for available files to play. If no playable files are available or there is no USB device connected to the Display, the No Signal image will be displayed. If there isn't any No Signal Image available, No Signal OSD will be displayed on the screen. The setting of the Auto Play option in the Media Browser&gt;Settings menu is not important, in Failover mode it will function anyway.</p> <p>If Input Search is selected the Display will search all available input sources consecutively to find signal. If no signal is detected from other available sources, No Signal OSD will be displayed and the Display will turn itself off after a period of 30 seconds.</p> <p><b>Note:</b> To set no signal image see USB operation command list.</p>
<b>No Signal Power off</b>	<p>When enabled the Display will turn itself off after a period of 5 minutes, if no signal is received from the selected source.</p> <p>This feature will only work if all of the following circumstances occur:</p> <p><b>-No Signal</b> option is set as <b>Failover</b>.</p> <p>USB device is not connected to the Display / USB device is connected but there are no playable files installed in the USB device.</p>
<b>Auto launch</b>	<p>Configures the auto launch preference. <b>CMS(Start url)</b>, <b>Open Browser(Open Browser initial page)</b> and <b>Disabled</b> options are available.</p>
<b>Last Status</b>	<p>Set as '<b>On</b>' to enable the Display to reopen with the closing status.</p>
<b>Panel Lock</b>	<p>Set as '<b>Off</b>' to prohibit the use of the buttons on the Display.</p>
<b>RCU Inhibit</b>	<p>Set as '<b>On</b>' to inhibit the use of the remote. Remote control will function in Stand-By mode independently from the setting of this option. If this option is set as '<b>Limited</b>' only the Volume Up/Down, Numeric Buttons and the Standby button on the remote will be functional.</p>
<b>Volume Settings</b>	<p>Press <b>OK</b> to see available Volume Settings menu options.</p>
<b>USB Option</b>	<p>Set as '<b>Off</b>' to disable the USB ports on the Display. You can also set this option as <b>5V</b> to provide 5 volts power over USB. In this case it will still not be available to browse the USB content via Media Browser feature of the Display.</p>
<b>Bootup Picture mode</b>	<p>Configures the picture mode preference at power on. If set as <b>Off</b> the last set picture mode will be used at power on.</p>

<b>Reset to Default Values</b>	Highlight this option and press the <b>OK</b> button on the remote to return the Display to default settings.
<b>TV Live Time</b>	Displays the duration of life of the unit.
<b>First time installation</b>	Highlight and press <b>OK</b> to perform <b>First Time Installation</b> and reset all settings to factory settings. You will need to enter the correct PIN to carry out this operation. <i>Note: Enter the PIN you have defined during the <b>First Time Installation</b> process.</i>

## Connectivity

To configure wired or wireless settings please refer to the **Network/Internet Settings** section in the **System>Settings** menu.

### Wired Connectivity

#### To Connect to a Wired Network

- You must have a modem/router connected to an active broadband connection.
- Connect your Display to your modem/router via an ethernet cable. There is a LAN port at the rear (back) of your Display.

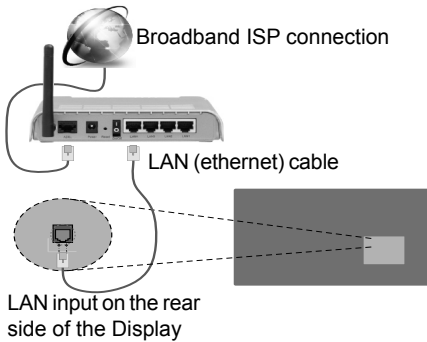

#### Configuring Wired Device Settings

##### Network Type

The **Network Type** can be selected as **Wired Device**, **Wireless Device** or **Disabled**, in accordance with the active connection to the Display. Select this as **Wired Device** if you are connecting via an ethernet.

##### Internet Speed Test

Highlight **Internet Speed Test** and press the **OK** button. Display will check the internet connection bandwidth and display the result when complete.

##### Advanced Settings

Highlight **Advanced Settings** and press the **OK** button. On the next screen you can change the IP and DNS settings of the Display. Highlight the desired one and press Left or Right button to change the setting from **Automatic** to **Manual**. Now you can enter the **Manual IP** and / or **Manual DNS** values. Select the related item in the drop down menu and enter the new values using the numeric buttons on the remote. Press the **OK** button to save settings when complete.

### Wireless Connectivity

#### To Connect to a Wireless Network

The Display cannot connect to the networks with a hidden SSID (wireless network name). To make your

modem's SSID visible, you should change your SSID settings via the modem's software.

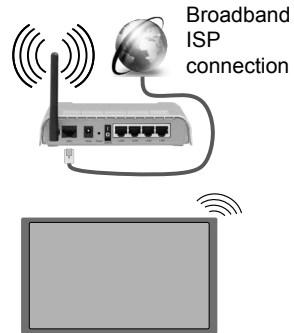

- A Wireless-N router (IEEE 802.11a/b/g/n) with simultaneous 2.4 and 5 GHz bands is designed to increase bandwidth. These are optimized for smoother and faster HD video streaming, file transfers.
- The frequency and channel differ depending on the area.
- The transmission speed differs depending on the distance and number of obstructions between the transmission products, the configuration of these products, the radio wave conditions, the line traffic and the products that you use. The transmission may also be cut off or may get disconnected depending on the radio wave conditions, DECT phones or any other WiFi 11b appliances. The standard values of the transmission speed are the theoretical maximum values for the wireless standards. They are not the actual speeds of data transmission.
- The location where the transmission is most effective differs depending on the usage environment.
- The Wireless feature of the Display supports 802.11 a,b,g & n type modems. It is highly recommended that you should use the IEEE 802.11n communication protocol in order to avoid any possible problems while watching videos.
- You must change your modem's SSID when there are any other modems around with the same SSID. You can encounter connection problems otherwise. Use a wired connection if you experience problems with a wireless connection.

#### Configuring Wireless Device Settings

Open the **Network/Internet Settings** menu and select **Network Type** as **Wireless Device** to start connection process.

The Display will scan the wireless networks automatically. A list of available networks will be displayed. Please select your desired network from the list.

**Note:** If the modem supports N mode, you should set N mode settings.

If the selected network is protected with a password, please enter the correct key by using the virtual keyboard. You can use this keyboard via the directional buttons and the **OK** button on the remote control.

Wait until the IP address is shown on the screen.

This means that the connection is now established. To disconnect from a wireless network, highlight **Network Type** and press Left or Right buttons to set as **Disabled**.

If your router has WPS (Wi-Fi Protected Setup) button, you can directly connect your Display to the modem/router without entering a password or adding the network first. Highlight the **Press WPS on your wifi router** option and press the **OK** button. Then press the WPS button on your router/modem to connect.

Highlight **Internet Speed Test** and press the **OK** button to check your internet connection speed. Highlight **Advanced Settings** and press the **OK** button to open the advanced setting menu. Use directional and numeric buttons to set. Press the **OK** button to save settings when complete.

## Other Information

The status of the connection will be displayed as **Connected** or **Not Connected** and the current IP address, if a connection is established.

### Connecting to your mobile device via wireless function

- If your mobile device has wireless function feature, you can connect it to your Display via a router, in order to access the content in your device. For this, your mobile device must have an appropriate sharing software.
- Connect to your router following the steps stated above in the **Wireless Connectivity** section.
- Afterwards, engage your mobile device with the router and then activate the sharing software on your mobile device. Then, select files that you want to share with your Display.
- If the connection is established correctly, you will be able to access the shared files from your mobile device via the **Media Browser** of your Display.
- Enter the **Media Browser** menu and the playback device selection OSD will be displayed. Select your mobile device and press the **OK** button to continue.

**Note:** This feature may not be supported on all mobile devices.

## Wireless Display

Wireless Display is a standard for streaming video and sound content. This feature provides the ability to use your Display as wireless display device.

## Using with mobile devices

There are different standards which enable sharing of screens including graphical, video and audio content between your mobile device and Display.

Switch to **Wireless Display** source.

A screen appears stating that the Display is ready for connection.

Open the sharing application on your mobile device. These applications are named differently for each brand, please refer to the instruction manual of your mobile device for detailed information.

Scan for devices. After you select your Display and connect, the screen of your device will be displayed on your Display.

**Note:** This feature can be used only if the mobile device supports this feature. Scanning and connecting processes differ according to the programme you use. Android based mobile devices should have the software version V4.2.2 and above.

## Connectivity Troubleshooting

### Wireless Network Not Available

- Ensure that any firewalls of your network allow the Display wireless connection.
- Try searching for wireless networks again, using the **Network/Internet Settings** menu screen.

If the wireless network does not function properly, try using the wired network in your home. Refer to the **Wired Connectivity** section for more information on the process.

If the Display does not function using the wired connection, check the modem (router). If the router does not have a problem, check the internet connection of your modem.

### Connection is Slow

See the instruction book of your wireless modem to get information on the internal service area, connection speed, signal quality and other settings. You need to have a high speed connection for your modem.

### Distruption during playback or slow reactions

You could try the following in such a case:

Keep at least three meters distance from microwave ovens, mobile telephones, bluetooth devices or any other wireless function compatible devices. Try changing the active channel on the WLAN router.

### Internet Connection Not Available / Audio Video Sharing Not Working

If the MAC address (a unique identifier number) of your PC or modem has been permanently registered, it is possible that your Display might not connect to the internet. In such a case, the MAC address is authenticated each time when you connect to the

internet. This is a precaution against unauthorized access. Since your Display has its own MAC address, your internet service provider cannot validate the MAC address of your Display. For this reason, your Display cannot connect to the internet. Contact your internet service provider and request information on how to connect a different device, such as your Display, to the internet.

It is also possible that the connection may not be available due to a firewall problem. If you think this causes your problem, contact your internet service provider. A firewall might be the reason of a connectivity and discovery problem while using the Display in Audio Video Sharing mode or while browsing via Audio Video Sharing feature.

### Invalid Domain

Ensure that you have already logged on to your PC with an authorized username/password and also ensure that your domain is active, prior to sharing any files in your media server program on your PC. If the domain is invalid, this might cause problems while browsing files in Audio Video Sharing mode.

## Using Audio Video Sharing Network Service

Audio Video Sharing feature uses a standard that eases the viewing process of digital electronics and makes them more convenient to use on a home network. This standard allows you to view and play photos, music and videos stored on your media server connected to your home network.

### 1. Connect to a Wired or Wireless Network

See the **Wired/Wireless Connectivity** chapters for detailed configuration information.

### 2. Play Shared Files via Media Browser

Select **Media Browser** by using the **directional** buttons from the main menu and press **OK**. The media browser will then be displayed.

## Audio Video Sharing

Select the desired media type on the main media browser menu and press **OK**. If sharing configurations are set properly, **Device Selection** screen will be displayed after selecting the desired media type. If available networks are found, they will be listed on this screen. Select media server or network that you want to connect to using the Up or Down buttons and press **OK**. If you want to refresh the device list, press the **Green** button. You can press **Menu** to exit.

If you select the media type as **Videos** and choose a device from the selection menu. Then select the folder with video files in it on the next screen and all the available video files will be listed.

To play other media types from this screen, you can go back to main **Media Browser** screen and select the media type as desired and then perform the network selection again. Or press the **Blue** button to switch to next media type quickly without changing the network. Refer to the **Media Browser** menu section for further information on file playback.

If a problem occurs with the network, please switch your display off at the wall socket and back on again. Trick mode and jump are not supported with the Audio Video Sharing feature.

PC/HDD/Media Player or any other devices that are compatible should be used with a wired connection for higher playback quality.

Use a LAN connection for quicker file sharing between other devices like computers.

**Note:** *There may be some PC's which may not be able to utilize the Audio Video Sharing feature due to administrator and security settings (such as business PC's).*



## Internet Browser

To use the internet browser, press the browser button on the RCU or using the main menu.

In the initial screen of the browser, the thumbnails of the predefined (if any) links to web sites available will be displayed as **Speed Dial** options along with the **Edit Speed Dial** and the **Add to Speed Dial** options.

If the browser URL is defined in the Link Options menu, the browser will open on this page.

To navigate the web browser, use the directional buttons on the remote or a connected mouse. To see the browser options bar, move the cursor to the top of the page. **History**, **Tabs** and **Bookmarks** options and the browser bar which contains previous/next buttons, the refresh button, the address/search bar, the **Speed Dial** and the **Opera** buttons are available.

To add a desired website to the **Speed Dial** list for quick access, move the cursor to the top of the page. The browser bar will appear. Highlight the **Speed Dial** -  button and press the **OK** button. Then select **Add to Speed Dial** option and press the **OK** button. Fill in the blanks for **Name** and **Address**, highlight **OK** and press the **OK** button to add. Whilst you are on the site you wish to add to the **Speed Dial** list, highlight the **Opera**-  button and press the **OK** button. Then highlight **Add to Speed Dial** option in the submenu and press the **OK** button again. **Name** and **Address** will be filled automatically according to the site you are visiting. Highlight **OK** and press the **OK** button to add.

You can also use the **Opera** menu options to manage the browser. Highlight the **Opera**-  button and press the **OK** button to see available page specific and general options.

There are various ways to search or visit websites using the web browser.

Enter the address of a website(URL) into the search/address bar and highlight the **Submit** button on the virtual keyboard and press the **OK** button to visit the site.

Enter keyword/s into the search/address bar and highlight the **Submit** button on the virtual keyboard and press the **OK** button to start a search for the related websites.

Highlight a Speed Dial thumbnail and press the **OK** button to visit the related website.

Your Display is compatible with USB keyboard/mice. Plug your device into the USB input of your Display for easier and quicker navigation.

Some web pages include flash content. These are not supported by the browser.

Your Display does not support any download processes from the internet via the browser.

All sites on the internet might not be supported. According to the site; content problems may occur. In some circumstances video contents might not be able to be played.

## Internal USB Operations (\*)

Your Display has an internal memory. There are 4 operations available that can be performed with the internal memory: **Copy From USB**, **Copy To USB**, **Delete** and **Format Disk FAT32 only**.

These options can be found in the signage settings/internal USB operations menu.

The internal memory of your Display has a default folder named "**int\_usb**" in the root directory. All **Copy From/To USB** operations are performed using this folder. If you want to copy data from an external USB storage device to the internal memory of your Display, this/these data file/s should be installed in a folder named "**copy\_to\_int\_usb**" in the root directory of the external USB storage device. If you want to copy data from the internal memory of your Display to an external USB storage device, a folder named "**copy\_from\_int\_usb**" should be created in the root directory of the external USB storage device.

**Copy From/To USB** operations will only be available if a USB storage device is connected to your Display. **Delete** and **Format Disk** options will be still functional, even if no USB storage device is connected. The default "**int\_usb**" folder in the root directory of the internal memory will be automatically recreated after each time **Delete** and **Format Disk** operations are performed.

*(\*) This feature may not be available depending on the model of your Display*

## OSD Rotation Support (\*)

You can change the OSD (On Screen Display) rotation of your Display if desired. While performing **First time installation** set the **OSD Orientation** option as desired when the **Signage Settings** menu is displayed. You can also change this setting later from the **Signage Settings** menu. Available options are: **Landscape** and **Portrait**.

*(\*) This feature may not be available depending on the model of your Display*

## DisplayPort

DisplayPort version 1.2 is supported via the DisplayPort input and output connectors on your Display.

**DP Streaming Setting** option in the **System>Settings>More** menu is set as **MST**(Multi-Stream Transport) by default. If a MST compliant source device is connected to the Display, the streaming data should be configured on the source device (Daisy-chaining).

If DisplayPort version 1.1 compliant or SST (Single-Stream Transport) compliant source device with DisplayPort version 1.2 support is connected to the Display, DisplayPort output on the Display will work as a splitter. In this case, same image will be displayed in all connected Displays.

To be able to stream the same image to all connected Displays using a MST compliant device, **DP Streaming Setting** option in the **System>Settings>More** menu should be set as **SST**.

The maximum amount of the Displays that can be connected by using daisy-chaining function may differ depending on the source device's capacity. The image that will be displayed in all Displays will be defined by the source device. For example, to be able to stream 4 different FHD images, the source device should be capable of supporting this operation.

**Note:** *It is recommended to use a DisplayPort certified cable for connection.*

## Controlling With An External PC

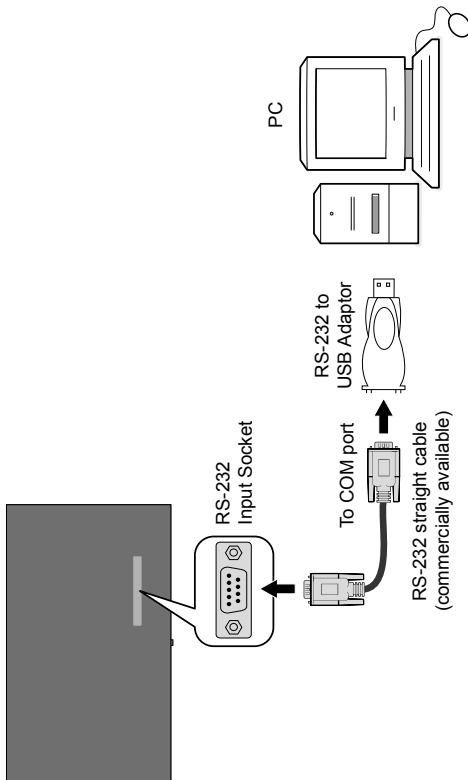

You can control the product from an external PC via RS-232 (COM port or LAN(Ethernet port)) on the PC. For instance, system source can be changed by RS-232 from remote computer. When a command is sent from the PC to the product, the product operates according to the received command and sends a response message to the PC.

### Equipment/Tools:

- RS-232 (female) to RS-232(male) cable or LAN cable (connected via router).
- USB to RS-232(male) cable
- Notebook or PC which has USB port or LAN
- Installed program on remote PC to send commands:

In general, the RS-232 commands are sent for operating the implemented functions via serial port and utility a suitable utility can be used such as described below.

## Connecting to the Display LAN port

Download and install the PuTTY software from the following link first: <http://www.putty.org/>.

Run the software and enter the Display's IP address in the field **Host Name**. Enter "**1986**" as a default value in the field **Port**. Then select "**Telnet**" as **Connection type** and click the **Open** button.

**Note:** Refer to the **Connectivity** section of this manual for information on connecting the *Display* to a network and displaying the IP address of the *Display*.

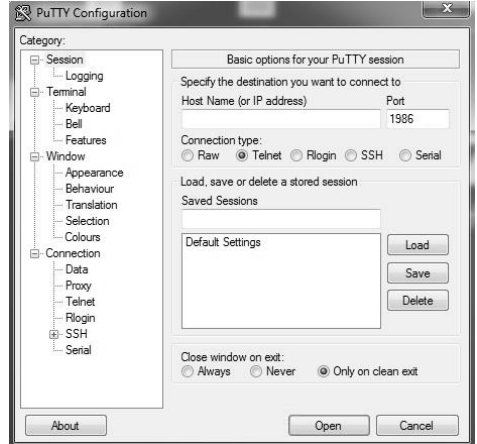

Use the commands in the **RS232 Command Table** which can be found on **Toshiba website**. For example, if "GETVOLUME" command is entered, current volume level should be displayed on the putty window as shown in the pictures below.



Another example;

Volume level can be changed by using "VOLUME" command. After sending this command, you can verify the changes from the Display.



The last example ;

When "GETSOURCE" command is entered, current source should be displayed on the putty window as shown in the picture below.



## Connecting to the Display (RS232 port)

Run the software and select **Serial** as **Connection Type**. Enter the Display's serial port in the field **Serial Line** (in the following example it is COM4) and **"115200"** in the field **Speed**. Then click the **Open** button.

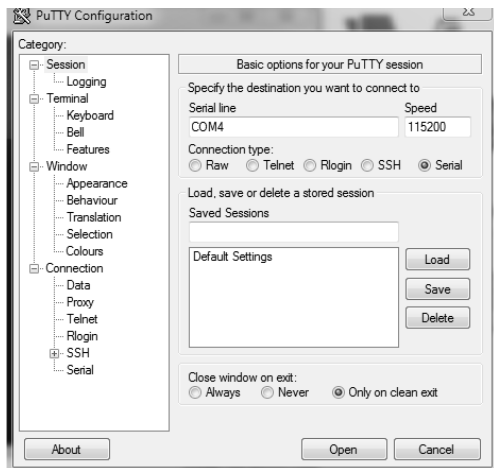

## System Features

### Panel

<b>Panel type</b>	65" (165cm) DLED	
<b>Resolution</b>	1920x1080	
<b>Active Area</b>	1073.78(H) x 604.0(V)	
<b>Visual angle</b>	<b>Horizontal</b>	178°
	<b>Perpendicular</b>	178°
<b>Max. brightness</b>	Typ : 400 cd/m <sup>2</sup>	
<b>Max. Contrast</b>	Typ : 1200	
<b>Response time</b>	6ms	
<b>H-Frequency</b>	60 KHz	
<b>V-Frequency</b>	67.5 KHz	

### Audio

2 x 8 W Audio Output Power

### Network Connection

Ethernet (LAN)

802.11 a/b/g/n built in

### Input/Output Ports

- 1 x USB 2.0 port
- 1 x USB 3.0 port
- 1 x Internal USB 3.0 port
- 1 x HDMI 2.0 In port (1.4 for FHD panels)
- 1 x VGA port
- 1 x Audio input port
- 1 x Audio output port
- 1 x RS232 port
- 1 x RJ12 port (Service only)
- 1 x Video In port
- 1 x YPbPr port
- 1 x SPDIF Coaxial Out port
- 1 x DVI port
- 1 x DisplayPort v1.2 In
- 1 x DisplayPort v1.2 Out
- 1 x Headphone port
- 1 x IR port

### Power

110-240V AC 50-60Hz 1.3A

Specifications are subject to change without notice.



Paying attention to the following points with respect to your product will provide a stable performance and also prolong its life.

### Daily Care

#### • Environmental Factors

Do not directly expose your product to humidity, high temperature, fire, direct sun light and dust while using it. The vent holes of your product will allow it perform safer without system overheating. Do not cover these holes or do not prevent air flow with an object.

Position your product at least 15 cm away from strong magnetic field generating electrical devices such as product, refrigerator or large speakers. Do not suddenly take your product from a cold environment and suddenly put it in a warm environment. A sudden temperature change of 10°C may cause some of the internal parts to malfunction. Do not put your product on an uneven surface.

#### • General points

- Points to be taken into consideration while cleaning the product

Your system must be turned off while cleaning your product. Please use a soft and damp piece of cloth for cleaning its surface. Do not use chemical cleansers to clean the screen. Do not directly apply the cleaning material on your monitor.

#### • Orientation

Your display can be mounted in both portrait and landscape positions.

When changing from Landscape to Portrait mode, the display must only be rotated clockwise so the IR and Stand-by LED housing is on the left side.

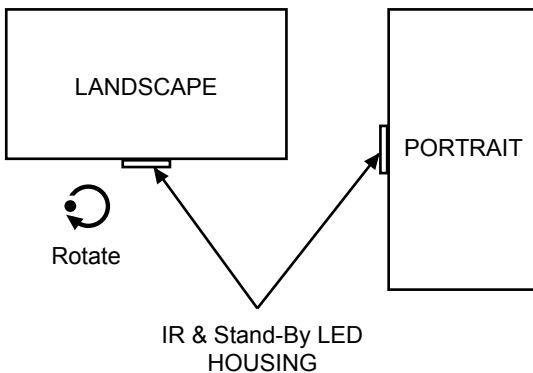

## Notification

### TRADEMARK ACKNOWLEDGMENT

The terms HDMI and High-Definition Multimedia Interface, and the HDMI Logo are trademarks or registered trademarks of HDMI Licensing LLC in the United States and other countries.



Manufactured under license from Dolby Laboratories. Dolby, Dolby Audio and the double-D symbol are trademarks of Dolby Laboratories.



### MP3 licence letter

MPEG Layer-3 audio coding technology licensed from Fraunhofer IIS and Thomson.

### MP4 licence letter

THIS PRODUCT IS LICENSED UNDER THE MPEG-4 VISUAL PATENT PORTFOLIO LICENSE FOR THE PERSONAL AND NON-COMMERCIAL USE OF A CONSUMER FOR (I) ENCODING VIDEO IN COMPLIANCE WITH THE MPEG-4 VISUAL STANDARD (MPEG-4 VIDEO) AND/OR (II) DECODING MPEG-4 VIDEO THAT WAS ENCODED BY A CONSUMER ENGAGED IN A PERSONAL AND NON-COMMERCIAL ACTIVITY AND/ OR WAS OBTAINED FROM A VIDEO PROVIDER LICENSED BY MPEG LA TO PROVIDE MPEG-4 VIDEO.

NO LICENSE IS GRANTED OR SHALL BE IMPLIED FOR ANY OTHER USE. ADDITIONAL INFORMATION INCLUDING THAT RELATING TO PROMOTIONAL, INTERNAL AND COMMERCIAL USES AND LICENSING MAY BE OBTAINED FROM MPEG LA, L.L.C. SEE [HTTP://WWW.MPEGLA.COM](http://WWW.MPEGLA.COM)

### AVC licence letter

THIS PRODUCT IS LICENSED UNDER THE AVC PATENT PORTFOLIO LICENSE FOR THE PERSONAL AND NON-COMMERCIAL USE OF A CONSUMER TO (I) ENCODE VIDEO IN COMPLIANCE WITH THE AVC STANDARD ("AVC VIDEO") AND/OR (II) DECODE AVC VIDEO THAT WAS ENCODED BY A CONSUMER ENGAGED IN A PERSONAL AND NON-COMMERCIAL ACTIVITY AND/OR WAS OBTAINED FROM A VIDEO PROVIDER LICENSED TO PROVIDE AVC VIDEO. NO LICENSE IS GRANTED OR SHALL BE IMPLIED FOR ANY OTHER USE. ADDITIONAL INFORMATION MAY BE OBTAINED FROM MPEG LA, L.L.C. SEE [HTTP://WWW.MPEGLA.COM](http://WWW.MPEGLA.COM)

## Trouble Shooting & Tips

### Display does not turn on

Make sure the power cord is plugged in securely to the mains socket. Check if batteries are of the remote exhausted. Press the Standby button on the Display.

### No picture

This means your Display is not receiving any signal.

Check if the correct source is selected.

Check if the connection cable is plugged in properly.

Check if the connection cable is damaged.

Check if suitable cables are used for connection.

### No sound

Check if the Display is muted. Press the Mute button or increase the volume to check.

Sound may be coming from only one speaker. Check the balance settings from Sound menu.

### Remote control - no operation

The batteries may be exhausted. Replace the batteries.

### Input sources - can not be selected

Check the AV cables and connections if you are trying to switch to the input source dedicated to the connected device.

If you are in any doubt please consult your dealer.

## Accessories Included

Remote Control

Batteries: 2 x AAA

Instruction Book

IR Extender

EU and UK mains lead

8Gb USB memory device (dependent on model)

### Optional Accessories

OPS

Overlay Touch Screen Kit

## Dimensions Unit

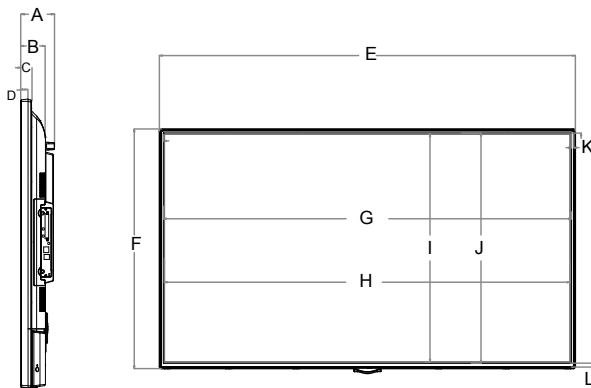

	A (mm)	B (mm)	C (mm)	D (mm)	E (mm)	F (mm)	G (mm)	H (mm)	I (mm)	J (mm)	K (mm)	L (mm)
65"	95,7	72	31.6	21.6	1459,4	841.2	1430,1 Bezel	1428.5	803.5	805.1 Bezel	13.6	10.4

Weight : 26 Kg

## Disposal...

The following information is only for EU-member states:

### Disposal of products

The crossed out wheeled dust bin symbol indicates that products must be collected and disposed of separately from household waste. Integrated batteries and accumulators can be disposed of with the product. They will be separated at the recycling centres.

The black bar indicates that the product was placed on the market after August 13, 2005.

By participating in separate collection of products and batteries, you will help to assure the proper disposal of products and batteries and thus help to prevent potential negative consequences for the environment and human health.

For more detailed information about the collection and recycling programmes available in your country, please contact your local city office or the shop where you purchased the product.



### Disposal of batteries and/or accumulators

The crossed out wheeled dust bin symbol indicates that batteries and/or accumulators must be collected and disposed of separately from household waste.

If the battery or accumulator contains more than the specified values of lead (Pb), mercury (Hg), and/or cadmium (Cd) defined in the European Battery Directive, then the chemical symbols for lead (Pb), mercury (Hg) and/or cadmium (Cd) will appear below the crossed out wheeled dust bin symbol.

By participating in separate collection of batteries, you will help to assure the proper disposal of products and batteries and thus help to prevent potential negative consequences for the environment and human health. For more detailed information about the collection and recycling programmes available in your country, please contact your local city office or the shop where you purchased the product.



## REACH information

The European Union (EU) chemical regulation, REACH (Registration, Evaluation, Authorization and Restriction of Chemicals), entered into force on 1 June 2007, with phased deadlines to 2018.

Toshiba will meet all REACH requirements and is committed to provide our customers with information about the presence in our articles of substances included on the candidate list according to REACH regulation.

Please consult the following website <http://www.toshiba.eu/reach> for information about the presence in our articles of substances included on the candidate list according to REACH in a concentration above 0.1 % weight by weight.

## EU Conformity Statement



This product is carrying the CE-Mark in accordance with the related European Directives.

Responsible for CE-Marking is TOSHIBA. 23 Davy Road, Plymouth, Devon. UK. PL6 8BY

This product is labeled with the CE Mark in accordance with the related European Directives, notably Low Voltage Directive 2014/35/EU, Electromagnetic Compatibility Directive 2014/30/EU and RoHS Directive 2011/65/EU.

We hereby declare that this product with an integrated Wireless Function is in compliance with the essential requirements and other relevant provisions of Directive 1999/5/EC.



TOSHIBA 2017

© TOSHIBA 23 Davy Road, Plymouth Devon PL6 8BY England  
All rights reserved.

Reproduction in whole or part without written permission is strictly prohibited.

This equipment corresponds to requirements of the Technical Regulation on limitation of usage of certain dangerous substances in electrical and electronic equipment.

