

Multi Channel AV Receiver

Operating Instructions

STR-DH710

WARNING

To reduce the risk of fire or electric shock, do not expose this apparatus to rain or moisture.

To reduce the risk of fire, do not cover the ventilation opening of the apparatus with newspapers, tablecloths, curtains, etc. Do not place the naked flame sources such as lighted candles on the apparatus.

Do not install the appliance in a confined space, such as a bookcase or built-in cabinet.

To reduce the risk of fire or electric shock, do not expose this apparatus to dripping or splashing, and do not place objects filled with liquids, such as vases, on the apparatus.

As the main plug is used to disconnect the unit from the mains, connect the unit to an easily accessible AC outlet. Should you notice an abnormality in the unit, disconnect the main plug from the AC outlet immediately.

Do not expose batteries or apparatus with battery-installed to excessive heat such as sunshine, fire or the like.

The unit is not disconnected from the mains as long as it is connected to the AC outlet, even if the unit itself has been turned off.

Excessive sound pressure from earphones and headphones can cause hearing loss.



This symbol is intended to alert the user to the presence of the Hot Surface that may be hot if it is touched during the normal operation.

For customers in the United States

Owner's Record

The model and serial numbers are located on the rear of the unit. Record these numbers in the space provided below. Refer to them whenever you call upon your Sony dealer regarding this product.

Model No. _____ Serial No. _____



This symbol is intended to alert the user to the presence of uninsulated "dangerous voltage" within the product's enclosure that may be of sufficient magnitude to constitute a risk of electric shock to persons.



This symbol is intended to alert the user to the presence of important operating and maintenance (servicing) instructions in the literature accompanying the appliance.

Important Safety Instructions

- 1) Read these instructions.
- 2) Keep these instructions.
- 3) Heed all warnings.
- 4) Follow all instructions.
- 5) Do not use this apparatus near water.
- 6) Clean only with dry cloth.
- 7) Do not block any ventilation openings. Install in accordance with the manufacturer's instructions.
- 8) Do not install near any heat sources such as radiators, heat registers, stoves, or other apparatus (including amplifiers) that produce heat.
- 9) Do not defeat the safety purpose of the polarized or grounding-type plug. A polarized plug has two blades with one wider than the other. A grounding type plug has two blades and a third grounding prong. The wide blade or the third prong are provided for your safety. If the provided plug does not fit into your outlet, consult an electrician for replacement of the obsolete outlet.
- 10) Protect the power cord from being walked on or pinched particularly at plugs, convenience receptacles, and the point where they exit from the apparatus.
- 11) Only use attachments/accessories specified by the manufacturer.

- 12) Use only with the cart, stand, tripod, bracket, or table specified by the manufacturer, or sold with the apparatus. When a cart is used, use caution when moving the cart/apparatus combination to avoid injury from tip-over.



- 13) Unplug this apparatus during lightning storms or when unused for long periods of time.
- 14) Refer all servicing to qualified service personnel. Servicing is required when the apparatus has been damaged in any way, such as power-supply cord or plug is damaged, liquid has been spilled or objects have fallen into the apparatus, the apparatus has been exposed to rain or moisture, does not operate normally, or has been dropped.

The following FCC statement applies only to the version of this model manufactured for sale in the U.S.A. Other versions may not comply with FCC technical regulations.

NOTE:

This equipment has been tested and found to comply with the limits for a Class B digital device, pursuant to Part 15 of the FCC Rules. These limits are designed to provide reasonable protection against harmful interference in a residential installation.

This equipment generates, uses and can radiate radio frequency energy and, if not installed and used in accordance with the instructions, may cause harmful interference to radio communications. However, there is no guarantee that interference will not occur in a particular installation. If this equipment does cause harmful interference to radio or television reception, which can be determined by turning the equipment off and on, the user is encouraged to try to correct the interference by one or more of the following measures:

- Reorient or relocate the receiving antenna.
- Increase the separation between the equipment and receiver.
- Connect the equipment into an outlet on a circuit different from that to which the receiver is connected.
- Consult the dealer or an experienced radio/TV technician for help.

CAUTION

You are cautioned that any changes or modifications not expressly approved in this manual could void your authority to operate this equipment.

To reduce the risk of electric shock, the speaker cord should be connected to the apparatus and the speakers in accordance with the following instructions.

- 1) Disconnect the AC power cord from the MAINS.
- 2) Strip 10 to 15 mm of the wire insulation of the speaker cord.
- 3) Connect the speaker cord to the apparatus and the speakers carefully so as not to touch the core of speaker cord by hand. Also disconnect the AC power cord from the MAINS before disconnecting the speaker cord from the apparatus and the speakers.

For customers in Australia



Disposal of Old Electrical & Electronic Equipment (Applicable in the European Union and other European countries with separate collection systems)

About This Manual

- The instructions in this manual are for model STR-DH710. Check your model number by looking at the lower right corner of the front panel. In this manual, models of area code U2 is used for illustration purposes unless stated otherwise. Any difference in operation is clearly indicated in the text, for example, “Models of area code U2 only”.
- The instructions in this manual describe the controls on the supplied remote. You can also use the controls on the receiver if they have the same or similar names as those on the remote.

About area codes

The area code of the receiver you purchased is shown on the lower right portion of the rear panel (see the illustration below).

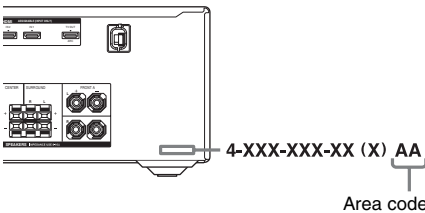

Any differences in operation, according to the area code, are clearly indicated in the text, for example, “Models of area code AA only”.

On Copyrights

This receiver incorporates Dolby* Digital and Pro Logic Surround and the DTS** Digital Surround System.

- * Manufactured under license from Dolby Laboratories. Dolby, Pro Logic, and the double-D symbol are trademarks of Dolby Laboratories.
- ** Manufactured under license under U.S. Patent #'s: 5,451,942; 5,956,674; 5,974,380; 5,978,762; 6,226,616; 6,487,535; 7,212,872; 7,333,929; 7,392,195; 7,272,567 & other U.S. and worldwide patents issued & pending. DTS is a registered trademark and the DTS logos, Symbol, DTS-HD and DTS-HD Master Audio are trademarks of DTS, Inc. © 1996-2008 DTS, Inc. All Rights Reserved.

This receiver incorporates High-Definition Multimedia Interface (HDMI™) technology. HDMI, the HDMI Logo, and High-Definition Multimedia Interface are trademarks or registered trademarks of HDMI Licensing LLC in the United States and other countries.

“x.v.Color (x.v.Colour)” and “x.v.Color (x.v.Colour)” logo are trademarks of Sony Corporation.

“BRAVIA” is a trademark of Sony Corporation.

“S-AIR” and its logo are trademarks of Sony Corporation.

“PLAYSTATION” is a trademark of Sony Computer Entertainment Inc.

Table of Contents

About This Manual.....	4
Supplied accessories.....	6
Description and location of parts.....	7

Connections

1: Installing the speakers	16
2: Connecting the speakers	19
3: Connecting the TV	21
4a: Connecting the audio components.....	22
4b: Connecting the video components	24
5: Connecting the antennas (aerials).....	31
6: Inserting the wireless transmitter/ transceiver.....	31
7: Connecting the AC power cord (mains lead)	32

Preparing the Receiver

Initializing the receiver.....	33
Selecting the speaker system	33
Calibrating the appropriate speaker settings automatically (AUTO CALIBRATION).....	34
Adjusting the speaker levels (TEST TONE)	40

Basic Operations

Playback	42
Viewing information on the display	43
Using the Sleep Timer	44
Recording	44

Tuner Operations

Listening to FM/AM radio	45
Presetting FM/AM radio stations	47
Using the Radio Data System (RDS)	49
(Models of area code AU1, TW2 only)	

Enjoying Surround Sound

Selecting the sound field.....	50
Enjoying the surround effect at low volume levels (NIGHT MODE)	54
Resetting sound fields to the initial settings	54

“BRAVIA” Sync Features

What is “BRAVIA” Sync?.....	55
Preparing for the “BRAVIA” Sync.....	55
Playing back components with one-touch operation (One-Touch Play).....	56
Enjoying the TV sound from the speakers connected to the receiver (System Audio Control).....	57
Turning off the receiver with the TV (System Power Off)	58
Enjoying movies with the optimum sound field (Theater/Theatre Mode Sync).....	59
Enjoying the TV sound via an HDMI cable (Audio Return Channel).....	59

S-AIR Operations

About S-AIR products	60
Setting up an S-AIR product.....	61
Enjoying the system’s sound in another room	64
Changing the channel for better sound transmission	65
Stabilizing S-AIR reception.....	66
Enjoying the S-AIR receiver while the S-AIR main unit is in standby mode.....	67

Advanced Operations

Switching between digital and analog audio (INPUT MODE)	68
Enjoying the sound/images from other inputs	68
Enjoying sound/images from the components connected to the DIGITAL MEDIA PORT	70
Using a bi-amplifier connection	70
Using the setting menu	71

Using the Remote

Changing the input button assignments	84
Clearing all the contents of the remote's memory	85

Additional Information

Glossary	85
Precautions	88
Troubleshooting	90
Specifications	96
Index	98

Supplied accessories

- Operating Instructions (this manual)
- Quick Setup Guide
- FM wire antenna (aerial) (1)



- AM loop antenna (aerial) (1)



- Remote commander (1)
 - RM-AAU073 (Models of area code U2, CA2 only)
 - RM-AAU075 (Models of area code AU1, TW2 only)

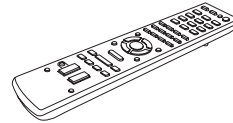

- R6 (size-AA) batteries (2)



- Optimizer microphone (ECM-AC2) (1)

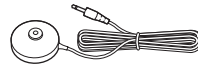

Description and location of parts

Front panel

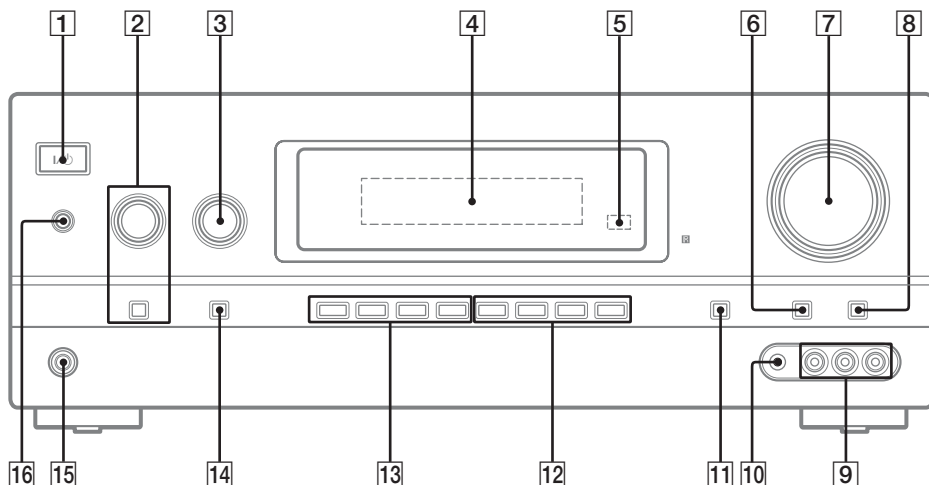

1 I/⏻ (on/standby) (page 33, 47, 54)

2 TONE +/-, TONE MODE (page 80)

3 INPUT SELECTOR (page 42 - 44, 46 - 48, 68, 70)

4 Display (page 8)

5 Remote sensor
Receives signals from remote commander.

6 DIMMER (page 83)

7 MASTER VOLUME (page 41, 42)

8 MUTING (page 42)

9 VIDEO 2 IN jacks (page 30)

10 AUTO CAL MIC jack (page 35)

11 DISPLAY (page 43)

12 2CH/A.DIRECT, A.F.D., MOVIE, MUSIC
(page 50)

13 TUNING MODE, TUNING +/-, MEMORY/
ENTER (page 45)

14 INPUT MODE (page 68)

15 PHONES jack (page 90)

16 SPEAKERS (page 33)

Indicators on the display

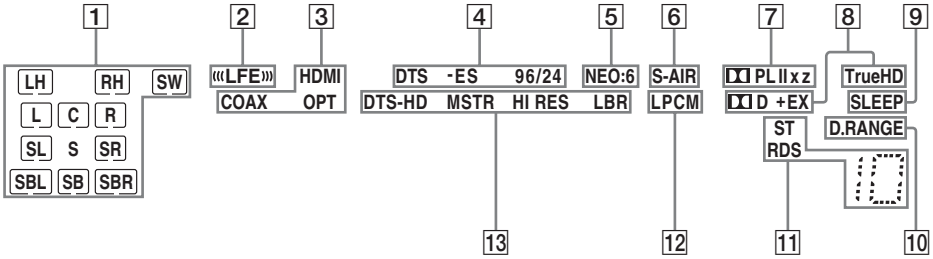

Indicator and explanation

1 Playback channel indicators

The letters (L, C, R, etc.) indicate the channels being played back. The boxes around the letters vary to show how the receiver downmixes or upmixes the source sound (based on the speaker settings).

SW	Subwoofer
LH	Front Left High
RH	Front Right High
L	Front Left
R	Front Right
C	Center (monaural)
SL	Surround Left
SR	Surround Right
S	Surround (monaural or the surround components obtained by Pro Logic processing)
SBL	Surround Back Left
SBR	Surround Back Right
SB	Surround Back (the surround back components obtained by 6.1 channel decoding)

Example:

Speaker pattern: 3/0.1
 Recording format: 3/2.1
 Sound Field: A.F.D. AUTO



Indicator and explanation

2 «LFE»

Lights up when the disc being played back contains an LFE (Low Frequency Effect) channel and the LFE channel signal is actually being reproduced.

3 Input indicators

Light up to indicate the current input.

HDMI

Lights up when
 – the receiver recognizes a component connected via an HDMI IN jack (page 24).
 – TV input detected Audio Return Channel (ARC) signals (page 59).

COAX

Lights up when INPUT MODE is set to “AUTO” and the source signal is a digital signal being input through the COAXIAL jack (page 68).

OPT

Lights up when INPUT MODE is set to “AUTO” and the source signal is a digital signal being input through the OPTICAL jack (page 68).

Indicator and explanation

4 DTS(-ES) indicators

Light up when DTS or DTS-ES signals are input.

DTS

Lights up when the receiver is decoding DTS signals.

DTS-ES

Lights up when the receiver is decoding DTS-ES signals.

DTS 96/24

Lights up when the receiver is decoding DTS 96 kHz/24 bit signals.

Note

When playing a DTS format disc, be sure that you have made digital connections and that INPUT MODE is set to "AUTO" (page 68).

5 NEO:6





Lights up when DTS Neo:6 Cinema/Music decoder is activated (page 51).

6 S-AIR

Lights up when the S-AIR transmitter (not supplied) is connected.

7 Dolby Pro Logic indicators

Lights up one of the respective indicators when the receiver performs Dolby Pro Logic processing. This matrix surround decoding technology can enhance input signals.

	PL	Dolby Pro Logic
	PL II	Dolby Pro Logic II
	PL IIx	Dolby Pro Logic IIx
	PL IIz	Dolby Pro Logic IIz





Note

These indicators may not light up depending on the speaker pattern setting.

Indicator and explanation

8 Dolby Digital Surround indicators

Lights up one of the respective indicators when the receiver is decoding the corresponding Dolby Digital format signals.

	D	Dolby Digital
	D EX	Dolby Digital Surround EX
	D+	Dolby Digital Plus
	TrueHD	Dolby TrueHD

Note

When playing a Dolby Digital format disc, be sure that you have made digital connections and that INPUT MODE is set to "AUTO" (page 68).

9 SLEEP

Lights up when the sleep timer is activated (page 44).

10 D.RANGE

Lights up when dynamic range compression is activated (page 76).

11 Tuning indicators

Lights up when the receiver tunes in radio stations.

ST

Stereo broadcast

RDS (Models of area code AU1, TW2 only)

A station that provides RDS services is tuned in.



Preset station number

Note

The preset station number will change according to the preset station you select. For details on presetting radio stations, see page 48.

12 LPCM

Lights up when Linear PCM signals are detected.

13 DTS-HD indicators

Lights up one of the respective indicators when the receiver is decoding the corresponding DTS-HD format signals.

DTS-HD MSTR

DTS-HD Master Audio

DTS-HD HI RES

DTS-HD High Resolution Audio

DTS-HD LBR

DTS-HD Low Bit Rate Audio

Rear panel

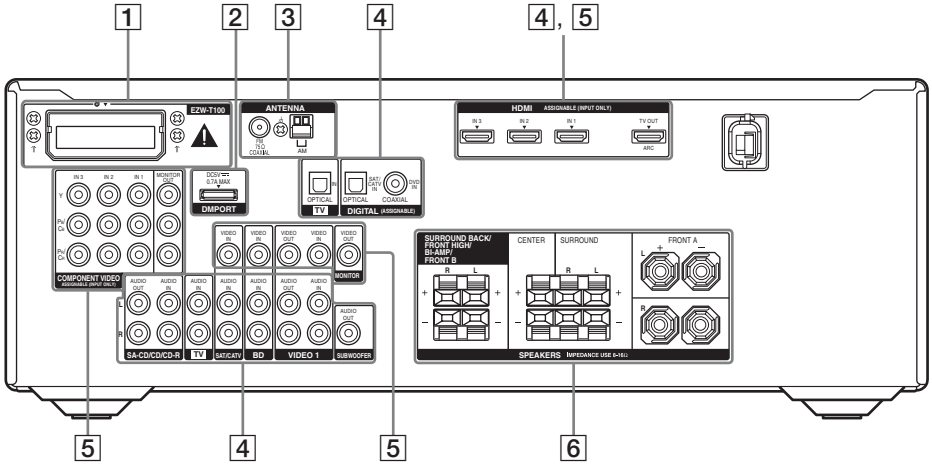

1 S-AIR section (page 31)



2 DMPORT section (page 70)



3 ANTENNA section (page 31)



4 Audio signal section

DIGITAL INPUT/OUTPUT jacks (page 21, 24, 27, 28, 29)



ANALOG INPUT/OUTPUT jacks (page 19, 21, 22, 27, 29)

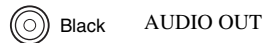
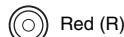
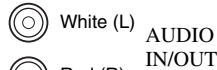



5 Video signal section*

The image quality depends on the connecting jack.

DIGITAL INPUT/OUTPUT jacks (page 21, 24)

 HDMI IN/OUT

COMPONENT VIDEO INPUT/OUTPUT jacks (page 21, 27, 28, 29)

 Green (Y) Y, Pb/Cb, Pr/Cr IN/OUT
 Blue (Pb/Cb)
 Red (Pr/Cr)

COMPOSITE VIDEO INPUT/OUTPUT jacks (page 21, 27, 29, 30)

 Yellow VIDEO IN/OUT



High quality image

6 SPEAKERS section (page 19)

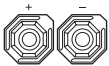

* You can watch the selected input image when you connect the HDMI TV OUT or MONITOR OUT jack to a TV (page 21, 24).

Remote commander

You can use the supplied remote RM-AAU073 (Models of area code U2, CA2 only) or RM-AAU075 (Models of area code AU1, TW2 only) to operate the receiver and to control the Sony audio/video components that the remote is assigned to operate.

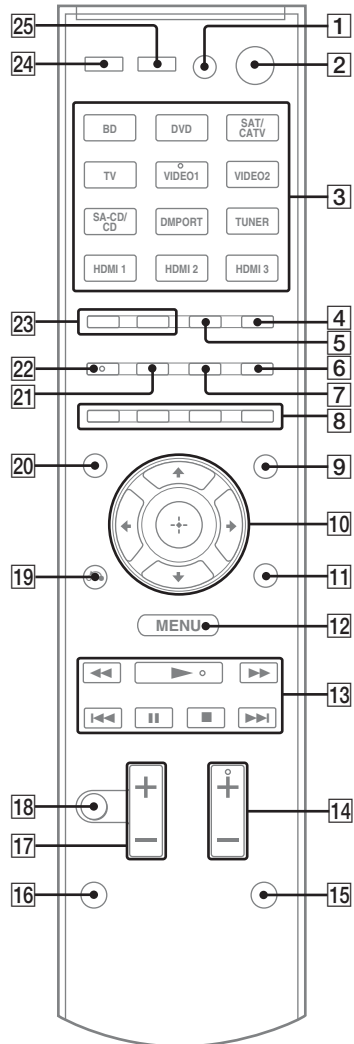

continued

Notes on using the SHIFT (15) and TV (16) button

SHIFT (15) button

Press and hold SHIFT (15), then press the button with pink printing that you want to use.
Example: Press and hold SHIFT (15), then press ENTER (3).

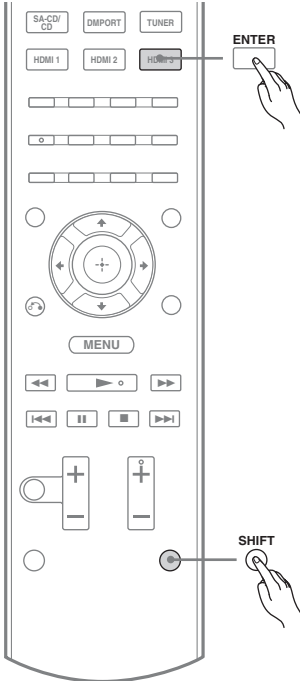

TV (16) button

Press and hold TV (16), then press the button with yellow printing to control the TV.
Example: Press and hold TV (16), then press TV CH + (RM-AAU073 only) or PROG + (RM-AAU075 only) (14).

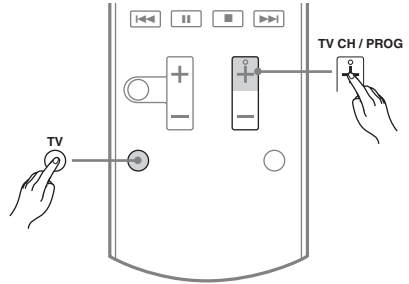

To control the receiver

Name and function

2 I/⏻^{b)} (on/standby)

Turns the receiver on or sets it to standby mode.

Saving the power in standby mode

When "CTRL.HDMI" is set to "CTRL OFF" (page 75) and "STANDBY" is set to "STBY OFF" (page 75).

3 Input buttons (VIDEO 1^{a)})

Selects the component you want to use. When you press any of the input buttons, the receiver turns on. The buttons are initial assigned to control Sony components.

Numeric buttons^{c)} (number 5^{a)})

Presets or tunes to preset stations.

ENTER^{c)}

Enters the selections.

4 D.TUNING

Enters direct tuning mode.

5 MEMORY

Stores a station during tuner operation.











6 DISPLAY

Views information on the display.

9 AMP MENU

Displays the menu to operate the receiver.

Name and function

10  ,  /  /  / 
Press  /  /  /  to select the settings, then press  to enter the selection.



12 **MENU/HOME^{d)}**
Displays the menu to operate the receiver.

13 **TUNING +/-**
Scans a station.





PRESET +/-
Selects preset stations.

14 **SOUND FIELD +^{a)}/-**
Selects a sound field.

17 **MASTER VOL +/- (RM-AAU073 only)**
 +/- (RM-AAU075 only)
Adjust the volume level of all speakers at the same time.

18 **MUTING (RM-AAU073 only)**
 (RM-AAU075 only)
Turns off the sound temporarily.
Press MUTING/ again to restore the sound.

19 **RETURN/EXIT **
Returns to the previous menu.

- ^{a)}The following buttons have tactile dots:
- RM-AAU073: 5/VIDEO 1, AUDIO,  and TV CH +/SOUND FIELD +
 - RM-AAU075: 5/VIDEO 1, ,  and PROG +/SOUND FIELD +/

Use the tactile dots as references when operating the receiver.

- ^{b)}If you press AV I/⏻ (**1**) and I/⏻ (**2**) simultaneously, the receiver and connected components will turn off (SYSTEM STANDBY).

^{c)}Press and hold SHIFT (**15**) then press this button.

^{d)}Press AMP MENU (**9**) to activate this button.

To control a Sony TV

Press and hold TV (**16**) and then press the yellow printing button to select the function you want.

Name and function

1 **TV I/⏻ (on/standby)**
Turns the TV on or off.

3 **Numeric buttons (number 5^{a)})**
Selects the TV channels.

ENTER (RM-AAU073 only)

Enters the selections.

 (Previous channel) (RM-AAU075 only)

Returns to the previous channel watched (for more than five seconds).

 (Text) (RM-AAU075 only)

Displays text.

6 **DISPLAY (RM-AAU073 only)**

Displays the information of TV.

 (Info/Text reveal) (RM-AAU075 only)

In digital mode: Displays brief details of the program currently being watched.

In analog mode: Displays information such as current channel number and screen format.

In text mode: Reveals hidden information (e.g. answers to a quiz).

8 **Color buttons**

Displays an operation guide on the TV screen when the color buttons are available. Follow the operation guide to perform a selected operation.

11 **TOOLS/OPTIONS**

Displays the TV options.

12 **MENU/HOME**



Displays the TV menus.

14 **TV CH +^{a)}/- (RM-AAU073 only)**

Selects the next (+) or previous (-) channel.

PROG +^{a)}/-, / (RM-AAU075 only)

In TV mode: Selects the next (+) or previous (-) channel.

In text mode: Selects the next () or previous () channel.

17 **TV VOL +/- (RM-AAU073 only)**

 +/- (RM-AAU075 only)

Adjusts the volume.

18 **MUTING (RM-AAU073 only)**

 (RM-AAU075 only)

Activates the TV's muting function.

continued

Name and function

19 RETURN/EXIT 

Returns to the previous TV menu.

20 GUIDE (RM-AAU073 only)

 **(RM-AAU075 only)**

Displays the guide when you are watching analog or digital channel.

22 AUDIO^{a)} (RM-AAU073 only)

 **(RM-AAU075 only)**

Selects the desired audio signal.

23 DIGITAL (RM-AAU075 only)

Changes to digital mode.

ANALOG (RM-AAU075 only)

Changes to analog mode.

24 THEATER (RM-AAU073 only)

THEATRE (RM-AAU075 only)

Sets the optimal picture settings automatically for watching movies when you connect a Sony TV that is compatible with the THEATER/ THEATRE button function (page 59).

25 INPUT (RM-AAU073 only)

Selects the input signal (TV or video).





 /  **(Input select/Text hold)**

(RM-AAU075 only)

In TV mode: Selects the input signal (TV or video).













In analog text mode: Holds the current page.

^{a)}The following buttons have tactile dots.





- RM-AAU073: 5/VIDEO 1, AUDIO,  and TV CH +/SOUND FIELD +
- RM-AAU075: 5/VIDEO 1, ,  and PROG +/SOUND FIELD +/

Use the tactile dots as references when operating the receiver.

To control other Sony components

Name	Blu-ray disc, DVD player	Satellite tuner, cable TV tuner	VCR	CD player
1 AV I/⏻ ^{b)}	Power	Power	Power	Power
3 Numeric buttons^{c)} (number 5 ^{a)})	Track	Channel	Channel	Track
ENTER ^{c)}	Enter	Enter ^{d)}	Enter	Enter
CLEAR ^{c)}	Clear	Clear	–	–
6 DISPLAY	Display	Display	Display	Display
7 ANGLE^{d)}  ^{e)}	Select angle	–	–	–
8 Color buttons	Menu, guide	Menu, guide ^{e)}	–	–
10 	Enter	Enter	Enter	–
	Select	Select	Select	–
11 TOOLS/OPTIONS	Options menu	Options menu ^{d)}	–	–
12 MENU/HOME	Menu	Menu	Menu	–
13  ^{f)}	Search forward, backward	–	Fast forward, rewind	Fast forward, rewind
 ^{a)f)}	Play	–	Play	Play
 ^{f)}	Skip track	–	Skip track	Skip track
 ^{f)}	Pause	–	Pause	Pause
 ^{f)}	Stop	–	Stop	Stop
19 RETURN/ EXIT 	Exit menu	Exit menu, Live TV ^{d)}	–	–
20 GUIDE^{d)}  ^{e)}	Program schedule	Display guide menu	–	–
21 SUBTITLE^{d)}  ^{e)}	Select subtitle	–	–	–
22 AUDIO^{a)d)}  ^{e)}	Select audio	–	–	–
23 TOP MENU	On-screen guide	–	–	–
POP UP/MENU	Menu	–	–	–

a) The following buttons have tactile dots.

- RM-AAU073: 5/VIDEO 1, AUDIO,  and TV CH +/SOUND FIELD +
- RM-AAU075: 5/VIDEO 1, ,  and PROG +/SOUND FIELD +/

Use the tactile dots as references when operating the receiver.

b) If you press AV I/⏻ (1) and I/⏻ (2) simultaneously, the receiver and connected components will turn off (SYSTEM STANDBY). The function of the AV I/⏻ (1) changes automatically each time you press the input buttons (3).

c) Press and hold SHIFT (15) then press this button.

d) RM-AAU073 only.

e) RM-AAU075 only.

f) This button is also available for DIGITAL MEDIA PORT adapter operation. For details on the function of the button, refer to the operating instructions supplied with the DIGITAL MEDIA PORT adapter.

Notes

- Some functions explained in this section may not work depending on the model.
- The above explanation is intended to serve as an example only. Therefore, depending on the component, the above operation may not be possible or may operate differently than described.

continued

Inserting batteries into the remote

Insert two R6 (size-AA) batteries in the RM-AAU073 (Models of area code U2, CA2 only) or RM-AAU075 (Models of area code AU1, TW2 only) Remote Commander. Observe the correct polarity when installing batteries.

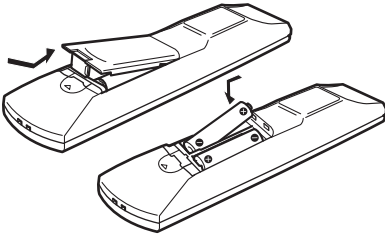

Notes

- Do not leave the remote in an extremely hot or humid place.
- Do not use a new battery with old ones.
- Do not mix manganese batteries and other kinds of batteries.
- Do not expose the remote sensor to direct sunlight or lighting apparatuses. Doing so may cause a malfunction.
- If you do not intend to use the remote for an extended period of time, remove the batteries to avoid possible damage from battery leakage and corrosion.
- When you replace the batteries, the remote buttons may be reset to their initial settings. If this happens, reassign the button again (page 84).
- When the remote no longer operates the receiver, replace all the batteries with new ones.

Connections

1: Installing the speakers

This receiver allows you to use a 7.1 channel system (7 speakers and one subwoofer).

To fully enjoy theater-like multi channel surround sound requires five speakers (two front speakers, a center speaker, and two surround speakers) and a subwoofer (5.1 channel).

You can enjoy high fidelity reproduction of DVD software recorded sound in the Surround EX format if you connect additional one surround back speaker (6.1 channel) or two surround back speakers (7.1 channel).

You can enjoy vertical sound effects if you connect additional two front high speakers (7.1 channel) in PLIIz mode (page 51).

Example of speaker system configuration

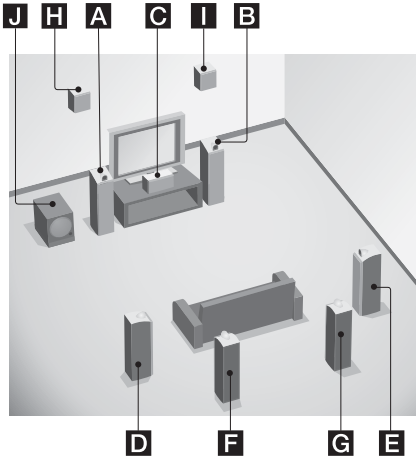

- A** Front speaker (Left)
- B** Front speaker (Right)
- C** Center speaker
- D** Surround speaker (Left)
- E** Surround speaker (Right)
- F** Surround back speaker (Left)
- G** Surround back speaker (Right)
- H** Front high speaker (Left)
- I** Front high speaker (Right)
- J** Subwoofer

Note

You cannot use the surround back speakers and the front high speakers simultaneously.

Tips

- When you connect a 7.1 channel speaker system with two surround back speakers, all angle **A** should be the same.

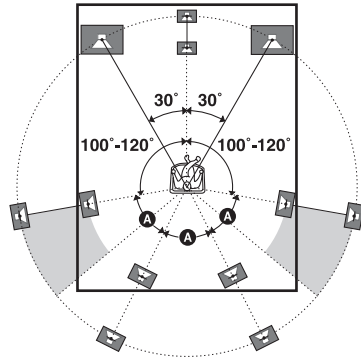

- When you connect a 7.1 channel speaker system with two front high speakers, place the front high speakers at an angle between 22° to 45° . Position the front high speakers at least 3.3 feet (1 meter) directly above the front speakers.

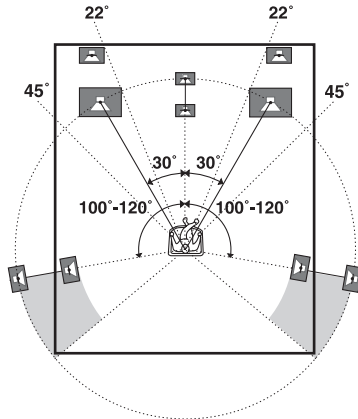

- When you connect a 6.1 channel speaker system, place the surround back speaker behind the listening position.

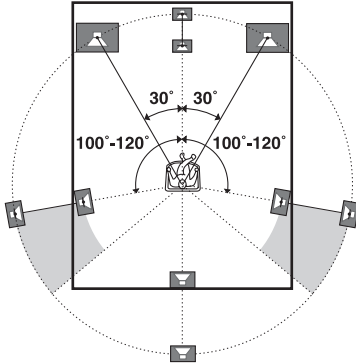

- Since the subwoofer does not emit highly directional signals, you can place it wherever you want.

2: Connecting the speakers

Before connecting the cords, be sure to disconnect the AC power cord (mains lead).

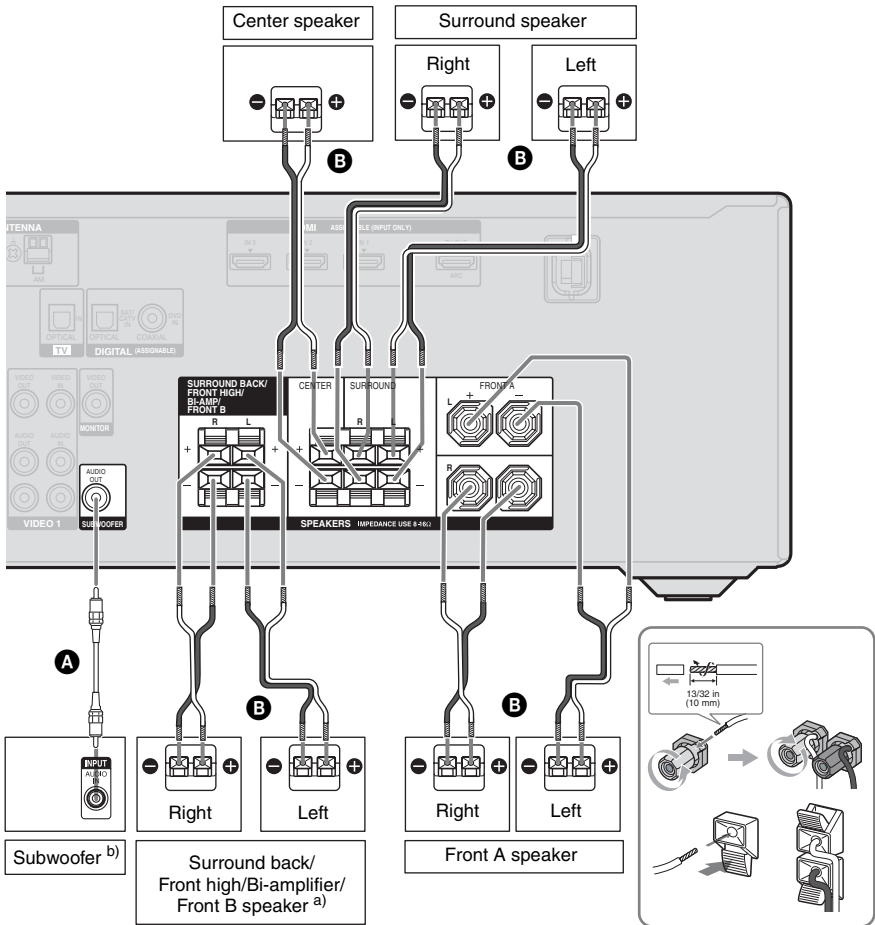

- A** Monaural audio cord (not supplied)
- B** Speaker cord (not supplied)

a) Notes on the SPEAKERS SURROUND BACK/FRONT HIGH/BI-AMP/FRONT B terminals connection.

- If you connect only one surround back speaker, connect it to the L of this terminals.
- If you are not using surround back speaker or front high speakers, and you have an additional front speaker system, connect the additional front speaker system to this terminals. Set “SB ASGN” to “SPK B” in the SPEAKER menu (page 79). You can select the front speaker system you want to use with the SPEAKERS button on the receiver (page 33).
- If you are not using surround back speaker or front high speakers, you can connect the front speakers to this terminals using bi-amplifier connection (page 20).

b) When you connect a subwoofer with an auto standby function, turn off the function when watching movies. If the auto standby function is set to on, it turns to standby mode automatically based on the level of the input signal to a subwoofer, then sound may not be output.

Notes

- Before connecting the AC power cord (mains lead), make sure that metallic wires of the speaker cords are not touching each other between the SPEAKERS terminals.
- After you have install and connect your speaker, be sure to select the speaker pattern from SPEAKER menu (page 77).

Bi-amplifier connection

If you are not using surround back speakers or front high speakers, you can connect the front speakers to the SPEAKERS SURROUND BACK/FRONT HIGH/BI-AMP/FRONT B terminals using a bi-amplifier connection.

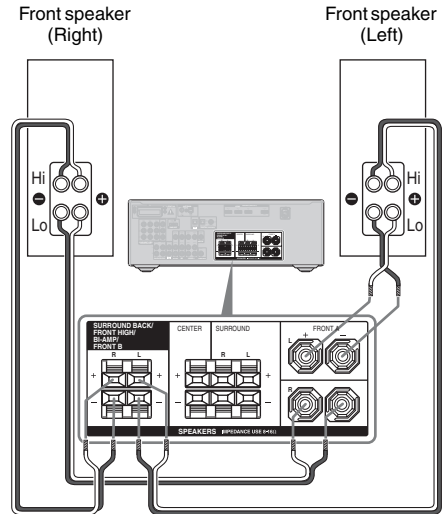

Connect the jacks on the Lo (or Hi) side of the front speakers to the SPEAKERS FRONT A terminals, and connect the jacks on the Hi (or Lo) side of the front speakers to the SPEAKERS SURROUND BACK/FRONT HIGH/BI-AMP/FRONT B terminals. Make sure that metal fittings of Hi/Lo attached to the speakers have been removed from the speakers. Not doing so may cause a malfunction of the receiver. After you have made the bi-amplifier connection, set “SB ASGN” to “BI-AMP” in the SPEAKER menu (page 70).

3: Connecting the TV

Before connecting cords, be sure to disconnect the AC power cord (mains lead).

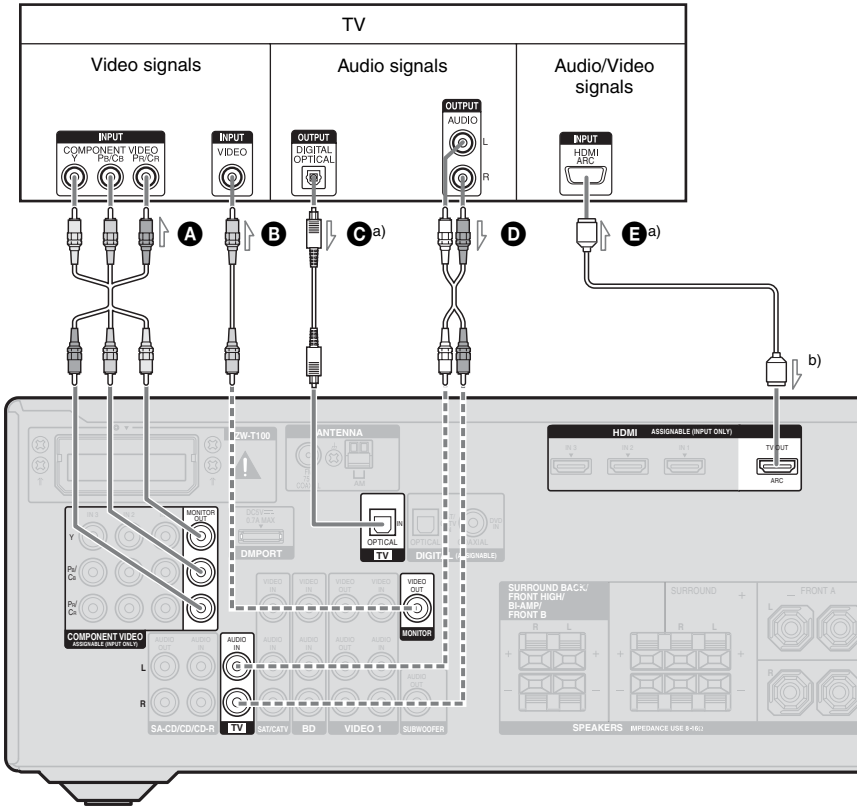

- A** Component video cord (not supplied)
- B** Video cord (not supplied)
- C** Optical digital cord (not supplied)
- D** Audio cord (not supplied)
- E** HDMI cable (not supplied)

We recommend that you use a Sony HDMI cable.

- Recommended connection
- - - - Alternative connection

- a) To enjoy TV multi channel surround sound broadcasting from the speakers connected to the receiver, connect either **C** or **E**. Be sure to turn off the TV's volume or activate the TV's muting function.
- b) If your TV is compatible with the Audio Return Channel (ARC) function, the TV sound will output from the speakers connected to the receiver via HDMI TV OUT connection. In this case, set "ARC" to "ARC ON" in HDMI menu (page 59).

Notes

- Be sure to turn on the receiver when the video and audio signals of a playback component are being output to a TV via the receiver. Unless the power is turned on, neither video nor audio signals will be transmitted.
- Connect image display components such as a TV monitor or a projector to the HDMI TV OUT or MONITOR OUT jack on the receiver. You may not be able to record even if you connect recording components.
- Depending on the status of the connection between the TV and the antenna (aerial), the image on the TV screen may be distorted. In this case, place the antenna (aerial) farther away from the receiver.
- When connecting optical digital cords, insert the plugs straight in until they click into place.
- Do not bend or tie optical digital cords.

Tip

All the digital audio jacks are compatible with 32 kHz, 44.1 kHz, 48 kHz, and 96 kHz sampling frequencies.

4a: Connecting the audio components

The following illustration shows how to connect a Super Audio CD player, CD player, CD recorder and DIGITAL MEDIA PORT adapter. Before connecting cords, be sure to disconnect the AC power cord (mains lead).

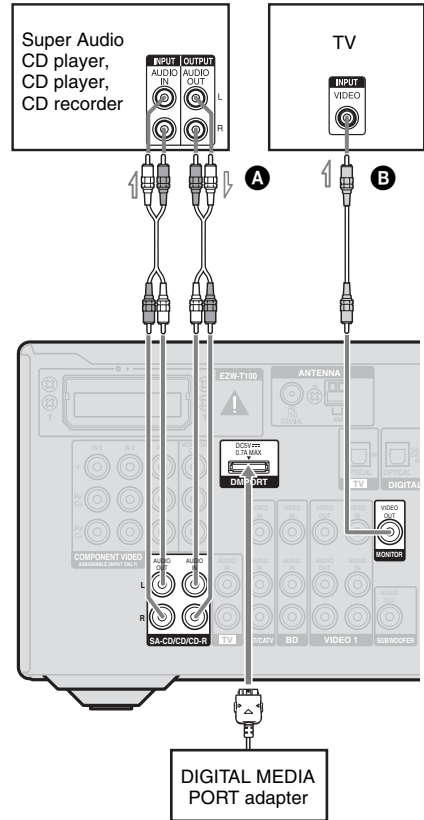

- Ⓐ Audio cord (not supplied)
- Ⓑ Video cord (not supplied)

Notes on connecting DIGITAL MEDIA PORT adapter

- Do not connect an adapter other than the DIGITAL MEDIA PORT adapter.
- Do not connect or disconnect the DIGITAL MEDIA PORT adapter while the receiver is turned on.
- When connecting the DIGITAL MEDIA PORT adapter, be sure the connector is inserted with the arrow mark facing towards the arrow mark on the DMPORT jack.
- Be sure to make DMPORT connections firmly, insert the connector straight in.
- As the connector of the DIGITAL MEDIA PORT adapter is fragile, be sure to handle with care when placing or moving the receiver.

To detach the DIGITAL MEDIA PORT adapter from DMPORT jack

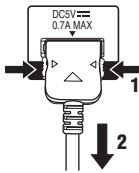

Press and hold both sides of the connector and then pull out the connector.

4b: Connecting the video components

Components to be connected

Connect your video components according to the table below.

Component	Page
Blu-ray disc player*	24, 27
“PlayStation 3”*	24
DVD player*	24, 28
DVD recorder*	24, 28, 30
Satellite tuner*, cable TV tuner*	24, 29
VCR	30
Camcorder, video game, etc.	30

* We recommend that you connect your video components via HDMI connection if they have HDMI jacks.

You can watch the selected input image when you connect the HDMI TV OUT or MONITOR OUT jack to a TV (page 21).

If you want to connect several digital components, but cannot find an unused input

See “Enjoying the sound/images from other inputs” (page 68).

Notes

- Before connecting cords, be sure to disconnect the AC power cord (mains lead).
- It is not necessary to connect all the cords. Connect according to the availability of jacks on the connected components.
- Be sure to turn on the receiver when the video and audio signals of a playback component are being output to a TV via the receiver. Unless the power is turned on, neither video nor audio signals will be transmitted.
- When connecting optical digital cords, insert the plugs straight in until they click into place.
- Do not bend or tie optical digital cords.

Tip

All the digital audio jacks are compatible with 32 kHz, 44.1 kHz, 48 kHz, and 96 kHz sampling frequencies.

Connecting components with HDMI jacks

HDMI is the abbreviated name for High-Definition Multimedia Interface. It is an interface which transmits video and audio signals in digital format.

HDMI features

- A digital audio signals transmitted by HDMI can be output from the speakers connected to the receiver. This signal supports Dolby Digital, DTS, and Linear PCM.
- This receiver can receive multi channel Linear PCM (up to 8 channels) with a sampling frequency of 192 kHz or less with an HDMI connection.
- This receiver supports High Bitrate Audio (DTS-HD Master Audio, Dolby TrueHD) and HDMI (Deep Color (Deep Colour), x.v.Color (x.v.Colour)).
- This receiver supports the Control for HDMI function. For details, see ““BRAVIA” Sync Features” (page 55).

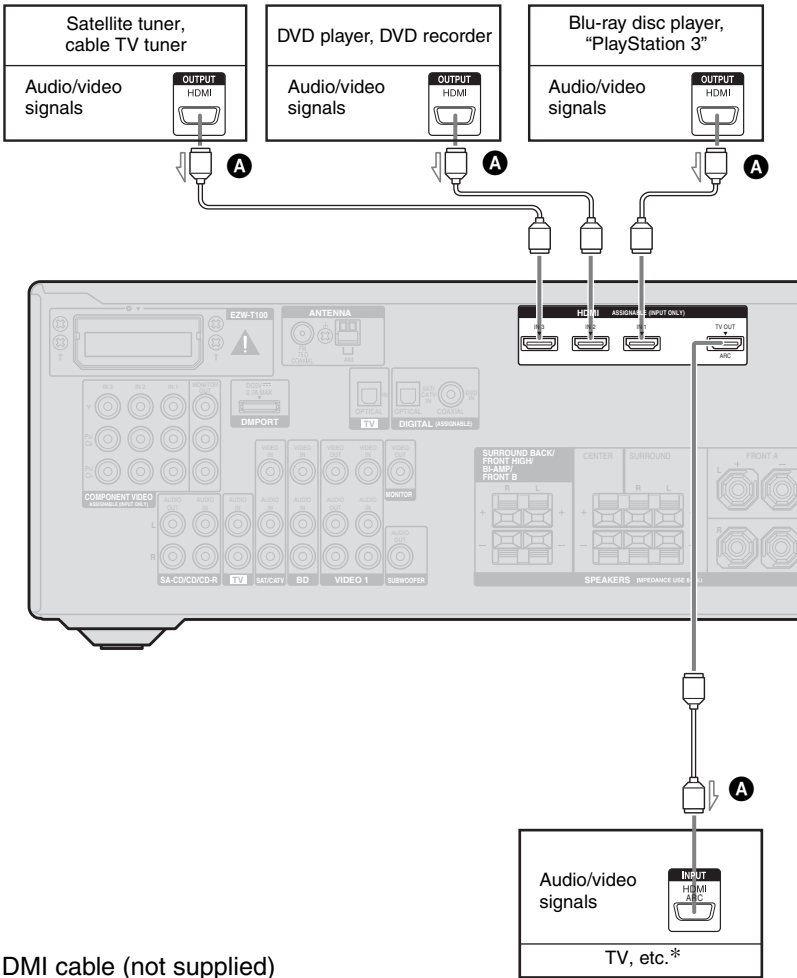

A HDMI cable (not supplied)
 We recommend that you use a Sony HDMI cable.

* See page 21 for the audio connection of TV to the receiver.

Notes

- Be sure to change the initial setting of the HDMI 1-3 input button on the remote so that you can use the button to control your components. For details, see “Changing the input button assignments” (page 84).
- You can also rename the HDMI input so that it can be displayed on the receiver’s display. For details, see “Naming inputs” (page 43).

Notes on connecting cables

- Use a High Speed HDMI cable. If you use a Standard HDMI cable, 1080p or Deep Color (Deep Colour) images may not be displayed properly.
- Sony recommends that you use an HDMI authorized cable or Sony HDMI cable.
- We do not recommend using an HDMI-DVI conversion cable. When you connect an HDMI-DVI conversion cable to a DVI-D component, the sound and/or the image may not be output. Connect other audio cords or digital connecting cords, then set “A. ASSIGN” in AUDIO menu (page 81) when the sound is not output correctly.

Notes on HDMI connections

- An audio signal input to the HDMI IN jack is output from the SPEAKERS jacks and HDMI TV OUT jack. It is not output from any other audio jacks.
- Video signals input to the HDMI IN jack can only be output from the HDMI TV OUT jack. The video input signals cannot be output from the VIDEO OUT jacks or MONITOR OUT jacks.
- When you want to listen to the sound from the TV speaker, set “AUDIO.OUT” to “TV+AMP” in the HDMI menu (page 82). If you cannot play back multi channel software, set to “AMP”. However, the sound will not output from the TV speaker.
- Be sure to turn on the receiver when video and audio signals of a playback component are being output to a TV through this receiver. If you set “PASS.THROUGH” to “OFF”, video and audio signals will not be transmitted when the power is set to off.
- DSD signals of Super Audio CD are not input and output.
- The multi/stereo area audio signals of a Super Audio CD are not output.

- Audio signals (sampling frequency, bit length, etc.) transmitted from an HDMI jack may be suppressed by the connected component. Check the setup of the connected component if the image is poor or the sound does not come out of a component connected via the HDMI cable.
- Sound may be interrupted when the sampling frequency, the number of channels or audio format of audio output signals from the playback component is switched.
- When the connected component is not compatible with copyright protection technology (HDCP), the image and/or the sound from the HDMI TV OUT jack may be distorted or may not be output. In this case, check the specification of the connected component.
- Set the image resolution of the player to more than 720p/1080i to enjoy High Bitrate Audio (DTS-HD Master Audio, Dolby TrueHD).
- The image resolution of player may need certain settings be made before you can enjoy multi channel Linear PCM. Refer to the operating instructions of the player.
- Not every HDMI component supports all functions that are defined by the specified HDMI version. For example, components that support HDMI, version 1.4, may not support Audio Return Channel (ARC).
- Refer to the operating instructions of each connected component for details.

Connecting a Blu-ray disc player

The following illustration shows how to connect a Blu-ray disc player.

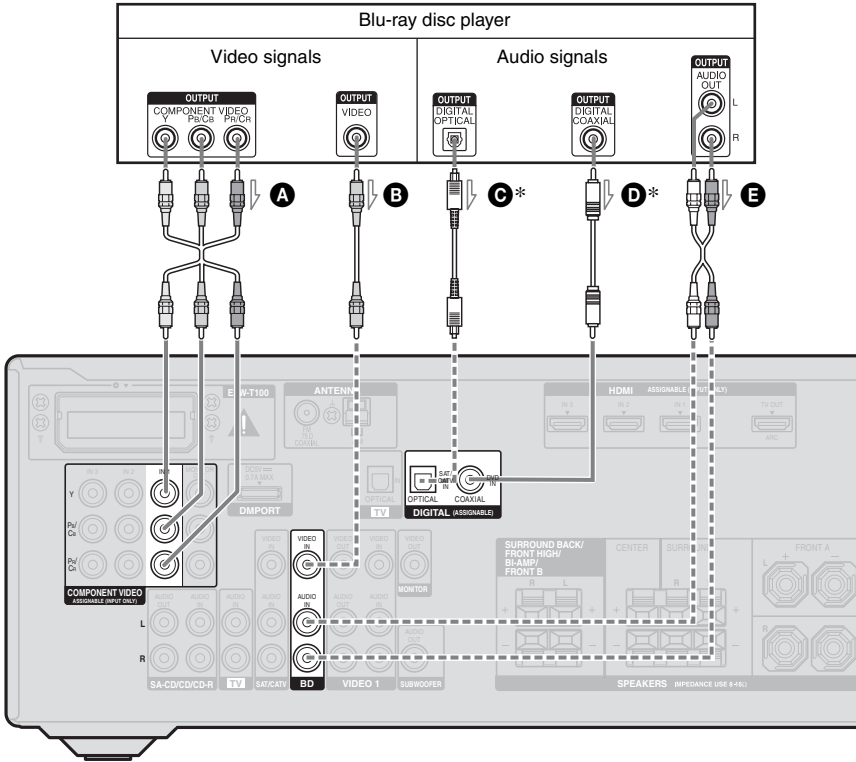

- A** Component video cord (not supplied)
- B** Video cord (not supplied)
- C** Optical digital cord (not supplied)
- D** Coaxial digital cord (not supplied)
- E** Audio cord (not supplied)

— Recommended connection
 - - - Alternative connection

* When you connect a component equipped with a OPTICAL/COAXIAL jack, set “A. ASSIGN” in the AUDIO menu (page 81).

Notes

- The initial setting of the COMPONENT VIDEO IN 1 jacks are Blu-ray disc player. If you want to connect your Blu-ray disc player to the COMPONENT VIDEO IN 2 or IN 3 jacks, set “V. ASSIGN” in the VIDEO menu (page 81).
- To input multi channel digital audio from the Blu-ray disc player, set the digital audio output setting on the Blu-ray disc player. Refer to the operating instructions supplied with the Blu-ray disc player.

Connecting a DVD player, DVD recorder

The following illustration shows how to connect a DVD player or DVD recorder.

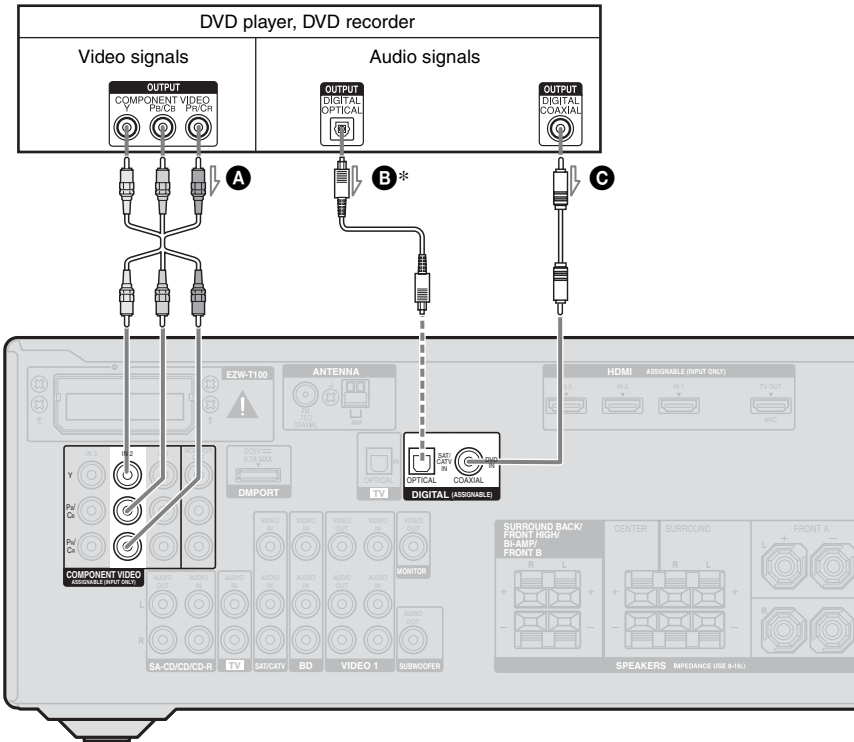

- A** Component video cord (not supplied)
- B** Optical digital cord (not supplied)
- C** Coaxial digital cord (not supplied)

- Recommended connection
- - - - Alternative connection

* When you connect a component equipped with an OPTICAL jack, set "A. ASSIGN" in the AUDIO menu (page 81).

Notes

- The initial setting for the DVD input button is as follows:
 - RM-AAU073: DVD player
 - RM-AAU075: DVD recorder
 Be sure to change the initial setting of the DVD input button on the remote so that you can use the button to control your DVD player or DVD recorder. For details, see "Changing the input button assignments" (page 84).
- You can also rename the DVD input so that it can be displayed on the receiver's display. For details, see "Naming inputs" (page 43).
- The initial setting of the COMPONENT VIDEO IN 2 jacks are DVD player or DVD recorder. If you want to connect your DVD player or DVD recorder to the COMPONENT VIDEO IN 1 or IN 3 jacks, set "V. ASSIGN" in the VIDEO menu (page 81).
- To input multi channel digital audio from the DVD player or DVD recorder, set the digital audio output setting on the DVD player or DVD recorder. Refer to the operating instructions supplied with the DVD player or DVD recorder.

Connecting a satellite tuner, cable TV tuner

The following illustration shows how to connect a satellite tuner or cable TV tuner.

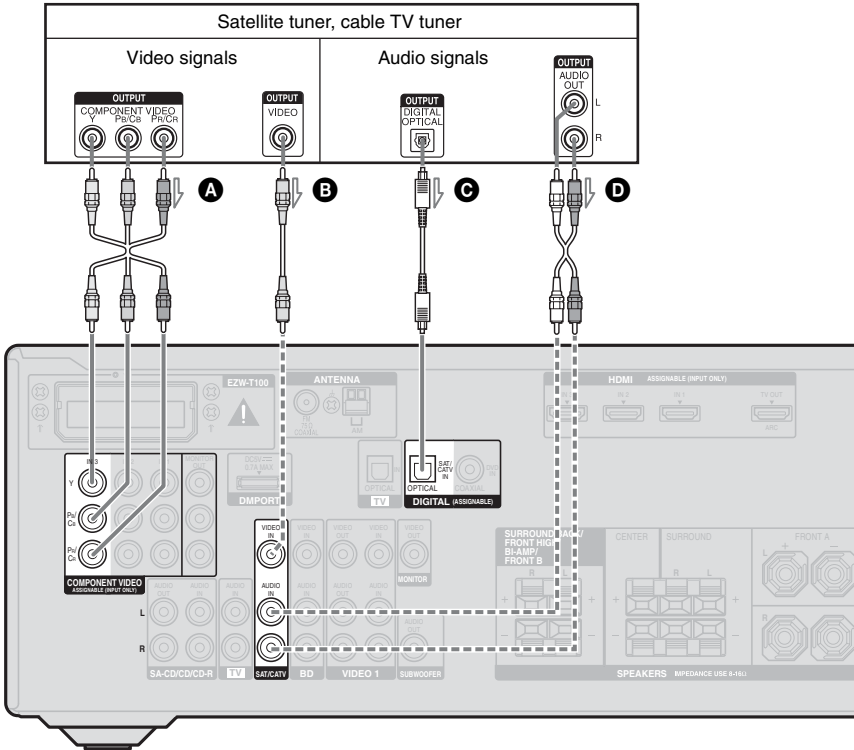

- A** Component video cord (not supplied)
- B** Video cord (not supplied)
- C** Optical digital cord (not supplied)
- D** Audio cord (not supplied)

— Recommended connection
 - - - - Alternative connection

Note

The initial setting of the COMPONENT VIDEO IN 3 jacks are satellite tuner or cable TV tuner. If you want to connect your satellite tuner or cable TV tuner to the COMPONENT VIDEO IN 1 or IN 2 jacks, set “V. ASSIGN” in the VIDEO menu (page 81).

Connecting components with analog video and audio jack

The following illustration shows how to connect a component which has analog jacks such as a VCR, DVD recorder, etc.

Notes

- Be sure to change the initial setting of the VIDEO 1 input button on the remote so that you can use the button to control your DVD recorder. For details, see “Changing the input button assignments” (page 84).
- You can also rename the VIDEO 1 input so that it can be displayed on the receiver’s display. For details, see “Naming inputs” (page 43).

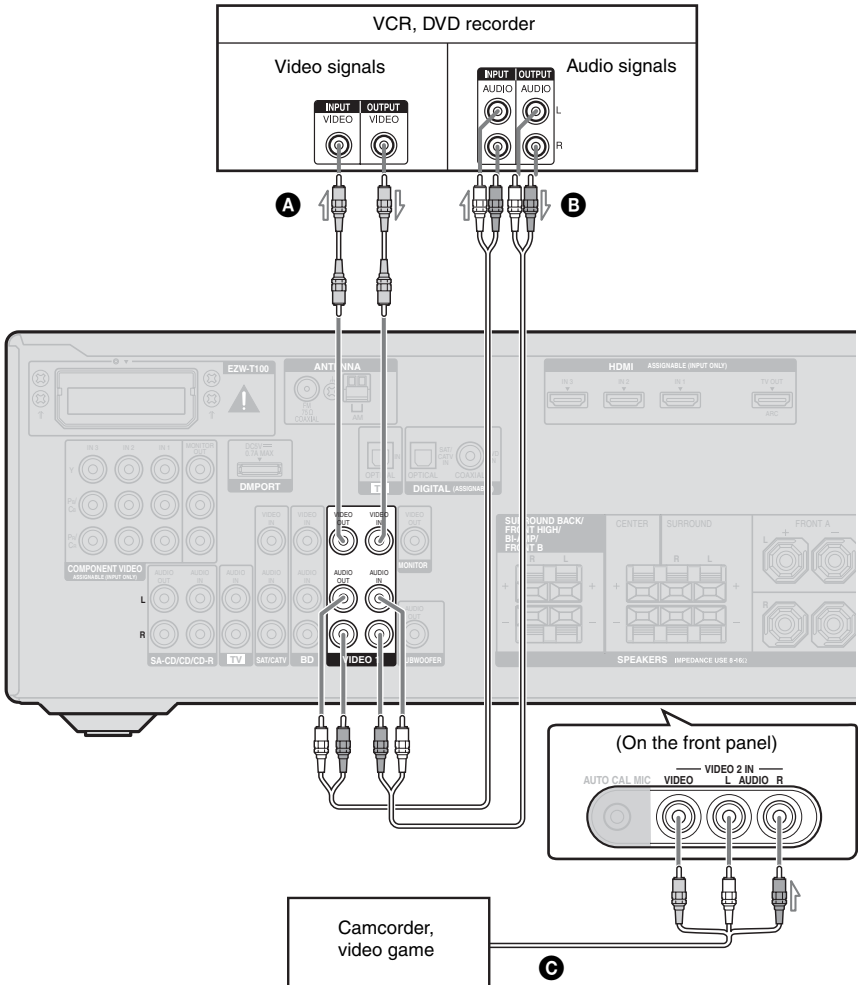

- A** Video cord (not supplied)
- B** Audio cord (not supplied)
- C** Audio/video cord (not supplied)

5: Connecting the antennas (aerials)

Connect the supplied AM loop antenna (aerial) and FM wire antenna (aerial).
Before connecting antennas (aerials), be sure to disconnect the AC power cord (mains lead).

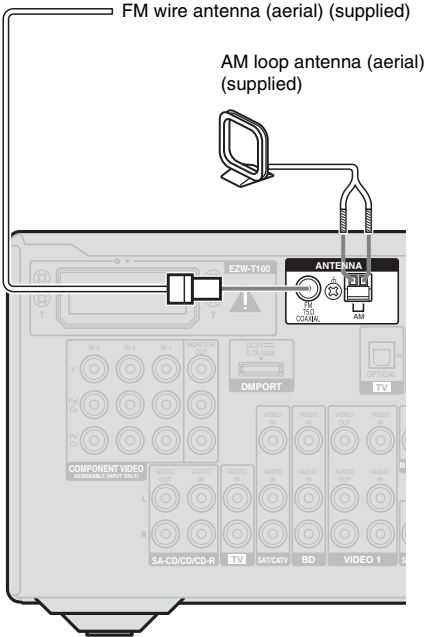

Notes

- To prevent noise pickup, keep the AM loop antenna (aerial) away from the receiver and other components.
- Be sure to fully extend the FM wire antenna (aerial).
- After connecting the FM wire antenna (aerial), keep it as horizontal as possible.

6: Inserting the wireless transmitter/transceiver

To use the S-AIR function, you need to insert the wireless transmitter (not supplied) into the S-AIR main unit (this receiver) and the wireless transceiver (not supplied) into the S-AIR sub unit.

Notes

- Before inserting the wireless transmitter/transceiver, be sure to disconnect the AC power cord (mains lead).
- Do not touch the terminals of the wireless transmitter/transceiver.

To insert the wireless transmitter into the S-AIR main unit

- 1 Remove the screws.

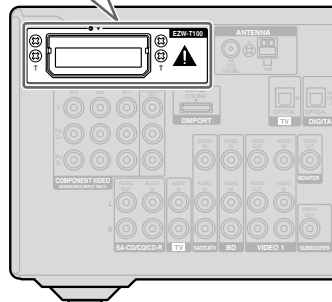
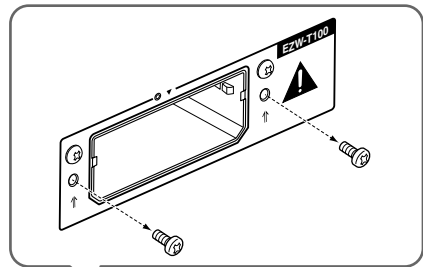

Note

Remove the screws pointed with ↑ mark. Do not remove other screws.

2 Insert the wireless transmitter.

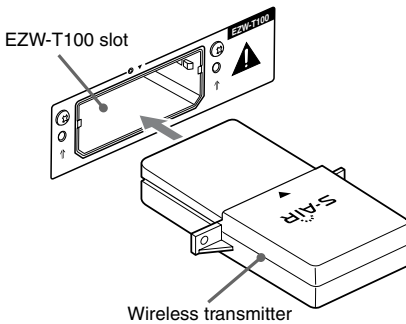

Notes

- Insert the wireless transmitter with the S-AIR logo facing up.
- Insert the wireless transmitter so that the ▼ marks are aligned.
- Do not insert other than the wireless transmitter into the EZW-T100 slot.

3 Use the screws that you removed from step 1 to fasten the wireless transmitter.

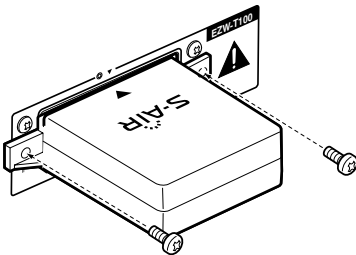

Note

Do not use other screws to fasten the wireless transmitter.

To insert the wireless transceiver into the S-AIR sub unit

Refer to the operating instructions supplied with the surround amplifier and S-AIR receiver.

7: Connecting the AC power cord (mains lead)

Connect the AC power cord (mains lead) to a wall outlet.

Notes

- Before connecting the AC power cord (mains lead), make sure that metallic wires of the speaker cords are not touching each other between the SPEAKERS terminals.
- Connect the AC power cord (mains lead) firmly.

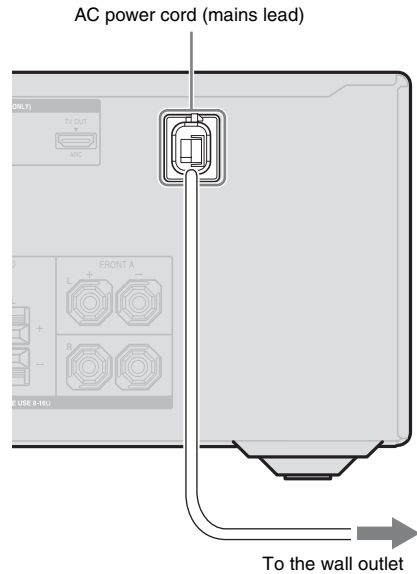

Initializing the receiver

Before using the receiver for the first time, initialize the receiver by performing the following procedure. This procedure can also be used to return settings you have made to their initial settings.

Be sure to use the buttons on the receiver for this operation.

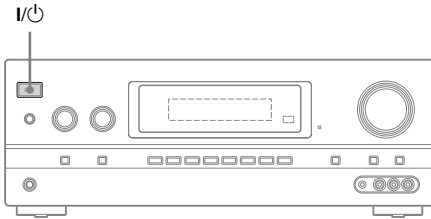

- 1 Press I/⏻ to turn off the receiver.**
- 2 Hold down I/⏻ for 5 seconds.**

After “CLEARING” appears on the display for a while, “CLEARED” appears.

All the settings you have changed or adjusted are reset to the initial settings.

Selecting the speaker system

You can select the front speakers you want to drive.

Be sure to use the buttons on the receiver for this operation.

SPEAKERS

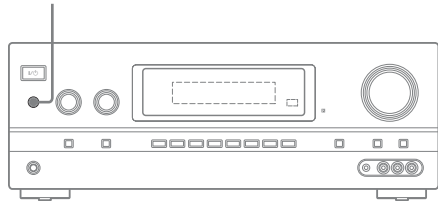

Press SPEAKERS repeatedly to select the front speaker system you want to drive.

To select the front speakers connected to	Display
The SPEAKERS FRONT A terminals	SPK A
The SPEAKERS SURROUND BACK/FRONT HIGH/BI-AMP/FRONT B terminals	SPK B*
Both the SPEAKERS FRONT A and SPEAKERS SURROUND BACK/FRONT HIGH/BI-AMP/FRONT B terminals (parallel connection)	SPK A+B*

* To select “SPK B” or “SPK A+B”, set “SB ASGN” to “SPK B” in the SPEAKER menu (page 79).

To turn off the speaker output

Press SPEAKERS repeatedly until “SPK OFF” appears on the display.

Note

This setting is not available when the headphones are connected.

Calibrating the appropriate speaker settings automatically

(AUTO CALIBRATION)

This receiver is equipped with DCAC (Digital Cinema Auto Calibration) Technology which allows you to perform automatic calibration as follows:

- Check the connection between each speaker and the receiver.^{a)}
- Adjust the speaker level.
- Measure the distance of each speaker from your listening position.^{a)b)}
- Measure the speaker size.^{a)}
- Measure the speaker polarity.
- Measure the frequency characteristics.^{a)c)}

^{a)}The measurement result is not utilized when Analog Direct is selected.

^{b)}The measurement result is not utilized when signals with a sampling frequency of more than 96 kHz are being received.

^{c)}The measurement result is not utilized when signals with a sampling frequency of more than 48 kHz are being received.

The DCAC is designed to obtain proper sound balance in your room. However, you can adjust the speaker levels manually according to your preference. For details, see “Adjusting the speaker levels (TEST TONE)” (page 40).

Before you perform Auto Calibration

Before you perform Auto Calibration, check the following items:

- set up and connect the speakers (page 16, 19).
- connect only the supplied optimizer microphone to the AUTO CAL MIC jack. Do not connect other microphones to this jack.
- set “SB ASGN” to “BI-AMP” in SPEAKER menu if you use bi-amplifier connection (page 79).
- set “SB ASGN” to “SPK B” in SPEAKER menu if you use speakers front B connection (page 79).
- pair the surround amplifier to S-AIR main unit if you want to use surround amplifier.
- speaker output is not set to “SPK OFF”.
- disconnect the headphones.
- remove any obstacles in the path between the optimizer microphone and the speakers to avoid measurement error.
- make sure the environment is quiet to avoid the effect of noise and get a more accurate measurement.
- select the seating position as position 1, 2 or 3 to save the Auto Calibration result (page 39).

Notes

- During the calibration, the sound that comes out of the speakers is very loud. The volume of the sound cannot be adjusted. Pay attention to the presence of children or to the effect on your neighborhood.
- If the muting function has been activated before you perform Auto Calibration, the muting function will be set to off automatically.

1: Setting up the Auto Calibration

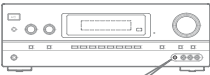

When using surround back speakers

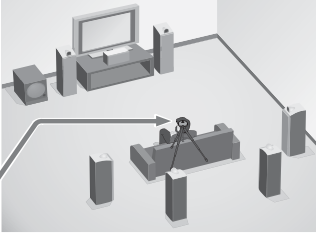

When using front high speakers*

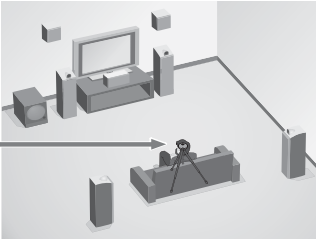

* Be sure to set the speaker pattern setting with front high speakers (page 77).

1 Connect the supplied optimizer microphone to the AUTO CAL MIC jack.

2 Set up the optimizer microphone.

Place the optimizer microphone at your listening position. Use a stool or tripod so that the optimizer microphone remains at the same height as your ears.

On setting up the active subwoofer

- When a subwoofer is connected, turn on the subwoofer and turn up the volume beforehand. Turn the MASTER VOLUME knob to just before the mid-point.

- If you connect a subwoofer with a crossover frequency function, set the value to the maximum.
- If you connect a subwoofer with an auto standby function, set this function to off (deactivated).

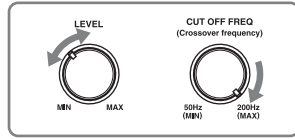

Note

Depending on the characteristics of the subwoofer you are using, the setup distance value may be further away from the actual position.

2: Performing Auto Calibration

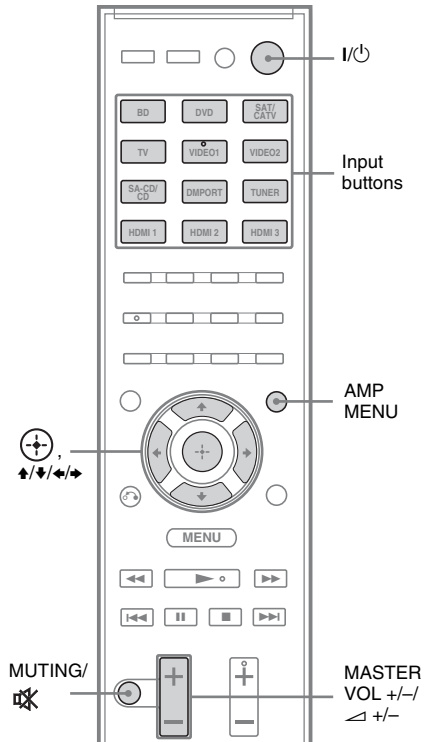

1 Press AMP MENU.

2 Press \uparrow/\downarrow repeatedly to select "A. CAL", then press \oplus or \rightarrow . "START" appears on the display.

3 Press \oplus .

Measurement starts in 5 seconds. A count down is displayed.

The measurement process will take approximately 30 seconds to complete. The table below shows the display when measurement starts.

Measurement for	Display
Speaker existence	TONE
Speaker gain, distance, frequency response	T. S. P.*
Subwoofer gain and distance	WOOFER*

* The corresponding speaker indicator lights up in the display during measurement.

Tips

- Operations other than turning the receiver on or off are deactivated during the measurement.
- The measurements may not be performed correctly or Auto Calibration cannot be performed when special speakers, such as dipole speakers are used.

To cancel Auto Calibration

The Auto Calibration function will be canceled when you do the following during the measurement process:

- Press I/⏻.
- Press the input buttons or turn the INPUT SELECTOR on the receiver.
- Change the volume level.
- Press MUTING (RM-AAU073 only) or \otimes (RM-AAU075 only).
- Press the SPEAKERS button on the receiver.
- Connect headphones.

3: Confirming/saving the measurement results

1 Confirm the measurement result.

When the measurement ends, a beep sounds and the measurement result appears on the display.

Measurement process [Display]	Explanation
Completes properly [SAVE.EXIT]	Proceed to step 2.
Fails [E - ■■■ ■■■]	See "When error codes appear" (page 37).

2 View the measurement result.

Press \uparrow/\downarrow repeatedly to select the item. Then, press \oplus .

Item and explanation

EXIT

Exits the setting process without saving the measurement results.

LVL.INFO.

Displays the measurement result for speaker level.

DIST.INFO.

Displays the measurement result for speaker distance.

P. INFO.

Displays the phase of each speaker (in phase/out of phase). See "When you select "P.INFO."" (page 38).

WARN CHK

Displays warning concerning the measurement results. See "When you select "WARN CHK"" (page 38).

SAVE.EXIT

Saves the measurement results and exits the setting process.

RETRY

Performs the Auto Calibration again.

3 Save the measurement result.

Select “SAVE.EXIT” in step 2. “COMPLETE” appears on the display and the settings are registered as selected position number.

4 Select the calibration type.

Press $\blacktriangle/\blacktriangledown$ repeatedly to select calibration type, then press \oplus .

Calibration type and explanation

FULL.FLAT

Makes the measurement of frequency from each speaker flat.

ENGINEER

Sets the frequency characteristics to a set that matches that of the Sony listening room standard.

FRONT.REF

Adjusts the characteristics of all speakers to match the characteristics of the front speaker.

OFF

Sets the Auto Calibration equalizer level to off.

5 Disconnect the optimizer microphone after you have finished.

Note

If you have reposition your speaker, we recommend that you perform Auto Calibration again to enjoy the surround sound.

Tip

The size of a speaker (LARGE/SMALL) is determined by the low frequency characteristics. The measurement results may vary, depending on the position of the optimizer microphone and speakers, and the shape of the room. It is recommended that you follow the measurement results. However, you can change those settings in the SPEAKER menu (page 77). Save the measurement results first, then try to change the settings if you want.

When error codes appear

1 Check the problem of the error.

Display and explanation

E - ■■■■* 31

SPEAKERS is set to “SPK OFF”. Set it to others (page 33) and perform the measurement again.

E - ■■■■* 32

None of the speakers were detected. Make sure that the optimizer microphone is connected properly and perform the measurement again. If the optimizer microphone is connected properly but the error code appears, the optimizer microphone cable may be damaged or improperly connected.

E - ■■■■* 33

- None of the front speakers are connected or only one front speaker is connected.
 - The optimizer microphone is not connected.
 - Either the left or right surround speakers is not connected.
 - Surround back speakers or front high speakers are not connected even though surround speakers are not connected. Connect the surround speaker(s) to the SPEAKERS SURROUND terminals.
- The surround back speaker is connected only to the SPEAKERS SURROUND BACK/FRONT HIGH/BI-AMP/FRONT B R terminals. When you connect only one surround back speaker, connect it to the SPEAKERS SURROUND BACK/FRONT HIGH/BI-AMP/FRONT B L terminals.
- Either the front left high or front right high speaker is not connected.

* ■■■■ represent a speaker channel

F	Front
S	Surround
SB	Surround back
FH	Front high

2 Perform Auto Calibration again.

Press \oplus . “RETRY Y” will appears on the display, then press \oplus .

3 Repeat steps in “3: Confirming/saving the measurement results” (page 36).

Checking the measurement results

When you select “P. INFO.”

You can check the phase of each speaker (in phase/out of phase).

- 1 Press \uparrow/\downarrow repeatedly to select a speaker you want to check.

Display and explanation

■■■■* IN

The speaker is in phase.

■■■■* OUT

The speaker is out of phase. The “+” and “-” terminals of the speaker may be connected the other way around. However, depending on the speakers, “■■■■ OUT” appears on the display even though the speakers are connected properly. This is because of the speakers’ specifications. In this case, you can continue to use the receiver.

- 2 Press \oplus to return to step 2 of “3: Confirming/saving the measurement results” (page 36).

When you select “WARN CHK”

If a warning on the measurement result is present, detailed information is displayed.

Display and explanation

W - ■■■■* 40

The measurement has completed. However, the noise level is high. You may be able to perform the measurement properly if you try it again, even though the measurement cannot be performed in all environments. Try to perform the measurement in a quiet environment.

W - ■■■■* 41

The sound input from the optimizer microphone is outside the acceptable range. It is louder than the loudest sound that can be measured. Try to perform the measurement when the environment is quiet enough to allow proper measurement.

W - ■■■■* 42

The volume of the receiver is out of the acceptable range. Try to perform the measurement when the environment is quiet enough to allow proper measurement.

Display and explanation

W - ■■■■* 43

The distance and position of a subwoofer cannot be detected. This may be caused by noise. Try to perform the measurement in a quiet environment.

NO WARN

There is no warning information.

* ■■■■ represent a speaker channel

FL	Front left
FR	Front right
CNT	Center
SL	Surround left
SR	Surround right
SBL	Surround back left
SBR	Surround back right
LH	Front left high
RH	Front right high
SW	Subwoofer

To return to step 2 of “3: Confirming/saving the measurement results”

Press \oplus .

Tip

Depending on the position of the subwoofer, the measurement results for polarity may vary. However, there will be no problems even if you continue to use the receiver with that value.

AUTO CAL menu

You can use the AUTO CAL menu to make various adjustments for Auto Calibration settings and to name the position. Select “A. CAL” in the amplifier menus. For details on adjusting the parameters, see “Using the setting menu” (page 71) and “Overview of the menus” (page 72).

■ START

■ CAL TYPE*

Lets you select the Auto Calibration type for each seating position. For details, see step 4 of “3: Confirming/saving the measurement results” (page 36).

* You can select this parameter only when you have performed the Auto Calibration and saved the settings.

■ POSITION

You can register three patterns as position 1, 2, 3, depending on the seating positions, listening environment, and measurement conditions. If you do not select the position number, the Auto Calibration result will automatically save as POS 1 (initial setting).

To register more than one set of settings for the listening environment

You can select the seating position you want and register the measurement results of the Auto Calibration for that seating position.

- 1 Press AMP MENU.
- 2 Press \uparrow/\downarrow repeatedly to select “A. CAL”, then press \oplus or \rightarrow .
- 3 Press \uparrow/\downarrow repeatedly to select “POSITION”, then press \oplus or \rightarrow .
- 4 Press \uparrow/\downarrow repeatedly to select the position (POS 1, 2, 3) for which you want to register the measurement results, then press \oplus .

- 5 Press \uparrow/\downarrow repeatedly to select “START”, then press \oplus to perform Auto Calibration.

For details, see “2: Performing Auto Calibration” (page 35).

The measurement results is registered as the position you selected in step 4.

- 6 Repeat steps 1 to 5 to register another seating position.

To select the registered seating position

- 1 Press AMP MENU.
- 2 Press \uparrow/\downarrow repeatedly to select “A. CAL”, then press \oplus or \rightarrow .
- 3 Press \uparrow/\downarrow repeatedly to select “POSITION”, then press \oplus or \rightarrow .
- 4 Press \uparrow/\downarrow repeatedly to select position (POS 1, 2, 3) you want, then press \oplus .
The registered seating position is selected.

To exit the menu

Press AMP MENU.

■ NAME IN (Naming position)

You can rename the position name.

- 1 Select the position (POS 1, 2, 3) for which you want to name.
- 2 Press \uparrow/\downarrow repeatedly to select “NAME IN”, then press \oplus or \rightarrow .
The cursor flashes and you can select a character.
- 3 Press \uparrow/\downarrow to select a character, then press \leftarrow/\rightarrow to move the cursor to the next position.

If you made a mistake

Press \leftarrow/\rightarrow until the character you want to change flashes, then press \uparrow/\downarrow to select the correct character.

Tips

- You can select the character type as follows by pressing \updownarrow .
Alphabet (upper case) \rightarrow Numbers \rightarrow Symbols
- To enter a blank space, press \rightarrow without selecting a character.

4 Press \oplus .

The name you entered is registered.

Adjusting the speaker levels (TEST TONE)

You can adjust the speaker levels while listening to the test tone from your listening position.

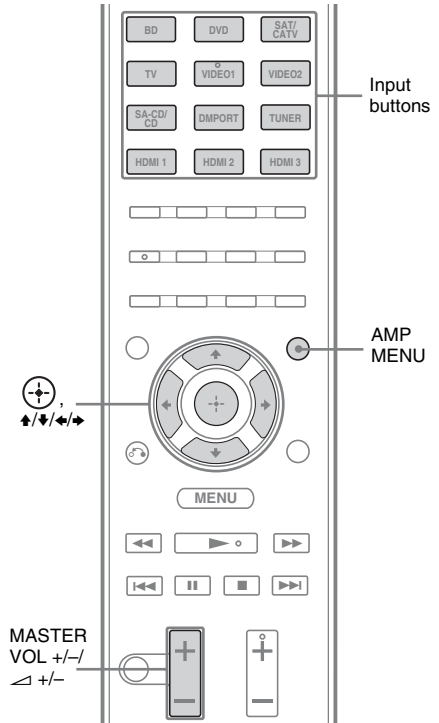

1 Press AMP MENU.

2 Press \updownarrow repeatedly to select “LEVEL”, then press \oplus or \rightarrow .

3 Press \updownarrow repeatedly to select “T. TONE”, then press \oplus .

4 Press **▲/▼** repeatedly to select “**AUTO ■■■■***”.

The test tone is output from each speaker in sequence.

* **■■■■** represent a speaker channel.

Note

Depending on the speaker pattern settings, test tone may not be output from all speakers even though you select “**AUTO ■■■■**”.

5 Adjust the speaker levels using the **LEVEL** menu so that the level of the test tone sounds the same from each speaker.

For details, see LEVEL menu (page 76).

Tips

- To adjust the level of all speakers at the same time, press **MASTER VOL +/-** (RM-AAU073 only) or **⏏ +/-** (RM-AAU075 only). You can also use **MASTER VOLUME** on the receiver.
- The adjusted value are shown on the display during adjustment.

6 Repeat steps 1 to 4 to select “**OFF**”.

You can also press any input buttons.
The test tone turns off.

When a test tone is not output from the speakers

- The speaker cords may not be connected securely.
- The speaker cords may have the short-circuit problem.

When a test tone is output from a different speaker than the speaker indicator showed in the display

The speaker pattern to the connected speaker is not set up correctly. Make sure the speaker connection and the speaker pattern match.

Note

Test tone is not output from the headphones connected to the S-AIR surround amplifier.

Playback

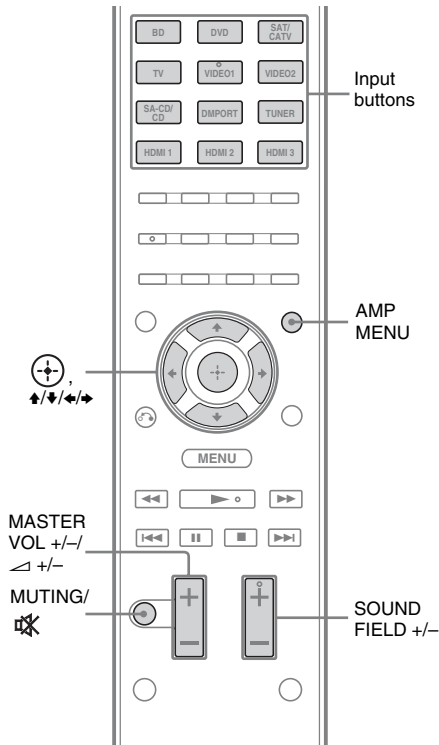

- 1 Turn on the connected component.**
- 2 Turn on the receiver.**
- 3 Press one of the input buttons to select the component you want.**

You can also use INPUT SELECTOR on the receiver.

The selected input appears on the display.

- 4 Play back the source.**
- 5 Press MASTER VOL +/- (RM-AAU073 only) or \triangle +/- (RM-AAU075 only) to adjust the volume.**

You can also use MASTER VOLUME on the receiver.

- 6 Press SOUND FIELD +/- to enjoy the surround sound.**

You can also use 2CH/A.DIRECT, A.F.D., MOVIE or MUSIC on the receiver.

For details, see page 50.

To activate the muting function

Press MUTING (RM-AAU073 only) or  (RM-AAU075 only) on the remote.

The muting function will be canceled when you do the following.

- Press MUTING (RM-AAU073 only) or  (RM-AAU075 only) again.
- Increase the volume.
- Turn off the receiver.
- Perform Auto Calibration

To avoid damaging your speakers

Before you turn off the receiver, be sure to turn down the volume level.

Naming inputs

You can enter a name of up to 8 characters for inputs (except TUNER) and display it on the receiver's display.

This is convenient for labeling the jacks with the names of the connected components.

1 Press one of the input buttons to select the input you want to create an index name for.

You can also use INPUT SELECTOR on the receiver.

2 Press AMP MENU.

3 Press \uparrow/\downarrow repeatedly to select "SYSTEM", then press \odot or \rightarrow .

4 Press \uparrow/\downarrow repeatedly to select "NAME IN", then press \odot or \rightarrow .

The cursor flashes and you can select a character.

5 Press \uparrow/\downarrow to select a character, then press \leftarrow/\rightarrow to move the cursor to the next position.

If you made a mistake

Press \leftarrow/\rightarrow until the character you want to change flashes, then press \uparrow/\downarrow to select the correct character.

Tips

- You can select the character type as follows by pressing \uparrow/\downarrow .
Alphabet (upper case) \rightarrow Numbers \rightarrow Symbols
- To enter a blank space, press \rightarrow without selecting a character.

6 Press \odot .

The name you entered is registered.

Viewing information on the display

You can check the sound field, etc., by changing the information on the display.

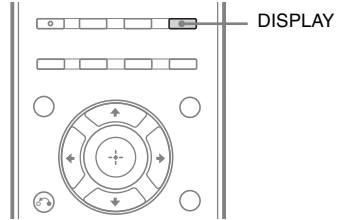

Press DISPLAY repeatedly.

Each time you press the button, the display changes cyclically as follows:

All inputs except the FM and AM band

Index name of the input^{a)} \rightarrow Selected input
 \rightarrow Sound field currently applied \rightarrow Volume level
 \rightarrow Stream info

FM and AM band

Program Service name^{b)} or preset station name^{a)} \rightarrow Frequency \rightarrow Program Type indication^{b)} \rightarrow Radio Text indication^{b)} \rightarrow Current Time indication (in 24-hour system mode)^{b)} \rightarrow Sound field currently applied \rightarrow Volume level

^{a)} Index name appears only when you have assigned one to the input or preset station (page 43, 48).

Index name does not appear when only blank spaces have been entered, or it is the same as the input name.

^{b)} During RDS reception only (Models of area code AU1, TW2 only) (page 49).

Note

Character or marks may not be displayed for some languages.

Using the Sleep Timer

You can set the receiver to turn off automatically at a specified time.

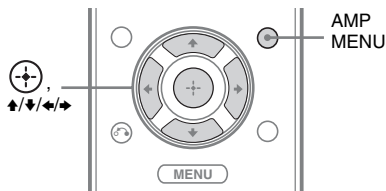

- 1 Press AMP MENU.**
- 2 Press \uparrow/\downarrow repeatedly to select “SYSTEM”, then press \odot or \rightarrow .**
- 3 Press \uparrow/\downarrow repeatedly to select “SLEEP”, then press \odot or \rightarrow .**
- 4 Press \uparrow/\downarrow repeatedly to select the preset time you want, then press \odot .**

The display changes as follows:

OFF \leftrightarrow 0-30-00 \leftrightarrow 1-00-00 \leftrightarrow
1-30-00 \leftrightarrow 2-00-00

When sleep timer is being used, “SLEEP” indicator lights up in the display.

Tips

- To check the remaining time before the receiver turns off, repeat steps 1 to 3. The remaining time appears on the display.
- A count down is displayed 1 minute before the receiver turns off.

Recording

You can record from a video/audio component using the receiver. Refer to the operating instructions supplied with your recording component.

Recording onto a CD-R

You can record onto a CD-R using the receiver. Refer to the operating instructions supplied with your CD recorder.

- 1 Press one of the input buttons to select the playback component.**
You can also use INPUT SELECTOR on the receiver.
- 2 Prepare the playback component for playing.**
For example, tune to the radio station you want to record (page 45).
- 3 Prepare the recording component.**
Insert a blank CD-R into the CD recorder and adjust the recording level.
- 4 Start recording on the recording component, then start playback on the playback component.**

Note

Sound adjustments do not affect the signal output from the SA-CD/CD/CD-R AUDIO OUT jacks.

Recording onto a recording media

1 Press one of the input buttons to select the playback component.

You can also use INPUT SELECTOR on the receiver.

2 Prepare the playback component for playing.

For example, insert the video tape you want to copy into the VCR.

3 Prepare the recording component.

Insert a blank video tape, etc. into the recording component (VIDEO 1) for recording.

4 Start recording on the recording component, then start playback on the playback component.

Notes

- Some sources contain copy guards to prevent recording. In this case, you may not be able to record from the source.
- Only analog signals are output from the analog output jack (for recording).
- HDMI sound cannot be recorded.

Tuner Operations

Listening to FM/AM radio

You can listen to FM and AM broadcasts through the built-in tuner. Before operation, make sure you have connected the FM and AM antennas (aerials) to the receiver (page 31).

Tip

The tuning scale for direct tuning differs depending on the area code as shown in the following table. For details on area codes, see page 4.

Area code	FM	AM
U2, CA2	100 kHz	10 kHz*
AU1, TW2	50 kHz	9 kHz

* The AM tuning scale can be changed (page 47).

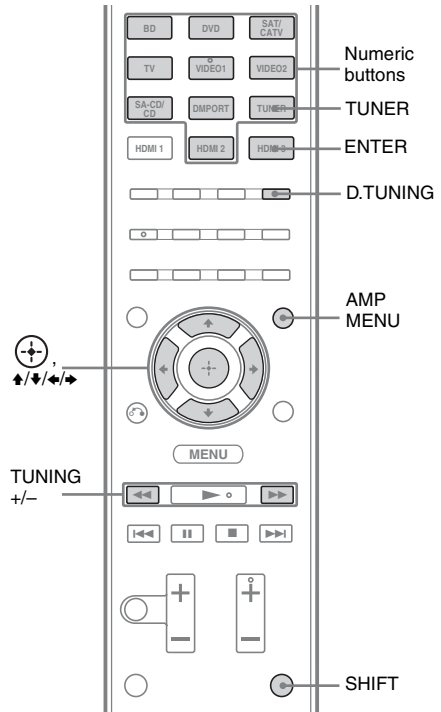

Tuning into a station automatically (Automatic Tuning)

- 1 Press TUNER repeatedly to select the FM or AM band.**
- 2 Press TUNING + or TUNING –.**

Press TUNING + to scan from low to high; press TUNING – to scan from high to low.

The receiver stops scanning whenever a station is received.

Using the controls on the receiver

- 1 Turn INPUT SELECTOR to select the FM or AM band.**
- 2 Press TUNING MODE repeatedly to select “AUTO”.**
- 3 Press TUNING + or TUNING –.**

In case of poor FM stereo reception

If the FM stereo reception is poor and “ST” flashes on the display, select monaural audio so that the sound will be less distorted.

- 1 Press AMP MENU.**
- 2 Press \uparrow/\downarrow repeatedly to select “TUNER”, then press \oplus or \rightarrow .**
- 3 Press \uparrow/\downarrow repeatedly to select “FM MODE”, then press \oplus or \rightarrow .**
- 4 Press \uparrow/\downarrow repeatedly to select “MONO”, then press \oplus .**

To return to stereo mode, repeat steps 1 to 4 and select “STEREO” in step 4.

Tuning into a station directly (Direct Tuning)

You can enter the frequency of a station directly by using the numeric buttons.

- 1 Press TUNER repeatedly to select the FM or AM band.**

You can also use INPUT SELECTOR on the receiver.
- 2 Press D.TUNING.**
- 3 Press and hold SHIFT, then press the numeric buttons to enter the frequency.**

Example 1: FM 102.50 MHz

 - Models of area code U2 and CA2:
Select 1 \rightarrow 0 \rightarrow 2 \rightarrow 5
 - Models of area code AU1 and TW2:
Select 1 \rightarrow 0 \rightarrow 2 \rightarrow 5 \rightarrow 0

Example 2: AM 1,350 kHz

Select 1 \rightarrow 3 \rightarrow 5 \rightarrow 0
- 4 Press and hold SHIFT, then press ENTER.**

You can also use MEMORY/ENTER on the receiver.

Tip

If you have tuned in an AM station, adjust the direction of the AM loop antenna (aerial) for optimum reception.

If you cannot tune in a station

Make sure you have entered the right frequency. If not, repeat steps 2 to 4. If you still cannot tune in a station, the frequency is not used in your area.

Changing the AM tuning scale

(Models of area code U2, CA2 only)

You can change the AM tuning scale to either 9 kHz or 10 kHz using the buttons on the receiver.

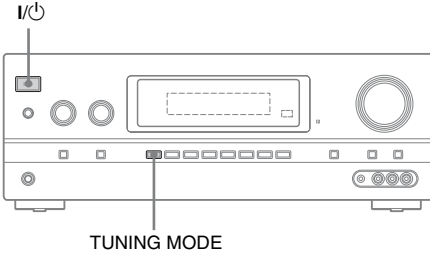

- 1** Press I/Power to turn off the receiver.
- 2** While holding down TUNING MODE, press I/Power.
- 3** Change the current AM tuning scale to 9 kHz (or 10 kHz).

To reset the scale to 10 kHz (or 9 kHz), repeat the procedure above.

Note

All preset stations will be erased when you change the tuning scale.

Presetting FM/AM radio stations

You can preset up to 30 FM stations and 30 AM stations. Then you can easily tune in the stations you often listen to.

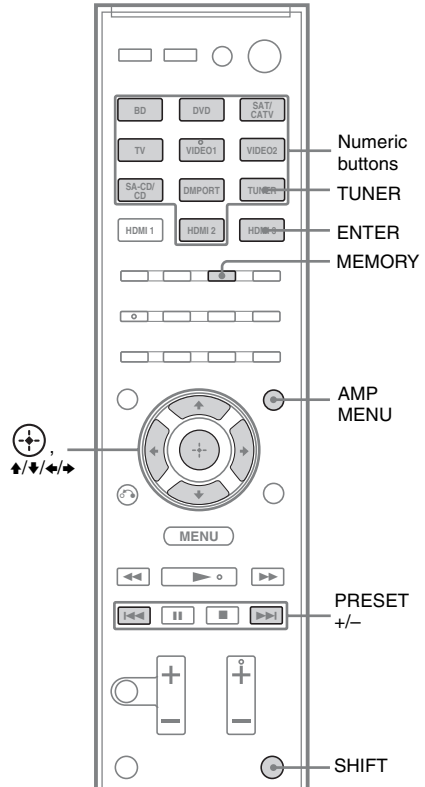

- 1** Press TUNER repeatedly to select the FM or AM band.

You can also use INPUT SELECTOR on the receiver.

- 2 Tune in the station that you want to preset using Automatic Tuning (page 46) or Direct Tuning (page 46).**

Switch the FM reception mode, if necessary (page 46).

- 3 Press MEMORY.**

You can also use MEMORY/ENTER on the receiver.

- 4 Press and hold SHIFT, then press the numeric buttons to select a preset number.**

You can also press PRESET + or PRESET – to select a preset number.

- 5 Press and hold SHIFT, then press ENTER.**

You can also use MEMORY/ENTER on the receiver.

The station is stored as the selected preset number.

- 6 Repeat steps 1 to 5 to preset another station.**

Tuning to preset stations

- 1 Press TUNER repeatedly to select the FM or AM band.**
- 2 Press PRESET + or PRESET – repeatedly to select the preset station you want.**

Each time you press the button, you can select a preset station as follows:

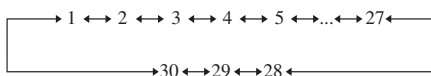



You can also press and hold SHIFT and then press the numeric buttons to select the preset station you want. To enter the selection, press and hold SHIFT then press ENTER.

Using the controls on the receiver

- Turn INPUT SELECTOR to select the FM or AM band.
- Press TUNING MODE repeatedly to select “PRESET”.
- Press TUNING + or TUNING – to select the preset station you want.

Naming preset stations

- 1 Press TUNER repeatedly to select the FM or AM band.**

You can also use INPUT SELECTOR on the receiver.
- 2 Tune in the preset station you want to create an index name for (page 48).**
- 3 Press AMP MENU.**
- 4 Press ↑/↓ repeatedly to select “TUNER”, then press  or .**

- 5** Press **▲/▼** repeatedly to select “NAME IN”, then press **⊕** or **▶**.

The cursor flashes and you can select a character.

- 6** Press **▲/▼** to select a character, then press **◀/▶** to move the cursor to the next position.

If you made a mistake

Press **◀/▶** until the character you want to change flashes, then press **▲/▼** to select the correct character.

Tips

- You can select the character type as follows by pressing **▲/▼**.
Alphabet (upper case) → Numbers → Symbols
- To enter a blank space, press **▶** without selecting a character.

- 7** Press **⊕**.

The name you entered is registered.

Note (Models of area code AU1, TW2 only)

When you name an RDS station and tune in that station, the Program Service name appears instead of the name you entered. (You cannot change the Program Service name. The name you entered will be overwritten by the Program Service name.)

Using the Radio Data System (RDS)

(Models of area code AU1, TW2 only)

This receiver allows you to use Radio Data System (RDS), which enables radio stations to send additional information along with the regular program signal. This receiver offers convenient RDS features, such as program service name display.

Notes

- RDS is operable only for FM stations.
- Not all FM stations provide RDS service, nor do they provide the same type of services. If you are not familiar with the RDS services in your area, check with your local radio stations for details.

Receiving RDS broadcasts

Simply select a station on the FM band using Direct Tuning (page 46), Automatic Tuning (page 46), or Preset Tuning (page 48).

When you tune in a station that provides RDS services, “RDS” lights up and the program service name appears on the display.

Note

RDS may not work properly if the station you tuned to is not transmitting the RDS signal properly or if the signal strength is weak.

Tip

When a program service name is displayed, you can check the frequency by pressing DISPLAY repeatedly (page 43).

Enjoying Surround Sound

Selecting the sound field

This receiver can create multi channel surround sound. You can select one of the optimized sound fields from the receiver's preprogrammed sound fields.

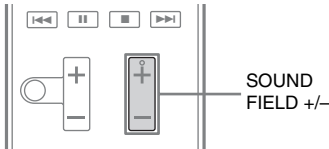

Press SOUND FIELD +/- repeatedly to select the sound field you want.

You can also press 2CH/A.DIRECT, A.F.D., MOVIE or MUSIC on the receiver.

2 channel sound mode

You can switch the output sound to 2 channel sound regardless of the recording formats of the software you are using, the playback component connected, or the sound field settings of the receiver.

■ 2CH ST. (2 Channel Stereo)

The receiver outputs the sound from the front left/right speakers only. There is no sound from the subwoofer.

Standard 2 channel stereo sources completely bypass the sound field processing and multi channel surround formats are downmixed to 2 channel except LFE signal.

■ A. DIRECT (Analog Direct)

You can switch the audio of the selected input to 2 channel analog input. This function enables you to enjoy high quality analog sources without any adjustment.

When using this function, only the volume and front speaker level can be adjusted.

Notes

- When headphones are connected, "HP DIR" appears on the display.
- You cannot select Analog Direct when you select DVD, DMPOR and HDMI 1-3 as input.

Auto Format Direct (A.F.D.) mode

The Auto Format Direct (A.F.D.) mode allows you to listen to high fidelity sound and select the decoding mode for listening to a 2 channel stereo sound as multi channel sound.

■ A.F.D. AUTO (A.F.D. Auto)

Presets the sound as it was recorded/encoded without adding any surround effects.

■ MULTI ST. (Multi Stereo)

Outputs 2 channel left/right signals from all speakers.

However, sound may not be output from certain speakers depending on the speaker settings.

Movie mode

You can take advantage of surround sound simply by selecting one of the receiver's pre-programmed sound fields. They bring the exciting and powerful sound of movie theaters into your home.

■ C.ST.EX A (Cinema Studio EX A DCS)

Reproduces the sound characteristics of the Sony Pictures Entertainment "Cary Grant Theater" cinema production studio. This is a standard mode, great for watching almost any type of movie.

■ C.ST.EX B (Cinema Studio EX B DCS)

Reproduces the sound characteristics of the Sony Pictures Entertainment "Kim Novak Theater" cinema production studio. This mode is ideal for watching science-fiction or action movies with lots of sound effects.

■ C.ST.EX C (Cinema Studio EX C DCS)

Reproduces the sound characteristics of the Sony Pictures Entertainment scoring stage. This mode is ideal for watching musicals or films where orchestra music is featured in the soundtrack.

■ V. M. DIM (V. Multi Dimension DCS)

Creates many virtual speakers from a single pair of actual surround speakers.

■ PLII MV (Pro Logic II Movie)

Performs Dolby Pro Logic II Movie mode decoding. This setting is ideal for movies encoded in Dolby Surround. In addition, this mode can reproduce sound in 5.1 channel for watching videos of overdubbed or old movies.

■ PLIIX MV (Pro Logic IIX Movie)

Performs Dolby Pro Logic IIX Movie mode decoding. This setting expands Dolby Pro Logic II Movie or Dolby Digital 5.1 to discrete 7.1 movie channels.

■ PLIIZ (Pro Logic IIZ)

Performs Dolby Pro Logic IIZ mode decoding. This setting increases flexibility to expand a 5.1 to a 7.1 channel system. Its vertical component gives a dimension of presence and depth.

■ NEO6 CIN (Neo:6 Cinema)

Performs DTS Neo:6 Cinema mode decoding. A source recorded in 2 channel format is decoded into 7 channels.

Music mode

You can take advantage of surround sound simply by selecting one of the receiver's preprogrammed sound fields. They bring the exciting and powerful sound of concert halls into your home.

■ HALL (Hall)

Reproduces the acoustics of a classical concert hall.

■ JAZZ (Jazz Club)

Reproduces the acoustics of a jazz club.

■ CONCERT (Concert)

Reproduces the acoustics of a 300-seat live house.

■ STADIUM (Stadium)

Reproduces the feeling of a large open-air stadium.

■ SPORTS (Sports)

Reproduces the feeling of sports broadcasting.

■ PORTABLE (Portable Audio Enhancer)

Reproduces a clear enhanced sound image from your portable audio device. This mode is ideal for MP3 and other compressed music.

■ PLII MS (Pro Logic II Music)

Perform Dolby Pro Logic II Music mode decoding. This setting is ideal for normal stereo sources such as CDs.

■ PLIIX MS (Pro Logic IIX Music)

Performs Dolby Pro Logic IIX Music mode decoding. This setting is ideal for normal stereo sources such as CDs.

■ PLIIZ (Pro Logic IIZ)

Performs Dolby Pro Logic IIZ mode decoding. This setting increases flexibility to expand a 5.1 to a 7.1 channel system. Its vertical component gives a dimension of presence and depth.

■ NEO6 MUS (Neo:6 Music)

Performs DTS Neo:6 Music mode decoding. A source recorded in 2 channel format is decoded into 7 channels. This setting is ideal for normal stereo sources such as CDs.

When headphones are connected

You can only select this sound field if the headphones are connected to the receiver.

■ HP 2CH (Headphones 2CH)

This mode is selected automatically if you use headphones (except Analog Direct). Standard 2 channel stereo sources completely bypass the sound field processing and multi channel surround formats are downmixed to 2 channels except LFE signals.

Note

When headphones are connected to the S-AIR surround amplifier, the sound field is automatically set to “HP 2CH”.

■ HP DIR (Headphones Direct)

Outputs the analog signals without processing by the equalizer, sound field, etc.

If you connect a subwoofer

This receiver will generate a low frequency signal for output to the subwoofer when there is no LFE signal, which is a low-pass sound effect output from a subwoofer to a 2 channel signal. However, the low frequency signal is not generated for “NEO6 CIN” or “NEO6 MUS” when all speakers are set to “LARGE”. In order to take full advantage of the Dolby Digital bass redirection circuitry, we recommend setting the subwoofer’s cut off frequency as high as possible.

Notes on sound fields

- Depends on the speaker pattern settings, some sound fields may not be available.
- The sound fields for music and movie do not work in the following cases.
 - signals with a sampling frequency of more than 48 kHz are being received.
 - signals with more than 5.1 channel are being received (except PLIIz).

- You cannot select PLII, PLIIx and PLIIz at the same time.
 - PLIIx is available only when the speaker pattern is set to a setting with surround back speaker(s).
 - PLIIz is available only when the speaker pattern is set to a setting with front high speakers.
- The effects provided by the virtual speakers may cause increased noise in the playback signal.
- When listening with sound fields that employ the virtual speakers, you will not be able to hear any sound coming directly from the surround speakers.
- When one of the sound fields for music is selected, no sound is output from the subwoofer if all the speakers are set to “LARGE” in the SPEAKER menu. However, the sound will be output from the subwoofer if the digital input signal contains LFE signals, or if the front or surround speakers are set to “SMALL”, the sound field for movie is selected, or “PORTABLE” is selected.

Tips

- You can identify the encoding format of DVD software, etc., by looking at the logo on the package.
- Dolby Pro Logic IIX and Dolby Pro Logic IIZ decoding are effective when multi channel signals are input.
- Sound fields with **DCS** marks use DCS technology. For details on Digital Cinema Sound (DCS), see “Glossary” (page 85).

To turn off the surround effect for movie/music

Press SOUND FIELD +/- repeatedly to select “2CH ST.” or “A.F.D. AUTO”.

You can also press 2CH/A.DIRECT repeatedly on the receiver to select “2CH ST.” or press A.F.D. repeatedly on the receiver to select “A.F.D. AUTO”.

When connecting Blu-ray disc players and other next generation HD players

Digital audio formats that this receiver can decode depend on digital audio input jacks for the connected component. This receiver supports the following audio formats.

Audio format	Maximum number of channels	Connection of the playback component and the receiver	
		COAXIAL/OPTICAL	HDMI
Dolby Digital	5.1	○	○
Dolby Digital EX	6.1	○	○
Dolby Digital Plus ^{a)}	7.1	×	○
Dolby TrueHD ^{a)}	7.1	×	○
DTS	5.1	○	○
DTS-ES	6.1	○	○
DTS 96/24	5.1	○	○
DTS-HD High Resolution Audio ^{a)}	7.1	×	○
DTS-HD Master Audio ^{a)b)}	7.1	×	○
Multi channel Linear PCM ^{a)}	7.1	×	○

^{a)} Audio signals are output in another format if the playback component does not correspond to the format. For details, refer to the operating instructions of the playback component.

^{b)} Signals with a sampling frequency of more than 96 kHz are played back at 96 kHz or 88.2 kHz.

Enjoying the surround effect at low volume levels

(NIGHT MODE)

This function allows you to retain a theater like environment at low volume levels. This function can be used with other sound fields. When watching a movie late at night, you will be able to hear the dialog clearly even at a low volume level.

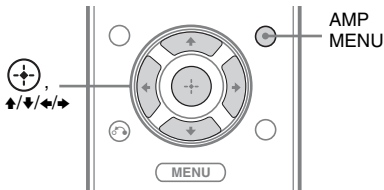

- 1 Press AMP MENU.**
- 2 Press \uparrow/\downarrow repeatedly to select "AUDIO", then press \rightarrow or \leftarrow .**
- 3 Press \uparrow/\downarrow repeatedly to select "NIGHT M.", then press \rightarrow or \leftarrow .**
- 4 Press \uparrow/\downarrow repeatedly to select "NIGHT. ON", then press \rightarrow or \leftarrow .**

Note

This function does not work in the following cases.

- Signals with a sampling frequency of more than 48 kHz are being received.
- Analog Direct is selected.

Tip

While the NIGHT MODE is turned on, "D. RANGE" is automatically set to "COMP. MAX".

Resetting sound fields to the initial settings

Be sure to use the buttons on the receiver for this operation.

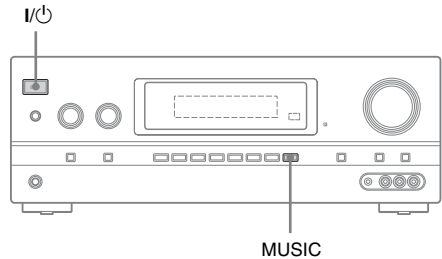

- 1 Press I/⏻ to turn off the receiver.**
- 2 While holding down MUSIC, press I/⏻.**
"S.F. CLEAR" appears on the display and all sound fields are reset to their initial setting.

What is “BRAVIA” Sync?

“BRAVIA” Sync is compatible with Sony TV, Blu-ray Disc/DVD player, AV amplifier, etc., that is equipped with the Control for HDMI function.

By connecting Sony components that are compatible with the “BRAVIA” Sync with an HDMI cable (not supplied), operation is simplified as follows:

- One-Touch Play (page 56)
- System Audio Control (page 57)
- System Power Off (page 58)
- Theater/Theatre Mode Sync (page 59)
- Audio Return Channel (page 59)

Control for HDMI is a mutual control function standard used by HDMI CEC (Consumer Electronics Control) for HDMI (High-Definition Multimedia Interface).

We recommend that you connect the receiver to products featuring “BRAVIA” Sync.

Note

Depending on the connected component, the Control for HDMI function may not work. Refer to the operating instructions of the component.

Preparing for the “BRAVIA” Sync

The receiver is compatible with the “Control for HDMI-Easy Setting” function.

- If your TV is compatible with the “Control for HDMI-Easy Setting” function, you can set the receiver and playback components Control for HDMI function automatically by setting the TV (page 55).
- If your TV is not compatible with the “Control for HDMI-Easy Setting” function, set the Control for HDMI function of the receiver, playback components and TV individually (page 56).

If your TV is compatible with the “Control for HDMI-Easy Setting” function

The Control for HDMI function of the receiver can be turned on simultaneously by turning on the Control for HDMI function of the TV.

- 1** Connect the receiver, TV and playback components via HDMI connection (page 24).
(The respective components must be compatible with the Control for HDMI function.)
- 2** Turn on the receiver, TV and playback components.
- 3** Turn on the Control for HDMI function of the TV.
The Control for HDMI function of the receiver and all the connected components are turned on simultaneously. When the setup is completed, “COMPLETE” will appear.

For details on setting the TV, refer to the operating instructions supplied with the TV.

If your TV is not compatible with the “Control for HDMI-Easy Setting” function

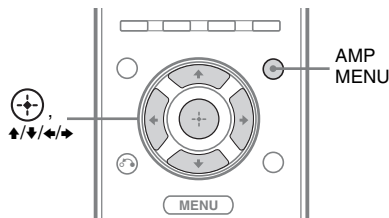

- 1 Perform the steps given in “If your TV is compatible with the “Control for HDMI-Easy Setting” function” (page 55).
- 2 Press AMP MENU.
- 3 Press **↑/↓** repeatedly to select “HDMI”, then press **⊕** or **➔**.
- 4 Press **↑/↓** repeatedly to select “CTRL.HDMI”, then press **⊕** or **➔**.
- 5 Press **↑/↓** repeatedly to select “CTRL ON”, then press **⊕**.
Control for HDMI function is activated.
- 6 Set the Control for HDMI function for the connected component to on.
If the Control for HDMI function for the connected component is already set to on, you do not need to change the setting.

For details on setting the TV and connected components, refer to the operating instructions of the respective components.

Notes

- Before you do the “Control for HDMI-Easy Setting” from the TV, be sure to turn on the TV, connected components and receiver.
- If the playback components cannot function after you have made the settings for “Control for HDMI-Easy Setting”, check the Control for HDMI setting on your TV.
- If the connected components do not support “Control for HDMI-Easy Setting”, you need to set the Control for HDMI function for the connected components to on before you perform the “Control for HDMI-Easy Setting” from the TV.

Playing back components with one-touch operation (One-Touch Play)

By a simple operation (one-touch), components connected to the receiver with HDMI connections start automatically. You can enjoy the sound/image from connected components.

When you set “PASS.THROUGH” to “AUTO” or “ON”, sound and image can be output only from the TV while the receiver remains in standby mode.

When you start playback a connected component, the receiver and TV operation are simplified as follow:

Receiver and TV

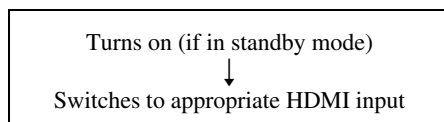

Notes

- Depending on the TV, the start of the content may not be output.
- Depending on the settings, the receiver may not turn on when “PASS.THROUGH” is set to “AUTO” or “ON”.

Tip

You can also select a connected component, such as DVD/Blu-ray disc player using the TV menu. The receiver and TV will automatically switch to the appropriate HDMI input.

Enjoying the TV sound from the speakers connected to the receiver (System Audio Control)

You can enjoy the TV sound from the speakers connected to the receiver by a simple operation.

You can operate System Audio Control function using the TV menu. For details, refer to the operating instructions of the TV.

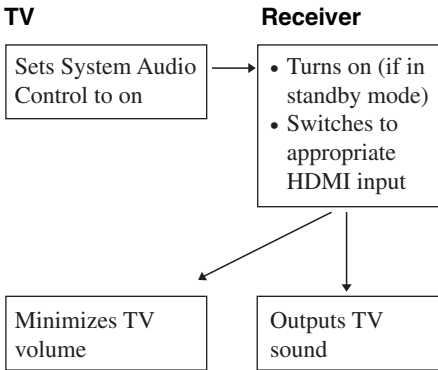

You can also use the System Audio Control function as follows.

- If you turn on the receiver while the TV is turned on, the System Audio Control function will automatically be set to on and the TV sound will output from the speakers connected to the receiver. However, if you turn off the receiver, the sound will output from the TV speakers.
- When you adjust the TV volume, the receiver’s volume is adjusted simultaneously.

Notes

- If System Audio Control does not function according to your TV setting, refer to the operating instructions of the TV.
- When “CTRL.HDMI” is set to “CTRL ON”, the “AUDIO.OUT” settings in the HDMI menu will set automatically depending on the System Audio Control settings.

- When you connect a TV that does not have System Audio Control function, the System Audio Control function does not work.
- If the TV is turned on before turning on the receiver, the TV sound will not be output for a moment.

Turning off the receiver with the TV

(System Power Off)

When you turn the TV off by using the POWER button on the TV's remote, the receiver and the connected components turn off automatically.
You can also use the receiver's remote to turn off the TV.

Press and hold TV, then press TV I/⏻.

The TV, receiver and the components connected via HDMI are turned off.

Notes

- Set the TV Standby Synchro to on before using the System Power Off function. For details, refer to the operating instructions of the TV.
- Depending on the status, the connected components may not be turned off. For details, refer to the operating instructions of the connected components.

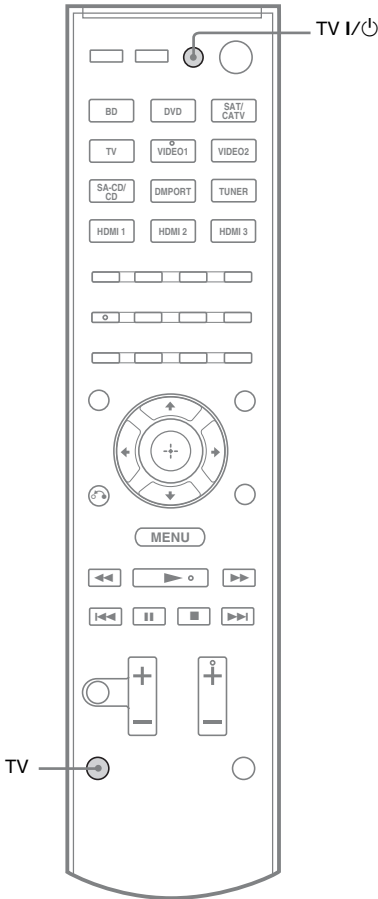

Enjoying movies with the optimum sound field (Theater/Theatre Mode Sync)

Press the **THEATER** or **THEATRE** button on the remote of the receiver, TV, or the Blu-ray disc player, while pointing the remote toward the TV.

The sound field switches to “C.ST.EX B”. To return to the previous sound field, press the **THEATER** or **THEATRE** button again.

Note

The sound field may not switch depending on the TV.

Tip

The sound field may be changed back to the previous one when you change the TV's input.

Enjoying the TV sound via an HDMI cable (Audio Return Channel)

The Audio Return Channel (ARC) function enables the TV outputs the audio signals to the receiver via an HDMI cable connected to the HDMI TV OUT jack.

You can enjoy the TV sound from the speakers connected to the receiver without connecting the TV OPTICAL IN or TV AUDIO IN jack.

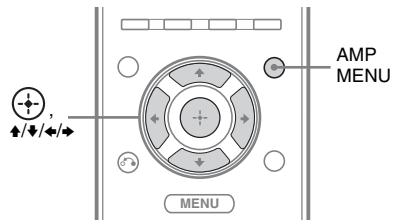

- 1 Press AMP MENU.**
- 2 Press ↓/↑ repeatedly to select “HDMI”, then press ⊕ or →.**
- 3 Press ↓/↑ repeatedly to select “ARC”, then press ⊕ or →.**
- 4 Press ↓/↑ repeatedly to select “ARC ON”, then press ⊕.**

Notes

- This function does not work when you set “CTRL.HDMI” to “CTRL OFF” in the HDMI menu.
- This function is only available when
 - your TV is compatible with Audio Return Channel (ARC) function.
 - INPUT MODE is set to “AUTO”.

S-AIR Operations

About S-AIR products

This receiver is compatible with the S-AIR function (page 88), which allows wireless sound transmission between S-AIR products. There are two types of S-AIR product.

- S-AIR main unit (this receiver):
This is for transmitting sound.
You can use up to three S-AIR main units.
(The number of usable S-AIR main unit depends on the use environment.)
- S-AIR sub unit (not supplied): This is for receiving sound.
 - Surround amplifier: You can enjoy surround and surround back speakers sound wirelessly.
 - S-AIR receiver: You can enjoy system sound in another room.

The S-AIR products can be purchased as an option (the S-AIR products lineup differs depending on the area).

Notes or instructions for the surround amplifier or S-AIR receiver in this operating instructions is refer only when the surround amplifier or S-AIR receiver is used.

Notes

- The S-AIR menu and parameters only available when you have inserted the wireless transmitter.
- When speaker pattern is set to a setting with front high speakers, the surround back speakers sound is not output from surround amplifier even if the surround amplifier is connected.

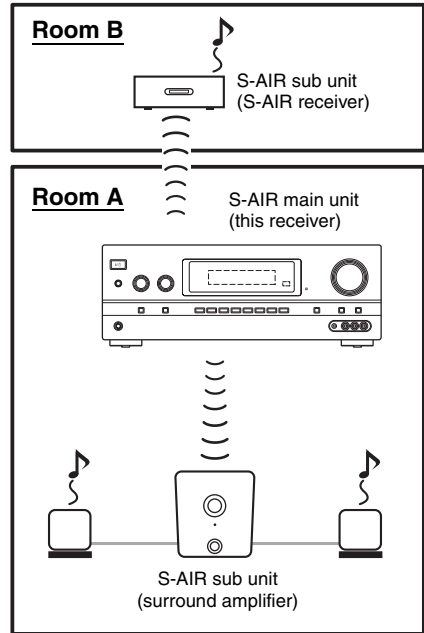

About environments where S-AIR products (S-AIR main unit and sub unit) are used

S-AIR products use a radio frequency of 2.4 GHz. Certain electronic equipment or other factors may cause lost connection or instability in S-AIR reception.

- Electronic equipment influence
The following may cause interference or cross talk.
 - Cellular phones, cordless phones
 - Wireless LAN, personal computers
 - Game machines using radio signals
 - Microwave ovens



- Other factors
 - The following may cause poor reception.
 - Materials or structures, such as walls and floors
 - The location where an S-AIR product is placed

When using S-AIR products, place them as far as possible from the above electronic equipment, or place where S-AIR reception is stable.

Setting up an S-AIR product

Before using an S-AIR product, be sure to perform the following settings to establish the sound transmission.

- Inserting the wireless transmitter/transceiver (page 31).
- Establishing sound transmission between the S-AIR main unit and S-AIR sub unit (ID setting) (page 61).
- Pairing the S-AIR main unit with a specific S-AIR sub unit (Pairing operation) (page 62).

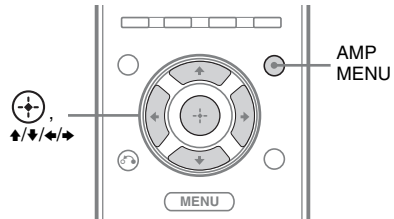

Establishing sound transmission between the S-AIR main unit and S-AIR sub unit (ID setting)

When you match the ID of the S-AIR main unit and the S-AIR sub unit, you can establish sound transmission. You can use multiple S-AIR main unit by setting a different ID for each unit.

To set the ID of the S-AIR main unit

- 1 Press AMP MENU.
- 2 Press \uparrow/\downarrow repeatedly to select “S-AIR”, then press \oplus or \rightarrow .
- 3 Press \uparrow/\downarrow repeatedly to select “ID SETUP”, then press \oplus or \rightarrow .
- 4 Press \uparrow/\downarrow repeatedly to select the ID (A, B or C) you want, then press \oplus .

To exit the menu

Press AMP MENU.

To set the ID of the S-AIR sub unit

Be sure to match the ID on S-AIR sub unit you want to the S-AIR main unit.

For details on setting the ID of the surround amplifier and S-AIR receiver, refer to the operating instructions supplied with the surround amplifier and S-AIR receiver.

Sound transmission is established as follows (example):

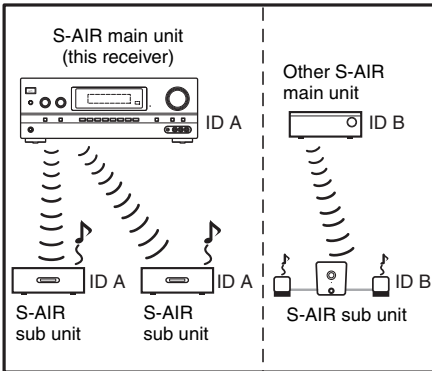

Notes

- Sources with copyright protection may not be playable on S-AIR sub unit.
- If you have connected surround amplifier, surround sound will not be output from S-AIR main unit.

Pairing the S-AIR main unit with a specific S-AIR sub unit (Pairing operation)

To establish sound transmission, you need to set the same ID for your S-AIR main unit and S-AIR sub unit.

However, if your neighbors have S-AIR products and their IDs are the same as yours, your neighbors could receive the sound of your S-AIR main unit or vice versa.

To prevent this, you can pair the S-AIR main unit with a specific S-AIR sub unit by performing the pairing operation.

■ Before pairing

Sound transmission is established by the ID (example).

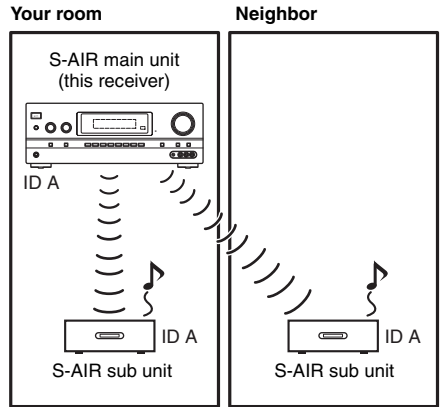

■ After pairing

Sound transmission is established between the paired S-AIR main unit and S-AIR sub unit(s) only.

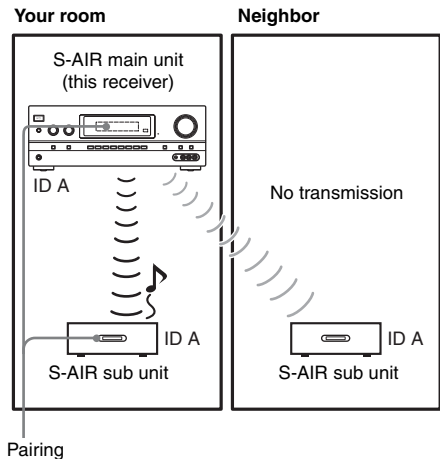

Pairing

To perform pairing

1 Place the S-AIR sub unit that you want to pair near the S-AIR main unit.

2 Match the IDs of the S-AIR main unit and the S-AIR sub unit.

- To set the ID of the S-AIR main unit, see “To set the ID of the S-AIR main unit” (page 61).
- To set the ID of the S-AIR sub unit, refer to the operating instructions supplied with the S-AIR sub unit.

3 Press AMP MENU.

4 Press \uparrow/\downarrow repeatedly to select “S-AIR”, then press \ominus or \rightarrow .

5 Press \uparrow/\downarrow repeatedly to select “PAIRING”, then press \ominus or \rightarrow .

6 Press \uparrow/\downarrow repeatedly to select the setting you want, then press \ominus .

- START: The S-AIR main unit starts pairing. “SEARCH” flashes on the display.
- STATUS: You can check the current ID. When the pairing setting is not made, “NO PAIR” appears on the display.

7 Start pairing of the S-AIR sub unit.

■ For the surround amplifier

Refer to the operating instructions supplied with the surround amplifier.

■ For the S-AIR receiver

Refer to the operating instructions supplied with the S-AIR receiver.

8 Pairing completed.

“COMPLETE” appears on the display.

To exit the menu

Press AMP MENU.

Note

Perform the pairing within several minutes after step 6. Otherwise, the pairing is canceled automatically and “ERROR” appears on the display.

To cancel pairing

Reset the ID of the S-AIR main unit.

For details, see “To set the ID of the S-AIR main unit” (page 61). You can select the same ID as before.

Enjoying the system's sound in another room

(For the S-AIR receiver only (not supplied))

You can enjoy the system's sound in another room by using the S-AIR receiver. The S-AIR receiver can be placed in another room for enjoying the system's sound there.

For details of the S-AIR receiver, refer to the operating instructions supplied with the S-AIR receiver.

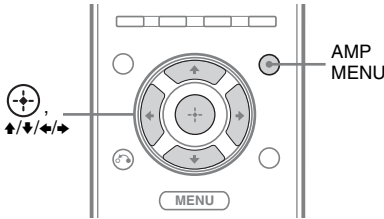

1 Set the ID of the S-AIR receiver to match the ID of the S-AIR main unit.

- To set the ID of the S-AIR main unit, see “To set the ID of the S-AIR main unit” (page 61).
- To set the ID of the S-AIR receiver, refer to the operating instructions supplied with the S-AIR receiver.

Notes

- When you are using another S-AIR sub unit, such as a surround amplifier, do not change the ID of the S-AIR main unit. Set the ID of the S-AIR receiver to match the ID of the S-AIR main unit.
- When you pair the S-AIR main unit and another S-AIR sub unit, such as a surround amplifier, you also need to pair the S-AIR main unit and the S-AIR receiver. For details, see “Pairing the S-AIR main unit with a specific S-AIR sub unit (Pairing operation)” (page 62).

2 Press AMP MENU.

3 Press \uparrow/\downarrow repeatedly to select “S-AIR”, then press \oplus or \rightarrow .

4 Press \uparrow/\downarrow repeatedly to select “MODE”, then press \oplus or \rightarrow .

5 Press \uparrow/\downarrow repeatedly to select the setting you want.

- PARTY: The S-AIR receiver outputs sound according to the input selected on the S-AIR main unit.
- SEPARATE: You can select the input you want for the S-AIR receiver while the input of the S-AIR main unit remain unchanged. When at SEPARATE mode, you can only select “SA-CD/CD”, “DMPORT”, “FM TUNER”, “AM TUNER” and the input that is currently selected at the S-AIR main unit.

Note

When “FM TUNER” or “AM TUNER” is selected on the S-AIR main unit, you can only select the same band for the tuner on the S-AIR receiver. However, you can select input other than TUNER on the S-AIR receiver.

6 Adjust the volume on the S-AIR receiver.

Notes

- The sound of the S-AIR receiver may be cut off by operation of the S-AIR main unit.
- When the sound is other than 2 channel stereo, multi channel sound is downmixed to 2 channel.
- Signals with a sampling frequency of more than 96 kHz cannot output to this S-AIR receiver.

To control the system from the S-AIR receiver

You can control the system from the S-AIR receiver by using the following buttons.

Press	Operation
\blacktriangleright , \parallel , \blacksquare , \blacktriangleleft , \blacktriangleright	Share the same operations on the remote.
S-AIR CH	Change the function of the system.

For details, refer to the operating instructions of the S-AIR receiver.

Changing the channel for better sound transmission

If you use multiple wireless systems which sharing the 2.4 GHz band, such as wireless LAN or Bluetooth, the transmission of S-AIR products or other wireless systems may be unstable. In this case, the transmission may be improved by changing the following “RF SETUP” setting.

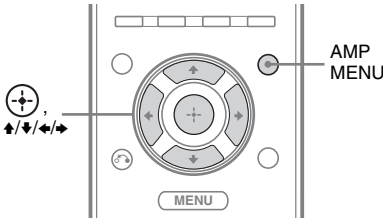

- 1** Press AMP MENU.
- 2** Press \uparrow/\downarrow repeatedly to select “S-AIR”, then press \oplus or \rightarrow .
- 3** Press \uparrow/\downarrow repeatedly to select “RF SETUP”, then press \oplus or \rightarrow .
- 4** Press \uparrow/\downarrow repeatedly to select the setting you want, then press \oplus .

- RF AUTO: Normally select this. The system changes “RF SETUP” to “RF ON” or “RF OFF” automatically.
- RF ON: The system transmits sound by searching the better channel for transmitting.
- RF OFF: The system transmits sound by fixing the channel for transmitting.

To exit the menu

Press AMP MENU.

Notes

- In most cases, you will not need to change this setting.
- If “RF SETUP” is set to “RF OFF”, transmission between the S-AIR main unit and S-AIR sub unit can be performed using one of the following channels.
 - S-AIR ID A: equivalent channel for IEEE 802.11b/g channel 1
 - S-AIR ID B: equivalent channel for IEEE 802.11b/g channel 6
 - S-AIR ID C: equivalent channel for IEEE 802.11b/g channel 11
- The transmission may be improved by changing the transmission channel (frequency) of the other wireless system(s). For details, refer to the operating instructions of the other wireless system(s).

Stabilizing S-AIR reception

Check the following when S-AIR reception is poor or unstable.

- Confirm the wireless adapters are inserted correctly (page 31).
- Confirm that the S-AIR IDs of the S-AIR main unit and sub unit are the same (page 61).

When S-AIR reception is poor

Check the following.

- Keep cords that are connected to the S-AIR product (AC power cord (mains lead), speaker cords, or other cords) away from the wireless adapter and slot.

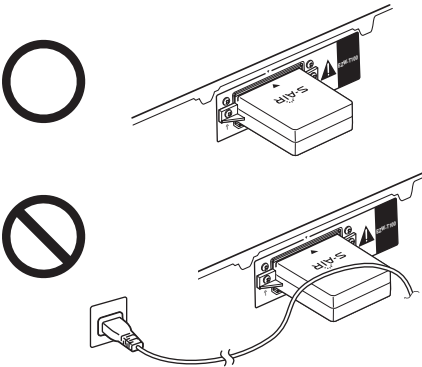

- Keep as much space as possible around S-AIR products.
 - Avoid placing S-AIR products on top of or directly below other electronic equipment.
 - Avoid placing S-AIR products in a closed rack, metal rack or under a table.

- Adjust the location (height, orientation, and place in the room) of S-AIR products until reception is the most stable.

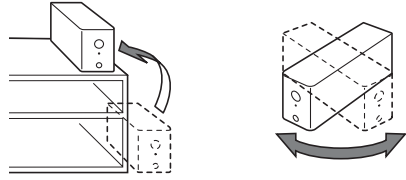

- Place so that the wireless adapters of the S-AIR main unit and sub unit are closer.

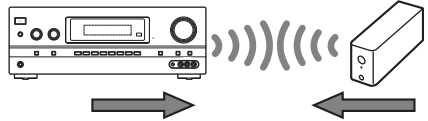

- Place so that S-AIR products are separated from other wireless devices.

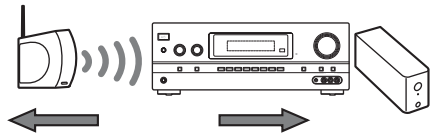

- Place so that S-AIR products are separated from metal doors or tables.

- If you still cannot improve S-AIR reception, change the “RF SETUP” setting (page 65).

Enjoying the S-AIR receiver while the S-AIR main unit is in standby mode

(For the S-AIR receiver only (not supplied))

You can enjoy the S-AIR receiver while the S-AIR main unit is in standby mode by setting "STANDBY" to "STBY ON".

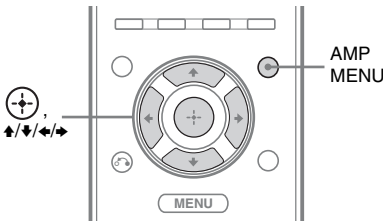

Notes

- When you set "STANDBY" to "STBY ON", the power consumption increases during the standby mode.
- When the wireless transmitter is removed from the S-AIR main unit, "STANDBY" is set to "STBY OFF" automatically.
- If you have selected "FM TUNER" or "AM TUNER" on the S-AIR main unit before you turn it off and "STANDBY" is set to "STBY ON", you can only select the same band for the tuner on the S-AIR receiver. However, you can select input other than TUNER on the S-AIR receiver.
- The sound of the S-AIR receiver may be cut off by operation of the S-AIR main unit.
- When the receiver is in standby mode, "S-AIR" indicator will lights up if "STANDBY" is set to "STBY ON".

- 1 Press AMP MENU.**
- 2 Press \uparrow/\downarrow repeatedly to select "S-AIR", then press \oplus or \rightarrow .**
- 3 Press \uparrow/\downarrow repeatedly to select "STANDBY", then press \oplus or \rightarrow .**
- 4 Press \uparrow/\downarrow repeatedly to select the setting you want.**
 - STBY OFF: You cannot enjoy the S-AIR receiver while the S-AIR main unit is in standby mode.
 - STBY ON: You can enjoy the S-AIR receiver while the S-AIR main unit is in standby mode or turned on.

To exit the menu

Press AMP MENU.

Switching between digital and analog audio (INPUT MODE)

When you connect components to both digital and analog input jacks on the receiver, you can fix the audio input mode to either of them, or switch from one to the other, depending on the type of material you intend to watch.

1 Turn INPUT SELECTOR on the receiver to select the input.

You can also use the input buttons on the remote.

2 Press INPUT MODE repeatedly on the receiver to select the audio input mode.

The selected audio input mode appears on the display.

Audio input modes

■ AUTO

Gives priority to digital audio signals when there are both digital and analog connections. If there are no digital audio signals, analog audio signals are selected.

■ ANALOG

Specifies the analog audio signals input to the AUDIO IN (L/R) jacks.

Notes

- Some audio input modes may not be set up depending on the input.
- When the Analog Direct function is selected, audio input is set to "ANALOG" automatically and you cannot select other modes.
- When HDMI 1-3 or DMPORT input is selected, "-----" appears on the display, and you cannot select other modes. Select an input mode other than the HDMI 1-3 and DMPORT input, then set the audio input mode.

Enjoying the sound/ images from other inputs

You can reassign audio and/or video signals to another input when they are not currently being used.

For example when you want to connect your DVD player but cannot find an unused input:

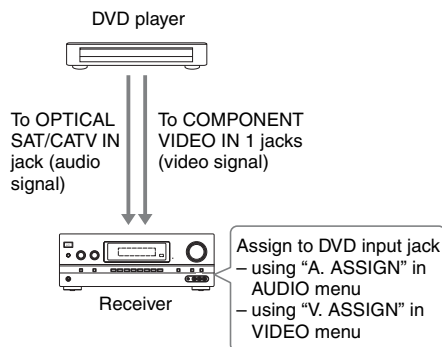

1 Press AMP MENU.

2 Press \uparrow/\downarrow repeatedly to select "AUDIO" or "VIDEO", then press \oplus or \rightarrow .

3 Press \uparrow/\downarrow repeatedly to select "A. ASSIGN" or "V. ASSIGN", then press \oplus or \rightarrow .

4 Press \uparrow/\downarrow repeatedly to select the input name you want to assign (for example, "DVD").

5 Press \oplus or \rightarrow to enter your selection.

6 Press \uparrow/\downarrow repeatedly to select the input jack you want to assign to the input which you selected in step 4.

To return to the previous display

Press \leftarrow .

Assigning input jacks

Assignable input jacks		Input name					
		VIDEO1	VIDEO2	BD	DVD	SAT	SA-CD
Video	CMPNT 1 (Component 1)	<input type="radio"/>	<input type="radio"/>	<input type="radio"/> *	<input type="radio"/>	<input type="radio"/>	<input type="radio"/>
	CMPNT 2 (Component 2)	<input type="radio"/>	<input type="radio"/>	<input type="radio"/>	<input type="radio"/> *	<input type="radio"/>	<input type="radio"/>
	CMPNT 3 (Component 3)	<input type="radio"/>	<input type="radio"/>	<input type="radio"/>	<input type="radio"/>	<input type="radio"/> *	<input type="radio"/>
	HDMI1	<input type="radio"/>	<input type="radio"/>	<input type="radio"/>	<input type="radio"/>	<input type="radio"/>	<input type="radio"/>
	HDMI2	<input type="radio"/>	<input type="radio"/>	<input type="radio"/>	<input type="radio"/>	<input type="radio"/>	<input type="radio"/>
	HDMI3	<input type="radio"/>	<input type="radio"/>	<input type="radio"/>	<input type="radio"/>	<input type="radio"/>	<input type="radio"/>
	COMP (Composite)	<input type="radio"/> *	<input type="radio"/> *	<input type="radio"/>	–	<input type="radio"/>	–
	NONE	–	–	–	<input type="radio"/>	–	<input type="radio"/> *
Audio	DVD COAX	<input type="radio"/>	<input type="radio"/>	<input type="radio"/>	<input type="radio"/> *	<input type="radio"/>	<input type="radio"/>
	SAT OPT	<input type="radio"/>	<input type="radio"/>	<input type="radio"/>	<input type="radio"/>	<input type="radio"/> *	<input type="radio"/>
	ANALOG	<input type="radio"/> *	<input type="radio"/> *	<input type="radio"/> *	–	<input type="radio"/>	<input type="radio"/> *

* Initial setting

Notes

- When you assign the digital audio input, the INPUT MODE setting may change automatically (page 68).
- You cannot reassign more than one HDMI input to the same input.
- You cannot reassign more than one digital audio input to the same input.
- You cannot reassign more than one component video input to the same input.

Enjoying sound/images from the components connected to the DIGITAL MEDIA PORT

The DIGITAL MEDIA PORT (DMPORT) allows you to enjoy sound/images from a portable audio source or computer by connecting a DIGITAL MEDIA PORT adapter.

The DIGITAL MEDIA PORT adapters are available for purchase depending on the area. For details on connecting the DIGITAL MEDIA PORT adapter, see “4a: Connecting the audio components” (page 22).

Notes

- Depending on the DIGITAL MEDIA PORT adapter, video output may not be possible.
- Depending on the type of DIGITAL MEDIA PORT adapter, you can operate the connected component by using the remote. For details on the remote button operation, see page 15.

1 Press DMPORT.

You can also use the INPUT SELECTOR on the receiver to select “DMPORT”.

2 Start playback of the connected component.

The sound is played back on the receiver and the image appears on the TV. For details, refer to the operating instructions supplied with the DIGITAL MEDIA PORT adapter.

Tip

When listening to MP3 or other compressed music using a portable audio source, you can enhance the sound. Press SOUND FIELD +/- repeatedly to select “PORTABLE” (page 51).

Using a bi-amplifier connection

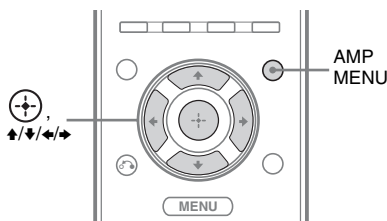

- 1 Press AMP MENU.
- 2 Press \uparrow/\downarrow repeatedly to select “SPKR”, then press \oplus or \rightarrow .
- 3 Press \uparrow/\downarrow repeatedly to select “PATTERN”, then press \oplus or \rightarrow .
- 4 Press \uparrow/\downarrow select the appropriate speaker pattern so that there are no surround back speakers and front high speakers.
- 5 Press \oplus or \leftarrow .
- 6 Press \uparrow/\downarrow repeatedly to select “SB ASGN”, then press \oplus or \rightarrow .
- 7 Press \uparrow/\downarrow repeatedly to select “BI-AMP”.

The same signals output from the SPEAKERS FRONT A terminals can be output from the SPEAKERS SURROUND BACK/FRONT HIGH/BI-AMP/FRONT B terminals.

To exit the menu

Press AMP MENU.

Notes

- Set “SB ASGN” to “BI-AMP” before you perform Auto Calibration.
- If you set “SB ASGN” to “BI-AMP”, the speaker level and distance settings of the surround back speakers and front high speakers become invalid, and those of the front speakers are used.
- If you set “PATTERN” to a setting with surround back speakers or front high speakers, you cannot set “SB ASGN” to “BI-AMP”.

Using the setting menu

By using the amplifier menus, you can make various adjustments to customize the receiver.

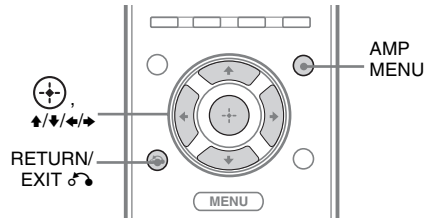

- 1 Press AMP MENU.**
- 2 Press \uparrow/\downarrow repeatedly to select the menu you want, then press \oplus or \rightarrow .**
- 3 Press \uparrow/\downarrow repeatedly to select the parameter you want to adjust, then press \oplus or \rightarrow .**
- 4 Press \uparrow/\downarrow repeatedly to select the setting you want.**

The setting is entered automatically.

To return to the previous display

Press \leftarrow or RETURN/EXIT \rightarrow .

To exit the menu

Press AMP MENU.

Note

Some parameters and settings may appear dimmed on the display. This means that they are either unavailable or fixed and unchangeable.

Overview of the menus

The following options are available in each menu. For details, see the page in the parentheses.

Menu [Display]	Parameters [Display]	Settings	Initial setting
AUTO CAL [A. CAL] (page 39)	Starts Auto Calibration [START]		
	Calibration type [CAL TYPE]	FULL.FLAT, ENGINEER FRONT.REF, OFF	FULL.FLAT
	Position [POSITION]	POS 1, POS 2, POS 3	POS 1
	Naming position [NAME IN]	For details, see page 39.	
LEVEL [LEVEL] (page 76)	Test tone ^{a)} [T. TONE]	OFF, AUTO ■■■■ ^{b)}	OFF
	Front left speaker level ^{a)} [FL LVL]	FL -10.0 dB to FL +10.0 dB (0.5 dB step)	FL 0 dB
	Front right speaker level ^{a)} [FR LVL]	FR -10.0 dB to FR +10.0 dB (0.5 dB step)	FR 0 dB
	Center speaker level ^{a)} [CNT LVL]	CNT -20.0 dB to CNT +10.0 dB (0.5 dB step)	CNT 0 dB
	Surround left speaker level ^{a)} [SL LVL]	SL -20.0 dB to SL +10.0 dB (0.5 dB step)	SL 0 dB
	Surround right speaker level ^{a)} [SR LVL]	SR -20.0 dB to SR +10.0 dB (0.5 dB step)	SR 0 dB
	Surround back speaker level ^{a)} [SB LVL]	SB -20.0 dB to SB +10.0 dB (0.5 dB step)	SB 0 dB
	Surround back left speaker level ^{a)} [SBL LVL]	SBL -20.0 dB to SBL +10.0 dB (0.5 dB step)	SBL 0 dB
	Surround back right speaker level ^{a)} [SBR LVL]	SBR -20.0 dB to SBR +10.0 dB (0.5 dB step)	SBR 0 dB
	Front left high speaker level ^{a)} [LH LVL]	LH -20.0 dB to LH +10.0 dB (0.5 dB step)	LH 0 dB
	Front right high speaker level ^{a)} [RH LVL]	RH -20.0 dB to RH +10.0 dB (0.5 dB step)	RH 0 dB
	Subwoofer level ^{a)} [SW LVL]	SW -20.0 dB to SW +10.0 dB (0.5 dB step)	SW 0 dB
	Dynamic range compressor [D. RANGE]	COMP. MAX, COMP. STD, COMP.AUTO, COMP. OFF	COMP.AUTO

Menu [Display]	Parameters [Display]	Settings	Initial setting
SPEAKER [SPKR] (page 77)	Speaker pattern [PATTERN]	For details, see page 77.	3/4.1
	Front speakers size ^{a)} [FRT SIZE]	LARGE, SMALL	LARGE
	Center speaker size ^{a)} [CNT SIZE]	LARGE, SMALL	LARGE
	Surround speakers size ^{a)} [SUR SIZE]	LARGE, SMALL	LARGE
	Front high speakers size ^{a)} [FH SIZE]	LARGE, SMALL	LARGE
	Surround back speaker assign ^{c)} [SB ASGN]	SPK B, BI-AMP, OFF	OFF
	Front left speaker distance ^{a)} [FL DIST.]		
	Front right speaker distance ^{a)} [FR DIST.]		
	Center speaker distance ^{a)} [CNT DIST.]		
	Surround left speaker distance ^{a)} [SL DIST.]		
	Surround right speaker distance ^{a)} [SR DIST.]		
	Surround back speaker distance ^{a)} [SB DIST.]	3'3" to 32'9" (1 inch step) 1.00 m to 10.00 m (0.01 m step)	9'10" 3.00 m
	Surround back left speaker distance ^{a)} [SBL DIST.]		
	Surround back right speaker distance ^{a)} [SBR DIST.]		
	Front left high speaker distance ^{a)} [LH DIST.]		
	Front right high speaker distance ^{a)} [RH DIST.]		
	Subwoofer distance ^{a)} [SW DIST.]		
	Distance unit [DIST.UNIT]	METER, FEET	FEET ^{d)}
	Front speaker crossover frequency ^{e)} [FRT CRS.]	CRS. 40 Hz to CRS. 200 Hz (10 Hz step)	CRS. 120 Hz

Menu [Display]	Parameters [Display]	Settings	Initial setting
	Center speaker crossover frequency ^{e)} [CNT CRS.]	CRS. 40 Hz to CRS. 200 Hz (10 Hz step)	CRS. 120 Hz
	Surround speaker crossover frequency ^{e)} [SUR CRS.]	CRS. 40 Hz to CRS. 200 Hz (10 Hz step)	CRS. 120 Hz
	Front high speaker crossover frequency ^{e)} [FH CRS.]	CRS. 40 Hz to CRS. 200 Hz (10 Hz step)	CRS. 120 Hz
SURROUND [SURR] (page 80)	Sound field selection [S.F. SELCT]	For details, see “Enjoying Surround Sound” (page 50).	A.F.D. AUTO
	Effect level [EFFECT]	EFCT. MIN, EFCT. STD, EFCT. MAX	EFCT. STD
EQ [EQ] (page 80)	Front speakers bass level [BASS]	BASS –10 dB to BASS +10 dB (1 dB step)	BASS 0 dB
	Front speakers treble level [TREBLE]	TRE –10 dB to TRE +10 dB (1 dB step)	TRE 0 dB
TUNER [TUNER] (page 80)	FM station receiving mode [FM MODE]	STEREO, MONO	STEREO
	Naming preset stations [NAME IN]	For details, see “Naming preset stations” (page 48).	
AUDIO [AUDIO] (page 81)	Synchronizes audio with video output [A/V SYNC]	SYNC 0 to SYNC 30	SYNC 0
	Digital broadcast language selection [DUAL]	MAIN/SUB, MAIN, SUB	MAIN
	Digital audio input decoding priority [DEC. PRIO]	DEC. AUTO, DEC. PCM	DEC. AUTO
	Digital audio input assignment [A. ASSIGN]	For details, see “Enjoying the sound/ images from other inputs” (page 68).	
	Night mode [NIGHT M.]	NIGHT.OFF, NIGHT. ON	NIGHT.OFF
VIDEO [VIDEO] (page 81)	Video input assignment [V. ASSIGN]	For details, see “Enjoying the sound/ images from other inputs” (page 68).	

Menu [Display]	Parameters [Display]	Settings	Initial setting
HDMI [HDMI] (page 82)	Control for HDMI [CTRL.HDMI]	CTRL ON, CTRL OFF	CTRL ON
	HDMI pass through [PASS.THRU]	ON, AUTO, OFF	OFF
	Setting HDMI audio input [AUDIO.OUT]	TV+AMP, AMP	AMP
	Subwoofer level for HDMI ^{f)} [SW LEVEL]	SW AUTO, SW +10 dB, SW 0 dB	SW AUTO
	Subwoofer Low Pass Filter for HDMI ^{f)} [SW L.P.F.]	L.P.F. ON, L.P.F. OFF	L.P.F. ON
	Audio Return Channel [ARC]	ARC ON, ARC OFF	ARC ON
SYSTEM [SYSTEM] (page 83)	Brightness of the display [DIMMER]	DIM MAX, DIM MID, DIM OFF	DIM OFF
	Sleep timer mode [SLEEP]	OFF, 0-30-00, 1-00-00, 1-30-00, 2-00-00	OFF
	Auto standby mode [AUTO.STBY]	STBY ON, STBY OFF	STBY ON
	Naming inputs [NAME IN]	For details, see “Naming inputs” (page 43).	
S-AIR [S-AIR] (page 83)	S-AIR ID ^{g)} [ID SETUP]	ID: A, ID: B, ID: C	ID: A
	Pairing ^{g)} [PAIRING]	START, STATUS	START
	S-AIR mode ^{g)} [MODE]	PARTY, SEPARATE	PARTY
	RF Change ^{g)} [RF SETUP]	RF AUTO, RF ON, RF OFF	RF AUTO
	S-AIR Standby ^{g)} [STANDBY]	STBY ON, STBY OFF	STBY OFF

a) Depends on the speaker pattern setting, some parameters may not be available.

b) ■■■ represent a speaker channel (FL, FR, CNT, SL, SR, SB, SBL, SBR, LH, RH, SW).

c) You can only select this parameter if “PATTERN” is not set to a setting with surround back speakers or front high speakers (page 77).

d) “METER” for models of area code AU1 and TW2.

e) You cannot select this setting if your speaker is set to “LARGE”.

f) This parameter is only available when HDMI input signals is detected.

g) This parameter is only available if the S-AIR transmitter (not supplied) is inserted to the EZW-T100 slot on the receiver.

LEVEL menu

You can adjust the level of each speaker. These settings are applied to all sound fields.

■ T. TONE

Lets you adjust the speaker levels while listening to the test tone from your listening position.

- OFF
The test tone is turned off.
- AUTO ■■■■*
The test tone is output from each speaker in sequence.

* ■■■■ represent a speaker channel.

Adjusting the speaker level

You can adjust each speaker's level using the following parameters.

For front left/right speakers, you can adjust the level from -10.0 dB to +10.0 dB in 0.5 dB steps. For other speakers, you can adjust the level from -20.0 dB to +10.0 dB in 0.5 dB steps.

■ FL LVL

■ FR LVL

■ CNT LVL

■ SL LVL

■ SR LVL

■ SB LVL

■ SBL LVL

■ SBR LVL

■ LH LVL

■ RH LVL

■ SW LVL

Note

Depends on the speaker pattern setting, some parameters may not be available.

■ D. RANGE

Lets you compress the dynamic range of the soundtrack. This may be useful when you want to watch movies at low volumes late at night. Dynamic range compression is possible with Dolby Digital sources only.

- COMP. MAX
The dynamic range is compressed dramatically.
- COMP. STD
The dynamic range is compressed as intended by the recording engineer.
- COMP.AUTO
The dynamic range is compressed automatically.
- COMP. OFF
The dynamic range is not compressed.

Tip

Dynamic range compressor lets you compress the dynamic range of the soundtrack based on the dynamic range information included in the Dolby Digital signal.

“COMP. STD” is the standard setting, but it only enacts light compression. Therefore, we recommend using the “COMP. MAX” setting. This greatly compresses the dynamic range and lets you view movies late at night at low volumes. Unlike analog limiters, the levels are predetermined and provide a very natural compression.

SPEAKER menu

You can set the size and distance of the speakers connected to this receiver.

■ PATTERN

Lets you set the number of speakers connected to this receiver. It should be synchronize with the speakers settings.

For example:

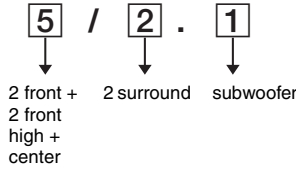

Speaker pattern	Front left/right	Front left/right high	Center	Surround left/right	Surround back left	Surround back right	Subwoofer
5/2.1	<input type="radio"/>	<input type="radio"/>	<input type="radio"/>	<input type="radio"/>	–	–	<input type="radio"/>
5/2	<input type="radio"/>	<input type="radio"/>	<input type="radio"/>	<input type="radio"/>	–	–	–
4/2.1	<input type="radio"/>	<input type="radio"/>	–	<input type="radio"/>	–	–	<input type="radio"/>
4/2	<input type="radio"/>	<input type="radio"/>	–	<input type="radio"/>	–	–	–
3/4.1	<input type="radio"/>	–	<input type="radio"/>	<input type="radio"/>	<input type="radio"/>	<input type="radio"/>	<input type="radio"/>
3/4	<input type="radio"/>	–	<input type="radio"/>	<input type="radio"/>	<input type="radio"/>	<input type="radio"/>	–
2/4.1	<input type="radio"/>	–	–	<input type="radio"/>	<input type="radio"/>	<input type="radio"/>	<input type="radio"/>
2/4	<input type="radio"/>	–	–	<input type="radio"/>	<input type="radio"/>	<input type="radio"/>	–
3/3.1	<input type="radio"/>	–	<input type="radio"/>	<input type="radio"/>	<input type="radio"/>	–	<input type="radio"/>
3/3	<input type="radio"/>	–	<input type="radio"/>	<input type="radio"/>	<input type="radio"/>	–	–
2/3.1	<input type="radio"/>	–	–	<input type="radio"/>	<input type="radio"/>	–	<input type="radio"/>
2/3	<input type="radio"/>	–	–	<input type="radio"/>	<input type="radio"/>	–	–
3/2.1	<input type="radio"/>	–	<input type="radio"/>	<input type="radio"/>	–	–	<input type="radio"/>
3/2	<input type="radio"/>	–	<input type="radio"/>	<input type="radio"/>	–	–	–
2/2.1	<input type="radio"/>	–	–	<input type="radio"/>	–	–	<input type="radio"/>
2/2	<input type="radio"/>	–	–	<input type="radio"/>	–	–	–
3/0.1	<input type="radio"/>	–	<input type="radio"/>	–	–	–	<input type="radio"/>
3/0	<input type="radio"/>	–	<input type="radio"/>	–	–	–	–
2/0.1	<input type="radio"/>	–	–	–	–	–	<input type="radio"/>
2/0	<input type="radio"/>	–	–	–	–	–	–

■ FRT SIZE

- **LARGE**

If you connect large speakers that will effectively reproduce bass frequencies, select “LARGE”. Normally, select “LARGE”. However, if you have selected a speaker pattern without subwoofer, the front speakers are automatically set to “LARGE”.

- **SMALL**

If the sound is distorted, or you feel a lack of surround effects when using multi channel surround sound, select “SMALL” to activate the bass redirection circuitry and output the front channel bass frequencies from the subwoofer. When the front speakers are set to “SMALL”, the center, surround and front high speakers are also automatically set to “SMALL”.

■ CNT SIZE

- **LARGE**

If you connect a large speaker that will effectively reproduce bass frequencies, select “LARGE”. Normally, select “LARGE”. However, if the front speakers are set to “SMALL”, you cannot set the center speaker to “LARGE”.

- **SMALL**

If the sound is distorted, or you feel a lack of surround effects when using multi channel surround sound, select “SMALL” to activate the bass redirection circuitry and output the center channel bass frequencies from the front speakers (if set to “LARGE”) or subwoofer.

■ SUR SIZE

The surround back speakers will be set to the same setting.

- **LARGE**

If you connect large speakers that will effectively reproduce bass frequencies, select “LARGE”. Normally, select “LARGE”. However, if the front speakers are set to “SMALL”, you cannot set the surround speakers to “LARGE”.

- **SMALL**

If the sound is distorted, or you feel a lack of surround effects when using multi channel surround sound, select “SMALL” to activate the bass redirection circuitry and output the surround channel bass frequencies from the subwoofer or other speaker that is set to “LARGE”.

■ FH SIZE

- **LARGE**

If you connect large speakers that will effectively reproduce bass frequencies, select “LARGE”. Normally, select “LARGE”. However, if the front speakers are set to “SMALL”, you cannot set front high speakers to “LARGE”.

- **SMALL**

If the sound is distorted, or you feel a lack of surround effects when using multi channel surround sound, select “SMALL” to activate the bass redirection circuitry and output the front high channel bass frequencies from the subwoofer or other speaker that is set to “LARGE”.

Tip

The “LARGE” and “SMALL” settings for each speaker determine whether the internal sound processor will cut the bass signal from that channel. When the bass is cut from a channel, the bass redirection circuitry sends the corresponding bass frequencies to the subwoofer or other “LARGE” speakers.

However, since bass sounds have a certain amount of directionality, it is best not to cut them, if possible. Therefore, even when using small speakers, you can set them to “LARGE” if you want to output the bass frequencies from that speaker. On the other hand, if you are using a large speaker, but prefer not to have bass frequencies output from that speaker, set it to “SMALL”.

If the overall sound level is lower than you prefer, set all speakers to “LARGE”. If there is not enough bass, you can use the equalizer to boost the bass levels. For details, see page 80.

■ SB ASGN**• SPK B**

If you connect an additional front speaker system to the SPEAKERS SURROUND BACK/FRONT HIGH/BI-AMP/FRONT B terminals, select “SPK B”.

• BI-AMP

If you connect front speakers to the SPEAKERS SURROUND BACK/FRONT HIGH/BI-AMP/FRONT B terminals using a bi-amplifier connection, select “BI-AMP”.

• OFF

If you connect surround back speakers or front high speakers to the SPEAKERS SURROUND BACK/FRONT HIGH/BI-AMP/FRONT B terminals, select “OFF”.

Note

When you change the connection from bi-amplifier or speaker front B to surround back or front high speakers connection, set “SB ASGN” to “OFF”, then perform the Auto Calibration again (page 35).

■ FL DIST.**■ FR DIST.**

Lets you set the distance from your listening position to the front speakers.

If both front speakers are not placed an equal distance from your listening position, set the distance to the closest speaker.

■ CNT DIST.

Lets you set the distance from your listening position to the center speaker.

■ SL DIST.**■ SR DIST.**

Lets you set the distance from your listening position to the surround speakers.

■ SB DIST.**■ SBL DIST.****■ SBR DIST.**

Lets you set the distance from your listening position to the surround back speakers.

■ LH DIST.**■ RH DIST.**

Lets you set the distance from your listening position to the front high speakers.

■ SW DIST.

Lets you set the distance from your listening position to the subwoofer.

Notes

- Depends on the speaker pattern setting. Some parameters may not be available.
- This function does not work in the following cases.
 - Signals with a sampling frequency of more than 96 kHz are being received.
 - Analog Direct is selected.

■ DIST.UNIT

Lets you select the unit of measure for setting distances.

• METER

The distance is displayed in meters.

• FEET

The distance is displayed in feet.

■ FRT CRS.

Lets you set the bass crossover frequency of the front speakers that have been set to "SMALL" in the SPEAKER menu.

■ CNT CRS.

Lets you set the bass crossover frequency of the center speaker that have been set to "SMALL" in the SPEAKER menu.

■ SUR CRS.

Lets you set the bass crossover frequency of the surround speakers that have been set to "SMALL" in the SPEAKER menu.

■ FH CRS.

Lets you set the bass crossover frequency of the front high speakers that have been set to "SMALL" in the SPEAKER menu.

SURROUND menu

You can select the sound field you want for your listening pleasure.

■ S.F. SELCT

Lets you select the sound field you want. For details, see "Enjoying Surround Sound" (page 50).

Note

The receiver lets you apply the last selected sound field to an input whenever it is selected (Sound Field Link). For example, if you select "HALL" for the DVD input, then change to a different input and then return to DVD, "HALL" will automatically be applied again.

■ EFFECT

Lets you adjust the "presence" of the surround effect for the Cinema Studio EX A/B/C sound fields.

EQ menu

You can adjust the tonal quality (bass/treble level) of the front speakers.

■ BASS

■ TREBLE

Note

This function does not work in the following cases.

- Signals with a sampling frequency of more than 48 kHz are being received.
- Analog Direct is selected.

Tip

You can also adjust the front speaker bass and treble level with TONE MODE and TONE +/- on the receiver (page 7).

TUNER menu

You can set the FM station receiving mode and name the preset stations.

■ FM MODE

- STEREO
This receiver will decode the signal as stereo signal when the radio station is broadcast in stereo.
- MONO
This receiver will decode the signal as mono signal regardless of the broadcast signal.

■ NAME IN

Lets you set the name of preset stations. For details, see "Naming preset stations" (page 48).

AUDIO menu

You can make settings for the audio to suit your preference.

■ A/V SYNC

Lets you delay the output of audio to minimize the time gap between audio output and visual display. You can adjust from 0 (0 ms) to 30 (300 ms) in 1 (10 ms) steps.

Notes

- This parameter is useful when you use a large LCD or plasma monitor or a projector.
- This function does not work in the following cases.
 - Multi channel Linear PCM and Dolby TrueHD signals with a sampling frequency of more than 96 kHz are being received.
 - Analog Direct is selected.

■ DUAL

Lets you select the language you want to listen to during digital broadcast. This feature only functions for Dolby Digital sources.

- MAIN/SUB
Sound of the main language will be output through the front left speaker and sound of the sub language will be output through the front right speaker simultaneously.
- MAIN
Sound of the main language will be output.
- SUB
Sound of the sub language will be output.

■ DEC. PRIO

Lets you specify the input mode for the digital signal input to the DIGITAL IN jacks or HDMI IN jacks.

- DEC. AUTO
Automatically switches the input mode between DTS, Dolby Digital, or PCM.

- DEC. PCM

When signals from the DIGITAL IN jack are selected, PCM signals are given priority (to prevent interruption when playback starts). However, when other signals are input, there may be no sound, depending on the format. In this case, set this item to “DEC. AUTO”. When signals from the HDMI IN jack are selected, only PCM signals are output from the connected player. When signals in any other format are received, set this item to “DEC. AUTO”.

Notes

- Even when “DEC. PRIO” is set to “DEC. PCM”, the sound may be interrupted at the very beginning of the first track depending on the CD being played back.
- When playback DTS CD, set “DEC. PRIO” to “DEC. AUTO”.

■ A. ASSIGN

Lets you assign the digital audio input to other input source. For details, see “Enjoying the sound/images from other inputs” (page 68).

■ NIGHT M.

Lets you to retain a theater-like environment at low volume levels. For details, see “Enjoying the surround effect at low volume levels (NIGHT MODE)” (page 54).

- NIGHT.OFF
- NIGHT. ON

VIDEO menu

You can assign the video input to other input source.

■ V. ASSIGN

Lets you assign the video input to other input source. For details, see “Enjoying the sound/ images from other inputs” (page 68).

HDMI menu

You can make various adjustments for HDMI settings.

■ CTRL.HDMI

Lets you turn the Control for HDMI function on or off. For details, see ““BRAVIA” Sync Features” (page 55).

■ PASS.THRU

Lets you output the HDMI signals to the TV even when the receiver is in standby mode.

- ON

When the receiver is in the standby mode, the receiver continuously outputs HDMI signals from the receiver's HDMI TV OUT jack.

- AUTO

When the TV is turned on while the receiver is in the standby mode, the receiver outputs HDMI signals from the receiver's HDMI TV OUT jack. Sony recommends this setting if you use a TV that is compatible with “BRAVIA” Sync. This setting saves power in the standby mode compared with the “ON” setting.

- OFF

The receiver does not output HDMI signals when in the standby mode. Turn on the receiver to enjoy the connected component's source on the TV. This setting saves power in the standby mode compared with the “ON” setting.

Notes

- This parameter is not available when “CTRL.HDMI” is set to “CTRL OFF”.
- When “AUTO” is selected, it may take a little more time for the image and sound to be output to the TV than when “ON” is selected.
- When the receiver is in standby mode, “HDMI” indicator will lights up if “PASS.THRU” is set to “AUTO” or “ON”. However, when “PASS.THRU” is set to “AUTO”, this indicator will lights off if no signals are detected.

■ AUDIO.OUT

Lets you set the HDMI audio output from the playback component connected to the receiver via an HDMI connection.

- TV+AMP

The sound is output from TV's speaker and the speakers connected to the receiver.

Notes

- The sound quality of the playback component depends on the TV's sound quality, such as the number of channels, and the sampling frequency, etc. When the TV has stereo speakers, the sound output from the receiver is also stereo as that of the TV, even if you play back multi channel software.
 - When you connect the receiver to an image display component (projector, etc.), sound may not be output from the receiver. In this case, select “AMP”.
- AMP
- The HDMI audio signals from the playback component are only output to the speakers connected to the receiver. Multi channel sound can be played back as it is.

Note

Audio signals are not output from the TV's speakers when “AUDIO.OUT” is set to “AMP”.

■ SW LEVEL

Lets you set the level of the subwoofer to 0 dB or +10 dB when multi channel Linear PCM signals are input via an HDMI connection. You can set the level for each HDMI input independently.

- SW AUTO

Automatically sets the level to 0 dB or +10 dB depending on the frequency.

- SW +10 dB

- SW 0 dB

Note

This parameter is only available when HDMI input signals are detected.

■ SW L.P.F.

Lets you set the low pass filter of the subwoofer when multi channel Linear PCM signals are input via an HDMI connection. Set the “SW L.P.F.” if your connected subwoofer’s crossover frequency do not have low pass filter.

- L.P.F. ON
The low pass filter of the subwoofer’s cut off frequency is set to 120 Hz.
- L.P.F. OFF
The low pass filter of the subwoofer is turned off.

Note

This parameter is only available when HDMI input signals are detected.

■ ARC

Lets you enjoy the TV sound from the speakers connected to the receiver via an HDMI cable. For details, see “Enjoying the TV sound via an HDMI cable (Audio Return Channel)” (page 59).

- ARC ON
Audio signal is input to the HDMI TV OUT jack.
- ARC OFF
Audio signal is input to the TV OPTICAL IN jack or TV AUDIO IN jack.

Note

This parameter is not available when “CTRL.HDMI” is set to “CTRL OFF”.

SYSTEM menu

You can customize the settings of the receiver.

■ DIMMER

Lets you adjust the brightness of the display in 3 levels.

■ SLEEP

Lets you set the Sleep Timer on the receiver to turn off automatically at the specific time. For details, see “Using the Sleep Timer” (page 44).

■ AUTO.STBY

Lets you set the receiver switch to standby mode automatically after 30 minutes when you do not operate the receiver or when there is no signals input to the receiver.

- STBY ON
Switches to standby mode after approximately 30 minutes.
- STBY OFF
Does not switch to standby mode.

Notes

- This function does not work in the following cases.
 - TUNER input is selected.
 - S-AIR receiver or surround amplifier is linked.
- If you use the auto standby mode and the Sleep Timer at the same time, the Sleep Timer has priority.

■ NAME IN

Lets you set the name of inputs. For details, see “Naming inputs” (page 43).

S-AIR menu

For details on S-AIR, see “S-AIR Operations” (page 60).

Using the Remote

Changing the input button assignments

You can change the initial settings of the input buttons to suit the components in your system. For example, if you connect a Blu-ray disc player to the DVD jack on the receiver, you can set the DVD button on this remote to control the Blu-ray disc player.

Note

You cannot change the remote assignments for TV, VIDEO 2, DMPORT, TUNER, HDMI 2 and HDMI 3 input buttons.

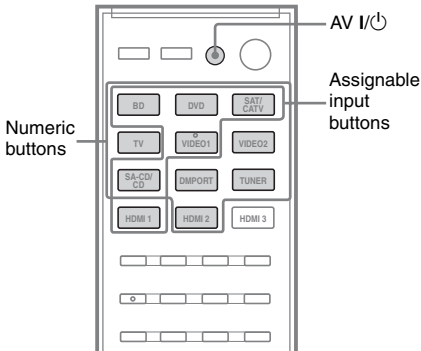

- 1 While holding down the input button of which you want to change the assignment, hold down AV I/⏻.**

Example: While holding down DVD, hold down AV I/⏻.

- 2 With the AV I/⏻ button held, release the input button you selected in step 1.**

Example: With the AV I/⏻ button held, release DVD.

- 3 Referring to the following table, press the corresponding button for the category you want, then release AV I/⏻.**

Example: Press 1, then release AV I/⏻. Now you can use the DVD button to control the Blu-ray disc player.

Categories and the corresponding buttons for BD, DVD, SAT/CATV, VIDEO 1, SA-CD/CD and HDMI 1

Categories	Press
Blu-ray disc player (command mode BD1) ^{a)}	1
Blu-ray disc recorder (command mode BD3) ^{a)}	2
DVD player (command mode DVD1)	3
DVD recorder (command mode DVD3) ^{b)}	4
VCR (command mode VTR3) ^{c)}	5
CD player	6
DSS (Digital Satellite Receiver) ^{d)} /Euro Digital Satellite Receiver ^{e)}	7

^{a)} For details on the BD1 or BD3 setting, refer to the operating instructions supplied with the Blu-ray disc player or Blu-ray disc recorder.

^{b)} Sony DVD recorders are operated with a DVD1 or DVD3 setting. For details, refer to the operating instructions supplied with the DVD recorders.

^{c)} Sony VCRs are operated with a VTR 2 or VTR 3 setting which corresponds to 8 mm and VHS respectively.

^{d)} RM-AAU073 only

^{e)} RM-AAU075 only

Clearing all the contents of the remote's memory

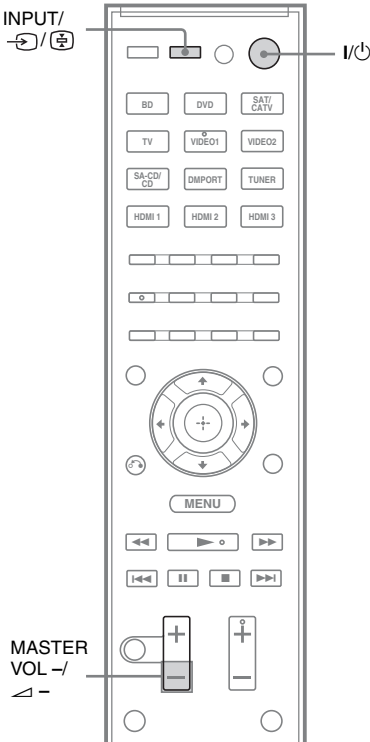

RM-AAU073 only

While holding down MASTER VOL - , press I/O and INPUT.

RM-AAU075 only

While holding down \triangle -, press I/O and \rightarrow / \leftarrow .

The remote is reset to its initial settings.

Glossary

■ Cinema Studio EX

A surround sound mode that can be regarded as the compilation of Digital Cinema Sound technology, delivers the sound of a dubbing theater using three technologies: “Virtual Multi Dimensions,” “Screen Depth Matching,” and “Cinema Studio Reverberation.”

“Virtual Multi Dimensions,” the virtual speaker technology, creates a virtual multi-surround environment with actual speakers up to 7.1 channels, and brings the surround sound experience of a theater with the latest facilities into your home.

“Screen Depth Matching” reproduces treble attenuation, fullness, and depth of sound usually created in a theater using sound emission from behind the screen. This is then added to the front and center channels.

“Cinema Studio Reverberation” reproduces the sound characteristics of state-of-the-art dubbing theaters and recording studios, including Sony Pictures Entertainment’s dubbing studios. There are three modes, A/B/C, available according to the studio type.

■ Component video

A format for transmitting video signal information consisting of three separate signals: luminance Y, chrominance Pb, and chrominance Pr. High quality pictures, such as DVD video or HDTV pictures, are transmitted more faithfully. The three jacks are color - coded green, blue and red.

■ Composite video

A standard format for transmitting video signal information. The luminance signal Y and chrominance signal C are combined and transmitted together.

■ Deep Color (Deep Colour)

Video signals for which the color depth of signals passing through an HDMI jack have been raised.

The number of colors that could be expressed by 1 pixel was 24 bits (16,777,216 colors) with the current HDMI jack. However, the number of colors which can be expressed by 1 pixel will be 36 bits, etc., when the receiver corresponds to Deep Color (Deep Colour). Since the gradation of the depth of a color can be expressed more finely with more bits, continuous color changes can be more smoothly expressed.

■ Digital Cinema Sound (DCS)

A unique sound reproduction technology for home theater developed by Sony, in cooperation with Sony Pictures Entertainment, for enjoying the exciting and powerful sound of movie theaters at home. With this “Digital Cinema Sound” developed by integrating a DSP (Digital Signal Processor) and measured data, the ideal sound field intended by filmmakers can be experienced at home.

■ Dolby Digital

Digital audio encoding/decoding technology developed by Dolby Laboratories, Inc. It consists of front (left/right), center, surround (left/right) and subwoofer channels. It is a designated audio standard for DVD video and also known as 5.1 channel surround. Since surround information is recorded and reproduced in stereo, more realistic sound with fuller presence is delivered than with Dolby surround.

■ Dolby Digital Plus

Dolby Digital Plus provides the flexibility and efficiency to deliver more channels of compelling surround sound for high-definition video media. Its superior coding efficiencies enable up to 7.1ch of high-quality multichannel audio without negatively impacting bit budgets allocated for video performance or additional feature sets.

■ Dolby Digital Surround EX

Acoustic technology developed by Dolby Laboratories, Inc. Surround back information is matrixed into regular left and right surround channels so that the sound can be reproduced in 6.1 channel. Active scenes, especially, are recreated with a more dynamic and realistic sound field.

■ Dolby Pro Logic II

This technology converts 2 channel stereo recorded audio into 5.1 channel for playback. There is a MOVIE mode for movies and MUSIC mode for stereo sources such as music. Old movies encoded in the traditional stereo format can be enhanced with 5.1 channel surround sound.

■ Dolby Pro Logic IIx

Technology for 7.1 channel (or 6.1 channel) playback. Along with audio encoded in Dolby Digital Surround EX, 5.1 channel Dolby Digital encoded audio can be reproduced in 7.1 channel (or 6.1 channel). Furthermore, existing stereo recorded content can also be reproduced in 7.1 channel (or 6.1 channel).

■ Dolby Pro Logic IIz

Dolby Pro Logic IIz brings a vertical aspect to the sound field through the addition of left and right front high speakers. It decodes nondirectional elements in the audio mix and reproduces them from the high speakers, giving an enhanced sense of depth and airiness to the sound field.

■ Dolby Surround (Dolby Pro Logic)

Audio processing technology developed by Dolby Laboratories, Inc. Center and mono surround information is matrixed into two stereo channels. When reproduced, audio is decoded and output in 4 channel surround sound. This is the most common audio processing method for DVD video.

■ **Dolby TrueHD**

Dolby TrueHD is Dolby's lossless audio technology developed for high-definition optical discs. Dolby TrueHD audio is bit-for-bit identical to the original studio masters and provides supreme-quality audio up to 8 channel at 96 kHz/24 bit and up to 6 channel at 192 kHz/24 bit. Together with high-definition video, it offers an unprecedented home theater experience.

■ **DTS 96/24**

A high sound quality digital signal format. It records audio at a sampling frequency and bit rate of 96 kHz/24 bit which is the highest possible for DVD video. The number of playback channels varies depending on the software.

■ **DTS Digital Surround**

Digital audio encoding/decoding technology for theaters developed by DTS, Inc. It compresses audio less than Dolby Digital, delivering a higher quality sound reproduction.

■ **DTS-ES**

Format for 6.1 channel playback with surround back information. There are two modes, "Discrete 6.1" which records all channels independently, and "Matrix 6.1" which matrixes surround back channel into surround left and surround right channels. It is ideal for playback of motion picture soundtracks.

■ **DTS-HD**

Audio format which extends the conventional DTS Digital Surround format.

This format consists of a core and an extension, and the core part has DTS Digital Surround compatibility. There are two kinds of DTS-HD, DTS-HD High Resolution Audio and DTS-HD Master Audio. DTS-HD High Resolution Audio has a maximum transmission rate of 6 Mbps, with lossy compression (Lossy), and DTS-HD High Resolution Audio corresponds to a maximum sampling frequency of 96 kHz, and a maximum of 7.1 channel. DTS-HD Master Audio has a maximum transmission rate of 24.5 Mbps, and uses lossless compression (Lossless), and DTS-HD Master Audio corresponds to a maximum sampling frequency of 192 kHz, and a maximum of 7.1 channel.

■ **DTS Neo:6**

This technology converts 2 channel stereo recorded audio for 7 channel playback. There are two modes to select according to the playback source or your preference, CINEMA for movies, and MUSIC for stereo sources such as music.

■ **HDMI (High-Definition Multimedia Interface)**

HDMI (High-Definition Multimedia Interface) is an interface that supports both video and audio on a single digital connection, allowing you to enjoy high quality digital picture and sound. The HDMI specification supports HDCP (High-bandwidth Digital Contents Protection), a copy protection technology that incorporates coding technology for digital video signals.

■ **PCM (Pulse Code Modulation)**

A method of converting analog audio to digital audio for easy enjoyment of digital sound.

■ S-AIR (Sony Audio Interactive Radio frequency)

Recent times have seen the rapid spread of DVD media, Digital Broadcasting, and other high quality media.

To ensure that the subtle nuances of these high quality media are transmitted with no deterioration, Sony has developed a technology called “S-AIR” for the radio transmission of digital audio signals with no compression, and has incorporated this technology into the EZW-RT10/EZW-T100. This technology transfers digital audio signals with no compression using the 2.4 GHz band range of ISM band (Industrial, Scientific, and Medical band), such as wireless LANs and Bluetooth applications.

■ Sampling frequency

To convert analog audio to digital, analog data should be quantified. This process is called sampling, and the number of times per second the analog data is quantified is called the sampling frequency. A standard music CD stores data quantified at 44,100 times per second, which is expressed as a sampling frequency of 44.1 kHz. Generally speaking, a higher sampling frequency means better sound quality.

■ x.v.Color (x.v.Colour)

x.v.Color (x.v.Colour) is a more familiar term for the xvYCC standard proposed by Sony, and is a trademark of Sony. xvYCC is an international standard for color space in video. This standard can express a wider colour range than the currently used broadcast standard.

Precautions

On safety

Should any solid object or liquid fall into the cabinet, unplug the receiver and have it checked by qualified personnel before operating it any further.

On power sources

- Before operating the receiver, check that the operating voltage is identical with your local power supply.
The operating voltage is indicated on the nameplate on the back of the receiver.
- The unit is not disconnected from the AC power source (mains) as long as it is connected to the wall outlet, even if the unit itself has been turned off.
- If you are not going to use the receiver for a long time, be sure to disconnect the receiver from the wall outlet. To disconnect the AC power cord (mains lead), grasp the plug itself; never pull the cord.
- The AC power cord (mains lead) must be changed only at a qualified service shop.
- (Models of area code U2, CA2 only)
One blade of the plug is wider than the other for the purpose of safety and will fit into the wall outlet only one way. If you are unable to insert the plug fully into the outlet, contact your dealer.

On heat buildup

Although the receiver heats up during operation, this is not a malfunction. If you continuously use this receiver at a large volume, the cabinet temperature of the top, side and bottom rises considerably. To avoid burning yourself, do not touch the cabinet.

On placement

- Place the receiver in a location with adequate ventilation to prevent heat buildup and prolong the life of the receiver.
- Do not place the receiver near heat sources, or in a place subject to direct sunlight, excessive dust, or mechanical shock.
- Do not place anything on top of the cabinet that might block the ventilation holes and cause malfunctions.
- Do not place the receiver near equipment such as a TV, VCR, or tape deck. (If the receiver is being used in combination with a TV, VCR, or tape deck, and is placed too close to that equipment, noise may result, and picture quality may suffer. This is especially likely when using an indoor antenna (aerial). Therefore, we recommend using an outdoor antenna (aerial).)
- Use caution when placing the receiver on surfaces that have been specially treated (with wax, oil, polish, etc.) as staining or discoloration of the surface may result.

On operation

Before connecting other components, be sure to turn off and unplug the receiver.

On cleaning

Clean the cabinet, panel, and controls with a soft cloth slightly moistened with a mild detergent solution. Do not use any type of abrasive pad, scouring powder, or solvent, such as alcohol or benzine.

On S-AIR function

- As the S-AIR product(s) transmits sound by radio waves, sound may skip when radio waves are obstructed. This is a characteristic of radio waves and is not malfunction.
- As the S-AIR product(s) transmits sound by radio waves, equipment that generates electromagnetic energy, such as a microwave oven, may interfere with sound transmission.
- As the S-AIR product(s) uses the radio waves that share the same frequency as other wireless systems, such as wireless LAN or Bluetooth devices, interference or poor transmission may result. In this case, take the following steps to enhance the transmission of signal:
 - Avoid placing the S-AIR product(s) near other wireless systems.
 - Avoid using the S-Air product(s) and the other wireless systems at the same time.
 - The transmission may be improved by changing the transmission channel (frequency) of the other wireless system(s). For details, refer to the operating instructions of the other wireless system(s).
- The transmission distance differs depending on the usage environment. Find a location where transmission between the S-AIR main unit and sub unit is most effective, and install the S-AIR main unit and sub unit there.
- Place the S-AIR product(s) on the stable surface off the floor.
- Poor transmission may occur and the transmission distance may be too short if the following conditions exist:
 - There is a wall/floor made of reinforced concrete or stone between the S-AIR product(s).
 - There is an iron divider/door or furniture/ electric product made of fireproof glass, metal, etc., between the S-AIR product(s).

If you have any questions or problems concerning your receiver, please consult your nearest Sony dealer.

Troubleshooting

If you experience any of the following difficulties while using the receiver, use this troubleshooting guide to help you remedy the problem. Should any problem persist, consult your nearest Sony dealer.

Audio

There is no sound, no matter which component is selected, or only a very low-level sound is heard.

- Check that the speakers and components are connected correctly and securely.
- Check that all speaker cords are connected correctly.
- Check that both the receiver and all components are turned on.
- Check that MASTER VOLUME is not set to “VOL MIN”.
- Check that the SPEAKERS is not set to “SPK OFF” (page 33).
- Check that headphones are not connected to the receiver or S-AIR surround amplifier.
- Press MUTING (RM-AAU073) or  (RM-AAU075) on the remote to cancel the muting function.
- Check that you have selected the correct component with the input buttons (page 42).
- The protective device on the receiver has been activated. Turn off the receiver, eliminate the short-circuit problem, and turn on the power again.

There is no sound from a specific component.

- Check that the component is connected correctly to the audio input jacks for that component.
- Check that the cord(s) used for the connection is (are) fully inserted into the jacks on both the receiver and the component.

There is no sound from one of the front speakers.

- Connect a pair of headphones to the PHONES jack to verify that sound is output from the headphones. If only one channel is output from the headphones, the component may not be connected to the receiver correctly. Check that all the cords are fully inserted into the jacks on both the receiver and the component. If both channels are output from the headphones, the front speaker may not be connected to the receiver correctly. Check the connection of the front speaker which is not outputting any sound.
- Make sure you have connected to both the L and R jacks of an analog component, and not only to either the L or R jack. Use an audio cord (not supplied).

There is no sound from analog 2 channel sources.

- Check that the INPUT MODE is not set to “AUTO” (page 68) and the DIGITAL connection is not made for the selected input.
- Check that the INPUT MODE is not set to “AUTO” (page 68) and the “A. ASSIGN” function is not used to reassign the audio input of another source to the selected input (page 68).

There is no sound from digital sources (from COAXIAL or OPTICAL input jack).

- Check that the INPUT MODE is not set to “ANALOG” (page 68).
- Check that the Analog Direct function is not selected.
- Check that the “A. ASSIGN” function is not used to reassign the audio input of another source to the selected input (page 68).
- Set “ARC” to “ARC OFF” when no sound is output from TV OPTICAL IN jack during TV input (page 83).

The left and right sounds are unbalanced or reversed.

- Check that the speakers and components are connected correctly and securely.
- Adjust the level parameters using the LEVEL menu.

There is severe hum or noise.

- Check that the speakers and components are connected securely.
- Check that the connecting cords are away from a transformer or motor, and at least 10 feet (3 meters) away from a TV set or fluorescent light.
- Move your audio components away from the TV.
- The plugs and jacks are dirty. Wipe them with a cloth slightly moistened with alcohol.

There is no sound, or only a very low-level sound is heard from the center/surround/surround back/front high speakers.

- Select a CINEMA STUDIO EX mode (page 50).
- Check that the speaker settings are appropriate using the AUTO CAL menu or “PATTERN” in the SPEAKER menu. Then check that sound is output from each speaker correctly, using “T. TONE” in the LEVEL menu.
- Adjust the speaker level (page 40).

There is no sound from the subwoofer.

- Check that the subwoofer is connected correctly and securely.
- Make sure you have turned on your subwoofer.
- Depending on the selected sound field, no sound output from the subwoofer.
- When all speakers are set to “LARGE” and “NEO6 CIN” or “NEO6 MUS” is selected, there is no sound from the subwoofer.
- Check “PATTERN” setting (page 77).

The surround effect cannot be obtained.

- Make sure you have selected the sound field for movie or music mode (page 50 or 51).
- Sound fields do not function for signals with a sampling frequency of more than 48 kHz.

Dolby Digital or DTS multi channel sound is not reproduced.

- Check that the DVD, etc. you are playing is recorded in Dolby Digital or DTS format.
- When connecting the DVD player, etc., to the digital input jacks of this receiver, check the audio setting (the settings for the audio output) of the connected component.

Recording cannot be carried out.

- Check that the components are connected correctly.
- Select the source component using the input buttons (page 42).

There is no sound from the component connected to the DIGITAL MEDIA PORT adapter.

- Adjust the volume of this receiver.
 - The DIGITAL MEDIA PORT adapter and/or component is not connected correctly. Turn off the receiver, then reconnect the DIGITAL MEDIA PORT adapter and/or component.
 - Check the DIGITAL MEDIA PORT adapter and/or component device to make sure it supports this receiver.
-

Video

There is no picture or an unclear picture appears on the TV screen or monitor.

- Select the appropriate input using the input buttons.
 - Set your TV to the appropriate input mode.
 - Move your audio components away from the TV.
 - Depending on the DIGITAL MEDIA PORT adapter, video output may not be possible.
-

Recording cannot be carried out.

- Check that the components are connected correctly.
 - Select the source component using the input buttons (page 42).
-

Tuner

The FM reception is poor.

- Use a 75-ohm coaxial cable (not supplied) to connect the receiver to an outdoor FM antenna (aerial) as shown below. If you connect the receiver to an outdoor antenna (aerial), ground it against lightning. To prevent a gas explosion, do not connect the ground (earth) wire to a gas pipe.

Outdoor FM antenna (aerial)

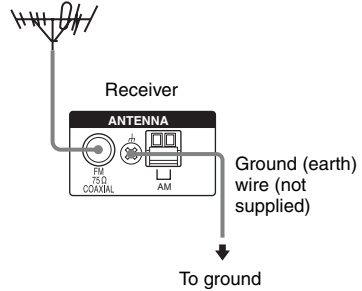

Radio stations cannot be tuned in.

- Check that the antennas (aerials) are connected securely. Adjust the antennas (aerials) and connect an external antenna (aerial), if necessary.
 - The signal strength of the stations is too weak (when tuning in with automatic tuning). Use direct tuning.
 - Make sure you set the tuning interval correctly (when tuning in AM stations with direct tuning).
 - No stations have been preset or the preset stations have been cleared (when tuning by scanning preset stations). Preset the stations (page 47).
 - Press DISPLAY repeatedly so that the frequency appears on the display.
-

RDS does not work.*

- Make sure that you are tuned to an FM RDS station.
- Select a stronger FM station.

The RDS information that you want does not appear.*

- Contact the radio station and find out whether they actually provide the service in question. If so, the service may be temporarily out of order.

* Models of area code AU1, TW2 only.

HDMI

The source sound input to the HDMI jack is not output from the receiver or the TV speaker.

- Check the HDMI connection (page 24).
- You cannot listen to the Super Audio CD by connecting HDMI.
- Depending on the playback component, you may need to set up the component. Refer to the operating instructions supplied with each component.
- Be sure to use a High Speed HDMI cable when you view images or listen to sound during Deep Color (Deep Colour) transmission.

The source image input to the HDMI jack is not output from the TV.

- Check the HDMI connection (page 24).
- Depending on the playback component, you may need to set up the component. Refer to the operating instructions supplied with each component.
- Be sure to use a High Speed HDMI cable when you view images or listen to sound during Deep Color (Deep Colour) transmission.

The Control for HDMI function does not work.

- Check the HDMI connection (page 24).
- Make sure “CTRL.HDMI” is set to “CTRL ON” in the HDMI menu.
- Make sure the connected component is compatible with the Control for HDMI function.
- Check the Control for HDMI settings on the connected component. Refer to the operating instructions of the connected component.
- Repeat the procedures of “Preparing for the “BRAVIA” Sync” if you change the HDMI connection, connect/disconnect the AC power cord (mains lead), or when there is a power failure (page 55).

No sound is output from the receiver and TV speaker while using the System Audio Control function.

- Make sure the TV is compatible with the System Audio Control function.
- If the TV does not have System Audio Control function, set the “AUDIO.OUT” settings in HDMI menu to
 - “TV+AMP” if you want to listen to the sound from the TV speaker and receiver.
 - “AMP” if you want to listen to the sound from the receiver.
- When you connect the receiver to a video component (projector, etc.), sound may not be output from the receiver. In this case, select “AMP”.
- If you cannot listen to the sound of a component connected to the receiver
 - Change the input of the receiver to HDMI when you want to watch a program on a component connected via HDMI connection to the receiver.
 - Change the TV channel when you want to watch a TV broadcast.
 - Select the component or input you want to watch when you watch a program on the component connected to the TV. Refer to the operating instructions of the TV on this operation.

When the receiver is in standby mode, there is no image or sound on the TV.

- When the receiver is in standby mode, image and sound are output from the HDMI component selected the last time you turned off the receiver. If you are enjoying other component, play the component and perform the One-Touch Play operation, or turn on the receiver to select the HDMI component you want to enjoy.
- Make sure “PASS.THROUGH” is set to “ON” in the HDMI menu if you connect components not compatible with the “BRAVIA” Sync to the receiver (page 82).

S-AIR function

S-AIR connection is not established (sound transmission is not established), e.g., the indicator of the S-AIR sub unit turns off, flashes, or turns red.

- If you use another S-AIR main unit, place it more than 26 feet (8 m) away from this S-AIR main unit.
- Confirm the S-AIR IDs of the S-AIR main unit and S-AIR sub unit (page 61).
- Another S-AIR sub unit is paired to the S-AIR main unit. Pair the desired S-AIR sub unit with the S-AIR main unit (page 62).
- Place the S-AIR main unit and S-AIR sub unit separately from other wireless devices.
- Avoid using any other wireless devices.
- The S-AIR sub unit is turned off. Make sure the AC power cord (mains lead) is connected and turn on the S-AIR sub unit.

No sound is heard from the S-AIR receiver.

- Check that the components are connected to this receiver.

No sound is heard from the S-AIR product.

- If you use another S-AIR main unit, place it more than 26 feet (8 m) away from this S-AIR main unit.
- Confirm the S-AIR IDs of the S-AIR main unit and S-AIR sub unit (page 61).
- Confirm the pairing setting (page 62).
- Place the S-AIR main unit and S-AIR sub unit closer to each other.
- Avoid use of equipment that generates electromagnetic energy, such as a microwave oven.
- Place the S-AIR main unit and S-AIR sub unit separately from other wireless devices.
- Avoid using any other wireless devices.
- Change the “RF SETUP” setting (page 65).
- Change the S-AIR ID settings of the S-AIR main unit and S-AIR sub unit.
- Turn off the system and S-AIR sub unit, then turn on them.
- Check that headphones are not connected to the S-AIR sub unit.

There is noise or the sound skips.

- If you use another S-AIR main unit, place it more than 26 feet (8 m) away from this S-AIR main unit.
- Place the S-AIR main unit and S-AIR sub unit closer to each other.
- Avoid use of equipment that generates electromagnetic energy, such as a microwave oven.
- Place the S-AIR main unit and S-AIR sub unit separately from other wireless devices.
- Avoid using any other wireless devices.
- Change the “RF SETUP” setting (page 65).
- Change the S-AIR ID settings of the S-AIR main unit and S-AIR sub unit.

“HP NO LK” and “VOL MIN” appear alternately in the display and the volume of the receiver becomes minimum.

- Volume becomes minimum when you turn off the surround amplifier with headphones connected or if the radio reception is poor. In these cases, check the radio reception and adjust the volume level to restore sound from the headphone.
-

Remote commander

The remote does not function.

- Point the remote at the remote sensor on the receiver.
 - Remove any obstacles in the path between the remote and the receiver.
 - Replace all the batteries in the remote with new ones, if they are weak.
 - Make sure you select the correct input on the remote.
-

Others

The receiver is turned off automatically.

- The “AUTO.STBY” function is working (page 83).
-

Error messages

If there is a malfunction, the display shows a message. You can check the condition of the system by the message. See the following table to solve the problem. If any problem persists, consult your nearest Sony dealer.

If an error message appears while you perform Auto Calibration, see “When error codes appear” (page 37) to solve the problem.

PROTECTOR

Irregular current is output to the speakers, or the upper panel of the receiver is covered with something. The receiver will automatically turn off after a few seconds. Check the speaker connection and turn on the power again.

If you are unable to remedy the problem using the troubleshooting guide

Clearing the receiver’s memory may remedy the problem (page 33). However, note that all memorized settings will be reset to their initial settings and you will have to readjust all settings on the receiver.

If the problem persist

Consult your nearest Sony dealer. Note that if service personnel changes some parts during repair, these parts may be retained. In the event of a problem with S-AIR function, have a Sony dealer check the entire system together (S-AIR main unit and S-AIR sub unit).

Reference sections for clearing the receiver’s memory

To clear	See
All memorized settings	page 33
Customized sound fields	page 54

Specifications

AUDIO POWER SPECIFICATIONS

POWER OUTPUT AND TOTAL HARMONIC DISTORTION: (Models of area code U2 only)

With 8 ohm loads, both channels driven, from 20 – 20,000 Hz; rated 95 watts per channel minimum RMS power, with no more than 0.09% total harmonic distortion from 250 milliwatts to rated output.

Amplifier section

Models of area code U2¹⁾

Minimum RMS Output Power
(8 ohms, 20 Hz – 20 kHz, THD 0.09%)
95 W + 95 W

Stereo Mode Output Power
(8 ohms, 1 kHz, THD 1%)
105 W + 105 W

Surround Mode Output Power²⁾
(8 ohms, 1 kHz, THD 10%)
140 W per channel

Models of area code CA2, AU1, TW2¹⁾

Minimum RMS Output Power
(8 ohms, 20 Hz – 20 kHz, THD 0.09%)
85 W + 85 W

Stereo Mode Output Power
(8 ohms, 1 kHz, THD 1%)
100 W + 100 W

Surround Mode Output Power²⁾
(8 ohms, 1 kHz, THD 10%)
140 W per channel

¹⁾Measured under the following conditions:

Area code	Power requirements
U2, CA2	120 V AC, 60 Hz
AU1	230 V AC, 50 Hz
TW2	110 V AC, 50 Hz

²⁾Reference power output for front, center, surround, surround back and front high speakers. Depending on the sound field settings and the source, there may be no sound output.

Frequency response

Analog 10 Hz – 70 kHz,
+0.5/–2 dB (with sound field and equalizer bypassed)

Input

Analog Sensitivity: 500 mV/
50 kohms
S/N³⁾: 96 dB
(A, 500 mV⁴⁾)

Digital (Coaxial) Impedance: 75 ohms
S/N: 100 dB
(A, 20 kHz LPF)

Digital (Optical) S/N: 100 dB
(A, 20 kHz LPF)

Output (Analog)

AUDIO OUT Voltage: 500 mV/
10 kohms

SUBWOOFER Voltage: 2 V/1 kohm

Equalizer

Gain levels ±6 dB, 1 dB step

³⁾INPUT SHORT (with sound field and equalizer bypassed).

⁴⁾Weighted network, input level.

FM tuner section

Tuning range 87.5 MHz – 108.0 MHz

Antenna (aerial) FM wire antenna (aerial)

Antenna (aerial) terminals
75 ohms, unbalanced

Intermediate frequency
10.7 MHz

AM tuner section

Tuning range

Area code	Tuning scale	
	10 kHz step	9 kHz step
U2, CA2	530 kHz – 1,710 kHz	531 kHz – 1,710 kHz
AU1, TW2	–	531 kHz – 1,602 kHz

Antenna (aerial) Loop antenna (aerial)

Intermediate frequency
450 kHz

Video section

Inputs/Outputs

Video: 1 Vp-p, 75 ohms

COMPONENT VIDEO:

Y: 1 Vp-p, 75 ohms

P_B/C_B: 0.7 Vp-p, 75 ohms

P_R/C_R: 0.7 Vp-p, 75 ohms

80 MHz HD Pass Through

General

Power requirements

Area code	Power requirements
U2, CA2	120 V AC, 60 Hz
AU1	230 V AC, 50 Hz
TW2	110 V AC, 50/60 Hz

Power output (DIGITAL MEDIA PORT)

DC OUT: 5V, 0.7A MAX

Power consumption

Area code	Power consumption
U2, CA2, AU1, TW2	240 W

Dimensions (width/height/depth) (Approx.)

17 in × 6 1/4 in × 12 3/4 in
(430 mm × 157.5 mm ×
322 mm) including
projecting parts and
controls

Mass (Approx.) 17 lb 11 oz (8.0 kg)

For details on the area code of the component you are using, see page 4.

Design and specifications are subject to change without notice.

- Standby power consumption: 0.3 W
- Halogenated flame retardants are not used in the certain printed wiring boards.

Index

Numerics

- 2 channel 50
- 5.1 channel 16
- 7.1 channel 16

A

- A.F.D. mode 50
- Analog Direct 50
- Audio Return Channel (ARC) 59
- AUTO CALIBRATION 34

B

- BI-AMP 79
- Bi-amplifier connection 70
- Blu-ray disc player
 - connecting 24, 27

C

- Cable TV tuner
 - connecting 24, 29
- Camcorder
 - connecting 30
- Clear
 - memory 33
 - remote 85

D

- DIGITAL MEDIA PORT
 - connecting 22
 - enjoying 70
- Dolby Digital 86
- Dolby Digital EX 53
- DTS 87
- DVD player
 - connecting 24, 28
- DVD recorder
 - connecting 24, 28, 30

E

- Error messages 95

H

- HDMI
 - connecting 24
- HDMI Pass Through 82

I

- Initial setup 33
- INPUT MODE 68

M

- Menu
 - AUDIO 81
 - AUTO CAL 39
 - EQ 80
 - HDMI 82
 - LEVEL 76
 - S-AIR 83
 - SPEAKER 77
 - SURROUND 80
 - SYSTEM 83
 - TUNER 80
 - VIDEO 81
- Movie mode 50
- Music mode 51
- Muting 42

N

- Naming 39, 43, 48
- NIGHT MODE 54

O

- One-Touch Play 56

P

- PAIRING 62
- “PlayStation 3”
 - connecting 24

R

- RDS 49
- Recording
 - onto a CD-R 44
 - onto a recording media 45
- Remote commander 11

S

- S-AIR 60
- Satellite tuner
 - connecting 24, 29
- Selecting
 - speaker system 33
- Sleep Timer 44
- Sound fields
 - resetting 54
 - selecting 50
- Speakers
 - connecting 19
 - installing 16
- System Audio Control 57
- System Power Off 58

T

- Test Tone 40, 76
- Tuner
 - connecting 31
- Tuning
 - automatically 46
 - directly 46
 - to preset stations 48
- TV
 - connecting 21

V

- VCR
 - connecting 30
- Video game
 - connecting 30



* 4 1 6 7 1 3 3 1 1 * (1)