

TP-LINK®

Touch P5 User Guide

AC1900 Touch Screen Wi-Fi Gigabit Router

Contents

Chapter 1. About This Guide	1
Chapter 2. Get to Know About You Router	1
1. 1. Product Overview	2
1. 2. Touchscreen Display.....	2
1. 2. 1.Home Screen	2
1. 2. 2.Menu Screen.....	4
1. 3. Button and Port Explanations.....	4
1. 4. Position Your Router.....	5
Chapter 3. Configure Touch P5 as a Router	6
2. 1. Connect Your Touch P5	7
2. 2. Log into Your Touch P5	8
2. 2. 1.Through Touchscreen Utility (Recommended).....	8
2. 2. 2.Through Web-based Utility	8
2. 3. Quick Setup.....	9
2. 4. Mode Selection	10
2. 5. Wireless Settings	10
2. 6. WPS	13
2. 7. Guest Network	15
2. 8. Parental Controls	16
2. 9. Devices Control	19
2. 10. Printer Server	21
2. 11. DDNS.....	25
2. 12. LAN.....	25
2. 13. DHCP Server	26
2. 14. QoS.....	28
2. 15. Clock	31
2. 16. Screen Settings	34
2. 17. Reboot & Reset.....	35
2. 18. Administrator Password	36
2. 19. About.....	36
2. 20. USB Application.....	37
2. 20. 1.Local Storage Sharing	37

2. 20. 2.Remote Access via FTP Server	40
2. 20. 3.Media Sharing	43
2. 21. IPv6 Connection.....	45
2. 22. IPTV	47
2. 23. NAT Forwarding.....	48
2. 23. 1.Share Local Resources in the Internet by Virtual Server	49
2. 23. 2.Open Ports Dynamically by Port Triggering	50
2. 23. 3.Make Applications Free from Port Restriction by DMZ	51
2. 23. 4.Make Xbox Online Games Run Smoothly by UPnP.....	52
2. 24. Firmware Upgrade	53
2. 25. FAQ.....	54

Chapter 4. Configure Touch P5 as a Repeater 59

3. 1. Quick Setup.....	60
3. 1. 1.Option 1: Through Touchscreen Utility (Recommended)	60
3. 1. 2.Option 2: Through Web-based Utility	61
3. 2. Entertainment Adapter	63
3. 3. Mode Selection	64
3. 4. Wireless Settings	65
3. 5. Devices Control	66
3. 6. LAN.....	68
3. 7. DHCP Server	69
3. 8. Screen Settings	72
3. 9. Reboot & Reset.....	73
3. 10. Administrator Password	73
3. 11. About.....	74
3. 12. FAQ.....	74

Chapter 5. Configure Touch P5 as an Access Point..... 76

4. 1. Connect Your Touch P5	77
4. 2. Log into Your Touch P5	77
4. 2. 1.Option 1: Through Touchscreen Utility (Recommended)	77
4. 2. 2.Option 2: Through Web-based Utility	78
4. 3. Quick Setup.....	79
4. 4. Mode Selection	79
4. 5. Wireless Settings	80
4. 6. WPS	81

4.7.	Devices Control	83
4.8.	LAN.....	85
4.9.	DHCP Server	86
4.10.	Screen Settings	89
4.11.	Reboot & Reset.....	90
4.12.	Administrator Password	90
4.13.	About.....	91
4.14.	FAQ.....	91







About This Guide

This guide is a complementation of Quick Installation Guide. The Quick Installation Guide instructs you on quick Internet setup, and this guide provides details of each function and shows you the way to configure these functions appropriate to your needs.

When using this guide, please notice that features of the router may vary slightly depending on the model and software version you have, and on your location, language, and Internet service provider. All screenshots, images, parameters and descriptions documented in this guide are used for demonstration only.

Conventions

In this guide the following conventions are used:

Convention	Description
<i>Blue Italic</i>	Hyperlinks are in blue italic. You can click to redirect to a website or a specific section.
Blue	Contents to be emphasized and texts on the web page are in blue, including the menus, items, buttons, etc.
>	The menu structures to show the path to load the corresponding page. For example, Advanced > Wireless > MAC Filtering means the MAC Filtering function page is under the Wireless menu that is located in the Advanced tab.
 Note:	Ignoring this type of note might result in a malfunction or damage to the device.
 Tips:	Indicates important information that helps you make better use of your device.
symbols on the web page	<ul style="list-style-type: none"> click to edit the corresponding entry. click to delete the corresponding entry. click to enable or disable the corresponding entry. click to view more information about items on the page.

More Info

- The latest software, management app and utility can be found at [Download Center](http://www.tp-link.com/support) at <http://www.tp-link.com/support>.
- The Quick Installation Guide (QIG) can be found where you find this guide or inside the package of the router.
- Specifications can be found on the product page at <http://www.tp-link.com>.
- A Technical Support Forum is provided for you to discuss our products at <http://forum.tp-link.com>.
- Our Technical Support contact information can be found at the [Contact Technical Support](http://www.tp-link.com/support) page at <http://www.tp-link.com/support>.

Chapter 1

Get to Know About Your Router

This chapter introduces what the router can do and shows its main features and appearance.

This chapter contains the following sections:

- *Product Overview*
- *Touchscreen Display*
- *Button and Port Explanations*
- *Position Your Router*

1.1. Product Overview

Wi-Fi at Your Fingertips

It is simple to use the touch-screen router with its responsive touch screen, just simple as using your smart phone. In addition to adding to the beauty of your router, the integrated touch screen also dramatically revolutionizes the way you set up and interact with your network. All you have to do is tap, swipe and connect.

Beautiful and Powerful

Stream Ultra HD video without buffering, play online games without lag, download large files in a flash, and discover countless other ways for the touch screen router to exceed your wireless expectations. Blazing fast AC Wi-Fi speeds ensure that everyone on your network can enjoy smooth streaming video and low-latency online gaming.

1.2. Touchscreen Display

1.2.1. Home Screen

In Router Mode

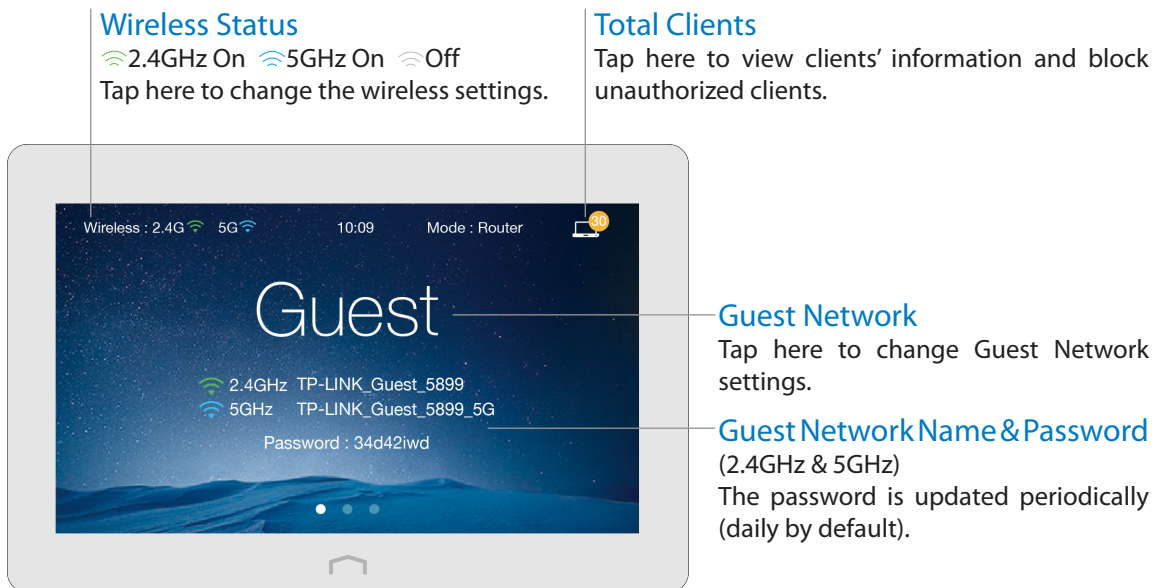

In Repeater Mode

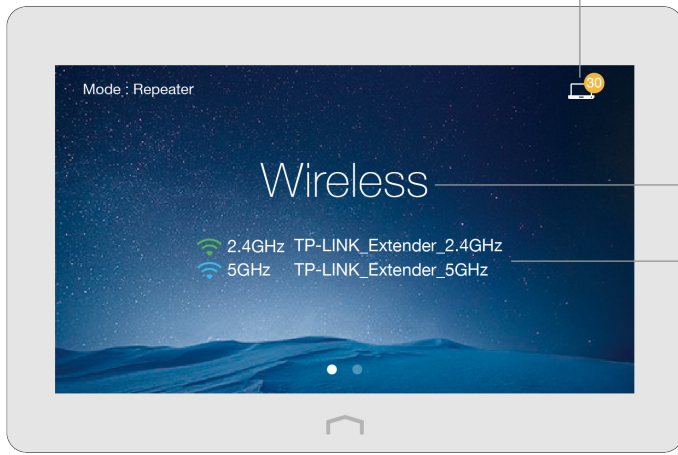

Total Clients
Tap here to view clients' information and block unauthorized clients.

Wireless Settings
Tap here to change the settings of host and extended networks.

Extended Network Name (2.4GHz & 5GHz)
Display the extended network names of your router.

In Access Point Mode

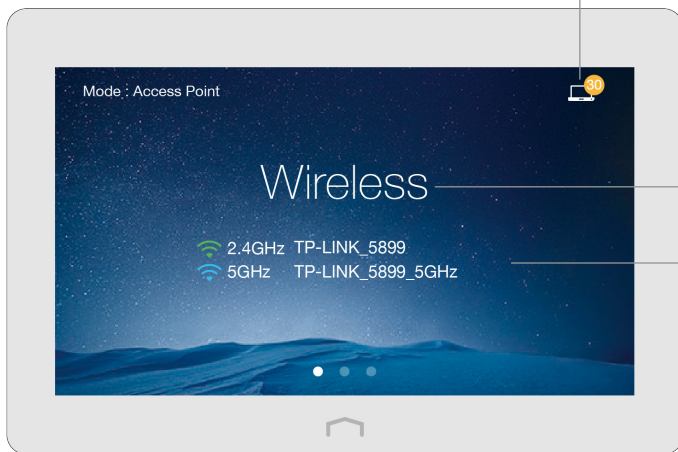

Total Clients
Tap here to view clients' information and block unauthorized clients.

Wireless Settings
Tap here to change the settings.

Network Name (2.4GHz & 5GHz)
Display the network names of your router.

1.2.2. Menu Screen

Tap the icons to perform various functions of your Touch P5, such as Quick Setup, Mode Selection, Parental Controls, etc.

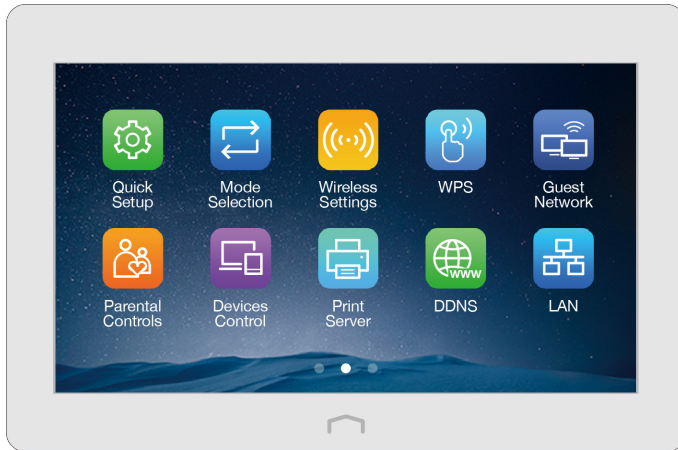

1.3. Button and Port Explanations



The router's buttons and ports (view from left to right) are located on the back panel.

Item	Description
Power Port	For connecting the router to a power socket via the provided power adapter.
Power On/Off Button	Press this button to power on or off the router.
USB 2.0 Port	For connecting to a 2.0 USB storage device or a 2.0 USB printer.
USB 3.0 Port	It's on the right front corner of your Touch P5. For connecting to a 3.0 USB storage device or a 3.0 USB printer. It is also compatible with USB 2.0 devices.
Internet Port	In router mode, for connecting to a DSL/Cable modem, or Ethernet. In repeater mode, for connecting to an Ethernet-enabled device, working as an Ethernet port. In access point mode, for connecting to a host router or the Internet.
Ethernet Ports (1, 2, 3, 4)	For connecting the router to your PC or other Ethernet-enabled devices.
Reset Button	Press and hold the Reset button until the Touch P5 logo displays.
Antennas	Used for wireless operation and data transmit. Upright them for the best Wi-Fi performance.

1.4. Position Your Router

- The product should not be located where it will be exposed to moisture or excessive heat.
- Place the router in a location where it can be connected to various devices as well as to a power source.
- Make sure the cables and power cord are safely placed out of the way so they do not create a tripping hazard.
- The router can be placed on a shelf or desktop.
- Keep the router away from strong electromagnetic radiation and devices sensitive of electromagnetic.

Generally, your router is placed on a horizontal surface. It can also be mounted on a wall as shown below.

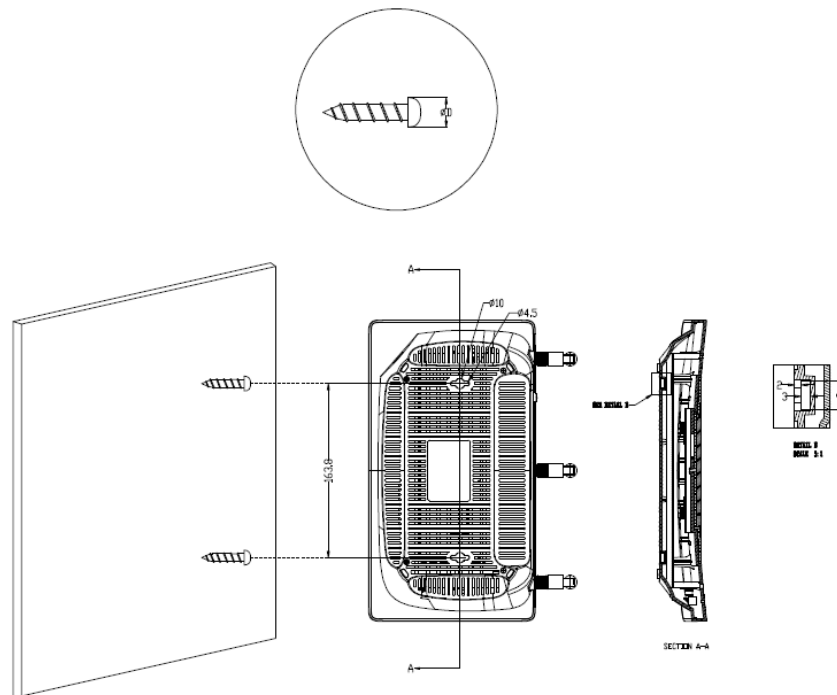

Note:

The diameter of the screws should range from 3.5mm to 6mm, and the distance of two screws is 163.8mm. The screws that project from the wall need around 4mm based, and the length of the screws need to be at least 20mm to withstand the product.

Chapter 2

Configure Touch P5 as a Router

This chapter introduces how to connect and configure your Touch P5 in [router mode](#) which will provide Internet access for multiple wired and wireless devices simultaneously.

This chapter contains the following sections:

- [Connect Your Touch P5](#)
- [Log into Your Touch P5](#)
- [Quick Setup](#)
- [Mode Selection](#)
- [Wireless Settings](#)
- [WPS](#)
- [Guest Network](#)
- [Parental Controls](#)
- [Devices Control](#)
- [Printer Server](#)
- [DDNS](#)
- [LAN](#)
- [DHCP Server](#)
- [QoS](#)
- [Clock](#)
- [Screen Settings](#)
- [Reboot & Reset](#)
- [Administrator Password](#)
- [About](#)
- [USB Application](#)
- [IPv6 Connection](#)
- [IPTV](#)
- [NAT Forwarding](#)
- [Firmware Upgrade](#)
- [FAQ](#)

2.1. Connect Your Touch P5



Follow the steps below to connect your Touch P5.

1. Install the antennas and position them vertically.

Note: If your Internet connection is through an Ethernet cable from the wall, instead of a modem, connect the Ethernet cable directly to your Touch P5's Internet port, and skip step 2, 3 and 4.

2. Turn off the modem, and remove the backup battery if it has one.
3. Connect the modem to the Internet port of your Touch P5 via an Ethernet cable.
4. Turn on the modem, and wait 2 minutes for it to restart.
5. Turn on your Touch P5 and wait until the system boot on the screen completes.
6. Connect your computer to your Touch P5.

➤ Option 1: Wired

Connect your computer to one Ethernet port on your Touch P5 via an Ethernet cable.

➤ Option 2: Wireless

Use the default SSID (Wireless Network Name) and Wireless Password printed on the product label at the bottom of your Touch P5 to connect wirelessly.

Note: If you want to use your Touch P5 for media sharing, storage sharing and printer sharing, please connect a USB storage device or printer to the USB port of your Touch P5.

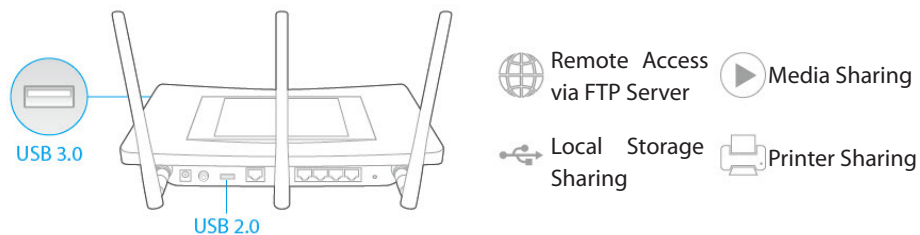

2.2. Log into Your Touch P5

Touch P5 supports two configuration methods: **Web-based utility** and **Touchscreen utility**. **Web-based utility** includes the configuration for all functions, and it requires a connection (wired or wireless) between your Touch P5 and the device you are using to log into the web management page. **Touchscreen utility** supports configuration for most commonly used functions, and the configuration can be easily done with a few taps on the touchscreen.

In this chapter, most configuration are introduced through the touchscreen utility. Other features, such as the USB Application, IPv6 Connection, IPTV, NAT Forwarding and Firmware Upgrade, etc., are introduced d through web-based utility.

2.2.1. Through Touchscreen Utility (Recommended)

1. Tap the home button or the screen and slide to start the screen.
2. The first time after you log in is to set a new administrator password for your Touch P5. Enter the new password twice and tap **Save**. Then follow the **Quick Setup** to complete the initial configuration.

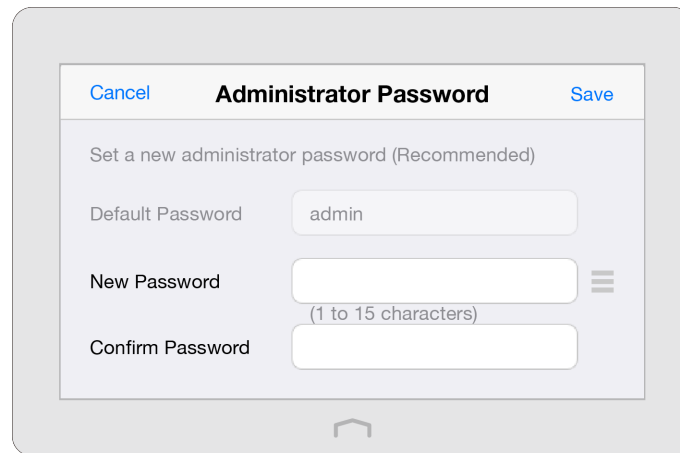

Note: Apps on the touchscreen and web-based utility will need to use the new password that you have set to log in.

2.2.2. Through Web-based Utility

The web-based utility can be used on any Windows, Macintosh or UNIX OS with a web browser, such as Microsoft Internet Explorer, Mozilla Firefox or Apple Safari. Follow the steps below to log into your Touch P5.

1. If the TCP/IP Protocol on your computer is set to the static (fixed) IP address, you need to change it to obtain an IP address automatically.
2. Launch a web browser on your computer, visit <http://tplinkwifi.net> and log in with the default username and password (**admin/admin**).

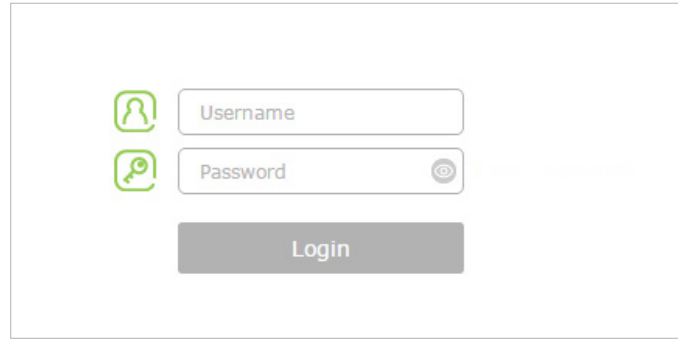

A login screen with two input fields and a button. The first field is labeled 'Username' and has a person icon to its left. The second field is labeled 'Password' and has a key icon to its left and a toggle icon to its right. Below the fields is a grey button labeled 'Login'.

3. The first time after you log in is to set up a new username and password for your Touch P5. Enter your new username and password and the new password again to confirm. Click [Confirm](#).

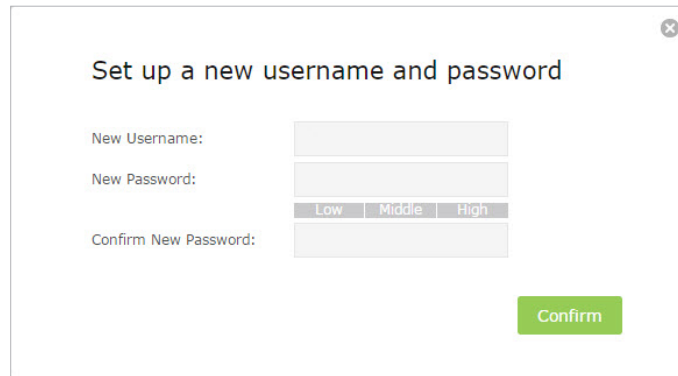

A dialog box titled 'Set up a new username and password' with a close button in the top right corner. It contains three input fields: 'New Username:', 'New Password:', and 'Confirm New Password:'. The 'New Password:' field has a strength indicator below it with three segments labeled 'Low', 'Middle', and 'High'. A green 'Confirm' button is located at the bottom right.

Note: Apps on the touchscreen will also need to use the new password that you have set to log in.

2.3. Quick Setup

The Quick Setup app will guide you through the process to set up your router.

1. On the menu screen, tap the [Quick Setup](#) icon to start it.
2. Set your [Time Zone](#) and tap [Next](#).

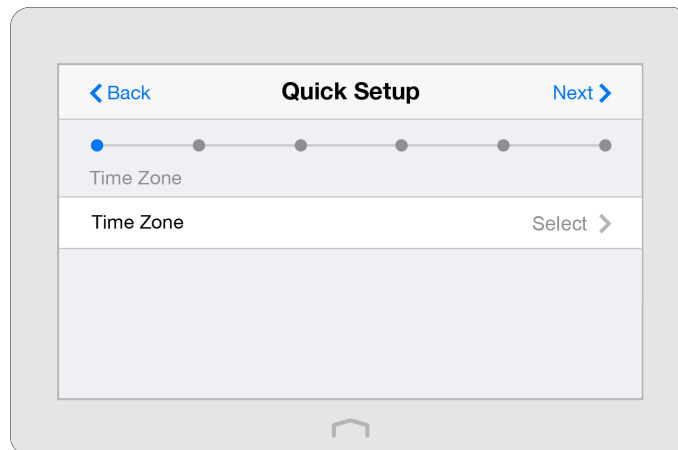

A screenshot of the 'Quick Setup' app interface. At the top, there are navigation links for '< Back' and 'Next >'. Below them is a progress indicator with six dots, the first of which is filled. The main content area shows 'Time Zone' with a 'Select >' button to its right. The bottom of the screen shows a home indicator.

3. Follow the on-screen instructions to complete the configuration.

Note: If you have changed the preset wireless network name (SSID) and wireless password during the quick setup process, all your wireless devices must use the new SSID and password to connect to your Touch P5.

2.4. Mode Selection

The Mode Selection app helps you easily switch your Touch P5 to a router, repeater or an access point.

Router Mode (Default): Touch P5 provides Internet access for multiple wired and wireless devices simultaneously.

Repeater Mode: Touch P5 extends your existing wireless coverage by repeating the wireless signal.

Access Point Mode: Touch P5 transforms your existing wired network to a wireless network.

1. On the menu screen, tap the **Mode Selection** icon to start it.
2. Select your desired mode, and tap **Save**.

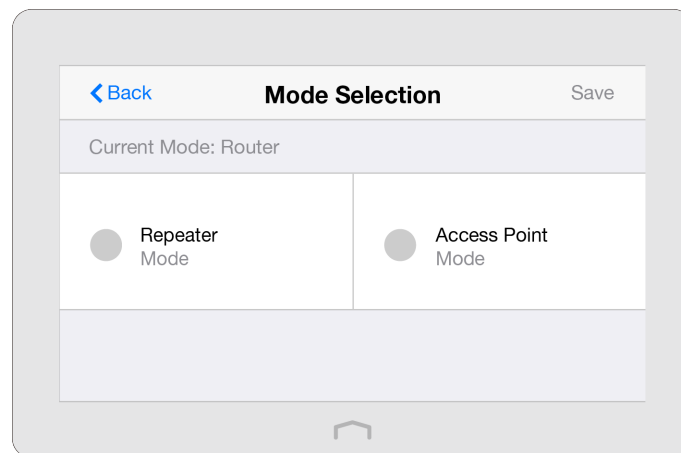

Note: Your Touch P5 will reboot to make your changes take effect, and please do **NOT** operate during the process.

2.5. Wireless Settings

The Wireless Settings app helps you customize the wireless settings including the wireless radio, wireless network name, password and security option, etc.

On the menu screen, tap the **Wireless Settings** icon to start it.

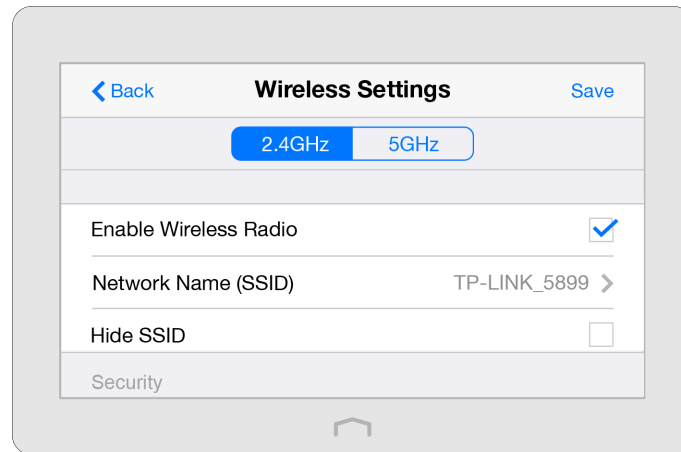

➤ **To enable or disable the wireless function:**

Select the wireless network 2.4GHz or 5GHz and enable the Wireless Radio. If you don't want to use the wireless function, just uncheck the box. If you disable the wireless function, all the wireless settings won't be effective.

➤ **To change the network name (SSID) or hide SSID:**

- Select the wireless network 2.4GHz or 5GHz and enter a new SSID up to 32 characters. The default SSID is TP-LINK_XXXX and the value is case-sensitive.
- Select the wireless network 2.4GHz or 5GHz and select **Hide SSID**, and your SSID will not display when you scan for local wireless networks and you need to manually join the network.

■ **Note:** If you change the wireless settings on a wireless device, you will be disconnected when the settings are effective.

➤ **To change the security option:**

Select the wireless network 2.4GHz or 5GHz, choose your **Security Type**, and enter the corresponding encryption parameters. Your Touch P5 provides four options:

- **No Security:** Select this option to disable the wireless security.
- **WPA/WPA2-Personal (Recommended):** Select this option to enable the standard authentication method based on a Pre-shared Key (PSK), also called passphrase. Its security level is the highest.
- **WPA/WPA2-Enterprise:** Select this option to enable the more advanced authentication method using a RADIUS (Remote Authentication Dial In User Service) server. If selected, WPS function will be disabled.
- **WEP:** Select this option to enable basic authentication method if any of your client devices can only access the wireless using WEP (Wired Equivalent Privacy).

➤ **To change the mode, channel width, channel or transmit power:**

Select the wireless network 2.4GHz or 5GHz.

Mode: Select the desired mode.

- 802.11ac only: Select only if all of your wireless clients are 802.11ac devices.
- 802.11n/ac mixed: Select if you are using both 802.11n and 802.11ac wireless clients.
- 802.11a/n/ac mixed: Select if you are using a mix of 802.11a, 802.11n, and 802.11ac wireless clients.

Note: It is strongly recommended that you select 802.11a/n/ac mixed, thus all 802.11a, 802.11n, and 802.11ac wireless devices can connect to your Touch P5.

- 802.11ac only (For 5GHz): Select only if all of your wireless clients are 802.11ac devices.
- 802.11n/ac mixed (For 5GHz): Select if you are using both 802.11n and 802.11ac wireless clients.
- 802.11a/n/ac mixed (For 5GHz): Select if you are using a mix of 802.11a, 802.11n and 802.11ac wireless clients. It is strongly recommended that you select 802.11a/n/ac mixed.

Channel Width: Select the channel width from the list. The default setting is **Auto**, which can adjust the channel width for your clients automatically.

Channel: Select the channel you want to use from the list. This field determines which operating frequency will be used. It is not necessary to change the wireless channel unless you notice interference problems with another nearby access point.

Transmit Power: Select either High, Middle, or Low to specify the data transmit power. The default and recommended setting is **High**.

➤ **Advanced wireless settings:**

If you are not familiar with the settings on this page, it's strongly recommended that you keep the provided default values; otherwise it may result in lower wireless network performance.

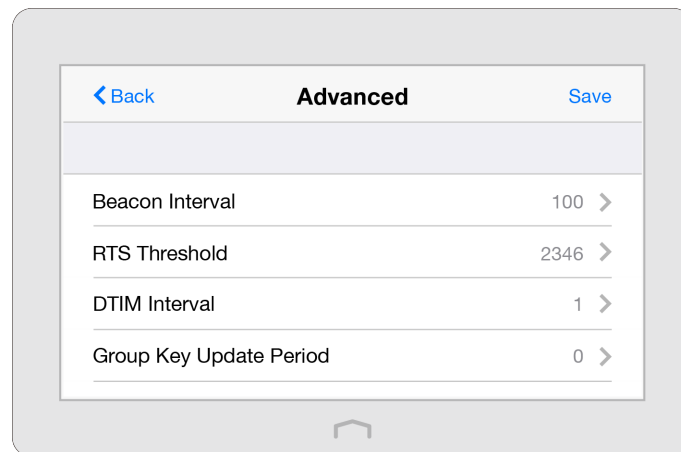

Beacon Interval: Enter a value between 40 and 1000 in milliseconds to determine the duration between beacon packets that are broadcasted by your Touch P5 to synchronize the wireless network. The default is 100 milliseconds.

RTS Threshold: Enter a value between 1 and 2346 to determine the packet size of data transmission through your Touch P5. By default, the RTS (Request to Send) Threshold size is 2346. If the packet size is greater than the preset threshold, your Touch P5 sends Request of Send frames to a particular receiving station and negotiates the sending of a data frame, or else the packet will be sent immediately.

DTIM Interval: This value determines the interval of the DTIM (Delivery Traffic Indication Message). Enter a value between 1 and 15 beacon intervals. The default value is 1, indicates the DTIM Interval is the same as Beacon Interval.

Group Key Update Period: Enter the number of seconds (minimum 30) to control the time interval for the encryption key automatic renewal. The default is 0, indicating no key renewal.

Enable WMM: The WMM function guarantees the packets with high-priority messages being transmitted preferentially. It is enabled by default and highly recommended.

Enable Short GI: This function is enabled by default and recommended to increase the data capacity by reducing the GI (Guard Interval) time.

Enable AP Isolation: If you want to confine and restrict all wireless devices connected to your network from interacting with each other, but still able to access the Internet, select the Enable AP Isolation checkbox.

2.6. WPS

The WPS app helps you quickly establish a secure wireless connection between WPS (Wi-Fi Protected Setup) supported devices and your Touch P5. Wireless devices that support WPS, including Android phones, tablets, and most USB network cards, can connect to your Touch P5 through this method (WPS is not supported by IOS devices).

Note: The WPS function cannot be configured if the wireless function of your Touch P5 is disabled. Also, the WPS function will be disabled if your wireless encryption for both 2.4GHz and 5GHz is WEP. Please make sure the wireless function is enabled and is configured with the appropriate encryption before configuring via the WPS.

1. On the menu screen, tap the **WPS** icon to start it.

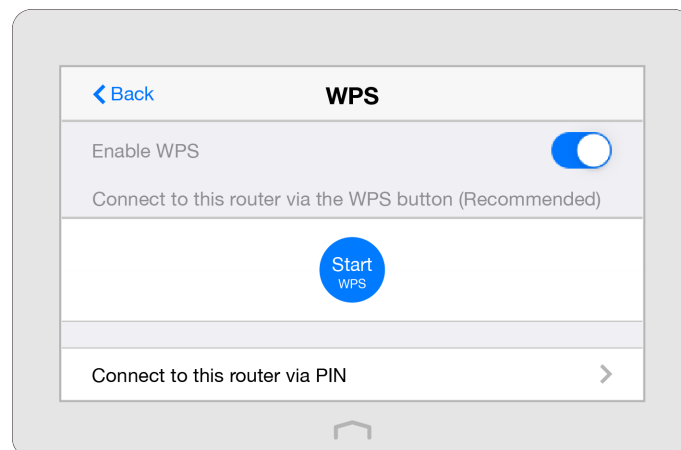

2. Use either the WPS Button method or PIN method.

➤ **Option 1: Use the WPS Button (Recommended)**

Use this option if your client device has a WPS button.

1) Tap the [Start WPS](#) button on the screen of your Touch P5, and the WPS button will show as below during the process.

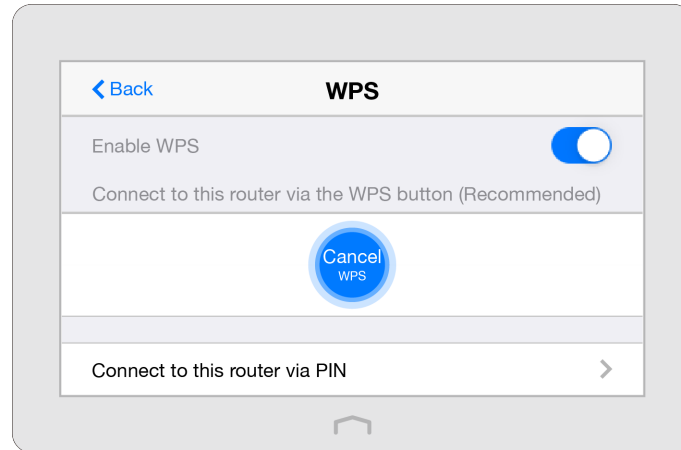

2) Immediately press the WPS button of the client device.

3) [Success](#) will appear on the above screen, which means the client device has successfully connected to your Touch P5.

■ **Note:** [Connection failed](#) will appear if the connection cannot be established within 2 minutes.

➤ **Option 2: Use the PIN**

Use this option if your client device asks for your Touch P5's PIN.

1) Tap [Connect to this router via PIN](#) on the above screen of your Touch P5 to get the PIN. You can use the default one or generate a new one.

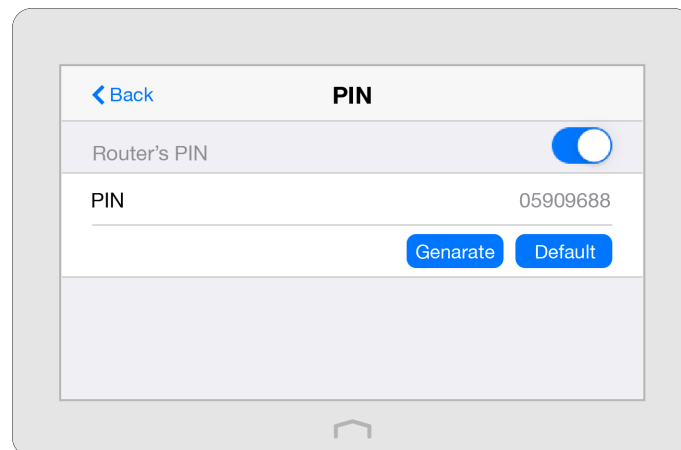

2) On the client device, enter your Touch P5's PIN to connect.

2.7. Guest Network

The Guest Network app allows you to provide Wi-Fi access for guests without disclosing your main network. When you have guests in your house, apartment, or workplace, you can create a guest network for them. In addition, you can assign permissions for guest network users to ensure the security and privacy of your main network.

On the menu screen, tap the [Guest Network](#) icon to start it.

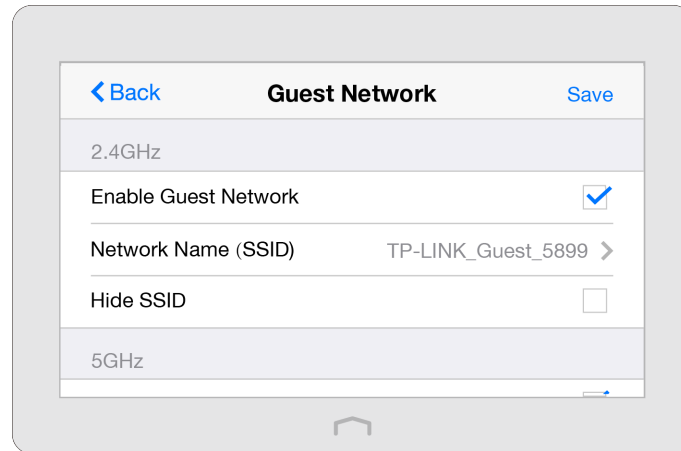

To enable or disable the guest network:

[Guest Network](#) is enabled by default. If you don't want to use the guest network function, just uncheck the box and all the guest network settings will be disabled.

To change the guest network name (SSID) or hide SSID:

1. Enter a new SSID up to 32 characters. The default SSID is TP-LINK_Guest_XXXX/ TP-LINK_Guest_XXXX_5G and the value is case-sensitive.
2. Select [Hide SSID](#), and your guest SSID will not display when you scan for local wireless networks and you need to manually join the network.

➤ To change the password or password update interval:

The guest Network 2.4GHz and 5GHz share one password. By default, the guest network password updates daily. You can change the update interval to weekly or monthly.

Or you can also select [Never](#) to set a static password for your guest networks. If you select [Never](#), please create a password between 8 and 63 ASCII characters or between 8 and 64 hexadecimal characters (0-9, a-f, A-F).

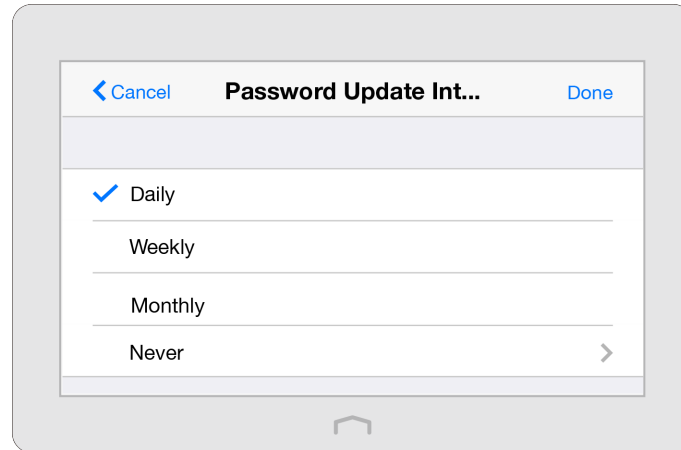

To limit the guest network authorities:

- **Allow guests to see each other:** Select this checkbox to allow clients in your guest network to access each other.
- **Allow guests to access my local network:** Select this checkbox to allow clients in your guest network to access your local network shares and printers, not just the Internet.

2.8. Parental Controls

The Parental Controls app allows you to block inappropriate, explicit and malicious websites and restrict access during certain periods (for example, client devices can only visit www.tp-link.com during office hours); At the same time it protects every device on your home network against malware and phishing through one central control point.

I want to: Control what types of websites my children or other home network users can visit and even the time they are allowed to access the Internet.

For example, I want to allow my children's devices (e.g. a computer or a tablet) to access only the following websites, www.tp-link.com and Wikipedia.org from 18:00 (6 PM) to 22:00 (10 PM) on weekdays.

How can I do that?

1. On the menu screen, tap the **Parental Controls** icon to start it and then enable **Parental Controls**.

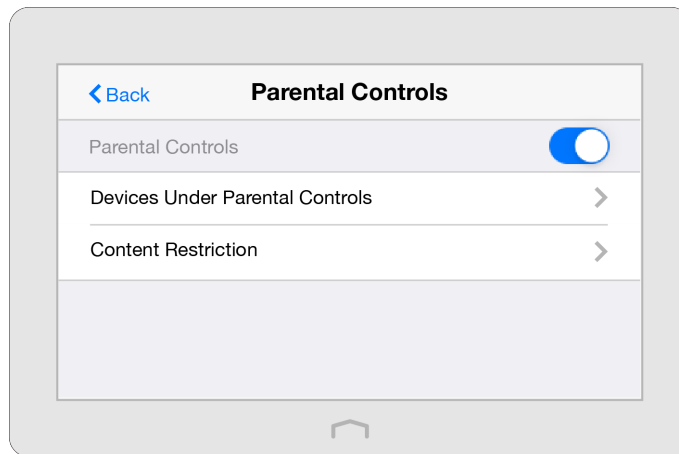

- 2) Tap [Devices Under Parental Controls](#) and then tap [Add](#) to add a device under parental controls.

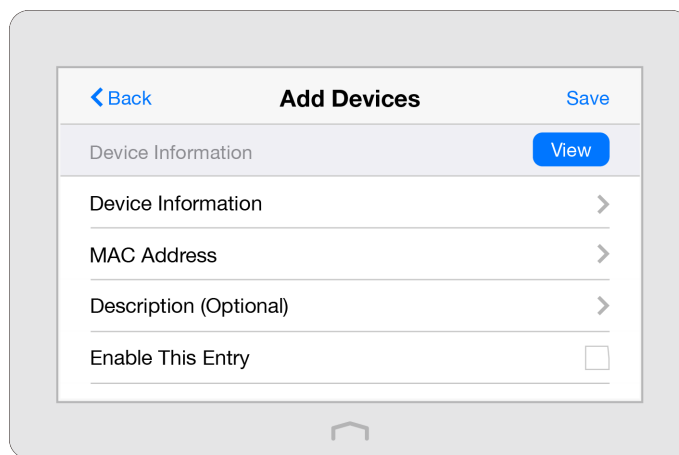

- 1) Tap [View](#) to see devices connected to your Touch P5 at present and select your desired device(s). Or, enter the [Device Name](#) and [MAC Address](#) manually if your desired device isn't connected to your Touch P5 at present.
- 2) Enter the [Description](#) of the device. Tap [Enable This Entry](#).
- 3) Tap [Internet Access Time](#) to set access time for the device.

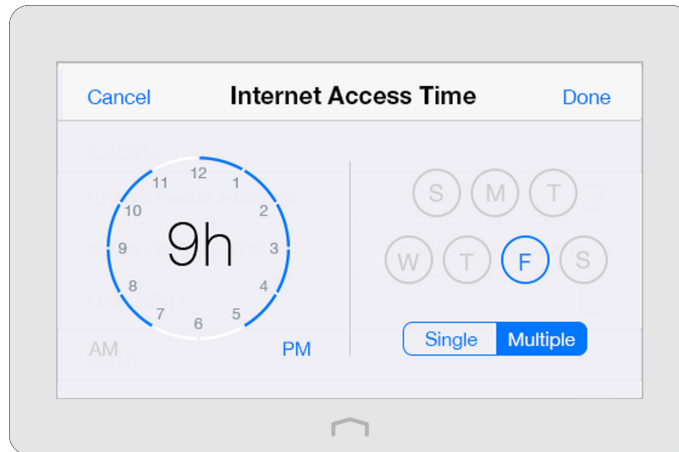

- **Single:** Select to set Internet access time for every single day respectively.
- **Multiple:** Select to set Internet access time for multiple days.
- **AM/PM:** Select to set time for the corresponding day(s).

Note: The access time schedule takes effect based on your Touch P5's system time. The system time can be set through the [Clock](#) app.

4) Tap [Save](#) to add the device to parental controls list.

Note: If you want to modify a device, tap the device to modify it. If you want to add or delete a device, tap [Edit](#) on the [Devices Under Parental Controls](#) page to set up according to your needs.

3. Return to the home page of [Parental Controls](#) and tap [Content Restriction](#) to specify the restriction policy.

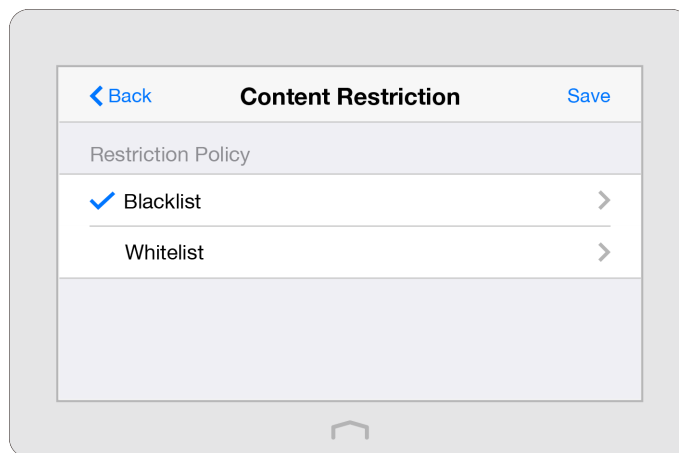

1) Select the restriction mode.

- In **Blacklist** mode, the controlled devices cannot access any websites containing the specified keywords during the Internet Access Time period.

- In [Whitelist](#) mode, the controlled devices can only access the websites in the whitelist during the Internet Access Time period.
- 2) Tap [Add](#) to [Add a New Keyword](#) or [Add a New Domain Name](#), then tap [Done](#) to add the rule. You can add up to 32 keywords for Blacklist and 32 domain names for Whitelist. Below are some sample entries to allow access.
- Enter a web address keyword (e.g. wikipedia) in blacklist to block access to the websites containing that keyword.
 - Enter a web address domain name (e.g. www.tp-link.com) allowed to access in whitelist. Specify the domain suffix (eg. .edu or .org) to allow access only to the websites with that suffix.
 - If you wish to block all Internet browsing access, do not add any domain name to the [Whitelist](#).
- ▀ **Note:** If you want to modify a rule, tap the rule to modify it. If you want to add or delete a rule, tap [Edit](#) to set up according to your needs.
4. Return to the [Content Restriction](#) page and tap [Save](#).

Done!

Now you can control your children's Internet access according to your needs.

2.9. Devices Control

The Devices Control app helps to view the client information and block unauthorized users (wired or wireless) from connecting to your Touch P5.

I want to:

Block specific client devices from connecting to my Touch P5.

How can I do that?

1. On the menu screen, tap the [Devices Control](#) icon to start it and then enable [Devices Control](#).

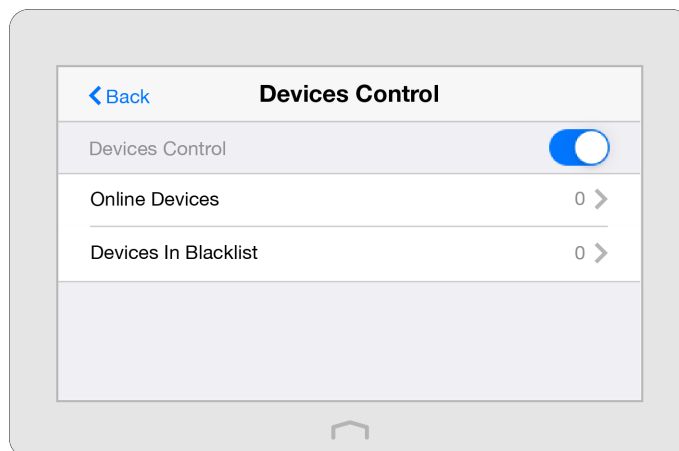

2. Tap **Online Devices** to view the connected clients.

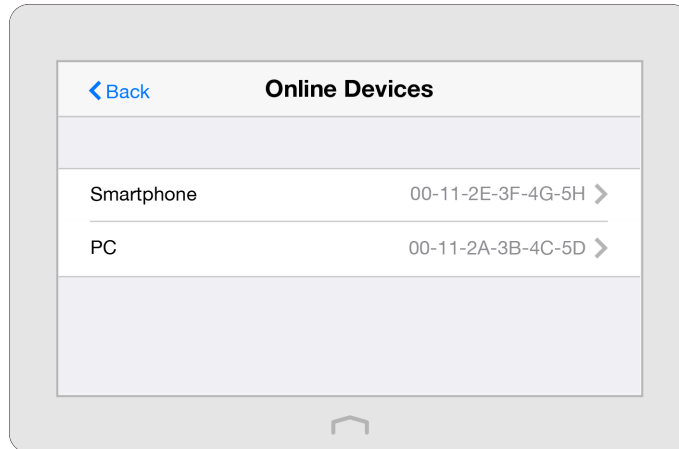

3. Select the device(s) to be blocked and tap **Block**.

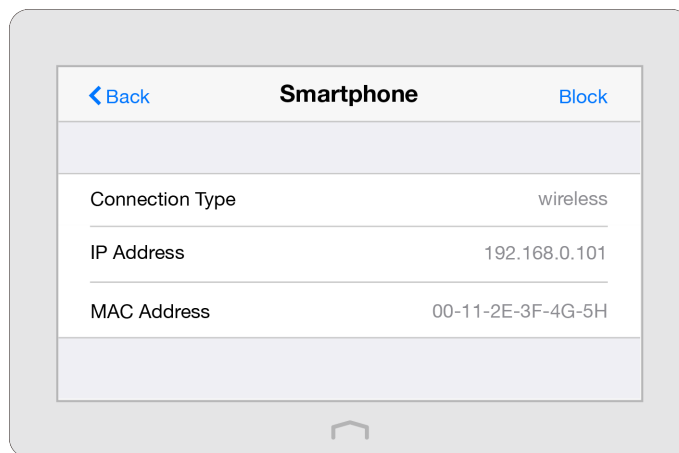

4. The blocked device(s) will be added to **Devices in Blacklist** automatically.

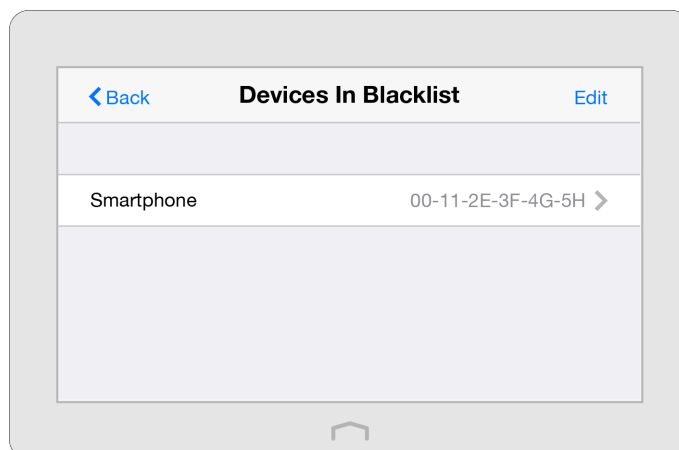

■ **Note:** If you want to add a device manually or delete a blocked device, tap **Edit** on the **Devices In Blacklist** page to set up as needed.

Done! Now devices in the blacklist cannot connect to your Touch P5.

2.10. Printer Server

The Printer Server app guides you how to share a printer with different computers connected to your Touch P5.

1. Install the Driver of the Printer

Make sure you have installed the driver of the printer on each computer that needs printer service. If you do not have the driver, contact the printer manufacturer.

2. Connect the Printer

Connect a printer to the USB port of your Touch P5 via a USB cable. Restart the **Printer Server** app again to see the **Printer Name** listed on the screen.

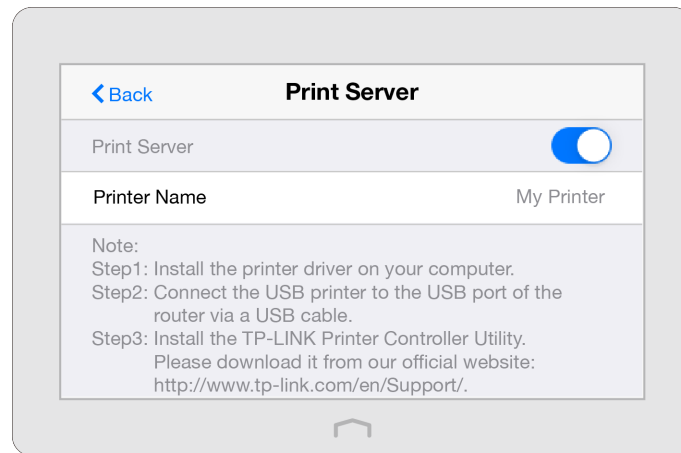

Note: You can check **Printer Compatibility List** at <http://www.tp-link.com/app/usb/> to verify whether your printer is supported by your Touch P5. Printers unlisted may be incompatible with your Touch P5.



3. Install the TP-LINK USB Printer Controller Utility

TP-LINK USB Printer Controller Utility helps you access the shared printer. Download and Install the utility on each computer that needs printer service.

You can get the utility from <http://www.tp-link.com/app/usb/>. PC Utility for Windows computers and Mac Utility for Mac computers.



4. Access the Printer

You should set the shared printer as Auto-Connect Printer on every computer that needs printer service.

- 1) Double click the icon  on your desktop to launch the USB Printer Controller.
- 2) Highlight the printer you share.

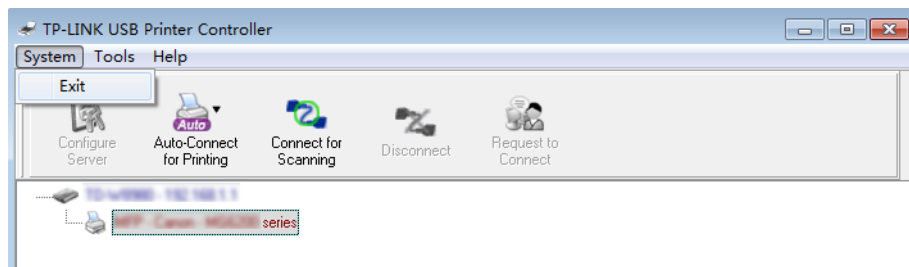

Windows

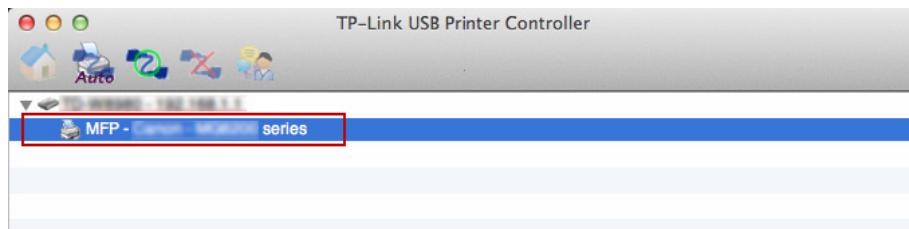

Mac

- 3) Click the **Auto-Connect for Printing** tab to pull down a list, and then select **Set Auto-Connect Printer**.

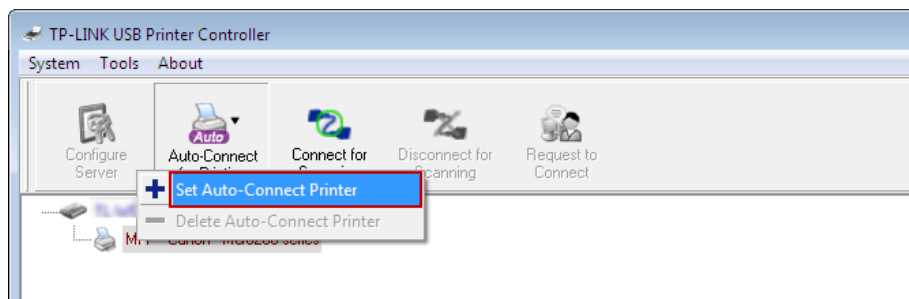

Windows

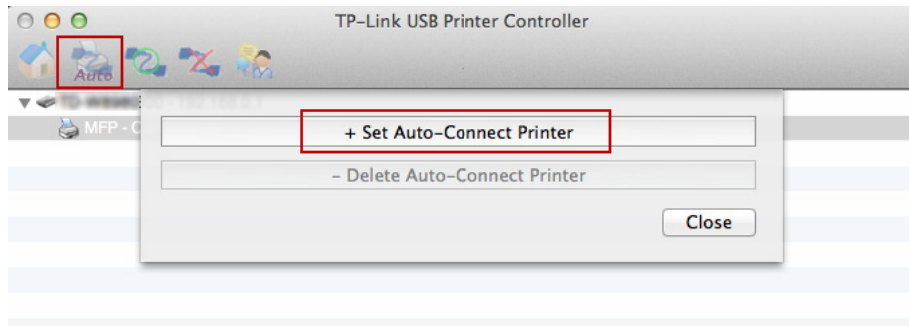

Mac

4) Select the printer you share and click [Apply](#).

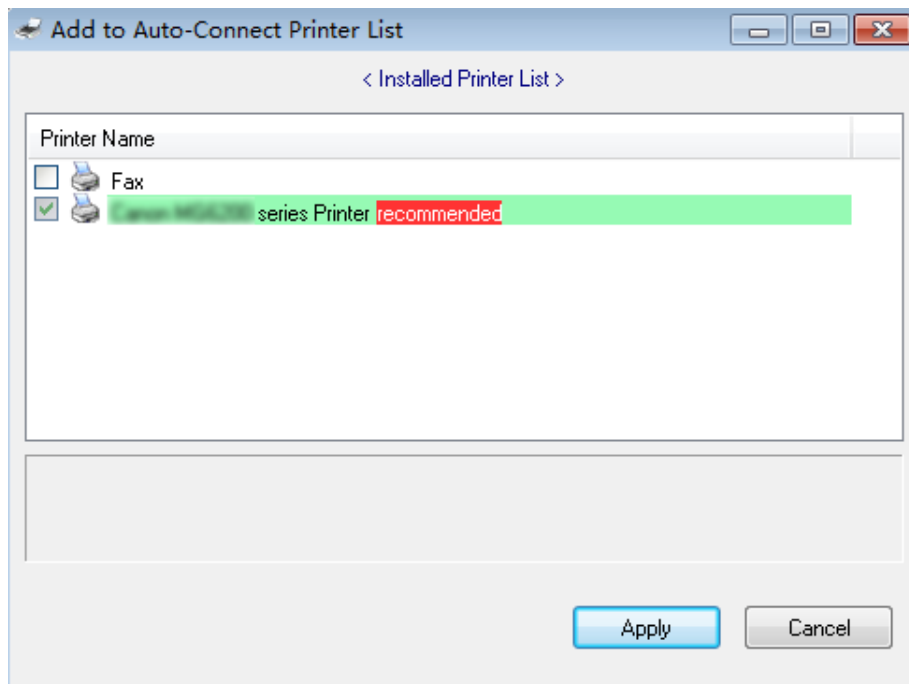

Windows

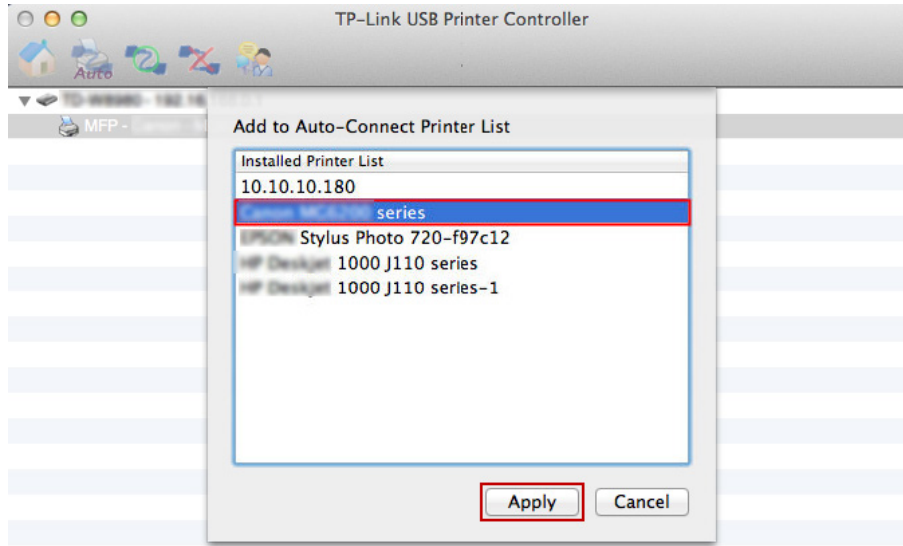

Mac

5) You will see the printer marked as **Auto-Connect Printer**. Now you can print with this printer.

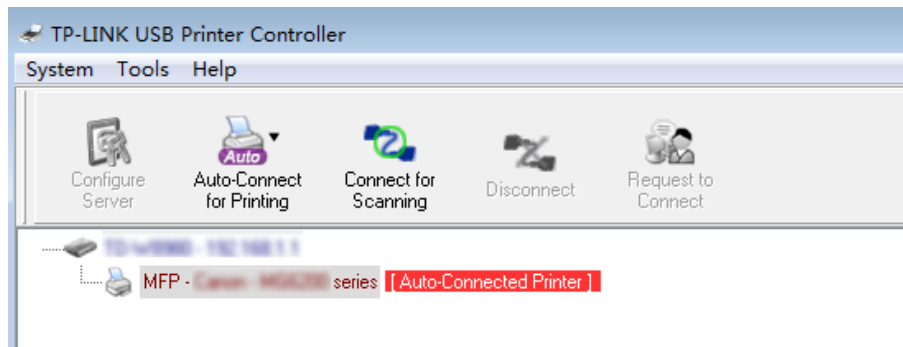

Windows

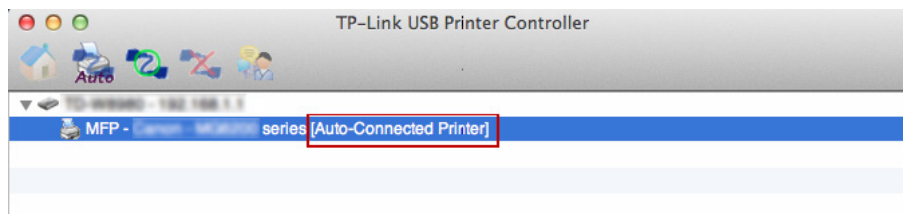

Mac

Note: The Print Server also allows different clients to share the scan feature of MFPs (Multi-Function Printers). To scan with **TP-LINK USB Printer Controller**, right click the printer and select **Network Scanner**. Then, a scanning window will pop up. Follow on-screen instructions to finish the scanning process.

2.11. DDNS

Most ISPs (Internet service providers) assign a dynamic IP address to your Touch P5 and you can use this IP address to access your Touch P5 remotely. However, the IP address can vary any time and you don't know when it changes. In this case, you might need the DDNS (Dynamic Domain Name Server) feature on your Touch P5 to allow you and your friends to access your Touch P5 and local servers (FTP, HTTP, etc.) using a domain name, in no need of checking and remembering the IP address.

■ **Note:** DDNS does not work if the ISP assigns a private WAN IP address (such as 192.168.0.x) to your Touch P5.

1. On the menu screen, tap the **DDNS** icon to start it.

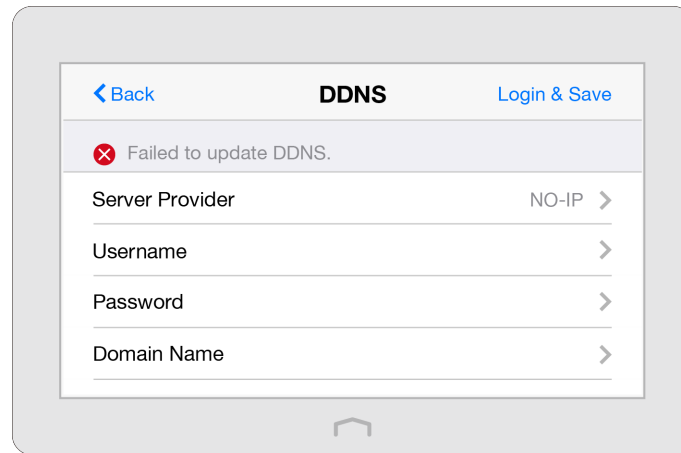

2. Select a DDNS **Service Provider** (NO-IP or Dyndns). If you don't have a DDNS account, please register an account with a service provider such as www.dyndns.com.
3. Enter the **Username**, **Password**, **Domain Name** (such as lisadns.ddns.net), and select **Update Interval** of the account.
4. Tap **Login & Save**.

■ **Note:** If you want to use a new DDNS account, please **Logout** first, then login with the new account.

2.12. LAN

The LAN app helps to change the default LAN settings of your Touch P5. Touch P5 is preset with a default LAN IP 192.168.0.1, with which you can log in to its web management page. The LAN IP address together with the Subnet Mask also defines the subnet that the connected devices are on. If the IP address conflicts with another device on your local network or your network requires a specific IP subnet, you can change it.

1. On the menu screen, tap the **LAN** icon to start it.

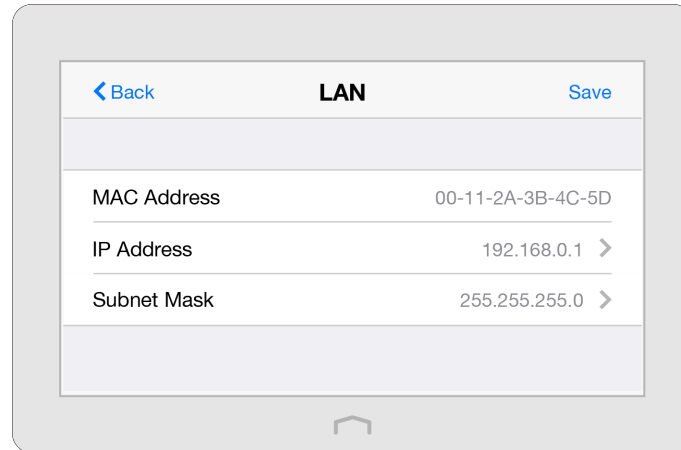

2. Type in a new [IP Address](#) as needed.
3. Select the [Subnet Mask](#) or customize one in dotted decimal format. The subnet mask together with the IP address identifies your local IP subnet.
4. Tap [Save](#).

2.13. DHCP Server

The DHCP Server app can configure your Touch P5 to act as a DHCP (Dynamic Host Configuration Protocol) server to assign IP addresses to its clients and view client information from the client list. To use the DHCP server of your Touch P5, you must configure all computers on the LAN as [Obtain an IP Address automatically](#). You can also manually reserve an IP address for a client that is connected to your Touch P5. Once reserved, the IP address will only be assigned to the client by the DHCP server.

1. On the menu screen, tap the [DHCP Server](#) icon to start it.

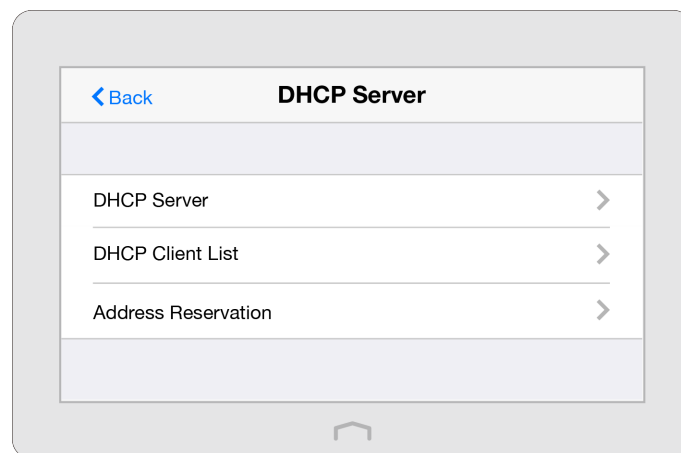

2. Configure the DHCP settings as needed.
- **To set DHCP server of your Touch P5:**

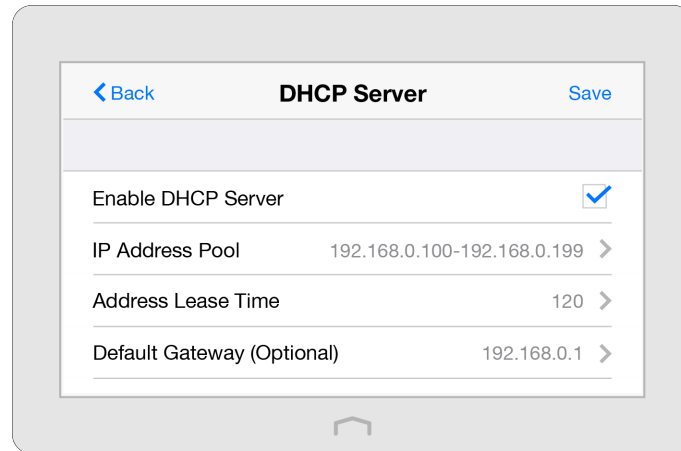
1) Select **DHCP Server**.2) The **Enable DHCP Server** checkbox is enabled by default.3) Specify the **IP Address Pool**, and the start and end addresses must be on the same subnet with the LAN IP. Your Touch P5 will assign addresses within this specified range to its clients. It is from 192.168.0.100 to 192.168.0.199 by default.4) Enter a value for the **Address Lease Time**.

The **Address Lease Time** is the amount of time in which a DHCP client can lease its current dynamic IP address assigned by your Touch P5. After the dynamic IP address expires, the client will be automatically assigned a new dynamic IP address.

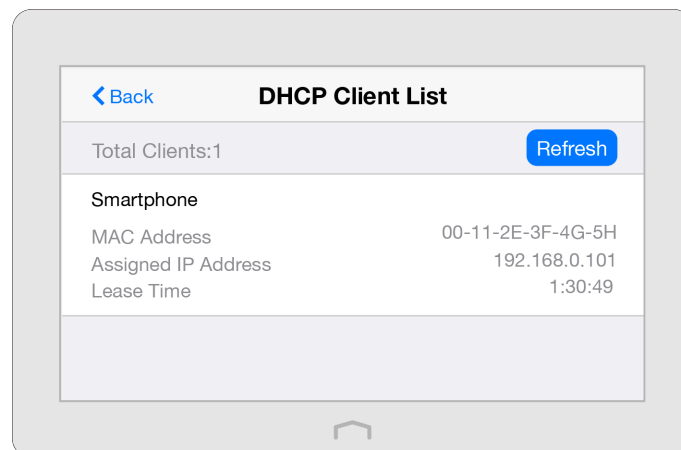
5) The **Default Gateway** is automatically filled, the same as the LAN IP address of your Touch P5. Enter **Primary DNS** and **Secondary DNS** if the ISP offers.6) Tap **Save**.➤ **To view the client information:**1) Select **DHCP Client List**.

2) You can view the information of connected clients.

➤ **To reserve an IP address for a specified client device:**

- 1) Select [Address Reservation](#) and tap [Add](#) to add an address reservation entry for your device.

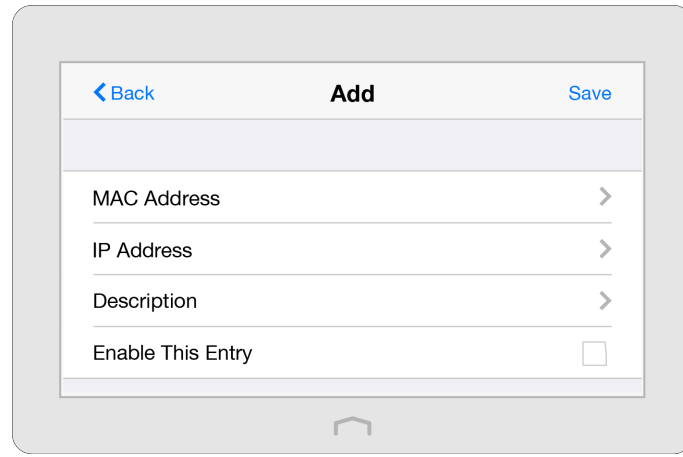

- 2) Enter the [MAC Address](#) of the device for which you want to reserve IP address.
- 3) Specify the [IP Address](#) which will be reserved for the device.
- 4) Enter the [Description](#) for the device.
- 5) Check the [Enable This Entry](#) box and tap [Save](#) to make the settings effective (shown as below).

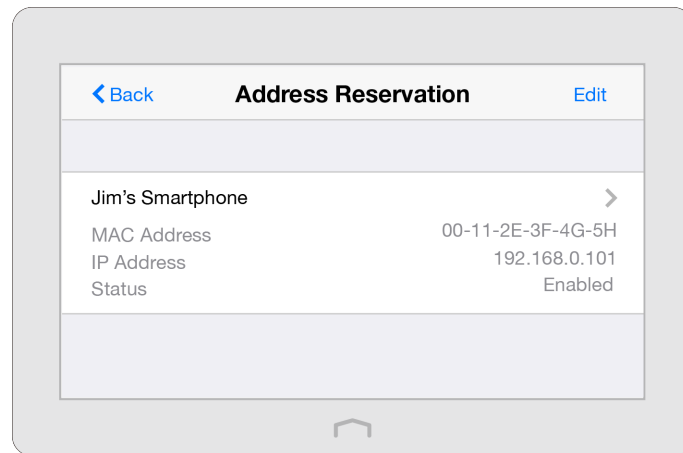

■ **Note:** If you want to modify a reserved address, tap the reserved address to modify it. If you want to add or delete a reserved address, tap [Edit](#) to set up as needed.

2.14. QoS

By default, the Internet bandwidth is shared by connected devices and applications, which means that the bandwidth of each device or application is uncontrollable while they are sharing the Internet. When some device is streaming videos on Internet or downloading with P2P software, the Internet experience of other applications will be

affected. The QoS (Quality of Service) app can help to specify priority levels for some devices or applications, thus avoiding the situation.

1. On the menu screen, tap the **QoS** icon to start it.

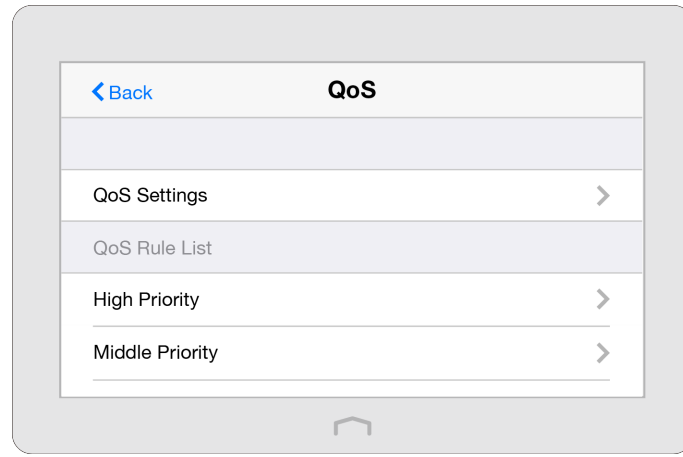

2. Select **QoS Settings** to set the parameters of QoS.

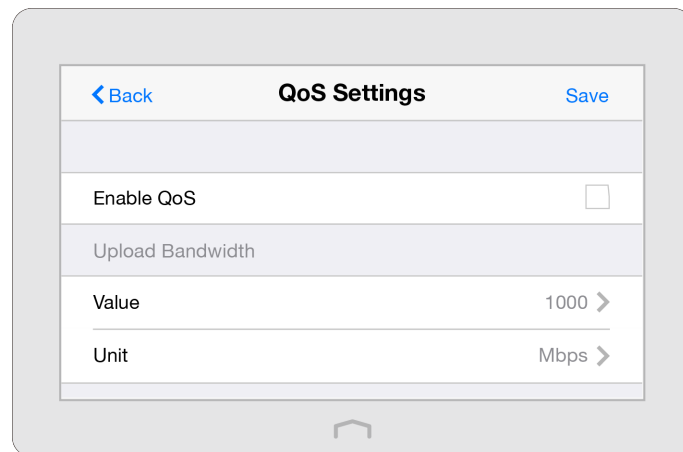

- 1) Select **Enable QoS** checkbox.
- 2) Set the maximum upload and download bandwidth provided by your service provider. 1Mbps equals to 1024Kbps.
- 3) Select **Advanced** and drag the scroll bar to set the bandwidth priority percentage. Tap **Done**.

■ **Note:** Add each priority up no more than 100%.

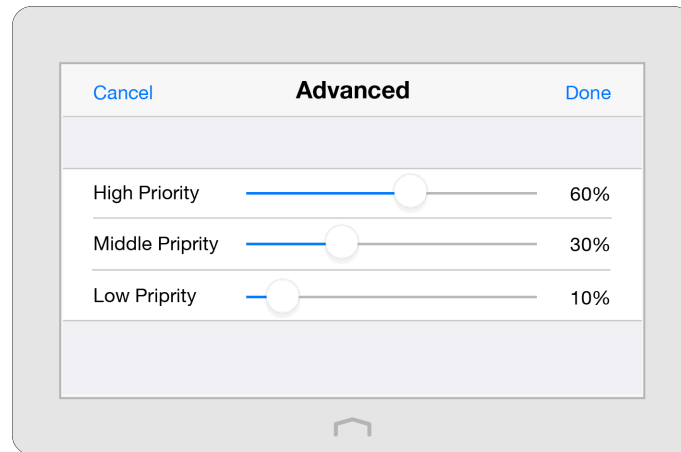

- 4) Tap **Save**.
3. Return to the home screen of QoS, and select **High**, **Middle** or **Low Priority** to **Add** the rules. Here we use **High Priority** as an example.

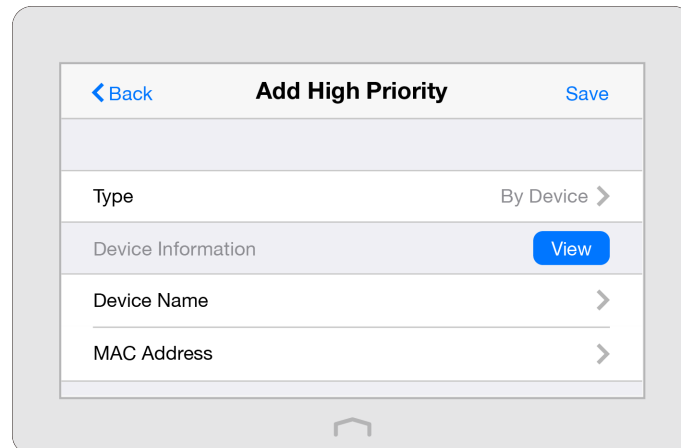

4. Select **By Device** or **By Application** as the rule type.
5. If **By Device** is selected, tap **View** to choose the respective device. If the device is not listed, enter the **Device Name** and **MAC Address** manually.
- If **By Application** is selected, tap **Application** to select the corresponding application. If the application is not listed, tap **Custom Application** to enter below application parameters manually.
- **Name**: Type in a name for your application.
 - **Protocol**: Select the protocol for your application, if you are not sure, select **ALL**.
 - **Port**: Enter the destination port for your application. Usually each application has a fixed port, so please ensure you enter the correct port.
6. Tap **Save**. The QoS rule will be listed in the priority table.

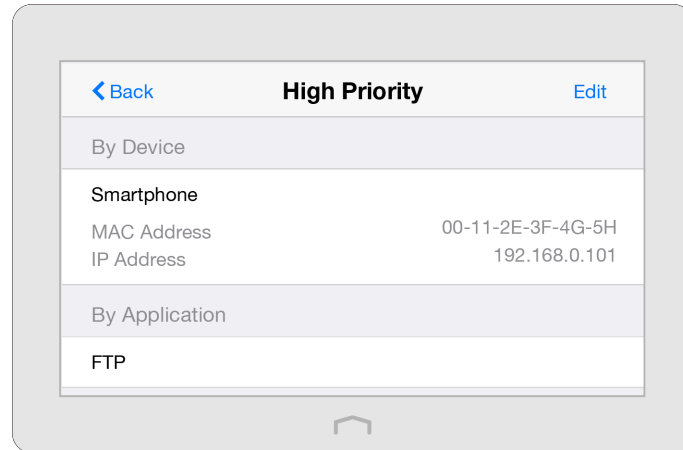



■ **Note:** If you want to add or delete a QoS rule, tap **Edit** to set up according to your needs.

2.15. Clock

The Clock app displays the time while your Touch P5 is running. The system time you configure here will be used for other time-based functions like Parental Controls.

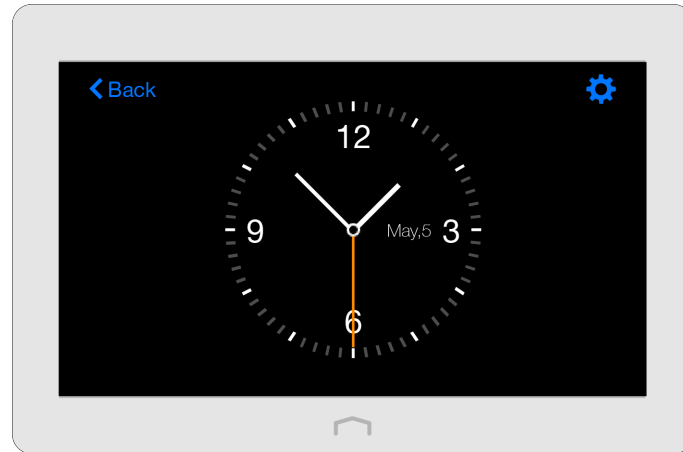
1. On the menu screen, tap the **Clock** icon to start it.



2. Tap  to configure the time settings.
- **To set the time of your Touch P5:**
- 1) Select **Time Settings**.

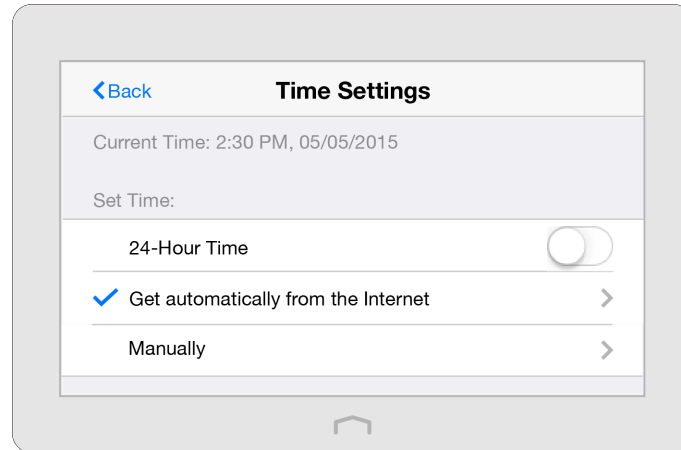

- 2) Toggle on or off to customize the time display in 12-hour or 24-hour format.
- 3) Two ways for you to configure the system time:
 - **Get automatically from the Internet:** Select this if you want to get time from the Internet. Make sure your Touch P5 can access the Internet before you select this method.
 - a. Select your local **Time Zone**.
 - b. In the **NTP Server I** field, enter the IP address or domain name of your desired NTP Server.
 - c. In the **NTP Server II** field, enter the IP address or domain name of the second NTP Server (Optional).
 - d. Tap **Obtain** to get the time and then tap **Save**.

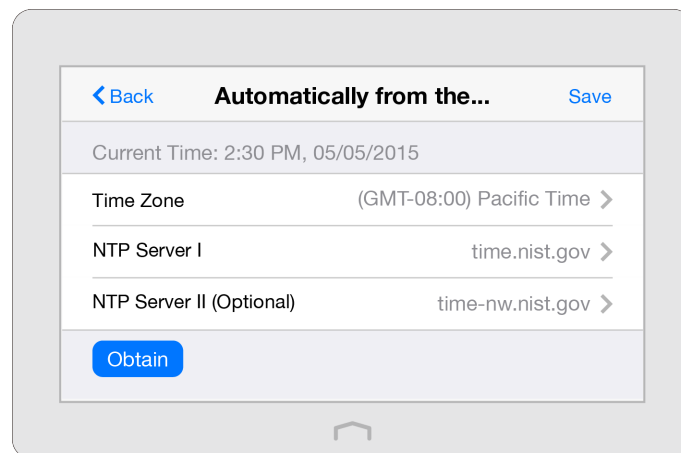

- **Manually:** Select to set the date and time manually, and tap **Save**.

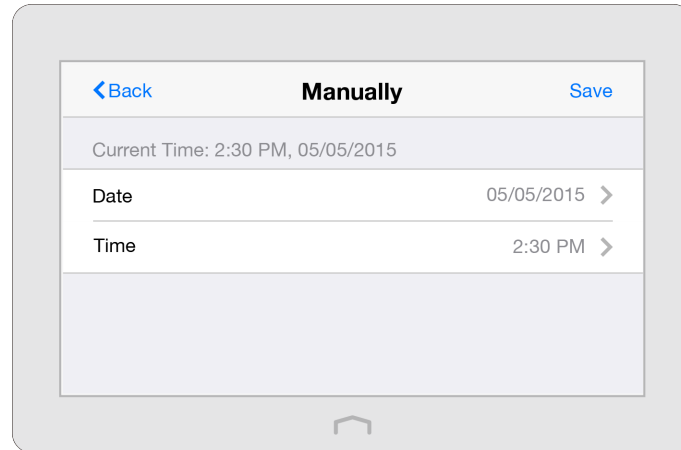

➤ **To set up daylight saving time of your Touch P5:**

- 1) Select [Daylight Saving Time](#).
- 2) Select the checkbox to enable [Daylight Saving Time](#). Set the start and end time and then tap [Save](#).

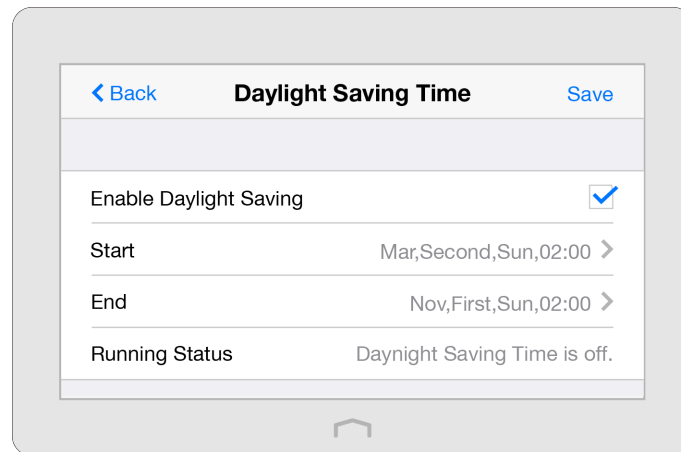

➤ **To set up the display type of the clock:**

- 1) Select [Clock Display](#).
- 2) Select the clock type and tap [Save](#).

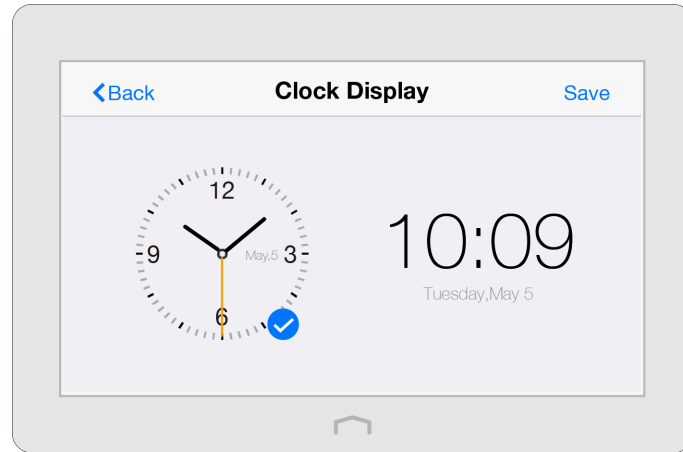

- 3) To use your Touch P5 as a clock, you need to stay at the home page of **Clock** app. Then the clock will display on the screen while your Touch P5 is locked.

Note: Overusing the screen as a clock will decrease the life span of the screen.

2.16. Screen Settings

The Screen Settings app helps to set the brightness and screen saver of your Touch P5.

1. On the menu screen, tap the **Screen Settings** icon to start it.

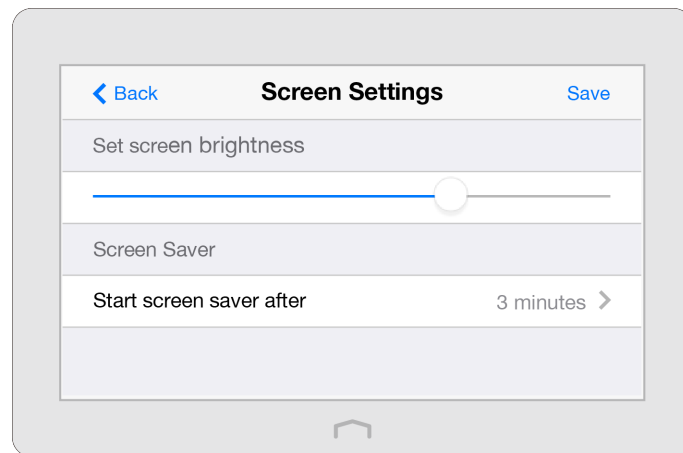

2. Drag the scroll bar to set the brightness of the screen.
3. By default, the screen saver will start if the screen is idle for 3 minutes. You can change the wait time.

Note: If you select **Never**, the screen will stay on and never go to sleep and this will decrease the life span of the screen.

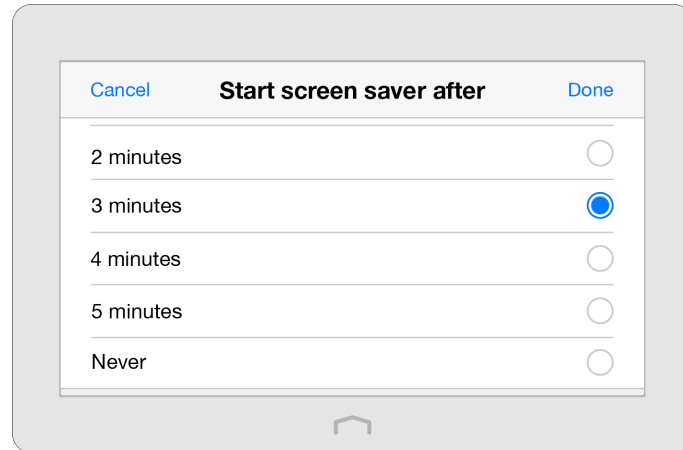

2.17. Reboot & Reset

With the Reboot & Reset app, you can restart your Touch P5 or reset it to its factory default settings.

1. On the menu screen, tap the [Reboot & Reset](#) icon to start it.

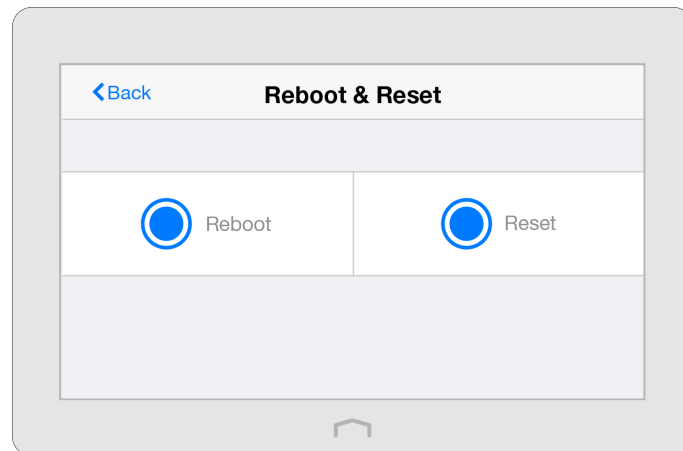

2. **Reboot:** Your Touch P5 will shut down and boot again.

Reset: To reset your Touch P5 to its factory default settings and all the settings you have configured will be erased.

■ **Note:** Please do **NOT** power off your Touch P5 during the rebooting or resetting process.

2.18. Administrator Password

Administrator password is used to log in to the touchscreen page and web management page of your Touch P5. You are required to set a new administrator password at your first login. You can also change it with the Administrator Password app.

1. On the menu screen, tap the **Administrator Password** icon to start it.

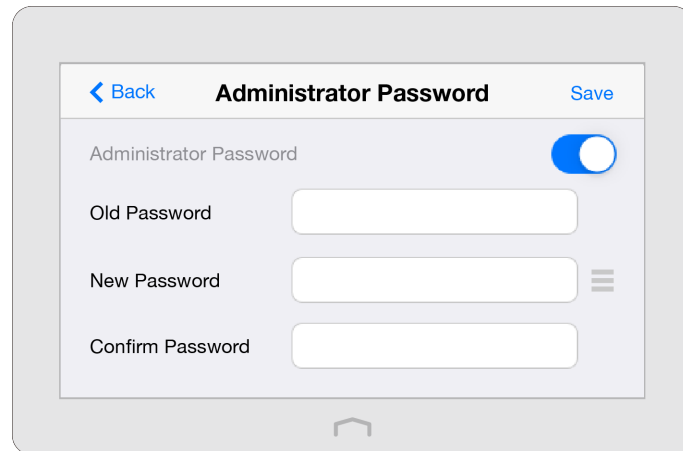

2. Enter the old password. Enter the new password and enter again to confirm.
3. Tap **Save**.

Note:

1. If you disable this function, your touchscreen will under no protection and anyone can change the settings of your Touch P5. But logging into the web management page still requires the password.
2. If you change the administrator password on the screen, logging into the web management page also requires the new password.

2.19. About

The About app displays the product model and hardware and firmware information of your Touch P5. On the menu screen, tap the **About** icon to start it.

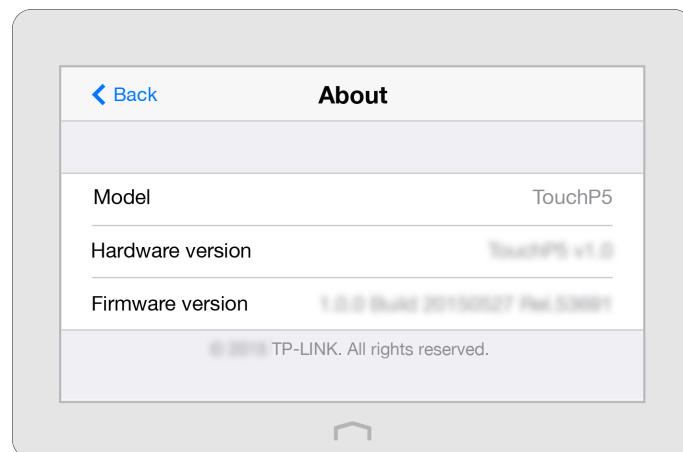

2.20. USB Application

This section describes how to share and access USB devices connected to your Touch P5 among different clients [through web-based utility](#). Refer to [Through Web-based Utility](#) to log into your Touch P5.

Touch P5 only supports USB external flash drives, hard drives and USB printers, and does not support 3G/4G USB modems.

This chapter contains the following sections:

- [Local Storage Sharing](#)
- [Remote Access via FTP Server](#)
- [Media Sharing](#)

2.20.1. Local Storage Sharing

Share your USB storage devices with different users on the network.

Access the USB disk

1. **Connect Your USB Disk:** insert your USB storage device into your Touch P5's USB port directly or using a USB cable.

Note:

1. If you use USB hubs, make sure no more than four devices are connected to your Touch P5.
2. If the USB storage device requires using bundled external power, make sure the external power has been connected.
3. If you use a USB hard drive, make sure its file system is FAT32 or NTFS.
4. Before you physically disconnect a USB device from your Touch P5, safely remove it to avoid data damage: select [Advanced](#) > [USB Settings](#) > [Device Settings](#) and click [Safely Remove](#).

2. **Access Your USB Disk:** by default all the network clients can access all folders on your USB disk. Refer to the following table for access instructions. You can also customize your sharing content and set a sharing account referring to [Customize Your Settings](#).

Windows computer	<ol style="list-style-type: none"> a. Press Windows () + R on the keyboard (or select Start > Run). b. Type in the server address \\tplinkwifi.net or ftp://tplinkwifi.net in the dialog box. c. Click OK.
Mac	<ol style="list-style-type: none"> a. Select Go > Connect to Server. b. Type the server address smb://tplinkwifi.net or ftp://tplinkwifi.net. c. Click Connect.
Pad	Use a third-party app for network files management.

Note:

You can also access your USB disk using your Network/Media Server Name. Refer to [To Customize the Address of the USB Disk](#) to learn more.

Customize Your Settings

➤ To only share specific content

By default, **Share All** is enabled so all contents on the USB disk are shared. If you want to only share specific folders, follow the steps below:

1. Visit <http://tplinkwifi.net>, and then log in with the username and password you set for your Touch P5.
2. Select **Basic > USB Settings > Sharing Access**. Focus on the **Folder Sharing** section. Click the button to disable **Share All**, and then click **Add** to add a new sharing folder.

Folder Sharing

Share All: Off Toggle On to share all files and folders or keep it Off to only share the specified folders.

[+ Add](#) [- Delete](#)

<input type="checkbox"/>	ID	Folder Name	Folder Path	Media Sharing	Volume Name	Active	Modify
<input type="checkbox"/>	--	--	--	--	--	--	--

Volume Name:

Folder Path:

Folder Name:

Allow Guest Network Access

Enable Authentication

Enable Write Access

Enable Media Sharing

3. Select the **Volume Name** and **Folder Path**, and then enter a **Folder Name** as you like.
4. Decide the way you share the folder:
 - **Allow Guest Network Access:** Tick to allow the clients in your guest network to access the shared folder.
 - **Enable Authentication:** Tick to enable authentication for this folder sharing, and you will be required to use a username and password to access the USB disk. Refer to [To Set up Authentication for Data Security](#) to learn more.
 - **Enable Write Access:** If you tick this check box, network clients can modify this folder.

- **Enable Media Sharing:** Tick to enable media sharing for this folder, and you can view photos, play music and watch movies stored on the USB disk directly from DLNA-supported devices. Click [Media Sharing](#) to learn more.

5. Click **OK**.

Note:

Touch P5 can share eight volumes at most. You can click  on the page to detach the corresponding volume you do not need to share.

➤ **To Set up Authentication for Data Security**

If you enable [Authentication](#), network clients will be required to enter the username and password you set when accessing the USB disk.

1. Visit <http://tplinkwifi.net>, and then log in with the username and password you set for your Touch P5.
2. Go to [Advanced](#) > [USB Settings](#) > [Sharing Access](#).

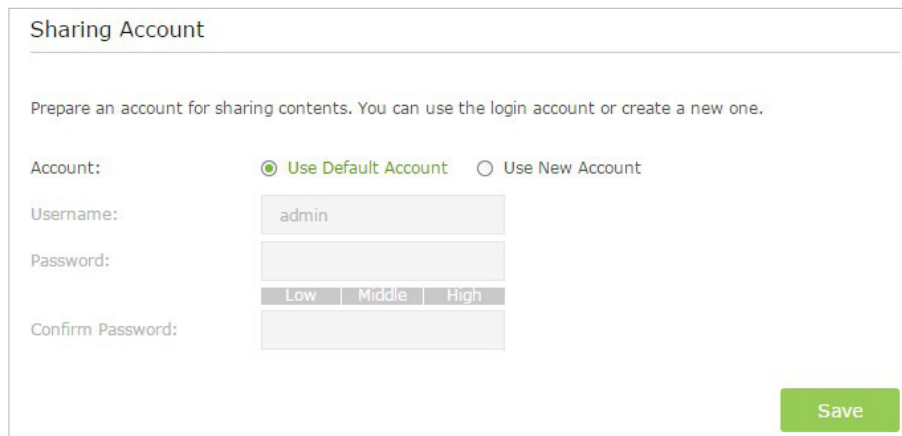

3. Choose to use the default Account (admin) or use a new account and click [Save](#).
4. Enable [Authentication](#) to apply the account you just set.
 - If you leave [Share All](#) enabled, click the button to enable [Authentication](#) for all folders.

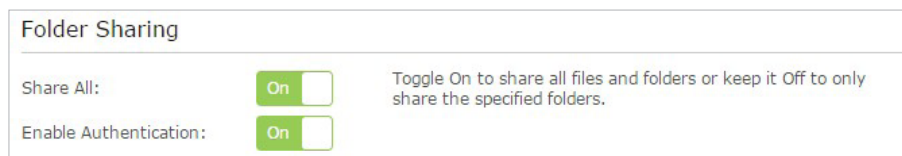

- If [Share All](#) is disabled, enable [Authentication](#) for specific folders.

➤ **To Customize the Address of the USB Disk**

You can customize the server name and use the name to access your USB disk.

1. Visit <http://tplinkwifi.net>, and then log in with the username and password you set for your Touch P5.
2. Go to [Advanced](#) > [USB Settings](#) > [Sharing Access](#).

3. Make sure **Network Neighborhood** is ticked, and enter a Network/Media Server Name as you like, such as **MyShare**, then click **Save**.

Sharing Settings

Network/Media Server Name:

Enable	Access Method	Link	Port
<input checked="" type="checkbox"/>	Network Neighborhood	\\MyShare	---
<input checked="" type="checkbox"/>	FTP	ftp://192.168.0.4:21	21
<input type="checkbox"/>	FTP (Via Internet)	ftp://0.0.0.0:21 Edit	<input type="text" value="21"/>

[Save](#)

4. Now you can access the USB disk with **\\MyShare** (**smb://MyShare** for Mac).

2. 20. 2. Remote Access via FTP Server

You can access your USB disk outside the local area network.

For example:

- Share photos and other large files with your friends without logging in to (and paying for) a photo-sharing site or email system.
- Get a safe backup for the materials for a presentation.
- Remove the files on your camera's memory card from time to time during the journey.

■ Note:

If your ISP assigns a private WAN IP address (such as 192.168.x.x or 10.x.x.x), you cannot use this feature because private addresses are not routed on the Internet.

Access the USB disk

1. **Connect Your USB Disk:** insert your USB storage device into your Touch P5's USB port directly or using a USB cable. Wait several seconds until the USB LED becomes solid on.

■ Note:

1. If you use USB hubs, make sure no more than four devices are connected to your Touch P5.
 2. If the USB storage device requires using bundled external power, make sure the external power has been connected.
 3. If you use a USB hard drive, make sure its file system is FAT32 or NTFS.
 4. Before you physically disconnect a USB device from your Touch P5, safely remove it to avoid data damage: select **Advanced > USB Settings > Device Settings** and click ➔ **Safely Remove**.
2. **Enable Authentication for Data Security:** it is strongly recommended that you set and apply a sharing account for data security.

- 1) Visit <http://tplinkwifi.net>, and then log in with the username and password you set for your Touch P5.
- 2) Go to [Advanced](#) > [USB Settings](#) > [Sharing Access](#).
- 3) Select [Use Default Account](#) (admin) or [Use New Account](#) and click [Save](#).

Sharing Account

Prepare an account for sharing contents. You can use the login account or create a new one.

Account: Use Default Account Use New Account

Username:

Password:

Confirm Password:

- 4) Enable [Authentication](#) to apply the sharing account.
 - If you leave [Share All](#) enabled, click the button to enable [Authentication](#) for all folders.

Folder Sharing

Share All: Toggle On to share all files and folders or keep it Off to only share the specified folders.

Enable Authentication:

- If [Share All](#) is disabled, enable [Authentication](#) for specific folders.
3. Enable the FTP(via Internet): tick the check box to enable [FTP\(Via Internet\)](#), and click [Save](#).

Sharing Settings

Network/Media Server Name:

Enable	Access Method	Link	Port
<input checked="" type="checkbox"/>	Network Neighborhood	\\MyShare	---
<input checked="" type="checkbox"/>	FTP	ftp://192.168.0.4:21	21
<input checked="" type="checkbox"/>	FTP (Via Internet)	ftp://0.0.0.0:21 Edit	<input type="text" value="21"/>

4. Access Your USB Disk via Internet: now different clients with Internet connection can access the USB disk.

Computer	<ul style="list-style-type: none"> To download, launch a web browser and type the server address <code>ftp://<WAN IP address of your Touch P5>:<port number></code> (such as <code>ftp://59.40.2.243:21</code>) or <code>ftp://<domain name of your Touch P5>:<port number></code> (such as <code>ftp://MyDomainName:21</code>) in the address bar, and then press Enter on the keyboard. To upload, use a third-party app for network files management.
Pad	<ul style="list-style-type: none"> Use a third-party app for network files management.

Note: Click [DDNS](#) to learn how to set up a domain name for your Touch P5.

Customize Your Settings

By default, **Share All** is enabled so all contents on the USB disk are shared. If you want to only share specific folders, follow the steps below:

1. Visit <http://tplinkwifi.net>, and then log in with the username and password you set for your Touch P5.
2. Go to **Basic > USB Settings > Sharing Access**.
3. Focus on the section of **Folder Sharing**. Click the button to disable **Share All**, and then click **Add** to add a new sharing folder.

Folder Sharing

Share All: Off Toggle On to share all files and folders or keep it Off to only share the specified folders.

[+ Add](#) [- Delete](#)

<input type="checkbox"/>	ID	Folder Name	Folder Path	Media Sharing	Volume Name	Active	Modify
--	--	--	--	--	--	--	--

Volume Name:

Folder Path: [Browse](#)

Folder Name:

Allow Guest Network Access

Enable Authentication

Enable Write Access

Enable Media Sharing

[Cancel](#) [OK](#)

4. Tick **Enable Authentication**. If you allow network clients to modify this folder, tick **Enable Write Access**.
5. Click **OK**.

Note: Touch P5 can share eight volumes at most. You can click  on the page to detach the corresponding volume you do not need to share.

2. 20. 3. Media Sharing

The feature of [Media Sharing](#) allows you to view photos, play music and watch movies stored on the USB disk directly from DLNA-supported devices, such as your computer, pad and PS2/3.

Access the USB disk

1. **Connect Your USB Disk:** insert your USB storage device into your Touch P5's USB port directly or using a USB cable. Wait several seconds until the USB LED becomes solid on.

Note:

1. If you use USB hubs, make sure no more than four devices are connected to your Touch P5.
 2. If the USB storage device requires using bundled external power, make sure the external power has been connected.
 3. If you use a USB hard drive, make sure its file system is FAT32 or NTFS.
 4. Before you physically disconnect a USB device from your Touch P5, safely remove it to avoid data damage: select [Advanced](#) > [USB Settings](#) > [Device Settings](#) and click  [Safely Remove](#).
2. **Access the Media Files on Your USB Disk:** now the DLNA-supported devices connected to your Touch P5 can detect and play the media files on the USB disks. For example:

Windows computer	<ol style="list-style-type: none"> a. Open the Windows Media Player. b. Click the media server name (Touch_P5-share by default) under the list of Other Libraries, and then you can directly view photos, play music and watch movies that you share on the USB disks.
Pad	Use a third-party DLNA-supported player.

Customize Your Settings

➤ To Only Share Specific Content

By default, [Share All](#) is enabled so all contents on the USB disk are shared. If you want to only share specific folders, follow the steps below:

1. Visit <http://tplinkwifi.net>, and then log in with the username and password you set for your Touch P5.
2. Go to [Basic](#) > [USB Settings](#) > [Sharing Access](#).
3. Focus on the section of [Folder Sharing](#). Click the button to disable [Share All](#), and then click [Add](#) to add a new sharing folder.

4. Select the **Volume Name** and **Folder Path**, then enter a **Folder Name** as you like.
5. Tick **Enable Media Sharing** and click **OK**.

Note: Touch P5 can share eight volumes at most. You can click  on the page to detach the corresponding volume you do not need to share.

➤ To Specify the Media Server

You can also modify the media server name or disable the feature of Media Sharing as needed.

1. Visit <http://tplinkwifi.net>, and then log in with the password you set for your Touch P5.
2. Select **Basic > USB Settings > Sharing Access**.
3. Enter a **Network/Media Server Name** as you like, such as **MyShare**.

4. Click **Save**.

2.21. IPv6 Connection

If your ISP provides IPv6 connection and has provided some detailed IPv6 parameters, you can configure your Touch P5 to permit IPv6 connection.

1. Visit <http://tplinkwifi.net>, and then log in with the username and password you set for your Touch P5.
2. Go to [Advanced](#) > [IPv6](#) to enable IPv6 connection.

The screenshot shows the 'Internet' configuration section. The 'IPv6:' toggle is currently set to 'Off'. Below it, the 'Internet Connection Type:' dropdown menu is open, showing a list of options: Static IP, Dynamic IP (SLAAC/DHCPv6), PPPoE, 6to4 Tunnel, and Pass-Through (Bridge).

3. Select the Internet connection type provided by ISP. Fill in the information as required and click [Save](#).

Note: If you do not know what your Internet connection type is, contact your ISP or judge according to the information provided by your ISP.

The screenshot shows the 'Internet' configuration section with the 'IPv6:' toggle set to 'On'. The 'Internet Connection Type:' dropdown menu is set to 'PPPoE'. The 'Advanced' options are expanded, showing fields for 'Username:', 'Password:', and 'IPv6 Address:'. At the bottom, there are 'Connect' and 'Disconnect' buttons, and a 'Save' button in the bottom right corner.

- 1) [Static IP](#): Fill in blanks.
 - 2) [Dynamic IP](#): Click [Advanced](#) to have more configuration if ISP requires..
 - 3) [PPPoE](#): Fill in the Username and Password. Click [Advanced](#) to have more configuration if ISP requires.
 - 4) [6to4 Tunnel](#): An IPv4 Internet connection type is a prerequisite for this connection type. Click [Advanced](#) to have more configuration if ISP requires.
 - 5) [Pass-Through \(Bridge\)](#): Skip to Step 5.
4. Configure LAN ports. Windows users are recommended to choose from the first two types. Fill in [Address Prefix](#) provided by ISP, and click [Save](#).

Note: Find Help on the management interface to know more about items.

LAN



Assigned Type: DHCPv6 SLAAC+Stateless DHCP SLAAC+RDNSS

Address Prefix: /64

Address: FE80::20A:EBFF:FE13:102/64

[Save](#)

5. Click [Status](#) on the left to check whether you succeed or not. The following figure is an example of a successful PPPoE configuration.

 Internet  IPv4 | IPv6

MAC Address: 00-0A-EB-AC-25-01

IP Address: 2001:c68:202:2111::120/64

Default Gateway: fe80::edd0:80d2:7f5e:6be7

Primary DNS: 2001:c68:202:2111::1

Secondary DNS: 2001:c68:202:2111::2

Connection Type: PPPoE

2.22. IPTV

If your ISP provides IPTV service and has provided some detailed IPTV parameters, you can configure your Touch P5 to permit IPTV connection.

I want to: Configure IPTV setup to enable Internet /IPTV /Phone service provided by my Internet Service Provider (ISP).

How can I do that?

1. Visit <http://tplinkwifi.net>, and then log in with the username and password you set for your Touch P5.
2. Go to [Advanced](#) > [Network](#) > [IPTV](#).
3. **If your ISP provides the networking service based on IGMP technology**, e.g., British Telecom (BT) and TalkTalk in UK:
 - 1) Select the [IGMP Proxy](#) checkbox and select the [IGMP Version](#), either V2 or V3, according to information provided by your ISP.
 - 2) Click [Save](#).

IGMP Proxy:	<input checked="" type="checkbox"/> Enable
IGMP Version:	V2 ▼

- 3) After configuring IGMP proxy, IPTV can work behind your Touch P5 now. You can connect your set-top box to any of your Touch P5's LAN port.

If IGMP is not the technology your ISP applies to provide IPTV service:

- 1) Select the [Enable IPTV](#) check box.
- 2) Select the appropriate [Mode](#) according to your ISP. Select [Bridge](#) if your ISP is not listed and no other parameters are required, and then skip to Step 4. Select [Custom](#) if your ISP is not listed but provides necessary parameters.

The screenshot shows the 'Settings' page for IPTV configuration. The 'Mode' dropdown menu is open, displaying the following options: Bridge, Russia, Singapore-ExStream, Malaysia-Unifi, Malaysia-Maxis, and Custom. The 'Save' button is located at the bottom right of the settings area.

- 3) After you have selected a mode, the necessary parameters are predetermined. You can perform other configuration, e.g. entering the [IPTV Multicast VLAN ID](#) and selecting the [IPTV Multicast VLAN Priority](#) in [Russia](#) mode according to your ISP.
- 4) For [Russia](#), [Singapore-ExStream](#), [Malaysia-Unifi](#) and [Malaysia-Maxis](#) mode, connect the set-top box to the predetermined LAN port. For [Bridge](#) and [Custom](#) mode, select the [LAN](#) type and connect the set-top box to the corresponding port.
- 5) Click [Save](#).

Done! Your IPTV setup is done now! You may need to configure your set-top box before enjoying your TV.

2.23. NAT Forwarding

Touch P5's NAT (Network Address Translation) feature makes devices in the LAN use the same public IP address to communicate in the Internet, which protects the local network by hiding IP addresses of the devices. However, it also brings about the problem that an external host cannot initiatively communicate with a specified device in the local network.

With the forwarding feature, your Touch P5 can penetrate the isolation of NAT and allow external hosts in the Internet to initiatively communicate with devices in the local network, thus realizing some special functions.

Touch P5 includes four forwarding rules. If two or more rules are set, the priority of implementation from high to low is Virtual Servers, Port Triggering, UPNP and DMZ.

This section contains the following sections:

- [Share Local Resources in the Internet by Virtual Server](#)
- [Open Ports Dynamically by Port Triggering](#)
- [Make Applications Free from Port Restriction by DMZ](#)
- [Make Xbox Online Games Run Smoothly by UPnP](#)

2.23.1. Share Local Resources in the Internet by Virtual Server

When you build up a server in the local network and want to share it on the Internet, Virtual Server can realize the service and provide it to the Internet users. At the same time Virtual Server can keep the local network safe as other services are still invisible from the Internet.

Virtual Server can be used for setting up public services in your local network, such as HTTP, FTP, DNS, POP3/SMTP and Telnet. Different services applies different service ports. Port 80 is used for HTTP service, port 21 for FTP service, port 25 for SMTP service and port 110 for POP3 service. Please verify the service port number before the configuration.

I want to: Share my personal website I've built in local network with my friends through the Internet.

For example: The personal website has been built in my home computer (192.168.0.100). I hope that my friends in the Internet can visit my website in some way. The computer is connected to your Touch P5 with the WAN IP address 218.18.232.154.

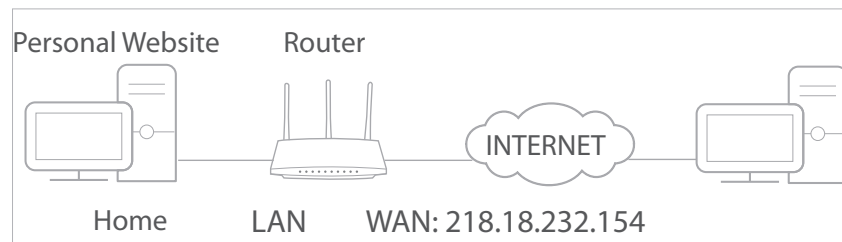

How can I do that?

1. Assign a static IP address to your computer, for example 192.168.0.100.
2. Visit <http://tplinkwifi.net>, and log in with the username and password you set for your Touch P5.
3. Go to **Advanced > NAT Forwarding > Virtual Servers**, and click **Add**.
4. Click **View Existing Services**, and select your **Service Type** (in this case: **HTTP**). The **External Port**, **Internal Port** and **Protocol** will be automatically filled in. Enter the computer's IP address 192.168.0.100 in the **Internal IP** field.
5. Click **OK**.

Virtual Servers

+ Add - Delete

<input type="checkbox"/>	ID	Service Type	External Port	Internal IP	Internal Port	Protocol	Status	Modify
--	--	--	--	--	--	--	--	--

Service Type: HTTP [View Existing Services](#)

External Port: 80 (XX-XX or XX)

Internal IP: 192.168.0.100

Internal Port: 80 (XX or Blank ,1-65535)

Protocol: TCP

Enable This Entry

Cancel OK

Note:

1. It is recommended to keep the default settings of **Internal Port** and **Protocol** if you are not clear about which port and protocol to use.
2. If the service you want to use is not in the list of **Service Type**, you can enter the corresponding parameters manually. You should verify the service port number.
3. You can add multiple virtual server rules if you want to provide several services in your Touch P5. Please note that the **External Port** cannot be overlapped.

Done!

Users in the Internet can enter **Service Type://WAN IP** to visit your local resources (in this case, enter `http://218.18.232.154` to visit your personal website).

Note:

1. The WAN IP should be a public IP address. For the WAN IP is assigned dynamically by ISP, it is recommended to apply and register a domain name for the WAN by DDNS. Then you can use **Service Type://Domain Name** to visit your local resources.
2. If you have changed the default External Port, you should use **Service Type://WAN IP:External Port** or **Service Type://Domain Name:External Port** to visit your local resources.

2.23.2. Open Ports Dynamically by Port Triggering

Port Triggering can specify a triggering port and its corresponding external ports. When a host in the local network initiates a connection to the triggering port, all the external ports will be opened for subsequent connections. Your Touch P5 can record the IP address of the host. When the data from the Internet return to the external ports, your Touch P5 can forward them to the corresponding host. Port Triggering is mainly applied to online games, VoIPs and video players. Common applications include MSN Gaming Zone, Dialpad, Quick Time 4 players, etc.

Follow the steps below to configure the port triggering rules:

1. Visit <http://tplinkwifi.net>, and log in with the username and password you set for your Touch P5.
2. Go to [Advanced](#) > [NAT Forwarding](#) > [Port Triggering](#) and click [Add](#).
3. Click [View Existing Applications](#), and select the desired [Application](#). The [External Port](#), [Internal Port](#) and [Protocol](#) will be automatically filled in. The following picture takes application [MSN Gaming Zone](#) as an example.
4. Click [OK](#).

Port Triggering

[+ Add](#) [- Delete](#)

<input type="checkbox"/>	ID	Application	Triggering Port	Triggering Protocol	External Port	External Protocol	Status	Modify
--	--	--	--	--	--	--	--	--

Application: [View Existing Applications](#)

Triggering Port: (XX,1-65535)

Triggering Protocol: ▼

External Port: (XX or XX-XX,1-65535,at most 5 pairs)

External Protocol: ▼

Enable This Entry

[Cancel](#) [OK](#)

Note:

1. You can add multiple port triggering rules as needed.
2. If the application you want to use is not in the list of [Existing Applications](#), you can enter the corresponding parameters manually. You should verify the ports number that the application needs.

2.23.3. Make Applications Free from Port Restriction by DMZ

When a computer is set as a DMZ (Demilitarized Zone) host in the local network, it is totally exposed to the Internet, which can realize the unlimited bidirectional communication between internal and external hosts. The DMZ host becomes a virtual server with all ports open. When you are not clear about which ports to open in some special applications, like IP camera and database software, you can set the computer to be a DMZ host.

Note: DMZ is more applicable in the situation that users are not clear about which ports to open. When it is enabled, the DMZ host is totally exposed to the Internet, which may bring some potential safety hazard. If DMZ is not in use, please disable it in time.

I want to: Make the home computer join the Internet online game without port restriction.

For example: Due to some port restriction, when playing online games, you can login normally but cannot join a team with other players. To solve this problem, set your computer as a DMZ with all ports open.

1. Assign a static IP address to your computer, for example 192.168.0.100.
2. Visit <http://tplinkwifi.net>, and log in with the username and password you set for your Touch P5.
3. Go to [Advanced](#) > [NAT Forwarding](#) > [DMZ](#) and select the checkbox to enable DMZ.

4. Enter the IP address 192.168.0.100 in the [DMZ Host IP Address](#) field.
5. Click [Save](#).

Done! The configuration is completed. You've set your computer as a DMZ host and now you can make a team to game with other players.

2. 23. 4. Make Xbox Online Games Run Smoothly by UPnP

The UPnP (Universal Plug and Play) protocol allows applications or host devices to automatically find the front-end NAT device and send request to it to open the corresponding ports. With UPnP enabled, applications or host devices in both sides of NAT device can freely communicate with each other, thus realizing the seamless connection of the network. You may need to enable the UPnP if you want to use applications for multiplayer gaming, peer-to-peer connections, real-time communication (such as VoIP or telephone conference), remote assistance, etc.

Note:

1. Only application supporting the UPnP protocol can use this feature.
2. The UPnP feature needs the support of operating system (e.g. Windows Vista/ Windows 7/ Windows 8, etc. Some operating systems need to install the UPnP components).

For example: When you connect your Xbox to your Touch P5 which is connected to the Internet for online games, UPnP will send request to your Touch P5 to open the corresponding ports allowing the following data penetrating the NAT to transmit. Therefore, you can play Xbox online games without a hitch.

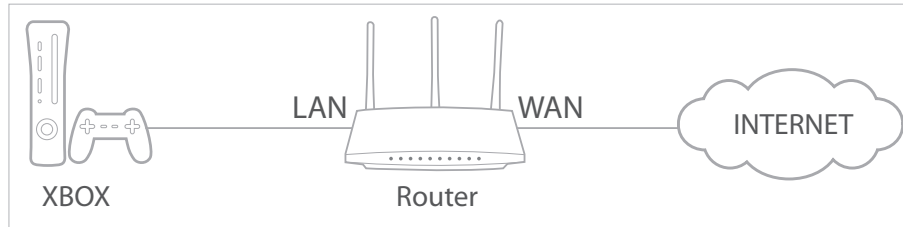

If necessary, you can follow the steps to change the status of UPnP.

1. Visit <http://tplinkwifi.net>, and log in with the username and password you set for your Touch P5.
2. Go to **Advanced** > **NAT Forwarding** > **UPnP** and toggle on or off as needed.

UPnP

UPnP: On

UPnP Service List

Client Number: 0 [Refresh](#)

ID	Service Description	External Port	Protocol	Internal IP Address	Internal Port
--	--	--	--	--	--

2. 24. Firmware Upgrade

TP-LINK is dedicated to improving and enriching the product features, giving you a better network experience. We will release the latest firmware at TP-LINK official website, and you can download the latest firmware file from our website and upgrade the firmware to the latest version.

1. Download the latest firmware file from our website [TP-LINK Support](#).
2. Visit <http://tplinkwifi.net>, and then log in with the username and password you set for your Touch P5.
3. Go to **Advanced** > **System Tools** > **Firmware Upgrade**.
4. Click **Browse** to locate the downloaded new firmware file, and click **Upgrade**.

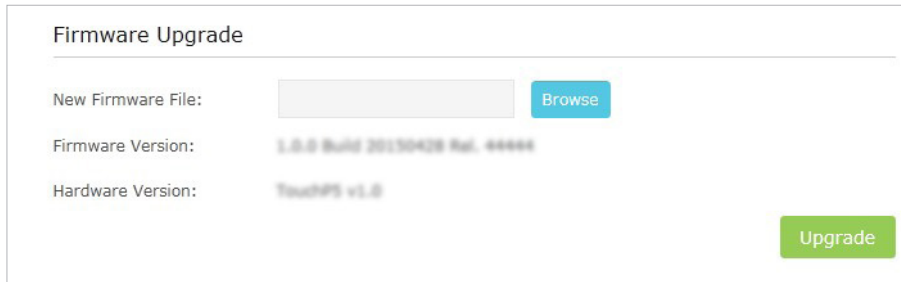

Firmware Upgrade

New Firmware File: [Browse](#)

Firmware Version: 1.0.0 Build 20130428 Rel. 44444

Hardware Version: TouchP5 v1.0

[Upgrade](#)

5. Wait a few minutes for the upgrading and rebooting.

Note:

1. Before upgrading the firmware, it's better to back up your current settings.
2. During the upgrading process, do **NOT** turn off or reset your Touch P5.
3. The upgraded firmware version must correspond to the hardware.

2.25. FAQ

Q1. What can I do if I cannot access the Internet?

1. Check if the Internet is working properly by connecting a computer directly to the modem via an Ethernet cable. If not, contact your Internet Service Provider.
2. Tap [Quick Setup](#) on the menu screen to run the setup again.
3. Tap [Reboot & Reset](#) on the menu screen, select [Reboot](#) to reboot your Touch P5 and try again.
4. If your Internet Connection Type is [Dynamic IP](#), go through [Quick Setup](#) and enter the MAC address that is registered with your ISP. Then reboot both the modem and your Touch P5.

Q2. What can I do if I forgot my wireless network password?

Tap [Wireless Settings](#) on the menu screen to obtain the security password, both for the 2.4GHz and 5GHz wireless networks.

For the Guest network, the password displays on the home screen.

Q3. How do I restore my Touch P5 to its factory default settings?

1. Tap [Reboot & Reset](#) on the menu screen, and then tap [Reset](#).
2. With your Touch P5 powered on, press and hold the [Reset](#) button on the back panel until the Touch P5 logo displays.

Note: Once your Touch P5 is reset, all the settings will be lost and you will need to re-configure your Touch P5.

Q4. What can I do if I forgot my administrator password?

With your Touch P5 powered on, press and hold the [Reset](#) button on the back panel until the Touch P5 logo displays to restore your Touch P5 to its factory default settings, and create a new administrator password.

Q5. What can I do if I forgot my account for web management page?

1. The default username and password of the web management page are [admin](#) (in lower case).
2. The web management page and touchscreen share the same password. Please try the administrator password of the touchscreen.
3. Restore your Touch P5 to its factory default settings: with your Touch P5 powered on, press and hold the [Reset](#) button on the back panel until the Touch P5 logo displays.

Q6. What can I do if I cannot log into my Touch P5's web management page?

1. Make sure your computer is connected to the Touch P5.
2. Make sure your computer is configured as [Obtain an IP address automatically](#) and [Obtain DNS server address automatically](#).
3. Make sure you have correctly input <http://tplinkwifi.net> or [192.168.0.1](#) in a web browser.
4. Check your computer's settings:
 - 1) Go to [Start](#) > [Control Panel](#) > [Network and Internet](#), and click [View network status and tasks](#);
 - 2) Click [Internet Options](#) on the bottom left;
 - 3) Click [Connections](#) and select [Never dial a connection](#);

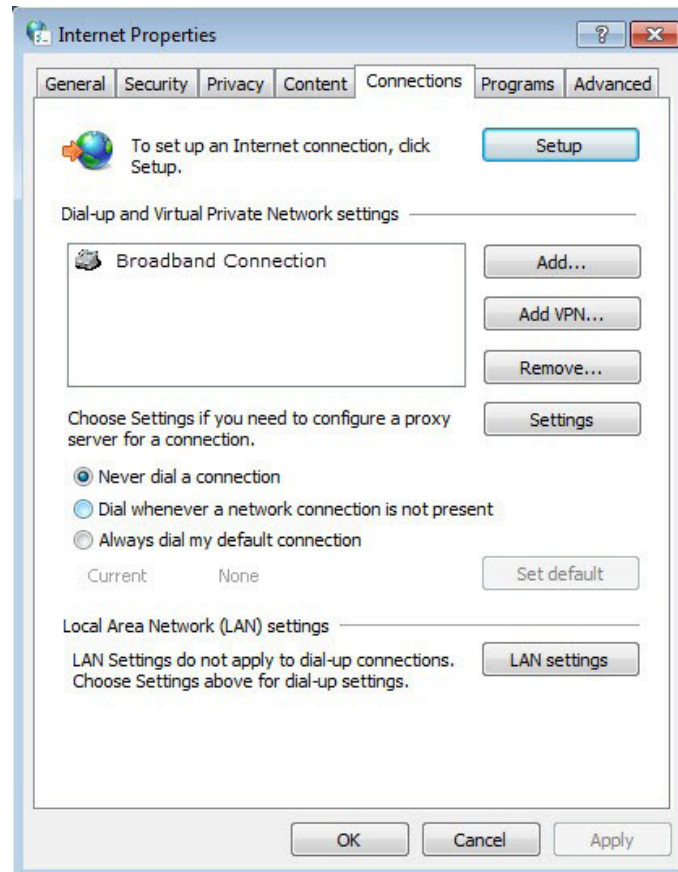

- 4) Click **LAN settings**, deselect the following three options and click **OK**;



- 5) Go to **Advanced > Restore advanced settings**, and click **OK**.

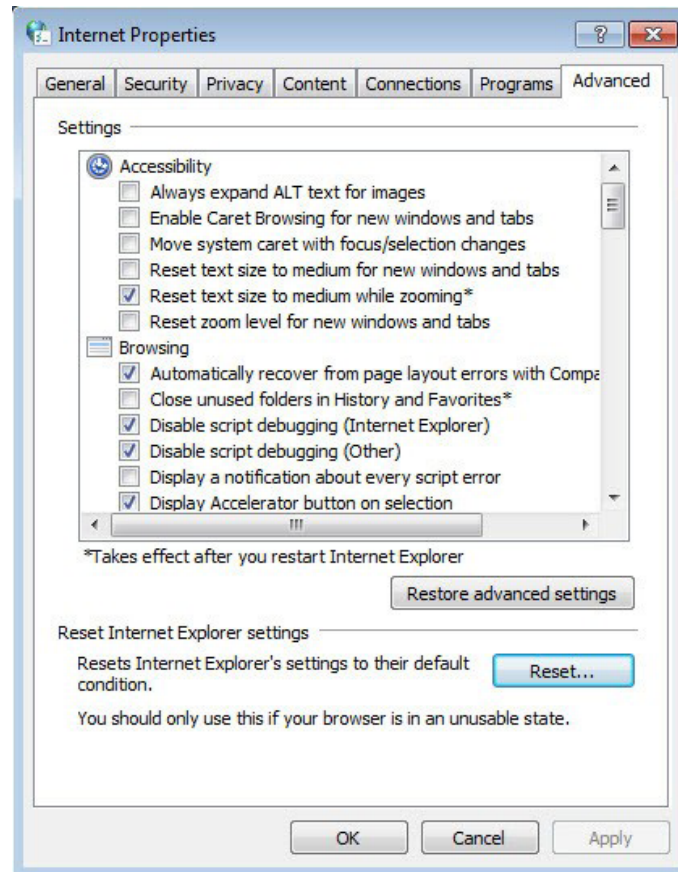

5. Use another a web browser or computer and login again.
6. Reset your Touch P5 to its factory default settings: with your Touch P5 powered on, press and hold the [Reset](#) button on the back panel until the Touch P5 logo displays.
 - **Note:** You'll need to reconfigure your Touch P5 to surf the Internet once your Touch P5 is reset.

If this doesn't solve the problem, please contact the technical support.

Q7. What can I do if I cannot find my wireless network or I cannot connect to the wireless network?

1. If you fail to find any wireless network, please follow the steps below:
 - 1) Make sure the wireless function is enabled if you're using a laptop with a built-in wireless adapter. You can refer to the relevant document or contact the laptop manufacturer.
 - 2) Make sure the wireless adapter driver is installed successfully and the wireless adapter is enabled.

On Windows 7

- a. If you see the message [No connections are available](#), it is usually because the wireless function is disabled or blocked somehow;
- b. Click [Troubleshoot](#) and Windows might fix the problem itself.

On Windows XP

- a. If you see the message [Windows cannot configure this wireless connection](#), this is usually because windows configuration utility is disabled or you are running another wireless configuration tool to connect the wireless;
 - b. Exit the wireless configuration tool(the TP-LINK Utility, for example);
 - c. Select and right click [My Computer](#) on desktop, and select [Manage](#) to open Computer Management window;
 - d. Expand [Services and Applications](#) > [Services](#), and find and locate [Wireless Zero Configuration](#) in the Services list on the right side;
 - e. Select and right click [Wireless Zero Configuration](#), and then select [Properties](#);
 - f. Change [Startup type](#) to [Automatic](#), click [Start](#) and make sure the [Service status](#) is [Started](#). And then click [OK](#);
 - g. Try to connect to the wireless network.
2. If you can find other wireless networks except your own, please follow the steps below:
- 1) Make sure your computer/device is still in the range of your Touch P5/modem. Move it closer if it is currently too far away;
 - 2) Tap the [Wireless Settings](#) icon to start it, and be sure the wireless function is enabled. Double check your Network Name, and make sure the SSID is not hidden.

Chapter 3

Configure Touch P5 as a Repeater

This chapter introduces how to connect and configure your Touch P5 in [repeater mode](#) which will extend the existing wireless coverage by repeating the wireless signal. We recommend that you use repeater mode when you want a larger wireless coverage to eliminate “dead zones”. You can also use Touch P5 as an adapter to connect any Ethernet-enabled device (such as a Blu-ray player, game console, DVR, or smart TV) to your Wi-Fi network.

This chapter includes the following sections:

- [Quick Setup](#)
- [Entertainment Adapter](#)
- [Mode Selection](#)
- [Wireless Settings](#)
- [Devices Control](#)
- [LAN](#)
- [DHCP Server](#)
- [Screen Settings](#)
- [Reboot & Reset](#)
- [Administrator Password](#)
- [About](#)
- [FAQ](#)

3.1. Quick Setup

Touch P5 supports two configuration methods: [Web-based utility](#) and [Touchscreen utility](#). [Web-based utility](#) includes the configuration for all functions, and it requires a connection (wired or wireless) between your Touch P5 and the device you are using to log into the web management page. [Touchscreen utility](#) supports configuration for most commonly used functions, and the configuration can be easily done within a few taps on the touchscreen.

In this chapter, we will introduce most of the configuration through the touchscreen utility.

3.1.1. Option 1: Through Touchscreen Utility (Recommended)

The Quick Setup app on the touchscreen will guide you through the process to connect your Touch P5 to the host network and set up its extended network.



1. Install the antennas and position them vertically.
2. Plug your Touch P5's power adapter into an electrical outlet [near](#) your host router. Turn it on and wait until the system boot on the screen completes.
3. On the menu screen, tap the [Mode Selection](#) icon to start it.
4. Select [Repeater](#) mode and tap [Save](#).

Note: Your Touch P5 will reboot to make your changes take effect, and please do **NOT** operate during the process.

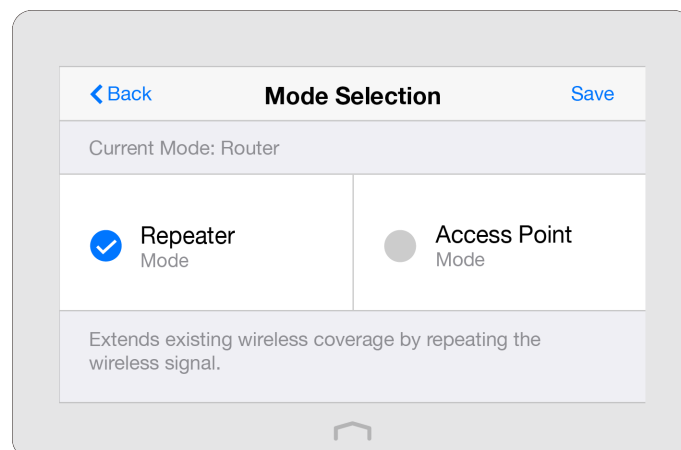

5. Go to the menu screen and tap the **Quick Setup** icon to start it.
6. Follow the onscreen instructions to complete the configuration.
7. Once the configuration is completed, please follow the instructions below to relocate your Touch P5. The location you choose must be within the range of the host network.
 - **Halfway Between** - Generally, the ideal location for your Touch P5 is halfway between the host router and wireless client. If the wireless signal is not satisfactory, you can place your Touch P5 somewhat closer to the host router.

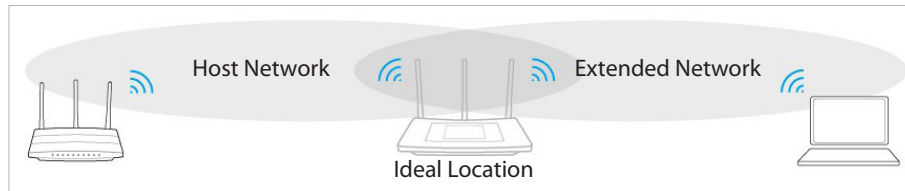

- **No Obstacles and Spacious** - Clear obstacles in the way between your Touch P5 and the host router. It's better to locate it in a spacious place, such as in a corridor.
 - **No Interference** - Choose a location away from Bluetooth devices and other household electronics, such as a cordless phone, microwave, and baby monitor, etc., to minimize signal interference.
8. Connect your wireless clients to the network of your Touch P5.

Note: The extended networks of Touch P5 share the same passwords as those of the host networks, but may have different wireless network names if you have customized them during the configuration. Please connect your wireless devices to one extended network of your Touch P5.

3.1.2. Option 2: Through Web-based Utility

The web-based utility can be used on any Windows, Macintosh or UNIX OS with a web browser, such as Microsoft Internet Explorer, Mozilla Firefox or Apple Safari. Follow the steps below to log into your Touch P5.



1. Install the antennas and position them vertically.
2. Plug your Touch P5's power adapter into an electrical outlet **near** your host router. Turn it on and wait until the system boot on the screen completes.

3. Connect your computer to the Ethernet port on your Touch P5 via an Ethernet cable, or wirelessly connect to your Touch P5 using the default SSID (Wireless Network Name) and Wireless Password printed on the label at the bottom of your Touch P5.

Note: If the TCP/IP Protocol on your computer is set to the static (fixed) IP address, you need to change it to obtain an IP address automatically.

4. Launch a web browser, visit <http://tplinkwifi.net> and log in with the default username and password ([admin/admin](#)).
5. Click the [Mode](#) button in the upper-right corner of the title bar, select [Repeater](#) and click [Save](#).

Note: Your Touch P5 will reboot to make your changes take effect, and please do **NOT** operate during the process.

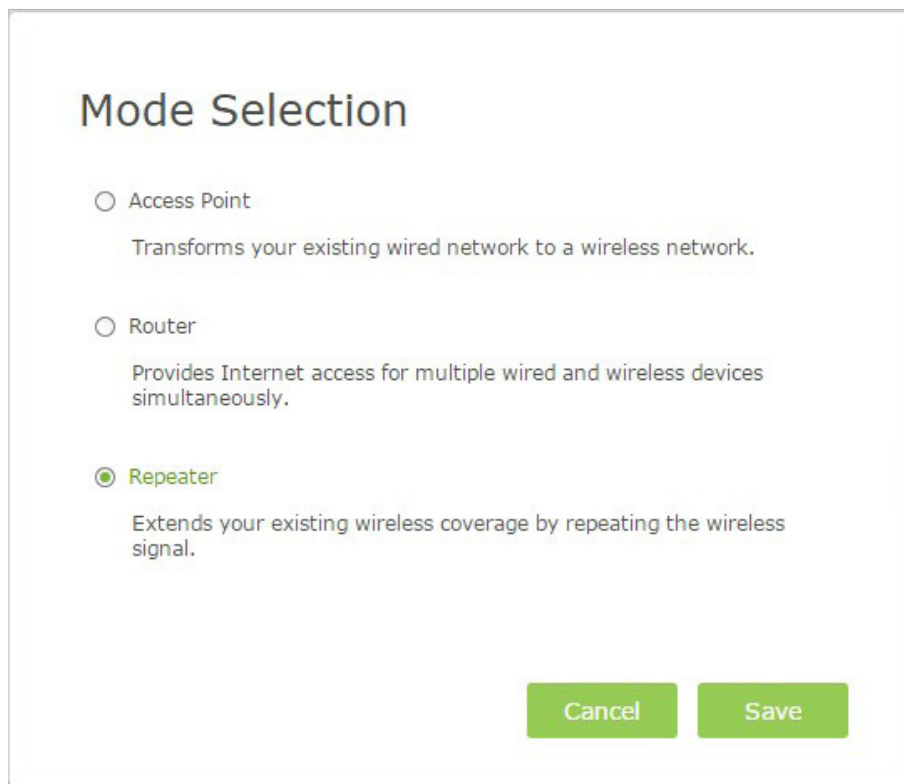

Mode Selection

Access Point
Transforms your existing wired network to a wireless network.

Router
Provides Internet access for multiple wired and wireless devices simultaneously.

Repeater
Extends your existing wireless coverage by repeating the wireless signal.

[Cancel](#) [Save](#)

6. Re-login and follow the Quick Setup instructions to complete the configuration.
7. Once the configuration is completed, please follow the instructions below to relocate your Touch P5. The location you choose must be within the range of the host network.
 - [Halfway Between](#) - Generally, the ideal location for your Touch P5 is halfway between the host router and wireless client. If the wireless signal is not satisfactory, you can place your Touch P5 somewhat nearer to the host router.



- **No Obstacles and Spacious** - Clear obstacles in the way between your Touch P5 and the host router. It's better to locate it in a spacious place, such as in a corridor.
- **No Interference** - Choose a location away from Bluetooth devices and other household electronics, such as a cordless phone, microwave, and baby monitor, etc., to minimize signal interference.

8. Connect your wireless clients to the network of your Touch P5.

Note: The extended networks of Touch P5 share the same passwords as those of the host networks, but may have different wireless network names if you have customized them during the configuration. Please connect your wireless devices to one extended network of your Touch P5.

3.2. Entertainment Adapter

Your Touch P5 can be used as a wireless network adapter to connect any Ethernet-only device (such as a Blu-ray player, game console, DVR, or smart TV) to the wireless network. After your Touch P5 is connected to the host router, you can connect an Ethernet-enabled device to your Touch P5's Ethernet port via an Ethernet cable. Then the devices can connect to the wireless network of the host router.

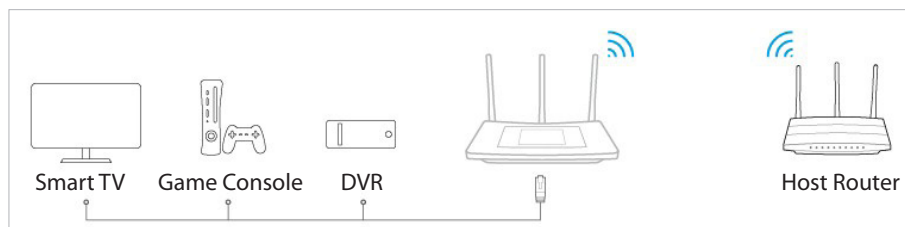

If both 2.4GHz and 5GHz wireless bands of your Touch P5 are connected to the host router, the 5GHz band is used for transmitting data between the host network and the wired connected devices by default. If you want to change the default setting, please follow the steps below:

1. Launch a web browser on your computer, visit <http://tplinkwifi.net> and log in with the default username and password ([admin/admin](#)).
2. Go to [Settings > Network](#), and focus on the [Ethernet Port](#) section.

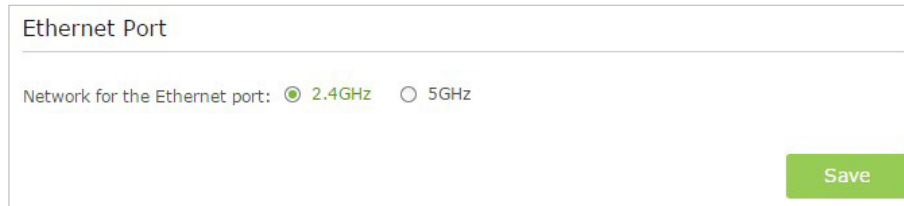

Ethernet Port

Network for the Ethernet port: 2.4GHz 5GHz

Save

3. Select 2.4GHz or 5GHz band and click [Save](#).

3.3. Mode Selection

The Mode Selection app helps you easily switch your Touch P5 to a router, repeater or an access point.

- **Router Mode (Default):** Touch P5 provides Internet access for multiple wired and wireless devices simultaneously.
- **Repeater Mode:** Touch P5 extends your existing wireless coverage by repeating the wireless signal.
- **Access Point Mode:** Touch P5 transforms your existing wired network to a wireless network.

1. On the menu screen, tap the [Mode Selection](#) icon to start it.
2. Select your desired mode, and tap [Save](#).

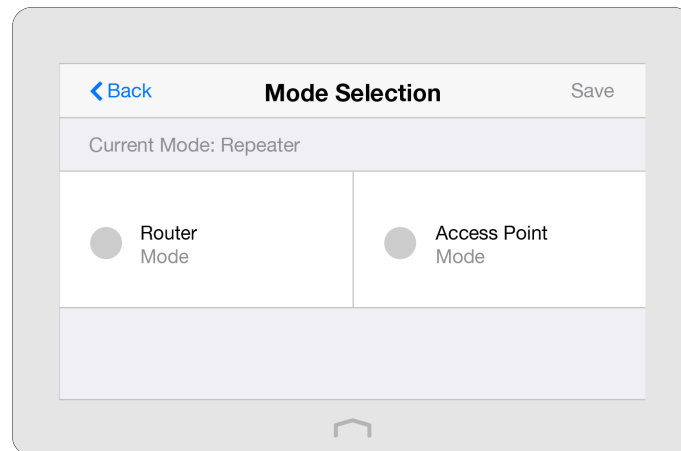

Note: Your Touch P5 will reboot to make your changes take effect, and please do **NOT** operate during the process.

3.4. Wireless Settings

The Wireless Settings app helps you configure the wireless settings of your host and extended networks as needed.

1. On the menu screen, tap the [Wireless Settings](#) icon to start it.
2. Configure the wireless settings as needed.

➤ **To set the host network connection of your Touch P5:**

- 1) Select [Host Network](#).

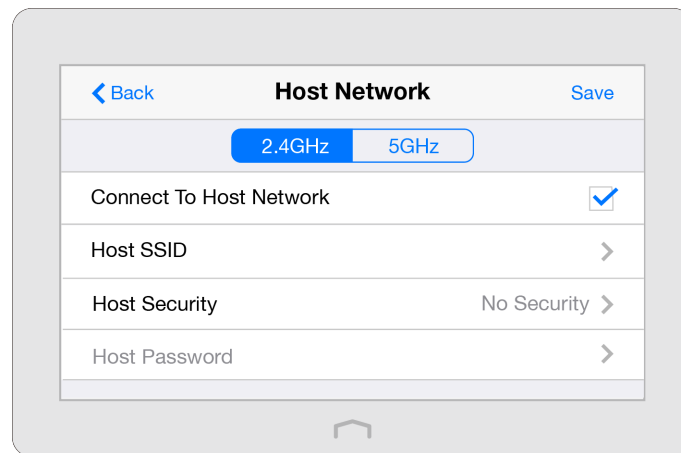

- 2) Select the [Connect To Host Network](#) checkbox.
- 3) Tap [Host SSID](#) to scan for the host network you want to extend.

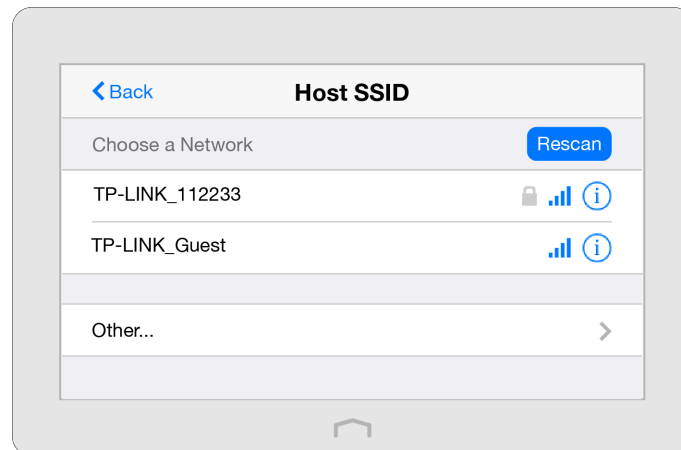

- 4) Select the SSID of your host network from the list.

Note: If the host network you want to extend is on but not shown in the list, please move your Touch P5 closer to your host router and tap [Rescan](#). Or, select [Other...](#) to enter the SSID manually.

- 5) Once a network is selected, the SSID and security settings of that network will automatically be filled in. Tap [Host Password](#) to enter the password of the host network in corresponding encryption.

Note: If the host network security is WEP, tap [Index](#) to select index same as host network.

6) Tap [Save](#).

➤ **To configure the extended network of your Touch P5:**

Select [Extended Network](#) on the home page of [Wireless Settings](#).

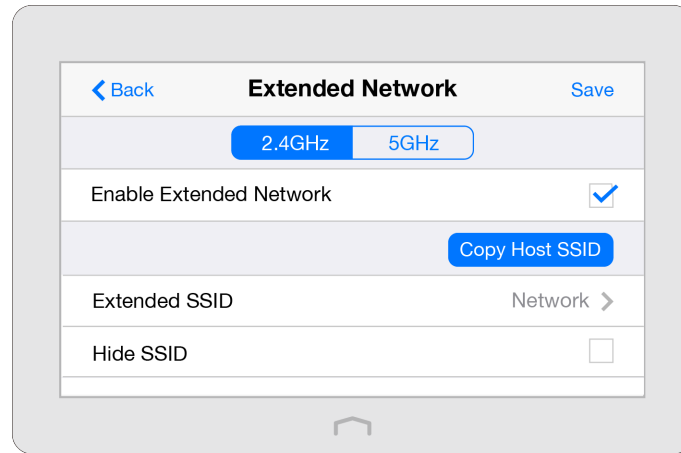

- **Enable Extended Network:** Enable or disable the 2.4GHz/5GHz extended network.
- **Extended SSID:** Either tap [Copy Host SSID](#) to copy the host router's SSID or create a new name using up to 32 characters. This field is case-sensitive.
- **Hide SSID:** Select this checkbox if you want to hide your Touch P5's SSID from the Wi-Fi network list, and you have to manually join the network.
- **Extended Password:** The password of the extended network is the same as that of the host network.

3.5. Devices Control

The Devices Control app helps to view the client information and block unauthorized users (wired or wireless) from connecting to your Touch P5.

I want to: Block some specific client devices from connecting to my Touch P5.

How can I do that? 1. On the menu screen, tap the [Devices Control](#) icon to start it. Toggle the button to enable [Devices Control](#).

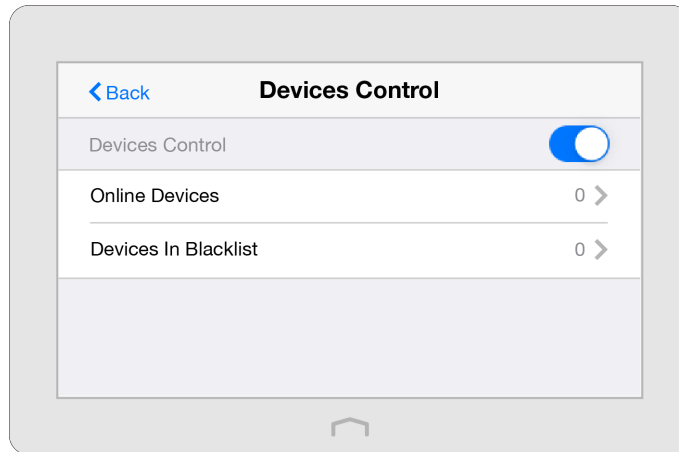

2. Tap **Online Devices** to view the connected clients.

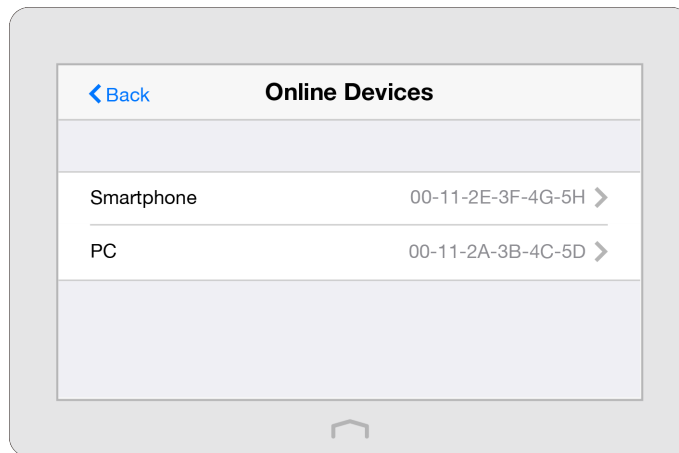

3. Select the device(s) to be blocked and tap **Block**.

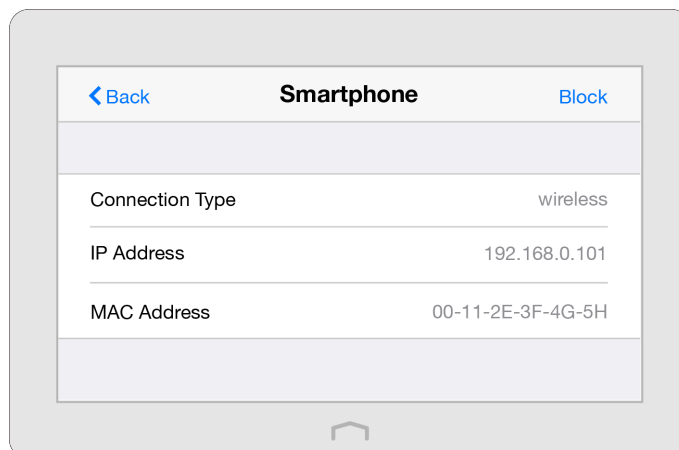

4. The blocked device(s) will be added to **Devices in Blacklist**.

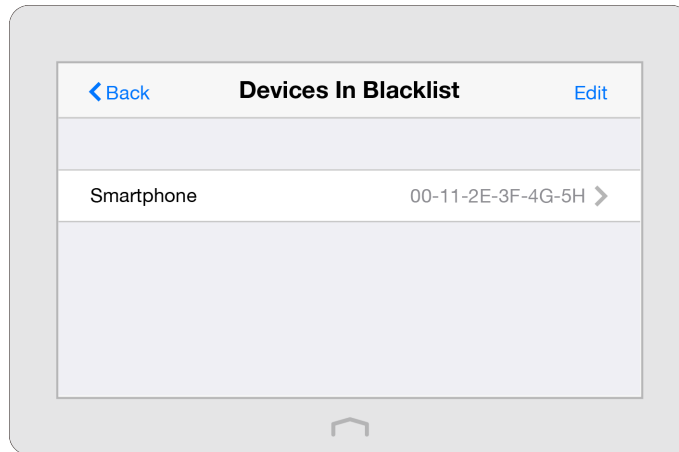

Note: If you want to add a device manually or delete a blocked device, tap [Edit](#) on the [Devices In Blacklist](#) page to set up according to your needs.

Done! Now devices in the blacklist cannot connect to your Touch P5.

3.6. LAN

By default, your Touch P5 is set to obtain an IP address automatically from the host router. The LAN app allows you to use a specific IP address appropriate to your network demand.

Note: We do **NOT** recommend you change the IP address unless you are quite sure about the IP setting for special network demand. Random changes may lead to Internet disconnection.

1. On the menu screen, tap the [LAN](#) icon to start it.

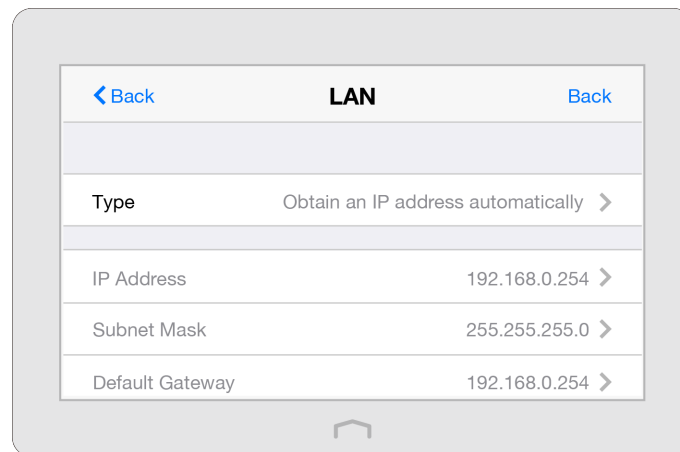

2. Tap [Type](#) to select [Use the following IP address](#) and tap [Done](#).
3. Tap [IP Address](#) to enter an IP address in dotted decimal notation. It should be in the same subnet as the host network.
4. Tap [Subnet Mask](#) to enter the subnet mask in dotted decimal notation. It determines the network portion and host portion of the IP address.

5. Tap **Default Gateway** to enter the gateway in dotted decimal notation . It should be in the same subnet as the IP address.
6. Tap **Save**.

3.7. DHCP Server

The DHCP Server app can configure your Touch P5 to act as a DHCP (Dynamic Host Configuration Protocol) server to assign IP addresses to its clients and view client information from the client list. To use the DHCP server function of your Touch P5, you must configure all computers on the LAN as **Obtain an IP Address automatically**. You can also manually reserve an IP address for a client that is connected to your Touch P5. Once reserved, the IP address will only be assigned to the client by the DHCP server.

1. On the menu screen, tap the **DHCP Server** icon to start it.

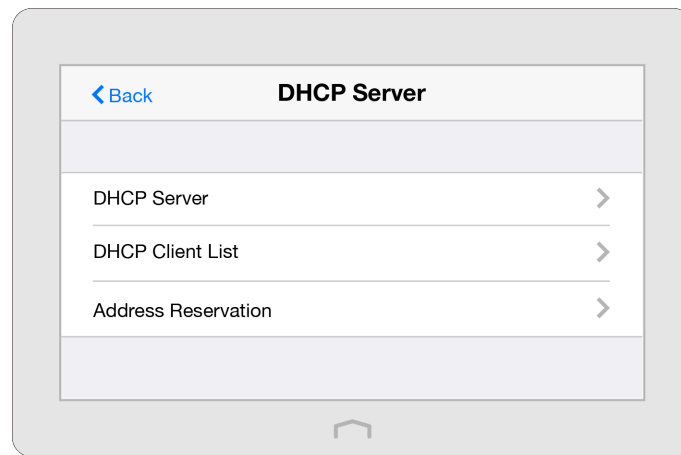

2. Configure the DHCP settings as needed.

➤ **To set DHCP server of your Touch P5:**

- 1) Select **DHCP Server**.

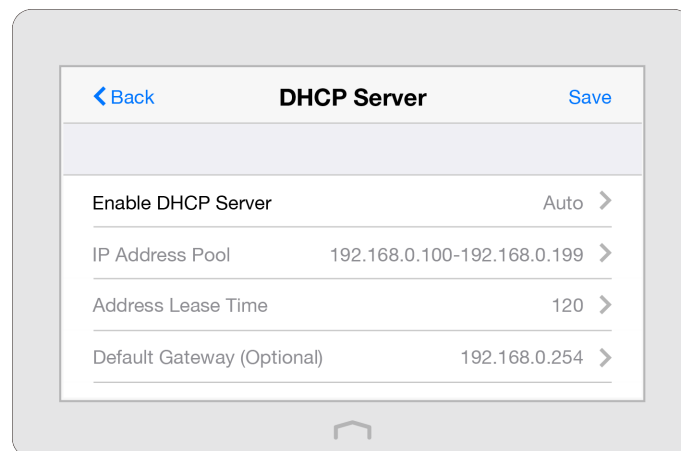

2) The **Enable DHCP Server** is set to be **Auto** by default and the function will automatically turn on or off to assign valid IP addresses to client devices according to the DHCP server settings of the host network.

If you select **On**, please configure it manually.

- **IP Address Pool:** The start and end addresses must be on the same subnet with the LAN IP. Your Touch P5 will assign addresses within this specified range to its clients. It is from 192.168.0.100 to 192.168.0.199 by default.
- **Address Lease Time:** The amount of time in which a DHCP client can lease its current dynamic IP address assigned by your Touch P5. After the dynamic IP address expires, the client will be automatically assigned a new dynamic IP address.
- **Default Gateway (Optional):** Enter the LAN IP address of your Touch P5.
- **Primary/Secondary DNS (Optional):** Enter this parameters as provided by your ISP.

If you select **Off**, please make sure the DHCP server of your host network is on. Otherwise, you have to configure the IP address for each client manually.

3) Tap **Save**.

➤ **To view the client information:**

1) Select **DHCP Client List**.

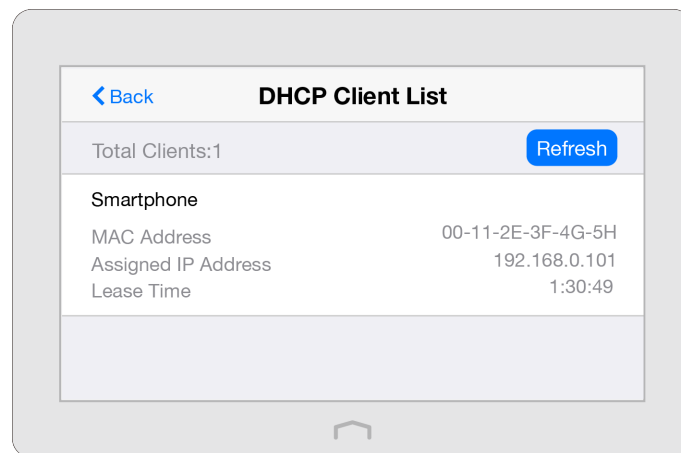

2) You can view the information of connected clients.

➤ **To reserve an IP address for a specified client device:**

1) Select **Address Reservation** and tap **Add** to add an address reservation entry for your device.

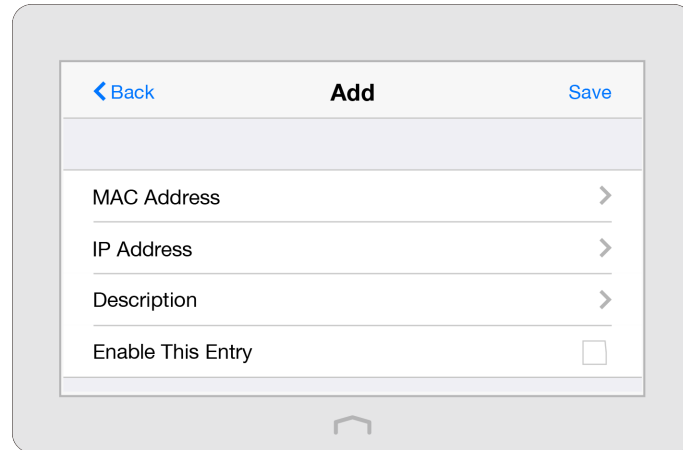

- 2) Enter the [MAC Address](#) of the device for which you want to reserve an IP address.
- 3) Specify the [IP Address](#) which will be reserved for the device.
- 4) Enter the [Description](#) for the device.
- 5) Check the [Enable This Entry](#) box and tap [Save](#) to make the settings effective (shown as below).

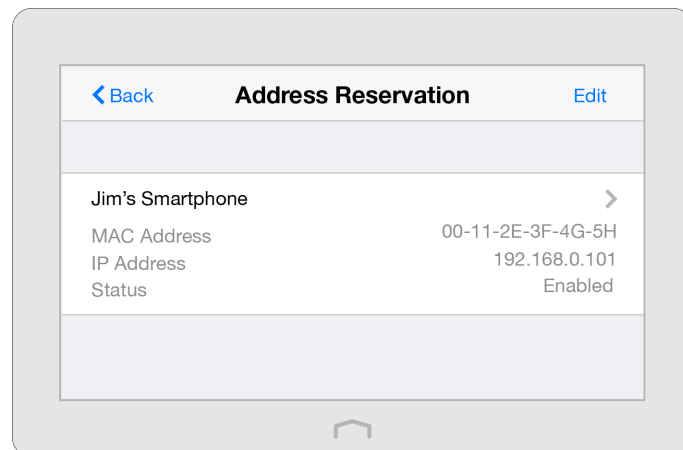

Note: If you want to modify a reserved address, tap the reserved address to modify it. If you want to add or delete a reserved address, tap [Edit](#) to set up as needed.

3.8. Screen Settings

The Screen Settings app helps to set the brightness and screen saver of your Touch P5.

1. On the menu screen, tap the **Screen Settings** icon to start it.

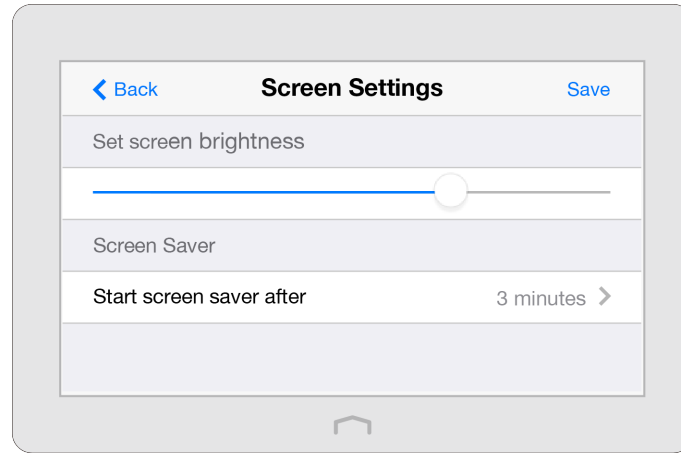

2. Drag the scroll bar to set the brightness of the screen.
3. By default, the screen saver will start if the screen is idle for 3 minutes. You can change the wait time.

Note: If you select **Never**, the screen will stay on and never go to sleep and this will decrease the life span of the screen.

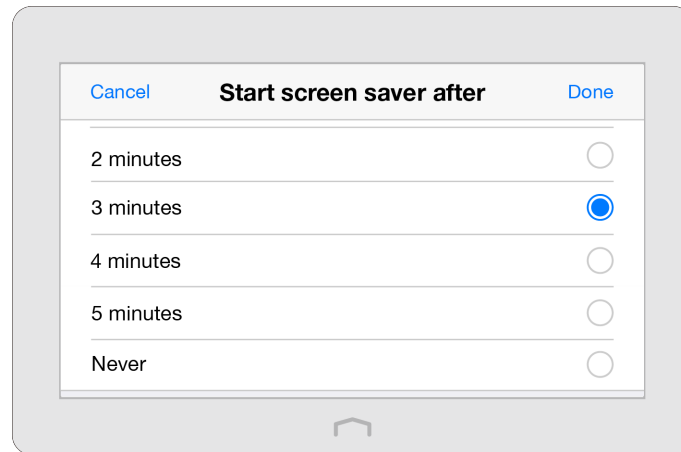

3.9. Reboot & Reset

With the Reboot & Reset app, you can restart your Touch P5 or reset it to its factory default settings.

1. On the menu screen, tap the [Reboot & Reset](#) icon to start it.

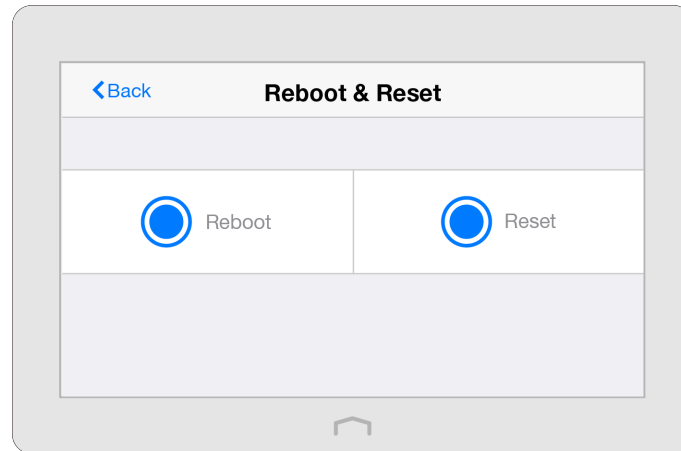

2. **Reboot:** Your Touch P5 will shut down and boot again.

Reset: To reset your Touch P5 to its factory default settings and all the settings you have configured will be erased.

■ **Note:** Please do **NOT** power off your Touch P5 during the rebooting or resetting process.

3.10. Administrator Password

Administrator password is used to log in to the touchscreen page and web management page of your Touch P5. You are required to set a new administrator password at your first login. You can also change it with the Administrator Password app.

1. On the menu screen, tap the [Administrator Password](#) icon to start it.

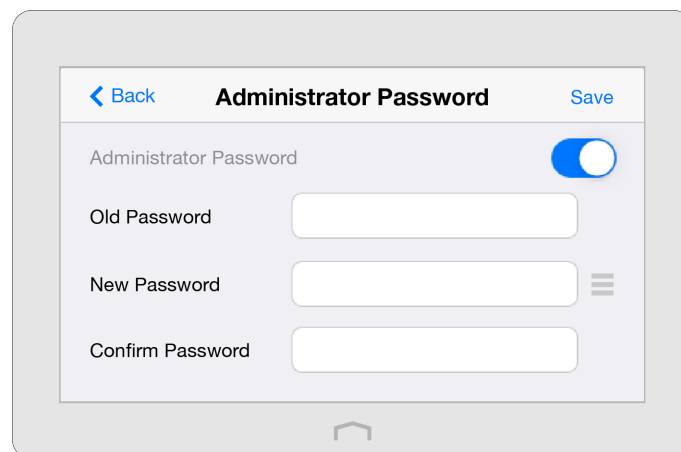

2. Enter the old password. Enter the new password and enter again to confirm.

3. Tap **Save**.

■ Note:

1. If you disable this function, your touchscreen will under no protection and anyone can change the settings of your Touch P5. But logging into the web management page still requires the password.
2. If you change the administrator password on the screen, logging into the web management page also requires the new password.

3.11. About

The About app displays the product model and hardware and firmware information of your Touch P5.

On the menu screen, tap the **About** icon to start it.

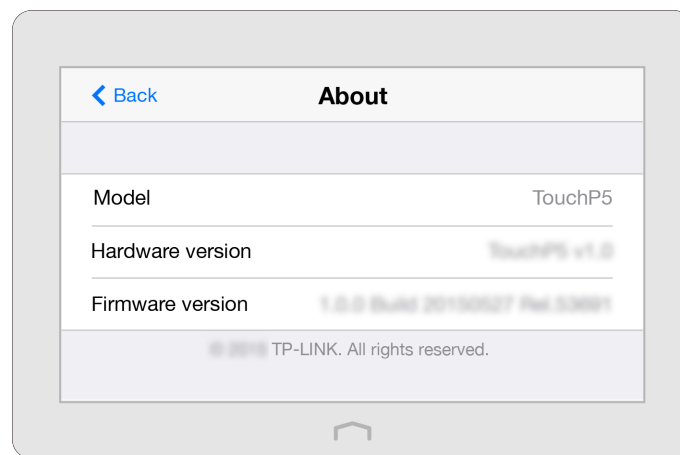

3.12. FAQ

Q1. What can I do if I forgot my wireless network password?

The password of the extended network is the same as that of your host network.

Q2. How do I restore my Touch P5 to its factory default settings?

1. Tap **Reboot & Reset** on the menu screen, and then tap **Reset**.
2. With your Touch P5 powered on, press and hold the **Reset** button on the back panel until the Touch P5 logo displays.

■ Note: Once your Touch P5 is reset, all the settings will be lost and you will need to re-configure your Touch P5.

Q3. What can I do if I forgot my administrator password?

With your Touch P5 powered on, press and hold the **Reset** button on the back panel until the Touch P5 logo displays to restore your Touch P5 to its factory default settings, and create a new administrator password.

Q4. What can I do if I cannot access the Internet?

1. Check if the Internet is working properly by connecting to your host network. If not, contact your Internet Service Provider.
2. Move Touch P5 closer to the host router. Clear obstacles in the way between your Touch P5 and the host router, and avoid interference from cordless phones, microwaves, and baby monitors.
3. Tap [Quick Setup](#) on the menu screen to run the setup again.
4. Tap [Reboot & Reset](#) on the menu screen, select [Reboot](#) to reboot your Touch P5 and try again.

Q5. What can I do if I forgot my account for web management page?

1. The default username and password of the web management page are [admin](#) (in lower case).
2. The web management page and touchscreen share the same password. Please try the administrator password of the touchscreen.
3. Restore your Touch P5 to its factory default settings: with your Touch P5 powered on, press and hold the [Reset](#) button on the back panel until the Touch P5 logo displays.

■ **Note:** Once your Touch P5 is reset, all the settings will be lost and you will need to re-configure your Touch P5.

Chapter 4

Configure Touch P5 as an Access Point

This chapter introduces how to connect and configure your Touch P5 in [access point mode](#) which will transform your existing wired network to a wireless network. We recommend that you use access point mode when your wireless devices need to access to a wired network, or when you require a supplement of ports for your wired router.

This chapter includes the following sections:

- [Connect Your Touch P5](#)
- [Log into Your Touch P5](#)
- [Quick Setup](#)
- [Mode Selection](#)
- [Wireless Settings](#)
- [WPS](#)
- [Devices Control](#)
- [LAN](#)
- [DHCP Server](#)
- [Screen Settings](#)
- [Reboot & Reset](#)
- [Administrator Password](#)
- [About](#)
- [FAQ](#)

4.1. Connect Your Touch P5

Follow the steps below to connect your Touch P5.



1. Install the antennas and position them vertically.
2. Connect the wired router's LAN port to the [Internet](#) port on your Touch P5 via an Ethernet cable.
3. Turn on your Touch P5 and wait until the system boot on the screen completes.
4. Connect your computer to your Touch P5. Use the default SSID (Wireless Network Name) and Wireless Password printed on the label at the bottom of your Touch P5 to connect wirelessly.

Note: If your Internet connection is through an Ethernet cable from the wall, instead of a wired router, connect the Ethernet cable directly to your Touch P5's [Internet](#) port.

Note: You can also connect your computer to the [Ethernet](#) port on your Touch P5 via an Ethernet cable.

4.2. Log into Your Touch P5

Your Touch P5 supports two configuration methods: [Web-based utility](#) and [Touchscreen utility](#). [Web-based utility](#) includes the configuration for all functions, and it requires a connection (wired or wireless) between your Touch P5 and the device you are using to log into the web management page. [Touchscreen utility](#) supports configuration for most commonly used functions, and the configuration can be easily done within a few taps on the touchscreen.

In this chapter, we will introduce most of the configuration through the touchscreen utility.

4.2.1. Option 1: Through Touchscreen Utility (Recommended)

1. On the menu screen, tap the [Mode Selection](#) icon to start it.
2. Select [Access Point](#) mode and tap [Save](#).

Note: Your Touch P5 will reboot to make your changes take effect, and please do **NOT** operate during the process.

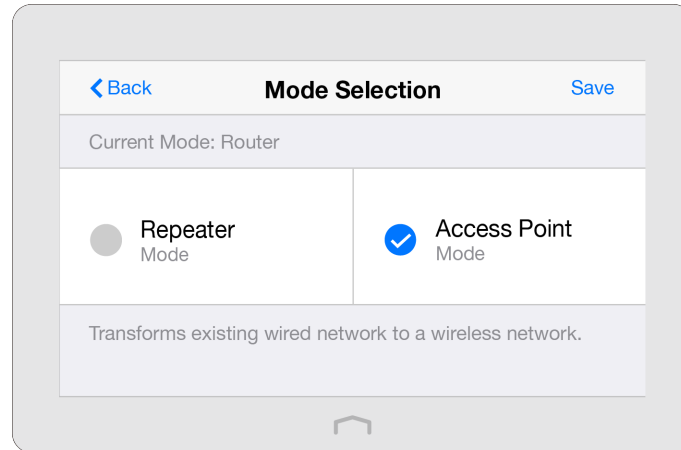

4.2.2. Option 2: Through Web-based Utility

The web-based utility can be used on any Windows, Macintosh or UNIX OS with a web browser, such as Microsoft Internet Explorer, Mozilla Firefox or Apple Safari. Follow the steps below to log into your Touch P5.

1. If the TCP/IP Protocol on your computer is set to the static (fixed) IP address, you need to change it to obtain an IP address automatically.
2. Launch a web browser, visit <http://tplinkwifi.net> and log in with the default username and password (**admin/admin**).

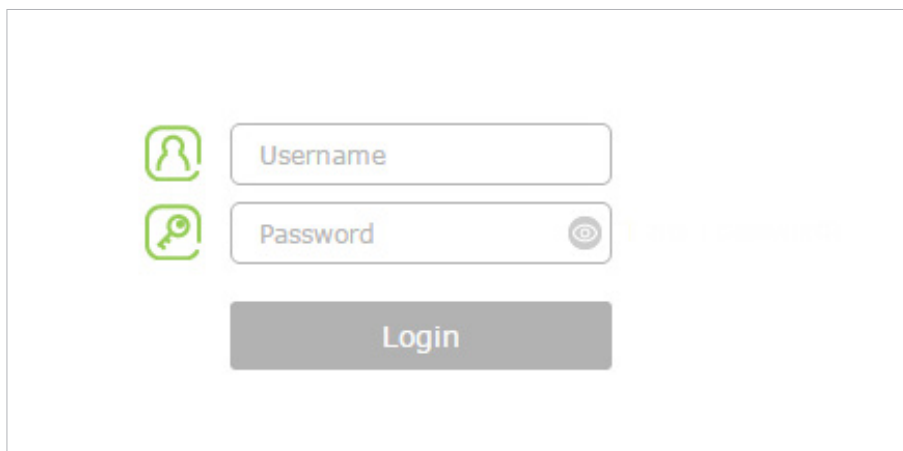

3. Click the **Mode** button in the upper-right corner of the title bar, select **Access Point** and click **Save**.

Note: Your Touch P5 will reboot to make your changes take effect, and please do **NOT** operate during the process.

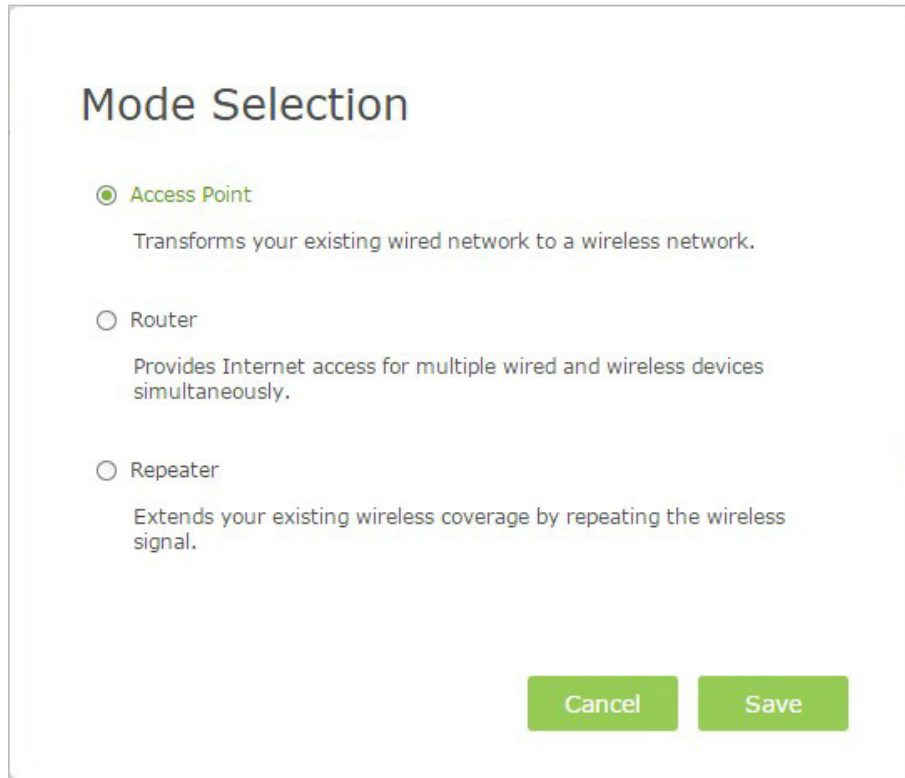

4.3. Quick Setup

The Quick Setup app on the touchscreen will guide you through the process to set the wireless network of your Touch P5.

1. On the menu screen, tap the **Quick Setup** icon to start it.
2. Follow the on-screen instructions to complete the configuration.
3. Once the configuration is completed, please connect your wireless devices to the wireless network of your Touch P5.

Note: If you change the preset wireless network name (SSID) and wireless password during the quick setup process, all your wireless devices must use the new SSID and password to connect to your Touch P5.

4.4. Mode Selection

The Mode Selection app helps you easily switch your Touch P5 to a router, repeater or an access point.

- **Router Mode (Default):** Touch P5 provides Internet access for multiple wired and wireless devices simultaneously.
- **Repeater Mode:** Touch P5 extends your existing wireless coverage by repeating the wireless signal.

- **Access Point Mode:** Touch P5 transforms your existing wired network to a wireless network.
 1. On the menu screen, tap the **Mode Selection** icon to start it.
 2. Select your desired mode, and tap **Save**.

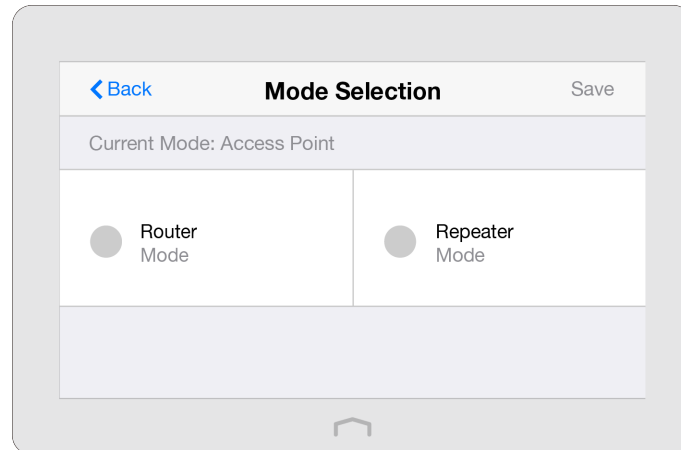

■ **Note:** Your Touch P5 will reboot to make your changes take effect, and please do **NOT** operate during the process.

4.5. Wireless Settings

The Wireless Settings app helps you customize the wireless settings including the wireless radio, wireless network name, password and security option, etc.

On the menu screen, tap the **Wireless Settings** icon to start it.

➤ To enable or disable the wireless function:

Select the wireless network 2.4GHz or 5GHz and enable the Wireless Radio. If you don't want to use the wireless function, just uncheck the box. If you disable the wireless function, all the wireless settings won't be effective.

➤ To change the network name (SSID) or hide SSID:

- Select the wireless network 2.4GHz or 5GHz and enter a new SSID using up to 32 characters. The default SSID is TP-LINK_XXXX and the value is case-sensitive.
- Select the wireless network 2.4GHz or 5GHz and select **Hide SSID**, and your SSID will not display when you scan for local wireless networks and you need to manually join the network.

■ **Note:** If you change the wireless settings on a wireless device, you will be disconnected when the settings are effective.

➤ To change the security option:

Select the wireless network 2.4GHz or 5GHz, choose your **Security Type**, and enter the corresponding encryption parameters. Your Touch P5 provides three options:

- **No Security:** Select this option to disable the wireless security.

- **WPA/WPA2-Personal (Recommended):** Select this option to enable the standard authentication method based on a Pre-shared Key (PSK), also called passphrase. Its security level is the highest.
- **WEP:** Select this option to enable basic authentication method if any of your client devices can only access the wireless using WEP (Wired Equivalent Privacy).

➤ **To change the mode, channel width, channel or transmit power:**

Select the wireless network 2.4GHz or 5GHz.

- **Mode:** Select the desired mode.
 - **802.11n only:** Select only if all of your wireless clients are 802.11n devices.
 - **802.11g/n mixed:** Select if you are using both 802.11b and 802.11g wireless clients.
 - **802.11b/g/n mixed:** Select if you are using a mix of 802.11b, 802.11g, and 802.11n wireless clients.

■ **Note:** When 802.11n only mode is selected, only 802.11n wireless devices can connect to your Touch P5. It is strongly recommended that you select 802.11b/g/n mixed, thus all 802.11b, 802.11g, and 802.11n wireless devices can connect to your Touch P5.

- **802.11ac only (For 5GHz):** Select only if all of your wireless clients are 802.11ac devices.
- **802.11n/ac mixed (For 5GHz):** Select if you are using both 802.11n and 802.11ac wireless clients.
- **802.11a/n/ac mixed (For 5GHz):** Select if you are using a mix of 802.11a, 802.11n and 802.11ac wireless clients. It is strongly recommended that you select 802.11a/n/ac mixed.
- **Channel Width:** Select the channel width from the list. The default setting is **Auto**, which can adjust the channel width for your clients automatically.
- **Channel:** Select the channel you want to use from the list. This field determines which operating frequency will be used. It is not necessary to change the wireless channel unless you notice interference problems with another nearby access point.
- **Transmit Power:** Select either High, Middle, or Low to specify the data transmit power. The default and recommended setting is **High**.

4.6. WPS

The WPS app helps you quickly establish a secure wireless connection between WPS (Wi-Fi Protected Setup) supported devices and your Touch P5. Wireless devices that support WPS, including Android phones, tablets, and most USB network cards, can connect to your Touch P5 through this method (WPS is not supported by IOS devices).

Note: The WPS function cannot be configured if the wireless function of your Touch P5 is disabled. Also, the WPS function will be disabled if your wireless encryption for both 2.4GHz and 5GHz is WEP. Please make sure the wireless function is enabled and is configured with the appropriate encryption before configuring via the WPS.

1. On the menu screen, tap the **WPS** icon to start it.

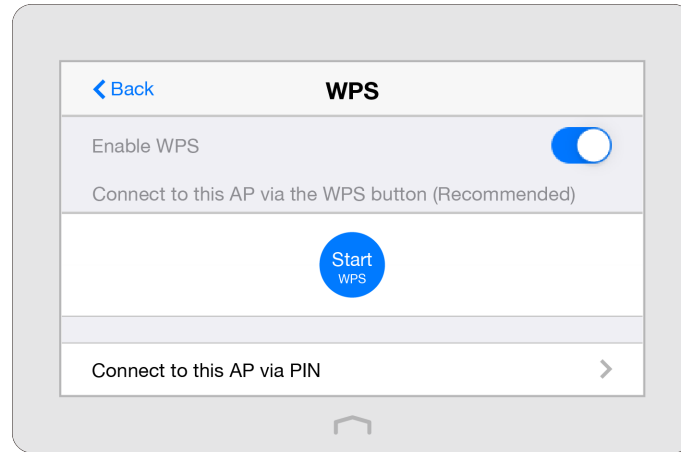

2. Use either the WPS Button method or PIN method.

➤ **Option 1: Use the WPS Button (Recommended)**

Use this option if your client device has a WPS button.

- 1) Tap the **Start WPS** button on the screen of your Touch P5, and the WPS button will show as below during the process.

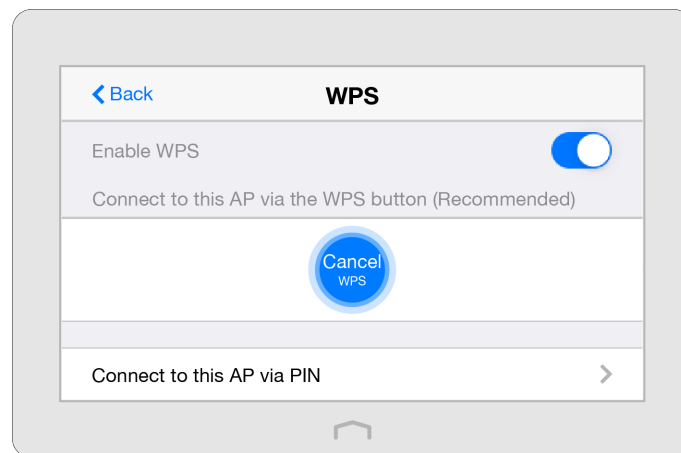

- 2) Immediately press the WPS button of the client device.
- 3) **Success** will appear on the above screen, which means the client device has successfully connected to your Touch P5.

Note: **Connection failed** will appear if the connection cannot be established within 2 minutes.

➤ **Option 2: Use the PIN**

Use this option if your client device asks for your Touch P5's PIN.

- 1) Tap [Connect to this AP via PIN](#) on the above screen of your Touch P5 to get the PIN. You can use the default one or generate a new one.

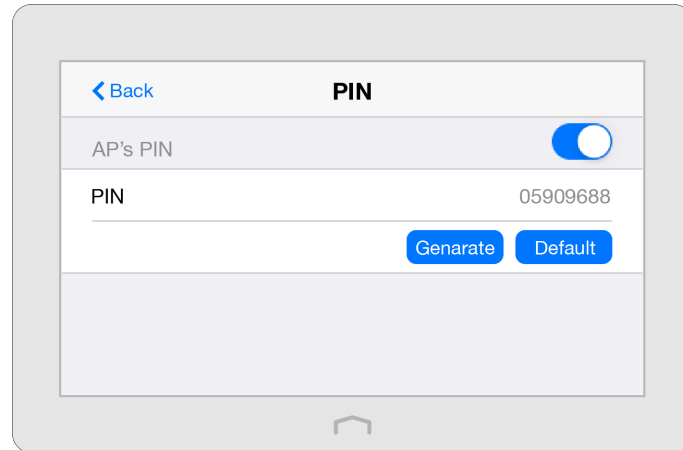

- 2) On the client device, enter your Touch P5's PIN to connect.

4.7. Devices Control

The Devices Control app helps to view the client information and block unauthorized users (wired or wireless) from connecting to your Touch P5.

I want to: Block some specific client devices from connecting to my Touch P5.

How can I do that?

1. On the menu screen, tap the [Devices Control](#) icon to start it and enable [Devices Control](#).

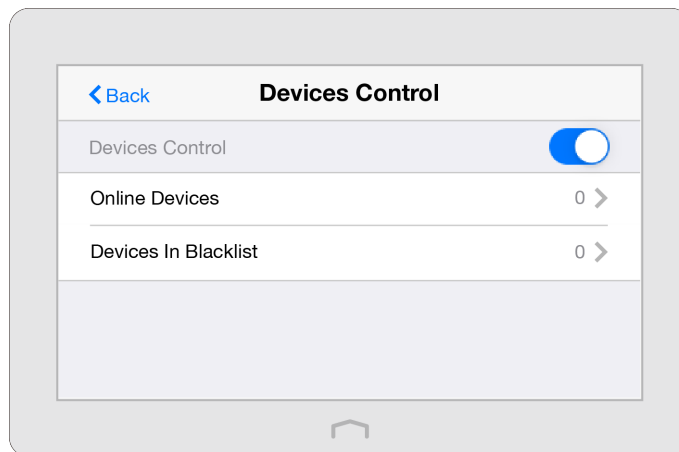

2. Tap [Online Devices](#) to view the connected clients.

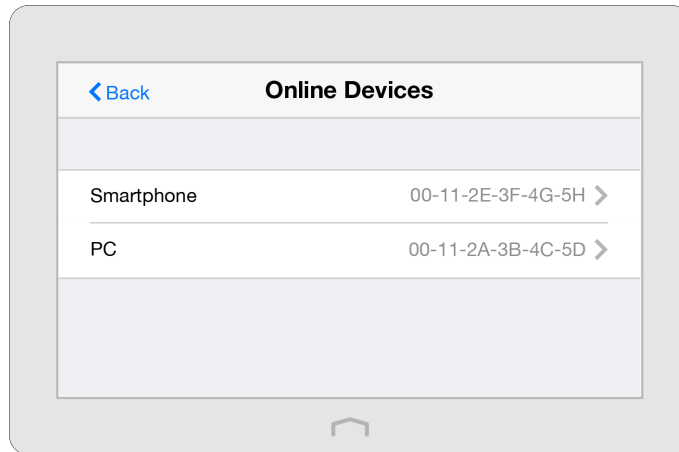

3. Select the device(s) to be blocked and tap **Block**.

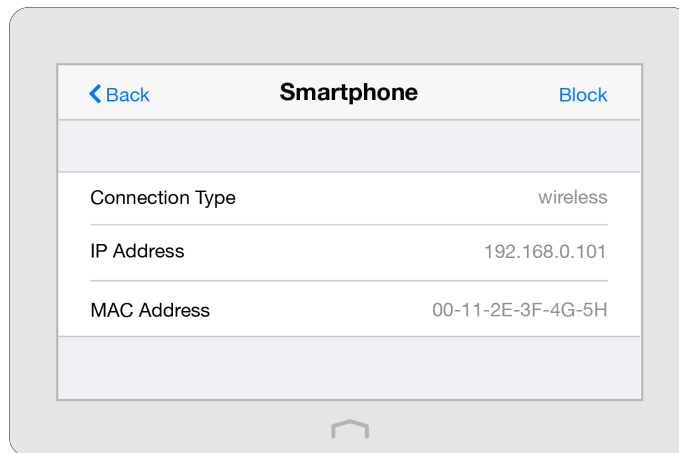

4. The blocked device(s) will be added to **Devices in Blacklist** automatically.

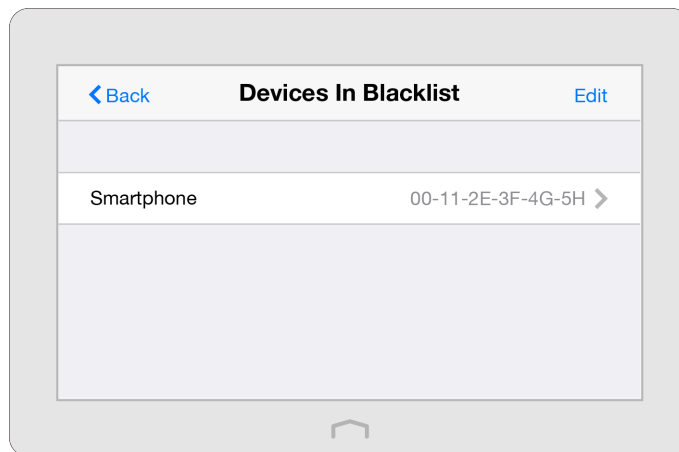

Note: If you want to add a device manually or delete a blocked device, tap **Edit** on the **Devices In Blacklist** page to set up as needed.

Done!

Now devices in the blacklist cannot connect to your Touch P5.

4.8. LAN

By default, your Touch P5 is set to obtain an IP address automatically from the host network. The LAN app allows you to use a specific IP address appropriate to your network demand.

Note: We do **NOT** recommend you change the IP address unless you are quite sure about the IP setting for special network demand. Random changes may lead to Internet disconnection.

1. On the menu screen, tap the **LAN** icon to start it.

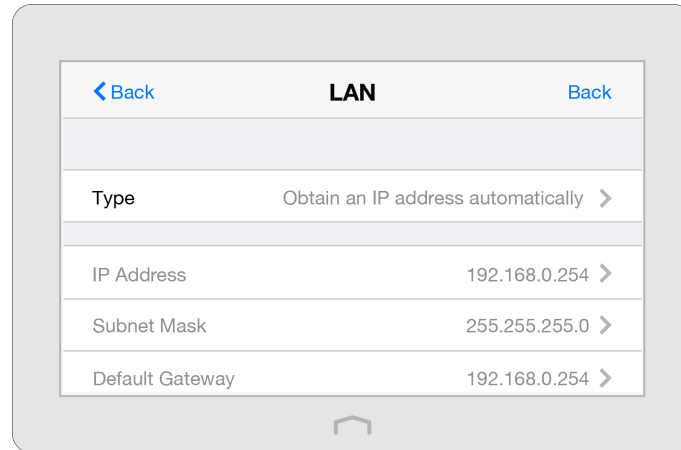

2. Tap **Type** to select **Use the following IP address** and tap **Done**.
3. Tap **IP Address** to enter an IP address in dotted decimal notation. It should be in the same subnet as the host network.
4. Tap **Subnet Mask** to enter the subnet mask in dotted decimal notation. It determines the network portion and host portion of the IP address.
5. Tap **Default Gateway** to enter the gateway in dotted decimal notation . It should be in the same subnet as the IP address.
6. Tap **Save**.

4.9. DHCP Server

The DHCP Server app can configure your Touch P5 to act as a DHCP (Dynamic Host Configuration Protocol) server to assign IP addresses to its clients and view client information from the client list. To use the DHCP server function of your Touch P5, you must configure all computers on the LAN as [Obtain an IP Address automatically](#). You can also manually reserve an IP address for a client that is connected to your Touch P5. Once reserved, the IP address will only be assigned to the same client by the DHCP server.

1. On the menu screen, tap the [DHCP Server](#) icon to start it.

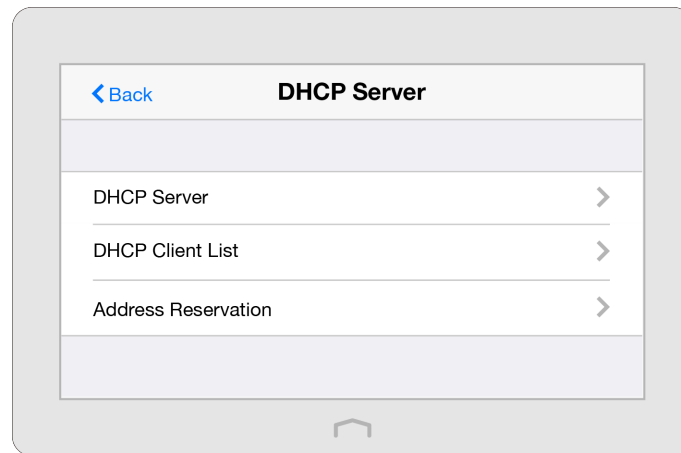

2. Configure the DHCP settings as needed.

➤ **To set DHCP server of your Touch P5:**

- 1) Select [DHCP Server](#).

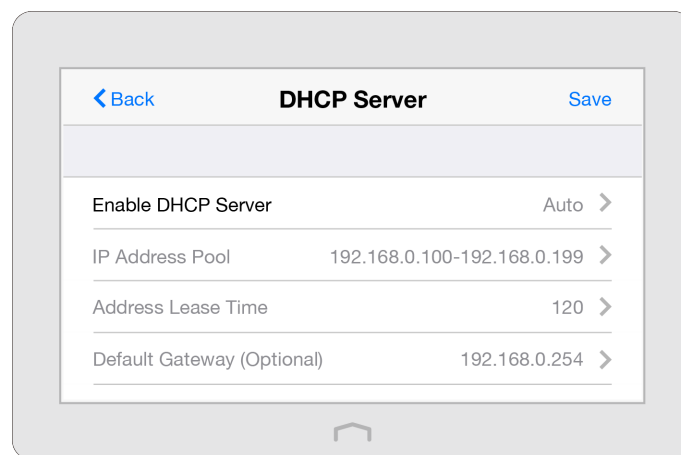

- 2) The [Enable DHCP Server](#) is set to be [Auto](#) by default and the function will automatically turn on or off to assign valid IP addresses to client devices according to the DHCP server settings of the host network.
If you select [On](#), please configure it manually.

- **IP Address Pool:** The start and end addresses must be on the same subnet with LAN IP. Your Touch P5 will assign addresses within this specified range to its clients. It is from 192.168.0.100 to 192.168.0.199 by default.
- **Address Lease Time:** The amount of time in which a DHCP client can lease its current dynamic IP address assigned by your Touch P5. After the dynamic IP address expires, the client will be automatically assigned a new dynamic IP address.
- **Default Gateway (Optional):** Enter the LAN IP address of your Touch P5.
- **Primary/Secondary DNS (Optional):** Enter this parameters as provided by your ISP.

If you select [Off](#), please make sure the DHCP server of your host network is on. Otherwise, you have to configure the IP address for each client manually.

3) Tap [Save](#).

➤ **To view the client information:**

1) Select [DHCP Client List](#).

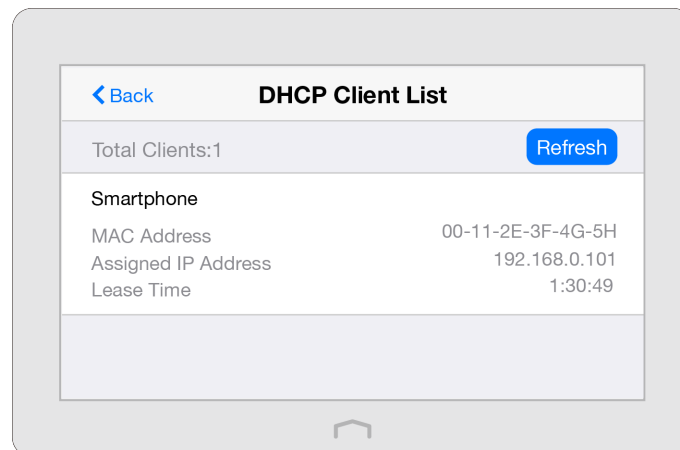

2) You can view the information of connected clients.

➤ **To reserve an IP address for a specified client device:**

1) Select [Address Reservation](#) and tap [Add](#) to add an address reservation entry for your device.

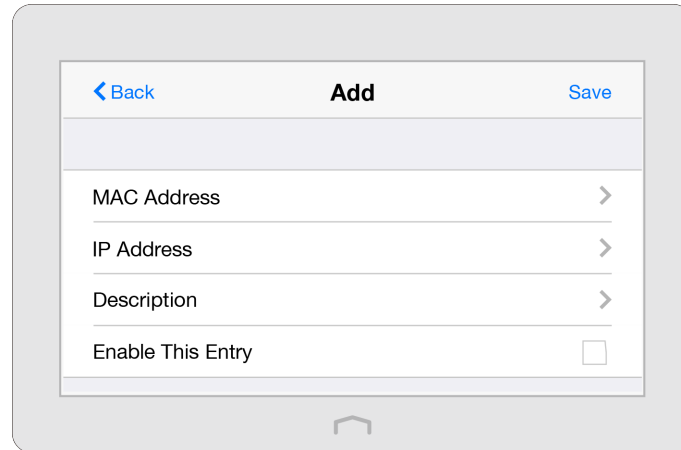

- 2) Enter the [MAC Address](#) of the device for which you want to reserve IP address.
- 3) Specify the [IP Address](#) which will be reserved for the device.
- 4) Enter the [Description](#) for the device.
- 5) Check the [Enable This Entry](#) box and tap [Save](#) to make the settings effective (shown as below).

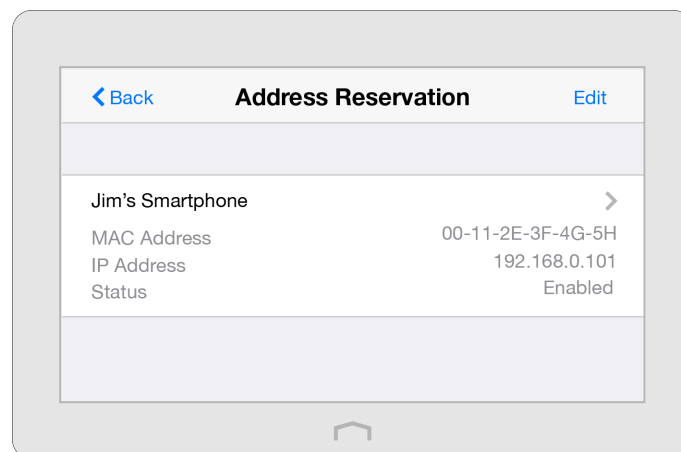

Note: If you want to modify a reserved address, tap the reserved address to modify it. If you want to add or delete a reserved address, tap [Edit](#) to set up according to your needs.

4.10. Screen Settings

The Screen Settings app helps to set the brightness and screen saver of your Touch P5.

1. On the menu screen, tap the [Screen Settings](#) icon to start it.

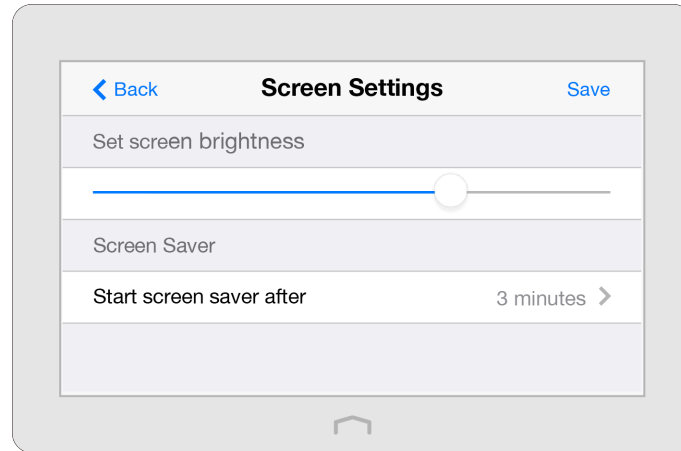

2. Drag the scroll bar to set the brightness of the screen.
3. By default, the screen saver will start if the screen is idle for 3 minutes. You can change the wait time.

Note: If you select [Never](#), the screen will stay on and never go to sleep and this will decrease the life span of the screen.

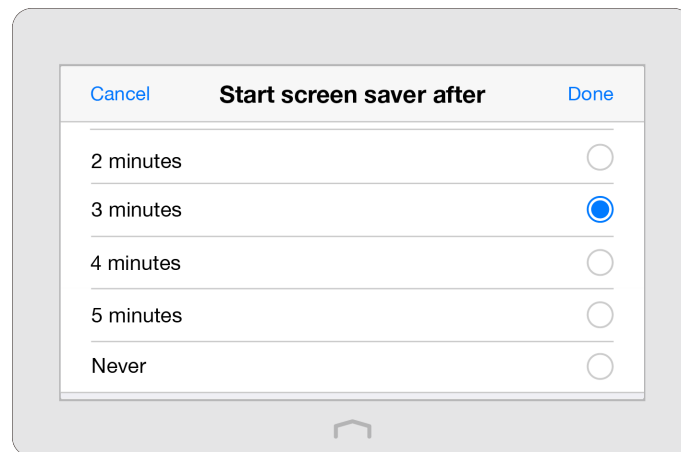

4.11. Reboot & Reset

With the Reboot & Reset app, you can restart your Touch P5 or reset it to its factory default settings.

1. On the menu screen, tap the [Reboot & Reset](#) icon to start it.

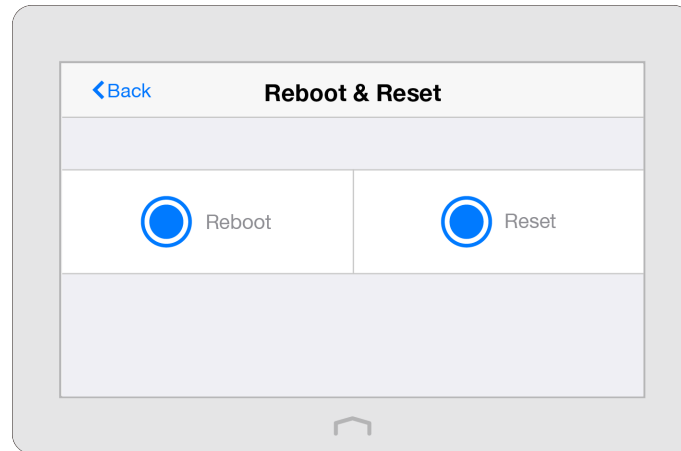

2. **Reboot:** Your Touch P5 will shut down and boot again.

Reset: To reset your Touch P5 to its factory default settings and all the settings you have configured will be erased.

■ **Note:** Please do **NOT** power off your Touch P5 during the rebooting or resetting process.

4.12. Administrator Password

Administrator password is used to log in to the touchscreen page and web management page of your Touch P5. You are required to set a new administrator password at your first login. You can also change it with the Administrator Password app.

1. On the menu screen, tap the [Administrator Password](#) icon to start it.

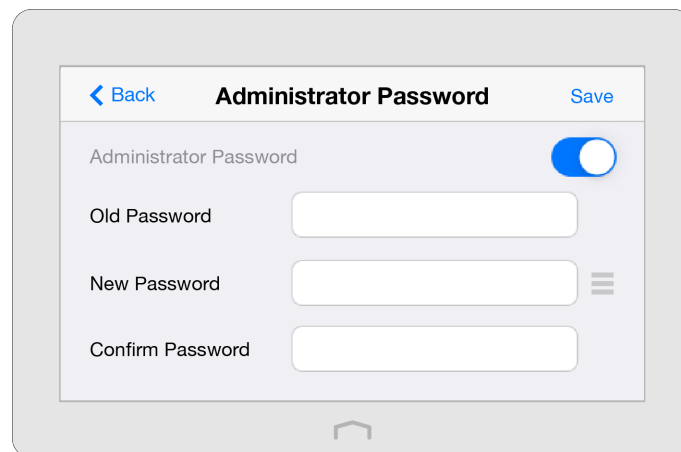

2. Enter the old password. Enter the new password and enter again to confirm.

3. Tap **Save**.

■ **Note:**

1. If you disable this function, your touchscreen will under no protection and anyone can change the settings of your Touch P5. But logging into the web management page still requires the password.
2. If you change the administrator password on the screen, logging into the web management page also requires the new password.

4.13. About

The About app displays the product model and hardware and firmware information of your Touch P5.

On the menu screen, tap the **About** icon to start it.

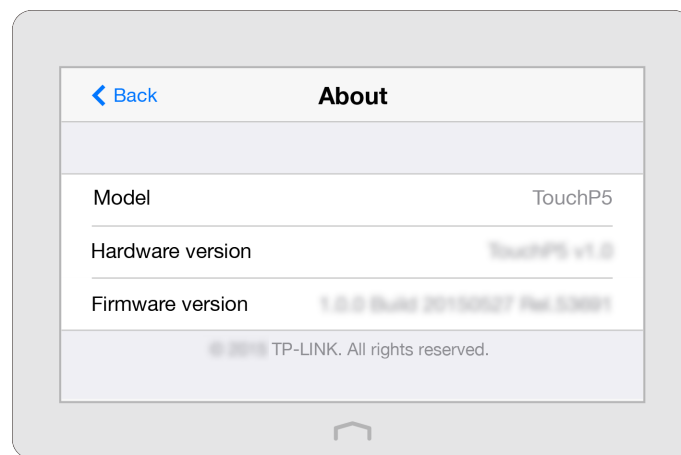

4.14. FAQ

Q1. What can I do if I cannot access the Internet?

1. Check if the Internet is working properly by connecting a computer directly to the wired router via an Ethernet cable. If not, contact your Internet Service Provider.
2. Tap **Quick Setup** on the menu screen to run the setup again.
3. Tap **Reboot & Reset** on the menu screen, select **Reboot** to reboot your Touch P5 and try again.

Q2. What can I do if I forgot my wireless network password?

Tap **Wireless Settings** on the menu screen to obtain the security password, both for 2.4GHz and 5GHz wireless networks.

Q3. How do I restore my Touch P5 to its factory default settings?

1. Tap **Reboot & Reset** on the menu screen, and then tap **Reset**.

2. With your Touch P5 powered on, press and hold the **Reset** button on the back panel until the Touch P5 logo displays.

■ **Note:** Once your Touch P5 is reset, all the settings will be lost and you will need to re-configure your Touch P5.

Q4. What can I do if I forgot my administrator password?

With your Touch P5 powered on, press and hold the **Reset** button on the back panel until the Touch P5 logo displays to restore your Touch P5 to its factory default settings, and create a new administrator password.

Q5. What can I do if I forgot my account for web management page?

1. The default username and password of the web management page are **admin** (in lower case).
2. The web management page and touchscreen share the same password. Please try the administrator password of the touchscreen.
3. Restore your Touch P5 to its factory default settings: with your Touch P5 powered on, press and hold the **Reset** button on the back panel until the Touch P5 logo displays.

■ **Note:** Once your Touch P5 is reset, all the settings will be lost and you will need to re-configure your Touch P5.

COPYRIGHT & TRADEMARKS

Specifications are subject to change without notice. **TP-LINK** is a registered trademark of TP-LINK TECHNOLOGIES CO., LTD. Other brands and product names are trademarks or registered trademarks of their respective holders.

No part of the specifications may be reproduced in any form or by any means or used to make any derivative such as translation, transformation, or adaptation without permission from TP-LINK TECHNOLOGIES CO., LTD. Copyright © 2016 TP-LINK TECHNOLOGIES CO., LTD. All rights reserved.

FCC STATEMENT



This equipment has been tested and found to comply with the limits for a Class B digital device, pursuant to part 15 of the FCC Rules. These limits are designed to provide reasonable protection against harmful interference in a residential installation. This equipment generates, uses and can radiate radio frequency energy and, if not installed and used in accordance with the instructions, may cause harmful interference to radio communications. However, there is no guarantee that interference will not occur in a particular installation. If this equipment does cause harmful interference to radio or television reception, which can be determined by turning the equipment off and on, the user is encouraged to try to correct the interference by one or more of the following measures:

- Reorient or relocate the receiving antenna.
- Increase the separation between the equipment and receiver.
- Connect the equipment into an outlet on a circuit different from that to which the receiver is connected.
- Consult the dealer or an experienced radio/ TV technician for help.

This device complies with part 15 of the FCC Rules. Operation is subject to the following two conditions:

1. This device may not cause harmful interference.
2. This device must accept any interference received, including interference that may cause undesired operation.

Any changes or modifications not expressly approved by the party responsible for compliance could void the user's authority to operate the equipment.

Note: The manufacturer is not responsible for any radio or TV interference caused by unauthorized modifications to this equipment. Such modifications could void the user's authority to operate the equipment.

FCC RF Radiation Exposure Statement

This equipment complies with FCC RF radiation exposure limits set forth for an uncontrolled environment. This device and its antenna must not be co-located or operating in conjunction with any other antenna or transmitter.

"To comply with FCC RF exposure compliance requirements, this grant is applicable to only Mobile Configurations. The antennas used for this transmitter must be installed to provide a separation distance of at least 20 cm from all persons and must not be co-located or operating in conjunction with any other antenna or transmitter."

This device is restricted in indoor environment only.

CE Mark Warning



This is a class B product. In a domestic environment, this product may cause radio interference, in which case the user may be required to take adequate measures.

RF Exposure Information

This device meets the EU requirements (1999/5/EC Article 3.1a) on the limitation of exposure of the general public to electromagnetic fields by way of health protection.

The device complies with RF specifications when the device used at 20 cm from your body.

National Restrictions

Restricted to indoor use.

Canadian Compliance Statement

This device complies with Industry Canada license-exempt RSS standard(s). Operation is subject to the following two conditions:

1. This device may not cause interference, and
2. This device must accept any interference, including interference that may cause undesired operation of the device.

Le présent appareil est conforme aux CNR d'Industrie Canada applicables aux appareils radio exempts de licence. L'exploitation est autorisée aux deux conditions suivantes :

1. l'appareil ne doit pas produire de brouillage;
2. l'utilisateur de l'appareil doit accepter tout brouillage radioélectrique subi, même si le brouillage est susceptible d'en compromettre le fonctionnement.

This radio transmitter (IC: 8853A-Touch P5/ Model: Touch P5) has been approved by Industry Canada to operate with the antenna types listed below with the maximum permissible gain indicated. Antenna types not included in this list below, having a gain greater than the maximum gain indicated for that type, are strictly prohibited for use with this device.

Le présent émetteur radio (IC: 8853A-Touch P5/ Model: Touch P5) a été approuvé par Industrie Canada pour fonctionner avec les types d'antenne énumérés ci-dessous et ayant un gain admissible maximal. Les types d'antenne non inclus dans cette liste ci-dessous et dont le gain est supérieur au gain maximal indiqué, sont strictement interdits pour l'exploitation de l'émetteur.

Antenna	3 Dual Band Detachable Antennas, 2dBi for both 5GHz and 2.4GHz
---------	--

Caution:

1. The device for operation in the band 5150–5250 MHz is only for indoor use to reduce the potential for harmful interference to co-channel mobile satellite systems;
2. For devices with detachable antenna(s), the maximum antenna gain permitted for devices in the band 5725-5850 MHz shall be such that the equipment still complies with the e.i.r.p. limits specified for point-to-point and non-point-to-point operation as appropriate; and

The high-power radars are allocated as primary users (i.e. priority users) of the bands 5250-5350 MHz and 5650-5850 MHz and that these radars could cause interference and/or damage to LE-LAN devices.

Avertissement:

1. Le dispositif fonctionnant dans la bande 5150-5250 MHz est réservé uniquement pour une utilisation à l'intérieur afin de réduire les risques de brouillage préjudiciable aux systèmes de satellites mobiles utilisant les mêmes canaux;
2. Le gain maximal d'antenne permis pour les dispositifs avec antenne(s) amovible(s) utilisant la bande 5725-5850 MHz doit se conformer à la limitation P.I.R.E spécifiée pour l'exploitation point à point et non point à point, selon le cas.

En outre, les utilisateurs devraient aussi être avisés que les utilisateurs de radars de haute puissance sont désignés utilisateurs principaux (c.-à-d., qu'ils ont la priorité) pour les bandes 5250-5350 MHz et 5650-5850 MHz et que ces radars pourraient causer du brouillage et/ou des dommages aux dispositifs LAN-EL.

Radiation Exposure Statement:

This equipment complies with IC radiation exposure limits set forth for an uncontrolled environment. This equipment should be installed and operated with minimum distance 20cm between the radiator & your body.

Declaration d'exposition aux radiations:

Cet équipement est conforme aux limites d'exposition aux rayonnements IC établies pour un environnement non contrôlé. Cet équipement doit être installé et utilisé avec un minimum de 20 cm de distance entre la source de rayonnement et votre corps.

Industry Canada Statement

CAN ICES-3 (B)/NMB-3(B)

Korea Warning Statements:

당해 무선설비는 운용중 전파혼신 가능성이 있음.

NCC Notice & BSMI Notice:

注意！

依據 低功率電波輻射性電機管理辦法

第十二條 經型式認證合格之低功率射頻電機，非經許可，公司、商號或使用者均不得擅自變更頻率、加大功率或變更原設計之特性或功能。

第十四條 低功率射頻電機之使用不得影響飛航安全及干擾合法通行；經發現有干擾現象時，應立即停用，並改善至無干擾時方得繼續使用。前項合法通信，指依電信規定作業之無線電信。低功率射頻電機需忍受合法通信或工業、科學以及醫療用電波輻射性電機設備之干擾。

電磁波曝露量MPE標準值 $1\text{mW}/\text{cm}^2$ ，送測產品實測值為 $0.2699\text{ mW}/\text{cm}^2$ 。

安全諮詢及注意事項

- 請使用原裝電源供應器或只能按照本產品注明的電源類型使用本產品。
- 清潔本產品之前請先拔掉電源線。請勿使用液體、噴霧清潔劑或濕布進行清潔。
- 注意防潮，請勿將水或其他液體潑灑到本產品上。
- 插槽與開口供通風使用，以確保本產品的操作可靠並防止過熱，請勿堵塞或覆蓋開口。
- 請勿將本產品置放於靠近熱源的地方。除非有正常的通風，否則不可放在密閉位置中。
- 請不要私自打開機殼，不要嘗試自行維修本產品，請由授權的專業人士進行此項工作。



Продукт сертифіковано згідно с правилами системи УкрСЕПРО на відповідність вимогам нормативних документів та вимогам, що передбачені чинними законодавчими актами України.

EAC

Safety Information



- When product has power button, the power button is one of the way to shut off the product; when there is no power button, the only way to completely shut off power is to disconnect the product or the power adapter from the power source.
- Don't disassemble the product, or make repairs yourself. You run the risk of electric shock and voiding the limited warranty. If you need service, please contact us.
- Avoid water and wet locations.
- Adapter shall be installed near the equipment and shall be easily accessible.
- The plug considered as disconnect device of adapter.

-  Use only power supplies which are provided by manufacturer and in the original packing of this product. If you have any questions, please don't hesitate to contact us.

For EU/EFTA, this product can be used in the following countries:

AT	BE	BG	CH	CY	CZ	DE	DK
EE	ES	FI	FR	GB	GR	HR	HU
IE	IS	IT	LI	LT	LU	LV	MT
NL	NO	PL	PT	RO	SE	SI	SK

Explanations of the symbols on the product label

Symbol	Explanation
	DC voltage
	<p>RECYCLING</p> <p>This product bears the selective sorting symbol for Waste electrical and electronic equipment (WEEE). This means that this product must be handled pursuant to European directive 2012/19/EU in order to be recycled or dismantled to minimize its impact on the environment.</p> <p>User has the choice to give his product to a competent recycling organization or to the retailer when he buys a new electrical or electronic equipment.</p>