



Contact SAMSUNG WORLD WIDE

If you have any questions or comments relating to Samsung products, please contact the SAMSUNG customer care center.

Country	Customer Care Center ☎	Web Site	Address
CANADA	1-800-SAMSUNG (726-7864)	www.samsung.com/ca (English) www.samsung.com/ca_fr (French)	Samsung Electronics Canada Inc., Customer Service 55 Standish Court Mississauga, Ontario L5R 4B2 Canada
U.S.A	1-800-SAMSUNG (726-7864)	www.samsung.com	Samsung Electronics America, Inc. 85 Challenger Road Ridgefield Park, NJ 07660



SERIES **5+**
5500

Plasma TV

user manual



Thank you for purchasing this Samsung product.
To receive more complete service, please register
your product at
www.samsung.com/register

Model _____ Serial No. _____

☎ If you have any questions, please call us at 1-800-SAMSUNG (1-800-726-7864) for assistance.



Important Safety Instructions

SAMSUNG

Warning! Important Safety Instructions

CAUTION

RISK OF ELECTRIC SHOCK DO NOT OPEN

CAUTION: TO REDUCE THE RISK OF ELECTRIC SHOCK, DO NOT REMOVE COVER (OR BACK). THERE ARE NO USER SERVICEABLE PARTS INSIDE. REFER ALL SERVICING TO QUALIFIED PERSONNEL.



This symbol indicates that high voltage is present inside. It is dangerous to make any kind of contact with any internal part of this product.



This symbol indicates that important literature concerning operation and maintenance has been included with this product.

- The slots and openings in the cabinet and in the back or bottom are provided for necessary ventilation. To ensure reliable operation of this apparatus, and to protect it from overheating, these slots and openings must never be blocked or covered.
 - Do not place this apparatus in a confined space, such as a bookcase, or built-in cabinet, unless proper ventilation is provided.
 - Do not place this apparatus near or over a radiator or heat register, or where it is exposed to direct sunlight.
 - Do not place vessels (vases etc.) containing water on this apparatus, as this can result in a fire or electric shock.
- Do not expose this apparatus to rain or place it near water (near a bathtub, washbowl, kitchen sink, or laundry tub, in a wet basement, or near a swimming pool etc.). If this apparatus accidentally gets wet, unplug it and contact an authorized dealer immediately.
- This apparatus uses batteries. In your community, there might be environmental regulations that require you to dispose of these batteries properly. Please contact your local authorities for disposal or recycling information.
- Do not overload wall outlets, extension cords or adaptors beyond their capacity, since this can result in fire or electric shock.
- Power-supply cords should be placed so that they are not likely to be walked on or pinched by items placed upon or against them. Pay particular attention to cords at the plug end, at wall outlets, and the point where they exit from the appliance.
- To protect this apparatus from a lightning storm, or when it is left unattended and unused for long periods of time, unplug it from the wall outlet and disconnect the antenna or cable system. This will prevent damage to the set due to lightning and power line surges.
- Before connecting the AC power cord to the DC adaptor outlet, make sure the voltage designation of the DC adaptor corresponds to the local electrical supply.
- Never insert anything metallic into the open parts of this apparatus. Doing so may create a danger of electric shock.
- To avoid electric shock, never touch the inside of this apparatus. Only a qualified technician should open this apparatus.
- Make sure to plug the power cord in until it is firmly seated. When unplugging the power cord from a wall outlet, always pull on the power cord's plug. Never unplug by pulling on the power cord. Do not touch the power cord with wet hands.
- If this apparatus does not operate normally - in particular, if there are any unusual sounds or smells coming from it - unplug it immediately and contact an authorized dealer or service center.
- Be sure to pull the power plug out of the outlet if the TV is to remain unused or if you are to leave the house for an extended period of time (especially when children, elderly or disabled people will be left alone in the house).
 - Accumulated dust can cause an electric shock, an electric leakage or a fire by causing the power cord to generate sparks and heat or the insulation to deteriorate.
- Be sure to contact an authorized service center for information if you intend to install your TV in a location with heavy dust, high or low temperatures, high humidity, chemical substances, or where it will operate 24 hours a day such as in an airport, a train station, etc. Failing to do so may lead to serious damage of your TV.
- Use only a properly grounded plug and wall outlet.
 - An improper ground may cause electric shock or equipment damage. (Class I Equipment only.)
- To turn this apparatus off completely, you must disconnect it from the wall outlet. Consequently, the wall outlet and power plug must be readily accessible at all times.
- Do not allow children to hang onto the product.
- Store the accessories (battery, etc.) in a location safely out of the reach of children.
- Do not install the product in an unstable location such as a shaky shelf, a slanted floor or a location exposed to vibration.
- Do not drop or apply any shock to the product. If the product is damaged, disconnect the power cord and contact a service center.
- To clean this apparatus, unplug the power cord from the wall outlet and wipe the product using a soft, dry cloth. Do not use any chemicals such as wax, benzene, alcohol, thinners, insecticide, air fresheners, lubricants, or detergent. These chemicals can damage the appearance of the TV or erase the printing on the product.
- Do not expose this apparatus to dripping or splashing.
- Do not dispose of batteries in fire.
- Do not short-circuit, disassemble or overheat the batteries.
- There is danger of an explosion if you replace the batteries used in the remote with the wrong type of battery. Replace only with the same or equivalent type.
- **WARNING - TO PREVENT THE SPREAD OF FIRE, KEEP CANDLES OR OTHER OPEN FLAMES AWAY FROM THIS PRODUCT AT ALL TIMES.**



Contents

Basic Features

- 5 Using the Smart Touch Control
 - 6 Connecting to the TV
 - 6 Inserting the Batteries (AAA X 2)
 - 7 Low Battery Power Warning
- 8 Using the touch pad
 - 8 Changing Channels by Entering Numbers
 - 9 Show Status and Notification Banner
 - 9 Recommended
 - 9 History
 - 9 Searching
 - 9 Using the Virtual Remote Control
- 10 Turning on the TV
- 11 Switching Between Video Sources
- 12 Universal Remote Setup
 - 12 Add the External Device

Viewing the e-Manual

- 13 Viewing the e-Manual
 - 13 Scrolling a Page
 - 13 Using the Top Icons
 - 13 Returning to the Home Page
 - 13 Searching the Index
 - 14 Searching Pages
 - 14 Closing the e-Manual
 - 14 Jumping to a Menu Item
 - 14 Updating the e-Manual

Network Configuration

- 15 Connecting to a Network
 - 15 Network Connection - Wireless
 - 15 Wireless Network Precautions
 - 15 Network Security Protocols
 - 16 Network Connection - Wired

3D Basics

- 17 3D Active Glasses
 - 17 Pairing 3D Active Glasses
 - 19 Watching 3D Video

Troubleshooting and Other Information

- 20 What is Remote Support?
- 21 Troubleshooting
- 22 Mounting the TV on the Wall Using the Wall Mount Kit (Optional)
- 24 Assembling the Cable manager
- 24 Eco Sensor and Screen Brightness
- 25 Maintenance
- 25 Providing Proper Ventilation for Your TV
- 26 Securing the TV to the Wall

Specifications

- 27 Specifications
- 28 Dimensions
- 28 Licenses

Guides

- 29 Warranty Information
- 32 Regulatory Compliance Statements (For 3D Active Glasses)
- 33 SAMSUNG BRAND PRODUCTS
 - 33 LIMITED WARRANTY TO ORIGINAL PURCHASER

Figures and illustrations in this User Manual are provided for reference only and may differ from the actual product appearance. Product design and specifications may change without notice.

Features of your new TV

- **3D:** This new feature enables you to view 3D content.

- **SMART HUB:**

This TV features Smart Hub, a multi-purpose entertainment and family center. With Smart Hub, you can surf the web, download applications, and stay in touch with family and friends through social networking services. In addition, you can view or play photo, video, and music files stored on external storage devices.

Press the  button to launch Smart Hub. Choose a service using the icons displayed in the top part of the screen.

Smart Hub services and functionality include:

Social: Watch the latest YouTube videos and you and your friends' video posts on Facebook and Twitter. You can also make video calls to friends by connecting the TV to a camera (sold separately).

Apps: Samsung Apps offers an extensive collection of free and paid news, sports, weather, and gaming content you can directly download to and enjoy on your TV.

On TV: Check a listing of programs that are currently airing or are scheduled to air.

Movies & TV Shows: Purchase and watch movies and series without a separate external device.

Photos, Videos & Music: Play back photo, video, and music files from an external storage device.

- **Anynet+ (HDMI-CEC):** This allows you to control all connected Samsung devices that support Anynet+ with your Samsung TV's remote.
- **e-Manual:** Provides a detailed, on-screen user's manual built into your TV.
- **SMART Interaction:** Using this function, you can access and control menu options and functions using motions. To use the Smart Interaction Feature, connect the SMART TV camera (sold separately) to your TV.
- **Device Manager:** Use the TV features with a USB or Bluetooth keyboard and mouse.
- **Screen Mirroring:** Displays mobile device screens on your TV using a wireless connection.

Using the Smart Touch Control

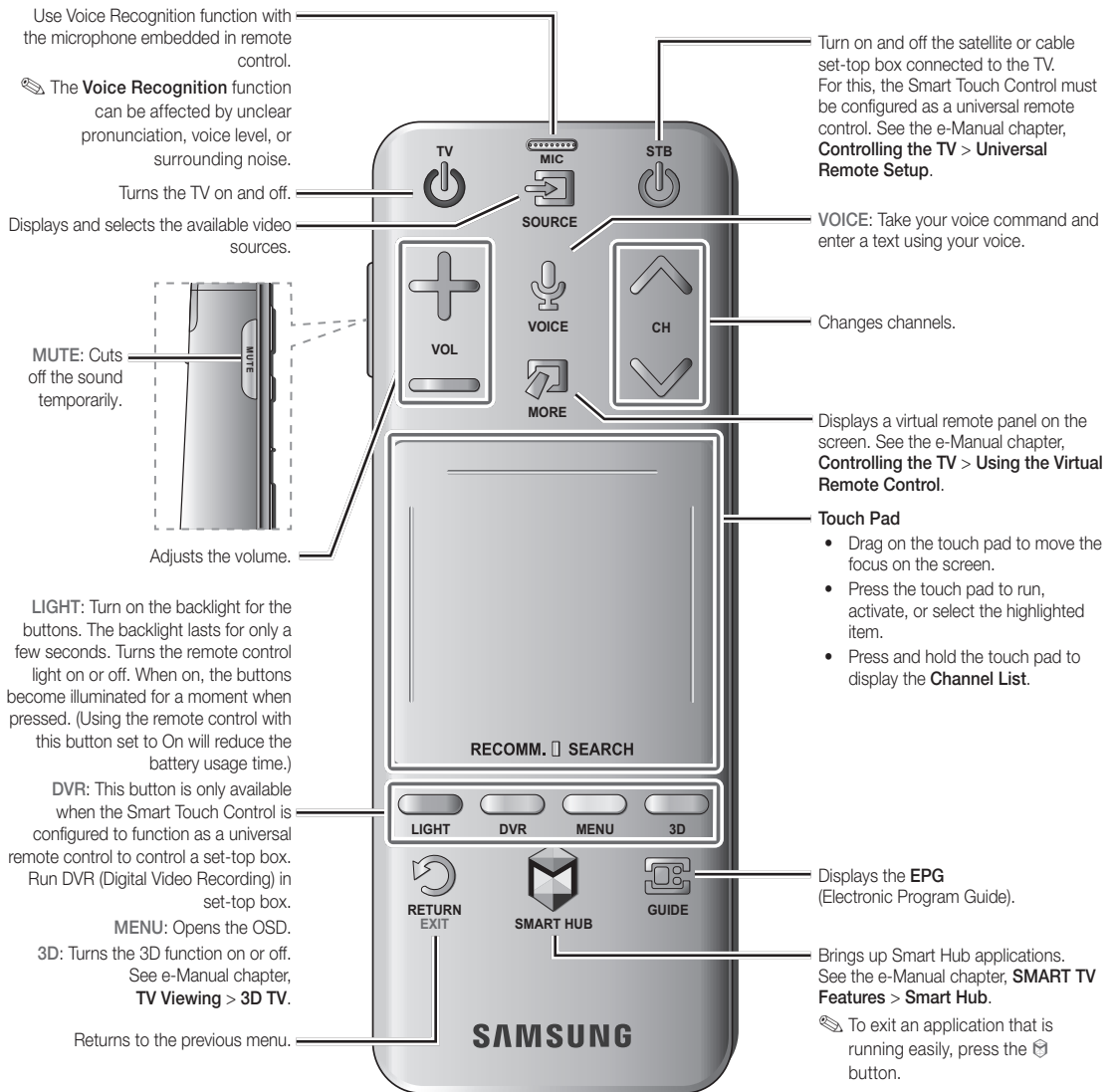

Connecting to the TV

In order to operate the TV using a Smart Touch Control, you must first pair it to the TV via Bluetooth. However, the Smart Touch Control is only available for the paired Samsung TV.

1. To turn on the TV, point the Smart Touch Control at the remote control receiver of the TV and press the  button. The remote control receiver's location may vary depending on the model.
2. A Bluetooth icon will appear at the bottom left of the screen as shown below. The TV will then attempt to connect to the Smart Touch Control automatically.



<Attempting to connect and completion icons>

Inserting the Batteries (AAA X 2)

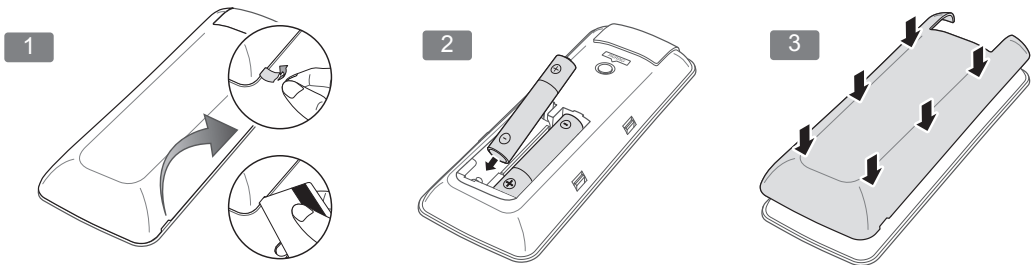

1. Slightly lift the battery cover by pulling the strap or using a plastic card (e.g. a credit card). Next, pull on the cover's notch with a fingernail to remove the cover completely.
2. Insert 2 AAA batteries, making sure to align the positive and negative ends correctly.
3. Align the battery cover with the back of the remote control, and then press down along the edges until it is completely attached to the remote control.

Reconnecting the Smart Touch Control

If you need to reestablish the connection between the TV and the Smart Touch Control, press the pairing button at the back of the Smart Touch Control, pointing at the remote control sensor of the TV.

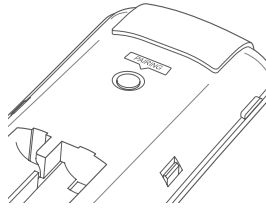

<The Smart Touch Control's pairing button>

The pairing button can be accessed by removing the Smart Touch Control's battery cover. Pressing the pairing button automatically reestablishes the connection between the Smart Touch Control and the TV.

Low Battery Power Warning



If the battery becomes low while using the Smart Touch Control, the following alarm window appears at the bottom of the left screen. If the alarm window pops up, replace the batteries of the Smart Touch Control. Use alkaline batteries for longer usage.



<Low battery alarm window>

Using the touch pad

Use the touch pad to implement various commands. Navigate to **Tutorial (System > Device Manager > Smart Touch Control Settings > Tutorial)** to view an on-screen guide to using the Smart Touch Control.

Dragging	Pressing
	
<p>Drag on the touch pad to move the focus, pointer, or highlight in the direction the finger is dragging.</p>	<p>Press the touch pad to select the item highlighted or in focus. When watching TV, press and hold the touch pad for 2 seconds displays the channel list. On some apps, press and hold the touch pad for 2 seconds displays a list of functions available for the app.</p>

Changing Channels by Entering Numbers

While watching TV, tap on the protruding line on the left or right edge of the touchpad to bring up the numerical input window on the screen. Use your finger to enter the number for the channel you want to watch. The recognized number is displayed on the screen and the TV switches to the corresponding channel. However, the number you have entered may not be recognized properly by the TV. Refer to the guide below to ensure that your numerical entries are recognized accurately.



Numerical Input Guide

Refer to the diagrams below when entering numerical values. The TV may not recognize your entries if you do not follow the sequences shown below.

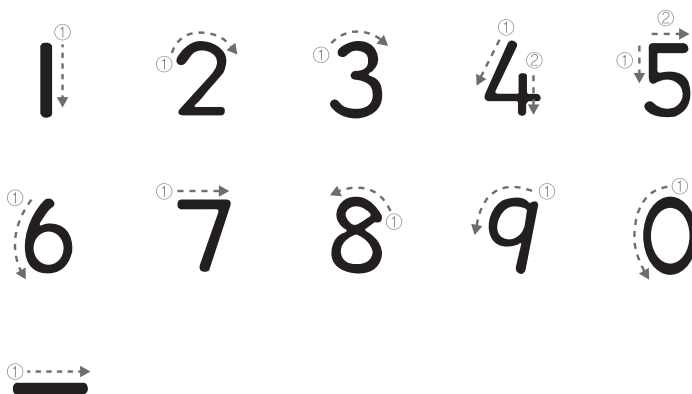

Show Status and Notification Banner

Press the **MORE** button on the Smart Touch Control and then select **STATUS** on the virtual remote panel that appears on the screen. The status and notification banner appears at the top of the screen. For more information about using the status and notification banner, refer to **e-Manual > SMART TV Features > Status and Notification**.

Recommended

Press the **RECOMM. / SEARCH** button and then select the **Recommended** from the list on bottom of the screen. This shows the current/scheduled program and application recommendations.

Select a program that is currently airing to jump to the corresponding channel or a program that is scheduled to air to set up a Schedule Viewing setting. Refer to **e-Manual > SMART TV Features > On TV** for more information.

Select an application to launch. Samsung Apps will launch if the selected application is not installed on the TV. Refer to **e-Manual > SMART TV Features > Apps > Samsung Apps** for more information.

History

Press the **RECOMM. / SEARCH** button and then select **History** from the list displayed at the bottom of the screen. This displays an interactive list of recently accessed channels, media content and applications.

Searching

Press the **RECOMM. / SEARCH** button on the Smart Touch Control. The list appears at the bottom of the screen. Press the **RECOMM. / SEARCH** button again. The keypad will appear on the screen. Enter search criteria to search not only many apps and their contents on the TV but also the Web.

Refer to **e-Manual > SMART TV Features > Searching** for more information.

Using the Virtual Remote Control

Press the **MORE** button to display the virtual remote panel on the TV screen. The virtual remote panel consists of the number panel, a playback control panel, and the quick access panel. Use the touch pad to highlight and select icons, numbers, and buttons on the panels.

 The displayed virtual remote panel on the TV screen may differ depending on the country.

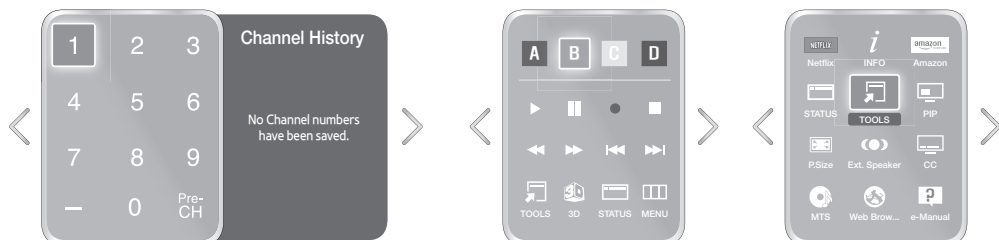

Changing the Virtual Remote Panel

You can change which virtual remote panel is displayed on the TV screen. To shift between panels, move the focus highlight beyond the left or right edge of the displayed panel.

Use left/right scroll function on the touch pad to change the panel easily.

Change a position of the Virtual Remote Panel

Press the **MORE** button on the Smart Touch Control. The virtual remote panel appears on the screen. Press and hold the touch pad for one second. Users can change a position of the virtual remote panel of the screen.

Using the Number Panel

Use the number panel to enter numbers on a keypad screen or webpage or to change the channel while watching TV. Changing the channel using the number pad leaves a record, allowing you to easily return to previous channels.

Using the Playback Control Panel



Use the playback control panel to pause, rewind, fast forward, skip to the next file, select a function with the **A**, **B**, **C**, **D** button, and much more while enjoying media content.

Using the Quick Access Panel

Use the buttons on the quick access panel to bring up the TV's **INFO**, **TOOLS**, or **e-Manual** screens. Note that the buttons that appear may vary depending on the operating mode of the Smart Touch Control (with the TV only, as a universal remote, etc.).

Turning on the TV

Turn on the TV using the  button on the Smart Touch Control or TV panel.

-  The product color and shape may vary depending on the model.
-  The first time you turn on your TV, it will immediately start the initial setup.
-  The TV's Controller, a small joy stick like button on the rear left side of the TV, lets you control the TV without the remote control.

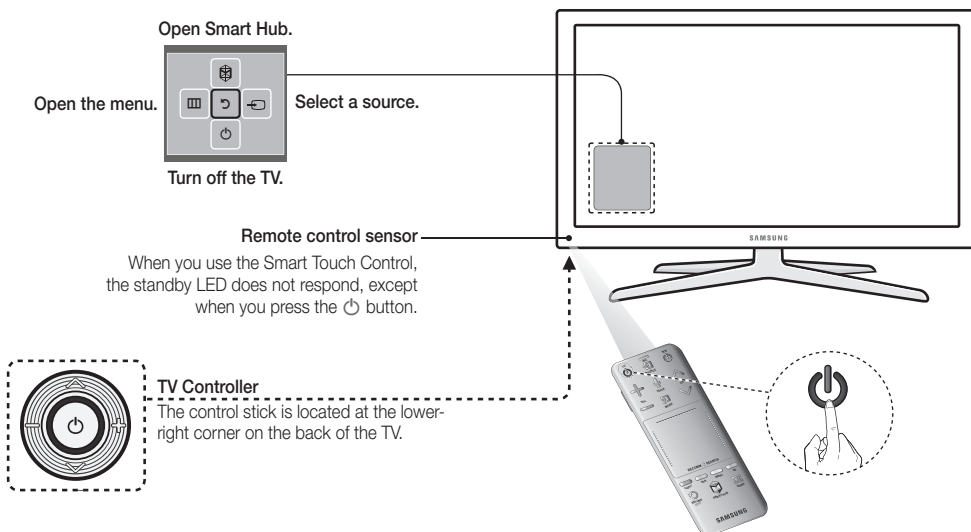

Switching Between Video Sources

Press the **SOURCE** button to switch between devices connected to the TV.

For example, to switch to a game console connected to the second HDMI connector, press the **SOURCE** button. From the **Source** list, select **HDMI2**. The connector names may vary depending on the product.

Select **Tools** at the upper-right corner of the source screen to access the following functions.

- **Edit Name:** Lets you associate a device name to an input source.

You can select the following device names in the **Edit Name** option:

VCR / DVD / Cable STB / Satellite STB / PVR STB / AV Receiver / Game / Camcorder / PC / DVI PC / DVI Devices / TV / IPTV / Blu-ray / HD DVD / DMA

To associate a device name to an input source follow these steps:

1. Select **Tools** in the upper right corner of the source screen.
2. Select **Edit Name**.
3. Find the input source you want in the **Source** list (HDMI1, HDMI2, Component, etc.).
4. Select the blank field next to the input.
5. In the device name list that appears, select the name of the device attached to the input.

When you view the Source list, the device name and the input jack will be displayed together.

- If you have connected a PC to the **HDMI IN 3 (DVI)** port with an HDMI cable, select **PC** from the device name list.
- If you have connected a PC to the **HDMI IN 3 (DVI)** port with an HDMI to DVI cable, select **DVI PC** from the device name list.
- If you connected an AV device to the **HDMI IN 3 (DVI)** port with an HDMI to DVI cable, select **DVI Devices** from the device name list.
- **Information:** View detailed information about the connected devices.
- **Refresh:** Select if a connected device does not appear in the list. If the list does not show the device after selecting **Refresh**, check the status of the TV-to-device connection.
- **Remove USB:** Remove the USB device from the list safely. This function is only available when the USB device selected.

Universal Remote Setup: Use to configure universal remote control settings. Using the universal remote control, you can control external devices connected to the TV, such as a set-top box, Blu-ray player, and AV receiver.

Universal Remote Setup

This TV has a universal remote control feature that lets you control cable boxes, Blu-ray players, home theaters, and other third-party external devices connected to the TV using the TV's remote control.

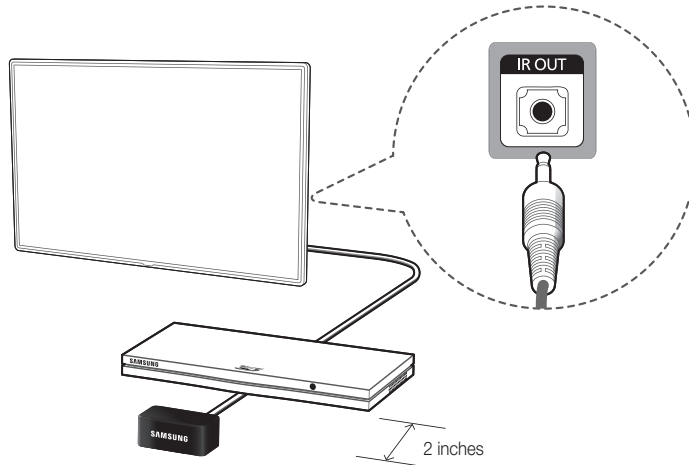



Keep a distance of 2 inches at least between the IR Extender and the external device, as the illustration shows. Face the IR Extender toward the external device's remote control signal receiver. Note that it should be no obstacle between IR Extender and external device. The presence of an obstacle will interfere with the transmission of the remote control signal.

Add the External Device

1. Turn on the external device you wish to set up universal remote function for and then press the **SOURCE** to bring up the **Source** screen.
2. Select **Universal Remote Setup** from the top of the screen. This initiates the universal remote setup process.
3. Follow the on-screen instruction and set up the universal remote control. If it does not work, set up the remote control by entering the model number manually.





Viewing the e-Manual

This TV has a built-in e-Manual that contains information about your TV's key features and instructions for using them. To view the e-Manual, use one of the following methods:

- Open the **Support** menu and choose **e-Manual (Troubleshooting)**.
 - Press the **MORE** button on the Smart Touch Control to display the virtual remote panel on the TV screen. Flick the touch pad until the quick access panel appears, select the **e-Manual** icon, and then press the touch pad.
-  In the e-Manual, words in blue refer to screen menu options and words in light blue refer to remote control buttons.
-  A printable version of this guide is also available at www.samsung.com/support.

Scrolling a Page

To scroll a page, use one of the following methods:

- Place the focus on the  or  button at the right edge of the screen, and then press the touch pad.
- Drag or flick up or down the line on either the left or right edge of the touch pad.
- Place the focus on the  or  button at the right edge of the screen, drag or flick up or down on the touch pad.

Using the Top Icons



Use the **Back**, **Forward**, and **Opened pages** icons on the top left of the screen to navigate through pages. These icons are available after you have viewed two or more pages.

Returning to the Home Page



To return to the home page, select the  button or select  on the top right of the screen.

-  To select a letter button (**A**, **B**, **C**, **D**), press the **MORE** button on the Smart Touch Control to display the virtual remote panel on the TV screen. Flick the touch pad until the playback control panel appears, select the **A** button, and then press the touch pad.

Searching the Index

Select the  button or select  on the top right of the screen to display the index. Select a term to display the page containing the term.

Searching Pages

Select the  button or select  on the top right of the screen, and enter search criteria. Select a page from the list of search results to display it.

Closing the e-Manual

To close the e-Manual, press and hold the **RETURN** button or select  at the upper-right corner of the screen.

Jumping to a Menu Item

To jump directly to the menu item that is described in the current section, select . It is possible to jump from a menu item directly to the related section in the e-Manual. On a menu screen, press the **MORE** button on the Smart Touch Control and then select **e-Manual** on the virtual remote panel that appears on the screen.

 This feature may not be available, depending on the menu.

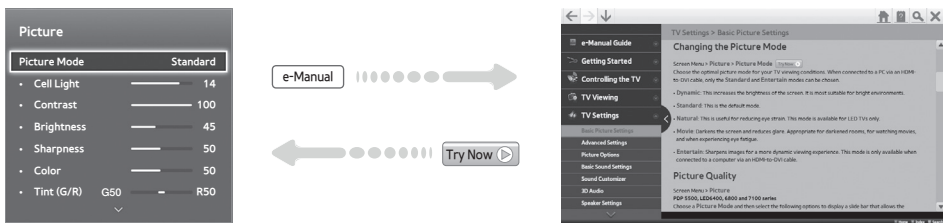

Updating the e-Manual

Press the  button and select **Apps**, and then select **More Apps**. The e-Manual can be updated in the same way with an application update.

On the **More Apps** screen, select **Update Apps**, and then select e-Manual from the list. The e-Manual starts updating to the latest version. However, **Update Apps** appears on the screen only when the update is required.

Connecting to a Network

Connecting the TV to a network gives you access to online services such as Smart Hub and lets you update the TV's software online directly from Samsung.com.

Network Connection - Wireless

Connect the TV to the Internet using a standard wireless router or modem.

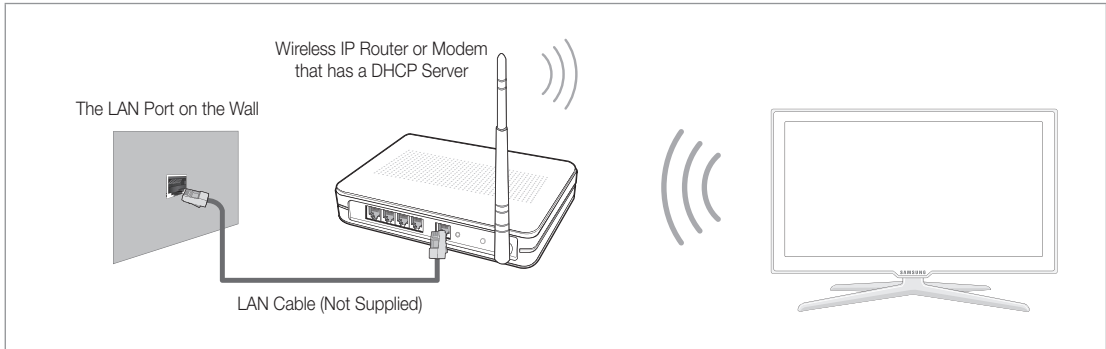

Wireless Network Precautions

- This TV supports the IEEE 802.11a/b/g/n communication protocols. Samsung recommends using IEEE 802.11n. Otherwise, when you play video over a network connection, the video may not play smoothly.
- To use a wireless network, the TV must be connected to a wireless router or modem. If the wireless router supports DHCP, the TV can use a DHCP or static IP address to connect to the wireless network.
- Select a channel that is not currently in use for the wireless router. If the channel set for the wireless router is currently being used by another device, the result is usually interference and/or a communications failure.
- Most wireless networks have an optional security system. To enable a wireless network's security system, you need to create a security key using characters and numbers, and then enter that key into the router through its menu. You then must enter this security key into any other devices you want to connect to the wireless network.

Network Security Protocols

The TV only supports the following wireless network security protocols:

- Authentication Modes: WEP, WPAPSK, WPA2PSK
- Encryption Types: WEP, TKIP, AES

In compliance with the newest Wi-Fi certification specifications, Samsung TVs do not support WEP or TKIP security encryption in networks running in the 802.11n mode.

If the wireless router supports WPS (Wi-Fi Protected Setup), you can connect the TV to your network using PBC (Push Button Configuration) or a PIN (Personal Identification Number). WPS automatically configures the SSID and WPA key settings.

Your Smart TV cannot connect to uncertified wireless routers.

Network Connection - Wired

There are three main ways to connect your TV to your network using cable, depending on your network setup. They are illustrated below:

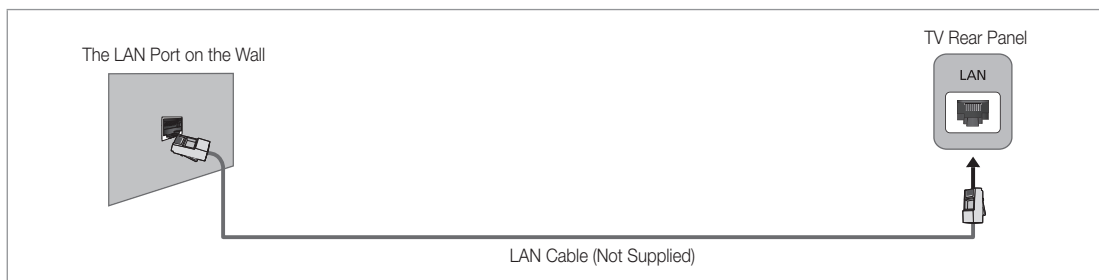
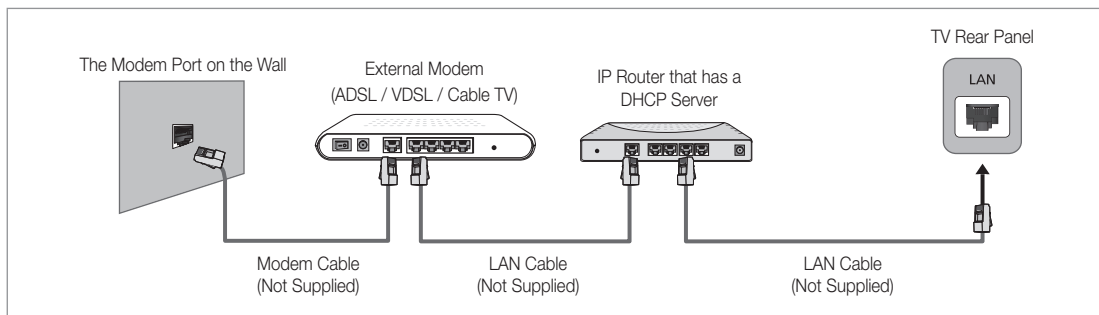
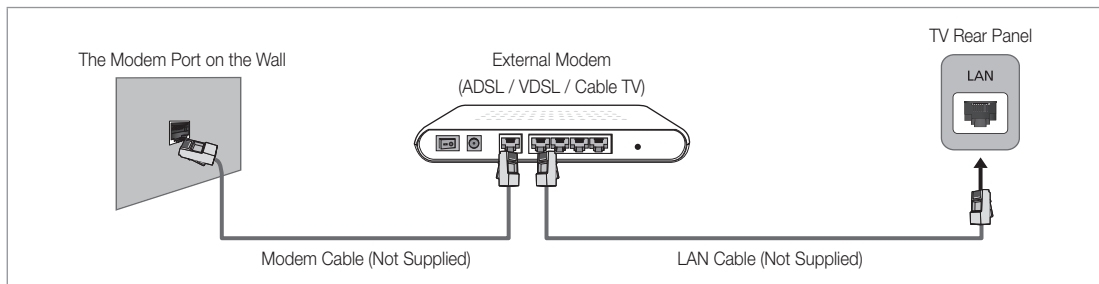

- 🔗 The TV does not support network speeds less than or equal to 10Mbps.
- 🔗 Use Cat 7 cable for the connection.

3D Active Glasses

Features

Samsung's SSG-5100GB 3D glasses enable you to view 3D images on your 3D TV. The Samsung 3D glasses communicate with Samsung 3D TVs via the 2.4GHz RF band.

- ✎ The Samsung 3D glasses are only compatible with Samsung D, E, and F series 3D TV's that were released in 2011, 2012, and 2013. These 3D glasses cannot be connected to other Bluetooth devices.

Parts

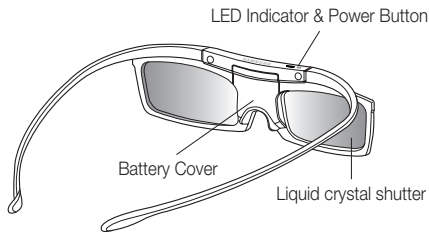

- ✎ For details on how to attach the glasses' temples, refer to the separate 3D glasses manual.

For details on how to pair the glasses with the TV, refer to the separate 3D glasses manual or to page 14 in this manual.

Replacing the Battery

If the red LED blinks every two seconds continually, replace the battery with a new one.

- ✎ Insert the "+" side of the battery into the side marked with "+" in the battery compartment.
- ✎ To check the remaining battery capacity, refer to the pairing section in this manual.

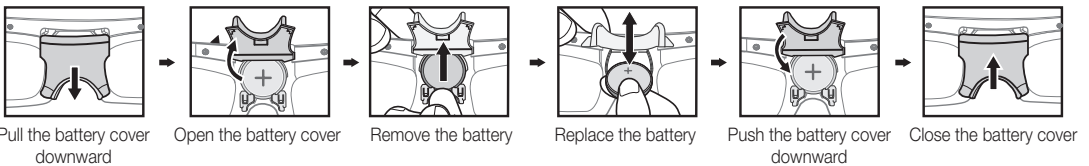

Pairing 3D Active Glasses

- ✎ What is Pairing? Pairing is the process of connecting 3D glasses and a 3D TV so that the two devices can exchange data.
- ✎ Ensure your Samsung TV and 3D glasses are no farther than 19.5 in (50 cm) apart from each other while pairing is in progress.

- **Turning the glasses on**

Press the power button briefly. The green LED turns on for 3 seconds. (Make sure that 3D is activated on the TV before using the 3D glasses.)

- **Turning the glasses off**

Press the power button briefly. The red LED turns on for 3 seconds.

- **Performing the pairing process**

Turn the TV on and let it power up completely. Press and hold the Power button on the glasses. The green and the red LEDs blink alternately for 2 seconds.

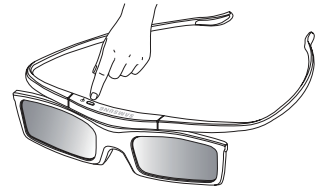

- **Operating range**

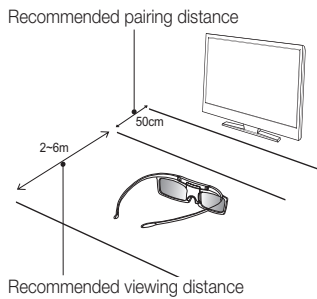

Recommended viewing distance	Recommended pairing distance
2-6m (6.5 to 19.5 ft)	50 cm or less (19.5 in)

- ✎ Once the 3D glasses are paired, the remaining battery capacity is displayed on the TV screen. (This feature only applies to Samsung F series 3D TVs and 3D glasses that have been available since 2013.)
- ✎ If you keep trying to pair the glasses and the TV after pairing has failed, the battery level will decrease significantly. However, the battery level will recover to a certain degree in about a minute.
- ✎ The working distance is affected by the presence of obstacles (a person, metal, walls, etc.) between the glasses and the TV and the strength of the Bluetooth signal.
- ✎ Turn off the 3D glasses when they are not in use. If you leave the 3D glasses on, the battery lifespan decreases.

Pairing steps

1. Turn on the TV, and then move the glasses within 19.5 inches of the TV.
2. Press the power button on the 3D glasses briefly. The 3D glasses will power on and pairing will start.
3. The message “3D glasses are connected to TV.” will be displayed on the TV screen when the pairing is successfully completed.
 - If pairing fails, the 3D glasses will power off.
 - If the first attempt to pair fails, power the TV off and on again and perform step 2.
 - How to pair again: Press the power button on the 3D glasses for more than 1 second.

You must pair the glasses again in the following situations:

- If the 3D glasses do not function, even when the power button is pressed, especially if the TV has just been repaired.
- If you want to play 3D content on another Samsung 3D TV model that belongs to the D, E, or F series released in 2011 through 2013. You must pair the glasses with the other TV.

Watching 3D Video

Some 3D modes may not be available depending on the format of the image source.

To watch in 3D, you must wear 3D Active Glasses and turn the glasses on by pressing the power button.

1. Go to the 3D screen. (**Picture > 3D**)
2. Select the 3D Mode. The 3D Mode screen appears.
3. Set the 3D Mode of the image you want to view.

Troubleshooting

If you encounter...	Try this...
My 3D glasses do not work.	<p>Replace the battery.</p> <p>The 3D glasses should be close to the TV. Make sure that the distance between the TV and your 3D glasses is less than 19.5 feet (6m) in a straight line.</p> <p>Check the 3D function settings of your TV.</p>
The LED keeps blinking	The battery is dead. Replace the battery.

Specifications (Model Number: SSG-5100GB)

Optics	Shutters	Liquid crystal	Transmittance	36±2%
	Recommended operating distance	2 ~ 6m (6.5 to 19.5 ft)	Field Rate	120 fields/second
Weight	Glasses	21.5g/.76 oz. (including the battery: 24.0±0.5g/.85±.018oz.)		
Power	Glasses	One 3V lithium/manganese dioxide battery 3V (CR2025)		
Power consumption	Glasses	0.85mA (Average)		
	Battery	Type	165mAh, 3.0V (CR2025)	
Operating time		150 hours		
Operating conditions	Operating temperature	50 °F ~ 104 °F (10°C ~ 40°C)		
	Custody temperature	-4 °F ~ 113 °F (-20°C ~ 45°C)		

 Product specifications may be changed without notice in order to enhance product performance.

 The continuous operating time may differ depending on the wireless communication environment and usage conditions.

What is Remote Support?

Samsung Remote Support service offers you one-on-one support with a Samsung Technician who can remotely.

- **Diagnose** your TV
- **Adjust the TV settings** for you
- **Perform a factory reset** on your TV
- Install recommended **firmware updates**

How Does it Work?

Having a Samsung Tech remotely service your TV is easy.



1. **Call the Samsung Contact Center** and ask for remote support.



2. **Open the menu** on your TV and go to the **Support section**.



3. Select Remote Management and **Provide the Pin#** to the agent.





4. The agent will then **access your TV**. That's it!

Troubleshooting

If the TV seems to have a problem, first review this list of possible problems and solutions. Also, review the Troubleshooting Section in the e-Manual. If none of the troubleshooting tips apply, visit www.samsung.com/support or call Samsung Customer Service at 1-800-SAMSUNG (1-800-726-7864).

Issues	Solutions and Explanations
Flickering and Dimming	If your Samsung Television is flickering or dimming sporadically, you may need to disable some of the energy efficiency features. Disable Energy Saving (System > Eco Solution > Eco Sensor) and/or Energy Saving (System > Eco Solution > Energy Saving) and check again.
Component Connections /Screen Color	If you find that the color on your Samsung television screen is not correct or the black and white colors are off, run a Self Diagnosis Picture Test (Support > Self Diagnosis > Picture Test). If the picture problem is caused by the TV, the problem should be visible in the Picture Test. If the problem is not visible, next confirm that the TV's video input jacks are connected to the correct external video device output jacks and that none of the connections are loose. Finally, if possible, test your external video devices by connecting them to another TV.
Screen Brightness	If you find that the colors on your Samsung TV are correct but just a little too dark or bright, try adjusting the following settings first. Navigate to Picture and adjust Cell Light, Contrast, Brightness, Sharpness, Color, Tint (G/R) and other picture quality adjustment settings.
Unwanted Powering Off	If your Samsung TV appears to turn off by itself, try disabling some of the TV's energy efficiency and automatic off features. Check if Sleep Timer (System > Time > Sleep Timer) has been enabled. Sleep Timer automatically turns off the TV after an amount of time that you select. If the Sleep Timer has not been enabled, see if No Signal Power Off (System > Eco Solution > No Signal Power Off) or Auto Power Off (System > Eco Solution > Auto Power Off) has been enabled. No Signal Power Off turns off the TV if no signal has been received by the TV for a specified period time. Auto Power Off turns off the TV if there has been no user input in four hours.
Trouble Powering On	When the TV is turned on, the remote control receiver flashes 5 times before the screen turns on. If you find that you are having problems powering on your Samsung television, there are a number of things to check before calling the service department. If the power cord is connected properly and the remote control is operating normally, the problem might be with the antenna cable connection or the cable/satellite box not being turned on. Check the antenna connection or turn on the cable/satellite box.
Stand Assembly	If you have any trouble assembling the stand, review the stand assembly instruction in the Quick Start Guide.
Cannot Find a Channel	Re-run Setup (Go to Menu > System > Setup) or run Auto Program . (Go to Menu > Broadcasting > Auto Program).

 For detailed troubleshooting information, watch the troubleshooting videos at www.samsung.com/spsn.

Issues	Solutions and Explanations
The TV won't turn on.	<ul style="list-style-type: none"> • Make sure the AC power cord is securely plugged in to the wall outlet and the TV. • Make sure the wall outlet is working. • Try pressing the  button on the TV to make sure the problem is not the remote. If the TV turns on, refer to "Remote control does not work" below.
There is no picture/video.	<ul style="list-style-type: none"> • Check the cable connections. Remove and reconnect all cables connected to the TV and external devices. • Set the video outputs of your external devices (Cable/Sat Box, DVD, Blu-ray etc) to match the TV's input connections. For example, if an external device's output is HDMI, it should be connected to an HDMI input on the TV. • Make sure your connected devices are powered on. • Be sure to select the correct input source. • Reboot the connected device by unplugging it, and then reconnecting the device's power cable.
The remote control does not work.	<ul style="list-style-type: none"> • Replace the remote control batteries. Make sure the batteries are installed with their poles (+/-) in the correct direction. • Clean the sensor's transmission window on the remote. • Try pointing the remote directly at the TV from 5-6 feet away.
The cable/set top box remote control doesn't turn the TV on or off or adjust the volume.	<ul style="list-style-type: none"> • Program the Cable/Set remote control to operate the TV. Refer to the Cable/Set-Top-Box user manual for the SAMSUNG TV code.

 Some functions and pictures shown in this manual are available on specific models only.

 To keep your TV in optimum condition, upgrade to the latest software. Use the Update Now or Auto Update functions on the TV's menu (Screen Menu > **Support** > **Software Update** > **Update now** or Screen Menu > **Support** > **Software Update** > **Auto Update**).

Mounting the TV on the Wall Using the Wall Mount Kit (Optional)



Wall or Ceiling Mounting

If you mount this product on a wall, it should be mounted only as recommended by the manufacturer. Unless it is correctly mounted, the product may slide or fall, causing serious injury to a child or adult, and serious damage to the product.

Installing the Wall Mount Kit

The wall mount kit (sold separately) lets you mount the TV on the wall.

For detailed information about installing the wall mount, see the instructions provided with the wall mount. We recommend you contact a technician for assistance when installing the wall mount bracket. We do not advise you to do it yourself. Samsung Electronics is not responsible for any damage to the product or injury to yourself or others if you select to install the wall mount on your own.

To order the wall mount kit, contact Samsung Customer Care at 1-800-SAMSUNG (1-800-726-7864).

Installing a Wall Mount using the Wall mount adapter

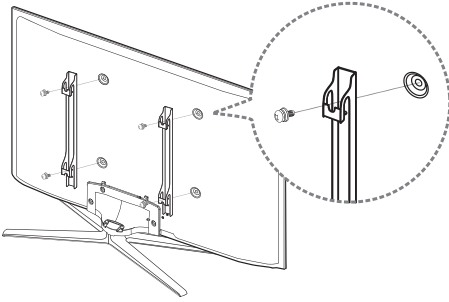

- ✎ For more detailed information, refer to the User Manual of the Wall Mount Kit.
- ✎ Wall mount adapters are provided only with 46-inch or bigger TVs.

VESA Wall Mount Kit Notes and Specifications

✎ Install your wall mount on a solid wall perpendicular to the floor. Before attaching the wall mount to surfaces other than plaster board, please contact your nearest dealer for additional information. If you install the TV on a ceiling or slanted wall, it may fall and result in severe personal injury.

NOTE

- Standard dimensions for wall mount kits are shown in the table below.
- Samsung wall mount kits contain a detailed installation manual, and all parts necessary for assembly are provided.
- Do not use screws that do not comply with VESA standard screw specifications.
- Do not use screws that are longer than the standard length or do not comply with VESA standard screw specifications. Screws that are too long may cause damage to the inside of the TV set.
- For wall mounts that do not comply with the VESA standard screw specifications, the length of the screws may differ depending on the wall mount specifications.
- Do not fasten the screws too firmly. This may damage the product or cause the product to fall, leading to personal injury. Samsung is not liable for these kinds of accidents.
- Samsung is not liable for product damage or personal injury when a non-VESA or non-specified wall mount is used or the consumer fails to follow the product installation instructions.
- Do not mount the TV at more than a 15 degree tilt.
- Always have two people mount the TV on to a wall.

Product Family	TV size in inches	VESA screw hole specs (A * B) in millimeters	Standard Screw	Quantity
PDP TV	43 - 51	400 X 400	M8	4
	60 - 64	600 X 400		

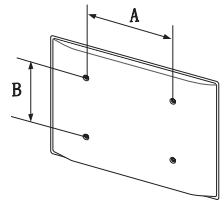

Do not install your Wall Mount Kit while your TV is turned on. It may result in personal injury from electric shock.

Assembling the Cable manager

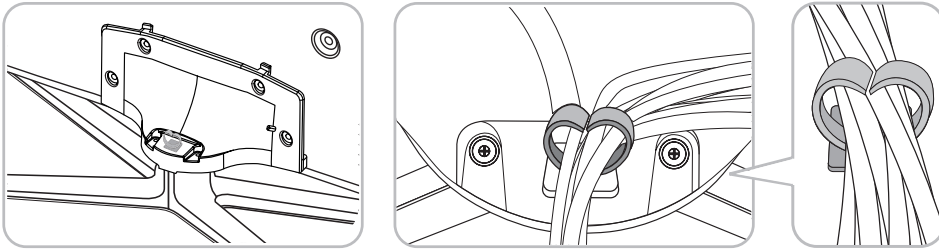

Eco Sensor and Screen Brightness



Eco Sensor measures the light in your room and optimizes the brightness of the TV automatically to reduce power consumption. This causes the TV to brighten and dim automatically. If you want to turn this function off, go to **Menu > System > Eco Solution > Eco Sensor**



Do not block the sensor with any material. It can decrease picture brightness.

Maintenance

- ✎ If a sticker was attached to the TV screen, some debris can remain after you remove the sticker. Please clean the debris off before watching TV.
- ✎ The exterior and screen of the product can get scratched during cleaning. Be sure to wipe the exterior and screen carefully using the cloth provided or a soft cloth to prevent scratches.

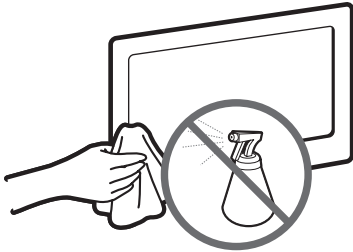

Do not spray water directly onto the product. Any liquid that goes into the product may cause a failure, fire, or electric shock.

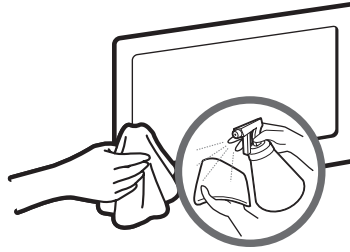

Clean the product with a soft cloth dampened with a small amount of water. Do not use a flammable liquid (e.g. benzene, thinners) or a cleaning agent.

Providing Proper Ventilation for Your TV

When you install your TV, maintain a distance of at least 4 inches between the TV and other objects (walls, cabinet sides, etc.) to ensure proper ventilation. Failing to maintain proper ventilation may result in a fire or a problem with the product caused by an increase in its internal temperature.

- ✎ Whether you install your TV using a stand or a wall-mount, we strongly recommend you use parts provided by Samsung Electronics only.
 - If you use parts provided by another manufacturer, it may cause difficulties with the product or result in injury caused by the product falling.



Other Warnings

- ✎ The actual appearance of the TV may differ from the images in this manual, depending on the model.
- ✎ Be careful when you touch the TV. Some parts can be warm or hot.

Securing the TV to the Wall



Caution: Pulling, pushing, or climbing on the TV may cause the TV to fall. In particular, ensure your children do not hang on or destabilize the TV. Doing so may cause the TV to tip over, causing serious injuries or death. Follow all safety precautions provided in the Safety Flyer included with your TV. For added stability and safety, you can purchase and install the anti-fall device as described below.



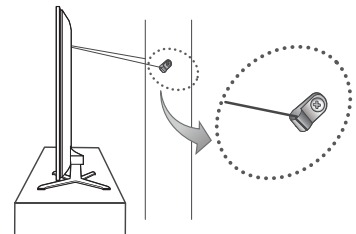
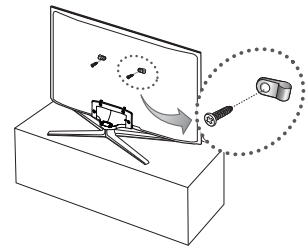

To Avoid the TV from Falling

1. Put the screws into the clamps and firmly fasten them onto the wall. Confirm that the screws have been firmly installed onto the wall.
 - 🔧 You may need additional material such as an anchor depending on the type of wall.
 - 🔧 Since the necessary clamps, screws, and string are not supplied, please purchase these additionally.
2. Remove the screws from the back center of the TV, put the screws into the clamps, and then fasten the screws onto the TV again.
 - 🔧 Screws may not be supplied with the product. In this case, please purchase the screws of the following specifications.
 - 🔧 Screw Specifications
 - For a 43 - 64 inches: M8
3. Connect the clamps fixed onto the TV and the clamps fixed onto the wall with a strong cable and then tie the string tightly.
 - 🔧 **NOTE**
 - Install the TV near to the wall so that it does not fall backwards.
 - It is safe to connect the string so that the clamps fixed on the wall are equal to or lower than the clamps fixed on the TV.
 - Untie the string before moving the TV.
4. Verify all connections are properly secured. Periodically check the connections for any sign of fatigue or failure. If you have any doubt about the security of your connections, contact a professional installer.



Specifications

Environmental Considerations	50°F to 104°F (10°C to 40°C)	
Operating Temperature	10% to 80%, non-condensing	
Operating Humidity	-4°F to 113°F (-20°C to 45°C)	
Storage Temperature	5% to 95%, non-condensing	
Storage Humidity	-20° ~ 20°	
Stand Swivel (Left / Right)		
Model Name	PN51F5500	PN60F5500
Screen Size (Diagonal)	51" Class (50.6 measured diagonally)	60" Class (59.9 measured diagonally)
Sound (Output)	10W x 2	
Dimensions (W x H x D)		
Body	46.9 x 27.9 x 2.2 inches (1191.9 x 709.1 x 57.0 mm)	54.9 x 32.7 x 2.2 inches (1396.9 x 831.3 x 57.0 mm)
With stand	46.9 x 31.4 x 12.0 inches (1191.9 x 798.8 x 307.2 mm)	54.9 x 36.5 x 14.7 inches (1396.9 x 928 x 375.5 mm)
Weight		
Without Stand	40.7 lbs (18.5 kg)	60.6 lbs (27.5 kg)
With Stand	44.7 lbs (20.3 kg)	66.3 lbs (30.1 kg)
Display Resolution	1920 x 1080	1920 x 1080 (Black & White)
Model Name	PN64F5500	
Screen Size (Diagonal)	64" Class (64.0 measured diagonally)	
Sound (Output)	10W x 2	
Dimensions (W x H x D)		
Body	58.4 x 34.5 x 2.2 inches (1483.8 x 877.1 x 57.0 mm)	
With stand	58.4 x 38.3 x 14.7 inches (1483.8 x 974.5 x 375.5 mm)	
Weight		
Without Stand	72.7 lbs (33.0 kg)	
With Stand	78.4 lbs (35.6 kg)	
Display Resolution	1920 x 1080	

-  Design and specifications are subject to change without prior notice.
-  The actual appearance of the TV may differ from the images in this manual, depending on the model.
-  This device is a Class B digital apparatus.
-  For information about the power supply, and more information about power consumption, refer to the label attached to the product.
-  Typical power consumption is measured according to Energy Star Program requirements for Televisions.

Dispose unwanted electronics through an approved recycler.

To find the nearest recycling location, go to our website:

www.samsung.com/recyclingdirect or call, (877) 278 - 0799

Standby mode

To decrease power consumption, unplug the power cord when you don't intend to use the TV for a long time.

Dimensions

- Jack panel detail / Rear view

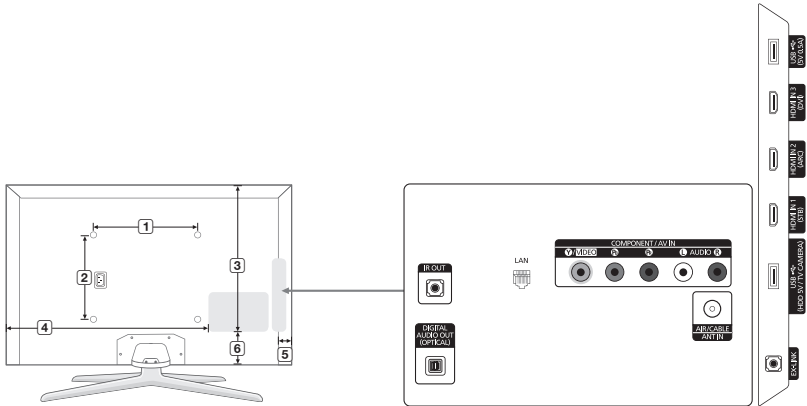

(Unit: inches)

The displayed image may differ depending on the model.

Model name	1	2	3	4	5	6	7
PN51F5500	15.7	15.7	19.5	35.0	1.4	3.1	5.0
PN60F5500	23.6	15.7	20.4	42.0	1.0	6.7	5.0
PN64F5500	23.6	15.7	21.8	42.8	1.7	6.9	5.0

NOTE: All drawings are not necessarily to scale. Some dimensions are subject to change without prior notice. Refer to the dimensions before installing your TV. Not responsible for typographical or printed errors.

© 2013 Samsung Electronics America, Inc

Licenses



Warranty Information

Federal Communication Commission Interference Statement

This equipment has been tested and found to comply with the limits for a Class B digital device, pursuant to Part 15 of the FCC Rules. These limits are designed to provide reasonable protection against harmful interference in a residential installation. This equipment generates, uses and can radiate radio frequency energy and, if not installed and used in accordance with the instructions, may cause harmful interference to radio communications. However, there is no guarantee that interference will not occur in a particular installation. If this equipment does cause harmful interference to radio or television reception, which can be determined by turning the equipment off and on, the user is encouraged to try to correct the interference by one of the following measures:

- Reorient or relocate the receiving antenna.
- Increase the separation between the equipment and receiver.
- Connect the equipment into an outlet on a circuit different from that to which the receiver is connected.
- Consult the dealer or an experienced radio/TV technician for help.

FCC Caution: Any changes or modifications not expressly approved by the party responsible for compliance could void the user's authority to operate this equipment.

This device complies with Part 15 of the FCC Rules. Operation is subject to the following two conditions: (1) This device may not cause harmful interference, and (2) this device must accept any interference received, including interference that may cause undesired operation.

For product available in the USA/Canada market, only channel 1~11 can be operated. Selection of other channels is not possible.

This device and its antenna(s) must not be co-located or operation in conjunction with any other antenna or transmitter.

FCC Radiation Exposure Statement:

This equipment complies with FCC radiation exposure limits set forth for an uncontrolled environment. This equipment should be installed and operated with minimum distance 20cm between the radiator & your body.

This Class B digital apparatus complies with Canadian ICES-003.

Cet appareil numérique de la classe B conforme à la norme NMB-003 du Canada.

This device complies with Industry Canada license-exempt RSS standard(s). Operation is subject to the following two conditions: (1) this device may not cause interference, and (2) this device must accept any interference, including interference that may cause undesired operation of the device.

Le présent appareil est conforme aux CNR d'Industrie Canada applicables aux appareils radio exempts de licence. L'exploitation est autorisée aux deux conditions suivantes: (1) l'appareil ne doit pas produire de brouillage, et (2) l'utilisateur de l'appareil doit accepter tout brouillage radioélectrique subi, même si le brouillage est susceptible d'en compromettre le fonctionnement.

For product available in the USA/Canada market, only channel 1~11 can be operated. Selection of other channels is not possible.

This device and its antenna(s) must not be co-located or operation in conjunction with any other antenna or transmitter.

Under Industry Canada regulations, this radio transmitter may only operate using an antenna of a type and maximum (or lesser) gain approved for the transmitter by Industry Canada. To reduce potential radio interference to other users, the antenna type and its gain should be so chosen that the equivalent isotropically radiated power (e.i.r.p.) is not more than that necessary for successful communication.

IC Radiation Exposure Statement:

This equipment complies with IC RSS-102 radiation exposure limits set forth for an uncontrolled environment. This equipment should be installed and operated with minimum distance 20cm between the radiator & your body.

IMPORTANT WARRANTY INFORMATION **REGARDING TELEVISION FORMAT** **VIEWING**

 See the warranty card for more information on warranty terms.

Wide screen format PDP Displays (with 16:9 aspect ratios, the ratio of the screen width to height) are primarily designed to view wide screen format full-motion video. The images displayed on them should primarily be in the wide screen, 16:9 ratio format, or expanded to fill the screen, if your model offers this feature, with the images constantly in motion. Displaying stationary graphics and images on the screen, such as the dark sidebars on non-expanded standard format television video and programming, should be limited to no more than 5% of the total television viewing time per week.

Additionally, viewing other stationary images and text such as stock market crawls, video game displays, station logos, web sites or computer graphics and patterns, should be limited as described above for all televisions. Displaying stationary images that exceed the above guidelines can cause uneven aging of PDP Displays that leave subtle, but permanent burned-in ghost images in the PDP picture. To avoid this, vary the programming and images, and primarily display full screen moving images, not stationary patterns or dark bars. On PDP models that offer picture sizing features, use these controls to view different formats as a full screen picture.

Be careful about the television formats you select and the length of time you view them. Uneven PDP aging as a result of format selection and use, as well as burned in images, are not covered by your Samsung limited warranty.

- **SAMSUNG ELECTRONICS NORTH AMERICAN LIMITED WARRANTY STATEMENT**

Subject to the requirements, conditions, exclusions and limitations of the original Limited Warranty supplied with Samsung Electronics (SAMSUNG) products, and the requirements, conditions, exclusions and limitations contained herein, SAMSUNG will additionally provide Warranty Repair Service in the United States on SAMSUNG products purchased in Canada, and in Canada on SAMSUNG products purchased in the United States, for the warranty period originally specified, and to the Original Purchaser only.

The above described warranty repairs must be performed by a SAMSUNG Authorized Service Center. Along with this Statement, the Original Limited Warranty Statement and a dated Bill of Sale as Proof of Purchase must be presented to the Service Center. Transportation to and from the Service Center is the responsibility of the purchaser. Conditions covered are limited only to manufacturing defects in material or workmanship, and only those encountered in normal use of the product.

Excluded, but not limited to, are any originally specified provisions for, in-home or on-site services, minimum or maximum repair times, exchanges or replacements, accessories, options, upgrades, or consumables.

For the location of a SAMSUNG Authorized Service Center, please call toll-free:

- In the United States: 1-800-SAMSUNG (1-800-726-7864)
- In Canada: 1-800-SAMSUNG

Still image warning

Avoid displaying still images (such as jpeg picture files), still image elements (such as TV channel logos, stock or news bars at the screen bottom etc.), or programs in panorama or 4:3 image format on the screen. Constantly displaying still pictures can cause image burn-in on the LED screen, which will affect image quality. To reduce risk of this effect, please follow the recommendations below:

- Avoid displaying the same TV channel for long periods.
- Always try to display any image in full screen. Use the TV set's picture format menu for the best possible match.
- Reduce brightness and contrast to avoid the appearance of after-images.
- Use all TV features designed to reduce image retention and screen burn. Refer to the e-Manual for details.

User Instructions

- Screen Image retention

Do not display a still image (such as on a video game) on the plasma display panel for more than several minutes as it can cause screen image retention. This image retention is also known as 'screen burn'. To avoid such image retention, refer to e-Manual to reduce the degree of brightness and contrast of the screen when displaying a still image.

- Heat on the top of the Plasma TV

The top side of the product may be hot after long periods of use as heat dissipates from the panel through the vent hole in the upper part of the product. This is normal and does not indicate any defect or operation failure of the product. However, children should be prevented from touching the upper part of the TV.

- The TV is making a 'cracking' noise.

A 'cracking' noise may occur when the product contracts or expands due to a change in the surrounding environment such as temperature or humidity. This is normal and not a defect of the unit.

- Cell Defects

Your plasma TV has a panel containing 2,360,000 (HD-level) to 6,221,000 (FHD-level) pixels which require sophisticated technology to produce. However, there may be a few bright or dark pixels on the screen. These pixels will have no impact on the performance of the product.

- Avoid operating the TV at temperatures below 41°F (5°C)

- A still image displayed too long may cause permanent damage to the PDP Panel.



Watching the Plasma TV in 4:3 format for a long period of time may leave traces of borders displayed on the left, right and center of the screen caused by the difference of light emission on the screen. Playing a DVD or a game console may cause similar effects to the screen. Damages caused by the above effect are not covered by the Warranty.

- After-images on the Screen.

Displaying still images from Video games or a PC for longer than a certain period of time may produce partial after-images.

To prevent this effect, reduce the 'brightness' and 'contrast' when displaying still images for a long time.

- Warranty

Warranty does not cover any damage caused by image retention. Burn-in is not covered by the warranty.

- Caution



The glass screen of your PDP TV can break if you accidentally drop the TV. Handle the TV with care.

When moving the TV, always have two or more people pick it up and carry it as a safety precaution. Do not lay the TV flat on its face or back.

Your Samsung Plasma TV is a high quality television that has been carefully packaged to protect the integrity of its glass panel and component parts during shipment. It is, nonetheless, a fragile piece of electronics that requires careful handling. Refrain from putting undue stress on any part of the packaging when shipping or unpacking the TV. Use care when installing the TV. Avoid placing the TV in a location where it may be struck, exposed to sharp impacts, or fall. Panel breakage caused by a fall or impact strike is not covered under the manufacturer's warranty.

Regulatory Compliance Statements (For 3D Active Glasses)

FCC COMPLIANCE

Federal Communication Commission Interference Statement

1. Changes or modifications not expressly approved by the party responsible for compliance could void the user's authority to operate the equipment.
2. **NOTE:** This equipment has been tested and found to comply with the limits for a Class B digital device, pursuant to Part 15 of the FCC Rules. These limits are designed to provide reasonable protection against harmful interference in a residential installation. This equipment generates, uses and can radiate radio frequency energy and, if not installed and used in accordance with the instructions, may cause harmful interference to radio communications. However, there is no guarantee that interference will not occur in a particular installation. If this equipment does cause harmful interference to radio or television reception, which can be determined by turning the equipment off and on, the user is encouraged to try to correct the interference by one or more of the following measures:
 - Reorient or relocate the receiving antenna.
 - Increase the separation between the equipment and receiver.
 - Connect the equipment to an outlet on a circuit different from that to which the receiver is connected.
 - Consult the dealer or an experienced radio/TV technician for help.

FCC Caution: Any changes or modifications not expressly approved by the party responsible for compliance could void the user's authority to operate this equipment.

This device complies with Part 15 of the FCC Rules. Operation is subject to the following two conditions: (1) This device may not cause harmful interference, and (2) this device must accept any interference received, including interference that may cause undesired operation.

CALIFORNIA USA ONLY

This perchlorate warning applies only to primary CR
(Manganese Dioxide)

Lithium coin cells in the product sold or distributed ONLY in California USA

" Perchlorate Material - special handling may apply,
See www.dtsc.ca.gov/hazardouswaste/perchlorate."

SAMSUNG BRAND PRODUCTS

LIMITED WARRANTY TO ORIGINAL PURCHASER

This SAMSUNG brand product, as supplied and distributed by SAMSUNG and delivered new, in the original carton to the original consumer purchaser, is warranted by SAMSUNG against manufacturing defects in materials and workmanship for a limited warranty period of 90 Days Parts and Labor for Commercial Use

Categories	Parts	Labor	Size	Service
LCD/LED TV	1 Year	1 Year	40" and Larger	Carry-In or In Home
			37" and Smaller	Carry-In
Plasma Display	1 Year	1 Year	All	Carry-In or In Home
Projector (Excluding Lamp **)	2 Year	2 Year	All	Carry-In or Pick up
PICO & LED Pocket Projector	1 Year	1 Year	All	Carry-In or Pick up

** 180 Days after Purchasing and 600 Hours of Use Lamp on Projector

This limited warranty begins on the original date of purchase, and is valid only on products purchased and used in the United States. To receive warranty service, the purchaser must contact SAMSUNG for problem determination and service procedures. Warranty service can only be performed by a SAMSUNG authorized service center. The original dated bill of sale must be presented upon request as proof of purchase to SAMSUNG or SAMSUNG's authorized service center.

SAMSUNG will repair or replace this product, at our option and at no charge as stipulated herein, with new or reconditioned parts or products if found to be defective during the limited warranty period specified above. All replaced parts and products become the property of SAMSUNG and must be returned to SAMSUNG. Replacement parts and products assume the remaining original warranty, or ninety (90) days, whichever is longer.

Certain products are eligible for In-home service at Samsung's discretion. To receive in-home service, the product must be unobstructed and accessible to service personnel. If during in-home service, repair cannot be completed, it may be necessary to remove, repair and return the product. If in-home service is unavailable, SAMSUNG may elect, at our option, to provide for transportation of our choice to and from a SAMSUNG authorized service center. Otherwise, and for 37" and smaller LCD/LED TV, transportation to and from the SAMSUNG authorized service center is the responsibility of the purchaser.

This limited warranty covers manufacturing defects in materials and workmanship encountered in normal, and except to the extent otherwise expressly provided for in this statement, noncommercial use of this product, and shall not apply to the following, including, but not limited to: damage which occurs in shipment; delivery and installation; applications and uses for which this product was not intended; altered product or serial numbers; cosmetic damage or exterior finishes; accidents, abuse, neglect, fire, water, lightning or other acts of nature; use of products, equipment, systems, utilities, services, parts, supplies, accessories, applications, installations, repairs, external wiring or connectors not supplied or authorized by SAMSUNG which damage this product or result in service problems; incorrect electrical line voltage, fluctuations and surges; customer adjustments and failure to follow operating instructions, cleaning, maintenance and environmental instructions that are covered and prescribed in the instruction book; reception problems and distortion related to noise, echo, interference or other signal transmission and delivery problems; brightness related to normal aging, or burned-in images. SAMSUNG does not warrant uninterrupted or error-free operation of the product.

THERE ARE NO EXPRESS WARRANTIES OTHER THAN THOSE LISTED AND DESCRIBED ABOVE, AND NO WARRANTIES WHETHER EXPRESS OR IMPLIED, INCLUDING, BUT NOT LIMITED TO, ANY IMPLIED WARRANTIES OF MERCHANTABILITY OR FITNESS FOR A PARTICULAR PURPOSE, SHALL APPLY AFTER THE EXPRESS WARRANTY PERIODS STATED ABOVE, AND NO OTHER EXPRESS WARRANTY OR GUARANTY GIVEN BY ANY PERSON, FIRM OR CORPORATION WITH RESPECT TO THIS PRODUCT SHALL BE BINDING ON SAMSUNG. SAMSUNG SHALL NOT BE LIABLE FOR LOSS OF REVENUE OR PROFITS, FAILURE TO REALIZE SAVINGS OR OTHER BENEFITS, OR ANY OTHER SPECIAL, INCIDENTAL OR CONSEQUENTIAL DAMAGES CAUSED BY THE USE, MISUSE OR INABILITY TO USE THIS PRODUCT, REGARDLESS OF THE LEGAL THEORY ON WHICH THE CLAIM IS BASED, AND EVEN IF SAMSUNG HAS BEEN ADVISED OF THE POSSIBILITY OF SUCH DAMAGES. NOR SHALL RECOVERY OF ANY KIND AGAINST SAMSUNG BE GREATER IN AMOUNT THAN THE PURCHASE PRICE OF THE PRODUCT SOLD BY SAMSUNG AND CAUSING THE ALLEGED DAMAGE. WITHOUT LIMITING THE FOREGOING, PURCHASER ASSUMES ALL RISK AND LIABILITY FOR LOSS, DAMAGE OR INJURY TO PURCHASER AND PURCHASER'S PROPERTY AND TO OTHERS AND THEIR PROPERTY ARISING OUT OF THE USE, MISUSE OR INABILITY TO USE THIS PRODUCT SOLD BY SAMSUNG NOT CAUSED DIRECTLY BY THE NEGLIGENCE OF SAMSUNG. THIS LIMITED WARRANTY SHALL NOT EXTEND TO ANYONE OTHER THAN THE ORIGINAL PURCHASER OF THIS PRODUCT, IS NONTRANSFERABLE AND STATES YOUR EXCLUSIVE REMEDY.

Some states do not allow limitations on how long an implied warranty lasts, or the exclusion or limitation of incidental or consequential damages, so the above limitations or exclusions may not apply to you. This warranty gives you specific legal rights, and you may also have other rights which vary from state to state.

To obtain warranty service, please contact SAMSUNG at:

Samsung Electronics America, Inc.

85 Challenger Road

Ridgefield Park, NJ 07660-2112

1-800-SAMSUNG (7267864) – www.samsung.com

1-800-749-0260: Projectors only