

A solid green vertical bar is positioned on the left side of the page, partially overlapping the text area.

User Manual

17" LCD Combo Console

GCL1800

PART NO. M1122-c

©2019 IOGEAR. All Rights Reserved. Part No. M1122-c

IOGEAR, the IOGEAR logo, MiniView®, VSE are trademarks or registered trademarks of IOGEAR. Microsoft and Windows are registered trademarks of Microsoft Corporation. IBM is a registered trademark of International Business Machines, Inc. Macintosh, G3/G4 and iMac are registered trademarks of Apple Computer, Inc. IOGEAR makes no warranty of any kind with regards to the information presented in this document. All information furnished here is for informational purposes only and is subject to change without notice. IOGEAR assumes no responsibility for any inaccuracies or errors that may appear in this document.

Table of Contents

Package Contents	4	Keyboard Function Keys	25
System Requirements	5	Hotkey Commands	26
Overview	6	Mac Keyboard Emulation	27
Rack Mounting	8	Sun Keyboard Emulation	28
Grounding	11	Firmware Upgrade	29
Open/Close Console	12	Upgrade Fail	33
Installation	14	Safety Instructions	34
Connect to a KVM	17	Specifications	38
External Console Ports (Optional)	20	EMC Information	39
USB External Mouse Port (Optional)	21	SJ/T 11364-2006	41
LCD Configuration	22	Limited Warranty	42
LCD Adjustment Setting	23	Contact	43
Reset Button	24		

Package Contents

- 1 x 17" LCD Console
- 1 x USB KVM Cable
- 1 x Firmware Upgrade Cable
- 1 x Rack Mount Kit (Long and Short L Brackets)
- 1 x Grounding Wire
- 1 x Power Cord
- 1 x Installation Guide
- 1 x Warranty Card

System Requirements

Computers

- VGA, SVGA, or MultiSync video graphics card with an HDB-15 port
- PS/2 mouse and keyboard ports (6-pin mini DIN) or 1 USB port

Overview

1. Slide Release
2. Handle Bar
3. LCD Display
4. LCD Power Button
5. LCD Controls
6. Keyboard
7. Touchpad
8. External USB Mouse Port
9. Power LED
10. Num Lock/Caps Lock/Scroll Lock LED
11. Reset Button
12. Firmware Upgrade Recovery Switch
13. Firmware Upgrade Port

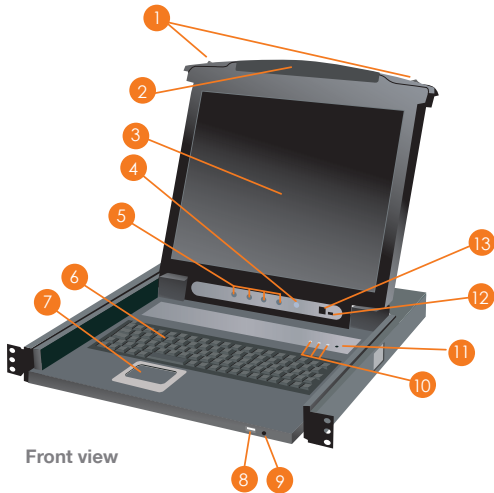

Front view

1. Grounding Terminal
2. Power Socket
3. Power Switch
4. External USB Mouse Port
5. External USB Keyboard Port
6. External PS/2 Mouse Port
7. External PS/2 Keyboard Port
8. External VGA Port
9. CPU Port

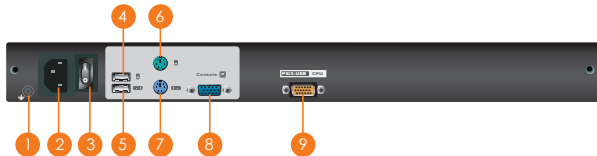

Back view

Rack Mounting

The following diagram shows the required components to mount the LCD Console to the rack.



CAUTION: Slide/rail mounted equipment is not to be used as a shelf or a work space.

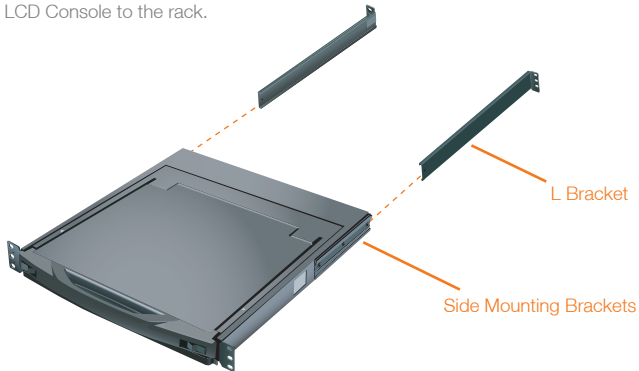

Note: The Slide Mounting Brackets are pre-installed onto the LCD Console.

Step 1

While one person holding the LCD Console in the proper position in the rack, the second person can lock the screws loosely through the front bracket onto the front of the rack.

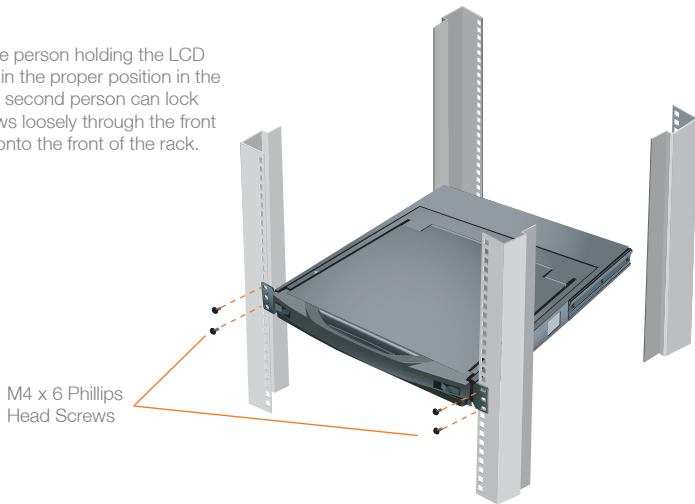

Step 2

While the person continue holding the position of the LCD Console, the second person can slide the L brackets from the back of the rack into the Slide Mounting Brackets. Then, you can lock the screws through the rear bracket onto the back of the rack.

Final Step

After the rear brackets are completely secured, tighten the front brackets' screws.

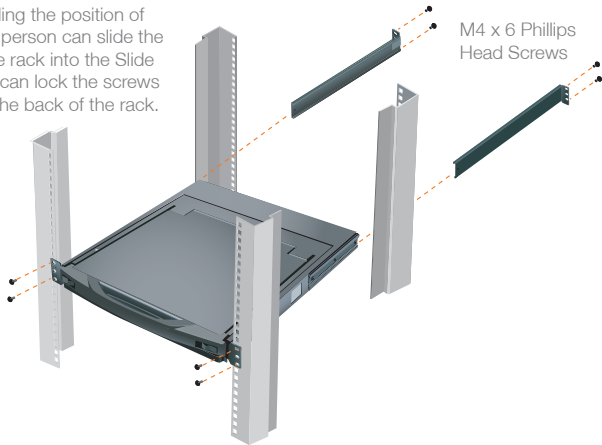

Grounding

To prevent damaging your equipment, it is important that all devices are properly grounded. Use the included grounding wire to ground the LCD Console by connecting one end of the wire to the grounding terminal, and the other end of the wire to a suitable grounded object.



Open/Close Console

Opening the Console

Slide the 2 Slide Releases toward the center of the LCD Console, then pull the console module out while holding the Slide Releases' position. Then simply open the console by raising the handle bar.

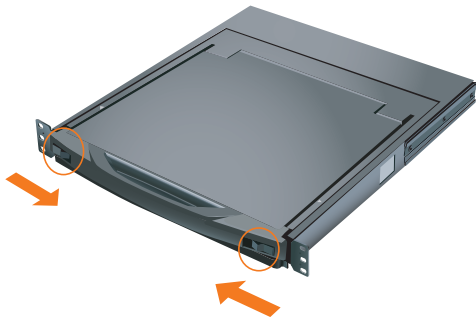

Closing the Console

First, close the LCD module with the handle bar, then pull the safety catches on both sides of the console module towards yourself to release the safety lock. Then slide the 2 Slide Releases toward the center of the LCD Console, then push the console module all the way in while holding the Slide Releases' position. Then simply release the Slide Releases to keep the console module in the lock position.

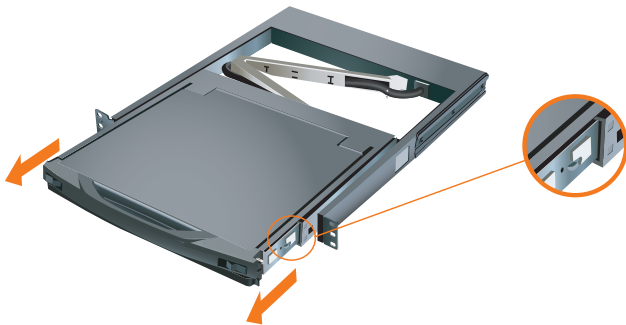

Installation

Please make sure the computer is powered off before you start.

Step 1

Connect the power cord to the power outlet and the power socket of the LCD Console.



Step2

Connect a USB KVM Cable (with a green connector) or PS/2 KVM Cable* (with a yellow connector) from the CPU port of the LCD Console to your computer

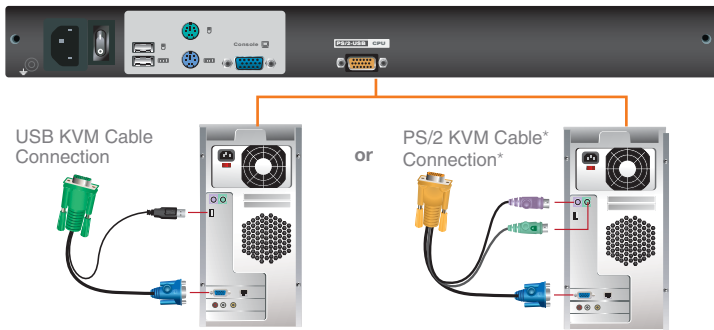

*PS/2 KVM Cables (Model No.: G2L5202P, G2L5203P and G2L5206P) are available and sold separately, please visit our website at www.iogear.com for details.

Step 3

Turn on LCD Console by using the power switch that's located in the back of the LCD Console.



Final Step

Turn on your computer.

Connect to a KVM

Note: This LCD Console is ideal for our GCS1808/GCS1716. Please visit our website at www.iogear.com for details about these two KVMs.

Step 1

Connect the power cord to the power outlet and the power socket of the LCD Console.



Step 2

Connect the provided USB KVM Cable from the CPU port of the LCD Console to the KVM switch's console VGA and USB keyboard port.

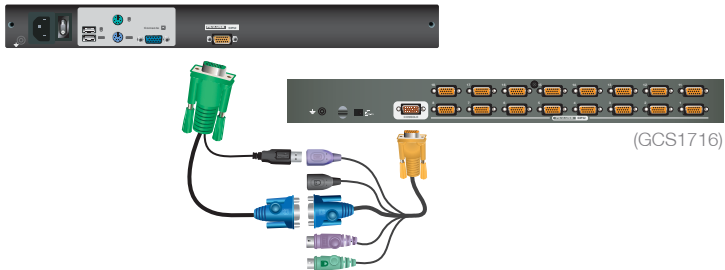

Step 3

Refer to your KVM's manual for details on how to connect your computers to your KVM.

Step 4

Turn on LCD Console by using the power switch that's located in the back of the LCD Console.



Step 5

Refer to your KVM's manual for detail on how to turn on your KVM.

Final Step

Turn on your computers.

External Console Ports (Optional)

If you wish to use external monitor, keyboard or mouse rather than the built-in LCD, keyboard or touchpad, you can connect your external VGA monitor, USB or PS/2 keyboard and mouse to the external console ports that are located in the back of the LCD Console.



USB External Mouse Port (Optional)

There is an external mouse port in the front of the LCD Console next to the Power LED. Simply plug in any USB connection of the mouse to that USB port to use an external mouse instead of the touchpad.



LCD Configuration

There are four buttons for LCD configuration, the functions are as follow:

Button	Function
Menu	<ul style="list-style-type: none">• If you are currently not in the LCD OSD (On Screen Display) Menu, press this Menu button will bring up the LCD OSD Menu.• If you are currently in the LCD OSD Menu, this button acts as an Enter button.
▶ ▲	This button navigates up or right within the OSD Menu. During an adjustment, this button increases the value of the specific adjustment.
◀ ▼	This button navigates left or down within the OSD Menu. During an adjustment, this button decreases the value of the specific adjustment.
Exit	<ul style="list-style-type: none">• If you are currently not in the LCD OSD Menu, press this Exit button will perform an auto adjustment.• If you are currently in the LCD OSD Menu, press this Exit button to exit from the current menu and return to the previous menu.• If you are currently in the LCD OSD main menu, press this Exit button to exit from the OSD.

LCD Adjustment Setting

There are ten functions in the LCD OSD Menu, and they are as follow:

Setting	Function
Brightness	This function adjusts the brightness of the LCD
Contrast	This function is to eliminate pixel jitters or horizontal line noise
Phase	This function is to eliminate vertical banding
Clock	If a port has been given a name, its name appears in this column.
H-Position	This function is to adjust the position of the LCD panel horizontally
V-Position	This function is to adjust the position of the LCD panel vertically
Color Temperature	This function is to adjust the color quality of the LCD. The warmth value and color balance can be adjusted by this function. The Adjust Color selection has a submenu that lets you fine tune the RGB values.
Language	This function is to select the OSD Menu display language
OSD Duration	This function is to set the amount of time for the LCD. If there is no input for this amount of time, LCD display will turn off.
Reset	This function turns all LCD settings back to factory default settings







Reset Button

Use a paper clip or any kind of small object to press the reset button, you will then hear a beep sound which indicates that it will perform a system reset on the LCD Console.



Keyboard Function Keys

There are 6 sets of Keyboard Function Keys on the built-in keyboard and they are as follow. Simply press and hold the [Fn] key then press the function key and release the [Fn] key to trigger the specific function.

Function	Description
	Mute key
	Volume Down key
	Volume Up key
	Trigger Computer Sleep Mode
	Home key
	End key







Hotkey Commands

Combination	Description
[Ctrl][Alt][Shift][P][C][Enter]	Set keyboard operating platform to PC compatible
[Ctrl][Alt][Shift][S][U][N][Enter]	Set keyboard operating platform to SUN compatible*
[Ctrl][Alt][Shift][M][A][C][Enter]	Set keyboard operating platform to MAC compatible*
[Ctrl][Alt][Shift][U][P][G][R][A][D][E][Enter]	Trigger Firmware Upgrade Mode
[Ctrl][Alt][Shift][L][Enter]	Enable Internal Console and disable External Console
[Ctrl][Alt][Shift][R][Enter]	Enable External Console and disable Internal Console
[Ctrl][Alt][Shift][L][R][Enter] or [Ctrl][Alt][Shift][R][L][Enter]	Enable both Internal Console and External Console

*This function can ONLY be used if you have physically connected one computer to the LCD Console. If you have connected multiple computers to the LCD Console through a KVM such as GCS1808/ GCS1716, you would need to enable the SUN Keyboard Emulation from the KVM, please see the user manual for the specific KVM for details.

Mac Keyboard Emulation







The PC compatible (101/104 key) keyboard can emulate the functions of the Mac keyboard. The emulation mappings are listed in the table below.

PC Keyboard	Mac Keyboard	[Alt]	Alt
[Shift]	Shift	[Print Screen]	F13
[Ctrl]	Ctrl	[Scroll Lock]	F14
	⌘		=
[Ctrl] [1]		[Enter]	Return
[Ctrl] [2]		[Backspace]	Delete
[Ctrl] [3]		[Insert]	Help
[Ctrl] [4]		[Ctrl] 	F15

*Note: When using key combinations, press and release the first key (Ctrl), then press and release the second key.

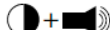
Sun Keyboard Emulation

The PC compatible (101/104 key) keyboard can emulate the functions of the Sun keyboard. The emulation mappings are listed in the table below.

PC Keyboard	Sun Keyboard		
[Crt] [t]	Stop	[Ctrl] [F9]	Find
[Crt] [F2]	Again	[Crt] [F10]	Cut
[Crt] [F3]	Props	[Crt] [1]	
[Crt] [F4]	Undo	[Crt] [2]	
[Crt] [F5]	Front	[Crt] [3]	
[Crt] [F6]	Copy	[Crt] [4]	
[Crt] [F7]	Open	[Crt] [h]	Help
[Crt] [F8]	Paste		Compose
			

*Note: When using key combinations, press and release the first key (Ctrl), then press and release the second key.

Firmware Upgrade

Note: In order to perform a firmware upgrade, you need to use a set of computer that is not connected to the LCD Console.

Step 1

Connect the provided firmware upgrade cable to the firmware upgrade port of the LCD Console and the serial port of the computer that you will be using to perform the firmware upgrade.

Step 2

Connect the power cord to the power outlet and the LCD Console. Then turn on the LCD Console by the power switch that's located in the back of the LCD Console.

Step 3

Go to www.iogear.com to download the latest available firmware or the specific firmware that you wish to upgrade to.

Step 4

Make sure the computer that is connected to the LCD Console is completely shutdown. Then Invoke Firmware Upgrade Mode. (Please refer to Hotkey Commands Section)

Step 5

Extract the file that you have downloaded by using software such as Winrar. Then double-click on the execute file to open up the Firmware Upgrade Utility.

Step 6

Read the License Agreement and click “I Agree” then click “Next” if you wish to continue with the firmware upgrade. Otherwise, click “Cancel” to exit.

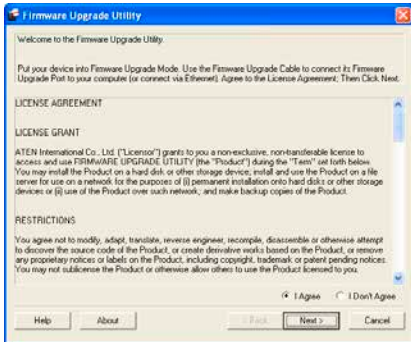

Step 7

Choose the correct device* that you wish to perform firmware upgrade from the “Device List” and then click “Next” to continue. Then the Firmware Upgrade Utility will verify if the device is connected to the computer via the firmware upgrade cable. (Check Firmware Version checkbox is optional)

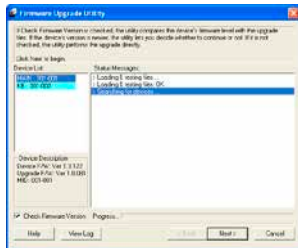

*Note: Please choose MAIN to proceed the firmware upgrade. KB is a sub layer in the LCD Console firmware.

Step 8

If you have checked the “Check Firmware Version” checkbox, then the utility will check the current firmware that is on your LCD Console. If the current firmware is newer than the firmware that you wish to upgrade to, a window will popup and prompt you to ask if you wish to proceed. Simply click “Yes” to start the upgrade and “No” to cancel the upgrade.

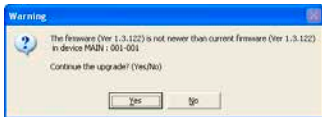

Note: If you did not check the “Check Firmware Version” checkbox, utility will perform the upgrade automatically no matter what version of firmware you have in the LCD Console.

Step 9

Warning window may popup again for 2nd part of the firmware upgrade (KB).

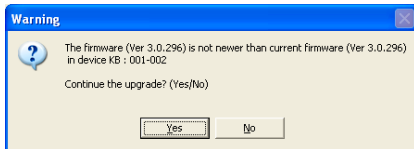

Step 10

When the firmware upgrade is done, you will see “Firmware upgrade OK” in the “Status Messages” window. Then simply click “Finish” to complete the whole firmware upgrade process.

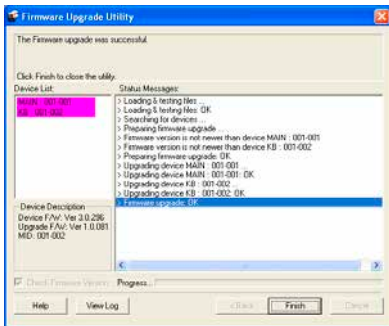

Final Step

Now the LCD Console will reset by itself and it will be ready for usage after the reset.

Upgrade Fail

If you don't see "Firmware upgrade OK" in the "Status Messages" window, it means the utility has failed to complete the firmware successfully. If that occurs, please do the following:

Step 1

Unplug the power cord from the LCD Console. Then, connect the provided firmware upgrade cable to the firmware upgrade port of the LCD Console and the serial port of your computer.

Step 2

Slide the Firmware Upgrade Recovery Switch to the Recover position (slide to the right). Then, connect power cord back to the LCD Console.

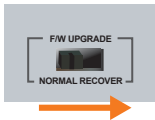

Step 3

Repeat the firmware upgrade process. (Please refer to Firmware Upgrade Section)

Step 4

After the firmware upgrade has completed, turn off the LCD Console. Then, unplug the power cord from the LCD Console.

Step 5

Slide the Firmware Upgrade Recovery Switch back to the Normal position (slide to the left). Then, connect power cord back to the LCD Console.



Final Step

Now the LCD Console is ready to function again, simply reconnect all your computer and console back to the LCD Console and begin using it.

Safety Instructions

General

- Please read all of these instructions and save them for future reference.
- Carefully follow all warning and instructions marked on the device.
- Do not place the device on any unstable surface (cart, stand, table, etc.). If the device falls, serious damage may result.
- Do not use the device near water.
- Do not place the device near or over any radiator, heat register or other heat source.
- The device cabinet is equipped with ventilation openings to ensure that the device remains adequately ventilated and does not overheat. These openings must never be blocked or covered.
- The device should never be placed on a soft surface (bed, sofa, rug, etc.) as this will block the ventilation openings. Additionally, the device should not be placed inside another enclosure (bookcase, etc.) unless adequate ventilation is provided.
- Do not place any liquids on top of the device and take all precautions to avoid spilling any liquids on the device.
- Unplug the device from the wall outlet before cleaning. Do not use liquid or aerosol cleaners. Use only a lightly dampened cloth for cleaning.
- The device should only be operated from the type of power source indicated on the label. If you are not sure what type of power is available, consult your dealer or local power company.
- The device is designed for IT power distribution systems with 110V and 230V phase-to-phase voltage.

- 
- In order to prevent damage once installed, it is important that this device and all devices connected to it are properly grounded.
 - As a safety feature, the device is equipped with a 3-wire grounding plug. If you are unable to insert the plug into an outlet, please contact an electrician to repair/replace the outlet. You should never attempt to override or modify the plug. Always follow your local and/or national wiring codes.
 - Do not allow anything to rest on the power cord or cables. Make sure the power cord and cables are in a location that prevents them from being stepped on or tripped over.
 - If an extension cord is used with this device add the total ampere rating of each product plugged into the extension cord and verify that the total does not exceed the ampere rating of the extension cord. Additionally, make sure that the total ampere rating of all products plugged into the wall outlet does not exceed 15 amperes.
 - To protect the system from sudden, transient increases and decreases in electrical power, use a surge suppressor, line conditioner, or un-interruptible power supply (UPS).
 - Position the system and power cables carefully. Make sure that nothing rests on any of the cables.
 - Do not push objects of any kind into or through the cabinet slots. Pushing objects through the slots poses an electrical and shock hazard.
 - Do not attempt to service the device yourself. Only qualified service personnel should attempt to service the device.

- 
- If the following conditions occur, unplug the device from the wall outlet and bring it to qualified service personnel for repair:
 - The power cord or plug is damaged or frayed;
 - Liquid was spilled into the device;
 - The device was exposed to rain or water
 - The device was dropped, or the cabinet was damaged;
 - The device exhibits a distinct change in performance, indicating a need for service
 - When following the operating instructions, the device does not operate normally.
 - Only adjust those controls that are discussed in the operating instructions. Improper adjustment of other controls may result in damage that could require extensive repair by a qualified technician.
 - Do not connect the RJ-11 connector marked “UPGRADE” to a public telecommunication network.

Rack Mounting

- Before working on the rack, make sure that the stabilizers are secured to the rack, extended to the floor, and that the full weight of the rack rests on the floor. Install front and side stabilizers on a single rack or front stabilizers for joined multiple racks before working on the rack.
- Always load the rack from the bottom up and load the heaviest item in the rack first.
- Make sure that the rack is level and stable before extending a device from the rack.
- Use caution when pressing the device rail release latches and sliding a device into or out of a rack as the slide rails can pinch your fingers.
- After a device is inserted into the rack, carefully extend the rail into a locked position and then slide the device into the rack.
- Do not overload the AC supply branch circuit that provides power to the rack. The total rack load should not exceed 80 percent of the branch circuit rating.
- Make sure that all equipment used on the rack, including power strips and other electrical connectors, are properly grounded.
- Ensure that proper airflow is provided to all devices in the rack.
- Ensure that the operating ambient temperature of the rack environment does not exceed the maximum specified by the equipment manufacturer.
- Do not step on or stand on any device when servicing other devices in a rack.

Specifications

Model	GCL1800	
Power Consumption	29.6W	
Physical Properties	Housing	Metal + Plastic
	Weight	25.94lb
	Dimension (W x H x D)	17in. x 1.75in. x 21in.
Environment	Operating Temperature	0-40°C
	Storage Temperature	-20-60°C
	Humidity	0-80% RH; Noncondensing

EMC Information

FEDERAL COMMUNICATIONS COMMISSION INTERFERENCE STATEMENT:

This equipment has been tested and found to comply with the limits for a Class A digital device, pursuant to Part 15 of the FCC Rules. These limits are designed to provide reasonable protection against harmful interference when the equipment is operated in a commercial environment. This equipment generates, uses, and can radiate radio frequency energy and, if not installed and used in accordance with the instruction manual, may cause harmful interference to radio communications. Operation of this equipment in a residential area is likely to cause harmful interference in which case the user will be required to correct the interference at his own expense.

FCC Caution: Any changes or modifications not expressly approved by the party responsible for compliance could void the user's authority to operate this equipment.

DÉCLARATION SUR LES INTERFÉRENCES DE LA COMMISSION FÉDÉRALE DES COMMUNICATIONS:

Cet équipement a été testé et déclaré conforme aux limites imposées aux appareils numériques de classe A à la partie 15 du règlement de la FCC. Ces limites sont conçues pour fournir une protection raisonnable contre les effets nocifs, interférences lorsque l'équipement est utilisé dans un environnement commercial. Cet équipement génère, utilise et peut émettre de l'énergie de fréquence radio et, s'il n'est pas installé et utilisé conformément à la manuel d'instructions, peut causer des interférences nuisibles aux communications radio. Fonctionnement de cet équipement dans une zone résidentielle est susceptible de provoquer des interférences nuisibles, auquel cas l'utilisateur sera tenu de corriger l'ingérence à ses propres frais.

Avertissement de la FCC: Tout changement ou modification non expressément approuvé par la partie responsable de conformité pourrait annuler le droit de l'utilisateur à utiliser cet équipement.



AS/NZS CISPR32:2013

Warning: This equipment is compliant with Class A of CISPR 32. In a residential environment this equipment may cause radio interference.

This device complies with Part 15 of the FCC Rules. Operation is subject to the following two conditions:

- (1) this device may not cause harmful interference, and
- (2) this device must accept any interference received, including interference that may cause undesired operation.

SJ/T 11364-2006

The following contains information that relates to China.

部件名称	有毒有害物质或元素					
	铅 (Pb)	汞 (Hg)	镉 (Cd)	六价 (Cr(VI))	多溴联苯 (PBB)	多溴二苯醚 (PBDE)
电器部件	●	○	○	○	○	○
机构部件	○	○	○	○	○	○

○:表示该有毒有害物质在该部件所有均质材料中的含量均在SJ/T 11363-2006规定的限量要求之下。

●:表示符合欧盟的豁免条款, 但该有毒有害物质至少在该部件的某一均质材料中的含量超出SJ/T 11363-2006的限量要求。

x: 表示该有毒有害物质至少在该部件的某一均质材料中的含量超出SJ/T 11363-2006的限量要求。



Limited Warranty

IN NO EVENT SHALL THE DIRECT VENDOR'S LIABILITY FOR DIRECT, INDIRECT, SPECIAL, INCIDENTAL OR CONSEQUENTIAL DAMAGES RESULTING FROM THE USE OF THE PRODUCT, DISK, OR ITS DOCUMENTATION EXCEED THE PRICE PAID FOR THE PRODUCT.

The direct vendor makes no warranty or representation, expressed, implied, or statutory with respect to the contents or use of this documentation, and especially disclaims its quality, performance, merchantability, or fitness for any particular purpose. The direct vendor also reserves the right to revise or update the device or documentation without obligation to notify any individual or entity of such revisions, or updates. For further inquiries please contact IOGEAR.

Contact

IOGEAR

www.iogear.com

iogear.custhelp.com

support@iogear.com

