

Gigabit Managed PoE+ Switches

# Installation and Getting Started Guide



## Trademarks Used in this Manual

---

### Trademarks Used in this Manual

Black Box and the Double Diamond logo are registered trademarks of BB Technologies, Inc.

Any other trademarks mentioned in this manual are acknowledged to be the property of the trademark owners.

We're here to help! If you have any questions about your application or our products, contact Black Box Tech Support at **877-877-2269** or go to **blackbox.com** and click on "Talk to Black Box." You'll be live with one of our technical experts in less than 60 seconds.

### Federal Communications Commission and Industry Canada Radio Frequency Interference Statements

This equipment generates, uses, and can radiate radio-frequency energy, and if not installed and used properly, that is, in strict accordance with the manufacturer's instructions, may cause interference to radio communication. It has been tested and found to comply with the limits for a Class A computing device in accordance with the specifications in Subpart B of Part 15 of FCC rules, which are designed to provide reasonable protection against such interference when the equipment is operated in a commercial environment. Operation of this equipment in a residential area is likely to cause interference, in which case the user at his own expense will be required to take whatever measures may be necessary to correct the interference.

Changes or modifications not expressly approved by the party responsible for compliance could void the user's authority to operate the equipment.

This digital apparatus does not exceed the Class A limits for radio noise emission from digital apparatus set out in the Radio Interference Regulation of Industry Canada.

Le présent appareil numérique n'émet pas de bruits radioélectriques dépassant les limites applicables aux appareils numériques de la classe A prescrites dans le Règlement sur le brouillage radioélectrique publié par Industrie Canada.

#### Disclaimer:

Black Box Network Services shall not be liable for damages of any kind, including, but not limited to, punitive, consequential or cost of cover damages, resulting from any errors in the product information or specifications set forth in this document and Black Box Network Services may revise this document at any time without notice.

## Instrucciones de Seguridad (Normas Oficiales Mexicanas Electrical Safety Statement)

1. Todas las instrucciones de seguridad y operación deberán ser leídas antes de que el aparato eléctrico sea operado.
2. Las instrucciones de seguridad y operación deberán ser guardadas para referencia futura.
3. Todas las advertencias en el aparato eléctrico y en sus instrucciones de operación deben ser respetadas.
4. Todas las instrucciones de operación y uso deben ser seguidas.
5. El aparato eléctrico no deberá ser usado cerca del agua—por ejemplo, cerca de la tina de baño, lavabo, sótano mojado o cerca de una alberca, etc.
6. El aparato eléctrico debe ser usado únicamente con carritos o pedestales que sean recomendados por el fabricante.
7. El aparato eléctrico debe ser montado a la pared o al techo sólo como sea recomendado por el fabricante.
8. Servicio—El usuario no debe intentar dar servicio al equipo eléctrico más allá a lo descrito en las instrucciones de operación. Todo otro servicio deberá ser referido a personal de servicio calificado.
9. El aparato eléctrico debe ser situado de tal manera que su posición no interfiera su uso. La colocación del aparato eléctrico sobre una cama, sofá, alfombra o superficie similar puede bloquea la ventilación, no se debe colocar en libreros o gabinetes que impidan el flujo de aire por los orificios de ventilación.
10. El equipo eléctrico debe ser situado fuera del alcance de fuentes de calor como radiadores, registros de calor, estufas u otros aparatos (incluyendo amplificadores) que producen calor.
11. El aparato eléctrico deberá ser conectado a una fuente de poder sólo del tipo descrito en el instructivo de operación, o como se indique en el aparato.
12. Precaución debe ser tomada de tal manera que la tierra física y la polarización del equipo no sea eliminada.
13. Los cables de la fuente de poder deben ser guiados de tal manera que no sean pisados ni pellizcados por objetos colocados sobre o contra ellos, poniendo particular atención a los contactos y receptáculos donde salen del aparato.
14. El equipo eléctrico debe ser limpiado únicamente de acuerdo a las recomendaciones del fabricante.
15. En caso de existir, una antena externa deberá ser localizada lejos de las líneas de energía.
16. El cable de corriente deberá ser desconectado del cuando el equipo no sea usado por un largo periodo de tiempo.
17. Cuidado debe ser tomado de tal manera que objetos líquidos no sean derramados sobre la cubierta u orificios de ventilación.
18. Servicio por personal calificado deberá ser provisto cuando:
  - A: El cable de poder o el contacto ha sido dañado; u
  - B: Objetos han caído o líquido ha sido derramado dentro del aparato; o
  - C: El aparato ha sido expuesto a la lluvia; o
  - D: El aparato parece no operar normalmente o muestra un cambio en su desempeño; o
  - E: El aparato ha sido tirado o su cubierta ha sido dañada.

## CAUTION:

Circuit devices are sensitive to static electricity, which can damage their delicate electronics. Dry weather conditions or walking across a carpeted floor may cause you to acquire a static electrical charge.

To protect your device, always:

- Touch the metal chassis of your computer to ground the static electrical charge before you pick up the circuit device.
- Pick up the device by holding it on the left and right edges only.
- If you need to connect an outdoor device to this device with cable, then you must add an arrester on the cable between the outdoor device and this device.

**NOTE:** The switch is an indoor device; if it will be used in outdoor environment or connects with some outdoor device, then it must use a lightning arrester to protect the switch.

## WARNING:

- Self-demolition on the switch is strictly prohibited. Damage caused by self-demolition will void the warranty.
- Do not place the switch outdoors or in a sandstorm.
- Before installation, make sure input power supply and product specifications are compatible with each other.
- To reduce the risk of electric shock, disconnect all AC or DC power cords and cables to completely remove power from the unit.
- Before importing/exporting configuration, make sure the firmware version is the same.
- After firmware upgrade, the switch will update the configuration automatically to the most recent firmware version.

## Related Publications

For specific information on how to operate and use the management functions of the switch, download the user manual.

The full user manual/installation guide can be downloaded from the Black Box Web site.

### To download from the Web site:

1. Go to [www.blackbox.com](http://www.blackbox.com)
2. Enter the part number (LPB2910A, LPB2926A, or LPB2952A) in the search box:

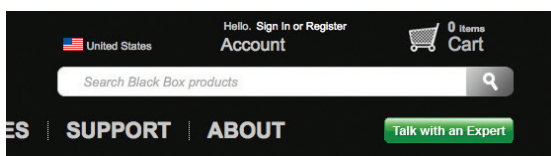

3. Click on the "Resources" tab on the product page, and select the document you wish to download.

If you have any trouble accessing the Black Box site to download the manual, you can contact our Technical Support at 877-877-2269 or [info@blackbox.com](mailto:info@blackbox.com).

# Table of Contents

---

## Table of Contents

1. Specifications.....	7
2. Overview .....	9
2.1 Introduction.....	9
2.2 Switch Architecture and Network Management Options.....	9
2.2.1 Switch Architecture.....	9
2.2.2 Network Management Options .....	9
2.3 What's Included .....	9
2.4 Hardware Description.....	10
2.4.1 LPB2910A.....	11
2.4.2 LPB2926A.....	12
2.4.3 LPB2952A.....	13
2.4.4 Supported SFP Transceivers .....	14
2.4.5 LED Indicators and their Functions .....	15
2.4.6 Power Select .....	15
2.4.7 Power over Ethernet (PoE).....	15
3. Network Planning.....	16
3.1 Introduction to Switching .....	16
3.2 Application Examples .....	16
4. Installing the Switch .....	17
4.1 Selecting a Site.....	17
4.2 Ethernet Cabling.....	17
4.3 Equipment Checklist.....	18
4.4 Mounting .....	18
4.5 Installing an Optional SFP Transceiver .....	19
4.6 Connecting to a Power Source.....	20
4.7 Connecting to the Console Port.....	21
4.8 Web-Based Management.....	22
5. Making Network Connections .....	24
5.1 Connecting Network Devices .....	24
5.2 Twisted-Pair Devices .....	24
5.2.1 Cabling Guidelines.....	24
5.2.2 Connecting to PCs, Servers, Hubs, and Switches .....	24
5.2.3 Network Wiring Connections.....	24
5.3 Fiber Optic SFP Devices.....	25
5.4 Connectivity Rules .....	26
5.4.1 1000BASE-T Cable Requirements.....	26
5.4.2 1000 Mbps Gigabit Ethernet Collision Domain .....	26
6. Cable Labeling and Connection Records .....	28
7. Troubleshooting.....	29
8. Power and Cooling Problems .....	30
8.1 Installation.....	30
8.2 In-Band Access.....	30
9. Cables .....	31
9.1 Twisted-Pair Cable and Pin Assignments.....	31
9.2 10BASE-T/100BASE-TX Pin Assignments.....	31
9.3 Straight-Through Wiring .....	31
9.4 Crossover Wiring .....	32
9.5 1000BASE-T Pin Assignments .....	32
9.6 Cable Testing for Existing Category 5 Cable.....	33
9.7 Adjusting Existing Category 5 Cabling to Run 1000BASE-T .....	33
9.8 Fiber Standards.....	33
Appendix. Glossary .....	34

## 1. Specifications

Physical	
Connectors	<p>LPB2910A: (8) 10/100/1000 Mbps UTP (PoE+), (2) Gigabit Ethernet combo ports TP/(100/1000M) SFP;</p> <p>LPB2926A: (24) 10/100/1000 Mbps UTP (PoE+), (2) Gigabit Ethernet combo ports TP/(100/1000M) SFP;</p> <p>LPB2952A: (48) 10/100/1000 Mbps UTP (PoE+), (4) 1G/10 Gbps SFP fiber ports</p>
Network Interface	<p>LPB2910A:</p> <p>Ports 1–8: RJ-45 connector, Auto MDI/X,  10BASE-T: RJ-45 (100-ohm, UTP cable, Category 3 or better),  100BASE-TX: RJ-45 (100-ohm, UTP cable Category 5 or better),  1000BASE-T: RJ-45 (100-ohm, UTP or STP cable, Category 5, 5e, or 6),  Ports 9–10: 100/1000M SFP ports;  Maximum UTP Cable Length: 328 ft (100 m);</p> <p>LPB2926A:</p> <p>Ports 1–24: RJ-45 connector, Auto MDI/X,  10BASE-T: RJ-45 (100-ohm, UTP cable, Category 3 or better),  100BASE-TX: RJ-45 (100-ohm, UTP cable Category 5 or better),  1000BASE-T: RJ-45 (100-ohm, UTP or STP cable, Category 5, 5e, or 6),  Ports 25–26: 100/1000M SFP ports;  Maximum UTP Cable Length: 328 ft (100 m),</p> <p>LPB2952A:</p> <p>Ports 1–48: RJ-45 connector, auto MDI/X,  10BASE-T: RJ-45 (100-ohm, UTP cable; Category 3 or better),  100BASE-TX: RJ-45 (100-ohm, UTP cable; Category 5 or better),  1000BASE-T: RJ-45 (100-ohm, UTP or STP cable; Category 5, 5e, or 6),  Ports 49–52: 1G/10G SFP ports;  Maximum UTP or STP Cable Length: 328 ft (100 m)</p>
LEDs	<p>System: Power;</p> <p>Twisted-Pair Port: Status LEDs: LINK/ACT, 10/100/1000M;</p> <p>SFP Port: Status LEDs: LINK/ACT/SPD, 100/1000M</p>
Dimensions	<p>LPB2910A: 1.7"H x 8.7"W x 9.4"D (4.4 x 22 x 24 cm);</p> <p>LPB2926A: 1.7"H x 17.4"W x 8.3"D (4.4 x 44.2 x 21.1 cm);</p> <p>LPB2952A: 1.7"H x 17.3"W x 15.1"D (4.4 x 44 x 38.5 cm)</p>
Environmental	
Temperature	Operating: 32 to 122° F (0 to 50° C)
Humidity	Operating: 10 to 90%, noncondensing
Power	
Power Input	100–240 VAC, 50–60 Hz
Power Supply	<p>LPB2910A: 130 W;</p> <p>LPB2926A: 185 W;</p> <p>LPB2952A: 370 W</p>

## Chapter 1: Specifications

---

Switch Features	
Switching Database	8 K MAC addresses entries
Forwarding Mode	Store-and-Forward
Throughput	LPB2910A: 20 Gbps; LPB2926A: 52 Gbps; LPB2952A: 176 Gbps
Flow Control	Full duplex: IEEE 802.3x; Half-duplex: Backpressure
Jumbo Frames	9216 bytes
Management Features	
In-Band Management	SSH/SSL, Telnet, SNMP, or HTTP
Out-of-Band Management	RJ-45 console port
Software Loading	HTTP, TFTP in-band, Console out-of-band
Approvals	
Standards	IEEE 802.3: 10BASE-T Ethernet (Twisted-pair Copper), IEEE 802.3u: 100BASE-TX Ethernet (Twisted-pair Copper), IEEE 802.3ab: 1000BASE-TX Ethernet (Twisted-pair Copper), IEEE 802.3z: 1000BASE-X Ethernet; IEEE 802.3x: Flow Control Capability; ANSI/IEEE 802.3: Auto-negotiation, IEEE 802.1Q: VLAN, IEEE 802.1p: Class of Service, IEEE 802.1X: Access Control, IEEE 802.1D: Spanning Tree, IEEE 802.1w: Rapid Spanning Tree, IEEE 802.1s: Multiple Spanning Tree, IEEE 802.3ad: Link Aggregation Control Protocol (LACP), IEEE 802.1AB: Link Layer Discovery Protocol (LLDP)
Emissions	EN55022 (CISPR 22) Class A EN 61000-3, FCC Class A, CE Mark
Immunity	EN 61000-4-2/3/4/5/6/8/11, EN 55024



## 2. Overview

### 2.1 Introduction

The Gigabit Managed PoE+ Switches provide a reliable infrastructure for your business network. These switches improve the availability of your critical business applications, protect your sensitive information, and optimize your network bandwidth to deliver information and applications more effectively. Easy to set up and use, the switches provide the ideal combination of affordability and capabilities for entry-level networking. Use them in small business or enterprise applications.

Three models are available:

- LPB2910A
- LPB2926A
- LPB2952A

The switches support advanced security management capabilities and network features, including data, voice, security, and wireless technologies. The switches are easy to deploy and configure, providing stable and quality network services.

### 2.2 Switch Architecture and Network Management Options

#### 2.2.1 Switch Architecture

The switch performs wire-speed, non-blocking switching. This allows wire-speed transport of multiple packets at low latency on all ports simultaneously. The switch also features full-duplex capability on all ports, which effectively doubles the bandwidth of each connection.

This switch uses store-and-forward technology to ensure maximum data integrity. With this technology, the entire packet must be received into a buffer and checked for validity before being forwarded. This prevents errors from being propagated throughout the network.

#### 2.2.2 Network Management Options

You can manage the switch over the network with a Web browser or Telnet application. The switch includes a built-in network management agent that allows it to be managed in-band using SNMP or RMON (Groups 1, 2, 3, 9) protocols. It also has an RJ-45 console port connector on the front panel for out-of-band management. Connect a PC to this port for configuration and monitoring out-of-band via a null-modem serial cable.

*NOTE: For a detailed description of the management features, refer to the user's manual.*

### 2.3 What's Included

Your package should include the following items. If anything is missing or damaged, contact Black Box Technical Support at 877-877-2269 or [info@blackbox.com](mailto:info@blackbox.com).

- Gigabit Managed PoE+ Switch
- Four adhesive rubber feet
- Mounting Accessory (for 19" rack shelf, optional)
- AC Power Cord
- RJ-45 Console Cable
- This Installation and Getting Started Guide

The full user manual can be downloaded from the Black Box Web site.

To download from the Web site:

1. Go to [www.blackbox.com](http://www.blackbox.com)
2. Enter the part number (LPB2910A, LPB2926A, or LPB2952A) in the search box.

3. Click on the “Resources” tab on the product page, and select the document you wish to download.

If you have any trouble accessing the Black Box site to download the manual, you can contact our Technical Support at 877-877-2269 or [info@blackbox.com](mailto:info@blackbox.com).

### 2.4 Hardware Description

#### 1000BASE-T Ports

The switch includes 10, 26, or 48 1000BASE-T RJ-45 ports. All RJ-45 ports support automatic MDI/MDI-X operation, auto-negotiation of speed and flow control, so the switch automatically select the optimum data rate and transmission.

#### SFP Transceiver Slots

The LPB2910A, LPB2926A, and LPB2952A switches support two or four Small Form Factor Pluggable (SFP) transceiver slots. The LPB2910A shares two SFP slots with RJ-45 ports 9 and 10. The LPB2926A shares two SFP slots with RJ-45 ports 25 and 26. If an SFP transceiver (purchased separately) is installed in a slot and has a valid link on the port, the associated RJ-45 port is disabled.

The LPB2952A has four 1G/10G SFP slots on ports 49 through 52.

Supported SFP transceivers are listed in Section 2.4.4.

#### Port and System Status LEDs

The switch has an LED display panel that indicates system and port status and activity to simplify installation and network troubleshooting. The LEDs are located on the left side of the front panel and are described in Section 2.4.5.

2.4.1 LPB2910A

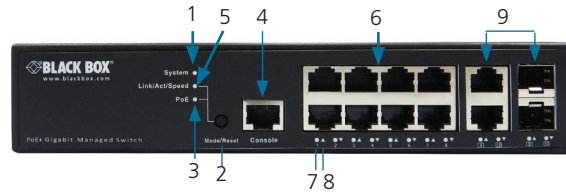

Figure 2-1. Front panel of the LPB2910A.



Figure 2-2. Back panel of the LPB2910A.

Table 2-1. LPB2910A components.

Number in Figures 2-1 and 2-2	Component in Figures 2-1 and 2-2	Description
1	(1) System LED	Lights when system is active
2	(1) Mode/Reset button	Press to select Mode or Reset
3	(1) PoE LED	Lights when system is in PoE mode
4	(1) RJ-45 port	Console port
5	(1) Link/Act/Speed LED	Lights when switch is in Link/Act/Speed mode
6	(8) RJ-45 ports	10/100/1000BASE-T ports
7	(8) Speed LEDs	10/100/1000 Mbps
8	(8) LINK/ACT LEDs	Link/Activity LED: Blinking: activity on port; Off: No link is established
9	(2) RJ-45/SFP combo ports	10/100/1000 RJ-45/100/1000 SFP combo ports
10	(1) 3-prong AC power socket	Links to AC power cord

## 2.4.2 LPB2926A

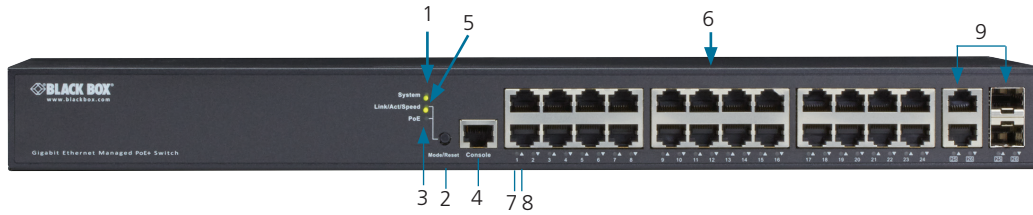

Figure 2-3. Front panel of the LPB2926A.



Figure 2-4. Back panel of the LPB2926A.

Table 2-2. LPB2926A components.

Number in Figures 2-3 and 2-4	Component in Figures 2-3 and 2-4	Description
1	(1) System LED	Lights when system is active
2	(1) Mode/Reset button	Press to select Mode or Reset
3	(1) PoE LED	Lights when switch is in PoE mode
4	(1) RJ-45 port	Console port
5	(1) Link/Act/Speed LED	Switch is in Link/Act/Speed Mode
6	(24) RJ-45 ports	10/100/1000BASE-T ports
7	(24) Speed LEDs	10/100/1000 Mbps
8	(24) LINK/ACT LEDs	Link/Activity LED: Blinking: activity on port; Off: No link is established
9	(2) RJ-45/SFP combo ports	10/100/1000 RJ-45/100/1000 SFP combo ports
10	(1) 3-prong AC power socket	Links to AC power cord

2.4.3 LPB2952A

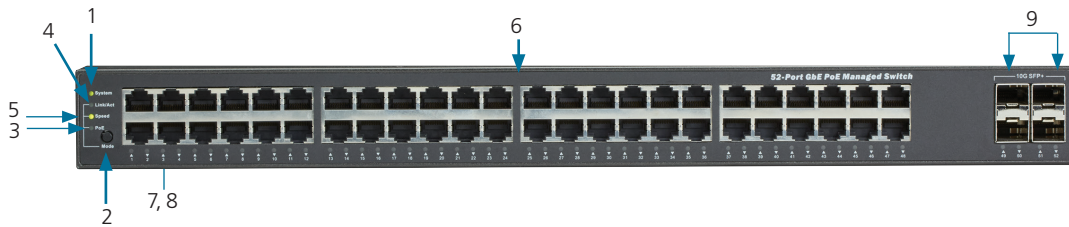

Figure 2-5. Front panel of the LPB2952A.



Figure 2-6. Back panel of the LPB2952A.

Table 2-3. LPB2952A components.

Number in Figures 2-5 and 2-6	Component in Figures 2-5 and 2-6	Description
1	(1) System LED	Lights when system is active
2	(1) Mode/Reset button	Press to select Mode or Reset
3	(1) PoE LED	Lights when switch is in PoE mode
4	(1) Link/Act LED	Lights when switch is in Link/Act mode
5	(1) Speed LED	Lights when switch is in Speed mode
6	(48) RJ-45 ports	10/100/1000BASE-T ports
7	(48) Speed LEDs	10/100/1000 Mbps
8	(48) LINK/ACT LEDs	Link/Activity LED: Blinking: activity on port; Off: No link is established
9	(4) SFP ports	1G/10G SFP ports
10	(1) 3-prong AC power socket	Links to AC power cord
11	(1) RPS connector	Not used
12	(1) DB9 male	Console port

### 2.4.4 Supported SFP Transceivers

The following table shows a list of transceiver types that we have tested with the switch.

Table 2-4. Supported SFP Transceivers.

Ordering Information: SFP Modules		Compatible Switches
LFP401	SFP, 155-Mbps Fiber with Extended Diagnostics, 850-nm Multimode, LC, 2 km	LPB2910A, LPB2926A
LFP402	SFP, 155-Mbps Fiber with Extended Diagnostics, 1310-nm Multimode, LC, 2 km	LPB2910A, LPB2926A
LFP403	SFP, 155-Mbps Fiber with Extended Diagnostics, 1310-nm, Single-Mode, LC, 30 km	LPB2910A, LPB2926A
LFP404	SFP, 155-Mbps Fiber with Extended Diagnostics, 1310-nm Single-Mode, Plus, LC, 60 km	LPB2910A, LPB2926A
LFP411	SFP, 1.25-Gbps Fiber with Extended Diagnostics, 850-nm Multimode, LC, 300 m	LPB2910A, LPB2926A, LPB2952A
LFP412	SFP, 1.25-Gbps Fiber with Extended Diagnostics, 1310-nm Multimode, LC, 2 km	LPB2910A, LPB2926A, LPB2952A
LFP413	SFP, 1.25-Gbps Fiber with Extended Diagnostics, 1310-nm Single-Mode, LC, 10 km	LPB2910A, LPB2926A, LPB2952A
LFP414	SFP, 1.25-Gbps Fiber with Extended Diagnostics, 1310-nm Single-Mode, LC, 30 km	LPB2910A, LPB2926A, LPB2952A
LFP416	SFP with SGMII Interface, 1.25 Gbps, Copper, 10/100/1000BASE-T, Extended Diagnostics	LPB2910A, LPB2926A, LPB2952A
LSP421	10GBASE-SR SFP+, 850-nm Multimode, 300 m, LC	LPB2952A
LSP422	10GBASE-SR SFP+, 1310-nm Single-Mode, 10 km, LC	LPB2952A

### 2.4.5 LED Indicators and their Functions

The table below describes the switch's LED indicators and their functions.

Table 2-5. Port Status LEDs.

LED Indicator	Condition	Status
TP SPEED	Green/Yellow	Lit Green when TP link on 1000 Mbps, Yellow when TP link on 10/100 Mbps
PoE (Link/ACT)	Green	Lit Green when PoE link with PD and supply power to PD
SFP SPEED	Green/Yellow	Lit Green when SFP link on 1000 Mbps, Yellow when SFP link on 100 Mbps

Table 2-6. Mode Status LEDs.

LED Indicator	Condition	Status
Link/ACT/Speed	Green	Lit Green indicates all LED of each port are in Link/ACT/Speed mode.
PoE	Green	Lit Green when PoE link with PD and supply power to PD.

Table 2-7. System Status LED.

LED Indicator	Condition	Status
Power	Green OFF	Lit green when power is on, Off when power is off.

### 2.4.6 Power Socket

An AC power socket is on the rear panel of the switch. Use an AC power cord (included) to power the switch.

### 2.4.7 Power over Ethernet (PoE)

Devices connected to the switch can be powered over the twisted-pair cable that links the devices to the switch. A powered device (PD) provides power over the extra wires on the RJ-45 connector and cables.

The LPB2910A, LPB2926A, and LPB2952A support PoE (802.3af) and PoE+ (802.3at) up to 30 W per port.

### 3. Network Planning

#### 3.1 Introduction to Switching

A network switch allows simultaneous transmission of multiple packets; it can partition a network more efficiently than bridges or routers. The switch is one of the most important devices for today's networking technology.

When performance bottlenecks are caused by congestion at the network access point such as file server, the device can be connected directly to a switched port. Using full-duplex mode doubles the bandwidth of the dedicated segment to maximize throughput.

When networks are based on repeater (hub) technology, the distance between end stations is limited by a maximum hop count. A switch subdivides the network into smaller and more manageable segments, and links them to the larger network. Then, it turns the hop count back to zero and removes the limitation.

You can easily configure a switch in any Ethernet, Fast Ethernet, or Gigabit Ethernet network to significantly increase bandwidth while using conventional cabling and network cards.

#### 3.2 Application Examples

The Gigabit Managed PoE+ Switch has 10, 24, or 48 Gigabit Ethernet TP ports with auto MDI-X and two combo RJ-45/SFP ports or four 1G/10G SFP slots for a removable SFP module.

The SFP module (ordered separately) connects many different types of fiber modules, such as LC and BiDi-LC modules.

The SFP module segments your network, and also provides a wide range of options in setting up network connections. Typical applications are described below.

The switch is suitable for the following applications.

- Remote site application for Enterprise or SMB.
- Peer-to-peer application for two remote offices.
- Office network.
- High-performance requirements environment.
- Advanced security for network safety applications.
- Data/ voice and video conference applications.



### 4. Installing the Switch

#### 4.1 Selecting a Site

Mount the switch in a standard 19-inch equipment rack (via an optional rackmount kit) or on a flat surface. Follow the guidelines below when choosing a location.

The site should:

- Be at the center of all the devices you want to link and near a power outlet.
- Be able to maintain its temperature within 32 to 122° F (0 to 50° C) and its humidity within 10% to 90%, non-condensing.
- Be accessible for installing, cabling and maintaining the devices.
- Allow the status LEDs to be clearly visible.
- Make sure the twisted-pair Ethernet cable is always routed away from power lines, radios, transmitters or any other electrical interference.
- Make sure that Gigabit Managed PoE+ Switch is connected to a separate grounded power outlet that provides 100 to 240 VAC, 50 to 60 Hz.

#### 4.2 Ethernet Cabling

For proper operation when installing the switch into a network, make sure that the current cables are suitable for 100BASE-TX or 1000BASE-T operation. Check the following criteria against the current installation of your network:

- Cable type: Unshielded twisted pair (UTP) or shielded twisted pair (STP) cable with RJ-45 connectors; Category 5 or Category 5e with maximum length of 328 feet (100 meters) is recommended for 100BASE-TX, and Category 5e or 6 with maximum length of 28 feet (100 meters) is recommended for 1000BASE-T.
- Protection from radio frequency interference emissions.
- Electrical surge suppression.
- Separation of electrical wires and data based network wiring.
- Safe connections with no damaged cables, connectors, or shields.

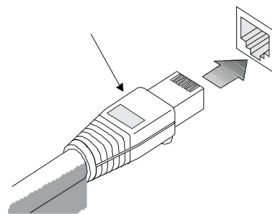

Figure 4-1. RJ-45 connection.

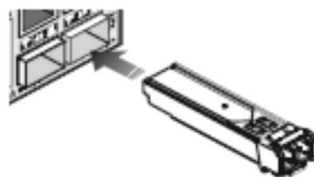

Figure 4-2. SFP transceiver.

## Chapter 4: Installing the Switch

---

### 4.3 Equipment Checklist

Before unpacking this switch, check the contents to be sure you have received all the components (see Section 2.3). Then, before beginning the installation, be sure you have all other necessary installation equipment.

*WARNING: The SFP transceivers are Class 1 laser devices. Avoid direct eye exposure to the beam coming from the transmit port.*

### 4.4 Mounting

The switch can be mounted in a standard 19-inch equipment rack or on a desktop or shelf. Mounting instructions for each type of site follow.

#### Rackmounting

Before rackmounting the switch, consider the following factors:

- Temperature: Since the temperature within a rack assembly may be higher than the ambient room temperature, check that the rack environment temperature is within the specified operating temperature range 32 to 122° F (0 to 50° C).
- Mechanical Loading: Do not place any equipment on top of a rackmounted unit.
- Circuit Overloading: Be sure that the supply circuit to the rack assembly is not overloaded.
- Grounding: Rackmounted equipment should be properly grounded.

To rackmount devices:

Step 1: Attach the brackets to the device using the screws provided in the mounting kit (INCLUDED OR NOT???).

#### Attaching the brackets

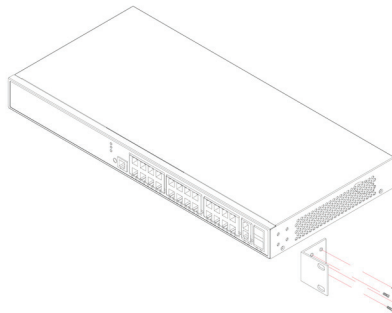

Figure 4-3. Attaching the brackets.

Step 2: Mount the device in the rack (using the rackmount brackets and four rackmounting screws). Be sure to secure the lower rack-mounting screws first to prevent the brackets being bent by the weight of the switch.

#### Installing the switch in a rack

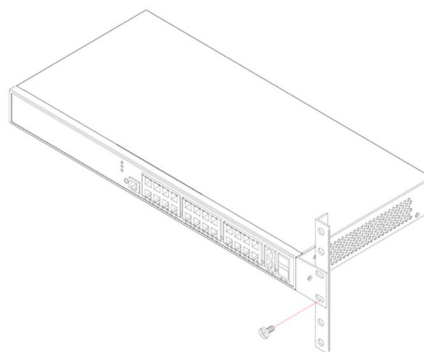

Figure 4-4. Attaching the switch to the rack with screws (not included).

Step 3: If installing a single switch only, turn to “Connection to a Power Source” at the end of this chapter.

Step 4: If installing multiple switches, mount them in the rack, one below the other, in any order.

### Desktop or Shelf Mounting

Step 1: Attach the four adhesive rubber feet to the bottom of the first switch.

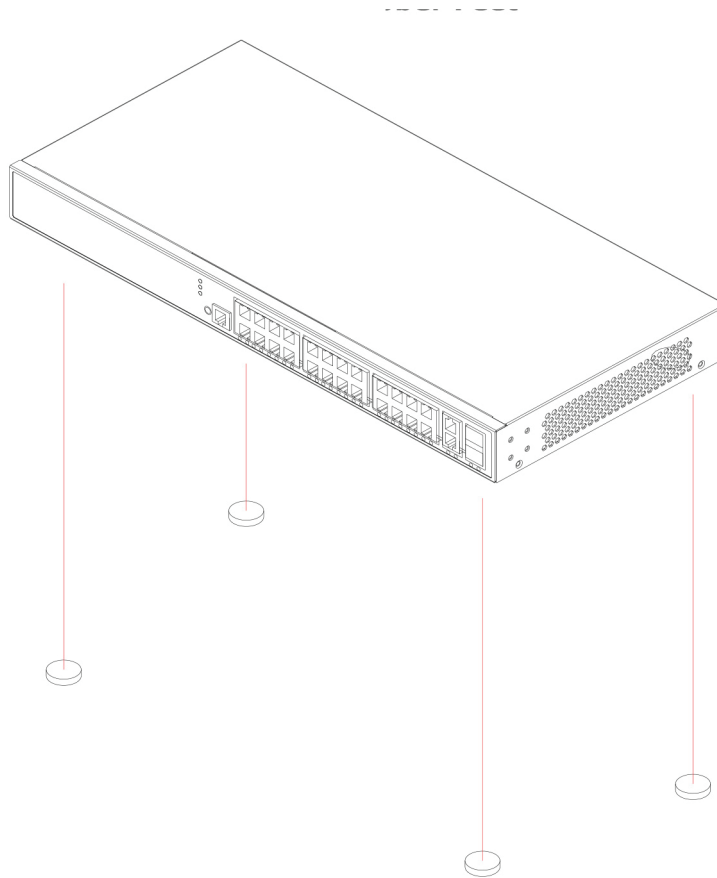

Figure 4-5. Attaching the adhesive rubber feet.

Step 2: Set the device on a flat surface near an AC power source, making sure there are at least two inches of space on all sides for proper air flow.

Step 3: If installing a single switch only, go to “Connecting to a Power Source” at the end of this Chapter.

Step 4: If installing multiple switches, attach four adhesive feet to each one. Place each device squarely on top of the one below, in any order.

### 4.5 Installing an Optional SFP Transceiver

You can install or remove an SFP from an SFP slot without powering off the switch. Use only compatible SFPs.

*NOTE: On the LPB2910A and LPB2926A, the SFP slots are shared with the two 10/100/1000BASE-T RJ-45 ports. If an SFP is installed in a slot, the associated RJ-45 port is disabled and cannot be used.*

The SFPs operate only at full duplex. Half-duplex operation is not supported.

Make sure the network cable is NOT connected when you install or remove an SFP module.

## Chapter 4: Installing the Switch

---

### Inserting an SFP Transceiver into a Slot

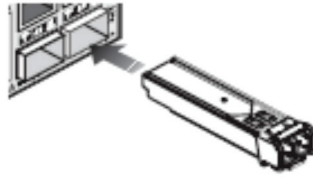

Figure 4-6. Inserting an SFP transceiver into a slot.

To install an SFP transceiver, do the following:

Step 1: Consider network and cabling requirements to select an appropriate SFP transceiver type.

Step 2: Insert the transceiver with the optical connector facing outward and the slot connector facing down. Note that SFP transceivers are keyed so they can only be installed in one orientation.

Step 3: Slide the SFP transceiver into the slot until it clicks into place.

*NOTE: SFP transceivers are ordered separately.*

### 4.6 Connecting to a Power Source

You can plug or remove the power cord from an AC power socket to switch the power on and off.

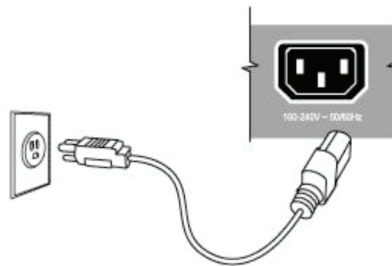

Figure 4-7. Inserting the power cord into an AC power socket.

Step 1: Insert the power cable plug directly into the AC Socket located at the back of the switch.

Step 2: Plug the other end of the cable into a grounded, 3-pin, AC power source.

Step 3: Check the front-panel LEDs as the device is powered on to be sure the POWER LED is lit. If not, check that the power cable is correctly plugged in.

*WARNING: For International use, you may need to change the AC line cord. You must use a line cord set that has been approved for the socket type in your country.*

### 4.7 Connecting to the Console Port

The RJ-45 serial port on the switch's front panel is used to connect to the switch for out-of-band console configuration. You can access the command-line-driven configuration program from a terminal or a PC running a terminal emulation program. The pin assignments used to connect to the serial port are provided next.

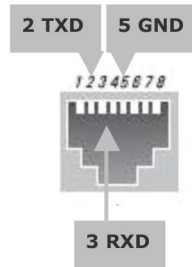

Figure 4-8. Serial port (RJ-45) pinout.

Table 4-1. Wiring map for serial cable.

**Switch's 8-Pin Serial Port**

- 6 RXD (receive data)
- 3 TXD (transmit data)
- 5 SGND (signal ground)

**Null Modem**

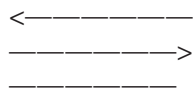

**PC's 9-Pin DTE Port**

- 3 TXD (transmit data)
- 2 RXD (receive data)
- 5 SGND (signal ground)

*NOTE: No other pins are used.*

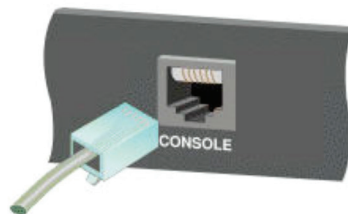

Figure 4-9. Plug in the console port.

The serial port's configuration requirements are as follows:

- Default Baud rate—115,200 bps
- Character Size—8 Characters
- Parity—None
- Stop bit—One
- Data bits—8
- Flow control—none

## Chapter 4: Installing the Switch

---

### 4.8 Web-Based Management

The default values of the managed switch are listed in the table below:

IP address	192.168.1.1
Subnet Mask	255.255.255.0
Default	192.168.1.254
Username	admin
Password	

After you configure the switch in the Command-Line Interface (CLI) via the switch's serial interface, you can browse it. For instance, type `http://192.168.1.1` in the address row in a browser. It will show the following screen and ask you to input a username and password to login and access authentication. The default username and password are both "admin." The first time you login to the switch, enter the default username and password, then click the <Login> button. The login process now is complete.

The image shows a web-based login interface for a switch. It consists of a light gray rectangular frame containing three main elements: a large white rectangular input field at the top, a smaller white rectangular input field labeled "Password" in the middle, and a solid blue rectangular button labeled "Login" at the bottom.

Figure 4-10. Gigabit Managed PoE+ Switch Web user interface.

*NOTE: To configure a function or parameter on the switch, refer to the user manual. Or, access the switch and click the "help" button under the Web GUI and help screens will pop up.*

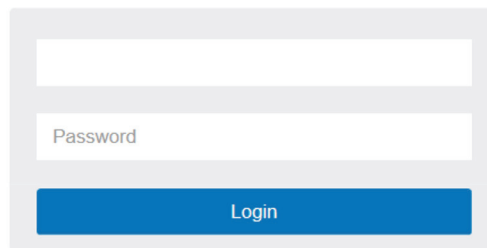
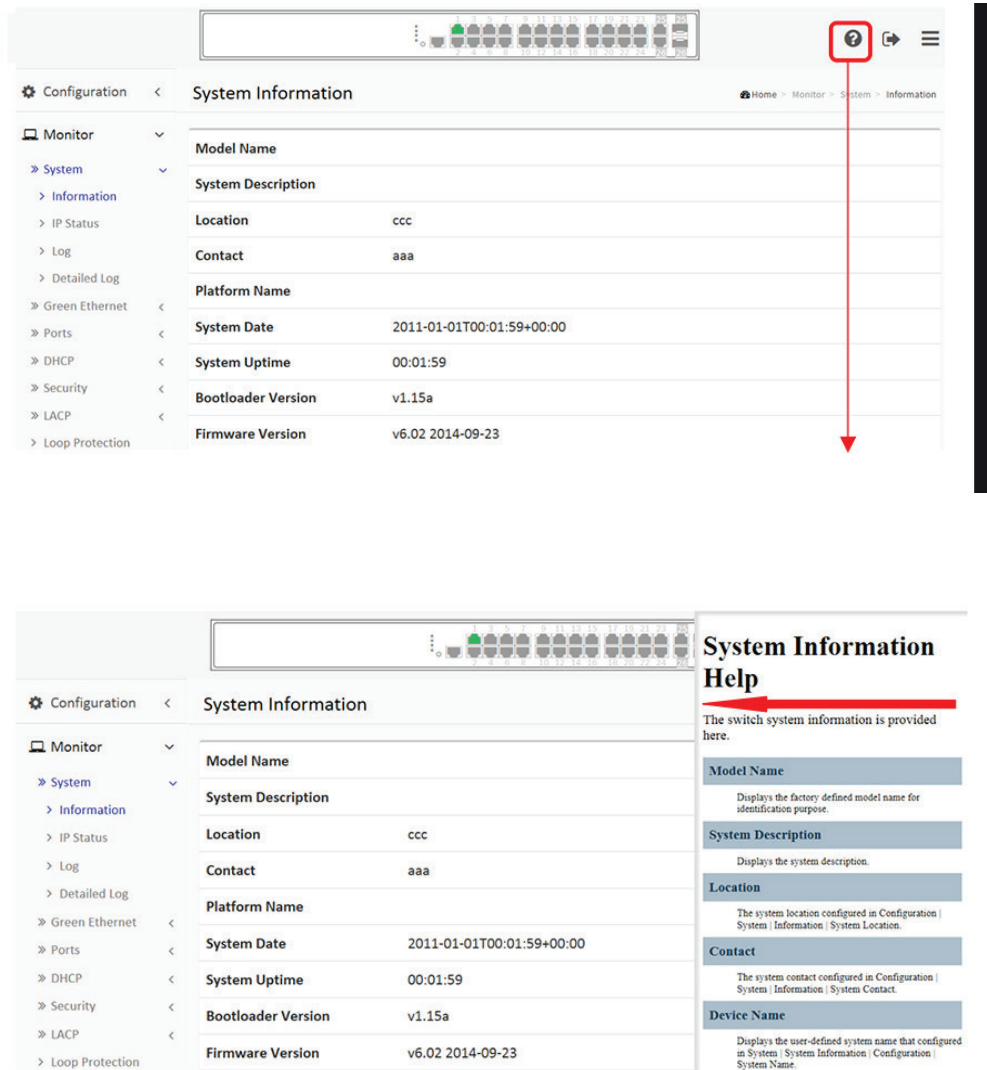

Figure 4-11. Help screen on the GUI interface.

### 5. Making Network Connections

#### 5.1 Connecting Network Devices

The switch is designed to be connected to 10, 100, or 1000 Mbps network cards in PCs and servers, as well as to other switches and hubs. It may also be connected to remote devices using optional SFP transceivers.

#### 5.2 Twisted-Pair Devices

Each device requires an unshielded twisted-pair (UTP) cable with RJ-45 connectors at both ends. Use Category 5, 5e or 6 cables for 1000BASE-T connections, Category 5 or better for 100BASE-TX connections.

##### 5.2.1 Cabling Guidelines

The RJ-45 ports on the switch support automatic MDI/MDI-X pinout configuration, so you can use standard straight-through twisted-pair cables to connect to any other network device (PCs, servers, switches, routers, or hubs).

*CAUTION: Do not plug a phone jack connector into an RJ-45 port. This will damage the switch. Use only twisted-pair cables with RJ-45 connectors that conform to FCC standards.*

##### 5.2.2 Connecting to PCs, Servers, Hubs, and Switches

Step 1: Attach one end of a twisted-pair cable segment to the device's RJ-45 connector.

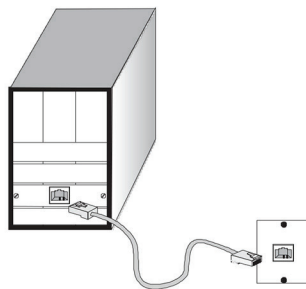

Figure 5-1. Making twisted-pair connections.

Step 2: If the device is a network card and the switch is in the wiring closet, attach the other end of the cable segment to a modular wall outlet that is connected to the wiring closet. (See the section “Network Wiring Connections.”) Otherwise, attach the other end to an available port on the switch.

Make sure each twisted pair cable does not exceed 328 feet (100 meters) in length.

*NOTE: Avoid using flow control on a port connected to a hub unless it is actually required to solve a problem. Otherwise, back pressure jamming signals may degrade overall performance for the segment attached to the hub.*

Step 3: As you make each connection, the Link LED (on the switch) corresponding to each port will light green (1000 Mbps) or amber (100 Mbps) to indicate that the connection is valid.

##### 5.2.3 Network Wiring Connections

A punchdown block is an integral part of many equipment racks. It is actually part of the patch panel. Instructions for making connections in the wiring closet with this type of equipment follow.

Step 1: Attach one end of a patch cable to an available port on the switch, and the other end to the patch panel.

Step 2: If not already in place, attach one end of a cable segment to the back of the patch panel where the punchdown block is located, and the other end to a modular wall outlet.

Step 3: Label the cables to simplify future troubleshooting. See “Cable Labeling and Connection Records.”



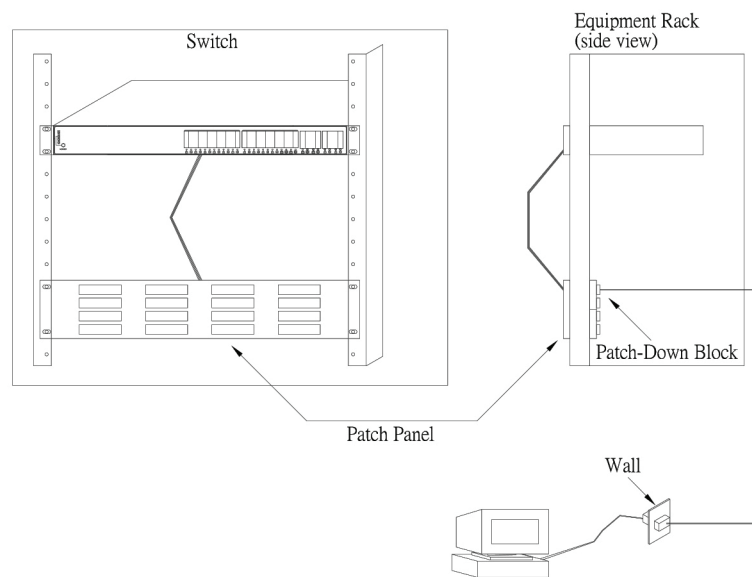

Figure 5-2. Network Wiring Connections.

### 5.3 Fiber Optic SFP Devices

An optional Gigabit SFP transceiver can be used for a backbone connection between switches, or for connecting to a high-speed server.

Each single-mode fiber port requires 9/125 micron single-mode fiber optic cable with an LC connector at both ends. Each multimode fiber optic port requires 50/125 or 62.5/125 micron multimode fiber optic cabling with an LC connector at both ends.

*WARNING: This switch uses lasers to transmit signals over fiber optic cable. The lasers are inherently eye safe in normal operation. However, users should never look directly at a transmit port when it is powered on.*

*WARNING: When selecting a fiber SFP device, consider safety. Make sure that it can function at a temperature that is not less than the recommended maximum operating temperature of the product. You must also use an approved Laser SFP transceiver.*

Step 1: Remove and keep the LC port's rubber plug. When not connected to a fiber cable, replace the rubber plug to protect the optics.

Step 2: Check that the fiber terminators are clean. You can clean the cable plugs by wiping them gently with a clean tissue or cotton ball moistened with a little ethanol. Dirty fiber terminators on fiber optic cables will impair the quality of the light transmitted through the cable and lead to degraded performance on the port.

Step 3: Connect one end of the cable to the LC port on the switch and the other end to the LC port on the other device. Since LC connectors are keyed, the cable can be attached in only one orientation.

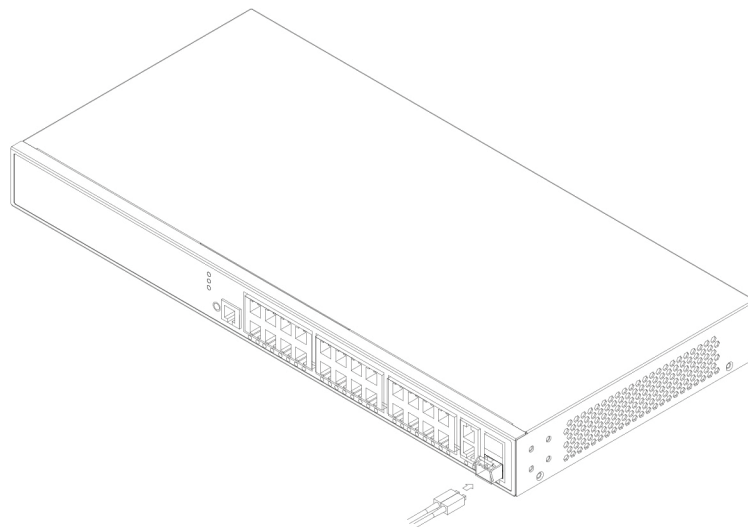

Figure 5-3. Making Fiber Port connections.

Step 4: As a connection is made, check the Link LED on the switch corresponding to the port to be sure that the connection is valid.

The fiber optic ports operate at 1 Gbps. The maximum length for fiber optic cable operating at Gigabit speed will depend on the fiber type as listed under “1000 Mbps Gigabit Ethernet Collision Domain.”

### 5.4 Connectivity Rules

When adding hubs to your network, note that because switches break up the path for connected devices into separate collision domains, you should not include the switch or connected cabling in your calculations for cascade length involving other devices.

#### 5.4.1 1000BASE-T Cable Requirements

All Category 5 UTP cables that are used for 100BASE-TX connections should also work for 1000BASE-T, providing that all four wire pairs are connected. However, we recommend using Category 5e or Category 6 cable for all critical connections, or any new cable installations. The Category 5e and 6 specifications include test parameters that are only recommendations for Category 5. Therefore, the first step in preparing existing Category 5 cabling for running 1000BASE-T is a simple test of the cable installation to be sure that it complies with the IEEE 802.3-2005 standards.

#### 5.4.2 1000-Mbps Gigabit Ethernet Collision Domain

Table 5-1. Maximum 1000BASE-T Gigabit Ethernet cable length.

Cable Type	Maximum Cable Length	Connector
Category 5, 5e, or 6 100-ohm UTP or STP	328 ft. (100 m)	RJ-45

Table 5-2. Maximum 1000BASE-X Gigabit fiber cable lengths.

Fiber Size	Fiber Bandwidth	Maximum Cable Length	Connector
62.5/125 micron multimode fiber	160 MHz/km	722 ft. (220 m)	LC
	200 MHz/km	902 ft. (275 m)	LC
50/125 micron multimode fiber	400 MHz/km	1641 ft. (500 m)	LC
	500 MHz/km	1805 ft. (550 m)	LC

Table 5-3. Maximum 1000BASE-LX/LHX/XD/ZX Gigabit fiber cable length.

Fiber Size	Fiber Bandwidth	Maximum Cable Length	Connector
9/125 micron single-mode fiber, 1310 nm	N/A	6.2 miles (10 km)	LC
9/125 micron single-mode fiber, 1550 nm	N/A	18.64 miles (30 km) 31.06 miles (50 km)	LC LC

Table 5-4. Maximum 1000BASE-LX single fiber Gigabit cable length.

Fiber Size	Fiber Bandwidth	Maximum Cable Length	Connector
Single-mode: TX-1310 nm, RX-1550 nm	N/A	12.42 miles (20 km)	BIDI LC
Single-mode: TX-1550 nm, RX-1310 nm	N/A	12.42 miles (20 km)	BIDI LC

Table 5-5. 100-Mbps Fast Ethernet Collision Domain.

Cable Type	Maximum Cable Length	Connector
Category 5, 5e, or 6 100-ohm, UTP or STP	328 ft. (100 m)	RJ-45

### 6. Cable Labeling and Connection Records

When planning a network installation, label the opposing ends of cables and record where each cable is connected. This will allow users to easily locate interconnected devices, isolate faults, and change your topology without unnecessary time consumption.

To best manage the physical implementations of your network, follow these guidelines:

- Clearly label the opposing ends of each cable
- Using your building's floor plans, draw a map of the location of all network-connected equipment. For each piece of equipment, identify the devices to which it is connected.
- Note the length of each cable and the maximum cable length supported by the switch ports.
- For ease of understanding, use a location-based key when assigning prefixes to your cable labeling.
- Use sequential numbers for cables that originate from the same equipment.
- Differentiate between racks by naming accordingly.
- Label each separate piece of equipment.
- Display a copy of your equipment map, including keys to all abbreviations at each equipment rack.

## 7. Troubleshooting

Most problems are caused by the following situations. Check for these items first when starting your troubleshooting:

- Connecting to devices that have a fixed full-duplex configuration. The RJ-45 ports are configured as “Auto.” That is, when connecting to devices, the switch will operate in one of two ways to determine the link speed and the communication mode (half-duplex or full-duplex).
- If the connected device is also configured to Auto, the switch will automatically negotiate both link speed and communication mode.
- If the connected device has a fixed configuration, for example 100 Mbps, at half or full duplex, the switch will automatically sense the link speed, but will default to a communication mode of half-duplex.

Because the Gigabit Managed PoE+ Switches devices behave in this way (in compliance with the IEEE 802.3 standard), if a device connected to the switch has a fixed configuration at full duplex, the device will not connect correctly to the switch. The result will be high error rates and very inefficient communications between the switch and the device.

Make sure all devices connected to the Gigabit Managed PoE+ Switch are configured to autonegotiate, or are configured to connect at half-duplex (all hubs are configured this way, for example).

- **Faulty or loose cables.** Look for loose or obviously faulty connections. If they appear to be OK, make sure the connections are snug. If that does not correct the problem, try a different cable.
- **Non-standard cables.** Non-standard and mis-wired cables may cause network collisions and other network problems, and can seriously impair network performance. Use a new correctly-wired cable. For pinouts and correct cable wiring, we recommend using a category 5 cable tester for every 100Base-TX and 1000BASE-T network installation.
- **Improper Network Topologies.** Make sure you have a valid network topology. If you no longer experience the problems, the new topology is probably at fault. In addition, make sure that your network topology contains no data path loops.
- **Check the port configuration.** A port on your Gigabit Managed PoE+ Switch may not be operating as you expect because it has been put into a “ blocking” state by Spanning Tree, GVRP (automatic VLANs), or LACP (automatic trunking). (Note that the normal operation of the Spanning Tree, GVRP, and LACP features may put the port in a blocking state.) Or, the port just may have been configured as disabled through software.

Table 7-1. Troubleshooting Chart.

Symptom	Action
POWER LED is Off	<ul style="list-style-type: none"> <li>• Check connections between the switch, the power cord and the wall outlet.</li> <li>• Contact Black Box Technical Support at 877-877-2269 or info@blackbox.com.</li> </ul>
Link LED is Off	<ul style="list-style-type: none"> <li>• Verify that the switch and attached device are powered on.</li> <li>• Be sure the cable is plugged into the switch and corresponding device.</li> <li>• If the switch is installed in a rack, check the connections to the punch-down block and patch panel.</li> <li>• Verify that the proper cable types is used and its length does not exceed specified limits.</li> <li>• Check the adapter on the attached device and cable connections for possible defects. Replace the defective adapter or cable if necessary.</li> </ul>

### 8. Power and Cooling Problems

#### 8.1 Installation

If the power indicator does not turn on when the power cord is plugged in, you may have a problem with the power outlet, power cord, or internal power supply. However, if the unit powers off after running for a while, check for loose power connections, power losses or surges at the power outlet. If you still cannot isolate the problem, the internal power supply may be defective. Verify that all system components have been properly installed. If one or more components appear to be malfunctioning (such as the power cord or network cabling), test them in an alternate environment where you are sure that all the other components are functioning properly.

#### 8.2 In-Band Access

You can access the management agent in the switch from anywhere within the attached network using Telnet, via a Web browser. You must first configure the switch with a valid IP address, subnet mask, and default gateway. If you have trouble establishing a link to the management agent, check to see if you have a valid network connection. Then verify that you entered the correct IP address. Also, be sure the port through which you are connecting to the switch has not been disabled. If it has not been disabled, then check the network cabling that runs between your remote location and the switch.

*NOTE: The management agent accepts up to four simultaneous Telnet sessions. If the maximum number of sessions already exists, an additional Telnet connection will not be able to log into the system.*

## 9. Cables

### 9.1 Twisted-Pair Cable and Pin Assignments

For 10/100BASE-TX connections, the twisted-pair cable must have two pairs of wires. For 1000BASE-T connections, the twisted-pair cable must have four pairs of wires. Each wire pair is identified by two different colors. For example, one wire might be green and the other, green with white stripes. Also, an RJ-45 connector must be attached to both ends of the cable.

**CAUTION:** DO NOT plug a phone jack connector into any RJ-45 port. Use only twisted-pair cables with RJ-45 connectors that conform to FCC standards.

**CAUTION:** Each wire pair must be attached to the RJ-45 connectors in a specific orientation.

The figure below illustrates how the pins on the RJ-45 connector are numbered. Be sure to hold the connectors in the same orientation when attaching the wires to the pins.

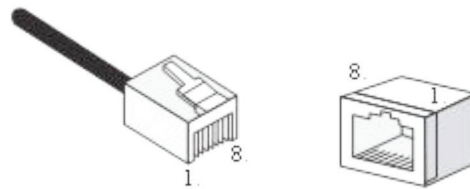

Figure 9-1. RJ-45 connector pin numbers.

### 9.2 10BASE-T/100BASE-TX Pin Assignments

Use unshielded twisted-pair (UTP) or shielded twisted-pair (STP) cable for RJ-45 connections: 100-ohm Category 3 or better cable for 10 Mbps connections, or 100-ohm Category 5 or better cable for 100 Mbps connections. Also be sure that the length of any twisted-pair connection does not exceed 328 feet (100 meters).

The RJ-45 ports on the switch base unit support automatic MDI/MDI-X operation, so you can use straight-through cables for all network connections to PCs or servers, or to other switches or hubs. In straight-through cable, pins 1, 2, 3, and 6, at one end of the cable, are connected straight through to pins 1, 2, 3, and 6 at the other end of the cable. When using any RJ-45 port on this switch, you can use either straight-through or crossover cable.

Table 9-1. 10/100BASE-TX MDI and MDI-X Port Pinouts.

Pin	MDI Signal Name	MDI-X Signal Name
1	Transmit Data plus (TD+)	Receive Data plus (RD+)
2	Transmit Data minus (TD-)	Receive Data minus (RD-)
3	Receive Data plus (RD+)	Transmit Data plus (TD+)
6	Receive Data minus (RD-)	Transmit Data minus (TD-)
4, 5, 7, 8	Not used	Not used

**NOTE:** The "+" and "-" signs represent the polarity of the wires that make up each wire pair

### 9.3 Straight-Through Wiring

If the twisted-pair cable is to join two ports and only one of the ports has an internal crossover (MDI-X), the two pairs of wires must be straight-through. (When auto-negotiation is enabled for any RJ-45 port on this switch, you can use either straight-through or crossover cable to connect to any device type.)

You must connect all four wire pairs as shown in the following diagram to support Gigabit Ethernet.

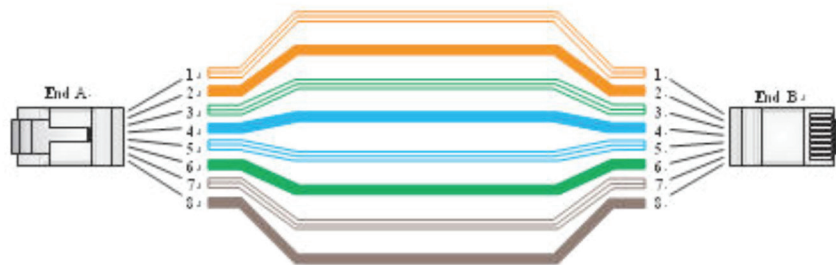

Figure 9-2. EIA/TIA 568B RJ-45 wiring standard 10/100BASE-TX straight-through cable.

## 9.4 Crossover Wiring

If the twisted-pair cable is to join two ports and either both ports are labeled with an “X” (MDI-X) or neither port is labeled with an “X” (MDI), a crossover must be implemented in the wiring. (When auto-negotiation is enabled for any RJ-45 port on this switch, you can use either straight-through or crossover cable to connect to any device type.)

You must connect all four wire pairs as shown in the following diagram to support Gigabit Ethernet.



Figure 9-3. EIA/TIA 568B RJ-45 Wiring Standard 10/100BASE-TX Crossover Cable.

## 9.5 1000BASE-T Pin Assignments

All 1000BASE-T ports support automatic MDI/MDI-X operation, so you can use straight-through cables for all network connections to PCs or servers, or to other switches or hubs.

The table below shows the 1000BASE-T MDI and MDI-X port pinouts. These ports require that all four pairs of wires be connected. Note that for 1000BASE-T operation, all four pairs of wires are used for both transmit and receive.

Use 100-ohm Category 5, 5e or 6 unshielded twisted-pair (UTP) or shielded twisted-pair (STP) cable for 1000BASE-T connections. Also be sure that the length of any twisted-pair connection does not exceed 328 feet (100 meters).

Table 9-2. 1000BASE-T MDI and MDI-X pinouts.

Pin	MDI Signal Name	MDI-X Signal Name
1	Bi-directional Pair A Plus (BI_DA+)	Bi-directional Pair B Plus (BI_DB+)
2	Bi-directional Pair A Minus (BI_DA-)	Bi-directional Pair B Minus (BI_DB-)
3	Bi-directional Pair B Plus (BI_DB+)	Bi-directional Pair A Plus (BI_DA+)
4	Bi-directional Pair C Plus (BI_DC+)	Bi-directional Pair D Plus (BI_DD+)
5	Bi-directional Pair C Minus (BI_DC-)	Bi-directional Pair D Minus (BI_DD-)
6	Bi-directional Pair B Minus (BI_DB-)	Bi-directional Pair A Minus (BI_DA-)
7	Bi-directional Pair D Plus (BI_DD+)	Bi-directional Pair C Plus (BI_DC+)
8	Bi-directional Pair D Minus (BI_DD-)	Bi-directional Pair C Minus (BI_DC-)



## 9.6 Cable Testing for Existing Category 5 Cable

Installed Category 5 cabling must pass tests for Attenuation, Near-End Crosstalk (NEXT), and Far-End Crosstalk (FEXT). This cable testing information is specified in the ANSI/TIA/EIA-TSB-67 standard. Additionally, cables must also pass test parameters for Return Loss and Equal-Level Far-End Crosstalk (ELFEXT). These tests are specified in the ANSI/TIA/EIA-TSB-95 Bulletin, "The Additional Transmission Performance Guidelines for 100 Ohm 4-Pair Category 5 Cabling."

*NOTE: When testing your cable installation, be sure to include all patch cables between switches and end devices.*

## 9.7 Adjusting Existing Category 5 Cabling to Run 1000BASE-T

If your existing Category 5 installation does not meet one of the test parameters for 1000BASE-T, there are basically three measures that can be applied to try and correct the problem:

1. Replace any Category 5 patch cables with high-performance Category 5e or Category 6 cables.
2. Reduce the number of connectors used in the link.
3. Reconnect some of the connectors in the link.

## 9.8 Fiber Standards

The International Telecommunication Union (ITU-T) has standardized various fiber types for data networks. These are summarized in the following table.

Table 9-3. Fiber standards.

ITU-T Standard	Description	Application
G.651	Multimode Fiber 50/125-micron core	Short-reach connections in the 1300-nm or 850-nm band
G.652	Non-Dispersion-Shifted Fiber Single-mode, 9/125-micron core	Longer spans and extended reach. Optimized for operation in the 1310-nm band, but can also be used in the 1550-nm band.
G.652.C	Low Water Peak Non-Dispersion-Shifted Fiber Single-mode, 9/125-micron core	Longer spans and extended reach. Optimized for wavelength-division multiplexing (WDM) transmission across wavelengths from 1285 to 1625 nm. The zero dispersion wavelength is in the 1310-nm region.
G.653	Dispersion-Shifted Fiber Single-mode, 9/125-micron core	Longer spans and extended reach. Optimized for operation in the region from 1500 to 1600 nm.
G.654	1550-nm Loss-Minimized Fiber Single-mode, 9/125-micron core	Extended long-haul applications. Optimized for high-power transmission in the 1500 to 1600-nm region, with low loss in the 1550-nm band.
G.655	Non-Zero Dispersion-Shifted Fiber Single-mode, 9/125-micron core	Extended long-haul applications. Optimized for high-power dense wavelength-division multiplexing (DWDM) operation in the region from 1500 to 1600 nm.

### Appendix. Glossary

**10BASE-T:** IEEE 802.3 specification for 10 Mbps Ethernet over two pairs of Category 3, 4, or 5 UTP cable.

**100BASE-TX:** IEEE 802.3u specification for 100 Mbps Ethernet over two pairs of Category 5 UTP cable.

**1000BASE-LH:** Specification for long-haul Gigabit Ethernet over two strands of 9/125 micron core fiber cable.

**1000BASE-LX:** IEEE 802.3z specification for Gigabit Ethernet over two strands of 50/125, 62.5/125, or 9/125 micron core fiber cable.

**1000BASE-SX:** IEEE 802.3z specification for Gigabit Ethernet over two strands of 50/125 or 62.5/125 micron core fiber cable.

**1000BASE-T:** IEEE 802.3ab specification for Gigabit Ethernet over 100-ohm Category 5, 5e or 6 twisted-pair cable (using all four wire pairs).

**Auto-Negotiation:** Signaling method allowing each node to select its optimum operational mode (e.g., speed and duplex mode) based on the capabilities of the node to which it is connected.

**Bandwidth:** The difference between the highest and lowest frequencies available for network signals. Also synonymous with wire speed, the actual speed of the data transmission along the cable.

**Collision Domain:** Single CSMA/CD LAN segment.

**CSMA/CD:** CSMA/CD (Carrier Sense Multiple Access/Collision Detect) is the communication method employed by Ethernet, Fast Ethernet, and Gigabit Ethernet.

**End Station:** A workstation, server, or other device that does not forward traffic.

**Ethernet:** A network communication system developed and standardized by DEC, Intel, and Xerox, were using baseband transmission, CSMA/CD access, logical bus topology, and coaxial cable. The successor IEEE 802.3 standard provides for integration into the OSI model and extends the physical layer and media with repeaters and implementations that operate on fiber, thin coax and twisted-pair cable.

**Fast Ethernet:** A 100-Mbps network communication system based on Ethernet and the CSMA/ CD access method.

**Full Duplex:** Transmission method that allows two network devices to transmit and receive concurrently, effectively doubling the bandwidth of that link.

**Gigabit Ethernet:** A 1000-Mbps network communication system based on Ethernet and the CSMA/ CD access method.

**IEEE:** Institute of Electrical and Electronic Engineers.

**IEEE 802.3:** Defines carrier sense multiple access with collision detection (CSMA/CD) access method and physical layer specifications.

**IEEE 802.3AB:** Defines CSMA/CD access method and physical layer specifications for 1000BASE-T Gigabit Ethernet. (Now incorporated in IEEE 802.3-2005.)

**IEEE 802.3U:** Defines CSMA/CD access method and physical layer specifications for 100BASE- TX Fast Ethernet. (Now incorporated in IEEE 802.3-2005.)

**IEEE 802.3X:** Defines Ethernet frame start/stop requests and timers used for flow control on full-duplex links. (Now incorporated in IEEE 802.3-2005.)

**IEEE 802.3Z:** Defines CSMA/CD access method and physical layer specifications for 1000BASE Gigabit Ethernet. (Now incorporated in IEEE 802.3-2005.)

**LAN Segment:** Separate LAN or collision domain.

**LED:** Light emitting diode used for monitoring a device or network condition.

**Local Area Network (LAN):** A group of interconnected computer and support devices.

**Media Access Control (MAC):** A portion of the networking protocol that governs access to the transmission medium, facilitating the exchange of data between network nodes.

**MIB:** An acronym for Management Information Base. It is a set of database objects that contains information about the device.

**Modal Bandwidth:** Bandwidth for multimode fiber is referred to as modal bandwidth, because it varies with the modal field (or core diameter) of the fiber. Modal bandwidth is specified in units of MHz per km, which indicates the amount of bandwidth supported by the fiber for a one km distance.

**Network Diameter:** Wire distance between two end stations in the same collision domain.

**RJ-45 Connector:** A connector for twisted-pair wiring.

**Switched Ports:** Ports that are on separate collision domains or LAN segments.

**TIA:** Telecommunications Industry Association.

**Transmission Control Protocol/Internet Protocol (TCP/IP):** Protocol suite that includes TCP as the primary transport protocol, and IP as the network layer protocol.

**User Datagram Protocol (UDP):** UDP provides a datagram mode for the packet-switched communications. It uses the IP as the underlying transport mechanism to provide access to IP-like services.

UDP packets are delivered just like IP packets – connection-less datagrams that may be discarded before reaching their targets. UDP is useful when TCP would be too complex, too slow, or just unnecessary.

**Unshielded Twisted-Pair Cable (UTP):** Unshielded twisted-pair cable.

**Virtual LAN (VLAN):** A Virtual LAN is a collection of network nodes that share the same collision domain regardless of their physical location or connection point in the network. A VLAN serves as a logical workgroup with no physical barriers, allowing users to share information and resources as though located on the same LAN.

**Black Box Tech Support: FREE! Live. 24/7.**

Tech support the  
way it should be.



Great tech support is just 60 seconds away at 877-877-2269 or [blackbox.com](http://blackbox.com).

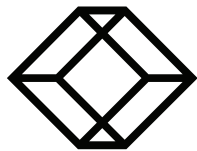

**BLACK BOX®**

### About Black Box

Black Box provides an extensive range of networking and infrastructure products. You'll find everything from cabinets and racks and power and surge protection products to media converters and Ethernet switches all supported by free, live 24/7 Tech support available in 60 seconds or less.

© Copyright 2018. Black Box Corporation. All rights reserved. Black Box® and the Double Diamond logo are registered trademarks of BB Technologies, Inc. Any third-party trademarks appearing in this manual are acknowledged to be the property of their respective owners.

LPB2910A Installation and Getting Started Guide, version 2

877-877-2269 | [blackbox.com](http://blackbox.com)