

Panasonic[®]

Basic Operating Instructions

Digital Camera

Model No. **DMC-FZ1000**



LUMIX

Please read these instructions carefully before using this product, and save this manual for future use.

More detailed instructions on the operation of this camera are contained in “Operating Instructions for advanced features (PDF format)” in the supplied DVD. Install it on your PC to read it.



Web Site: <http://www.panasonic.com>

Model number suffix “EB” denotes UK model.

EB

SQT0214-1
F0614YS1074

Dear Customer,

We would like to take this opportunity to thank you for purchasing this Panasonic Digital Camera. Please read these Operating Instructions carefully and keep them handy for future reference. Please note that the actual controls and components, menu items, etc. of your Digital Camera may look somewhat different from those shown in the illustrations in these Operating Instructions.

Carefully observe copyright laws.

- Recording of pre-recorded tapes or discs or other published or broadcast material for purposes other than your own private use may infringe copyright laws. Even for the purpose of private use, recording of certain material may be restricted.

Information for Your Safety

WARNING:

To reduce the risk of fire, electric shock or product damage,

- Do not expose this unit to rain, moisture, dripping or splashing.
- Use only the recommended accessories.
- Do not remove covers.
- Do not repair this unit by yourself. Refer servicing to qualified service personnel.

The socket outlet shall be installed near the equipment and shall be easily accessible.

■ Product identification marking

Product	Location
Digital Camera	Bottom
Battery charger	Bottom

CE 1731

Declaration of Conformity (DoC)

Hereby, "*Panasonic Corporation*" declares that this product is in compliance with the essential requirements and other relevant provisions of Directive 1999/5/EC.

Customers can download a copy of the original DoC to our R&TTE products from our DoC server:

<http://www.doc.panasonic.de>

Contact to Authorized Representative:

Panasonic Marketing Europe GmbH, Panasonic Testing Centre, Winsbergring 15, 22525 Hamburg, Germany

This product is intended for general consumer. (Category 3)

This product on purpose to connect to access point of 2.4 GHz WLAN.

■ About the battery pack

CAUTION

- Danger of explosion if battery is incorrectly replaced. Replace only with the type recommended by the manufacturer.
- When disposing of the batteries, please contact your local authorities or dealer and ask for the correct method of disposal.

- Do not heat or expose to flame.
- Do not leave the battery(ies) in a car exposed to direct sunlight for a long period of time with doors and windows closed.

Warning

Risk of fire, explosion and burns. Do not disassemble, heat above 60 °C or incinerate.

■ About the battery charger

CAUTION!

To reduce the risk of fire, electric shock or product damage,



- **Do not install or place this unit in a bookcase, built-in cabinet or in another confined space. Ensure this unit is well ventilated.**

- The battery charger is in the standby condition when the AC power supply cord is connected. The primary circuit is always "live" as long as the power cord is connected to an electrical outlet.

Caution for AC mains lead

For your safety, please read the following text carefully.

This appliance is supplied with a moulded three pin mains plug for your safety and convenience.

A 5-ampere fuse is fitted in this plug. Should the fuse need to be replaced please ensure that the replacement fuse has a rating of 5-ampere and that it is approved by ASTA or BSI to BS1362. Check for the ASTA mark  or the BSI mark  on the body of the fuse.

If the plug contains a removable fuse cover you must ensure that it is refitted when the fuse is replaced.

If you lose the fuse cover the plug must not be used until a replacement cover is obtained.

A replacement fuse cover can be purchased from your local dealer.

■ Before use

Remove the connector cover.

■ How to replace the fuse

The location of the fuse differ according to the type of AC mains plug (figures A and B). Confirm the AC mains plug fitted and follow the instructions below.

Illustrations may differ from actual AC mains plug.

1. Open the fuse cover with a screwdriver.

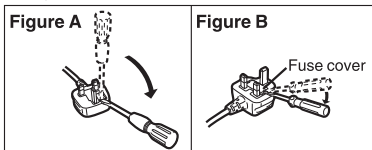

2. Replace the fuse and close or attach the fuse cover.

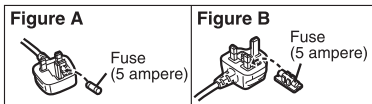

Cautions for Use

- Do not use any other USB connection cables except the supplied one or a genuine Panasonic USB connection cable (DMW-USBC1: optional).
- Use a "High Speed HDMI micro cable" with the HDMI logo.
Cables that do not comply with the HDMI standards will not work.
"High Speed HDMI micro cable" [Type D–Type A plug, up to 2 m (6.6 feet) long]
- Always use a genuine Panasonic AV cable (DMW-AVC1: optional).
- Always use a genuine Panasonic remote shutter (DMW-RSL1: optional).

Keep this unit as far away as possible from electromagnetic equipment (such as microwave ovens, TVs, video games etc.).

- If you use this unit on top of or near a TV, the pictures and/or sound on this unit may be disrupted by electromagnetic wave radiation.
- Do not use this unit near cell phones because doing so may result in noise adversely affecting the pictures and/or sound.
- Recorded data may be damaged, or pictures may be distorted, by strong magnetic fields created by speakers or large motors.
- Electromagnetic wave radiation may adversely affect this unit, disturbing the pictures and/or sound.
- If this unit is adversely affected by electromagnetic equipment and stops functioning properly, turn this unit off and remove the battery or disconnect AC adaptor (DMW-AC10E: optional). Then reinsert the battery or reconnect AC adaptor and turn this unit on.

Do not use this unit near radio transmitters or high-voltage lines.

- If you record near radio transmitters or high-voltage lines, the recorded pictures and/or sound may be adversely affected.

-
- Before cleaning the camera, remove the battery or the DC coupler (DMW-DCC8: optional), or disconnect the power plug from the outlet.
 - Do not press the monitor with excessive force.
 - Do not press the lens with excessive force.
 - Do not spray the camera with insecticides or volatile chemicals.
 - Do not keep rubber or plastic products in contact with the camera for a long period of time.
 - Do not use solvents such as benzine, thinner, alcohol, kitchen detergents, etc., to clean the camera, since it may deteriorate the external case or the coating may peel off.
 - Do not leave the camera with the lens facing the sun, as rays of light from the sun may cause it to malfunction.
 - Always use the supplied cords and cables.
 - Do not extend the cords or the cables.
 - During access (image writing, reading and deleting, formatting etc.), do not turn this unit off, remove the battery, card or disconnect the AC adaptor (DMW-AC10E: optional). Furthermore, do not subject the camera to vibration, impact or static electricity.
 - The data on the card may be damaged or lost due to electromagnetic waves, static electricity or breakdown of the camera or the card. We recommend storing important data on a PC etc.
 - Do not format the card on your PC or other equipment. Format it on the camera only to ensure proper operation.
-

- **The battery is not charged when the camera is shipped. Charge the battery before use.**
 - **The battery is a rechargeable lithium ion battery. If the temperature is too high or too low, the operating time of the battery will become shorter.**
 - The battery becomes warm after using and during and after charging. The camera also becomes warm during use. This is not a malfunction.
 - **Do not leave any metal items (such as clips) near the contact areas of the power plug or near the batteries.**
 - Store the battery in a cool and dry place with a relatively stable temperature: [Recommended temperature: 15 °C to 25 °C (59 °F to 77 °F), Recommended humidity: 40%RH to 60%RH]
 - **Do not store the battery for a long time while fully charged.** When storing the battery for a long period of time, we recommend charging it once a year. Remove the battery from the camera and store it again after it has completely discharged.
-

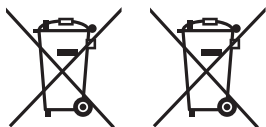

These symbols indicate separate collection of waste electrical and electronic equipment or waste batteries. More detailed information is contained in "Operating Instructions for advanced (PDF format)".

Contents

Information for Your Safety	2
• Cautions for Use.....	5

Before Use

Care of the camera.....	9
Accessories	10
Names and Functions of Components	11
Preparations before Recording	13
• Attaching the Lens Hood	13
• Attaching the Lens Cap	13
• Attaching the Shoulder Strap.....	14
• Monitor	14
• [LVF] button (Switching the Monitor/ Viewfinder)	15
• Charging the Battery	16
• Inserting and Removing the Card (optional)/the Battery.....	17
• Formatting the card (initialisation)....	18
• Setting Date/Time (Clock Set).....	18

Basic Operation

Setting the Menu	19
• Calling frequently-used menus instantly (Quick Menu)	20
Tips for taking good pictures.....	20
Selecting the Recording Mode.....	21
Taking a Still picture	22
Recording Motion Picture	23
Switching the Information Displayed on the recording screen	25
Playing Back Pictures/ Motion Pictures	26
• Playing Back Pictures.....	26
• Playing Back Motion Pictures.....	27
Deleting Pictures.....	28

Recording Modes

Taking Pictures using the Automatic Function (Intelligent Auto Mode)	29
• Recording night scenes ([iHandheld Night Shot])	31
• Combining pictures into a single picture with rich gradation ([iHDR]).....	31
• Taking a picture with a blurred background (Defocus Control).....	31
Taking Pictures with Your Favourite Settings (Programme AE Mode).....	32
Taking Pictures by Specifying the Aperture/Shutter Speed	33
• Aperture-Priority AE Mode.....	33
• Shutter-Priority AE Mode	33
• Manual Exposure Mode.....	34
• Confirm the Effects of Aperture and Shutter Speed (Preview Mode)	34
Recording motion pictures with manually set aperture value/shutter speed (Creative Video Mode)	35
• Recording motion pictures in 4K....	35
Taking Pictures that match the Scene being recorded (Scene Guide Mode)	36
Taking Pictures with different image effects (Creative Control Mode)	37
Registering your preferred settings (Custom Mode)	37
• Registering Personal Menu Settings (Registering custom settings).....	37
Adjusting the White Balance.....	38
Setting the Picture Quality and Size	39
• Setting the aspect ratio of pictures	39
• Setting the number of pixels.....	39
• Setting the compression rate of pictures ([Quality])	40
Taking Pictures with Auto Focus	41
• About the focus mode (AFS/AFF/ AFC).....	42

Taking Pictures with Manual Focus	43
Taking Close-up Pictures	45
Fixing the Focus and the Exposure (AF/AE Lock)	45
Compensating the Exposure	46
Setting the Light Sensitivity	46
Selecting the Method for Measuring Brightness ([Metering Mode])	47
Setting the Shutter Type	48
Select a Drive Mode	49
Taking Pictures using Burst Mode	50
Taking Pictures using Auto Bracket	51
Taking Pictures with the Self-timer	51
Taking Pictures Automatically at Set Intervals ([Time Lapse Shot])	52
Creating Stop Motion Pictures ([Stop Motion Animation])	54
Functions Customised for Various Subjects and Purposes	56
• Disabling Operational Sounds and the Output of Light at once ([Silent Mode])	56
• Displaying the centre of the screen ([Center Marker])	56
• Checking areas that may be white saturated ([Zebra Pattern])	57
Optical Image Stabiliser	58
Taking Pictures with the Zoom	59
Taking pictures by using the flash	61
• Changing Flash Mode.....	61

Using the Wi-Fi function

Wi-Fi® function/NFC function	62
Controlling with a Smartphone/Tablet	63
• Installing the smartphone/tablet app “Image App”.....	63
• Connecting to a smartphone/tablet	63
• Taking pictures via a smartphone/tablet (remote recording).....	67
• Playing back images in the camera	67
• Saving images stored in the camera	67
• Sending images in the camera to an SNS.....	68
Setting up a connection to a PC via a wireless access point	69

Others

Playing Back Pictures on a TV Screen	71
Saving still pictures and motion pictures on your PC	72
• About the supplied software	72
Monitor Display/Viewfinder Display	75
Message Display	78
Menu list	79
• [Rec]	79
• [Motion Picture]	81
• [Custom]	82
• [Setup]	84
• [Playback]	85
Troubleshooting	86
Specifications	90
Digital Camera Accessory System ...	93
Reading the Operating Instructions (PDF format)	94

Care of the camera

Do not subject to strong vibration, shock, or pressure.

- The lens, monitor, or external case may be damaged if used in the following conditions.

It may also malfunction or image may not be recorded if you:

- Drop or hit the camera.
- Press hard on the lens or the monitor.
- **When camera is not in use or when using the playback feature, ensure that the lens is in the stored position, with lens cap on.**
- **There are times when rattling sounds or vibrations will come from the camera, but these are due to the motion of the aperture, the zoom and the motor and do not indicate a defect.**

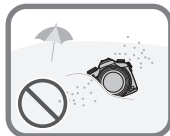
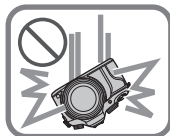

This camera is not dust/splash/water proof.

Avoid using the camera in places with a lot of dust, water, sand, etc.

- Liquid, sand and other foreign material may get into the space around the lens, buttons, etc. Be particularly careful since it may not just cause malfunctions, but it may also become irreparable.
 - Places with a lot of sand or dust.
 - Places where water can come into contact with this unit, such as when using it on a rainy day or at the beach.

■ About Condensation (When the lens, the viewfinder or monitor is fogged up)

- Condensation occurs when the ambient temperature or humidity changes. Be careful of condensation since it causes lens, viewfinder and monitor stains, fungus and camera malfunction.
- If condensation occurs, turn the camera off and leave it for about 2 hours. The fog will disappear naturally when the temperature of the camera becomes close to the ambient temperature.

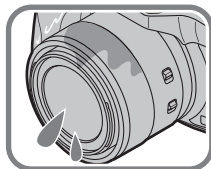

Accessories

Check that all the accessories are supplied before using the camera.

Product numbers correct as of June 2014. These may be subject to change.

- 1 Battery Pack
(Indicated as **battery pack** or **battery** in the text)
Charge the battery before use.
- 2 Battery Charger
(Indicated as **battery charger** or **charger** in the text)
- 3 AC Mains Lead
- 4 Lens Hood
- 5 Lens Cap
- 6 USB Connection Cable
- 7 DVD
 - Software:
Use it to install the software to your PC.
 - Operating Instructions for advanced features:
Use it to install to your PC.
- 8 Shoulder Strap
- 9 Hot shoe cover
 - This is attached to the camera at the time of purchase.

• SD Memory Card, SDHC Memory Card and SDXC Memory Card are indicated as **card** in the text.





• **The card is optional.**

• Consult the dealer or Panasonic if you lose the supplied accessories. (You can purchase the accessories separately.)

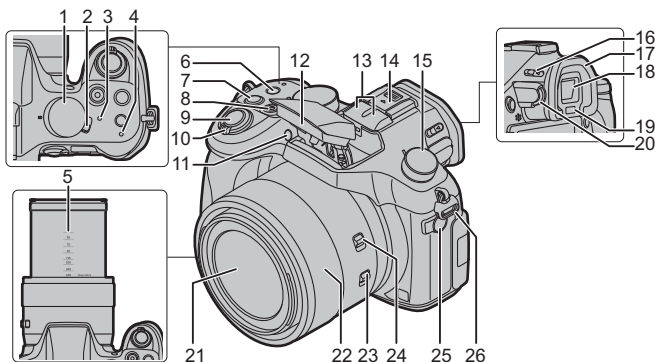
1  DMW-BLC12E	2  DE-A80A
3  K2CT3YY00034	4  SYQ0081
5  SYQ0103	6  K1HY08YY0031
7  SFM0023	8  VFC4453
9  VYF3522	

Names and Functions of Components



1	Mode dial (P21)	14	Hot shoe (Hot shoe cover) • Keep the Hot Shoe Cover out of reach of children to prevent swallowing.
2	Camera ON/OFF switch (P18)	15	Drive mode dial Single (P49):  Burst (P50):  Auto Bracket (P51):  Self-timer (P51):  Time Lapse/Animation (P52, 54): 
3	Status indicator (P18)	16	Flash open lever (P61) • The flash opens, and recording with the flash becomes possible.
4	Wi-Fi® connection lamp (P62)	17	Eye Cup
5	Focal length scale (35 mm film camera equivalent) • Indicates values for the [3:2] aspect ratio. (When recording motion pictures, refer to the focal length displayed on the screen.)	18	Viewfinder (P15)
6	[Wi-Fi] button (P62)/[Fn2] button	19	Eye sensor (P15)
7	[Fn1] button	20	Diopter adjustment dial (P15)
8	Motion picture button (P23)	21	Lens surface
9	Shutter button (P22)	22	Manual ring (P43, 59)
10	Zoom lever (P59)	23	O.I.S. switch (P58)
11	Self-timer indicator (P51)/ AF Assist Lamp	24	Manual ring selector switch (P43, 59)
12	Flash (P61)	25	[MIC] socket
13	Stereo microphone • Be careful not to cover the microphone with your finger. Doing so may make sound difficult to record.	26	Shoulder strap eyelet (P14)

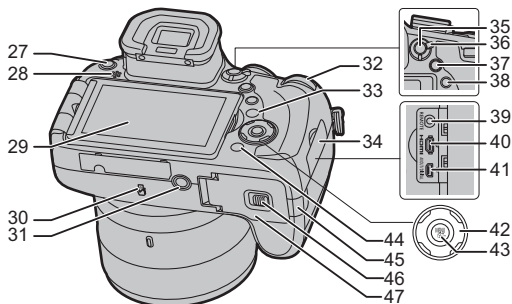

<p>27 [LVF] button (P15)/[Fn5] button</p>	<p>41 [AV OUT/DIGITAL] socket (P71, 74)</p>
<p>Speaker</p> <p>28 • Be careful not to cover the speaker with your finger. Doing so may make sound difficult to hear.</p>	<p>Cursor buttons</p> <ul style="list-style-type: none"> • These Operating instructions express the up, down, left, and right of the cursor button as ▲/▼/◀/▶. <p>42</p> <ul style="list-style-type: none"> ▲/ISO button (P46) ▶/WB (White Balance) (P38) ◀/AF Mode button (P41) ▼/AF button (P45)
<p>29 Monitor (P14)</p>	<p>43 [MENU/SET] button (P19)</p>
<p>30 NFC antenna (P65)</p>	<p>44 / (Delete/Cancel) button (P28)/[Fn4] button</p>
<p>Tripod mount</p> <p>31 • A tripod with a screw length of 5.5 mm (0.22 inch) or more may damage this unit if attached.</p>	<p>DC coupler cover</p> <ul style="list-style-type: none"> • When using an AC adaptor, ensure that the Panasonic DC coupler (DMW-DCC8: optional) and AC adaptor (DMW-AC10E: optional) are used. • Always use a genuine Panasonic AC adaptor (DMW-AC10E: optional). • When using an AC adaptor, use the AC mains lead supplied with the AC adaptor. • It is recommended to use a fully charged battery or AC adaptor when recording motion pictures. • If while recording motion pictures using the AC adaptor and the power supply is cut off due to a power outage or if the AC adaptor is disconnected etc., the motion picture will not be recorded.
<p>Rear dial</p> <ul style="list-style-type: none"> • These Operating instructions describe operations of the rear dial as follows: <p>32</p>	<p>45</p>
<p>[DISP.] button (P25)</p> <p>33 • Each time this is pressed, the display on the monitor is switched.</p>	<p>46 Release lever (P17)</p>
<p>34 Terminal cover</p>	<p>47 Card/Battery door (P17)</p>
<p>35 [AF/AE LOCK] button (P45)</p>	
<p>36 Focus mode lever (P41, 43)</p>	
<p>37 [Q.MENU] button (P20)/[Fn3] button</p>	
<p>38 (Playback) button (P26)</p>	
<p>39 [REMOTE] socket</p>	
<p>40 [HDMI] socket (P71)</p>	

Preparations before Recording

Attaching the Lens Hood

- Do not hold the lens hood in a way that twists or bends it.
- Check that the camera is turned off.
- Close the flash.

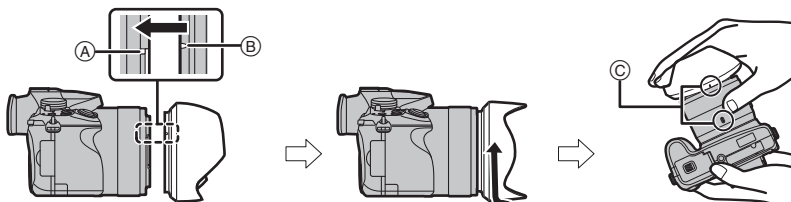

- 1 Align the mounting mark on the lens hood slightly above the mounting projection on the edge of the lens.**
 - (A) Mounting projection (Lens edge)
 - (B) Mounting mark (Lens hood)
- 2 Screw in the lens hood in the direction of the arrow.**
- 3 Continue to rotate the lens hood until you hear a “click” even if you feel some stiffness, and then align the mark on the bottom of the camera.**
 - (C) Rotate until the marks are aligned
 - Check that the lens hood is firmly attached and that it does not appear in the picture.

- When temporarily detaching and carrying the lens hood, we recommend attaching with the orientation reversed. Return it to the normal direction when taking pictures.
- When taking pictures with flash with the lens hood attached, the lower portion of the photo may turn dark (vignetting effect) and the control of the flash may be disabled because the photo flash may be obscured by the lens hood. We recommend detaching the lens hood.

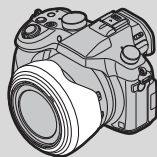

Attaching the Lens Cap

- When you turn the camera off or carry the camera, attach the lens cap to protect the surface of the lens.
- Make sure to detach the lens cap when turning this unit on.
- **Be careful not to lose the lens cap.**

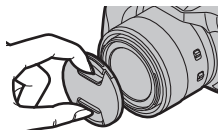

Attaching the Shoulder Strap

- We recommend attaching the shoulder strap when using the camera to prevent it from dropping.

- 1 Pass the shoulder strap through the hole at the shoulder strap eyelet.
- 2 Pass the shoulder strap through the stopper and fasten the shoulder strap.

(A) Pull the shoulder strap 2 cm (0.066 feet) or more.

- Attach the shoulder strap to the other side of the camera being careful not to twist it.

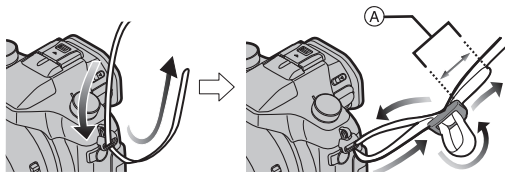

Monitor

At the time when this camera is purchased, the monitor is stowed in the camera body. Bring out the monitor as shown below.

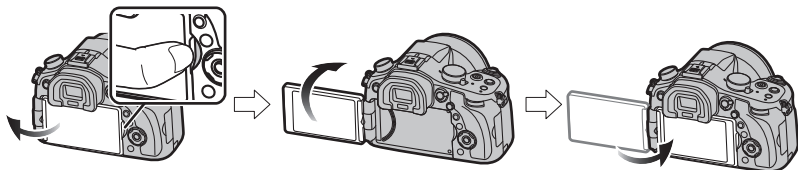

- 1 Place your finger in the notch on the right side of the monitor to open it. (Maximum 180°)
- 2 It can be rotated 180° forwards.
- 3 Return the monitor to its original position.

- Only rotate the monitor after opening it wide enough, and be careful not to use excessive force as it may be damaged.
- When not using the monitor it is recommended that you close it with the screen facing inward to prevent dirt and scratches.

Free angle shooting

The monitor can be rotated to suit your needs. This is convenient as it allows you to take pictures from various angles by adjusting the monitor.

Taking pictures at a high angle

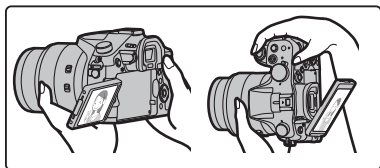

Taking pictures at a low angle

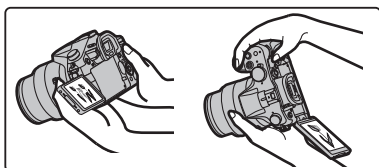

[LVF] button (Switching the Monitor/Viewfinder)

Press [LVF] to switch between the Monitor and Viewfinder.

- The monitor/viewfinder will switch as follows:

**Automatic viewfinder/
monitor switching***

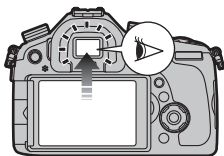

Viewfinder display*

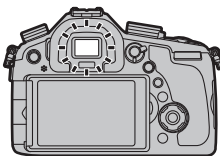

Monitor display

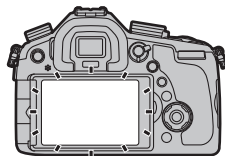

- * If [Eye Sensor AF] in the [Custom] menu is set to [ON], the camera automatically adjusts the focus as the eye sensor is activated.

■ Diopter adjustment

Adjust the diopter to suit your vision so that you can see the viewfinder clearly.

Look at the display on the viewfinder and rotate the diopter adjustment dial to where the screen is in focus.

- Ⓐ Diopter adjustment dial

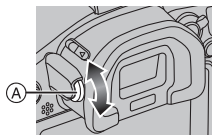

Charging the Battery

1 Attach the battery paying attention to the direction of the battery.

2 Connect the AC mains lead.

- The [CHARGE] indicator A lights up and charging begins.

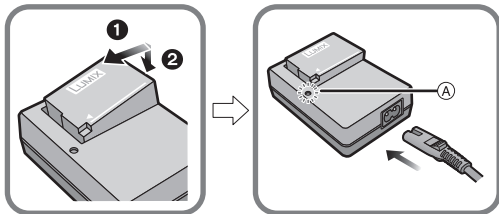

■ About the [CHARGE] indicator

On: Charging.

Off: Charging has completed.
(Disconnect the charger from the electrical socket and detach the battery after charging is completed.)

• When the [CHARGE] indicator flashes

- The battery temperature is too high or too low. It is recommended to charge the battery again in an ambient temperature of between 10 °C and 30 °C (50 °F and 86 °F).

■ Charging time

Charging time	Approx. 140 min
---------------	-----------------

- The indicated charging time is for when the battery has been discharged completely. The charging time may vary depending on how the battery has been used. The charging time for the battery in hot/cold environments or a battery that has not been used for a long time may be longer than normal.

■ Battery indication



- The indication turns red and blinks if the remaining battery power is exhausted. (The status indicator also blinks)
Recharge the battery or replace it with a fully charged battery.

Inserting and Removing the Card (optional)/the Battery

- Always use genuine Panasonic batteries (DMW-BLC12E).
- If you use other batteries, we cannot guarantee the quality of this product.

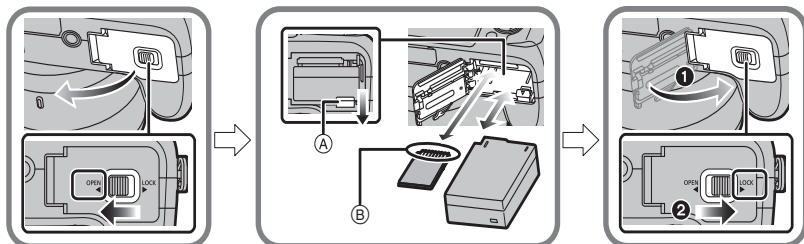

- **Battery:** Being careful about the battery orientation, insert all the way until you hear a locking sound and then check that it is locked by lever (A). Pull the lever (A) in the direction of the arrow to remove the battery.
 - **Card:** Push it securely all the way until you hear a “click” while being careful about the direction in which you insert it. To remove the card, push the card until it clicks, then pull the card out upright.
- (B): Do not touch the connection terminals of the card.

■ About cards that can be used with this unit

The following cards which conform to the SD standard can be used with this unit. (These cards are indicated as **card** in the text.)

SD Memory Card (8 MB to 2 GB)

SDHC Memory Card (4 GB to 32 GB)

SDXC Memory Card (48 GB, 64 GB)

- Keep the Memory Card out of reach of children to prevent swallowing.

■ About the motion picture recording and speed class

According to the [Rec Format] and [Rec Quality] of a motion picture, the required card differs. Use a card that meets the following ratings of the SD Speed Class or UHS Speed Class.

- SD Speed Class and UHS Speed Class are the speed standards regarding continuous writing. To check the class, see the labelled side, etc. of the card.

[Rec Format]	[Rec Quality]	Speed class	Label example
[AVCHD]	All	Class 4 or higher	CLASS 4 4
[MP4]	FHD/HD/VGA		
[MP4]	4K/ High Speed Video	UHS Speed Class 3	3

- Please confirm the latest information on the following website.

<http://panasonic.jp/support/global/cs/dsc/>

(This Site is English only.)

Formatting the card (initialisation)

Format the card before recording a picture with this unit.

Since data cannot be recovered after formatting, make sure to back up necessary data in advance.

Select the menu.

MENU → **[Setup]** → **[Format]**

- Confirmation screen is displayed. It is executed when [Yes] is selected.

Setting Date/Time (Clock Set)

- The clock is not set when the camera is shipped.

1 Turn the camera on.

- The status indicator **1** lights when you turn this unit on.

2 Press **[MENU/SET]**.

3 Press **◀/▶** to select the items (year, month, day, hour, minute), and press **▲/▼** to set.

To set the display order and the time display format.

- To display the setting screen of the order/time, select **[Style]** and then press **[MENU/SET]**.

4 Press **[MENU/SET]**.

5 Press **◀/▶** to select the home area, and then press **[MENU/SET]**.

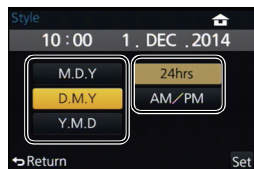
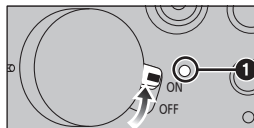

Setting the Menu

Example: In the [Rec] menu, change [Quality] from [Hi] to [Lo].

1 Press [MENU/SET].

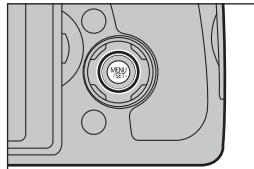

[Rec] (P79)	This menu lets you set the aspect ratio, number of pixels and other aspects of the pictures you are recording.
[Motion Picture] (P81)	This menu lets you set the [Rec Format], [Rec Quality], and other aspects for motion picture recording.
[Custom] (P82)	Operation of the unit, such as displaying of the screen and button operations, can be set up according to your preferences. Also, it is possible to register the modified settings.
[Setup] (P84)	This menu lets you perform the clock settings, select the operating beep tone settings and set other settings which make it easier for you to operate the camera. You can also configure the settings of Wi-Fi related functions.
[Playback] (P85)	This menu lets you set the Protection, Cropping or Print Settings, etc. of recorded pictures.

2 Press ▲/▼ to select the menu item and then press [MENU/SET].

3 Press ▲/▼ to select the setting and then press [MENU/SET].

- Depending on the menu item, its setting may not appear or it may be displayed in a different way.



■ Close the menu

Press [W/SH] repeatedly until the screen returns to the recording/playback screen.

- In Recording Mode, the menu screen can also be exited by pressing the shutter button halfway.

Switching to other menus

e.g.: Switching to the [Setup] menu from [Rec] menu.

- 1 Press **◀**.
- 2 Press **▲/▼** to select [**⌂**] or another of the menu toggle icons.
- 3 Press **[MENU/SET]**.
 - Select a menu item next and set it.



Calling frequently-used menus instantly (Quick Menu)

By using the Quick Menu, some of the menu settings can be easily found.

- The features that can be adjusted using Quick Menu are determined by the mode or a display style the camera is in.

- 1 Press **[Q.MENU]** to display the Quick Menu.
- 2 Rotate the rear dial to select the menu item, then press the rear dial.
- 3 Rotate the rear dial to select the setting.
- 4 Press **[Q.MENU]** to exit the menu once the setting is complete.

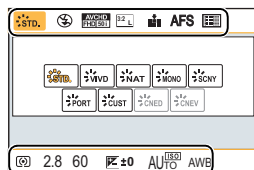
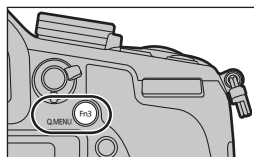

Tips for taking good pictures

Hold the camera gently with both hands, keep your arms still at your side and stand with your feet slightly apart.

- Do not cover the flash, the AF Assist lamp, the microphone or the speaker with your fingers or other objects.
- Be careful not to move the camera when you press the shutter button.
- Do not hold the lens barrel as you take pictures. There is a risk that your finger will be trapped as the lens retracts.

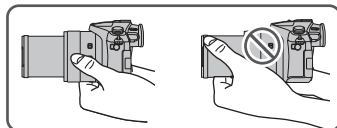
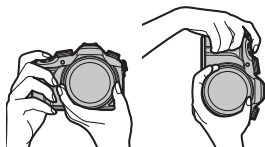

Selecting the Recording Mode

Switching the mode by rotating the mode dial.

- Rotate the mode dial slowly to select the desired mode.

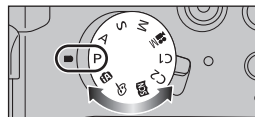

Intelligent Auto Mode (P29)

The subjects are recorded using settings automatically selected by the camera.

Intelligent Auto Plus Mode (P29)

Allows you to adjust the brightness and colour hue when in Intelligent Auto Mode.

P Programme AE Mode (P32)

Records at the aperture value and shutter speed set by the camera.

A Aperture-Priority AE Mode (P33)

The shutter speed is automatically determined by the aperture value you set.

S Shutter-Priority AE Mode (P33)

The aperture value is automatically determined by the shutter speed you set.

M Manual Exposure Mode (P34)

The exposure is adjusted by the aperture value and the shutter speed which are manually adjusted.

Creative Video Mode (P35)

Records a motion picture with the aperture value and the shutter speed you specify. In this recording mode, all the motion picture functions become available. For example, you can record motion pictures in 4K.

- * You cannot take still pictures.

C1 C2 Custom Mode (P37)

Use this mode to take pictures with previously registered settings.

Scene Guide Mode (P36)

This mode allows you to take pictures that match the scene being recorded.

Creative Control Mode (P37)

Record while checking the image effect.

Taking a Still picture

- Set the drive mode dial to [] (single recording).

- 1 Select the Recording Mode. (P21)**
- 2 Press the shutter button halfway to focus.**



(A) Aperture value

(B) Shutter speed

- Aperture value and shutter speed are displayed. (It will flash in red if the correct exposure is not achieved, except when set to flash.)

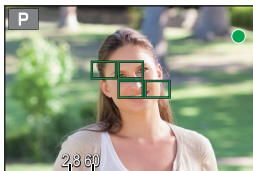

Focus	When the subject is focused	When the subject is not focused
Focus indication	On	Blinks
AF area	Green	—
Sound	Beeps 2 times	Beeps 4 times

- 3 Press the shutter button fully (push it in further), and take the picture.**



Recording Motion Picture

This camera can record full high definition motion pictures compatible with the AVCHD format or motion pictures recorded in MP4.

- You can operate the zoom even when recording motion pictures.
- If the Extra Optical Zoom is used before pressing the motion picture button, those settings will be cleared, so the shooting range will change dramatically.
- Confirm the settings for the O.I.S. switch and the manual ring selector switch before recording a motion picture. Be careful not to accidentally switch them during recording.
- Still picture recording is also possible during the motion picture recording by fully pressing the shutter button.

1 Start recording by pressing the motion picture button.

- Release the motion picture button right after you press it.
- The operational sound of the zoom or button operation may be recorded when it is operated during the recording of a motion picture.



2 Stop the recording by pressing the motion picture button again.

- (A) Elapsed recording time
- (B) Available recording time



■ Setting the format, size and frame rate

1 Select the menu.

MENU → **[Motion Picture]** → **[Rec Format]**

2 Press **▲/▼** to select the item and then press **[MENU/SET]**.

[AVCHD]	This data format is suitable for when playing back on a high-definition TV, etc.
[MP4]	This data format is suitable for when playing back on a PC, etc.

3 Press **▲/▼** to select **[Rec Quality]** and then press **[MENU/SET]**.

4 Press **▲/▼** to select the item and then press **[MENU/SET]**.

- Exit the menu after it is set.

When [AVCHD] is selected

Item	Size	Frame rate	Bit rate
[FHD/28M/50p]*1	1920×1080	50p	28 Mbps
[FHD/17M/50i]	1920×1080	50i	17 Mbps
[FHD/24M/25p]	1920×1080	50i*2	24 Mbps
[FHD/24M/24p]	1920×1080	24p	24 Mbps

*1 AVCHD Progressive

*2 The sensor output is 25 frames/second

When [MP4] is selected

Item	Size	Frame rate	Bit rate
[4K/100M/25p]*3	3840×2160	25p	100 Mbps
[FHD/28M/50p]	1920×1080	50p	28 Mbps
[FHD/20M/25p]	1920×1080	25p	20 Mbps
[HD/10M/25p]	1280×720		10 Mbps
[VGA/4M/25p]	640×480		4 Mbps

*3 These can be set only in Creative Video Mode.

Switching the Information Displayed on the recording screen

Press [DISP.] to change.

- You can select between [] (monitor style) and [] (viewfinder style) for each of the monitor and the viewfinder display screen using [Monitor Disp. Style] and [LVF Disp.Style] in the [Custom] menu.

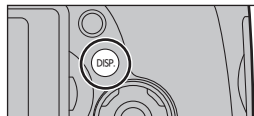

[] monitor style

- Screen will switch as follows (Example of monitor display):

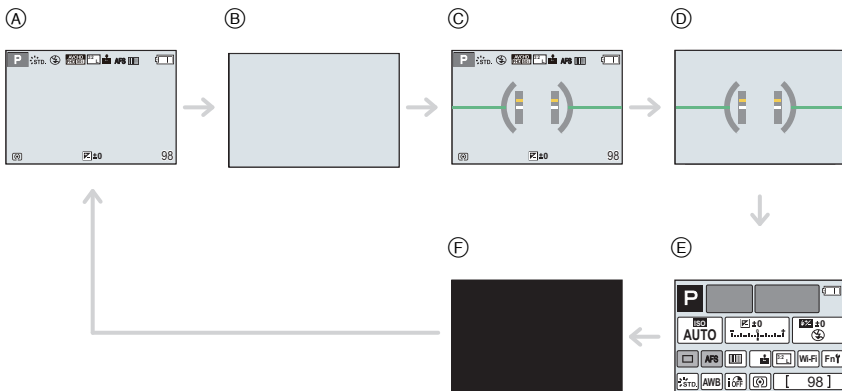

- (A) With information
- (B) Without information
- (C) With information (tilt sensor display)
- (D) Without information (tilt sensor display)
- (E) On-monitor recording information*
- (F) Turned off

[] viewfinder style

- Screen will switch as follows (Example of display on viewfinder):

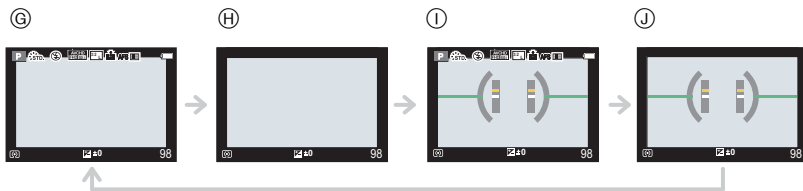

- (G) With information (detailed information)
- (H) With information
- (I) With information (detailed information, tilt sensor display)
- (J) With information (tilt sensor display)

* It is displayed when the [Monitor Info. Disp.] of the [Custom] menu is set to [ON].

Playing Back Pictures/Motion Pictures

Playing Back Pictures

- 1 Press [▶].
- 2 Press ◀/▶.

- ◀: Play back the previous picture
- ▶: Play back the next picture



■ To finish playback

Press [▶] again, press the motion picture button or press the shutter button halfway.

Using the Playback Zoom

Rotate the zoom lever towards [Q] (T).

1× → 2× → 4× → 8× → 16×

- When you change the magnification, the zoom position indication (A) appears for about 1 second.
- The more a picture is enlarged, the more its quality deteriorates.
- You can move the enlarged part by pressing ▲/▼/◀/▶ of the cursor button.

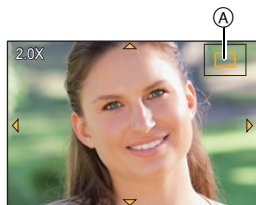

Displaying multiple screens (Multi Playback)

Rotate the zoom lever towards [W] (W).

1 screen → 12 screens → 30 screens → Calendar screen display

■ To return to Normal Playback

Press ▲/▼/◀/▶ to select a picture and then press [MENU/SET].

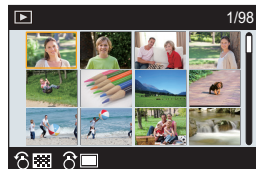

Displaying Pictures by Recording Date (Calendar Playback)

- 1 Rotate the zoom lever towards [] (W) to display the calendar screen.
- 2 Press ▲/▼/◀/▶ to select the date to be played back.
- 3 Press [MENU/SET] to display the images that are recorded in selected date.
- 4 Press ▲/▼/◀/▶ to select a picture and then press [MENU/SET].



Playing Back Motion Pictures

This unit was designed to play motion pictures using the AVCHD and MP4 formats.

In Playback Mode, select a picture with the motion picture icon ([]), and then press ▲ to play back.

Ⓐ Motion picture recording time

- After playback starts, the elapsed playback time is displayed on the screen.

For example, 8 minutes and 30 seconds is displayed as [8m30s].

- Some information (recording information, etc.) is not displayed for motion pictures recorded in [AVCHD].



■ Operations during Motion Picture Playback

▲	Play/Pause	▼	Stop
◀	Fast rewind*	▶	Fast forward*
	Frame-by-frame rewind (while pausing)		Frame-by-frame forward (while pausing)
Rear dial (left)	Reduce volume level	Rear dial (right)	Increase volume level

* The fast forward/rewind speed increases if you press ▶/◀ again.

- To play back the motion pictures recorded by this unit on a PC, use the "PHOTOfunSTUDIO" software on the DVD (supplied).

Deleting Pictures

Once deleted, pictures cannot be recovered.

- Pictures that are not in the DCF standard or those that are protected cannot be deleted.

To delete a single picture

- 1 In Playback Mode, select the picture to delete and then press [Fn4 /].

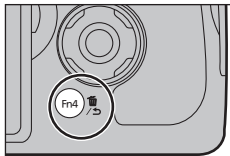

- 2 Press ▲ to select [Delete Single] and then press [MENU/SET].

- Confirmation screen is displayed.
- Picture is deleted by selecting [Yes].



To delete multiple pictures (up to 100*) or all the pictures

- * Picture groups are treated as a single picture.
(All the pictures in the selected picture group will be deleted.)

- 1 In Playback Mode, press [Fn4 /].
- 2 Press ▲/▼ to select [Delete Multi] or [Delete All] and then press [MENU/SET].

- [Delete All] → Confirmation screen is displayed.
- Pictures are deleted by selecting [Yes].
- It is possible to delete all pictures except the ones set as favourite when [All Delete Except Favorite] is selected with the [Delete All] set.

- 3 (When [Delete Multi] is selected)
Press ▲/▼/◀/▶ to select the picture, and then press [MENU/SET] to set. (Repeat this step.)

- appears on the selected pictures.
- If [MENU/SET] is pressed again, the setting is cancelled.

- 4 (When [Delete Multi] is selected)
Press ◀ to select [OK], and then press [MENU/SET].

- Confirmation screen is displayed.
- Pictures are deleted by selecting [Yes].

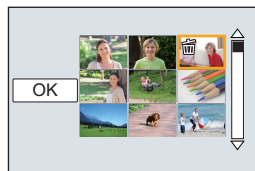

- Depending on the number of pictures to be deleted, it may take some time to delete them.

Taking Pictures using the Automatic Function

(Intelligent Auto Mode)

Recording Mode:  

When you wish to leave settings to the camera and record without thinking about them, use Intelligent Auto Plus Mode or Intelligent Auto Mode, which makes optimal settings for the subject and scene.

- Functions that can be set differ between Intelligent Auto Plus Mode and Intelligent Auto Mode.
(○: possible, —: not possible)

	Intelligent Auto Plus Mode	Intelligent Auto Mode
Setting the brightness	○	—
Setting the colour tone	○	—
Defocus Control (P31)	○	○

1 Set the mode dial to .

- The camera will switch to either the most recently used of Intelligent Auto Mode or Intelligent Auto Plus Mode.
At the time of purchase, the mode is set to Intelligent Auto Plus Mode.

2 Align the screen with the subject.

- When the camera identifies the optimum scene, the icon of the scene concerned is displayed in blue for 2 seconds, after which its colour changes to the usual red.
- If you press  and then press the shutter button halfway, the AF tracking function will be activated.

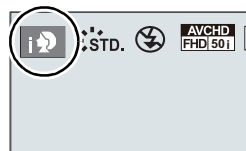

■ Switching between Intelligent Auto Plus Mode and Intelligent Auto Mode

1 Press [MENU/SET].

- Press , and press  or  to select  or .

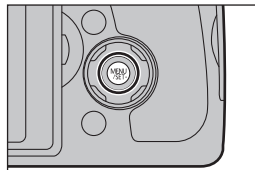

2 Press or to select or and then press [MENU/SET].

- Press [DISP.] to display the description of the selected mode.

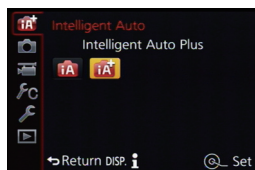

■ Scene Detection

When taking pictures





 →  [i-Portrait]	 [iHandheld Night Shot] ^{*2}
 [i-Scenery]	 [i-Food]
 [i-Macro]	 [i-Baby] ^{*3}
 [i-Night Portrait] ^{*1}	 [i-Sunset]
 [i-Night Scenery]	

*1 Only displayed when the built-in flash is open.

*2 Only displayed when [iHandheld Night Shot] is set to [ON].







*3 When [Face Recog.] is set to [ON], [] will be displayed for birthdays of registered faces already set only when the Face/Eye of a person 3 years old or younger is detected.

When recording motion pictures

 →  [i-Portrait]
 [i-Scenery]
 [i-Low Light]
 [i-Macro]

• [] is set if none of the scenes are applicable, and the standard settings are set.

■ About the flash

Flash mode is set to [] when the flash is closed, and [] (AUTO) when it is open. When the flash is open, the camera automatically sets [], [] (AUTO/Red-Eye Reduction), [], or [] to match the type of subject and brightness.

• **Open the flash when the flash is to be used. (P61)**

■ Functions that work automatically

- The following functions are performed automatically to allow the camera to make the optimal settings.
 - Scene Detection
 - Backlight Compensation
 - [Face/Eye Detection]
 - Auto White Balance
 - Intelligent ISO sensitivity control
 - [Red-Eye Removal]
 - [i.Resolution]
 - [i.Dynamic]
 - [Long Shtr NR]
 - [Quick AF]
 - [AF Assist Lamp]
 - [Level Shot]

Recording night scenes ([iHandheld Night Shot])

Recording Mode:  

When [iHandheld Night Shot] is set to [ON] and [iA+] is detected while taking handheld night shots, pictures of the night scenery will be taken at a high burst speed and composed into a single picture.

This mode is useful if you want to take stunning night shots with minimal jitter and noise, without using a tripod.

MENU →  [Rec] → [iHandheld Night Shot] → [ON]/[OFF]

- Flash is fixed to  (forced flash off).

Combining pictures into a single picture with rich gradation ([iHDR])

Recording Mode:  

When [iHDR] is set to [ON] and there is, for example, strong contrast between the background and the subject, multiple still pictures are recorded with differing exposures and combined to create a single still picture rich in gradation.

[iHDR] works automatically as needed. When it does, [HDR] is displayed on the screen.

MENU →  [Rec] → [iHDR] → [ON]/[OFF]

Taking a picture with a blurred background (Defocus Control)

Recording Mode:  

You can easily set the blurriness of the background while checking the screen.

1 Press the rear dial to display the setting screen.

- Each time the rear dial is pressed in Intelligent Auto Plus Mode, the camera switches among brightness setting operation, Defocus Control operation, and normal operation.
- Each time the rear dial is pressed in Intelligent Auto Mode, the camera switches between Defocus Control operation and normal operation.

2 Set the blurriness by rotating the rear dial.



Strong defocus



Weak defocus

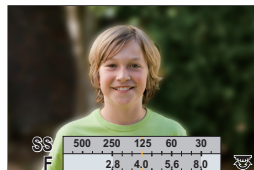

- Pressing  /  on the blurriness setting screen will cancel the setting.

Taking Pictures with Your Favourite Settings

(Programme AE Mode)

Recording Mode: **P**

The camera automatically sets the shutter speed and the aperture value according to the brightness of the subject.

You can take pictures with greater freedom by changing various settings in the [Rec] menu.

1 Set the mode dial to **[P]**.

2 Press the shutter button halfway and display the aperture value and shutter speed value on the screen.

- If the exposure is not adequate when the shutter button is pressed halfway, the aperture value and shutter speed turn red and blink.

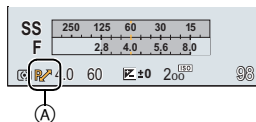

3 While the values are displayed (about 10 seconds), the perform Programme Shift by rotating the rear dial.

- It will switch between Programme Shift operation and Exposure Compensation operation (P46) every time the rear dial is pressed while the values are displayed.
- The Programme Shift indication **(A)** appears on the screen.
- To cancel Programme Shift, turn the camera off or rotate the rear dial until the Programme Shift indication disappears.

f Displaying/not displaying the exposure meter

MENU → **f**[Custom] → **[Expo.Meter]** → **[ON]/[OFF]**

- When **[Expo.Meter]** is set to **[ON]**, the exposure meter **(B)** will be displayed when performing Programme Shift, setting the aperture value or adjusting the shutter speed.
- Unsuitable areas of the range are displayed in red.
- When the exposure meter is not displayed, switch the display information for screen by pressing **[DISP.]**. (P25)
- The exposure meter disappears after approximately 4 seconds if no operation is performed.

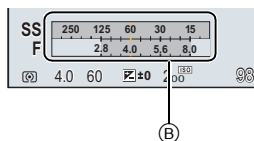

Taking Pictures by Specifying the Aperture/ Shutter Speed

Recording Mode: **A S M**

- The effects of the set aperture value and shutter speed will not be visible on the recording screen. To check on the recording screen, please use [Preview]. (P34)
- The brightness of the screen and the recorded pictures may differ. Check the pictures on the playback screen.

Available Aperture Value	Available Shutter Speed (Sec)
F2.8 to F8.0	B (Bulb)*, 60 to 1/4000th (with the mechanical shutter) 1 to 1/16000th (with the electronic shutter) * It can only be used with Manual Exposure Mode.

Aperture-Priority AE Mode

Set the aperture value to a higher number when you want a sharp focus background. Set the aperture value to a lower number when you want a soft focus background.

- 1 Set the mode dial to **[A]**.
- 2 Rotate the rear dial to set the aperture value.

- (A) Aperture value
(B) Exposure meter

- It will switch between aperture setting operation and Exposure Compensation operation every time the rear dial is pressed.

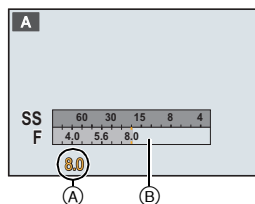

Shutter-Priority AE Mode

When you want to take a sharp picture of a fast moving subject, set with a faster shutter speed. When you want to create a trail effect, set to a slower shutter speed.

- 1 Set the mode dial to **[S]**.
- 2 Rotate the rear dial to set the shutter speed.

- (A) Shutter speed
(B) Exposure meter

- It will switch between shutter speed setting operation and Exposure Compensation operation every time the rear dial is pressed.

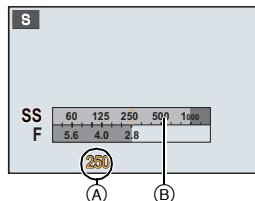

Manual Exposure Mode

Determine the exposure by manually setting the aperture value and the shutter speed. The Manual Exposure Assistance appears on the lower portion of the screen to indicate the exposure.

- 1 **Set the mode dial to [M].**
- 2 **Rotate the rear dial to set the aperture and shutter speed.**

- It will switch between aperture setting operation and shutter speed setting operation every time the rear dial is pressed.

- (A) Exposure meter
- (B) Aperture value
- (C) Shutter speed
- (D) Manual Exposure Assistance

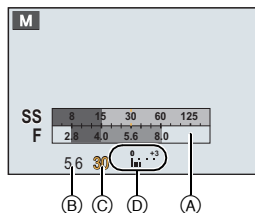

■ About [B] (Bulb)

If you set the shutter speed to [B], the shutter stays open while the shutter button is pressed fully (up to about 120 seconds).

The shutter closes if you release the shutter button.

Use this when you want to keep the shutter open for a long time to take pictures of fireworks, a night scene etc.

- It can only be used with Manual Exposure Mode.

Confirm the Effects of Aperture and Shutter Speed (Preview Mode)

Applicable modes:

• Confirm the effects of aperture:

You can check the depth of field (effective focus range) before taking a picture by closing the leaf shutter to the aperture value you set.

• Confirm the effects of shutter speed:

Movement can be confirmed by displaying the actual picture that will be taken with that shutter speed. When the shutter speed is set for high speed, display in the shutter speed preview will be displayed like a time-release film. It is used in cases such as stopping the movement of running water.

- 1 **Set a function button to [Preview].**
 - The following step is an example in which [Preview] is assigned to [Fn4].
- 2 **Switch to confirmation screen by pressing [Fn4].**
 - Screen is switched every time [Fn4] is pressed.

Normal recording screen → Effects of Aperture → Effects of Shutter Speed



Recording motion pictures with manually set aperture value/shutter speed (Creative Video Mode)

Recording Mode: 

It is possible to manually change the aperture and shutter speed and record motion pictures.

- 1 Set the mode dial to .
- 2 Select the menu.

MENU →  [Motion Picture] → [Exposure Mode]

- 3 Press **▲/▼** to select [P], [A], [S] or [M], and then press **[MENU/SET]**.
 - The operation for changing the aperture value or shutter speed is the same as the operation for setting the mode dial to **P**, **A**, **S** or **M**.
- 4 Start recording.
 - Press the motion picture button or the shutter button to start recording a motion picture. (Still pictures cannot be taken.)
- 5 Stop recording.
 - Press the motion picture button or the shutter button to stop recording a motion picture.

• Aperture value

- Set the aperture value to a higher number when you want a sharp focus background. Set the aperture value to a lower number when you want a soft focus background.

• Shutter speed

- When you want to take a sharp picture of a fast moving subject, set with a faster shutter speed. When you want to create a trail effect, set to a slower shutter speed.
- Manually setting a higher shutter speed may increase the noise on-screen due to the higher sensitivity.
- When subjects are recorded in an extremely bright place or under fluorescent/LED lighting, the colour tone or brightness of the image may change, or horizontal stripes may appear on the screen. In that case, change the Recording Mode or manually adjust the shutter speed to 1/60 or 1/100.

Recording motion pictures in 4K

You can create finely-detailed motion pictures in 4K by recording motion pictures with their size set to [4K] in [Rec Quality].

- You can record motion pictures in 4K only in Creative Video Mode.
- The angle of view of motion pictures in 4K is narrower than those of motion pictures in other sizes.
- When recording motion pictures in 4K, use a card rated as UHS Speed Class 3. (P17)



To record motion pictures in 4K:

- 1 Set the mode dial to .
- 2 Set **[Rec Format]** in the **[Motion Picture]** menu to **[MP4]**.
- 3 Set **[Rec Quality]** in the **[Motion Picture]** menu to **[4K/100M/25p]**.

Taking Pictures that match the Scene being recorded (Scene Guide Mode)

Recording Mode: 

If you select a scene to suit the subject and recording conditions with reference to the example images, the camera will set optimal exposure, colour, and focus, allowing you to record in a manner appropriate to the scene.

- 1 Set the mode dial to .
- 2 Press /  to select the scene.
- 3 Press [MENU/SET] to set.

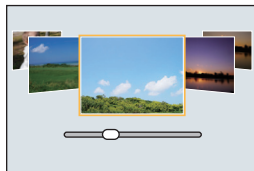

■ Switching the scene selection screen display

Press [DISP.] to switch the monitor screen.

■ [Panorama Shot]

- 1 Check the recording direction, and then press [MENU/SET].
 - A horizontal/vertical guide is displayed.



Changing the recording direction

- 1 Select the menu.
 - MENU** →  [Rec] → [Panorama Settings] → [Direction]
- 2 Select the recording direction, and then press [MENU/SET].

- 2 Press the shutter button halfway to focus.
- 3 Press the shutter button fully and move the camera in a small circle in the direction of the arrow on the screen.

Recording from left to right

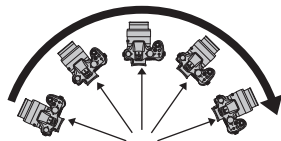

(A) Recording direction and panning (Guide)

- Move the camera at a constant speed.
- Pictures may not be able to be recorded properly if the camera is moved too fast or slow.

- 4 Press the shutter button once again to end the still picture recording.
 - Recording can also be ended by keeping the camera still while recording.
 - Recording can also be ended by moving the camera to the end of the guide.



Taking Pictures with different image effects

(Creative Control Mode)

Recording Mode: 

This mode records with additional image effects.

You can set the effects to add by selecting example images and checking them on the screen.

- 1 Set the mode dial to .
- 2 Press $\blacktriangle/\blacktriangledown$ to select the image effects (filters).
 - The image effect of the selected example image will be applied in a preview display .
- 3 Press [MENU/SET] to set.

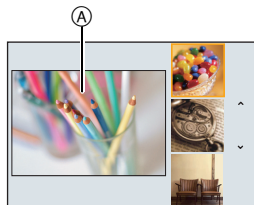

■ Switching the image effect (filter) selection screen display

Press [DISP.] to switch the monitor screen.

Registering your preferred settings (Custom Mode)

Recording Mode:  

You can register the current camera settings as custom settings.

If you then record in Custom Mode, you can use the registered settings.

- Initial setting of the Programme AE Mode is registered as the custom settings initially.

Registering Personal Menu Settings (Registering custom settings)

To allow recording using the same settings, up to 4 sets of current camera settings can be registered using [Cust.Set Mem.]. (C1, C2-1, C2-2, C2-3)

Preparations: Set in advance the Recording Mode you wish to save and select the desired menu settings on the camera.

- 1 Select the menu.

MENU → f_C [Custom] → [Cust.Set Mem.]

- 2 Press $\blacktriangle/\blacktriangledown$ to select the custom set to register and then press [MENU/SET].

- Confirmation screen is displayed. It is executed when [Yes] is selected.
Exit the menu after it is executed.

Adjusting the White Balance

Applicable modes:        

In sunlight, under incandescent lights or in other such conditions where the colour of white takes on a reddish or bluish tinge, this item adjusts to the colour of white which is closest to what is seen by the eye in accordance with the light source.

1 Press **▶ (WB)**.



2 Select the White Balance by rotating the rear dial.

[AWB]	Automatic adjustment
[☀]	When taking pictures outdoors under a clear sky
[☁]	When taking pictures outdoors under a cloudy sky
[🏠]	When taking pictures outdoors in the shade
[💡]	When taking pictures under incandescent lights
[WB]*	When taking pictures with the flash only * It will operate as [AWB] during motion picture recording.
[1]/[2]/[3]/[4]	The manually set value is used
[K]	When using the preset colour temperature setting

3 Press the rear dial to set.

Setting the White Balance manually

Set the White Balance value. Use to match the condition when taking photographs.

- Press **▶ (WB)**.
- Rotate the rear dial to select [**1**], [**2**], [**3**], or [**4**], and then press **▲**.
- Aim the camera at a sheet of white paper etc. so that the frame in the centre is filled by the white object only and then press [MENU/SET].

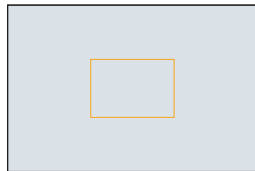

Setting the Picture Quality and Size

Setting the aspect ratio of pictures

Applicable modes: **P** **A** **S** **M** **C1** **C2**

MENU → **[Rec]** → **[Aspect Ratio]**

[4:3]	[Aspect Ratio] of a 4:3 TV
[3:2]	[Aspect Ratio] of a 35 mm film camera
[16:9]	[Aspect Ratio] of a high-definition TV, etc.
[1:1]	Square aspect ratio

Setting the number of pixels

Applicable modes: **P** **A** **S** **M** **C1** **C2**

MENU → **[Rec]** → **[Picture Size]**

When the aspect ratio is **[4:3]**.

Settings	Image size
[L] (17.5M)	4864×3648
[EXM] (9M)	3456×2592
[EXS] (4.5M)	2432×1824

When the aspect ratio is **[3:2]**.

Settings	Image size
[L] (20M)	5472×3648
[EXM] (10M)	3888×2592
[EXS] (5M)	2736×1824

When the aspect ratio is **[16:9]**.

Settings	Image size
[L] (17M)	5472×3080
[EXM] (8M)	3840×2160
[EXS] (2M)	1920×1080

When the aspect ratio is **[1:1]**.







Settings	Image size
[L] (13.5M)	3648×3648
[EXM] (6.5M)	2592×2592
[EXS] (3.5M)	1824×1824

Setting the compression rate of pictures ([Quality])

Applicable modes:         

Set the compression rate at which the pictures are to be stored.

MENU →  **[Rec]** → **[Quality]**

	A JPEG image in which image quality was given priority.
	A standard image quality JPEG image. This is useful for increasing the number of shots without changing the number of pixels.
	You can record a RAW image and a JPEG image ( or ) simultaneously.*1
	
	You can only record RAW images.*2

*1 If you delete a RAW file from the camera, the corresponding JPEG image will also be deleted.

*2 It is fixed to maximum recordable pixels ([L]) for each image aspect ratio.



About RAW

RAW format refers to a data format of images that have not been processed. Playback and editing of RAW images require the camera or the dedicated software.

You can make advanced adjustments by editing RAW images. For example, you can adjust the White Balance after taking pictures or save them in file formats that are capable of displaying them on a PC. Pictures taken in RAW format will have higher image quality than those taken in JPEG format, but the data size will be larger.

- You can process RAW images in [RAW Processing] in the [Playback] menu.
- To process and edit RAW files on a PC, use the software "SILKYPIX Developer Studio" by Ichikawa Soft Laboratory on the DVD (supplied).

Taking Pictures with Auto Focus

Applicable modes: **P** **A** **S** **M** **C1** **C2**

This allows the focusing method that suits the positions and number of the subjects to be selected.

1 Set the focus mode lever to **[AFS/AFF]** or **[AFC]**.

- The Focus Mode will be set. (P42)

2 Press **◀** ().

3 Press **◀/▶** to select AF Mode and then press **[MENU/SET]**.

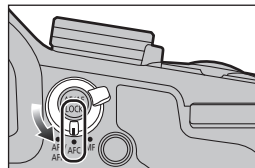

 ([Face/Eye Detection])	The camera automatically detects the person's face and eyes. An eye closer to the camera will be in focus, while the exposure will be optimised for the face. (When [Metering Mode] is set to [☉])
 ([Tracking])	Focus and exposure can be adjusted to a specified subject. Focus and exposure will keep on following the subject even if it moves. (Dynamic tracking)
 ([49-Area])	Up to 49 AF areas can be focused. This is effective when a subject is not in the centre of the screen.
 ([Custom Multi])	From among 49 AF areas, you can freely set the optimum shape of the AF area for the subject.
 ([1-Area])	The camera focuses on the subject in the AF area on the centre of the screen.
 ([Pinpoint])	You can achieve a more precise focus on a point that is smaller than [■] .

About the focus mode (AFS/AFF/AFC)

Applicable modes:   **P** **A** **S** **M**  **C2**  

Item	The movement of the subject and the scene (recommended)	Description of settings
AFS *	Subject is still (Scenery, anniversary photograph, etc.)	"AFS" is an abbreviation of "Auto Focus Single". Focus is set automatically when the shutter button is pressed halfway. Focus will be fixed while it is pressed halfway.
AFF *	Movement cannot be predicted (Children, pets, etc.)	"AFF" is an abbreviation of "Auto Focus Flexible". In this mode, focusing is performed automatically when the shutter button is pressed halfway. If the subject moves while the shutter button is pressed halfway, the focus is corrected to match the movement automatically.
AFC	Subject is moving (Sport, trains, etc.)	"AFC" is an abbreviation of "Auto Focus Continuous". In this mode, while the shutter button is pressed halfway, focusing is constantly performed to match the movement of the subject. When the subject is moving, the focusing is performed by predicting the subject position at the time of recording. (Movement prediction)

* In [AFS/AFF] in the [Rec] menu or the [Motion Picture] menu, you can assign [AFS] or [AFF] to [AFS/AFF] of the focus mode lever.

Taking Pictures with Manual Focus

Applicable modes:         

1 Set the focus mode lever to [MF].

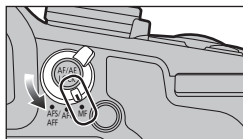

2 Set the manual ring selector switch to [FOCUS].

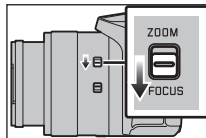

3 Press ◀ ().

4 Press ▲/▼/◀/▶ to determine the area to be enlarged, and press [MENU/SET].

- The assist screen is displayed, enlarging the area. (MF Assist)
- If you press [DISP.], the area to be enlarged will be reset to the centre.

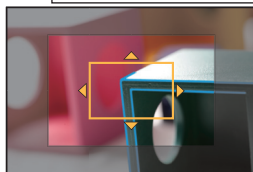

5 Operate the manual ring to set the focus.

Rotate to A side:

Focuses on nearby subject

Rotate to B side:

Focuses on faraway subject

- Be careful not to accidentally switch the O.I.S. switch or manual ring selector switch when you rotating the manual ring.

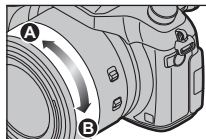

- (A) Indicator for ∞ (infinity)
- (B) MF Assist (enlarged screen)
- (C) Peaking
- (D) MF Guide

- The in-focus portions will be highlighted. (Peaking)
By using [Peaking] in the [Custom] menu, you can select the [ON]/[OFF] and detect level or colour in the [SET].
- You can check whether the point of focus is to the near side or to the far side. (MF Guide)

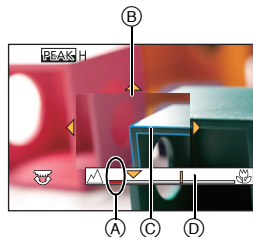

■ Displaying the MF Assist

- It is displayed by rotating the manual ring.
- It can also be displayed by pressing ◀ to display the setup screen for the enlarged area, deciding the area to enlarge using the cursor button, and then pressing [MENU/SET].

■ Changing the display of the MF Assist

Each time the rear dial is pressed, an enlarged display switches between a windowed screen display and a full screen display.

- If the rear dial is rotated, the display can be enlarged/reduced up to approximately 3 to 6 times when the enlarged display is in a windowed display or up to approximately 3 to 10 times when the enlarged display is in a full screen display.

■ Closing the MF Assist

- It will close when the shutter button is pressed halfway.
- You can also close MF Assist by pressing [MENU/SET].
- If you have displayed the MF Assist by rotating the manual ring, it will close approximately 10 seconds after you stop operating the camera.

Taking Close-up Pictures

Applicable modes: **P** **A** **S** **M** **C1** **C2**

- 1 Press **▼** [**AF**].
- 2 Press **◀/▶** to select the item and then press [**MENU/SET**].

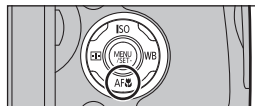

[AF] ([AF Macro])	You can take pictures of a subject as close as 3 cm (0.098 feet) from the lens by rotating the zoom lever upmost to Wide (1×).
[] ([Macro Zoom])	Use this setting to get close to the subject and then further enlarge when taking the picture. You can take a picture with the Digital Zoom up to 3× while maintaining the distance to the subject for the extreme Wide position [3 cm (0.098 feet)]. • The image quality is poorer than during normal recording. • Zoom range will be displayed in blue. (digital zoom range)
[OFF]	—

- If the lens becomes dirty with fingerprints or dust, the lens may not be able to focus on the subject correctly.

Fixing the Focus and the Exposure (AF/AE Lock)

Applicable modes: **P** **A** **S** **M** **C1** **C2**

This is useful when you want to take a picture of a subject outside the AF area or the contrast is too strong and you cannot achieve appropriate exposure.

- 1 Align the screen with the subject.
- 2 Press and hold [**AF/AE LOCK**] to fix the focus or exposure.
 - If you release [**AF/AE LOCK**], AF/AE Lock is cancelled.
 - Only the exposure is locked in the default setting.
- 3 While pressing [**AF/AE LOCK**], move the camera as you compose the picture and then press shutter button fully.
 - When [**AE LOCK**] is set, after pressing the shutter button halfway to focus, press the shutter button fully.

Setting the functions of [**AF/AE LOCK**]

MENU → **fC**[Custom] → [**AF/AE Lock**]

Compensating the Exposure

Applicable modes:  P A S M  C1 C2  SCN 

Use this function when you cannot achieve appropriate exposure due to the difference in brightness between the subject and the background.

- 1 Press the rear dial to switch to Exposure Compensation operation.
- 2 Rotate the rear dial to compensate the exposure.

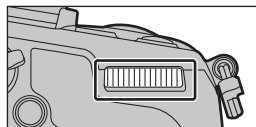

- 3 Press the rear dial to set.

Setting the Light Sensitivity

Applicable modes:  P A S M  C1 C2 

- 1 Press ▲ (ISO).
- 2 Select the ISO sensitivity by rotating the rear dial.

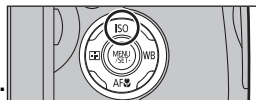

AUTO	The ISO sensitivity is automatically adjusted according to the brightness. • Maximum [3200]
ISO (Intelligent)	The camera detects movement of the subject and then automatically sets the optimum ISO sensitivity and shutter speed to suit the movement of the subject and brightness of the scene to minimise the jitter of the subject. • Maximum [3200]
80*/100*/125/200/400/800/ 1600/3200/6400/12800/25600*	The ISO sensitivity is fixed to various settings.

* Only available when [Extended ISO] is set.

- 3 Press the rear dial to set.





Selecting the Method for Measuring Brightness

([Metering Mode])

Applicable modes:        

Type of optical measurement to measure brightness can be changed.

MENU →  **[Rec]** → **[Metering Mode]**

 (Multiple)	This is the method in which the camera measures the most suitable exposure by judging the allocation of brightness on the whole screen automatically. Usually, we recommend using this method.
 (Centre weighted)	This is the method used to focus on the subject on the centre of the screen and measure the whole screen evenly.
 (Spot)	This is the method to measure the subject in the spot metering target  . 

Setting the Shutter Type

Applicable modes:   **P** **A** **S** **M**  **C1** **C2**  

You can use either of the two shutters to take pictures: the mechanical shutter or the electronic shutter.

	Mechanical Shutter	Electronic Shutter
Description	The camera starts an exposure electronically, and ends it with the mechanical shutter.	The camera starts and ends an exposure electronically.
Flash	○	—
Shutter Speed (Sec.)	60 to 1/4000th	1 to 1/16000th
Shutter sound	Mechanical shutter sound* + Electronic shutter sound	Electronic shutter sound

* The mechanical shutter sound cannot be muted.

Select the menu.

MENU →  **[Rec]** → **[Shutter Type]**

[AUTO]	Depending on the recording condition and the shutter speed, the shutter type is switched automatically.
[MSHTR]	Takes pictures only with the mechanical shutter.
[ESHTR]	Takes pictures using only the electronic shutter method.

- When a moving subject is recorded with the electronic shutter, the subject may appear distorted on the picture.
- When the electronic shutter is used under fluorescent or LED lighting, etc., horizontal stripes may appear on the picture. In such cases, lowering the shutter speed may reduce the effect of the horizontal stripes.





Select a Drive Mode

Applicable modes:   **P** **A** **S** **M**  **C1** **C2**  

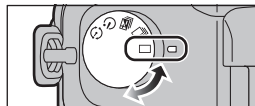
You can change what the camera will do when you press the shutter button.

Rotating the drive mode dial.



 Single	When the shutter button is pressed, only one picture is recorded.
 Burst	Recordings are made in succession while the shutter button is pressed.
 Auto Bracket (P51)	Each time the shutter button is pressed, recordings are made with different exposure settings according to the Exposure Compensation range.
 Self Timer (P51)	When the shutter button is pressed, recording takes place after the set time has elapsed.
 Time Lapse/Animation (P52, 54)	Pictures are recorded with Time Lapse Shot or Stop Motion Animation.

Taking Pictures using Burst Mode

Applicable modes:   **P** **A** **S** **M**    

Pictures are taken continuously while the shutter button is pressed.

- Pictures taken with a burst speed of [SH] will be recorded as a single burst group.

1 Set the drive mode dial to [].

2 Focus on the subject and take a picture.

- Hold down the shutter button fully to activate the Burst Mode.



■ Changing the burst speed

1 Select the menu.

MENU →  **[Rec]** → **[Burst Rate]**

2 Press **▲/▼** to select the burst speed and then press **[MENU/SET]**.

		[SH] ^{*2} (Super high speed)	[H] (High speed)	[M] (Middle speed)	[L] (Low speed)
Burst speed (pictures/ second)	AFS	50	12	7	2
	AFF/AFC	—	7	7	2
Live View during Burst Mode		None	None	Available	Available
*1	With RAW files	—	10	10	10
	Without RAW files	Max. 60	Depends on the capacity of the card		

*1 Number of recordable pictures

*2 The electronic shutter will operate.

Taking Pictures using Auto Bracket

Applicable modes: P A S M C1 C2 SCN B

Maximum of 7 pictures will be recorded with different exposure settings following the Exposure Compensation range every time the shutter button is pressed.

With Auto Bracket

[Step]: [3•1/3], [Sequence]: [0/-/+]

1st picture



±0 EV

2nd picture



-1/3 EV

3rd picture



+1/3 EV

- 1 Set the drive mode dial to .
- 2 Focus on the subject and take a picture.
 - If you press and hold the shutter button, the number of pictures that you set is taken.



■ Changing the settings for [Single/Burst Settings], [Step] and [Sequence] in Auto Bracket

- 1 Select the menu.

MENU → [Rec] → [Auto Bracket]

- 2 Press **▲/▼** to select [Single/Burst Settings], [Step] or [Sequence] and then press [MENU/SET].
- 3 Press **▲/▼** to select the setting and then press [MENU/SET].
 - Exit the menu after it is set.

Taking Pictures with the Self-timer

Applicable modes: P A S M C1 C2 SCN B

- 1 Set the drive mode dial to .
- 2 Press the shutter button halfway to focus and then press it fully to take the picture.

■ Changing the time setting for the self-timer

- 1 Select the menu.

MENU → [Rec] → [Self Timer]

- 2 Press **▲/▼** to select the mode and then press [MENU/SET].

Taking Pictures Automatically at Set Intervals

([Time Lapse Shot])

Applicable modes:        

If you set the start time of recording, the recording interval and the number of pictures, the camera can automatically take pictures of subjects such as animals or plants as time elapses and create a motion picture.

- Set the date and time settings in advance. (P18)
- Pictures taken with Time Lapse Shot are displayed as a set of group pictures.

- 1 Set the drive mode dial to [].
- 2 Press [MENU/SET].
- 3 Press [MENU/SET].
- 4 Select [Mode] with $\blacktriangle/\blacktriangledown$, and then press [MENU/SET].
- 5 Select [Time Lapse Shot] with $\blacktriangle/\blacktriangledown$, and then press [MENU/SET].
- 6 Press $\blacktriangle/\blacktriangledown$ to select the item and then press [MENU/SET].

[Start Time]	[Now]	Starts the recording by fully-pressing the shutter button.
	[StartTime Set]	You can set the time to start recording. Any time up to 23 hours 59 minutes ahead can be set. Select the item (hour or minute) by pressing $\blacktriangle/\blacktriangledown$, set the start time by pressing $\blacktriangle/\blacktriangledown$, and then press [MENU/SET].
[Shooting Interval]/ [Image Count]	The recording interval and the number of pictures can be set. $\blacktriangle/\blacktriangledown$: Select the item (minute/second/number of pictures) $\blacktriangle/\blacktriangledown$: Setting [MENU/SET]: Set <ul style="list-style-type: none"> • A recording interval ranging from 1 second to 99 minutes and 59 seconds can be set at 1 second interval. • The number of pictures ranging from 1 to 9999 can be set. 	

- 7 Press the shutter button halfway.
- 8 Press the shutter button fully.
 - Confirmation screen for creating a motion picture is displayed next, so select [Yes].

9 Select the methods for creating a motion picture.

- The recording format is set to [MP4].

[Rec Quality]	Sets the quality of a motion picture. [4K/25p]/[FHD/50p]/[FHD/25p]/[HD/25p]/[VGA/25p]
[Frame Rate]	Sets the number of frames per second. The larger the number is, the smoother the motion picture will be. [50fps]*/[25fps]/[12.5fps]/[8.3fps]/[6.25fps]/[5fps]/[2.5fps]/[1fps] * Only when set to [FHD/50p]
[Sequence]	[NORMAL]: Splices pictures together in recording order. [REVERSE]: Splices pictures together in reverse recording order.

10 Select [OK] with ▲/▼, and then press [MENU/SET].

■ Changing the Time Lapse Shot settings

You can change the settings in [Time Lapse/Animation] in the [Rec] menu.

Creating Stop Motion Pictures ([Stop Motion Animation])

Applicable modes:        

- Set the date and time settings in advance. (P18)
- Pictures taken with [Stop Motion Animation] are displayed as a set of group pictures.

- 1 Set the drive mode dial to [].
- 2 Press [MENU/SET].
- 3 Press [MENU/SET].
- 4 Select [Mode] with ▲/▼, and then press [MENU/SET].
- 5 Select [Stop Motion Animation] with ▲/▼, and then press [MENU/SET].
- 6 Press ▲/▼ to select the recording method, and then press [MENU/SET].

[Auto Shooting]	[ON]	Takes pictures automatically at a set recording interval. When the shutter button is pressed fully, recording starts.
	[OFF]	This is for taking pictures manually, frame by frame.
[Shooting Interval]	(Only when [Auto Shooting] is set to [ON]) Sets the interval for automatic recording. A value between 1 and 60 seconds can be set in 1 second intervals. Press ◀/▶ to select the recording interval (seconds), press ▲/▼ to set it, and press [MENU/SET].	

- 7 Press the shutter button halfway.
- 8 Press the shutter button fully.
- 9 Move the subject to decide on the composition.
 - Repeat recording in the same way.
- 10 To stop the recording, press [MENU/SET], select [Time Lapse/Animation] in the [Rec] menu, and press [MENU/SET].
 - Confirmation screen for creating a motion picture is displayed next, so select [Yes].

11 Select the methods for creating a motion picture.

- The recording format is set to [MP4].

[Rec Quality]	Sets the quality of a motion picture. [4K/25p]/[FHD/50p]/[FHD/25p]/[HD/25p]/[VGA/25p]
[Frame Rate]	Sets the number of frames per second. The larger the number is, the smoother the motion picture will be. [50fps]*/[25fps]/[12.5fps]/[8.3fps]/[6.25fps]/[5fps]/[2.5fps]/[1fps] * Only when set to [FHD/50p]
[Sequence]	[NORMAL]: Splices pictures together in recording order. [REVERSE]: Splices pictures together in reverse recording order.

12 Press ▲/▼ to select [OK] and then press [MENU/SET].

■ Changing the settings of Stop Motion Animation

You can change the settings in [Time Lapse/Animation] in the [Rec] menu.

Functions Customised for Various Subjects and Purposes

Disabling Operational Sounds and the Output of Light at once ([Silent Mode])

Applicable modes:   **P** **A** **S** **M**  **C1** **C2**  

This function is useful for recording images in a quiet environment, public facility, etc. or recording images of subjects such as babies or animals.

Select the menu.

MENU →  **[Custom]** → **[Silent Mode]**

Settings: **[ON]/[OFF]**

Displaying the centre of the screen ([Center Marker])

Applicable modes:   **P** **A** **S** **M**  **C1** **C2**  

The centre of the recording screen will be displayed as [+]. This is convenient for operating the zoom while keeping the subject at the centre of the screen.

MENU →  **[Custom]** → **[Center Marker]**

Settings: **[ON]/[OFF]**

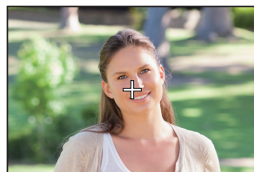



Checking areas that may be white saturated ([Zebra Pattern])

Applicable modes:  P A S M C1 C2 SCN ↻

You can check areas that may be white saturated by displaying areas above a certain luminance level in a zebra pattern. You can also set the minimum luminance level (brightness) to be processed as a zebra pattern.

MENU → **f_C[Custom]** → **[Zebra Pattern]**

[ZEBRA1]	Displays areas above a certain luminance level by a right-leaning zebra pattern.	
[ZEBRA2]	Displays areas above a certain luminance level by a left-leaning zebra pattern.	
[OFF]	—	
[SET]	Sets the minimum brightness level for each zebra pattern. [Zebra 1]/[Zebra 2] Press ▲/▼ to select the brightness, and press [MENU/SET] .	

Optical Image Stabiliser

The camera detects jitter during recording and automatically corrects it, so you can record images with reduced jitter.



Confirm that the O.I.S. switch is set to [ON].

■ Setting the Stabiliser in the [Rec] menu

1 Select the menu.

MENU →  **[Rec]** → **[Stabilizer]**

2 Press ▲/▼ to select the item and then press [MENU/SET].

 ([Normal])	Vertical and horizontal shake are compensated for.
 ([Panning])	Camera shake is corrected for up/down movements. This mode is ideal for panning (a method of taking pictures which involves turning the camera to track the movements of a subject which continues to move in a fixed direction).

Taking Pictures with the Zoom

Applicable modes:   **P** **A** **S** **M**  **C1** **C2**  

You can zoom-out to record landscapes etc. in wide angle (Wide) or zoom-in to make people and objects appear closer (Tele).

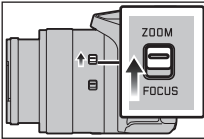
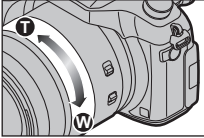
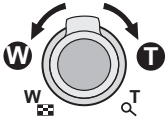
With the manual ring	With the zoom lever
<p>1 Set the manual ring selector switch to [ZOOM].</p>  <p>2 Rotate the manual ring.</p>  <ul style="list-style-type: none"> • Be careful not to accidentally switch the O.I.S. switch or manual ring selector switch when you rotating the manual ring. 	<p>Rotate the zoom lever.</p>  <ul style="list-style-type: none"> • The smaller the rotation angle is, the slower the zoom speed becomes; the greater the rotation angle is, the faster the zoom speed becomes.

Optical Zoom

Zooms in without deteriorating the image quality.

Maximum magnification: 16×

Extra Optical Zoom (EX)

This function works when any of the picture sizes (P39) indicated with **EX** is selected. You can zoom in further than you can with the Optical Zoom without deteriorating the image quality.

Maximum magnification: 32×

Intelligent Zoom

Applicable modes:   **P** **A** **S** **M**  **C1** **C2**  

You can zoom in up to twice the original zoom magnification while minimising the deterioration of the image quality.

MENU →  **[Rec]** → **[i.Zoom]** → **[ON]/[OFF]**

MENU →  **[Motion Picture]** → **[i.Zoom]** → **[ON]/[OFF]**

[Digital Zoom]

Applicable modes:   **P** **A** **S** **M**  **C1** **C2**  

Although the image quality deteriorates every time you zoom in further, you can zoom in up to four times the original zoom magnification.

MENU →  **[Rec]** → **[Digital Zoom]** → **[ON]/[OFF]**

MENU →  **[Motion Picture]** → **[Digital Zoom]** → **[ON]/[OFF]**

Taking pictures by using the flash

Applicable modes:         

■ Open/Close the built-in flash

(A) To open the flash

Slide the flash open lever.

(B) To close the flash

Press the flash until it clicks.

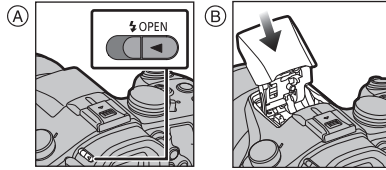

- Forcibly closing the flash can damage the camera.
- Make sure to close the built-in flash when it is not in use.

- **Be careful when opening the flash as the flash will jump out.**
- **Be careful not to catch a finger when closing a flash bulb.**

Changing Flash Mode





Applicable modes:         

1 Select the menu.

MENU →  **[Rec]** → **[Flash]**

2 Press **▲/▼** to select **[Flash Mode]** and then press **[MENU/SET]**.

3 Press **▲/▼** to select the item and then press **[MENU/SET]**.

 [[Forced Flash On]]	The flash is activated every time regardless of the recording conditions.
 [[Forced On/Red-Eye]]	<ul style="list-style-type: none"> • Use this when your subject is back-lit or under fluorescent light.
 [[Slow Sync.]]	When taking pictures against a dark background landscape, this feature will slow the shutter speed when the flash is activated. Dark background landscape will appear brighter.
 [[Slow Sync./Red-Eye]]	

Wi-Fi® function/NFC function

■ Describing method

When you see a step that says, "Select [Select a destination from History]." or a similar step, press the cursor buttons to select [Select a destination from History], and press [MENU/SET].

■ About the Wi-Fi connection lamp

- Lit blue: The Wi-Fi connection is on standby
Blinking blue: Sending/receiving data through the Wi-Fi connection



■ About the [Wi-Fi] button

[Wi-Fi]/[Fn2] button can be used in two ways, as [Wi-Fi] or as [Fn2] (function 2).

At the time of purchase, it is initially set to [Wi-Fi].



Pressing and holding [Wi-Fi] before connecting to Wi-Fi (When connecting to a smartphone)

- The information required for connecting the smartphone to this unit (QR code, SSID and password) is displayed.

Pressing [Wi-Fi] before connecting to Wi-Fi

- Following items can be selected.

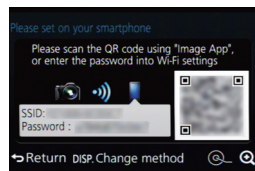

[New Connection]

[Select a destination from History]

[Select a destination from Favorite]

- These operating instructions describe the procedure for [New Connection].

What you can do with the [Wi-Fi] button when connected to Wi-Fi

- Following items can be selected.

[Terminate the Connection]

[Change the Destination]

[Change Settings for Sending Images]*

[Register the Current Destination to Favorite]

[Network Address]

- * This is not displayed when the destination of [Remote Shooting & View], [Playback on TV] or [Send Images Stored in the Camera] is set to [Printer].

- We strongly recommend that you set an encryption to maintain information security.
- When sending images on a mobile network, high packet communication fees may be incurred depending on the details of your contract.

Controlling with a Smartphone/Tablet

These operating instructions refer to both smartphones and tablets as “smartphones” from this point on unless noted otherwise.

Installing the smartphone/tablet app “Image App”

The “Image App” is an application provided by Panasonic.

• OS (As of June 2014)

App for Android™: Android 2.3.3 or higher*

App for iOS: iOS 5.0 or higher

* Connecting to this unit with [Wi-Fi Direct] requires Android OS 4.0 or higher and Wi-Fi Direct™ support.

- 1 **Connect the smartphone to a network.**
- 2 **(Android) Select “Google Play™ Store”.**
(iOS) Select “App Store™”.
- 3 **Enter “Panasonic Image App” or “LUMIX” into the search box.**
- 4 **Select “Panasonic Image App”  and install it.**

- Use the latest version.
- Read the [Help] in the “Image App” menu for further details on how to operate.
- The screen differs depending on the OS.
- The screens and procedures described from this point on are those at the time when the model first became available for purchase. The screens and procedures may change with version updates.
- The service may not be able to be used properly depending on the type of smartphone being used. For information on the “Image App”, refer to the support site below.

<http://panasonic.jp/support/global/cs/dsc/>

(This Site is English only.)

- When downloading the app on a mobile network, high packet communication fees may be incurred depending on the details of your contract.

Connecting to a smartphone/tablet

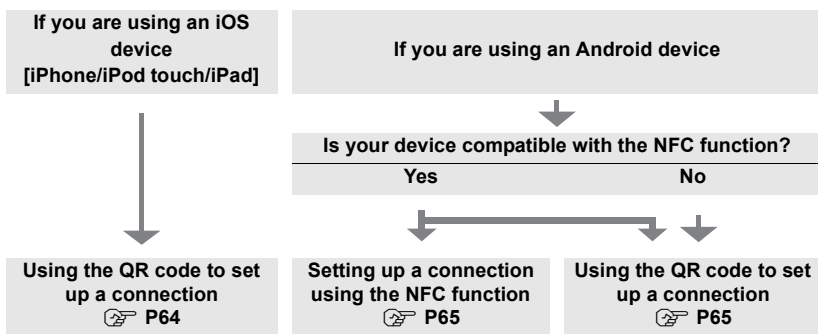

- You can also set up a connection by entering a password directly. For details, refer to P66.
- When terminating the connection, refer to P66.

If you are using an iOS device [iPhone/iPod touch/iPad]

Using the QR code to set up a connection

1 Press and hold [Wi-Fi] on the camera.



2 Start "Image App" on your smartphone.

3 Select [QR code], and then select [OK].



4 Using "Image App", scan the QR code displayed on the screen of the camera.

Ⓐ QR code

- If you press [MENU/SET] on the camera, the QR code will be enlarged. When it is difficult to scan the QR code, try enlarging it.

(If the scanning is not successful, move the camera and the smartphone further away from each other and try again or use a connection method other than the QR code method.)

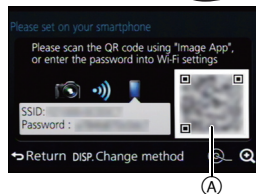

5 Install the profile of "IMAGE APP".

- A message will be displayed on the browser.
- If the smartphone is locked with a passcode, enter the passcode to unlock the smartphone.



6 Press the home button to close the browser.

7 Turn on the Wi-Fi function in the setting menu of the smartphone.

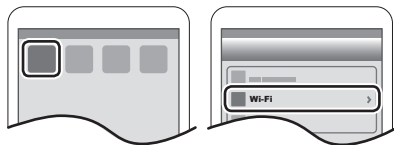

8 Select the SSID displayed on the screen of the camera.

9 Return to the home screen, and then start "Image App". (P63)

- Steps 2 through 6 are not required from the second time on.

When using an Android device

Setting up a connection using the NFC function

- If [NFC] is not displayed on the smartphone, the NFC function of the smartphone is disabled. Read the operating instructions of your smartphone and enable it.
- This function can be used with the NFC compatible device with Android (OS version 2.3.3 or higher). (excluding some models)

- 1 Launch "Image App" on your smartphone.
- 2 While [NFC] is displayed on the screen of the smartphone, touch the smartphone to [NFC] of the camera.
- 3 When the connection confirmation screen is displayed on the camera, select [Yes].
- 4 Touch the smartphone to [NFC] of the camera again.

- Steps 3 through 4 are not required from the second time on.
- For information on the operation and settings of NFC-compatible smartphones, refer to the operating instructions of your device.

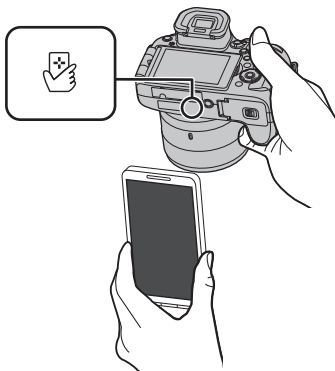

When using an Android device

Using the QR code to set up a connection

- 1 Press and hold [Wi-Fi] on the camera.
- 2 Start "Image App" on your smartphone.
- 3 Select [QR code].
- 4 Scan the QR code displayed on the screen of the camera.

Ⓐ QR code

- If you press [MENU/SET] on the camera, the QR code will be enlarged. When it is difficult to scan the QR code, try enlarging it.

(If the scanning is not successful, move the camera and the smartphone further away from each other and try again or use a connection method other than the QR code method.)

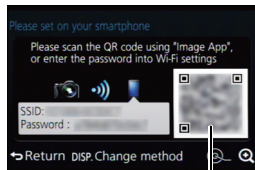

For both iOS devices (iPhone/iPod touch/iPad) and Android devices

Entering a password to set up a connection

- 1 Press and hold [Wi-Fi] on the camera.
- 2 Turn on the Wi-Fi function in the setting menu of the smartphone.



- 3 Select the SSID displayed on the screen of the camera.

(A) SSID and password

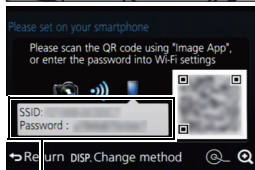

- 4 Enter the password displayed on the screen of the camera.

- If you are using an Android device, marking the box for password display will allow the device to display the password as you enter it.

- 5 On the smartphone, start "Image App".



For both iOS devices (iPhone/iPod touch/iPad) and Android devices

Terminating the connection

After use, terminate the connection to the smartphone.

- 1 Press [Wi-Fi] on the camera. (P62)
- 2 On the smartphone, close "Image App".

If you are using an iOS device

On the screen of "Image App", press the home button to close the app.

If you are using an Android device

On the screen of "Image App", press the return button twice to close the app.

Taking pictures via a smartphone/tablet (remote recording)

- 1 **Connect to a smartphone. (P63)**
- 2 **Operate the smartphone.**

- 1 Select [].
- 2 Record an image.
 - The recorded images are saved in the camera.
 - Some settings are not available.



Playing back images in the camera

- 1 **Connect to a smartphone. (P63)**
- 2 **Operate the smartphone.**

- 1 Select [].
 - You can switch the images to be displayed by selecting the icon (A) on the top left of the screen. To display images stored in the camera, select [LUMIX].
- 2 Touch the image to enlarge it.



Saving images stored in the camera

- 1 **Connect to a smartphone. (P63)**
- 2 **Operate the smartphone.**

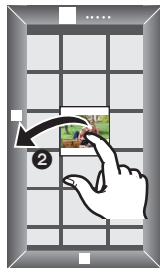
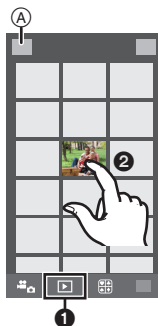

- 1 Select [].
 - You can switch the images to be displayed by selecting the icon (A) on the top left of the screen. To display images stored in the camera, select [LUMIX].
- 2 Touch and hold an image, and drag it to save it.



- The function can be assigned to the top, bottom, left or right according to your preference.
- You cannot save pictures taken in RAW format, motion pictures recorded with [AVCHD] or with their picture quality size set to [MP4] in 4K.

Saving images in the camera using the NFC function

The NFC function is not available for iOS devices (iPhone/iPod touch/iPad).

- 1 Play back the picture in the camera.
- 2 Launch “Image App” on the smartphone.
- 3 While [] is displayed on the connection screen of the “Image App”, touch the smartphone to [] of the camera.
 - If a connection attempt by touching fails, restart the “Image App”, and then display the screen in step 2 again.
 - To transfer more than one image, repeat steps 1 and 3.
(They cannot be transferred as a batch.)

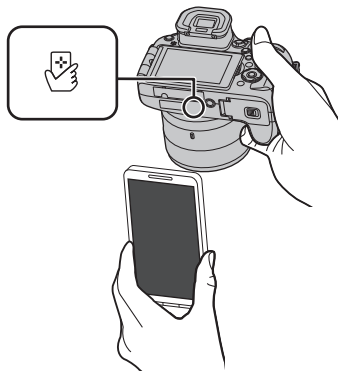

- After you set up a connection with the smartphone using the NFC function, the image will be saved via the Wi-Fi connection.
- You do not need to keep the devices in contact with each other while an image is being transferred. Do not put the camera down on top of the lens.

Sending images in the camera to an SNS

- 1 Connect to a smartphone. (P63)
- 2 Operate the smartphone.
 - 1 Select [].
 - You can switch the images to be displayed by selecting the icon (A) on the top left of the screen. To display images stored in the camera, select [LUMIX].
 - 2 Touch and hold an image, and drag it to send it to an SNS, etc.
 - The image is sent to a web service such as an SNS.

- The function can be assigned to the top, bottom, left or right according to your preference.

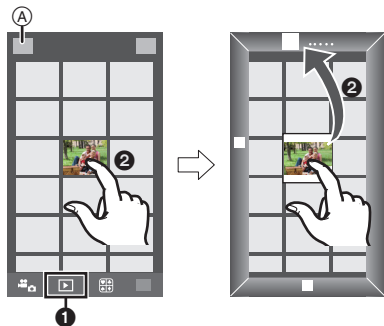

Setting up a connection to a PC via a wireless access point

To create a folder that receives images

Prepare folders for receiving images on the PC before sending a picture to the PC.

- Create a PC user account [account name (up to 254 characters) and password (up to 32 characters)] consisting of alphanumeric characters. An attempt to create a receive folder may fail if the account includes non-alphanumeric characters.

■ When using “PHOTOfunSTUDIO”

1 Install “PHOTOfunSTUDIO” to the PC.

- For details on hardware requirements and installation, read “About the supplied software” (P72).

2 Create a folder that receives images with “PHOTOfunSTUDIO”.

- To create the folder automatically, select [Auto-create]. To specify a folder, create a new folder, or set a password to the folder, select [Create manually].
- For details, refer to the operating instructions of “PHOTOfunSTUDIO” (PDF).

■ When not using “PHOTOfunSTUDIO”

(For Windows)

Supported OS: Windows XP/Windows Vista/Windows 7/Windows 8/Windows 8.1

Example: Windows 7

1 Select a folder you intend to use for receiving, then right-click.

2 Select [Properties], then enable sharing of the folder.

- For details, refer to the operating instructions of your PC or Help on the OS.

(For Mac)

Supported OS: OS X v10.5 to v10.9

Example: OS X v10.8

1 Select a folder you intend to use for receiving, then click on the items in the following order.

[File] → [Get Info]

2 Enable sharing of the folder.

- For details, refer to the operating instructions of your PC or Help on the OS.

When sending images to PC

You can send pictures and motion pictures recorded with this unit to a PC.

The connection methods described in this manual are examples. For details on other connection methods, refer to “Operating Instructions for advanced features (PDF format)”.

Preparations:

- If the workgroup of the destination PC has been changed from the standard setting, you also need to change the setting of this unit in [PC Connection].

- 1 Press [Wi-Fi].
- 2 Select [New Connection].
- 3 Select the connection method.

**Sending an image each time a recording is made
([Send Images While Recording])**

Available file format: JPEG/RAW

**Select and send the images
([Send Images Stored in the Camera])**

Available file format: ALL format

- 4 Select [PC].
- 5 Select the connection method.
Example: Selecting [WPS (Push-Button)] to set up a connection

- 1 Select [Via Network].
- 2 Select [WPS (Push-Button)].
- 3 Press the wireless access point WPS button until it switches to WPS mode.

- 6 On the camera, perform the operation that matches your purpose.

**Sending an image each time a recording is made
([Send Images While Recording])**

- 1 Select the PC you want to connect to and the destination folder.*
- 2 Take a picture with the camera.

**Select and send the images
([Send Images Stored in the Camera])**

- 1 Select the PC you want to connect to and the destination folder.*
- 2 Select [Single Select] or [Multi Select], and then select the images you want to send.

- * When the PC you want to connect to is not displayed, select [Manual Input], and enter the computer name of the PC (NetBIOS name for Apple Mac computers).
- To change the setting or disconnect, press [Wi-Fi]. (P62)

- Folders sorted by the sent date are created in the specified folder, and pictures are saved in those folders.
- If the screen for a user account and password entry appears, enter the one you set on your PC.
- When the computer name (NetBIOS name for Apple Mac computers) contains a space (blank character), etc., it may not be recognised correctly.
If a connection attempt fails, we recommend that you change the computer name (or NetBIOS name) to the one consisting of only alphanumeric characters, with a maximum of 15 characters.

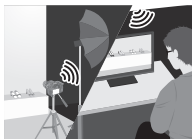
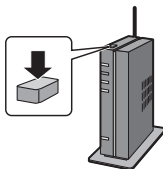

Playing Back Pictures on a TV Screen

Preparations: Turn this unit and the TV off.

- Confirm the terminals on your TV and use a cable compatible with the terminals.
Image quality may vary with the connected terminals.

1 Connect the camera and a TV.

- Check the direction of the terminals and plug in/out straight holding onto the plug. (It may result in malfunction by the deforming of the terminal if it is plugged in obliquely or in wrong direction.)

Do not connect devices to incorrect terminals. Doing so may cause malfunction.

To connect with an HDMI micro cable

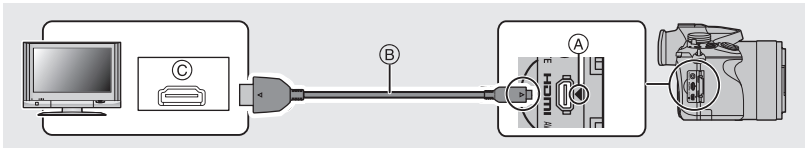

- Use a "High Speed HDMI micro cable" with the HDMI logo.
Cables that do not comply with the HDMI standards will not work.
"High Speed HDMI micro cable" [Type D–Type A plug, up to 2 m (6.6 feet) long]
- Check the [HDMI Mode (Play)].
- During 24p motion picture playback, please set [HDMI Mode (Play)] to [AUTO].
For settings other than [AUTO], it cannot output at 24 frames/second.
- Audio will be played back as stereo (2ch).
- No picture is displayed on the screen of this unit.
- When [VIERA Link] is set to [ON], operations using the buttons on the camera are restricted.

(A) Align the marks, and insert.

(C) HDMI socket

(B) HDMI micro cable

To connect with an AV cable (optional)

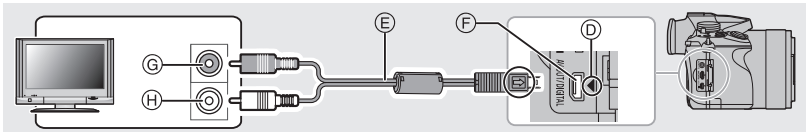

- Always use a genuine Panasonic AV cable (DMW-AVC1: optional).
- Audio will be played back in monaural.

(D) Align the marks, and insert.

(G) Yellow: to the video input socket

(E) AV cable (optional)

(H) White: to the audio input socket

(F) [AV OUT/DIGITAL] terminal

- The colour of the terminal is gold.

2 Turn on the TV and select the input to match the connector in use.

3 Turn the camera on and then press [▶].

- Input of the TV will switch automatically and playback screen is displayed when connected to a VIERA Link compatible TV using an HDMI micro cable with the [VIERA Link] set to [ON].

- No sound is output from the camera speakers.
- Read the operating instructions for the TV.

Saving still pictures and motion pictures on your PC

■ PC that can be used

The unit can be connected to any PC capable of recognising a mass storage device.

- Windows support: Windows XP/Windows Vista/Windows 7/Windows 8/Windows 8.1
- Mac support: OS X v10.5 to v10.9



AVCHD motion pictures may not be imported correctly when copied as files or folder

- With Windows, always import AVCHD motion pictures using "PHOTOfunSTUDIO", one of the programmes on the DVD (supplied).
- With a Mac, AVCHD motion pictures can be imported using "iMovie".
Please note that importing is not possible depending on the picture quality.
(For details about iMovie, please contact Apple Inc.)

About the supplied software

The supplied DVD includes the following software.
Install the software on to your computer before use.

- **PHOTOfunSTUDIO 9.5 PE (Windows XP/Windows Vista/Windows 7/Windows 8/Windows 8.1)**
This software allows you to manage images. For example, you can send pictures and motion pictures to a PC and sort them by recording date or model name. You can also perform operations such as writing images to a DVD, processing and correcting images, and editing motion pictures.
- **SILKYPIX Developer Studio 4.1 SE (Windows XP/Windows Vista/Windows 7/Windows 8/Windows 8.1, Mac OS X v10.5/v10.6/v10.7/v10.8/v10.9)**

This is software to edit RAW format images.

Edited images can be saved in a format (JPEG, TIFF, etc.) that can be displayed on a personal computer.

For details on how to use the SILKYPIX Developer Studio, refer to the “Help” or the Ichikawa Soft Laboratory’s support website:
<http://www.isl.co.jp/SILKYPIX/english/p/support/>

• **LoiLoScope 30 day full trial version (Windows XP/Windows Vista/Windows 7/Windows 8/Windows 8.1)**

LoiLoScope is a video editing software where that draws out the full power of your PC. Creating videos is as easy as organizing cards on top of a desk. Use your music, picture and video files to create videos to share with your friends and family by burning it to a DVD, uploading it to websites, or simply share your videos with your friends via e-mail.

– This will only install a shortcut to the trial version download site.

For more information on how to use LoiLoScope, read the LoiLoScope manual available for download at the link below.
Manual URL: <http://loilo.tv/product/20>

■ **Installing supplied software**

- Before inserting the DVD, close all running applications.

1 Check the environment of your PC.

- **Operating environment of “PHOTOfunSTUDIO”**

– OS:

Windows® XP (32bit) SP3,
 Windows Vista® (32bit) SP2,
 Windows® 7 (32bit/64bit) or SP1,
 Windows® 8 (32bit/64bit),
 Windows® 8.1 (32bit/64bit)

– CPU:

Pentium® III 500 MHz or higher (Windows® XP),
 Pentium® III 800 MHz or higher (Windows Vista®),
 Pentium® III 1 GHz or higher (Windows® 7/Windows® 8/Windows® 8.1)

– Display:

1024×768 pixels or more (1920×1080 pixels or more recommended)

– RAM:

512 MB or more (Windows® XP/Windows Vista®),
 1 GB or more (Windows® 7 32bit/Windows® 8 32bit/Windows® 8.1 32bit),
 2 GB or more (Windows® 7 64bit/Windows® 8 64bit/Windows® 8.1 64bit)

– Free hard disk space:

450 MB or more for installing software

- Refer to the operating instructions of “PHOTOfunSTUDIO” (PDF) for further operating environment.
- For details on “SILKYPIX Developer Studio”, please read the support site given on P73.

2 Insert the DVD with the supplied software.

3 Click on the [Applications] on the install menu.

- If the automatic playback screen is displayed, you can display the menu by selecting and executing [Launcher.exe].
- In Windows 8/Windows 8.1, you can display the menu by clicking a message that is displayed after inserting the DVD and then selecting and executing [Launcher.exe].
- You can also display the menu by double-clicking [SFMXXXX] in [Computer] (XXXX differs depending on the model).

4 Click on the [Recommended Installation].

- Proceed with installation according to messages appearing on the screen.

- The software compatible with your PC will be installed.
- On the Mac, SILKYPIX can be installed manually.

- 1 Insert the DVD with the supplied software.
- 2 Double-click the application folder on the DVD.
- 3 Double-click on the automatically displayed folder.
- 4 Double-click the icon in the application folder.



Not available in these cases:

- “PHOTOfunSTUDIO” and “LoiLoScope” are not compatible with Mac.

■ Transferring pictures to a PC

Preparations: Install “PHOTOfunSTUDIO” to the PC.

1 Connect the computer and camera with the USB connection cable (supplied).

- Please turn this unit on and your PC before connecting.
- Check the direction of the terminals and plug in/out straight holding onto the plug. (It may result in malfunction by the deforming of the terminal if it is plugged in obliquely or in wrong direction.)
Do not connect devices to incorrect terminals. Doing so may cause malfunction.
- Do not use any other USB connection cables except the supplied one or a genuine Panasonic USB connection cable (DMW-USBC1: optional).

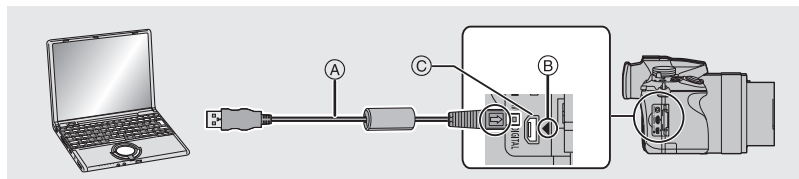

- A USB connection cable (supplied)
- Align the marks, and insert.
- [AV OUT/DIGITAL] terminal
 - The colour of the terminal is gold.

2 Press ▲/▼ to select [PC], and then press [MENU/SET].

- If [USB Mode] is set to [PC] in the [Setup] menu in advance, the camera will be automatically connected to the PC without displaying the [USB Mode] selection screen.

3 Copy the images to a PC using “PHOTOfunSTUDIO”.

- Do not delete or move copied files or folders in Windows Explorer.
When viewing in “PHOTOfunSTUDIO”, you will not be able to play back or edit.

■ Copying to a PC without using “PHOTOfunSTUDIO”

If you are not able to install “PHOTOfunSTUDIO”, you can copy files and folders to your PC by dragging and dropping files from this unit.

Monitor Display/Viewfinder Display

• The following images are examples of when the display screen is set to [] (monitor style) in the monitor.

■ In recording

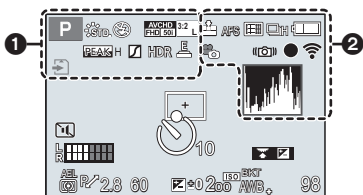

1

	Recording Mode (P21)
	Custom settings (P37)
	Photo Style
	Creative control adjustment display
	Flash Mode (P61)
	Flash
	Recording format/ Recording quality (P23)
	Picture size/Aspect Ratio (P39)
	Card (displayed only during recording)
	Elapsed recording time*1 (P23)
	Simultaneous recording indicator
	Automatic viewfinder/ monitor switching
	Peaking
	Highlight Shadow
	HDR

	Multi exposure
	Electronic shutter

2

	RAW	Quality (P40)
	100fps	High Speed Video
	AFS AFF AFC MF	Focus Mode (P42)
		AF Mode (P41)
		Face Recognition
	AFL	AF Lock (P45)
		Burst (P50)
	Auto Bracket	(P51)
		Self-timer (P51)
		Time Lapse Shot (P52)
		Stop Motion Animation (P54)
		Battery indication
		Picture Mode (Still picture priorities)
		Luminance Level
	AF	Macro recording (P45)
		Level Shot
		Optical Image Stabiliser (P58)
		Jitter alert
		Recording state (Flashes red./Focus (Lights green.) (P22)
	LOW	Focus (Under low illumination)
		Connected to Wi-Fi
		Histogram

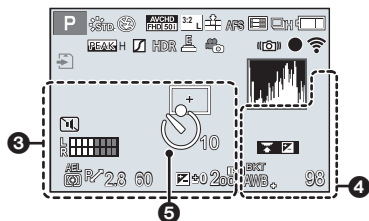

3

Name*2

Number of days that have passed since the departure date*2

Age*2

Location*2

Current date and time/Travel destination setting*2. ✈

	AF area
	Spot metering target (P47)
	Self-timer*3 (P51)
	Silent Mode (P56)
	External Microphone
	Zoom Microphone
	Mic Level Display
	Mic Level Limiter (OFF)

*1 m: minute, s: second

*2 This is displayed for about 5 seconds when the camera is turned on, after setting the clock and after switching from Playback Mode to Recording Mode.

*3 This is displayed during countdown.

*4 It is possible to switch the display between the number of recordable pictures and available recording time with the [Remaining Disp.] setting in the [Custom] menu.

	AE Lock (P45)
	Metering Mode (P47)
	Programme Shift
2.8	Aperture value
60	Shutter speed
	Exposure compensation value (P46)
	Brightness
	Manual Exposure Assistance
200	ISO sensitivity (P46)
4	
	Dial operation guide
	White Balance Bracket
	White Balance Fine Adjustment
	White Balance (P38)
	Colour
98	Number of recordable pictures*4
R8m30s	Available recording time*1,4
5	
	Exposure meter (P32)
	Zoom

On-monitor recording information

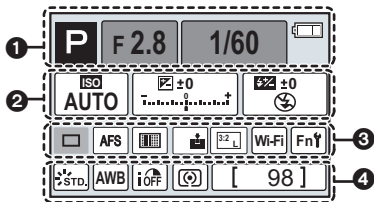

1

	Recording Mode (P21)
F2.8	Aperture value (P22)
1/60	Shutter speed (P22)
	Battery indication

2

	ISO sensitivity (P46)
	Exposure compensation value (P46)
	Brightness
	Manual Exposure Assistance
	Flash Mode (P61)
	Flash

3

	Single (P49)
	Burst (P50)
	Auto Bracket (P51)

	Self-timer (P51)
	Time Lapse Shot (P52)
	Stop Motion Animation (P54)
	Focus Mode (P42)
	AF Mode (P41)
	Quality (P40)
	Picture size/Aspect Ratio (P39)
	Wi-Fi (P62)
	Function button setting

4

	Photo Style
	White Balance (P38)
	Intelligent Dynamic Range Control
	Metering Mode (P47)
98	Number of recordable pictures
R8m30s	Available recording time

Message Display

Confirmation messages or error messages will be displayed on the screen in some cases. The major messages are described below as examples.

- Please also refer to the “Operating Instructions for advanced features (PDF format)”, which describes more detailed information.

[Some pictures cannot be deleted]/[This picture cannot be deleted]

- This feature can only be used with pictures that comply with the DCF standard. Perform formatting (P18) on this unit after saving necessary data on a PC, etc.

[Memory Card Error]/[This memory card cannot be used]

- Use a card compatible with this unit. (P17)

[Insert SD card again]/[Try another card]

- An error has occurred accessing the card.
Insert the card again.
- Insert a different card.

[Read Error/Write Error Please check the card]

- It has failed to read or write data.
Remove the card after turning this unit off. Insert the card again, turn this unit on, and try to read or write the data again.
- The card may be broken.
- Insert a different card.

[This battery cannot be used]

- Use a genuine Panasonic battery. If this message is displayed even when a genuine Panasonic battery is used, contact the dealer or Panasonic.
- If the battery terminal is dirty, clean it and remove any objects.

[Failed to connect wireless access point]/[Connection failed]/[No destination found]

- Check following regarding the wireless access point.
 - The wireless access point information set on this unit is wrong.
Check the authentication type, encryption type, and encryption key.
 - Power of the wireless access point is not turned on.
 - Setting of the wireless access point is not supported by this unit.
- Check the network setting of the destination.
- Radio waves from other devices may block the connection to a wireless access point.
Check other devices that are connected to the wireless access point and devices that use the 2.4 GHz band.

[No picture to send]

- This is displayed when there is no image to transmit due to the restriction of the destination.
Check the file format of the image to send.

Menu list

[Rec]

This menu lets you set the aspect ratio, number of pixels and other aspects of the pictures you are recording.

- [Photo Style], [AFS/AFF], [Metering Mode], [Highlight Shadow], [i.Dynamic], [i.Resolution], [i.Zoom] and [Digital Zoom] are common to both the [Rec] menu and [Motion Picture] menu. Changing these settings in one of these menus is reflected in other menu.

[Photo Style]	You can select effects to match the type of image you wish to record. You can adjust the colour and image quality of the effects.
[Aspect Ratio]	Sets the aspect ratio of the image.
[Picture Size]	Set the number of pixels.
[Quality]	Set the compression rate at which the pictures are to be stored.
[AFS/AFF]	Assigns [AFS] or [AFF] to [AFS/AFF] of the focus mode lever.
[Metering Mode]	Sets the light metering method for measuring brightness.
[Burst Rate]	Sets the burst speed for burst recording.
[Auto Bracket]	Sets single/burst recording, compensation range and recording sequence for Auto Bracket recording.
[Self Timer]	Sets the manner in which the self-timer works.
[Time Lapse/Animation]	Makes the recording settings for Time Lapse Shot and Stop Motion Animation.
[Highlight Shadow]	You can adjust the brightness of bright and dark portions on an image while checking the brightness on the screen.
[i.Dynamic] (Intelligent dynamic range control)	Adjusts the contrast and exposure.
[i.Resolution]	Records pictures with more defined outlines and sense of clarity.
[iHandheld Night Shot]	Pictures of the night scenery will be taken at a high burst speed and composed into a single picture.
[iHDR]	There is, for example, strong contrast between the background and the subject, multiple still pictures are recorded with differing exposures and combined to create a single still picture rich in gradation.
[HDR]	You can combine 3 pictures with different levels of exposure into a single picture with rich gradation.

[Multi Exp.]	Gives an effect like multi exposure. (up to 4 times equivalent per a single image)
[Panorama Settings]	Sets the recording direction and image effect for panorama recording.
[Shutter Type]	You can choose between taking pictures with the mechanical shutter and the electronic shutter.
[Flash]	Sets the manner in which the flash works.
[Red-Eye Removal]	Automatically detects red-eye caused by the flash and corrects the image data accordingly.
[ISO Limit Set]	When the ISO sensitivity is set to [AUTO] or [iISO], an optimal ISO sensitivity is set with the selected value as an upper limit.
[ISO Increments]	The ISO sensitivity settings values changes in steps of 1/3 EV or 1 EV.
[Extended ISO]	You can extend the available ISO sensitivity values.
[Long Shtr NR]	You can eliminate the noise caused by recording with a slower shutter speed.
[i.Zoom]	You can raise the zoom magnification with minimum image deterioration.
[Digital Zoom]	Increases the Tele effect. The higher the level of magnification, the greater the degradation in image quality.
[Color Space]	Set this when you want to correct the colour reproduction of the recorded pictures on a PC, printer etc.
[Stabilizer]	When camera shake is sensed during recording, the camera corrects it automatically.
[Face Recog.]	Sets the focus and exposure automatically prioritising registered faces.
[Profile Setup]	If you set the name and birthday of your baby or pet in advance, you can record their name and age in months and years in the images.

[Motion Picture]

This menu lets you set the [Rec Format], [Rec Quality], and other aspects for motion picture recording.

- [Photo Style], [AFS/AFF], [Metering Mode], [Highlight Shadow], [i.Dynamic], [i.Resolution], [i.Zoom] and [Digital Zoom] are common to both the [Rec] menu and [Motion Picture] menu. Changing these settings in one of these menus is reflected in other menu.



– For details, refer to the explanation for the corresponding setting in the [Rec] menu.

[Rec Format]	Sets the file format for the motion pictures you record.
[Rec Quality]	This sets up the picture quality of motion pictures.
[Exposure Mode]	Select the method for setting the aperture value and shutter speed in Creative Video Mode.
[High Speed Video]	You can record slow motion pictures by performing ultra-high-speed recording.
[Picture Mode]	Sets the recording method for still pictures during motion picture recording.
[Continuous AF]	Continues to focus on the subject for which focus has been achieved.
[Level Shot]	The camera automatically detects its tilt and corrects the motion pictures you record to a level position to prevent them from being skewed.
[Luminance Level]	Select the luminance range to match the use of video.
[Flkr Decrease]	The shutter speed can be fixed to reduce the flicker or striping in the motion picture.
[Mic Level Disp.]	Set whether or not the mic levels are displayed on the recording screen.
[Mic Level Adj.]	Adjust the sound input level to 19 different levels.
[Special Mic.]	Sets the sound recording method when a stereo shotgun microphone (optional) is connected.
[Mic Level Limiter]	Adjusts the sound input level automatically.
[Wind Cut]	You can reduce the wind noise effectively when recording with sound.
[Zoom Mic]	Coupled to the zoom operation, it will clearly record far sounds with tele, and surrounding sounds with wide.

[Custom]

Operation of the unit, such as displaying of the screen and button operations, can be set up according to your preferences. Also, it is possible to register the modified settings.

[Cust.Set Mem.]	Registers the current camera settings as custom set.
[Silent Mode]	Disables operational sounds and output of light at once.
[AF/AE Lock]	Sets the fixed content for focusing and exposure when the AF/AE lock is on.
[AF/AE Lock Hold]	This will set the operation of [AF/AE LOCK] button when taking a picture with fixed focus or exposure.
[Shutter AF]	Set whether or not the focus is adjusted automatically when the shutter button is pressed halfway.
[Half Press Release]	The shutter will immediately fire when the shutter button is pressed halfway.
[Quick AF]	Speeds up the focusing that takes place when you press the shutter button.
[Eye Sensor AF]	The camera automatically adjusts the focus when the eye sensor is active.
[Pinpoint AF Time]	Sets the time for which the screen is enlarged when the shutter button is pressed halfway with Auto Focus Mode set to [⊕].
[AF Assist Lamp]	AF assist lamp will illuminate the subject when the shutter button is pressed half-way making it easier for the camera to focus when recording in low light conditions.
[Direct Focus Area]	Moves the AF area or MF assist using the cursor button when recording.
[Focus/Release Priority]	It will set so no picture can be taken when it is out of focus.
[AF+MF]	You can set the focus manually after the automatic focus has finished.
[MF Assist]	Sets the display method of MF Assist (enlarged screen).
[MF Guide]	When you set the focus manually, an MF guide that allows you to check the direction to achieve focus is displayed.
[Peaking]	In-focus portions are highlighted when focus is being adjusted manually.
[Histogram]	This allows you to set either to display or not display the histogram.
[Guide Line]	This will set the pattern of guide lines displayed when taking a picture.

[Center Marker]	Displays [+], which indicates the centre of the recording screen.
[Highlight]	When the Auto Review function is activated or when playing back, white saturated areas appear blinking in black and white.
[Zebra Pattern]	Indicates parts that may be whited out through overexposure in a zebra pattern.
[Monochrome Live View]	You can display the recording screen in black and white.
[Constant Preview]	You can check the effects of the chosen aperture and shutter speed on the recording screen in Manual Exposure Mode.
[Expo.Meter]	Set whether or not to display the exposure meter.
[Dial Guide]	Set whether or not to display the dial operation guide.
[LVF Disp.Style]	This will set the display style of the viewfinder.
[Monitor Disp. Style]	This will set the display style of the monitor.
[Monitor Info. Disp.]	Display the recording information screen.
[Rec Area]	This changes the angle of view during motion picture recording and still picture recording.
[Remaining Disp.]	This will switch display between the number of recordable pictures and available recording time.
[Auto Review]	Set the length of time that the picture is displayed after taking the still picture.
[Fn Button Set]	You can assign frequently-used functions to particular buttons.
[Zoom Lever]	Change the zoom setting of the zoom lever.
[Manual ring (Zoom)]	Change the zoom setting of the manual ring.
[Zoom Resume]	Saves the zoom position when you turn off the camera.
[Q.MENU]	Switch the setting method of Quick Menu.
[Video Button]	Enables/disables the motion picture button.
[Eye Sensor]	Setting the eye sensor sensitivity and the method for switching between the monitor and viewfinder.
[Menu Guide]	Set the screen that is displayed when the mode dial is set to  and  .

[Setup]

This menu lets you perform the clock settings, select the operating beep tone settings and set other settings which make it easier for you to operate the camera.

You can also configure the settings of Wi-Fi related functions.

[Clock Set]	Setting Date/Time.
[World Time]	Sets the times for the region where you live and your holiday destination.
[Travel Date]	Departure date and return date of the trip as well as the name of the travel destination can be set.
[Wi-Fi]	Configure the each setting for Wi-Fi functions.
[Beep]	Set the volume for electronic noises and the electronic shutter noise.
[Live View Mode]	Set the frame rate of the recording screen (Live View screen).
[Monitor Display]/ [Viewfinder]	Brightness, colour, or red or blue tint of the Monitor/viewfinder is adjusted.
[Monitor Luminance]	Set the monitor brightness to suit the amount of surrounding light.
[Economy]	Suppresses the unit's power consumption to prevent the battery from being run down.
[USB Mode]	Sets the communication method when connecting using the USB connection cable (supplied).
[TV Connection]	This sets how the unit connects to a television etc.
[Menu Resume]	Stores the location of the last-used menu item for each menu.
[Menu Background]	Set the background colour for the menu screen.
[Menu Information]	Descriptions of menu items or their settings are displayed on the menu screen.
[Language]	Set the language displayed on the screen.
[Version Disp.]	It is possible to check which version of firmware is on the camera.
[Exposure Comp. Reset]	An exposure value can be reset when the Recording Mode is changed or the camera is turned off.
[No.Reset]	Returns the image file number to 0001.
[Reset]	The recording or setup/custom settings are reset to the default.
[Reset Wi-Fi Settings]	Reset all settings in the [Wi-Fi] menu to factory default settings. (Excluding [LUMIX CLUB])
[Format]	The card is formatted.

[Playback]

This menu lets you set the Protection, Cropping or Print Settings, etc. of recorded pictures.

[Slide Show]	Selects the type etc. of the images and plays back in order.
[Playback Mode]	Selects the type etc. of the images and plays back only particular images.
[Location Logging]	You can write location information (longitude/latitude) on images sent from the smartphone.
[RAW Processing]	You can convert the pictures taken in the RAW format into the JPEG format on the camera.
[Title Edit]	Input texts (comments) on the recorded pictures.
[Text Stamp]	Stamps the recorded pictures with recording date and time, names, travel destination, travel date, etc.
[Video Divide]	Splits the recorded motion picture in two.
[Time Lapse Video]	Creates a motion picture from a set of group pictures recorded with the [Time Lapse Shot].
[Stop Motion Video]	Creates a motion picture from the Stop Motion Animation group.
[Resize]	Reduces the image size (number of pixels).
[Cropping]	Crops the recorded image.
[Rotate]	Rotate pictures manually in 90° steps.
[Rotate Disp.]	This mode allows you to display pictures vertically if they were recorded holding the camera vertically.
[Favorite]	Marks can be added to images, and images can be set as favourites.
[Print Set]	Sets the images for printing and the number of prints.
[Protect]	Protects images to prevent deletion by mistake.
[Face Rec Edit]	Removes or changes information relating to personal identity.
[Picture Sort]	Sets the display order of the images you play back on the camera.
[Delete Confirmation]	This sets which option, [Yes] or [No], will be highlighted first when the confirmation screen for deleting a picture is displayed.

Troubleshooting

First, try out the following procedures.

If the problem is not resolved, it may be improved by selecting [Reset] on the [Setup] menu.

- Please also refer to the “Operating Instructions for advanced features (PDF format)”, which describes more detailed information.

**The camera cannot be operated even when it is turned on.
The camera turns off immediately after it is turned on.**

- The battery is exhausted.
→ Charge the battery.
- If you leave the camera on, the battery will be exhausted.
→ Turn the camera off frequently by using the [Economy] etc.

This unit is turned off automatically.

- Is the linked operation of VIERA Link enabled?
→ If you are not using VIERA Link, set [VIERA Link] to [OFF].

The subject is not focused properly.

- The subject is beyond the focus range of the camera.
- There is camera shake (jitter) or the subject is moving slightly.
- Is [Focus/Release Priority] in the [Custom] menu set to [RELEASE]?
- Is [Shutter AF] in the [Custom] menu set to [OFF]?
- Is the AF Lock (P45) applied incorrectly?

**The recorded picture is blurred.
The Optical Image Stabiliser is not effective.**

- The shutter speed will become slower and the Optical Image Stabiliser function may not work properly when taking pictures especially in dark places.
→ We recommend holding the camera firmly with both hands when taking pictures. (P20)
→ We recommend using a tripod and the self-timer (P51) when taking pictures with a slow shutter speed.

**Striping or flicker appears under lighting such as a fluorescent or LED lighting fixture.
The subject appears distorted.**

- This is characteristic of MOS sensors which serve as the camera's pickup sensors.
This is not a malfunction.
When a subject moves across the image very fast, the subject may appear slightly distorted.
- Are you taking pictures with the electronic shutter?
→ When using the electronic shutter, lowering the shutter speed may reduce the effect of the horizontal stripes.
- When noticeable flicker or striping is seen under lighting such as a fluorescent or LED lighting fixture, you can reduce the flicker or striping by setting up [Flkr Decrease] and fixing the shutter speed. It is possible to select a shutter speed from [1/50], [1/60], [1/100], or [1/120].
You can set the shutter speed manually in the Creative Video Mode. (P35)

The brightness or the hue of the recorded picture is different from the actual scene.

- When recording under fluorescent or LED lighting fixture, etc., increasing the shutter speed may introduce slight changes to brightness and colour. These are a result of the characteristics of the light source and do not indicate a malfunction.
- When recording subjects in extremely bright locations or recording under fluorescent lighting, LED lighting fixture, mercury lamp, sodium lighting, etc., the colours and screen brightness may change or horizontal striping may appear on the screen.

Recording motion pictures is not possible.

- You may not be able to record for a short while after turning this unit on when using a large capacity card.

The screen may be blacked out momentarily, or the unit may record noise.

- Depending on the environment at the time of motion picture recording, the screen may be blacked out momentarily or the unit may record noise due to static electricity or powerful electromagnetic waves (radio towers, high voltage power lines, etc.).

The flash is not activated.

- Is the flash closed?
→ Open the flash. (P61)
- When the electronic shutter is used, the flash is not activated.
→ Set [Shutter Type] to [AUTO] or [MSHTR].
- When [Silent Mode] is set to [ON], the flash is not activated. (P56)
→ Set [Silent Mode] to [OFF].

The picture is not played back. There are no recorded pictures.

- Is the card inserted?
- Is there a picture on the card?
- Is this a folder or picture which was processed in the PC?
If it is, it cannot be played back by this unit.
→ It is recommended to use the "PHOTOfunSTUDIO" software in the DVD (supplied) to write pictures from PC to card.
- Has [Playback Mode] been set for playback?
→ Change to [Normal Play].

The folder number and the file number are displayed as [—] and the screen turns black.

- Is this a non-standard picture, a picture which has been edited using a PC or a picture which was taken by another make of digital camera?
- Did you remove the battery immediately after picture-taking or did you take the picture using a battery with a low remaining charge?
→ To delete such pictures, make a backup of the data and format the card.

Motion pictures recorded with this model cannot be played back on other equipment.

- The picture quality or sound quality of recorded motion pictures may be deteriorated even when these are played back with the compatible devices. Also, recording information may not be displayed correctly.

A Wi-Fi connection cannot be established.

Radio waves get disconnected.

Wireless access point is not displayed.

■ **General tips for using a Wi-Fi connection**

- Try [Reset Wi-Fi Settings] in the [Setup] menu.
- Use within the communication range of the device to be connected.
- Is any device, such as microwave oven, cordless phone, etc., that uses 2.4 GHz frequency operated nearby?
 - Radio waves may get interrupted when used simultaneously. Use them sufficiently away from the device.
- When the battery indicator is flashing red, the connection with other equipment may not start or the connection may be disrupted.
(A message such as [Communication error] is displayed.)
- If you place the camera on a metal table or shelf, the radio waves may be adversely affected. In such cases, you may not be able to establish a connection. Move the camera away from the metal surface.

■ **About a wireless access point**

- Check if the wireless access point to connect is in operating state.
- The camera may not display or connect to a wireless access point depending on the radio wave condition.
 - Move this unit closer to the wireless access point.
 - Remove the obstacles between this unit and the wireless access point.
 - Change the direction of this unit.
 - Change the location and orientation of the wireless access point.
 - Perform the [Manual Input].
- It may not display even if the radio waves exist depending on the setting of the wireless access point.
 - Check the settings of the wireless access point.
 - When the network SSID of the wireless access point is set not to broadcast, the wireless access point may not be detected. Enter the network SSID to start the connection or enable the SSID broadcast of the wireless access point.
- Connection types and security setting methods are different depending on the wireless access point. (Refer to the operating instructions of the wireless access point.)
- Is the 5 GHz/2.4 GHz switchable wireless access point connected to other equipment using the 5 GHz band?
 - The use of a wireless access point that can use 5 GHz/2.4 GHz simultaneously is recommended. It cannot be used simultaneously with this camera if it is not compatible.

Images cannot be transmitted to a PC.

- When the firewall of the OS, security software, etc. is enabled, connecting to the PC may not be possible.

When I try to set up a Wi-Fi connection with a Windows 8 PC, my user name and password are not recognised, so I cannot connect to the PC.

- Some OS versions, including Windows 8, use two types of accounts: a local account and a Microsoft account.
 - Be sure to use the user name and password for the local account.
 - If you haven't set up a local account, please create one.

Transmission of the image fails midway. Some images cannot be transmitted.

- Image cannot be transmitted when the battery indicator is flashing red.
- Is the size of the image too large?
 - Reduce the image size at [Size], and then send.
 - Transmit after dividing the motion picture with [Video Divide].
- File format of the motion picture that can be sent differs depending on the destination.
- Capacity or number of images in the web service is full.
 - Login to "LUMIX CLUB", and check the status of the destination on the web service link settings.

The motion pictures cannot be played back on a TV.

- Are you trying to play back the motion pictures by directly inserting the card in the card slot of the TV?
 - Connect the camera to the TV with the AV cable (optional), or with the HDMI micro cable, and then play back the motion pictures on the camera. (P71)

VIERA Link does not work.

- Is it connected properly with the HDMI micro cable? (P71)
- Is the [VIERA Link] on this unit set to [ON]?
 - If the input channel does not switch automatically, use the remote control for the TV to switch it.
 - Check the VIERA Link setting on the connected device.
 - Turn this unit off and on.
 - Set [HDAVI Control] to [Off] on the TV and then turn it back to [On].
(Refer to the operating instructions of the TV for details.)
 - Check [Video Out] setting.

There is a sound from lens unit.

- It is a sound of lens movement or aperture operation when this unit is turned on or off, and it is not a malfunction.
- The sound, which is caused by the automatic adjustment of the aperture, is heard when the brightness has changed due to, for example, zooming or the movement of the camera. This is not a malfunction.

The camera becomes warm.

- The surface of the camera and the reverse side of the monitor may become warm during use. This does not affect the performance or quality of the camera.

The clock is reset.

- If you do not use the camera for a long time, the clock may be reset.
 - [Please set the clock] message will be displayed; please reset the clock. (P18)

Zooming stops instantaneously.

- When using the Extra Optical Zoom, the zooming action will stop temporarily. This is not a malfunction.

Specifications

Specifications are subject to change without notice.

Digital Camera:

Information for your safety

Power Source:	DC 8.4 V
Power Consumption:	2.4 W (When recording with Monitor) 2.8 W (When recording with Viewfinder) 1.7 W (When playing back with Monitor) 1.7 W (When playing back with Viewfinder)
Camera effective pixels	20,100,000 pixels
Image sensor	1" MOS sensor, total pixel number 20,900,000 pixels, Primary colour filter
Lens	Optical 16× zoom, f = 9.12 mm to 146 mm (35 mm film camera equivalent: 25 mm to 400 mm) Wide: F2.8 to F8.0 (when recording motion pictures: F2.8 to F11) Tele: F4.0 to F8.0 (when recording motion pictures: F4.0 to F11)
Image Stabiliser	Optical method
Focus range	
AF	30 cm (0.98 feet) (Wide)/1 m (3.3 feet) (Tele) to ∞
AF Macro/MF/ Intelligent Auto/ Motion Picture	3 cm (0.098 feet) (Wide)/1 m (3.3 feet) (Tele) to ∞
Shutter system	Electronic shutter+Mechanical shutter
Minimum Illumination	Approx. 9 lx (when i-Low light is used, the shutter speed is 1/25th of a second)
Shutter speed	
Still picture	B (Bulb) (Max. approx. 120 second), 60 to 1/4000th seconds (with the mechanical shutter) 1 to 1/16000th seconds (with the electronic shutter)
Motion picture	1/25th seconds to 1/16000th of a second 1/2th seconds to 1/16000th of a second (when [M] is selected in Creative Video Mode, MF)
Exposure (AE)	Programme AE (P)/Aperture-Priority AE (A)/ Shutter-Priority AE (S)/Manual Exposure (M)/AUTO
Light metering mode	Multiple/Centre weighted/Spot
Monitor	3.0" Monitor (3:2) (Approx. 920,000 dots) (field of view ratio about 100%)

Viewfinder	OLED Live Viewfinder (4:3) (Approx. 2,360,000 dots) (field of view ratio about 100%) (with diopter adjustment -4 to +4 diopter)	
Flash	Built-in pop up flash AUTO, AUTO/Red-Eye Reduction, Forced ON, Forced ON/ Red-Eye Reduction, Slow Sync., Slow Sync./Red-Eye Reduction, Forced OFF	
Microphone	Stereo	
Speaker	Monaural	
Recording media	SD Memory Card/SDHC Memory Card*/SDXC Memory Card* (* UHS-I UHS Speed Class 3)	
Recording file format		
Still Picture	RAW/JPEG (based on "Design rule for Camera File system", based on "Exif 2.3" standard, DPOF corresponding)	
Motion pictures	AVCHD Progressive/AVCHD/MP4	
Audio compression	AVCHD	Dolby [®] Digital (2 ch)
	MP4	AAC (2 ch)
Interface		
Digital	"USB 2.0" (High Speed) * Data from the PC can not be written to the camera using the USB connection cable.	
Analogue video/ audio	NTSC/PAL Composite Audio line output (monaural)	
Terminal		
[MIC]	∅ 3.5 mm jack	
[REMOTE]	∅ 2.5 mm jack	
[AV OUT/DIGITAL]	Dedicated jack (8 pin)	
[HDMI]	MicroHDMI Type D	
Dimensions	Approx. 136.8 mm (W)×98.5 mm (H)×130.7 mm (D) [5.39"(W)×3.88"(H)×5.15"(D)]	
Mass	Approx. 831 g/1.83 lb (with card and battery) Approx. 780 g/1.72 lb (excluding card and battery)	
Operating temperature	0 °C to 40 °C (32 °F to 104 °F)	
Operating humidity	10%RH to 80%RH	

Wireless transmitter

Compliance standard	IEEE 802.11b/g/n (standard wireless LAN protocol)
Frequency range used (central frequency)	2412 MHz to 2462 MHz (1 to 11ch)
Encryption method	Wi-Fi compliant WPA™/WPA2™
Access method	Infrastructure mode

NFC

Compliance standard	ISO/IEC 18092 NFC-F (Passive Mode)
----------------------------	------------------------------------

Battery Charger (Panasonic DE-A80A):

Information for your safety

Input:	AC ~ 110 V to 240 V, 50/60 Hz, 0.2 A
Output:	DC --- 8.4 V, 0.65 A

Battery Pack (lithium-ion) (Panasonic DMW-BLC12E):

Information for your safety

Voltage/capacity:	7.2 V/1200 mAh
--------------------------	----------------

Digital Camera Accessory System

Description	Accessory#
Battery Pack	DMW-BLC12
AC Adaptor*	DMW-AC10
DC Coupler*	DMW-DCC8
MC Protector	DMW-LMCH62
ND Filter	DMW-LND62
PL Filter (Circular Type)	DMW-LPL62
Flash	DMW-FL360L, DMW-FL580L
LED Video Light	VW-LED1
Stereo Shotgun Microphone	DMW-MS2
Stereo Microphone	VW-VMS10
Remote Shutter	DMW-RSL1
USB connection Cable	DMW-USBC1
AV Cable	DMW-AVC1

* The AC Adaptor (optional) can only be used with the designated Panasonic DC Coupler (optional). The AC adaptor (optional) cannot be used by itself.

Product numbers correct as of June 2014. These may be subject to change.

• Some optional accessories may not be available in some countries.

• NOTE: Accessories and/or model numbers may vary between countries. Consult your local dealer.

Sales and Support Information

Customer Communications Centre

- For customers within the UK: 0844 844 3899
- For customers within Ireland: 01 289 8333
- Monday – Friday 9:00 am – 5:00 pm (Excluding public holidays).
- For further support on your product, please visit our website:
www.panasonic.co.uk

Direct Sales at Panasonic UK

- Order accessory and consumable items for your product with ease and confidence by phoning our Customer Communications Centre Monday – Friday 9:00 am – 5:00 pm (Excluding public holidays).
- Or go on line through our Internet Accessory ordering application at www.pas-europe.com.
- Most major credit and debit cards accepted.
- All enquiries transactions and distribution facilities are provided directly by Panasonic UK.
- It couldn't be simpler!
- Also available through our Internet is direct shopping for a wide range of finished products. Take a browse on our website for further details.

Reading the Operating Instructions (PDF format)

- Please also refer to the “Operating Instructions for advanced features (PDF format)”, which describes more detailed information.

More detailed instructions on the operation of this camera are contained in “Operating Instructions for advanced features (PDF format)” in the supplied DVD. Install it on your PC to read it.

■ For Windows

- 1 Turn the PC on and insert the DVD containing the Operating Instructions (supplied).
- 2 Click the [Operating Instructions].
- 3 Select the desired language and then click [Operating Instructions] to install.
 - Ⓐ To return to the install menu.
- 4 Double click the “Operating Instructions” shortcut icon on the desktop.

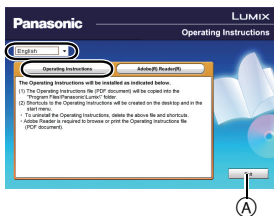

■ When the Operating Instructions (PDF format) will not open

You will need Adobe Acrobat Reader 5.0 or later or Adobe Reader 7.0 or later to browse or print the Operating Instructions (PDF format).

- You can download and install a version of Adobe Reader that you can use with your OS from the following Web Site.

<http://get.adobe.com/reader/otherversions>

■ To uninstall the Operating Instructions (PDF format)

Delete the PDF file from the “Program Files\Panasonic\Lumix\” folder.

■ For Mac

- 1 Turn the PC on and insert the DVD containing the Operating Instructions (supplied).
- 2 Open the “Manual” folder in the DVD.
 - “Manual” folder is displayed again.
- 3 Open the “Manual” folder in the DVD and then copy the PDF file with the desired language inside the folder.
- 4 Double click the PDF file to open it.

This product incorporates the following software:

- (1) the software developed independently by or for Panasonic Corporation,
- (2) the software owned by third party and licensed to Panasonic Corporation, and/or
- (3) open source software

The software categorised as (3) is distributed in the hope that it will be useful, but WITHOUT ANY WARRANTY, without even the implied warranty of MERCHANTABILITY or FITNESS FOR A PARTICULAR PURPOSE.

Please refer to the detailed terms and conditions thereof displayed by selecting [MENU/SET] → [Setup] → [Version Disp.] → [Software info].

- SDXC Logo is a trademark of SD-3C, LLC.
- “AVCHD”, “AVCHD Progressive” and the “AVCHD Progressive” logo are trademarks of Panasonic Corporation and Sony Corporation.
- Manufactured under license from Dolby Laboratories. Dolby and the double-D symbol are trademarks of Dolby Laboratories.
- HDMI, the HDMI Logo, and High-Definition Multimedia Interface are trademarks or registered trademarks of HDMI Licensing LLC in the United States and other countries.
- HDAVI Control™ is a trademark of Panasonic Corporation.
- Adobe is a trademark or registered trademark of Adobe Systems Incorporated in the United States and/or other countries.
- iMovie, Mac and Mac OS are trademarks of Apple Inc., registered in the U.S. and other countries.
- iPad, iPhone, iPod, and iPod touch are trademarks of Apple Inc., registered in the U.S. and other countries.
- App Store is a service mark of Apple Inc.



- Windows and Windows Vista are either registered trademarks or trademarks of Microsoft Corporation in the United States and/or other countries.
- Android and Google Play are trademarks or registered trademarks of Google Inc.
- The Wi-Fi CERTIFIED Logo is a certification mark of the Wi-Fi Alliance.
- The Wi-Fi Protected Setup Mark is a mark of the Wi-Fi Alliance.
- “Wi-Fi”, “Wi-Fi Protected Setup”, “Wi-Fi Direct”, “WPA” and “WPA2” are marks or registered marks of the Wi-Fi Alliance.
- DLNA, the DLNA Logo and DLNA CERTIFIED are trademarks, service marks, or certification marks of the Digital Living Network Alliance.
- This product uses “DynaFont” from DynaComware Corporation. DynaFont is a registered trademark of DynaComware Taiwan Inc.
- QR Code is a registered trademark of DENSO WAVE INCORPORATED.
- Other names of systems and products mentioned in these instructions are usually the registered trademarks or trademarks of the manufacturers who developed the system or product concerned.



This product is licensed under the AVC patent portfolio license for the personal and non-commercial use of a consumer to (i) encode video in compliance with the AVC Standard (“AVC Video”) and/or (ii) decode AVC Video that was encoded by a consumer engaged in a personal and non-commercial activity and/or was obtained from a video provider licensed to provide AVC Video. No license is granted or shall be implied for any other use. Additional information may be obtained from MPEG LA, LLC. See <http://www.mpegla.com> .

Manufactured by: Panasonic Corporation
Kadoma, Osaka, Japan

Importer for Europe: Panasonic Marketing Europe GmbH
Panasonic Testing Centre
Winsbergring 15, 22525 Hamburg, Germany



Panasonic Corporation

Web Site: <http://panasonic.net>

© Panasonic Corporation 2014