

Panasonic®

Operating Instructions

Amplified Cordless Telephone with Digital Answering Machine

Model No. **KX-TGM420**
KX-TGM450



*Before initial use, see “Getting Started”
on page 12.*

Thank you for purchasing a Panasonic product.

Please read these operating instructions before using the unit and save them for future reference.

Consulte “Guía Rápida Española”, página 73.

For assistance, visit our Web site: <http://shop.panasonic.com/support> for customers in the U.S.A.

Please register your product: <http://shop.panasonic.com/support>

Table of Contents

Introduction	
Model composition	4
Accessory information	4
Graphical symbols for use on equipment and their descriptions	6
Important Information	
For your safety	7
Important safety instructions	9
For best performance	9
Other information	10
Specifications	11
Getting Started	
Setting up	12
Controls	17
Display icons	20
Language settings	21
Date and time	21
Recording your greeting message	22
Other settings	22
Accessibility	
Accessibility	23
Tone control	23
Volume booster	24
Speech booster (making your voice louder)	26
Talking keypad and phonebook	26
Key tones	27
Message indicator	28
Slow talk	29
Using assistive listening devices	29
Making/Answering Calls	
Making calls	32
Answering calls	32
Useful features during a call	33
Intercom	35
Call Block	
Call block	37
Storing unwanted callers	37
Phonebook	
Phonebook	39
Memory dial	41
Programming	
Menu list	42
Alarm	49
Silent mode	49
Other programming	50
Registering a unit	50
Caller ID Service	
Using Caller ID service	52
Caller list	52
Answering System	
Answering system	54
Turning the answering system on/off	54
Greeting message	54
Listening to messages	55
Advanced new message alerting features	56
Remote operation	58
Answering system settings	59



Table of Contents

Useful Information

Voicemail service60
Wall mounting61
Error messages63
Troubleshooting64
FCC and other information ...70

Guía Rápida Española

Guía Rápida Española73

Appendix

Customer services79
Limited Warranty (ONLY FOR
U.S.A.)80

Index

Index.....82

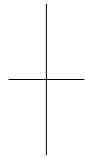
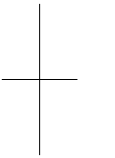

Introduction

Model composition

Series	Model No.	Base unit	Handset	
		Part No.	Part No.	Quantity
KX-TGM420 series	KX-TGM420	KX-TGM420	KX-TGMA44	1
KX-TGM450 series	KX-TGM450	KX-TGM450	KX-TGMA45	1

Accessory information

Supplied accessories

No.	Accessory item/Part number	Quantity
①	AC adaptor*1, *2	1
②	Telephone line cord*2, *3	1
③	Wall mounting adaptor/PNKL1001Y3	1
④	Rechargeable batteries*4, *5	4
⑤	Handset cover*6/PNYNTGMA44WR	1
⑥	Belt clip*7/PNKE2076Z1	1

*1 PNLV226X: KX-TGM420

PNLV236-0Y: KX-TGM450

*2 The AC adaptor and telephone line cord come connected to the base unit at the time of shipment.

*3 PQJA10075Y (Black cord), PQJA10075Z (Transparent cord)

*4 The supplied rechargeable batteries in the handset and base unit are installed with yellow insulation sheets inserted between battery ends and the terminals at the time of shipment. Remove the yellow insulation sheets before use.

*5 See page 5 for replacement battery information.

*6 The handset cover comes attached to the handset at the time of shipment.

*7 The belt clip comes attached to the handset at the time of shipment.

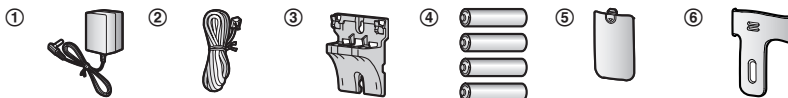

Additional/replacement accessories

Please contact your nearest Panasonic dealer for sales information (page 79).

Accessory item	Model number/Specifications
Rechargeable batteries	HHR-4DPA*1 <ul style="list-style-type: none"> To order, please visit http://shop.panasonic.com/support
	Battery type: <ul style="list-style-type: none"> Nickel metal hydride (Ni-MH) 2 x AAA (R03) size for each handset
Headset	KX-TCA60, KX-TCA400, KX-TCA430
Range extender	KX-TGA405*2
Key detector	KX-TGA20*3

- *1 Replacement batteries may have a different capacity from that of the supplied batteries.
 *2 By installing this unit, you can extend the range of your phone system to include areas where reception was previously not available. This product can be purchased online. Please visit our Web site: <http://shop.panasonic.com/support>
 *3 By registering the key detector (4 max.) to a Panasonic Digital Cordless Phone and attaching it to an easy-to-lose item in advance, you can locate and find the mislaid item to which the key detector is attached. Please visit our Web site: <http://www.panasonic.com/tga20>

Other information

- Design and specifications are subject to change without notice.
- The illustrations in these instructions may vary slightly from the actual product.













Expanding your phone system

Handset (optional): KX-TGMA44*1/KX-TGMA45*2	
<p>You can expand your phone system by registering optional handsets (6 max.) to a single base unit.</p> <ul style="list-style-type: none"> Optional handsets may be a different color from that of the supplied handsets. 	

- *1 Maximum receiver volume is 40 dB (when the booster is on).
 *2 Maximum receiver volume is 50 dB (when the booster is on).

Introduction

Graphical symbols for use on equipment and their descriptions

Symbol	Explanation	Symbol	Explanation
	Alternating current (A.C.)		Class II equipment (equipment in which protection against electric shock relies on Double Insulation or Reinforced Insulation)
	Direct current (D.C.)		"ON" (power)
	Protective earth		"OFF" (power)
	Protective bonding earth		Stand-by (power)
	Functional earth		"ON"/"OFF" (power; push-push)
	For indoor use only		Caution, risk of electric shock

For your safety

To prevent severe injury and loss of life/property, read this section carefully before using the product to ensure proper and safe operation of your product.

WARNING

Power connection

- Use only the power source marked on the product.
- Do not overload power outlets and extension cords. This can result in the risk of fire or electric shock.
- Completely insert the AC adaptor/power plug into the power outlet. Failure to do so may cause electric shock and/or excessive heat resulting in a fire.
- Regularly remove any dust, etc. from the AC adaptor/power plug by pulling it from the power outlet, then wiping with a dry cloth. Accumulated dust may cause an insulation defect from moisture, etc. resulting in a fire.
- Unplug the product from power outlets if it emits smoke, an abnormal smell, or makes an unusual noise. These conditions can cause fire or electric shock. Confirm that smoke has stopped emitting and contact us at <http://shop.panasonic.com/support>
- Unplug from power outlets and never touch the inside of the product if its casing has been broken open.
- Never touch the plug with wet hands. Danger of electric shock exists.

Installation

- To prevent the risk of fire or electrical shock, do not expose the product to rain or any type of moisture.
- Do not place or use this product near automatically controlled devices such as automatic doors and fire alarms. Radio waves emitted from this product may cause such devices to malfunction resulting in an accident.
- Do not allow the AC adaptor or telephone line cord to be excessively pulled, bent or placed under heavy objects.

Operating safeguards

- Unplug the product from power outlets before cleaning. Do not use liquid or aerosol cleaners.
- Do not disassemble the product.
- Do not spill liquids (detergents, cleansers, etc.) onto the telephone line cord plug, or allow it to become wet at all. This may cause a fire. If the telephone line cord plug becomes wet, immediately pull it from the telephone wall jack, and do not use.
- To prevent hearing damage, make sure anyone who uses this product is aware that the product can produce very loud sounds, and make sure children use this product only under adult supervision.
- To prevent hearing damage, we recommend that you set this product to the lowest volume setting at which you can hear adequately. Note that when the BOOST indicator is lit in red, the volume booster feature is enabled and the product may emit sounds at very high volume.
- Avoid prolonged exposure to loud sounds produced by this product. Be aware that the louder a sound is, the less time is needed to cause hearing damage. In the event that you experience hearing discomfort, consult a medical professional.

Important Information

Medical

- Consult the manufacturer of any personal medical devices, such as pacemakers or hearing aids, to determine if they are adequately shielded from external RF (radio frequency) energy. (The product operates in the frequency range of 1.92 GHz to 1.93 GHz, and the RF transmission power is 115 mW (max.).)
- Do not use the product in health care facilities if any regulations posted in the area instruct you not to do so. Hospitals or health care facilities may be using equipment that could be sensitive to external RF energy.

CAUTION

Installation and location

- Never install telephone wiring during an electrical storm.
- Never install telephone line jacks in wet locations unless the jack is specifically designed for wet locations.
- Never touch uninsulated telephone wires or terminals unless the telephone line has been disconnected at the network interface.
- Use caution when installing or modifying telephone lines.
- The AC adaptor is used as the main disconnect device. Ensure that the AC outlet is installed near the product and is easily accessible.
- This product is unable to make calls when:
 - the handset batteries need recharging or have failed.
 - there is a power failure.

Ni-MH rechargeable batteries (supplied)

- We recommend using the batteries noted on page 5. **USE ONLY rechargeable Ni-MH batteries AAA (R03) size.**
- Do not mix old and new batteries.
- Do not open or mutilate the batteries. Released electrolyte from the batteries is corrosive and may cause burns or injury to the eyes or skin. The electrolyte is toxic and may be harmful if swallowed.
- Exercise care when handling the batteries. Do not allow conductive materials such as rings, bracelets, or keys to touch the batteries, otherwise a short circuit may cause the batteries and/or the conductive material to overheat and cause burns.
- Charge the batteries provided with or identified for use with this product only, in accordance with the instructions and limitations specified in this manual.
- Only use a compatible base unit (or charger) to charge the batteries. Do not tamper with the base unit (or charger). Failure to follow these instructions may cause the batteries to swell or explode.

Attention:



A nickel metal hydride battery that is recyclable powers the product you have purchased. Please call 1-800-8-BATTERY (1-800-822-8837) for information on how to recycle this battery.

Important Information

Note when using alkaline batteries for power backup

- The batteries should be used correctly, otherwise the unit may be damaged due to battery leakage.
- Do not charge, short-circuit, disassemble, or heat the batteries.
- Do not dispose of batteries in a fire.
- Remove all the batteries when replacing.
- Do not mix old, new or different types of batteries.
- It is recommended that batteries are replaced annually.
- It is recommended that batteries are replaced after a power outage.

Important safety instructions

When using your product, basic safety precautions should always be followed to reduce the risk of fire, electric shock, and injury to persons, including the following:

1. Do not use this product near water for example, near a bathtub, washbowl, kitchen sink, or laundry tub, in a wet basement or near a swimming pool.
2. Avoid using a telephone (other than a cordless type) during an electrical storm. There may be a remote risk of electric shock from lightning.
3. Do not use the telephone to report a gas leak in the vicinity of the leak.
4. Use only the power cord and batteries indicated in this manual. Do not dispose of batteries in a fire. They may explode. Check with local codes for possible special disposal instructions.

SAVE THESE INSTRUCTIONS

For best performance

Base unit location/avoiding noise

The base unit and other compatible Panasonic units use radio waves to communicate with each other.

- For maximum coverage and noise-free communications, place your base unit:
 - at a convenient, high, and central location with no obstructions between the handset and base unit in an indoor environment.
 - away from electronic appliances such as TVs, radios, personal computers, wireless devices, or other phones.
 - facing away from radio frequency transmitters, such as external antennas of mobile phone cell stations. (Avoid putting the base unit on a bay window or near a window.)
- Coverage and voice quality depends on the local environmental conditions.
- If the reception for a base unit location is not satisfactory, move the base unit to another location for better reception.

Environment

- Keep the product away from electrical noise generating devices, such as fluorescent lamps and motors.
- The product should be kept free from excessive smoke, dust, high temperature, and vibration.
- The product should not be exposed to direct sunlight.
- Do not place heavy objects on top of the product.
- When you leave the product unused for a long period of time, unplug the product from the power outlet.

For assistance, please visit <http://shop.panasonic.com/support>

9

Important Information

- The product should be kept away from heat sources such as heaters, kitchen stoves, etc. It should not be placed in rooms where the temperature is less than 0 °C (32 °F) or greater than 40 °C (104 °F). Damp basements should also be avoided.
- The maximum calling distance may be shortened when the product is used in the following places: Near obstacles such as hills, tunnels, underground, near metal objects such as wire fences, etc.
- Operating the product near electrical appliances may cause interference. Move away from the electrical appliances.

Routine care

- **Wipe the outer surface of the product with a soft moist cloth.**
- Do not use benzine, thinner, or any abrasive powder.

Other information

CAUTION: Risk of explosion if battery is replaced by an incorrect type. Dispose of used batteries according to the instructions.

Notice for product disposal, transfer, or return

- This product can store your private/confidential information. To protect your privacy/confidentiality, we recommend that you erase information such as phonebook or caller list entries from the memory before you dispose of, transfer, or return the product.

Notice

- This product is designed for use in the United States of America. Sale or use of this product in other countries may violate local laws.
- Cet appareil est conçu pour être utilisé aux États-Unis d'Amérique. La vente ou l'emploi de cet appareil dans certains autres pays peut constituer une infraction à la législation locale.
- Este producto está diseñado para usarse en los Estados Unidos de América. La venta o el empleo de este producto en ciertos países puede constituir violación de la legislación local.
- 本產品專為美國使用而設。若在其他國家銷售或使用，可能會違反當地法例。
- この製品は、日本国外での使用を目的として設計されており、日本国内での使用は法律違反となります。従って、当社では日本国内においては原則として修理などのサービスは致しかねます。

Specifications

- **Standard:**
DECT 6.0 (Digital Enhanced Cordless Telecommunications 6.0)
 - **Frequency range:**
1.92 GHz to 1.93 GHz
 - **RF transmission power:**
115 mW (max.)
 - **Power source:**
120 V AC, 60 Hz
 - **Power consumption:**
Base unit*1:
Standby: Approx. 0.8 W
Maximum: Approx. 4.3 W
Base unit*2:
Standby: Approx. 1.0 W
Maximum: Approx. 8.3 W
 - **Operating conditions:**
0 °C – 40 °C (32 °F – 104 °F), 20 % – 80 % relative air humidity (dry)
- *1 KX-TGM420
*2 KX-TGM450

Getting Started

Setting up

Connections

- ① Connect the AC adaptor to the unit by pressing the plug firmly.
- ② Fasten the cord by hooking it.
- ③ Connect the AC adaptor to the power outlet.
- ④ Connect the telephone line cord to the unit, then to the single-line telephone jack (RJ11C) until you hear a click.
- ⑤ A DSL/ADSL filter (not supplied) is required if you have a DSL/ADSL service.

Note:

- The AC adaptor and telephone line cord come connected to the base unit at the time of shipment.
- Use only the supplied Panasonic AC adaptor.*1

*1 PNLV226: KX-TGM420
PNLV236: KX-TGM450

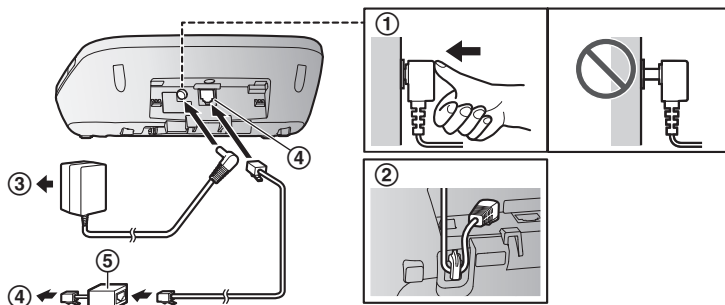

Handset battery charging

2 rechargeable Ni-MH batteries are installed in the handset at the time of shipment.

Before initial use: Remove the yellow insulation sheet before using the handset.

Charge for about 7 hours.

- Confirm “Charging” is displayed (A).
- When the batteries are fully charged, “Fully charged” is displayed.

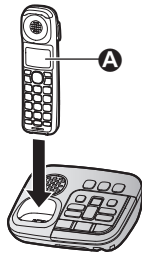

- Follow the directions on the display to set up the unit.

Handset battery level

Icon	Battery level
	High
	Medium
	Low
	Needs charging.
	Empty

Panasonic Ni-MH battery performance

Operation	Operating time
In continuous use	13 hours max.*1
Not in use (standby)	9 days max.*1

*1 If eco mode is on and booster is off.

Getting Started

Note:

- Actual battery performance depends on usage and ambient environment.

Handset battery installation (for replacement)

- USE ONLY rechargeable Ni-MH batteries AAA (R03) size (A).
- Do NOT use alkaline/manganese/Ni-Cd batteries.
- Confirm correct polarities (+, -).

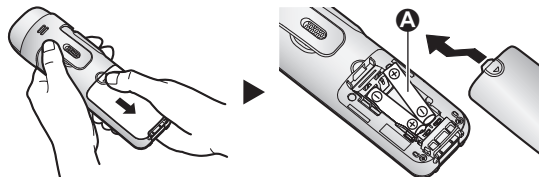

Base unit backup batteries

2 rechargeable Ni-MH batteries are installed in the base unit at the time of shipment. These batteries can be used to supply power to the base unit in the event of a power failure.

Before initial use: Remove the yellow insulation sheet before using the base unit.

Base unit battery status when a power failure occurs

Item	Battery status
<i>PF</i>	Power backup mode is on.*1
<i>PF</i> (flashing)	Battery power is low.*2

*1 When the base unit is running on battery power, “PF” is displayed on the message counter of the base unit. If there is other information that can be displayed, such as the number of answering system messages, the other information is displayed.

*2 When the base unit is running on battery power and the remaining battery power is too low, “PF” flashes and the base unit beeps. Additionally, the base unit’s message indicator flashes.

Panasonic Ni-MH battery performance when operating on backup battery power

Operation	Operating time
In continuous use	3 hours max.

Getting Started

Operation	Operating time
Not in use (standby)	4 hours max.

Note:

- Battery performance depends on the type of batteries.
- Actual battery performance depends on usage and ambient environment.
- If the base unit is running on battery power, the brightness of the message counter on the base unit is reduced to save battery power.
- When the base unit is running on battery power, the maximum ringer volume of the base unit will be reduced.
- If your phone service provider requires additional devices in order to make and receive calls, such as a modem, you may still not be able to make and receive calls even if the base unit's backup power feature is functioning.

Base unit battery installation (for replacement)

Important:

- The following AAA (R03) size batteries can be used with the base unit:
 - Rechargeable Ni-MH batteries*1
 - Standard (non-rechargeable) alkaline batteries*2
- Do NOT use manganese batteries.
- Confirm correct polarities (⊕, ⊖).

*1 The base unit can fully charge Ni-MH batteries in about 15 hours.

*2 If the rechargeable batteries become depleted during a power failure, you can insert alkaline batteries into the base unit. Remove the alkaline batteries when power is restored.

- 1 Disconnect the telephone line cord (1).
- 2 Open the battery cover (2).
- 3 Install the batteries in the battery compartment (3).
- 4 Close the cover (4), then reconnect the telephone line cord (5).

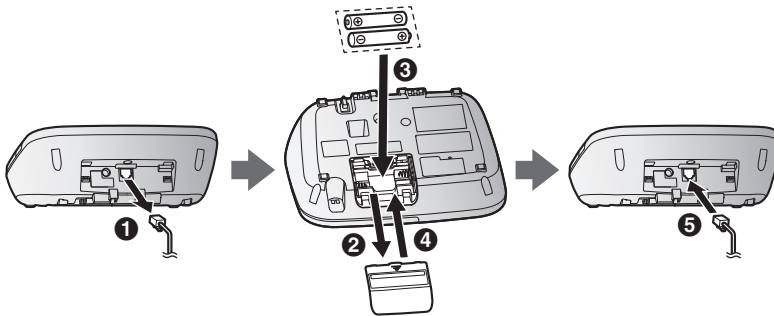

For assistance, please visit <http://shop.panasonic.com/support>

15

Getting Started

Note when setting up

Note for connections

- The AC adaptor must remain connected at all times. (It is normal for the adaptor to feel warm during use.)
- The AC adaptor should be connected to a vertically oriented or floor-mounted AC outlet. Do not connect the AC adaptor to a ceiling-mounted AC outlet, as the weight of the adaptor may cause it to become disconnected.

Note for battery installation

- Use the supplied rechargeable batteries. For replacement, we recommend using the Panasonic rechargeable batteries noted on page 5, 8.

Note for battery charging

- It is normal for the handset to feel warm during charging.
- Clean the charge contacts of the handset, base unit, and charger with a soft and dry cloth once a month. Before cleaning the unit, disconnect from power outlets and any telephone line cords. Clean more often if the unit is exposed to grease, dust, or high humidity.

Intelligent eco mode

This feature automatically reduces handset power consumption by suppressing handset transmission power when the handset is close to the base unit.

- When this feature is activated, **ECO** is displayed.
- Eco mode is turned off when the sound enhancer is activated (page 34).

Controls

Handset

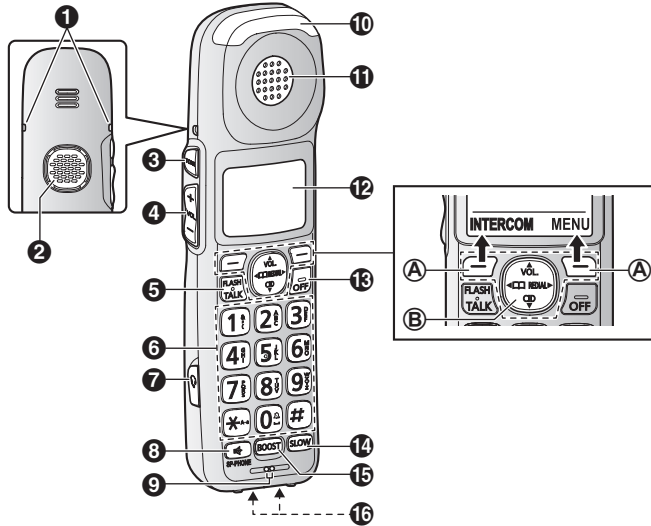

1 Belt clip holes

- The belt clip comes attached to the handset at the time of shipment.

2 Speaker

3 [TONE] (Tone control)

4 [+]/[-] (VOL.: Volume up/down)

5 [FLASH] [TALK]

6 Dial keypad

: Temporary tone dialing

: (♫) Ringer off

7 Headset jack

- This jack is used to connect an optional headset (page 5) or a user-supplied neckloop to the handset. You must set the “**Headset type**” setting to match the type of device connected (page 30).

Getting Started

8 **[📞]** (SP-PHONE: Speakerphone)

9 **Microphone**

10 **Message indicator**

11 **Receiver**

12 **Display**

13 **[OFF]**

14 **[SLOW] (SLOW TALK)**
SLOW TALK indicator

15 **[BOOST]**
BOOST indicator

- Light off: Volume booster is turned off.
- Light in red: Volume booster is turned on.

Note that when the BOOST indicator is lit in red, the volume booster feature is enabled and the product may emit sounds at very high volume.

16 **Charge contacts**

■ Control type

Ⓐ **Soft keys**

By pressing a soft key, you can select the feature shown directly above it on the display.

Ⓑ **Navigator key**

- **[▲]**, **[▼]**, **[◀]**, or **[▶]**: Scroll through various lists and items.
- **VOL.** (Volume: **[▲]** or **[▼]**): Adjust the receiver or speaker volume while talking.
- **[◀]** **☎**: View the phonebook entry.
- **[▶]** **REDIAL**: View the redial list.
- **[▼]** **CID** (Caller ID): View the caller list.

Base unit

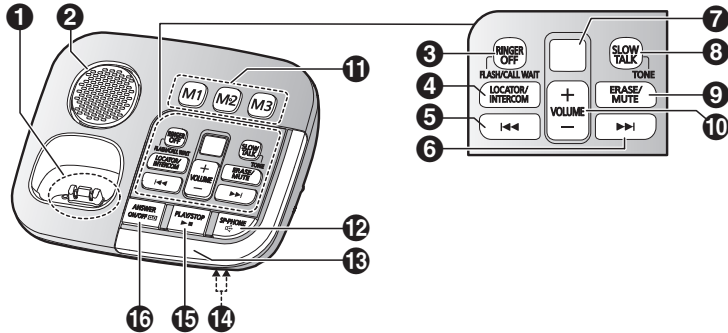

















- 1** Charge contacts
- 2** Speaker
- 3** **[RINGER OFF]**
RINGER OFF indicator
[FLASH/CALL WAIT]
- 4** **[LOCATOR/INTERCOM]**
 - You can locate a misplaced handset by pressing **[LOCATOR/INTERCOM]**.
- 5** **[◀◀] (Repeat)**
- 6** **[▶▶] (Skip)**
- 7** Message counter
- 8** **[SLOW TALK]**
SLOW TALK indicator
[TONE] (Tone control)
- 9** **[ERASE/MUTE]**
- 10** **[+]/[-] (VOLUME: Volume up/down)**
- 11** **[M1] (Memory dial 1)**
[M2] (Memory dial 2)
[M3] (Memory dial 3)
- 12** **[📞] (SP-PHONE: Speakerphone)**
SP-PHONE indicator (📞)
- 13** Message indicator

Getting Started

- 14 Microphone
- 15 **[▶■] (PLAY/STOP)**
New Message/Play indicator (▶)
- 16 **[ANSWER ON/OFF]**
ANSWER ON/OFF indicator (ON)

Display icons

Handset display items

Item	Meaning
	Within base unit range
	Out of base unit range
	Sound enhancer is on. (page 34)
	The line is in use. <ul style="list-style-type: none">• When flashing: The call is put on hold.• When flashing rapidly: An incoming call is now being received.
	Speech booster is on. (page 26)
	Eco mode is on. (page 16)
	Noise reduction is set. (page 34)
	Tone control level (Tone 1-6 or Custom tone)
	
	Speakerphone is on. (page 32)
	Ringer volume is off. (page 33, 44)
	Silent mode is on. (page 50)
	Call sharing mode is off. (page 47)
	Alarm is on. (page 49)
	Handset number
	Battery level
	Blocked call (page 37)
In use	Answering system is being used by another handset or the base unit.
Line in use	Someone is using the line.

Base unit display items

Item	Meaning
<i>GO</i>	"Greeting only" is selected. Caller messages are not recorded. (page 59)
<i>PF</i>	Power backup mode is on. (page 14)

Language settings**Display language**

- 1 **[MENU]** **#** **1** **1** **0**
- 2 **[↕]**: Select the desired setting. → **[SAVE]** → **[OFF]**

Voice announcement language

You can select the language used for the following features.

- Answering system guidance
- Talking Caller ID
- Talking keypad and phonebook

- 1 **[MENU]** **#** **1** **1** **2**
- 2 **[↕]**: Select the desired setting. → **[SAVE]** → **[OFF]**
 - The setting will be applied in about 5 seconds.

Date and time

- 1 **[MENU]** **#** **1** **0** **1**
- 2 Enter the current month, date, and year by selecting 2 digits for each.
Example: July 12, 2016
0 **7** **1** **2** **1** **6**
- 3 **[OK]**

Getting Started

- 4 Enter the current hour and minute (12-hour clock format) by selecting 2 digits for each.

Example: 9:30

[0] [9] [3] [0]

- 5 **[X]**: Select “AM” or “PM”.

- 6 **[SAVE]** → **[OFF]**

Note:

- When English is selected as the display language, 12-hour clock format is used. When Spanish is selected, 24-hour clock format is used.

Recording your greeting message

You can record your own greeting message instead of using a pre-recorded greeting message. See page 54 for details.

- 1 **[MENU]** **#** **[3] [0] [2]**

- 2 **[↕]**: “Yes” → **[SELECT]**

- 3 Record a greeting message. → **[STOP]** → **[OFF]**

Other settings

Dialing mode

If you cannot make calls, change this setting according to your telephone line service. The default setting is “Tone”.

“Tone”: For tone dial service.

“Pulse”: For rotary/pulse dial service.

- 1 **[MENU]** **#** **[1] [2] [0]**

- 2 **[↕]**: Select the desired setting. → **[SAVE]** → **[OFF]**

Accessibility

This product is designed to provide not only optimal volume, but optimal sound quality as well, ensuring that every call is heard loud and clear.

Tone control

This feature clarifies the voice of the person you are talking to, producing a more natural-sounding voice that is easier to hear and understand. This feature can be set for each unit.

The following settings are available.

Handset:

- Receiver: “**Tone 1-6**” and “**Custom tone 1-20**”
- Speakerphone: “**Tone 1-4**”
- Headset: “**Tone 1-4**” and “**Custom tone 1-20**”

Base unit: “**1-4**” (Tone 1-4)

Handset

You can select a tone control setting while talking on the phone.

There are two methods available.

■ Using the [TONE] key

- 1 Press [TONE] on the side repeatedly to select the desired setting while talking.
- 2 To exit, press [BACK] or wait for a few seconds.
 - The selected setting is shown on the handset display while talking.

Note:

- To select one of the “**Custom tone**” settings, follow the instructions in “Using the [MENU] key”, page 23.

■ Using the [MENU] key

- 1 Press [MENU] while talking.
- 2 [↕]: “**Tone control**” → [SELECT]

Accessibility

3 **[↕]**: Select the desired setting. → **[OK]**

- If you select "Custom tone", select the desired type. → **[OK]**
- The selected setting is shown on the handset display while talking.

Base unit

- 1 Press and hold **[TONE]** for about 2 seconds while talking.
- 2 Press **[+]** or **[-]** repeatedly to select the desired setting.
 - The selected setting flashes on the message counter while talking.
- 3 To exit, press **[TONE]** or wait for about 5 seconds.

Note for handset and base unit:

- The selected setting is applied immediately and is also used for future calls.
- Depending on the condition and quality of your telephone line, this feature may emphasize existing line noise. If it becomes difficult to hear, reset to the default setting (Tone 2).

Volume booster

This feature allows you to drastically increase the volume of the other party's voice. This feature can be set for each unit.

⚠ WARNING

- This feature is designed for users who are hard of hearing. If other users use the phone, be sure to turn this feature off.
- Do not use this feature unnecessarily. High volume emitted from the product may cause hearing damage.
- Pressing the **[BOOST]** key activates the volume booster feature. Use this key with care. At its loudest setting (volume and volume booster features set to their highest settings), the product can output sound at up to 40 dB (KX-TGM420) or 50 dB (KX-TGM450). To prevent hearing damage, we recommend that you set this product to the lowest volume setting at which you can hear adequately.

Turning on the volume booster

- 1 Press **[BOOST]** while on a call.
 - The BOOST indicator lights in red.
- 2 Press **[+]** or **[-]** on the side repeatedly to select the desired volume.
 - The selected volume setting is shown on the handset display while talking.
 - The selected volume setting is used for future calls when the booster is turned on.

Note:

- Noise reduction is automatically turned on when the booster is turned on. In this case, the menu that allows you to turn off noise reduction is not shown even after you press **[MENU]** while on a call.
- **NR** is not shown if the noise reduction feature was turned off before you turned on the volume booster.
- If the auto boost feature is turned on (page 25), volume booster turns on automatically when you make or answer a call. If the auto boost feature is turned off, volume booster turns off automatically at the end of each call.

Turning on auto boost

If the auto boost feature is turned on, volume booster turns on automatically when you make or answer a call. This feature is useful if the unit is used mainly by a user who is hard of hearing.

1 **[MENU]** **#** **7** **8** **2**

2 **[↕]**: Select the desired setting. → **[SAVE]** → **[OFF]**

- If the volume booster is turned on, the BOOST indicator lights in red during a call.

Note:

- While on a call, you can temporarily turn the volume booster off by pressing **[BOOST]**, and adjust the volume by pressing **[+]** or **[-]** on the side repeatedly.

Adjusting the volume

While on a call, you can adjust the volume by pressing **[+]** or **[-]** on the side repeatedly.

- The selected volume setting is shown on the handset display.
- The selected volume setting is applied immediately and is also used for future calls. A separate setting is used for when volume booster is on and when it is off.

Available volume settings

The available settings vary by model and whether volume booster is turned on or off.

BOOST indicator	Volume booster	Available volume settings	Default
Light off	Turned off	Receiver: 1–15	15
		Speakerphone: 1–21	15
		Headset: 1–15	15

Accessibility



BOOST indicator	Volume booster	Available volume settings	Default
Light in red	Turned on	KX-TGM420 series	
		Receiver: 12–40	15
		Speakerphone: 18–30	21
		Headset: 12–40	15
		KX-TGM450 series	
		Receiver: 12–50	15
		Speakerphone: 18–40	21
		Headset: 12–50	15

Speech booster (making your voice louder)

This feature allows you to increase the volume of your voice heard by the other party. This feature can be set for each handset.

WARNING

- The speech booster feature can be used to increase the volume of your voice heard by the other party. If this feature is used unnecessarily, your voice may be too loud. We recommend that you use this feature only if your voice is too quiet to be heard by the other party.

- 1 Press **[MENU]** while on a call.
- 2 **[ ]**: “Boost speech on” or “Boost speech off” → **[SELECT]**
 - The selected setting is applied immediately and is also used for future calls.

Note:

- You can set this feature in standby mode (page 45).

Talking keypad and phonebook

This feature helps you by announcing the following information as you use the phone.

Handset:

- Phone numbers entered for dialing, phonebook, and memory dial. The unit can announce numbers (**[0]** to **[9]**), special keys (**[*]**, **#[**, and **[FLASH]**), and dialing pauses (**[▲]**).

- Name or phone numbers when searching the phonebook, caller list, redial list, memory dial entries, and call block list.

Base unit:

- Name or phone numbers when confirming memory dial keys ([M1] – [M3]).

Setting the talking keypad and phonebook

You can enable this feature by setting its volume to “High” or “Low”, and disable it by setting its volume to “Off”. The default setting is “Off”. This feature can be set for each unit.

1 For handset: [MENU]#750

For base unit (using a handset): [MENU]#*750

2 [↕]: Select the desired setting. → [SAVE] → [OFF]

Note:

- If you dial a phone number quickly, the handset may not announce the dialed phone number correctly. For best results, dial slowly, and wait for the handset to announce each number before dialing the next.
- Some names may not be announced properly.
- Talking phonebook is not available in the following situations.
 - When the base unit is in use (on an outside call or using the answering system)
 - When another user is searching the phonebook, caller list, redial list, memory dial, or call block list

Key tones

Use this procedure to change the volume of the tones that sound when you press keys on the handset and base unit, or to turn them off. The default setting is “Low”. Includes confirmation tones and error tones, etc. This feature can be set for each unit.

1 For handset: [MENU]#165

For base unit (using a handset): [MENU]#*165

2 [↕]: Select the desired setting. → [SAVE] → [OFF]

Accessibility

Message indicator

The message indicator on the handset and base unit can indicate unit status, as explained below.

Indicator	Status
Flashing rapidly	<ul style="list-style-type: none">– Outside call or intercom call is being received or on hold. (page 32, 33, 35)– The handset alarm is sounding. (page 49)
Flashing slowly	<ul style="list-style-type: none">– There are new messages. (page 55)– There are new voicemails. (page 61)– There are missed calls. (page 52)

Setting the message indicator

You can enable and disable the message indicator for each type of status.

- “**Incoming call**” (default: On)
- “**New message**” (default: On)
- “**New VM**” (default: On)
- “**Missed call**” (default: Off)
- “**Alarm**” (default: On) (handset only)

This feature can be set for each unit.

1 For handset: [MENU]#278

For base unit (using a handset): [MENU]#*278

2 [↕]: Select the desired setting and press **[SELECT]**.

- “✓” is displayed next to enabled items.
- To disable an item, select it and press **[SELECT]** again. “✓” disappears.

3 [SAVE] → [OFF]

Note:

- If the message indicator flashes when the handset is not placed on the base unit, the handset consumes battery power faster than usual.

Slow talk

This feature slows down the speed of the other party's voice, which can make it easier to understand phone conversations, answering system messages, etc. Slow talk is available in the following situations.

- When talking on outside calls (including conferences)
- When playing answering system messages
- When screening calls

Handset

To activate this feature or change the current setting, press **[SLOW]** repeatedly.

Base unit

To activate this feature or change the current setting, press **[SLOW TALK]** repeatedly.

- When talking on outside calls or screening calls
Switches between normal speed and slow speed.
- When playing answering system messages
Switches between normal speed, slow speed, and slower speed.

SLOW TALK indicator	Status
Light off	Normal speed
Light	Slow speed
Flashing	Slower speed

Note:

- Slow talk is automatically deactivated when the call ends or when you stop playback.
- This feature is not available for intercom calls or greeting message playback.

Using assistive listening devices

If you use hearing aids that are compatible with a neckloop, you can connect your neckloop to a handset and enjoy hands-free conversations. When talking on the phone, you can speak using

Accessibility

the neckloop's microphone or the handset's microphone depending on the neckloop's features and the handset's settings.

- Hearing aids that are equipped with a telecoil (T-coil)
- Audio neckloops with a 3-pole, 2.5 mm plug
- Audio neckloops with a 3-pole, 3.5 mm plug^{*1}

^{*1} In this case, a 3-pole 3.5 mm to 3-pole 2.5 mm adaptor is required.

To use with a T-coil-equipped hearing aid

- 1 Set your hearing aid to the "T" setting.
 - Refer to your hearing aid's operating instructions for details.
- 2 Hold the handset near your hearing aid when talking.

To use a neckloop

When using a neckloop with the handset, you can speak using the neckloop's microphone or using the handset's microphone.

Important:

- You must set the headset type before use (page 30).

- 1 Connect the neckloop to the headset jack on the side of the handset.
- 2 Use the handset as normal.
 - Refer to your neckloop's operating instructions for details.
 - If your neckloop does not have a microphone, speak into the handset's microphone.
 - You can use volume booster (page 24), speech booster (page 26), tone control (page 23), and other features even when using a neckloop.

Setting the headset type

Set this setting to match the type of device connected. This feature can be set for each unit.

"Headset" (default): Disables the handset's microphone. The connected headset is used for talking and listening.

"Neckloop with Mic": Disables the handset's microphone. The connected neckloop is used for talking and listening.

"Neckloop w/o Mic": Enables the handset's microphone. The connected neckloop is used for listening only.



Accessibility

- 1** **[MENU]** **#** **7** **8** **6**
- 2** **[↕]**: Select the desired setting. → **[SAVE]** → **[OFF]**

Making/Answering Calls

Making calls

- 1 Lift the handset and then dial the phone number.
 - To correct a digit, press **[CLEAR]**.
- 2 Press **[TALK]** to make the call.
 - To make the call using the speakerphone, press **[☎]**.
- 3 When you finish talking, press **[OFF]** or place the handset on the base unit or charger.

Note:

- While talking, you can switch between the receiver and the speakerphone by pressing **[☎]**.
- In step 1, you can store the dialed phone number to the phonebook by pressing **[SAVE]**.

Making a call using the redial list

The last 5 phone numbers dialed are stored in the redial list (each 48 digits max.).

- 1 **[▶]** REDIAL
- 2 **[↕]**: Select the desired entry.
- 3 **[TALK]**

Erasing a number in the redial list

- 1 **[▶]** REDIAL
- 2 **[↕]**: Select the desired entry. → **[ERASE]**
- 3 **[↕]**: “Yes” → **[SELECT]** → **[OFF]**

Adjusting the receiver or speaker volume

Handset

Press **[+]** or **[-]** on the side repeatedly while talking.

- The available settings vary by model and whether volume booster is turned on or off (page 24).
- Pressing the **[BOOST]** key activates the volume booster feature. Use this key with care. To prevent hearing damage, we

recommend that you set this product to the lowest volume setting at which you can hear adequately.

Base unit

Press **[+]** or **[-]** repeatedly while talking.

Pause (for PBX/long distance service users)

A pause is sometimes required when making calls using a PBX or long distance service. When storing a calling card access number and/or PIN in the phonebook, a pause is also needed (page 40).

Example: If you need to dial the line access number “9” when making outside calls with a PBX:

- 1 **[9]** → **[▲]** (Pause)
- 2 Dial the phone number. → **[TALK]**

Note:

- A 3.5 second pause is inserted each time you press **[▲]** (Pause) on the handset.

Answering calls

Using the handset

When a call is being received, the message indicator flashes rapidly if the handset message indicator’s “**Incoming call**” setting is enabled (page 28).

- 1 Lift the handset and then press **[TALK]** or **[☎]** when the unit rings.
- 2 When you finish talking, press **[OFF]** or place the handset on the base unit or charger.

Any key answer: You can answer the call by pressing any dial key (**[1]** to **[9]**, **[*]**, or **[-]**).

Auto talk: You can answer calls simply by lifting the handset (page 47).

Temporary handset ringer off: You can turn the ringer off temporarily by pressing **[&]** (left soft key).

Using the base unit

When a call is being received, the SP-PHONE indicator (📞) flashes rapidly.

Additionally, the message indicator flashes rapidly if the base unit message indicator's "Incoming call" setting is enabled (page 28).

- 1 Press [📞] when the unit rings.
- 2 Speak into the microphone.
- 3 When you finish talking, press [📞].

Note:

- While on a call, you can switch from the base unit to the handset:
 - Press [TALK] on the handset, then press [📞] on the base unit with the call sharing mode on (page 47).
 - If the handset is on the base unit, simply lift it.

Adjusting the ringer volume

Handset

Press [➕] or [➖] on the side repeatedly to select the desired volume.

- To turn the ringer off, press [➖] repeatedly.

Base unit

Press [➕] or [➖] repeatedly to select the desired volume.

- To turn the ringer off, press and hold [➖] until the base unit beeps.

One-touch ringer off

Handset

Press and hold [📞] until the handset beeps to turn the ringer off. While the ringer is turned off, the handset will not ring for calls.

- You can turn the ringer on again by pressing and holding [📞] until the handset beeps.

Base unit

Press [RINGER OFF] to turn the ringer off. While the ringer is turned off, the base unit will not ring for calls.

- The RINGER OFF indicator is lit while the ringer is turned off.
- You can turn the ringer on again by pressing [RINGER OFF].

Useful features during a call

Hold

- 1 Press [MENU] during an outside call.
- 2 [📞]: "Hold" → [SELECT]
- 3 To release hold, press [TALK].
 - Another handset user can take the call by pressing [TALK].
 - The base unit user can take the call by pressing [📞].

Note:

- While an outside call is on hold, the SP-PHONE indicator (📞) on the base unit flashes.
- After holding for 10 minutes, the call is disconnected.

Mute

Handset

- 1 Press [MUTE] during a call.
- 2 To return to the call, press [MUTE].

Note:

- [MUTE] is a soft key visible on the display during a call.

Base unit

- 1 Press [ERASE/MUTE] during a call.
 - The SP-PHONE indicator (📞) flashes.
- 2 To return to the call, press [ERASE/MUTE].

Making/Answering Calls

Flash

Handset / Base unit

[FLASH] on the handset or **[FLASH/CALL WAIT]** on the base unit allows you to use the special features of your host PBX such as transferring an extension call, or accessing optional telephone services.

Note:

- To change the flash time, see page 47.

For call waiting or Call Waiting Caller ID service users

To use call waiting or Call Waiting Caller ID, you must first subscribe with your phone service provider.

This feature allows you to receive calls while you are already talking on the phone. If you receive a call while on the phone, you will hear a call waiting tone.

If you subscribe to both Caller ID and Call Waiting with Caller ID services, the 2nd caller's information is displayed on the unit that is in use after you hear the call waiting tone.

Handset

- 1 Press **[FLASH]** to answer the 2nd call.
- 2 To switch between calls, press **[FLASH]**.

Base unit

- 1 Press **[FLASH/CALL WAIT]** to answer the 2nd call.
- 2 To switch between calls, press **[FLASH/CALL WAIT]**.

Note:

- Please contact your phone service provider for details and availability of this service in your area.

Temporary tone dialing (for rotary/pulse service users)

Press **[*]** before entering access numbers which require tone dialing.

Handset sound enhancer

This feature can improve sound clarity when the handset is used in an area where there may be interference. During an outside call, this feature is turned on automatically when necessary.

- When this feature is turned on, **[SPEAKER]** is displayed.

Handset noise reduction

This feature allows you to hear the voice of the person you are talking to more clearly, by reducing the surrounding noise coming from the other party's telephone.

- 1 Press **[MENU]** while talking.
- 2 **[↕]**: "Noise reduction on" or "Noise reduction off" → **[SELECT]**

Note:

- Depending on the environment where this handset is being used, this feature may not be effective.
- This feature is not available while using the speakerphone.

Call share

You can join an existing outside call.

Handset

To join the conversation, press **[TALK]** when the other unit is on an outside call.

Base unit

To join the conversation, press **[TALK]** when the handset is on an outside call.

Note for handset and base unit:

- A maximum of 3 parties (including 1 outside party) can join a conversation using 2 extensions. **(3-way conference)**
- To prevent other users from joining your conversations with outside callers, turn call sharing mode off (page 47).

Transferring calls, conference calls

Outside calls can be transferred or a conference call*1 with an outside party can be made:

- between 2 handsets
- between a handset and the base unit

*1 A conference call can be established using the handset only.

Handset

- 1 During an outside call, press **[MENU]**.
- 2 **[↕]**: "Intercom" → **[SELECT]**
- 3 **[↕]**: Select the desired unit. → **[SELECT]**
 - If you select "Voice paging", the call will be switched from the ear-receiver mode to the speakerphone mode.
- 4 Wait for the paged party to answer.
 - If the paged party does not answer, press **[BACK]** to return to the outside call.
- 5 **To complete the transfer:**
Press **[OFF]**.
To establish a conference call:
[MENU] → **[↕]**: "Conference" → **[SELECT]**
 - To leave the conference, press **[OFF]**. The other 2 parties can continue the conversation.
 - To put the outside call on hold: **[MENU]** → **[↕]**: "Hold" → **[SELECT]**
To resume the conference: **[MENU]** → **[↕]**: "Conference" → **[SELECT]**
 - To cancel the conference: **[MENU]** → **[↕]**: "Stop conference" → **[SELECT]**
You can continue the conversation with the outside caller.

Base unit

- 1 During an outside call, press **[LOCATOR/INTERCOM]**.
 - All registered handsets ring.
 - The outside call is put on hold.

- 2 Wait for the paged party to answer.
 - If the paged party does not answer, press **[LOCATOR/INTERCOM]** to return to the outside call.
- 3 To complete the transfer, press **[↕]**.
 - The outside call is being routed to the handset.

Intercom

Intercom calls can be made:

- between handsets
- between a handset and the base unit

Note:

- When paging unit(s), the paged unit(s) rings for 1 minute.
- If you receive an outside call while talking on the intercom, the interrupt tone sounds.
 - **Handset:** To finish intercom, press **[OFF]**. To answer the call, press **[TALK]**.
 - **Base unit:** To finish intercom, press **[↕]**. To answer the call, press **[↕]** again.
- To change the ringer volume and ringer tone for intercom calls, see page 44.

Making an intercom call

Handset

- 1 **[MENU]** → **[↕]**: "Intercom" → **[SELECT]**
 - 2 **[↕]**: Select the desired unit or "Voice paging". → **[SELECT]**
 - If you select "Voice paging", speak into the microphone after the beep. Your voice will be heard from the speakers of the base unit and all handsets. Voice paging ends when you press **[OFF]** or when a handset user or base unit user answers your voice page.
 - 3 When you finish talking, press **[OFF]**.
- Note:**
- You can also use the **[INTERCOM]** soft key, if displayed, to make intercom calls.

Making/Answering Calls

- You cannot use voice paging if other units are in use.
- Voice paging is not available when a range extender (KX-TGA405) is registered to the base unit.

Base unit

- 1 Press [**LOCATOR/INTERCOM**].
 - All registered handsets ring.
- 2 When you finish talking, press [**⏏**].

Answering an intercom call

Handset

- 1 Press [**TALK**] to answer the page.
- 2 When you finish talking, press [**OFF**].

Base unit

- 1 Press [**⏏**] to answer the page.
- 2 When you finish talking, press [**⏏**].

Call block

In the following situations, you can disconnect the current call and add the caller's phone number to the call block list.

- When an outside call is being received
- When an outside caller's message is being recorded
- When you are talking on an outside call

1 When an outside call is being received or

When an outside caller's message is being recorded

Press **[BLOCK]** on the handset.

When you are talking on an outside call
[MENU] → **[↕]**: "Blocked call" → **[SELECT]**

2 Confirm the call block number and press **[YES]**.

- The phone number is stored in the call block list, "Caller blocked" is displayed, and the call is disconnected.

Note:

- If the call has no phone number, the call is blocked but it is not stored in the call block list.
- The call block feature is not available for intercom calls or calls received by call waiting.
- Blocked calls are logged in the caller list.

Storing unwanted callers

The unit can block calls by storing the desired items in the call block list beforehand (Caller ID subscribers only).

- "Block a single number": The unit blocks calls from specific phone numbers stored in the call block list.
- "Block range of numbers": The unit blocks calls that begin with a number stored in the call block list, such as a toll-free phone number prefix or certain area codes.
- "Block unknown CID": The unit blocks calls that have no phone number.

Single phone numbers and ranges of numbers can be stored in the call block list up to 250 items in total.

Blocking unwanted callers:

When a call is received, the unit rings once^{*1} while caller information is being received.

If the caller's phone number matches an entry in the call block list, the unit emits no sound to the caller, and disconnects the call.

- *1 If you do not want this one ring to sound, select "No" in "Turning the first ring on and off" (page 38).

Storing a single phone number

Important:

- We recommend storing 10 digits (including the area code). If only 7 digits are stored, all numbers that have the same last 7 digits will be blocked.

Adding call blocked numbers from the caller list

- 1 **[▼]** CID
- 2 **[↕]**: Select the desired entry to be blocked. → **[MENU]**
 - To edit the number: **[↕]**: "Edit" → **[SELECT]**
 Press **[EDIT]** repeatedly until the phone number is shown in the 10-digit format. → **[SAVE]** → **[↕]**: "Call block" → **[SELECT]** → Go to step 4.
- 3 **[↕]**: "Save call block" → **[SELECT]**
- 4 **[↕]**: "Yes" → **[SELECT]**
- 5 Edit the phone number if necessary (24 digits max.). → **[SAVE]** → **[OFF]**

Adding call blocked numbers manually

- 1 **[MENU]** **[#]** **[2]** **[1]** **[7]**
- 2 **[↕]**: "Block a single number" → **[SELECT]**
- 3 **[MENU]** → **[↕]**: "Add" → **[SELECT]**

Call Block

- 4 Enter the phone number (24 digits max.).
→ [SAVE] → [OFF]

Storing a range of number

- 1 [MENU]#217
- 2 [↕]: "Block range of numbers" →
[SELECT]
- 3 [MENU] → [↕]: "Add" → [SELECT]
- 4 Enter the desired number (2-8 digits). →
[SAVE] → [OFF]

Blocking incoming calls that have no phone number

You can block calls when no phone number is provided, such as private callers or out of area calls.

- 1 [MENU]#217
- 2 [↕]: "Block unknown CID" →
[SELECT]
- 3 [↕]: Select the desired setting. →
[SAVE] → [OFF]

Turning the first ring on and off

You can choose whether the first ring sounds when a call is received.

"Yes" (default): The first ring for all calls will be heard, including calls from blocked phone numbers.

"No": The first ring is muted for all calls. If this setting is selected, the unit will never ring for calls from blocked phone numbers.

- 1 [MENU]#217
- 2 [↕]: "One ring for blocked call"
→ [SELECT]
- 3 [↕]: Select the desired setting. →
[SAVE] → [OFF]

Viewing/editing/erasing call block numbers

- 1 [MENU]#217

- 2 [↕]: "Block a single number" or
"Block range of numbers" →
[SELECT]
- 3 [↕]: Select the desired entry.
• After viewing, press [OFF] to exit.
- 4 To edit a number:
[EDIT] → Edit the number. → [SAVE]
→ [OFF]
To erase a number:
[ERASE] → [↕]: "Yes" → [SELECT]
→ [OFF]

Note:

- When editing, press the desired dial key to add digits and press [CLEAR] to erase digits.

Erasing all call block numbers

- 1 [MENU]#217
- 2 [↕]: "Block a single number" or
"Block range of numbers" →
[SELECT]
- 3 [MENU] → [↕]: "Erase all" →
[SELECT]
- 4 [↕]: "Yes" → [SELECT]
- 5 [↕]: "Yes" → [SELECT] → [OFF]

Phonebook

You can add 100 names (16 characters max.) and phone numbers (24 digits max.) to the phonebook, and assign each phonebook entry to the desired group (page 39).

Important:

- All entries can be shared by any registered handset.

Adding phonebook entries

- 1 [◀] □□ → [MENU]
- 2 [↕]: "Add new entry" → [SELECT]
- 3 Enter the party's name. → [OK]
- 4 Enter the party's phone number. → [OK]
- 5 [↕]: Select the desired group. → [SELECT] 2 times → [OFF]

Note:

- In step 3, you can switch the language for entering characters.
[#] → [↕]: Select the desired language. → [OK]

Entering characters

Press the dial key that corresponds to the desired character. Press repeatedly to scroll through the available characters. The following operations are also available.

Key	Operation
[X]	Switch between the uppercase and lowercase (A ↔ a)
[◀] [▶]	Move the cursor
[CLEAR]	Erase the character or number <ul style="list-style-type: none"> • To erase all, press and hold it.

- To enter another character that is located on the same dial key, first press [▶] to move the cursor to the next space.
- If you do not press any dial key within 2 seconds after entering a character, the character is fixed and the cursor moves to the next space.

Storing a redial list number to the phonebook

Phone numbers of up to 24 digits can be stored in the phonebook.

- 1 [▶] REDIAL
- 2 [↕]: Select the desired entry. → [SAVE]
- 3 To store the name, continue from step 3, "Editing entries", page 40.

Note:

- The name stored in the phonebook will be reflected in the redial list after you make a call using that phonebook entry.

Storing caller information to the phonebook

- 1 [▼] CID
- 2 [↕]: Select the desired entry. → [MENU]
 - To edit the number: [↕]: "Edit" → [SELECT]
Press [EDIT] repeatedly until the phone number is shown in the desired format. → [SAVE] → [↕]: "Phonebook" → [SELECT] → Go to step 4.
- 3 [↕]: "Save phonebook" → [SELECT]
- 4 Continue from step 3, "Editing entries", page 40.

Groups

Groups can help you find entries in the phonebook quickly and easily. You can change the names of groups assigned for phonebook entries ("Friends", "Family", etc.). By assigning different ringer tones for different groups of callers, you can identify who is calling (ringer ID), if you have subscribed to Caller ID service.

Changing group names/setting ringer ID

The default group name is "Group 1" to "Group 9".

- 1 [◀] □□ → [MENU]
- 2 [↕]: "Group" → [SELECT]

Phonebook

- 3 **[↕]**: Select the desired group. → **[SELECT]**
- 4 **To change group names**
[↕]: "Group name" → **[SELECT]** → Edit the name (10 characters max.).
To set group ringer tone
[↕]: Select the current setting of the group ringer tone. → **[SELECT]** → **[↕]**: Select the desired ringer tone.
 - If you select one of the ringers ("Ringer 1" to "Ringer 5"), select the desired frequency ("Frequency 1" to "Frequency 6").
- 5 **[SAVE]** → **[OFF]**

Finding and calling from a phonebook entry

- 1 **[←] □□**
- 2 **To scroll through all entries**
[↕]: Select the desired entry.
To search by first character
 - ① Press the dial key (**[0]** to **[9]**, or **[#]**) which contains the character you are searching for.
 - ② **[↕]**: Scroll through the phonebook if necessary.**To search by group**
 - ① **[GROUP]**
 - ② **[↕]**: Select the desired group. → **[SELECT]**
 - ③ **[↕]**: Scroll through the phonebook if necessary.
- 3 **[TALK]**

Editing entries

- 1 Find the desired entry (page 40).
- 2 **[MENU]** → **[↕]**: "Edit" → **[SELECT]**
- 3 Edit the name if necessary. → **[OK]**
- 4 Edit the phone number if necessary. → **[OK]**
- 5 **[↕]**: Select the desired group (page 39). → **[SELECT]** 2 times → **[OFF]**

Erasing entries

Erasing an entry

- 1 Find the desired entry (page 40).
- 2 **[MENU]** → **[↕]**: "Erase" → **[SELECT]**
- 3 **[↕]**: "Yes" → **[SELECT]** → **[OFF]**

Erasing all entries

- 1 **[←] □□** → **[MENU]**
- 2 **[↕]**: "Erase all" → **[SELECT]**
- 3 **[↕]**: "Yes" → **[SELECT]**
- 4 **[↕]**: "Yes" → **[SELECT]** → **[OFF]**

Chain dial

This feature allows you to dial phone numbers in the phonebook while you are on a call. This feature can be used, for example, to dial a calling card access number or bank account PIN that you have stored in the phonebook, without having to dial manually.

- 1 During an outside call, press **[←] □□**.
- 2 **[↕]**: Select the desired entry.
- 3 Press **[CALL]** to dial the number.

Note:

- When storing a calling card access number and your PIN in the phonebook as one phonebook entry, press **[▲]** (Pause) to add pauses after the number and PIN as necessary (page 32).
- If you have rotary/pulse service, you need to press **[☒]** before pressing **[←] □□** in step 1 to change the dialing mode temporarily to tone. When adding entries to the phonebook, we recommend adding **[☒]** to the beginning of phone numbers you wish to chain dial (page 39).

Memory dial

For easy dialing, you can assign a phone number to each dial key ([1] to [9]) on the handset. All memory dial entries can be used by any handset.

Phone numbers assigned to dial keys [1] to [9] on the handset are also assigned to the base unit's memory dial keys ([M1], [M2], and [M3]).

Adding phone numbers to memory dial keys

■ By entering phone numbers:

- 1 Press and hold the desired memory dial key ([1] to [9]). → [ADD]
- 2 [↕]: "Manual" → [SELECT]
- 3 Enter the party's name (16 characters max.). → [OK]
- 4 Enter the party's phone number (24 digits max.). → [OK] → [SELECT] → [OFF]

■ From the phonebook:

- 1 Press and hold the desired memory dial key ([1] to [9]). → [ADD]
- 2 [↕]: "Phonebook" → [SELECT]
- 3 [↕]: Select the desired entry. → [SAVE] → [OFF]

Note:

- If you edit a phonebook entry which is assigned to a memory dial key, the edited entry does not transfer to the memory dial key.

Editing an entry

- 1 Press and hold the desired memory dial key ([1] to [9]). → [MENU]
- 2 [↕]: "Edit" → [SELECT]
- 3 Edit the name if necessary. → [OK]
- 4 Edit the phone number if necessary. → [OK] → [SELECT] → [OFF]

Erasing an entry

- 1 Press and hold the desired memory dial key ([1] to [9]). → [MENU]
- 2 [↕]: "Erase" → [SELECT]
- 3 [↕]: "Yes" → [SELECT] → [OFF]

Viewing an entry/Making a call using the handset

- 1 Press and hold the desired memory dial key ([1] to [9]).
- 2 To make a call, press [TALK].

Confirming an entry/ Making a call using the base unit

If the talking keypad and phonebook feature is set to "High" or "Low", you can confirm the entry that is assigned to a memory dial key before calling that entry (page 27). Set the talking keypad and phonebook to "High" or "Low" first (page 27).

To confirm an entry, press the desired memory dial key ([M1] to [M3]).

- The unit announces the name or phone number of the entry.

To make a call, press and hold the desired memory dial key ([M1] to [M3]).

- The speakerphone turns on.

Programming

Menu list

To access the features, there are 2 methods.

■ Scrolling through the display menus

- 1 [MENU]
- 2 Press [▼] or [▲] to select the desired main menu. → [SELECT]
- 3 Press [▼] or [▲] to select the desired item from the next sub-menus. → [SELECT]
- 4 Press [▼] or [▲] to select the desired setting. → [SAVE]

■ Using the direct command code

- 1 [MENU] → Enter the desired code.
Example: Press [MENU][#][1][0][1].
- 2 Select the desired setting. → [SAVE]

Note:

- To exit the operation, press [OFF].
- In the following table, < > indicates the default settings.
- In the following table,  indicates the reference page number.
- Display menu order and sub-menu may vary depending on your model.

Display menu tree and direct command code table

Main menu:  "Phonebook"

Operation	Code	
Viewing the phonebook entry.	#280	40

Main menu:  "Caller list"

Operation	Code	
Viewing the caller list.	#213	52

Main menu:  "Answering device"

Sub-menu 1	Sub-menu 2	Settings	Code	
Play new message	–	–	#323	55
Play all message	–	–	#324	55
Erase all message*1	–	–	#325	56
Greeting	Record greeting*1	–	#302	54
	Check greeting	–	#303	55
	Pre-recorded*1 (Reset to pre-recorded greeting)	–	#304	55

Programming

Sub-menu 1	Sub-menu 2	Settings	Code	
New message alert ^{*1}	Outgoing call – On/Off	On <Off>	#338	56
	Outgoing call – Notification to	–		
	Outgoing call – Remote code	Activate <Inactivate>		
	Base unit beep	On <Off>	#339	56
Settings	Ring count ^{*1}	Toll saver 2-7 rings <4 rings>	#211	59
	Recording time ^{*1}	<3 min> 1 min Greeting only ^{*2}	#305	59
	Remote code ^{*1}	<111>	#306	58
	Screen call – Handset	<On> Off	#310	59
	Screen call – Base unit ^{*1}	<On> Off	#*310	
Answer on ^{*1}	–	–	#327	54
Answer off ^{*1}	–	–	#328	54

Main menu:  “Voicemail access”

Operation	Code	
Listening to voicemail messages.	#330	61

Main menu:  “Intercom”

Operation	Code	
Paging the desired unit.	#274	35

Main menu:  “Set date & time”

Sub-menu 1	Sub-menu 2	Settings	Code	
Date and time ^{*1}	–	–	#101	21
Memo alarm	Alarm1-3	<Off>, Once, Daily, Weekly	#720	49
Time adjustment ^{*1, *3}	–	<Caller ID auto> Manual	#226	–

Main menu:  “Memory dial”

Operation	Code	
Viewing the memory dial entry.	#261	41

For assistance, please visit <http://shop.panasonic.com/support>

43

Programming

Main menu:  "Settings"

Sub-menu 1	Sub-menu 2	Settings	Code	
Ring adjustments	Ringer volume (Incoming) - Handset	Off-6 <6>	#160	-
	Ringer volume (Incoming) - Base unit ^{*1}	Off-10 <1>	#*160	-
	Intercom ringer volume - Handset	1-6 <6>	#175	-
	Intercom ringer volume - Base unit ^{*1}	1-10 <1>	#*175	-
	Ringer tone (Incoming) - Handset ^{*4, *5, *6}	<Ringer 1>	#161	-
	Ringer tone (Incoming) - Base unit ^{*1, *4, *6}	<Ringer 1>	#*161	-
	Intercom ringer tone - Handset ^{*4, *5, *6}	<Ringer 3>	#163	-
	Intercom ringer tone - Base unit ^{*1, *4, *6}	<Ringer 3>	#*163	-
	Silent mode - Handset	On/Off - On - <Off>	#238	50
		Start/End - <11:00 PM/ 06:00 AM>	#237	50
		Select group Group 1-9	#241	50
	Silent mode - Base unit ^{*1}	On/Off - On - <Off>	#*238	50
		Start/End - <11:00 PM/ 06:00 AM>	#*237	50
		Select group Group 1-9	#*241	50

Programming

Sub-menu 1	Sub-menu 2	Settings	Code	
Audio settings	Talking dial - Handset	<Off> Low High	#750	26
	Talking dial - Base unit ^{*1}	<Off> Low High	#*750	
	Talking caller ID - Handset	<On> Off	#162	52
	Talking caller ID - Base unit ^{*1}	On <Off>	#*162	
	Auto boost	On <Off>	#782	25
	Boost speech	On <Off>	#783	26
	Key tone - Handset	Off <Low> High	#165	27
	Key tone - Base unit ^{*1}	Off <Low> High	#*165	
Set date & time	Date and time ^{*1}	-	#101	21
	Memo alarm - Alarm1-3	<Off> Once Daily Weekly	#720	49
	Time adjustment ^{*1,*3}	<Caller ID auto> Manual	#226	-

Programming

Sub-menu 1	Sub-menu 2	Settings	Code		
Key detector setting^{*7} – 1: Add new device (for Detector1) ^{*8} – 2: Add new device (for Detector2) – 3: Add new device (for Detector3) – 4: Add new device (for Detector4)	Change name ^{*1}	Detector1	#6561	–	
		Detector2 ^{*9}	#6562 ^{*9}		
		Detector3 ^{*9}	#6563 ^{*9}		
		Detector4 ^{*9}	#6564 ^{*9}		
	Registration	–		#6571	–
				#6572 ^{*9}	
				#6573 ^{*9}	
	Deregistration	–		#6574 ^{*9}	
				#6581	–
				#6582 ^{*9}	
				#6583 ^{*9}	
			#6584 ^{*9}		
Call block ^{*1}	Block a single number	–	#217	37	
	Block range of numbers	–		38	
	Block unknown CID (CID: Caller ID)	Block <Unblock>	#240	38	
	One ring for blocked call	<Yes> No	#173	38	
Memory dial	–	–	#261	41	
Record greeting ^{*1}	–	–	#302	54	
Voicemail	Save VM access# ^{*1} (VM: Voicemail)	–	#331	60	
	VM tone detect ^{*1}	<On> Off	#332	60	
LCD contrast (Display contrast)	–	Level 1–4 <2>	#145	–	
Handset name	–	–	#104	50	
Display name	–	On <Off>	#105	50	

Programming

Sub-menu 1	Sub-menu 2	Settings	Code	
Message indicator	Handset – Incoming call	<On> Off	#278	28
	Handset – New message	<On> Off		
	Handset – New VM	<On> Off		
	Handset – Missed call	On <Off>		
	Handset – Alarm	<On> Off		
	Base unit ^{*1} – Incoming call	<On> Off	#*278	
	Base unit ^{*1} – New message	<On> Off		
	Base unit ^{*1} – New VM	<On> Off		
	Base unit ^{*1} – Missed call	On <Off>		
	Caller ID edit (Caller ID number auto edit)	–	<On> Off	#214
Auto talk ^{*10}	–	On <Off>	#200	32
Set tel line	Set dial mode ^{*1}	<Tone> Pulse	#120	22
	Set flash time ^{*1, *11}	80 ms 90 ms 100 ms 110 ms 160 ms 200 ms 250 ms 300 ms 400 ms 600 ms <700 ms> 900 ms	#121	34
	Set line mode ^{*1, *12}	A 	#122	–
Call sharing ^{*1}	–	<On> Off	#194	34
Registration	Register handset	–	#130	50
	Deregistration ^{*2}	–	#131	51

For assistance, please visit <http://shop.panasonic.com/support>

47

Programming

Sub-menu 1	Sub-menu 2	Settings	Code	
Headset type	–	<Headset> Neckloop with Mic Neckloop w/o Mic	#786	30
Change language	Display	<English> Español	#110	21
	Announcement*1	<English> Español	#112	21

Main menu:  “Customer support”

Operation	Code	
Displaying customer support Web address.	#680	–

Main menu:  “Key detector”*7

Sub-menu 1	Sub-menu 2	Settings	Code	
Search	–	–	#655	–
Battery check	–	–		

- *1 If you program these settings using one of the units, you do not need to program the same item using another unit.
- *2 This menu is not displayed when scrolling through the display menus. It is only available in direct command code.
- *3 This feature allows the unit to automatically adjust the date and time each time caller information including date and time is received.
To turn this feature on, select “Caller ID auto”. To turn this feature off, select “Manual”. (Caller ID subscribers only)
To use this feature, set the date and time first (page 21).
- *4 If you subscribe to a distinctive ring service (such as IDENTA-RING), select one of the ringers (“Ringer 1” to “Ringer 5”).
- *5 The preset ringers in this product (“Ringer 6” - “Ringer 15”) are used with permission of © 2004 - 2013 Copyrights Vision Inc.
- *6 If you select one of the ringers (“Ringer 1” to “Ringer 5”), select the desired frequency (“Frequency 1” to “Frequency 6”).
- *7 This setting is available when you have the key detector (KX-TGA20). Read the installation manual for more information on the key detector.
- *8 For models with supplied key detectors, the display shows “1: Detector1”.
- *9 If you register 2 or more key detectors.
- *10 If you subscribe to a Caller ID service and want to view the caller’s information after lifting up the handset to answer a call, turn off this feature.
- *11 The flash time depends on your telephone exchange or host PBX. Contact your PBX supplier if necessary. The setting should stay at “700 ms” unless pressing [FLASH] fails to pick up the waiting call.

- *12 Generally, the line mode setting should not be changed. This setting automatically maintains receiver volume at the proper level depending on the current telephone line condition. Set the line mode to “**A**” if telephone line condition is not good.

Alarm

An alarm sounds at the set time for 1 minute and repeats 5 times at 5 minute intervals (snooze function). You can also configure the alarm to display a text memo. You can set 3 separate alarms for each handset. Each alarm can be set to sound once, daily, or weekly. When an alarm sounds, the message indicator flashes rapidly if the handset message indicator’s “**Alarm**” setting is enabled (page 28).

Important:

- Make sure the unit’s date and time setting is correct (page 21).

- 1 **[MENU]** **[#]** **[7]** **[2]** **[0]**
- 2 **[↓]**: Select the desired alarm. → **[SELECT]**
- 3 **[↓]**: Select the desired alarm option. → **[SELECT]**

“ Off ”	Turns alarm off. Go to step 10.
“ Once ”	An alarm sounds once at the set time.
“ Daily ”	An alarm sounds daily at the set time. Go to step 5.
“ Weekly ”	Alarm sounds weekly at the set time(s).

- 4 Proceed with the operation according to your selection in step 3.
 - **Once**:
Enter the desired month and date. → **[OK]**
 - **Weekly**:
[↓]: Select the desired day of the week and press **[SELECT]**. → **[OK]**
- 5 Set the desired time.

- 6 **[☒]**: Select “**AM**” or “**PM**”. → **[OK]**
- 7 Enter a text memo (10 characters max.). → **[OK]**
- 8 **[↑]**: Select the desired alarm tone. → **[SELECT]**
 - If you select one of the ringers (“**Ringer 1**” to “**Ringer 5**”), select the desired frequency (“**Frequency 1**” to “**Frequency 6**”).
 - We recommend selecting a different ringer tone from the one used for outside calls and intercom calls.
- 9 **[↓]**: Select the desired snooze setting. → **[SAVE]**
- 10 **[SELECT]** → **[OFF]**

Note:

- Press **[STOP]** to stop the alarm completely.
- When the handset is in use, the alarm will not sound until the handset is in standby mode.
- Press any dial key or **[SNOOZE]** to stop the sound but keep the snooze function activated.
- If you want to make an outside call when the snooze function is activated, please stop the snooze function before making the call.

Silent mode

Silent mode allows you to select a period of time during which the handset and/or base unit will not ring for outside calls. This feature is useful for time periods when you do not want to be disturbed, for example, while sleeping. Silent mode can be set for each unit. Using the phonebook’s group feature (page 39), you can also select groups of callers whose calls override silent mode and ring the unit (Caller ID subscribers only).

Programming

Important:

- Make sure the unit's date and time setting is correct (page 21).
- If you have set the alarm, the alarm sounds even if the silent mode is turned on.

Turning silent mode on/off

- 1 **For handset:** [MENU]#238
For base unit (using a handset):
[MENU]#*238
- 2 [↕]: Select the desired setting. → [SAVE]
 - If you select "OFF", press [OFF] to exit.
- 3 Enter the desired hour and minute you wish to start this feature.
- 4 [X]: Select "AM" or "PM". → [OK]
- 5 Enter the desired hour and minute you wish to end this feature.
- 6 [X]: Select "AM" or "PM".
- 7 [SAVE] → [OFF]

Changing the start and end time

- 1 **For handset:** [MENU]#237
For base unit (using a handset):
[MENU]#*237
- 2 Continue from step 3, "Turning silent mode on/off", page 50.

Selecting groups to bypass silent mode

- 1 **For handset:** [MENU]#241
For base unit (using a handset):
[MENU]#*241
- 2 [↕]: Select the desired groups. → [SELECT]
 - "✓" is displayed next to the selected group numbers.
 - To cancel the selected group:
[↕]: Select the group. → Press [SELECT] again. "✓" disappears.
- 3 [SAVE] → [OFF]

Other programming

Changing the handset name

The default handset name is "Handset 1" to "Handset 6". You can customize the name of each handset ("Bob", "Kitchen", etc.). This is useful when you make intercom calls between handsets. To display the handset name in standby mode, turn on the handset name display feature (page 50).

- 1 [MENU]#104
- 2 Enter the desired name (10 characters max.). → [SAVE] → [OFF]

Displaying the handset name

You can select whether or not the handset name is displayed in standby mode. The default setting is "OFF".

- 1 [MENU]#105
- 2 [↕]: Select the desired setting. → [SAVE] → [OFF]

Registering a unit

Operating additional units

Additional handsets

Up to 6 handsets can be registered to the base unit.

Important:

- See page 5 for information on the available model.

Registering a handset to the base unit

The supplied handset and base unit are pre-registered. If for some reason the handset is not registered to the base unit, re-register the handset.

Programming

- 1 Handset:**
[MENU] [#] 1 3 0
- 2 Base unit:**
Press and hold [LOCATOR/INTERCOM] for about 5 seconds.
 - If all registered handsets start ringing, press [LOCATOR/INTERCOM] again to stop, then repeat this step.
- 3 Handset:**
Press [OK], then wait until a long beep sounds.

Deregistering a handset

A handset can cancel its own registration to the base unit, or other handsets registered to the same base unit. This allows the handset to end its wireless connection with the system.

- 1 [MENU] [#] 1 3 1**
 - All handsets registered to the base unit are displayed.
- 2 [↕]:** Select the handset you want to cancel. → [SELECT]
- 3 [↕]:** "yes" → [SELECT] → [OFF]

Using Caller ID service

Important:

- This unit is Caller ID compatible. To use Caller ID features, you must subscribe to a Caller ID service. Contact your phone service provider for details.

Caller ID features

When an outside call is being received, the caller information is displayed.

Caller information for the last 50 callers is logged in the caller list from the most recent call to the oldest.

- If the unit cannot receive caller information, the following is displayed:
 - “**Out of area**”: The caller dials from an area which does not provide a Caller ID service.
 - “**Private caller**”: The caller requests not to send caller information.
 - “**Long distance**”: The caller makes a long distance call.
- If the unit is connected to a PBX system, caller information may not be properly received. Contact your PBX supplier.

Missed calls

If a call is not answered, the unit treats it as a missed call. The display shows “**Missed call**”.

When there is a missed call, the message indicator flashes slowly if the handset or base unit message indicator’s “**Missed call**” setting is enabled (page 28).

Note:

- Even when there are unviewed missed calls, “**Missed call**” disappears from the standby display if the following operation is performed by one of the units:
 - A handset is replaced on the base unit or charger.
 - Pressing [**OFF**] on a handset.

Phonebook name display

When caller information is received and it matches a phone number stored in the

phonebook, the stored name in the phonebook is displayed and logged in the caller list.

Talking Caller ID

Handset / Base unit

This feature lets you know who is calling without looking at the display.

To use this feature, you must:

- subscribe to a Caller ID service of your phone service provider.
- turn this feature on (page 45).

When caller information is received, the handsets and/or base unit announce the caller’s name or phone number received from your phone service provider following every ring.

- Name pronunciation may vary. This feature may not pronounce all names correctly.
- Caller ID service has a limit of how many characters can be displayed. If the caller’s name is too long, the unit may not be able to display or announce the entire name.

Phonebook name announcement

When caller information is received and it matches a phone number stored in the phonebook, the stored name in the phonebook is announced.

Caller list

Important:

- Make sure the unit’s date and time setting is correct (page 21).

Viewing the caller list and calling back

- 1 [**▼**] CID
- 2 Press [**▼**] to search from the most recent call, or [**▲**] to search from the oldest call.
- 3 To call back, press [**TALK**].
To exit, press [**OFF**].

Note:

- If the entry has already been viewed or answered, “✓” is displayed.

Editing a caller’s phone number

You can edit a phone number in the caller list by removing its area code and/or the long distance code “1”.

- 1 [▼] CID
- 2 [↕]: Select the desired entry. → [MENU]
- 3 [↕]: “Edit” → [SELECT]
- 4 Press [EDIT] repeatedly until the phone number is shown in the desired format.
- 5 [TALK]

Caller ID number auto edit feature

Once you call back an edited number, the unit which was used to call back remembers the area code and format of the edited number. The next time someone calls from the same area code, caller information is customized by the unit as follows:

- When the call is being received, the Caller ID number is displayed in the same format as the edited number.
- After the call has ended, the caller’s phone number is displayed in the same format as the edited number, when reviewed from the caller list.

For example, you can use this feature to set the unit to ignore the area code of callers in your area, so that you can call these local numbers using caller information without dialing the area code.

To activate this feature, you must edit an entry in the caller list, then call that number. After that, phone numbers from that caller’s area code are edited automatically.

This feature can be set for each unit (page 47). The default setting is “on”.

Note:

- Phone numbers from the 4 most recently edited area codes are automatically edited.

Erasing selected caller information

- 1 [▼] CID
- 2 [↕]: Select the desired entry.
- 3 [ERASE] → [↕]: “Yes” → [SELECT] → [OFF]

Erasing all caller information

- 1 [▼] CID
- 2 [ERASE] → [↕]: “Yes” → [SELECT] → [OFF]

Answering System

Answering system

The answering system can answer and record calls for you when you are unavailable to answer the phone.

You can also set the unit to play a greeting message but not to record caller messages by selecting “**Greeting only**” as the recording time setting (page 59).

Important:

- Make sure the unit’s date and time setting is correct (page 21).

Memory capacity (including your greeting message)

The total recording capacity is about 17 minutes. A maximum of 64 messages can be recorded.

Note:

- When message memory becomes full:
 - “**Messages full**” is shown on the handset display.
 - The message counter and the ANSWER ON/OFF indicator (ON) on the base unit flashes if the answering system is turned on.
 - If you use the pre-recorded greeting message, the unit automatically switches to another pre-recorded greeting message asking callers to call again later.
 - If you recorded your own greeting message, the same message is still announced to callers even though their messages are not recorded.

Turning the answering system on/off

Base unit

Press **[ANSWER ON/OFF]** to turn on/off the answering system.

Handset

- 1 **To turn on:**
[MENU][#][3][2][7]
To turn off:
[MENU][#][3][2][8]
- 2 **[OFF]**

Note for base unit and handset:

- When the answering system is turned on,
 - the ANSWER ON/OFF indicator (ON) on the base unit lights up.
 - the message counter on the base unit displays the total number of messages (old and new).

Greeting message

When the unit answers a call, a greeting message is played to callers.

You can use either:

- your own greeting message
- a pre-recorded greeting message

Recording your greeting message

- 1 **[MENU][#][3][0][2]**
- 2 **[↓]: “Yes” → [SELECT]**
- 3 After a beep sounds, hold the handset about 20 cm (8 inches) away and speak clearly into the microphone (2 minutes max.).
- 4 Press **[STOP]** to stop recording. → **[OFF]**

Using a pre-recorded greeting message

The unit provides 2 pre-recorded greeting messages:

- If you reset to pre-recorded greeting or do not record your own greeting message, the unit plays a pre-recorded greeting asking callers to leave a message.
- If the message recording time (page 59) is set to “**Greeting only**”, callers’ messages are not recorded and the unit

plays a different pre-recorded greeting message asking callers to call again.

Resetting to a pre-recorded greeting message

Use this procedure to erase your greeting message and use a pre-recorded one.

- 1 [MENU] [#] 3 0 4
- 2 [YES] → [OFF]

Playing back the greeting message

- 1 [MENU] [#] 3 0 3
- 2 To exit, press [OFF].

Listening to messages

Important:

- When using the base unit or handset to listen to messages, the noise reduction feature (page 34) is activated automatically in spite of the setting ([NR] is not displayed).

Using the base unit

When new messages have been recorded:

- The new message/play indicator (▶) on the base unit flashes.
- The message indicator on the base unit flashes slowly if the base unit message indicator's "New message" setting is enabled (page 28).

Press [▶■] (PLAY).

- During playback, the new message/play indicator (▶) on the base unit lights.
- If new messages have been recorded, the base unit plays back new messages.
- If there are no new messages, the base unit plays back all messages.

Operating the answering system during playback

Key	Operation
[+] or [-]	Adjust the speaker volume
[◀◀]	Repeat message*1
[▶▶]	Skip message
[▶■] (STOP)	Stop playback
[ERASE/MUTE]	Erase currently playing message

*1 If pressed within the first 5 seconds of a message, the previous message is played.

Erasing all messages

Press [ERASE/MUTE] 2 times while the unit is not in use.

Using the handset

When new messages have been recorded:

- "New message" is displayed.
- The message indicator on the handset flashes slowly if the handset message indicator's "New message" setting is enabled (page 28).

- 1 **To listen to new messages:**
[MENU] [#] 3 2 3
To listen to all messages:
[MENU] [#] 3 2 4
- 2 When finished, press [OFF].

Note:

- To switch to the receiver, press [📞].
- You can also use the [PLAY] soft key, if displayed, to play new messages.

Operating the answering system

[MENU] → [⬆]: "Answering device" → [SELECT]

Key	Operation
[+] or [-]	Adjust the receiver/speaker volume (during playback)

Answering System

Key	Operation
1 or [◀]	Repeat message (during playback)*1
2 or [▶]	Skip message (during playback)
3	Enter the "Settings" menu
4	Play new messages
5	Play all messages
6	Play greeting message
7/6	Record greeting message
8	Turn answering system on
[PAUSE]	Pause message*2
9 or [STOP]	Stop recording Stop playback
0	Turn answering system off
*4	Erase currently playing message
*5	Erase all messages
*6	Reset to a pre-recorded greeting message

*1 If pressed within the first 5 seconds of a message, the previous message is played.

*2 To resume playback:
[↕]: "Playback" → [SELECT]

*3 You can also erase as follows:
[PAUSE] → [↕]: "Erase" → [SELECT] → [↕]: "Yes" → [SELECT]

Calling back (Caller ID subscribers only)

- 1 Press [PAUSE] during playback.
- 2 [↕]: "Call back" → [SELECT]

Editing the number before calling back

- 1 Press [PAUSE] during playback.
- 2 [↕]: "Edit & Call" → [SELECT]
- 3 Press [EDIT] repeatedly until the phone number is shown in the desired format (page 53). → [TALK]

Erasing all messages

- 1 [MENU]#3/2/5
- 2 [↕]: "Yes" → [SELECT] → [OFF]

Advanced new message alerting features

Audible message alert

This feature allows the base unit to beep to inform you of a new message arrival when new messages are recorded. The base unit beeps 2 times every minute until you listen to the messages, if the "Base unit beep" setting is turned on. The default setting is "OFF".

- 1 [MENU]#3/3/9
- 2 [↕]: Select the desired setting. → [SAVE] → [OFF]

New message alert by a call

This feature allows you to receive a notification by phone when new messages are recorded. The base unit calls a phone number you specify. You can then operate the answering system remotely to listen to the new message.

To use this feature, you must:

- store a phone number to which the unit makes the call to.
- turn on the new message alert setting.

After you answer the new message alert call, you can listen to messages from that call (page 57).

Important:

- A new message alert is stopped 1 minute after the unit starts to call. The unit will not retry the call even if the call is not answered.

Storing a phone number to which the unit makes an alert call

■ From the phonebook:

- 1 [MENU]#338
- 2 [↕]: "Notification to" → [SELECT] → [ADD]
- 3 [↕]: "Phonebook" → [SELECT]
- 4 [↕]: Select the desired phonebook entry. → [SAVE] → [OFF]

■ By entering a phone number:

- 1 [MENU]#338
- 2 [↕]: "Notification to" → [SELECT] → [ADD]
- 3 [↕]: "Manual" → [SELECT]
- 4 Enter the desired name (16 characters max.). → [OK]
- 5 Enter the desired number (24 digits max.). → [OK] → [SELECT] → [OFF]

Turning on/off the new message alert setting

- 1 [MENU]#338
- 2 [↕]: "On/Off" → [SELECT]
- 3 [↕]: Select the desired setting. → [SAVE] → [OFF]

Editing the set phone number

- 1 [MENU]#338
- 2 [↕]: "Notification to" → [SELECT]
- 3 [MENU] → [↕]: "Edit" → [SELECT]
- 4 Edit the name if necessary (16 characters max.). → [OK]
- 5 Edit the phone number if necessary (24 digits max.). → [OK] → [SELECT] → [OFF]

Erasing the set phone number

- 1 [MENU]#338
- 2 [↕]: "Notification to" → [SELECT]
- 3 [MENU] → [↕]: "Erase" → [SELECT]

- 4 [↕]: "Yes" → [SELECT] → [OFF]
 - The new message alert setting is turned off.

Activating/inactivating the remote access code to play messages

If you activate this feature, you must enter the remote access code (page 58) to play the new message from the new message alert call. This is so that unauthorized parties cannot listen to your messages. The default setting is "Inactivate".

- "Inactivate": You can listen to the message by pressing 4 to play new messages (without entering the remote access code).
- "Activate": You must enter your remote access code and then press 4 to play new message.

- 1 [MENU]#338
- 2 [↕]: "Remote code" → [SELECT]
- 3 [↕]: Select the desired setting. → [SAVE] → [OFF]

Listening to messages

After you answer the new message alert, you can listen to the messages as follows.

■ When the remote access code is set to "Inactivate":

Press 4 to play the new message during the announcement.

■ When the remote access code is set to "Activate":

- 1 Enter the remote access code (page 58) during the announcement.
- 2 Press 4 to play the new message.

Note:

- Within 10 seconds after listening to new messages, you can press #9 during the call to turn off the new message alert by a call feature.
- Even if the unit makes a new message alert call, the handset redial list does not show the record.

Answering System

Remote operation

Using a touch-tone phone, you can call your phone number from outside and access the unit to listen to messages or change answering system settings. The unit's voice guidance prompts you to press certain dial keys to perform different operations.

Remote access code

A 3-digit remote access code must be entered when operating the answering system remotely. This code prevents unauthorized parties from listening to your messages remotely. The default setting is "111".

Important:

- To prevent unauthorized access to this product, we recommend that you regularly change the remote code.

- [MENU]** **#** **3** **0** **6**
- Enter the desired 3-digit remote access code. → **[SAVE]** → **[OFF]**

Deactivating remote operation

Press **[X]** in step 2 on "Remote access code", page 58.

- The entered remote access code is deleted.

Using the answering system remotely

- Dial your phone number from a touch-tone phone.
- After the greeting message starts, enter your remote access code.
- Follow the voice guidance prompts as necessary or control the unit using remote commands (page 58).
- When finished, hang up.

Voice guidance

■ When the English voice guidance is selected

During remote operation, the unit's voice guidance starts and prompts you to press

- [1]** to perform a specific operation, or press **[2]** to listen to more available operations.

■ When the Spanish voice guidance is selected

To start the voice guidance, press **[9]**. The voice guidance announces the available remote commands (page 58).

Note:

- If you do not press any dial keys within 10 seconds after a voice guidance prompt, the unit disconnects your call.

Remote commands

You can press dial keys to access certain answering system functions without waiting for the voice guidance to prompt you.

Key	Operation
[1]	Repeat message (during playback)*1
[2]	Skip message (during playback)
[4]	Play new messages
[5]	Play all messages
[9]	Stop playback*2 Start voice guidance*3
[0]	Turn answering system off
[X] [4]	Erase currently playing message
[X] [5]	Erase all messages
[X] #	End remote operation (or hang up)

*1 If pressed within the first 5 seconds of a message, the previous message is played.

*2 For English voice guidance only

*3 For Spanish voice guidance only

Turning on the answering system remotely

- Dial your phone number from a touch-tone phone.
- Let the phone ring 15 times.
 - A long beep is heard.

- 3 Enter your remote access code within 10 seconds after the long beep.
- The greeting message is played back.
 - You can either hang up, or enter your remote access code again and begin remote operation (page 58).

Answering system settings

Call screening

While a caller is leaving a message, you can listen to the call through the unit's speaker. To adjust the speaker volume, press **[+]** or **[-]** repeatedly.

You can answer the call by pressing **[TALK]** on the handset or **[📞]** on the base unit. Call screening can be set for each unit. The default setting is "on".

- 1 For handset: **[MENU]#310**
For base unit (using a handset): **[MENU]#*310**
- 2 **[↕]**: Select the desired setting. → **[SAVE] → [OFF]**

Number of rings before the unit answers a call

You can change the number of times the phone rings "Ring count" before the unit answers calls. You can select 2 to 7 rings, or "Toll saver".

The default setting is "4 rings".

"Toll saver": The unit's answering system answers at the end of the 2nd ring when new messages have been recorded, or at the end of the 5th ring when there are no new messages. If you call your phone from outside to listen to new messages (page 58), you know that there are no new messages when the phone rings for the 3rd time. You can then hang up without being charged for the call.

- 1 **[MENU]#211**
- 2 **[↕]**: Select the desired setting. → **[SAVE] → [OFF]**

Caller's recording time

You can change the maximum message recording time allowed for each caller. The default setting is "3 min".

- 1 **[MENU]#305**
- 2 **[↕]**: Select the desired setting. → **[SAVE] → [OFF]**

Selecting "Greeting only"

You can select "Greeting only" which sets the unit to announce a greeting message to callers but not record messages.

Select "Greeting only" in step 2 on "Caller's recording time", page 59.

Note:

- When you select "Greeting only":
 - If you do not record your own message, the unit will play the pre-recorded greeting-only message asking callers to call again later.
 - If you use your own message, record the greeting-only message asking callers to call again later (page 54).

Useful Information

Voice mail service

In addition to your unit's answering system you may also have voicemail service from your phone service provider. Voicemail is an answering service that may be offered by your phone service provider. This service can also record calls when you are unavailable to answer the phone or when your line is busy. Messages are recorded on the phone company system and not on the unit's answering system.

- To use the voicemail service rather than the unit's answering system, turn off the answering system (page 54).

If you have unit's answering system set on and also the voicemail enabled, the system with least amount of rings will record the message first.

Example:

If the unit's answering system is set to 4 rings (page 59) and the voicemail answering system provided by your phone company is set to 6 rings (call your service provider), the unit's answering system will record the incoming call first.

Important:

- You need to store the voicemail access number in order to light the handset and base unit's message indicator when a new voicemail is received (page 28).

Storing the voicemail (VM) access number

In order to listen to your voicemail messages, you must dial your phone service provider's voicemail access number. Once you have stored your voicemail access number, you can dial it automatically (page 61).

- 1 **[MENU]** **[#]** **[3]** **[3]** **[1]**
- 2 Enter your access number (24 digits max.). → **[SAVE]** → **[OFF]**

Note:

- When storing your voicemail access number and your mailbox password, press **[▲]** (Pause) to add pauses (page 32) between the access number and the

password as necessary. Contact your phone service provider for the required pause time.

Example:

1-222-333-4444	PPPP	8888
VM access number	Pauses	Password

To erase the voicemail access number

- 1 **[MENU]** **[#]** **[3]** **[3]** **[1]**
- 2 Press and hold **[CLEAR]** until all digits are erased. → **[SAVE]** → **[OFF]**

Voice mail (VM) tone detection

Your phone service provider sends special signals (sometimes called "voicemail tones" or "stutter tones") to the unit to let you know you have new voicemail messages. If you hear a series of dial tones followed by a continuous dial tone after you press **[TALK]** on the handset or press **[☎]** on the base unit, you have new voicemail messages. Soon after you hang up a call or after the phone stops ringing, your unit checks the phone line to see if new voicemail messages have been recorded.

Turn this feature off when:

- You do not subscribe to voicemail service.
- Your phone service provider does not send voicemail tones.
- Your phone is connected to a PBX.

If you are not sure which setting is required, contact your phone service provider.

Turning VM tone detection on/off

The default setting is "On".

- 1 **[MENU]** **[#]** **[3]** **[3]** **[2]**
- 2 **[↕]**: Select the desired setting. → **[SAVE]** → **[OFF]**

Listening to voicemail messages

When new messages have been recorded:

- "Voicemail msg. via phone co." is displayed if message indication service is available.
- The message indicator flashes slowly if the handset or base unit message indicator's "New VM" setting is enabled (page 28).

- 1 **[MENU]** **[#]** **[3]** **[3]** **[0]**
 - The speakerphone turns on.
- 2 Follow the pre-recorded instructions.
- 3 When finished, hang up.

Note:

- You can also use the **[ACCESS]** soft key, if displayed, to play new voicemail messages.
- If the handset still indicates there are new messages even after you have listened to all new messages, turn it off by pressing and holding **[#]** until the handset beeps.

Wall mounting

Note:

- Make sure that the wall and the fixing method are strong enough to support the weight of the unit.

- 1 Lead the AC adaptor cord and telephone line cord through the hole in the wall mounting adaptor in the direction of the arrow.

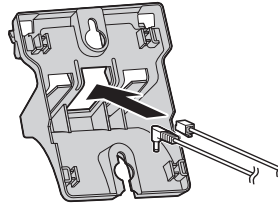

- 2 Tuck the telephone line cord inside the wall mounting adaptor (1). Connect the AC adaptor cord and telephone line cord (2).
- A** AC adaptor cord

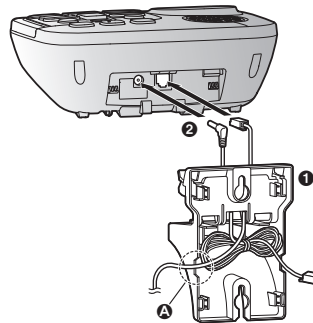

Useful Information

- 3** Insert the hooks on the wall mounting adaptor into holes **(A)** and **(B)** on the base unit.

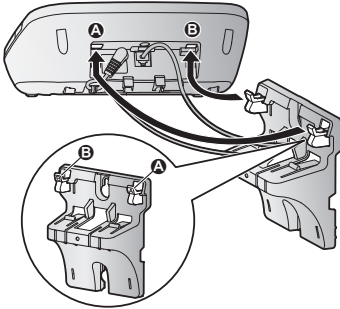

- 4** Adjust the adaptor to hold the base unit, then push it in the direction of the arrow until it clicks into place.

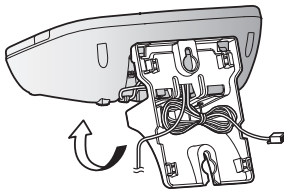
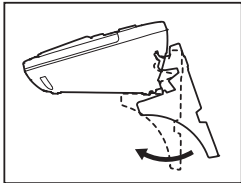

- 5** Mount the unit on a wall then slide down to secure in place.

- A** AC adaptor cord
- This product is compliant with the following wall phone plate sizes (2 types).
 - B** 83 mm (3 1/4 inches)
 - C** 102 mm (4 inches)

Fit the slots of the unit onto the corresponding wall phone plate tabs for **(D)** and **(E)** respectively.

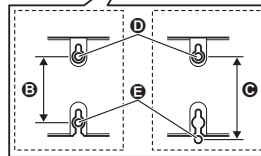
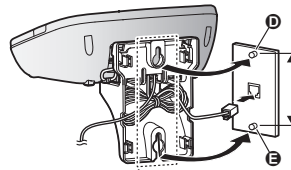
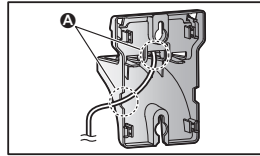

To remove the wall mounting adaptor

While pushing down the release levers **(1)**, remove the adaptor **(2)**.

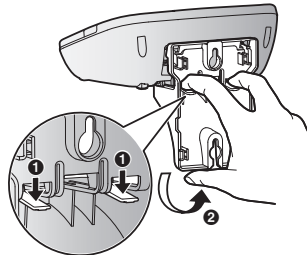

Error messages

Display message	Cause/solution
Ask phone company for VM access #	<ul style="list-style-type: none"> You have not stored the voicemail access number. Store the number (page 60).
Busy	<ul style="list-style-type: none"> The called unit is in use. Other units are in use and the system is busy. Try again later. The handset you are using is too far from the base unit. Move closer and try again.
Check tel line	<ul style="list-style-type: none"> The supplied telephone line cord has not been connected yet or not connected properly. Check the connections (page 12).
Error!!	<ul style="list-style-type: none"> Recording was too short. Try again.
Invalid	<ul style="list-style-type: none"> There is no handset registered to the base unit matching the handset number you entered. The handset is not registered to the base unit. Register the handset (page 50).
Main unit no power or No link. Re-connect base AC adaptor.	<ul style="list-style-type: none"> Confirm the base unit's AC adaptor is connected to the unit and the power outlet correctly. The handset has lost communication with the base unit. Move closer to the base unit and try again. Unplug the base unit's AC adaptor to reset the unit. Reconnect the adaptor and try again. The handset's registration may have been canceled. Re-register the handset (page 50).
Requires subscription to Caller ID.	<ul style="list-style-type: none"> You must subscribe to a Caller ID service. Once you receive caller information after subscribing to a Caller ID service, this message will not be displayed.
Use rechargeable battery.	<ul style="list-style-type: none"> A wrong type of battery such as alkaline or manganese was inserted. Use only the rechargeable Ni-MH batteries noted on page 5, 8.

Useful Information

Troubleshooting

If you still have difficulties after following the instructions in this section, disconnect the base unit's AC adaptor, then reconnect the base unit's AC adaptor. Remove the batteries from the handset, and then insert them into the handset again.

If the base unit batteries for power backup are installed, remove the batteries from the base unit, and then insert them into the base unit again.

General use

Problem	Cause/solution
The handset does not turn on even after installing charged batteries.	<ul style="list-style-type: none">Place the handset on the base unit or charger to turn on the handset.
The unit does not work.	<ul style="list-style-type: none">Make sure the batteries are installed correctly (page 14).Fully charge the batteries (page 13).Check the connections (page 12).Unplug the base unit's AC adaptor to reset the unit. Reconnect the adaptor and try again.The handset has not been registered to the base unit. Register the handset (page 50).
I cannot hear a dial tone.	<ul style="list-style-type: none">The base unit's AC adaptor or telephone line cord is not connected. Check the connections.Disconnect the base unit from the telephone line and connect the line to a known working telephone. If the working telephone operates properly, contact our service personnel to have the unit repaired. If the working telephone does not operate properly, contact your phone service provider.
The indicator on the handset or base unit flashes slowly.	<ul style="list-style-type: none">New messages have been recorded. Listen to the new messages (page 55).New voicemail messages have been recorded. Listen to the new voicemail messages (page 61).
The base unit beeps.	<ul style="list-style-type: none">New messages have been recorded. Listen to the new messages (page 55).
The unit does not work during a power failure.	<ul style="list-style-type: none">The batteries inserted in the base unit are depleted. You can insert 2 alkaline batteries into the base unit to provide backup power. Remove the alkaline batteries and reinsert the rechargeable batteries when power is restored (page 15).

Accessibility

Problem	Cause/solution
I cannot search the phonebook, caller list, redial list, memory dial, or call block list.	<ul style="list-style-type: none"> Other units are in use and the system is busy. Try again later.
The unit does not announce names or phone numbers when I search the phonebook, caller list, etc.	<ul style="list-style-type: none"> The default setting for the talking keypad and phonebook feature is "off". Change the setting (page 26). Other units are in use and the system is busy. Try again later.
The announcement is in a language I cannot understand.	<ul style="list-style-type: none"> Change the voice announcement language (page 21).
The announcement is too low to be heard.	<ul style="list-style-type: none"> Change the talking keypad and phonebook setting to "High" (page 27).
I cannot use the slow talk feature.	<ul style="list-style-type: none"> Other units are in use and the system is busy. Try again later.
When using a neckloop, whistling or feedback is heard, or the other party cannot hear your voice.	<ul style="list-style-type: none"> The headset type is set to "Headset" or "Neckloop with Mic". Select "Neckloop w/o Mic" (page 30).
When using a headset, the other party says that your voice is very quiet or sounds far away.	<ul style="list-style-type: none"> The headset type is set to "Neckloop w/o Mic". Select "Headset" (page 30).
When using a neckloop with a built-in microphone, the other party says that your voice is very quiet or sounds far away.	<ul style="list-style-type: none"> The headset type is set to "Neckloop w/o Mic". Select "Neckloop with Mic" (page 30).



Menu list

Problem	Cause/solution
The display is in a language I cannot read.	<ul style="list-style-type: none"> Change the display language (page 21).
I cannot register a handset to a base unit.	<ul style="list-style-type: none"> The maximum number of handsets (6) is already registered to the base unit. Cancel unused handset registrations from the base unit (page 51).





Battery recharge

Problem	Cause/solution
The handset beeps and/or  flashes.	<ul style="list-style-type: none"> Battery charge is low. Fully charge the batteries (page 13).

Useful Information

Problem	Cause/solution
I fully charged the batteries, but <ul style="list-style-type: none"> -  still flashes, -  is displayed, or - the operating time seems to be shorter. 	<ul style="list-style-type: none"> • Clean the battery ends (\oplus, \ominus) and the charge contacts with a dry cloth and charge again. • It is time to replace the batteries (page 14).

Making/answering calls, intercom

Problem	Cause/solution
 is displayed.	<ul style="list-style-type: none"> • The handset is too far from the base unit. Move closer. • The base unit's AC adaptor is not properly connected. Reconnect AC adaptor to the base unit. • The handset is not registered to the base unit. Register it (page 50).
Noise is heard, sound cuts in and out.	<ul style="list-style-type: none"> • You are using the handset or base unit in an area with high electrical interference. Re-position the base unit and use the handset away from sources of interference. • Move closer to the base unit. • If you use a DSL/ADSL service, we recommend connecting a DSL/ADSL filter between the base unit and the telephone line jack. Contact your DSL/ADSL provider for details.
The handset does not ring.	<ul style="list-style-type: none"> • The ringer volume is turned off. Adjust the ringer volume (page 33, 44). • Silent mode is turned on. Turn it off (page 50). • The ringer volume is turned off by pressing and holding  (). Press and hold  () again to turn it on (page 33).
The base unit does not ring.	<ul style="list-style-type: none"> • The ringer volume is turned off. Adjust the ringer volume (page 33, 44). • Silent mode is turned on. Turn it off (page 50). • The ringer volume is turned off by pressing [RINGER OFF]. Press [RINGER OFF] again to turn it on (page 33).
I cannot make a call.	<ul style="list-style-type: none"> • The dialing mode may be set incorrectly. Change the setting (page 22).
I cannot make long distance calls.	<ul style="list-style-type: none"> • Make sure that you have long distance service.
I cannot use voice paging.	<ul style="list-style-type: none"> • You cannot use voice paging if other units are in use. • Voice paging is not available when a range extender (KX-TGA405) is registered to the base unit.

Caller ID/Talking Caller ID

Problem	Cause/solution
Caller information is not displayed.	<ul style="list-style-type: none"> ● You must subscribe to Caller ID service. Contact your phone service provider for details. ● If your unit is connected to any additional telephone equipment such as a Caller ID box or cordless telephone line jack, plug the unit directly into the wall jack. ● If you use a DSL/ADSL service, we recommend connecting a DSL/ADSL filter between the base unit and the telephone line jack. Contact your DSL/ADSL provider for details. ● The name display service may not be available in some areas. Contact your phone service provider for details. ● Other telephone equipment may be interfering with this unit. Disconnect the other equipment and try again.
Caller information is displayed or announced late.	<ul style="list-style-type: none"> ● Depending on your phone service provider, the unit may display or announce the caller's information at the 2nd ring or later. ● Move closer to the base unit.
Caller information is not announced.	<ul style="list-style-type: none"> ● The handset or base unit's ringer volume is turned off. Adjust it (page 33, 44). ● The Talking Caller ID feature is turned off. Turn it on (page 45). ● The number of rings for the answering system is set to "2 rings" or "Toll saver". Select a different setting (page 59). ● If the base unit and another handset are having an intercom call, your handset does not announce caller information.
The caller list/incoming phone numbers are not edited automatically.	<ul style="list-style-type: none"> ● The Caller ID number auto edit feature is turned off. Turn it on and try again (page 47). ● You need to call back the edited number to activate Caller ID number auto edit.
I cannot dial the phone number edited in the caller list.	<ul style="list-style-type: none"> ● The phone number you dialed might have been edited incorrectly (for example, the long distance "1" or the area code is missing). Edit the phone number with another pattern (page 53).
Time on the unit has shifted.	<ul style="list-style-type: none"> ● Incorrect time information from incoming Caller ID changes the time. Set the time adjustment to "Manual" (off) (page 45).
The 2nd caller's information is not displayed during an outside call.	<ul style="list-style-type: none"> ● In order to use Caller ID, call waiting, or Call Waiting Caller ID (CWID), you must first contact your phone service provider and subscribe to the desired service. After subscribing, you may need to contact your phone service provider again to activate this specific service, even if you already subscribed to both Caller ID and Call Waiting with Caller ID services (CWID).

Useful Information

Answering system

Problem	Cause/solution
The unit does not record new messages.	<ul style="list-style-type: none">• The answering system is turned off. Turn it on (page 54).• The message memory is full. Erase unnecessary messages (page 55, 56).• The recording time is set to “Greeting only”. Change the setting (page 59).• Your phone service provider’s voicemail service may be answering your calls before the unit’s answering system can answer your calls. Change the unit’s number of rings setting (page 59) to a lower value, or contact your phone service provider.• The answering system will not answer incoming calls while the other devices such as handsets are engaged in a call.
I cannot operate the answering system remotely.	<ul style="list-style-type: none">• The remote access code is not set. Set the remote access code (page 58).• You are entering the wrong remote access code. If you have forgotten your remote access code, enter the remote access code setting to check your current code (page 58).• The answering system is turned off. Turn it on (page 58).
The unit does not emit the specified number of rings.	<ul style="list-style-type: none">• If the first ring is turned off (“No”) (page 38), the number of rings decreases by 1 from the specified number of rings.

Voicemail

Problem	Cause/solution
“Voicemail msg. via phone co.” is shown on the handset display. How do I remove this message from the display?	<ul style="list-style-type: none">• This notification is displayed when your phone service provider’s voicemail service (not the unit’s answering system) has recorded a message for you. Typically you can remove this notification from the display by listening to the message. To listen to the message, dial the voicemail number provided by your phone service provider (for most cases, this will be your own phone number), and follow the voice instructions. Depending on your phone service provider, you may need to remove all messages from your voice mailbox to remove the notification. You can also remove this notification by pressing and holding [#] until the unit beeps.

Useful Information

Liquid damage

Problem	Cause/solution
Liquid or other form of moisture has entered the handset/base unit.	<ul style="list-style-type: none">● Disconnect the AC adaptor and telephone line cord from the base unit. Remove the batteries from the base unit and handset and leave to dry for at least 3 days. After the handset/base unit are completely dry, reconnect the AC adaptor and telephone line cord. Insert the batteries and charge fully before use. If the unit does not work properly, contact an authorized service center.

Caution:

- To avoid permanent damage, do not use a microwave oven to speed up the drying process.

Useful Information

FCC and other information

This equipment complies with Part 68 of the FCC rules and the requirements adopted by the ACTA. On the bottom of this equipment is a label that contains, among other information, a product identifier in the format US:ACJ-----.

If requested, this number must be provided to the telephone company.

- Registration No.....(found on the bottom of the unit)
- Ringer Equivalence No. (REN).....0.1B

A plug and jack used to connect this equipment to the premises wiring and telephone network must comply with the applicable FCC Part 68 rules and requirements adopted by the ACTA. A compliant telephone cord and modular plug is provided with the product. It is designed to be connected to a compatible modular jack that is also compliant.

The REN is used to determine the number of devices that may be connected to a telephone line. Excessive RENs on a telephone line may result in the devices not ringing in response to an incoming call. In most but not all areas, the sum of RENs should not exceed five (5.0). To be certain of the number of devices that may be connected to a line, as determined by the total RENs, contact the local telephone company. For products approved after July 23, 2001, the REN for the product is part of the product identifier that has the format US:AAAEQ##TXXXX. The digits represented by ## are the REN without a decimal point (e.g., 03 is a REN of 0.3).

If this equipment causes harm to the telephone network, the telephone company will notify you in advance that temporary discontinuance of service may be required. But if advance notice isn't practical, the telephone company will notify the customer as soon as possible. Also, you will be

advised of your right to file a complaint with the FCC if you believe it is necessary.

The telephone company may make changes in its facilities, equipment, operations or procedures that could affect the operation of the equipment. If this happens the telephone company will provide advance notice in order for you to make necessary modifications to maintain uninterrupted service.

If trouble is experienced with this equipment, for repair or warranty information, please contact a Factory Service Center or other Authorized Servicer. If the equipment is causing harm to the telephone network, the telephone company may request that you disconnect the equipment until the problem is resolved.

Connection to party line service is subject to state tariffs. Contact the state public utility commission, public service commission or corporation commission for information.

If your home has specially wired alarm equipment connected to the telephone line, ensure the installation of this equipment does not disable your alarm equipment. If you have questions about what will disable alarm equipment, consult your telephone company or a qualified installer.

This equipment is hearing aid compatible as defined by the FCC in 47 CFR Section 68.316.

When you hold the phone to your ear, noise might be heard in your Hearing Aid. Some Hearing Aids are not adequately shielded from external RF (radio frequency) energy. If noise occurs, use an optional headset accessory or the speakerphone option (if applicable) when using this phone. Consult with your audiologist or Hearing Aid

Useful Information

manufacturer about the availability of Hearing Aids which provide adequate shielding to RF energy commonly emitted by digital devices.

WHEN PROGRAMMING EMERGENCY NUMBERS AND/OR MAKING TEST CALLS TO EMERGENCY NUMBERS:

- 1) Remain on the line and briefly explain to the dispatcher the reason for the call.
- 2) Perform such activities in the off-peak hours, such as early morning or late evenings.

This device complies with Part 15 of the FCC Rules. Operation is subject to the following two conditions:

(1) This device may not cause harmful interference, and (2) this device must accept any interference received, including interference that may cause undesired operation.

Privacy of communications may not be ensured when using this phone.

CAUTION:

Any changes or modifications not expressly approved by the party responsible for compliance could void the user's authority to operate this device.

NOTE:

This equipment has been tested and found to comply with the limits for a Class B digital device, pursuant to Part 15 of the FCC Rules. These limits are designed to provide reasonable protection against harmful interference in a residential installation. This equipment generates, uses, and can radiate radio frequency energy and, if not installed and used in accordance with the instructions, may cause harmful interference to radio communications. However, there is no guarantee that interference will not occur in a particular installation. If this equipment does cause harmful interference to radio or television reception, which can be determined by turning the equipment off and on, the user is

encouraged to try to correct the interference by one or more of the following measures:

- Reorient or relocate the receiving antenna.
- Increase the separation between the equipment and receiver.
- Connect the equipment into an outlet on a circuit different from that to which the receiver is connected.
- Consult the dealer or an experienced radio/TV technician for help.

Some cordless telephones operate at frequencies that may cause interference to nearby TVs and VCRs. To minimize or prevent such interference, the base of the cordless telephone should not be placed near or on top of a TV or VCR. If interference is experienced, move the cordless telephone further away from the TV or VCR. This will often reduce or eliminate interference.

FCC RF Exposure Warning:

- This product complies with FCC radiation exposure limits set forth for an uncontrolled environment.
- To comply with FCC RF exposure requirements, the base unit must be installed and operated 20 cm (8 inches) or more between the product and all person's body.
- This product may not be collocated or operated in conjunction with any other antenna or transmitter.
- The handset may be carried and operated with only the specific provided belt-clip. Other non-tested belt-clips or similar body-worn accessories may not comply and must be avoided.

Notice:

- FCC ID can be found inside the battery compartment or on the bottom of the units.

For assistance, please visit <http://shop.panasonic.com/support>

71

Useful Information

Compliance with TIA-1083 standard:

Telephone handsets identified with this logo have reduced noise and interference when used with T-Coil equipped hearing aids and cochlear implants.



Charge only mode

The charge only mode is the dedicated mode to charge the backup batteries of the base unit. Do not use this mode if it is unnecessary because all functions except the base unit's battery charge is disabled with this feature on. Leave all the registered handsets on the chargers during use of the charge only mode.

■ To activate the charge only mode:

- 1 Press **[ANSWER ON/OFF]** to turn on the answering system.
 - Make sure the message counter turns on.
- 2 Disconnect the telephone line cord, the AC adaptor plug, and remove the batteries from the base unit.
- 3 Press and hold **[▶▶]**, **[⏪]**, and **[ERASE]** at the same time, then insert the AC adaptor plug to the base unit. Keep on pressing these keys until a beep tone sounds.
- 4 Release these keys.
 - The message counter turns off.
- 5 Insert batteries.
 - The batteries are started to be charged.

Note:

- If the message counter is still on when you release the keys, the base unit is not in the charging only mode. Repeat from step 1.

■ To deactivate the charge only mode:

- Press any key.
- 24 hours passed after activating the charge only mode.

Guía Rápida Española

Conexiones

- ① Conecte el adaptador de corriente alterna a la unidad presionándolo firmemente.
- ② Enganche el cable para fijarlo.
- ③ Conecte el adaptador de corriente alterna a la toma de corriente.
- ④ Conecte el cable de la línea telefónica a la unidad, y después a la toma telefónica de una sola línea (RJ11C) hasta que escuche un clic.
- ⑤ Se requiere un filtro DSL/ADSL (no incluido) si tiene este tipo de servicio.

Nota:

- El adaptador de CA y el cable de la línea de teléfono vienen conectados a la unidad base en el momento del envío.
- Use solo el adaptador de corriente alterna Panasonic que se suministra.*1

*1 PNLV226: KX-TGM420
PNLV236: KX-TGM450

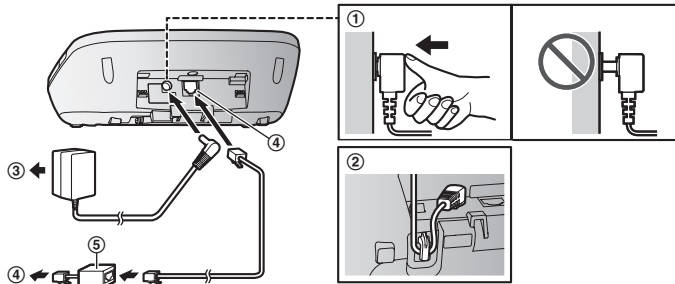

Guía Rápida Española

Carga de las baterías

Auricular

Dos (2) baterías Ni-MH recargables están instaladas en el auricular en el momento del envío.

Antes del uso inicial: Quite el precinto amarillo antes de usar el auricular.

Cargue aproximadamente durante 7 horas.

Nota para el auricular:

- UTILICE SOLO baterías recargables de Ni-MH tamaño AAA (R03).
- NO utilice baterías alcalinas, de manganeso ni de Ni-Cd.
- Confirme que las polaridades estén correctas (⊕, ⊖).
- Cambie el idioma de la pantalla.
- Confirme que aparezca "Cargando" (A).

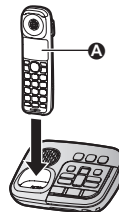

Unidad base

Dos (2) baterías Ni-MH recargables están instaladas en la unidad base en el momento del envío. Estas baterías pueden utilizarse para suministrar energía a la unidad base en caso de corte de energía.

Antes del uso inicial: Quite el precinto amarillo antes de usar la unidad base.

Cargue aproximadamente durante 15 horas.

Sugerencias de operación

Teclas de función

Al oprimir una tecla de función, puede seleccionar la función que aparece directamente encima de ella en la pantalla. Preste atención a la pantalla para ver qué funciones están asignadas a las teclas de función durante la operación.

Tecla navegadora

- [▲], [▼], [←], o [→]: Navegue por diversas listas y elementos.
- VOL. (Volumen: [▲] o [▼]): Ajuste el volumen del receptor o el altavoz mientras habla.
- [←] [RECALL] [→]: Vea la entrada del directorio telefónico.
- [→] REDIAL [←]: Vea la lista de remarcación.
- [▼] CID (identificador de llamadas): Vea la lista de personas que llamaron.

Tecla de volumen

Oprima [+] o [-] repetidamente:

- ajustar el volumen del timbre.
- ajustar el volumen del receptor o del altavoz mientras habla.

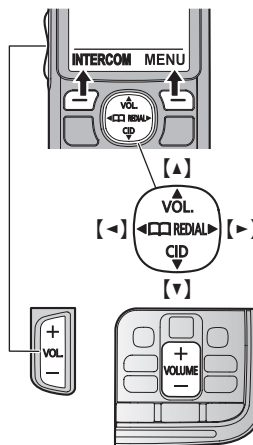

Cambio de idiomas (Auricular) (predeterminado: "English")

Cuando aparece "Set date/time Press SELECT", presione [OFF] para salir.

Idioma de la pantalla

[MENU] [F1] [1] [0] → [↕]: "Español" → [GUARDAR] → [OFF]

Idioma de anuncio de voz

[MENU] [F1] [1] [2] → [↕]: "Español" → [GUARDAR] → [OFF]

Fecha y hora (Auricular)

1 [MENU] [F1] [0] [1]

2 Introduzca el día, mes y año actuales. → [OK]

3 Introduzca la hora y minuto actuales (formato de reloj de 24 horas).

4 [GUARDAR] → [OFF]

Cómo grabar el mensaje de saludo del contestador de llamadas (Auricular)

Puede grabar su propio mensaje de saludo en lugar de usar uno pregrabado.

1 [MENU] [F1] [3] [0] [2] → [↕]: "sí" → [SELEC.]

2 Después de que se emita un pitido, sostenga el auricular a una distancia aproximada de 20 cm (8 pulgadas) y hable con claridad en el micrófono (máx. de 2 minutos).

3 Oprima [PARAR] para dejar de grabar. → [OFF]

Accesibilidad

Control del tono (Auricular)

1 Oprima repetidamente [TONE] al costado para seleccionar la configuración deseada mientras habla.

2 Para salir, oprima [ATRÁS] o espere unos segundos.

Control del tono (Unidad base)

1 Mantenga presionado [TONE] durante 2 segundos durante la llamada.

2 Oprima repetidamente [+] o [-] para seleccionar la configuración deseada.

3 Para salir, presione [TONE] o espere unos 5 segundos.

Activación del amplificador de volumen (Auricular)

⚠ ADVERTENCIA:

- Esta función está diseñada para usuarios con dificultades auditivas. Si otros usuarios utilizan el teléfono, asegúrese de desactivar esta función.
- No use esta función si no es necesario. El volumen alto que emite el producto puede provocar daños auditivos.
- Al presionar la tecla [BOOST] se activa la función de amplificación de sonido. Utilice esta tecla con cuidado. En la configuración de volumen más alto (las funciones de volumen y amplificador de volumen configuradas en su nivel máximo), el producto puede emitir sonidos de hasta 40 dB (KX-TGM420) o 50 dB (KX-TGM450). Para evitar daños auditivos, le recomendamos configurar este producto con el volumen mínimo en el cual pueda escuchar adecuadamente.

1 Oprima [BOOST] durante una llamada.

- El indicador BOOST enciende una luz roja.

2 Oprima repetidamente [+] o [-] al costado para seleccionar el volumen deseado.

Guía Rápida Española

Accesibilidad

Aumentador de voz (hace su voz más fuerte) (Auricular)

ADVERTENCIA:

- La función de amplificación de voz puede utilizarse para subir el volumen de su voz para su interlocutor. Si utiliza esta función innecesariamente, el volumen de su voz puede estar demasiado alto. Le recomendamos que utilice esta función solo si el volumen de su voz es demasiado bajo para el interlocutor.

- 1 Oprima **[MENU]** durante una llamada.
- 2 **[↑]**: “Amp. de Trans. Enc.” o “Amp. Tr. Apag.” → **[SELEC.]**

Configuración de teclado y libreta de teléfonos por voz (Auricular/Unidad base)

- 1 Para el auricular: **[MENU]****[7]****[5]****[0]**
Para la unidad base (usando un auricular): **[MENU]****[7]****[5]****[0]**
- 2 **[↓]**: Seleccione la configuración deseada. → **[GUARDAR]** → **[OFF]**

Configuración del indicador de mensajes (Auricular/Unidad base)

- 1 Para el auricular: **[MENU]****[7]****[8]**
Para la unidad base (usando un auricular): **[MENU]****[7]****[8]**
- 2 **[↓]**: Seleccione la configuración deseada y oprima **[SELEC.]**.
- 3 **[GUARDAR]** → **[OFF]**

Conversación lenta (Auricular)

Para activar esta función o cambiar la configuración actual, presione repetidamente **[SLOW]**.

Conversación lenta (Unidad base)

Para activar esta función o cambiar la configuración actual, presione repetidamente **[SLOW TALK]**.

Operaciones básicas

Para hacer y contestar llamadas (Auricular)

Para hacer llamadas	Marque el número telefónico. → [TALK] / [☎]
Para contestar llamadas	[TALK] / [☎]
Para colgar	[OFF]
Para ajustar el volumen del receptor o del altavoz	Oprima repetidamente [+] o [-] al costado durante la llamada.
Cómo hacer una llamada usando la lista de remarcación	[▶] REDIAL → [↓] : Seleccione el número telefónico deseado. → [TALK]
Para ajustar el volumen del timbre del auricular	Oprima repetidamente [+] o [-] al costado para seleccionar el volumen deseado.

Operaciones básicas

Para contestar llamadas (Unidad base)

Para contestar llamadas	[☎]
Para colgar	[☎]
Para ajustar el volumen del altavoz	Oprima [+] o [-] repetidamente mientras habla.
Para ajustar el volumen del timbre de la unidad base	Oprima [+] o [-] repetidamente para seleccionar el volumen deseado.

Directorio telefónico (Auricular)

Para añadir entradas	<ol style="list-style-type: none"> 1 [◀] □ □ → [MENU] 2 [⬆]: "Agregar Ent. Nueva" → [SELEC.] 3 Introduzca el nombre de la persona (máx. 16 caracteres). → [OK] 4 Introduzca el número telefónico de la persona (máx. 24 dígitos). → [OK] 5 [⬆]: Seleccione el grupo deseado. → [SELEC.] 2 veces → [OFF] <ul style="list-style-type: none"> • En el paso 3, puede cambiar el idioma de introducción de caracteres. [#] → [⬆]: Seleccione el idioma deseado. → [OK]
Para hacer llamadas	[◀] □ □ → [⬆]: Seleccione la entrada deseada. → [TALK]

Memoria de marcaje (Unidad base)

Añadir números de teléfono usando un auricular	<ol style="list-style-type: none"> 1 Mantenga pulsada la tecla de memoria que desee ([1] a [3]) en el auricular. → [AÑADIR] 2 [⬆]: "Manual" → [SELEC.] • Si selecciona "Directorio", puede agregar números de teléfono del directorio. En este caso, siga las instrucciones en pantalla. 3 Introduzca el nombre de la persona (máx. 16 caracteres). → [OK] 4 Introduzca el número telefónico de la persona (máx. 24 dígitos). → [OK] → [SELEC.] → [OFF] • El número de teléfono se asigna a la tecla correspondiente de la memoria en el auricular ([1], [2], o [3]) y unidad base ([M1], [M2], o [M3]).
Para hacer llamadas	Mantenga pulsada la tecla de memoria que desee ([M1] a [M3]) en la unidad base.

Sistema contestador de llamadas (Unidad base)

Contestador encendido/apagado	Oprima [ANSWER ON/OFF] para encender y apagar el contestador de llamadas.
Para escuchar mensajes	[▶■] (PLAY)

Sistema contestador de llamadas (Auricular)

Para escuchar mensajes	<p>Para escuchar mensajes nuevos: [REPROD.] o [MENU] [#] [3] [2] [3]</p> <p>Para escuchar todos los mensajes: [MENU] [#] [3] [2] [4]</p>
------------------------	---

Guía Rápida Española

Preguntas frecuentes	
Pregunta	Causa y solución
¿Por qué aparece Ψ ?	<ul style="list-style-type: none"> El auricular está demasiado lejos de la unidad base. Acérquelo. El adaptador para corriente de la unidad base no está conectado correctamente. Conecte de nuevo el adaptador para corriente a la unidad base. El auricular no está registrado en la unidad base. Regístrelo. <ol style="list-style-type: none"> Auricular: [MENU] [#] [1] [3] [0] Unidad base: Oprima y mantenga oprimido [LOCATOR/INTERCOM] durante aproximadamente 5 segundos. Auricular: Oprima [OK], y después espere hasta que suene un pitido largo.
¿Cómo se incrementa el nivel de volumen del auricular?	<ul style="list-style-type: none"> Presione repetidamente la tecla de volumen [+] en el lateral del auricular durante una llamada. Si el indicador BOOST no está encendido, active el aumentador de volumen presionando [BOOST] durante una llamada. Tenga en cuenta que el volumen subirá drásticamente.
¿Cómo se disminuye el nivel de volumen del auricular?	<ul style="list-style-type: none"> Presione repetidamente la tecla de volumen [-] en el lateral del auricular durante una llamada. Si el indicador BOOST está encendido, desactive el aumentador de volumen presionando [BOOST] durante una llamada.
¿Por qué hay ruido o se corta la conversación?	<ul style="list-style-type: none"> Trate de reubicar la unidad base de forma que se minimice la distancia al auricular. Si ocurre el mismo problema aunque el auricular se encuentre enseguida de la unidad base, visite: http://shop.panasonic.com/support
¿Es posible añadir otro auricular accesorio a mi unidad base?	<ul style="list-style-type: none"> Sí, puede añadir hasta 6 auriculares (incluyendo los que se venden con su unidad base) a una sola unidad base. Para adquirir auriculares accesorios adicionales^{*1}, visite: http://shop.panasonic.com/support <p>Los usuarios TTY (usuarios con impedimentos auditivos o del habla) pueden llamar al 1-877-833-8855.</p> <p>*1 KX-TGMA44: El volumen máximo del receptor es de 40 dB. KX-TGMA45: El volumen máximo del receptor es de 50 dB.</p>
¿Es posible mantener cargando las baterías todo el tiempo?	<ul style="list-style-type: none"> Puede dejar el auricular en la unidad base o el cargador en cualquier momento. Esto no daña las baterías.
¿Cómo se contestan las llamadas en espera (segunda llamada)?	<ul style="list-style-type: none"> Oprima [FLASH] en el auricular o [CALL WAIT] en la unidad base cuando escuche el tono de llamada en espera.

Customer services

Shop
Accessories!

for all your Panasonic gear

Go to

<http://shop.panasonic.com/support>

Get everything you need to get the most out of
your Panasonic products

Accessories & Parts for your Camera, Phone, A/V
products, TV, Computers & Networking, Personal
Care, Home Appliances, Headphones, Batteries,
Backup Chargers & more...

Customer Services Directory

For Product Information, Operating Assistance,
Parts, Owner's Manuals, Dealer and Service info
go to <http://shop.panasonic.com/support>

For the hearing or speech impaired TTY: 1- 877-833-8855

As of June 2015

Appendix

Limited Warranty (ONLY FOR U.S.A.)

Panasonic Products Limited Warranty

Limited Warranty Coverage (For USA Only)

If your product does not work properly because of a defect in materials or workmanship, Panasonic Corporation of North America (referred to as "the warrantor") will, for the length of the period indicated on the chart below, which starts with the date of original purchase ("warranty period"), at its option either (a) repair your product with new or refurbished parts, (b) replace it with a new or a refurbished equivalent value product, or (c) refund your purchase price. The decision to repair, replace or refund will be made by the warrantor.

Product or Part Name	Parts	Labor
Telephone	One (1) Year	One (1) Year

During the "Labor" warranty period there will be no charge for labor. During the "Parts" warranty period, there will be no charge for parts. This Limited Warranty excludes both parts and labor for non-rechargeable batteries, antennas, and cosmetic parts (cabinet). This warranty only applies to products purchased and serviced in the United States. This warranty is extended only to the original purchaser of a new product which was not sold "as is".

Mail-In Service--Online Repair Request

Online Repair Request

To submit a new repair request and for quick repair status visit our Web Site at <http://shop.panasonic.com/support>

When shipping the unit, carefully pack, include all supplied accessories listed in the Owner's Manual, and send it prepaid, adequately insured and packed well in a carton box. When shipping Lithium Ion batteries please visit our Web Site at <http://shop.panasonic.com/support> as Panasonic is committed to providing the most up to date information. Include a letter detailing the complaint, a return address and provide a daytime phone number where you can be reached. A valid registered receipt is required under the Limited Warranty.

IF REPAIR IS NEEDED DURING THE WARRANTY PERIOD, THE PURCHASER WILL BE REQUIRED TO FURNISH A SALES RECEIPT/PROOF OF PURCHASE INDICATING DATE OF PURCHASE, AMOUNT PAID AND PLACE OF PURCHASE. CUSTOMER WILL BE CHARGED FOR THE REPAIR OF ANY UNIT RECEIVED WITHOUT SUCH PROOF OF PURCHASE.

Limited Warranty Limits and Exclusions

This warranty ONLY COVERS failures due to defects in materials or workmanship, and DOES NOT COVER normal wear and tear or cosmetic damage. The warranty ALSO DOES NOT COVER damages which occurred in shipment, or failures which are caused by products not supplied by the warrantor, or failures which result from accidents, misuse, abuse, neglect, mishandling, misapplication, alteration, faulty installation, set-up adjustments, misadjustment of consumer controls, improper maintenance, power line surge, lightning damage, modification, introduction of sand, humidity or liquids, commercial use such as hotel, office, restaurant, or other business or rental use of the product, or service by anyone other than a Factory Service Center or other Authorized Servicer, or damage that is attributable to acts of God.

THERE ARE NO EXPRESS WARRANTIES EXCEPT AS LISTED UNDER "LIMITED WARRANTY COVERAGE".

THE WARRANTOR IS NOT LIABLE FOR INCIDENTAL OR CONSEQUENTIAL DAMAGES RESULTING FROM THE USE OF THIS PRODUCT, OR ARISING OUT OF ANY BREACH OF THIS WARRANTY.

(As examples, this excludes damages for lost time, travel to and from the servicer, loss of or damage to media or images, data or other memory or recorded content. The items listed are not exclusive, but for illustration only.)

ALL EXPRESS AND IMPLIED WARRANTIES, INCLUDING THE WARRANTY OF MERCHANTABILITY, ARE LIMITED TO THE PERIOD OF THE LIMITED WARRANTY.

Some states do not allow the exclusion or limitation of incidental or consequential damages, or limitations on how long an implied warranty lasts, so the exclusions may not apply to you. This warranty gives you specific legal rights and you may also have other rights which vary from state to state. If a problem with this product develops during or after the warranty period, you may contact your dealer or Service Center. If the problem is not handled to your satisfaction, then write to:

Consumer Affairs Department
Panasonic Corporation of North America
661 Independence Pkwy
Chesapeake, VA 23320

PARTS AND SERVICE, WHICH ARE NOT COVERED BY THIS LIMITED WARRANTY, ARE YOUR RESPONSIBILITY.

As of June 2015

Index

Index

- # 3-way conference: 34
- A** Accessibility
 - Auto boost: 25
 - Booster (speech): 26
 - Booster (volume): 24
 - Headset type: 30
 - Message indicator: 28
 - Neckloop: 29
 - Talking dial: 26
 - Tone control: 23
- Additional handset: 50
- Alarm: 49
- Answering calls: 32
- Answering system
 - Call screening: 59
 - Erasing
 - messages: 55, 56, 58
 - Greeting message: 54
 - Greeting only: 59
 - Listening to
 - messages: 55, 58
 - New message alerting: 56
 - Number of rings: 59
 - Recording time: 59
 - Remote access code: 58
 - Remote operation: 58
 - Ring count: 59
 - Toll saver: 59
 - Turning on/off: 54
- Auto talk: 32, 47
- B** Battery: 14, 16
- C** Call block: 37
 - One ring for blocked call: 38
- Call share: 34, 47
- Call waiting: 34
- Call Waiting Caller ID: 34
- Caller ID number auto edit: 47, 53
- Caller ID service: 52
- Caller list: 52
- Caller list edit: 53
- Chain dial: 40
- CID (Caller ID): 52
- Conference calls: 35
- Control type: 18
- Customer support: 48
- D** Date and time: 21
- Dialing mode: 22
- Direct command code: 42
- Display
 - Contrast: 46
 - Language: 21
- E** Eco mode: 16
- Error messages: 63
- F** Flash: 34, 47
- G** Groups: 39
- H** Handset
 - Deregistration: 51
 - Name: 50
 - Registration: 50
 - Hold: 33
- I** Intercom: 35
- K** Key detector: 46, 48
- Key tone: 45
- L** Line mode: 47
- M** Making calls: 32
- Memory dial: 41
- Missed calls: 52
- Mute: 33
- N** Noise reduction: 34
- P** Pause: 32
- Phonebook: 39
- Power failure (power backup operation): 14
- R** Redialing: 32
- Ringer ID: 39
- Ringer tone
 - Intercom call (Base unit): 44
 - Intercom call (Handset): 44
 - Outside call (Base unit): 44
 - Outside call (Handset): 44
- Rotary/pulse service: 34
- S** Silent mode: 49
- Sound enhancer: 34

- SP-PHONE
(Speakerphone): 32
- T** Talking Caller ID: 52
- Temporary tone dialing: 34
- Time adjustment: 45
- Transferring calls: 35
- Troubleshooting: 64
- TTY: 79
- V** VM (Voicemail): 60
- Voice announcement language: 21
- Voice paging: 35
- Voicemail: 60
- Volume
 - Receiver: 32
 - Ringer for intercom call (Base unit): 33, 44
 - Ringer for intercom call (Handset): 33, 44
 - Ringer for outside call (Base unit): 33, 44
 - Ringer for outside call (Handset): 33, 44
 - Speaker: 32
- W** Wall mounting: 61

IMPORTANT!

If your product is not working properly. . .

- ① **Disconnect AC adaptor and remove batteries from base unit.**
- ② **Reconnect AC adaptor and reinsert batteries into base unit.**
- ③ **Check if telephone line cord is connected.**
- ④ **Use rechargeable Ni-MH batteries.**
(Alkaline/Manganese/Ni-Cd batteries CANNOT be used.)
- ⑤ Read **troubleshooting** page in the **Operating Instructions**.



Visit our Web site: <http://shop.panasonic.com/support>

- **FAQ and troubleshooting hints are available.**

For your future reference

We recommend keeping a record of the following information to assist with any repair under warranty.

Serial No.	Date of purchase
(found on the bottom of the base unit)	
Name and address of dealer	
Attach your purchase receipt here.	

Panasonic Corporation of North America

Two Riverfront Plaza, Newark, NJ 07102-5490

© Panasonic System Networks Co., Ltd. 2016

Printed in Malaysia



PNQX7794ZA

PNQX7794ZA PT0416YK0