



User Guide



HP ENVY Inspire 7200e series
HP ENVY Inspire 7900e series



HP ENVY Inspire 7200e series
HP ENVY Inspire 7900e series

SUMMARY

This guide provides configuration, use, and safety and environmental information.

HP company notices

Copyright and License

THE INFORMATION CONTAINED HEREIN IS SUBJECT TO CHANGE WITHOUT NOTICE.

ALL RIGHTS RESERVED. REPRODUCTION, ADAPTATION, OR TRANSLATION OF THIS MATERIAL IS PROHIBITED WITHOUT PRIOR WRITTEN PERMISSION OF HP, EXCEPT AS ALLOWED UNDER THE COPYRIGHT LAWS. THE ONLY WARRANTIES FOR HP PRODUCTS AND SERVICES ARE SET FORTH IN THE EXPRESS WARRANTY STATEMENTS ACCOMPANYING SUCH PRODUCTS AND SERVICES. NOTHING HEREIN SHOULD BE CONSTRUED AS CONSTITUTING AN ADDITIONAL WARRANTY. HP SHALL NOT BE LIABLE FOR TECHNICAL OR EDITORIAL ERRORS OR OMISSIONS CONTAINED HEREIN.

© Copyright 2021 HP Development Company, L.P.

Trademark Credits

Microsoft and Windows are either registered trademarks or trademarks of Microsoft Corporation in the United States and/or other countries.

Mac, OS X, macOS, and AirPrint are trademarks of Apple Inc., registered in the U.S. and other countries.

ENERGY STAR and the ENERGY STAR mark are registered trademarks owned by the U.S. Environmental Protection Agency.

Android and Chromebook are trademarks of Google LLC.

iOS is a trademark or registered trademark of Cisco in the U.S. and other countries and is used under license.

Safety information

Always follow basic safety precautions when using this product to reduce risk of injury from fire or electric shock.

- Read and understand all instructions in the documentation that comes with the printer.
- Observe all warnings and instructions marked on the product.
- Unplug this product from wall outlets before cleaning.
- Do not install or use this product near water, or when you are wet.
- Install the product securely on a stable surface.
- Install the product in a protected location where no one can step on or trip over the line cord, and the line cord cannot be damaged.
- If the product does not operate normally, see **Solve a problem** in this guide.
- There are no user-serviceable parts inside. Refer servicing to qualified service personnel.

Table of contents

1 Get started	1
Printer views	1
Printer front view	1
Printing supplies area	2
Printer back view	2
Control panel features	3
Tilt the control panel	3
Overview of buttons and lights	3
Function buttons	4
Dashboard icons	4
Change printer settings	5
To change settings for a function	5
To change the printer settings	5
Use the HP Smart app to print, scan, and manage	6
To install HP Smart and open the app	6
Get more information about HP Smart	7
Turn the printer off	7
2 Connect your printer	8
Requirements for HP+ printers	8
Keep the printer connected to the Internet	8
Use Original HP cartridges	8
Have an HP account	8
Connect your printer to a Wi-Fi network using HP Smart	8
Connect your printer to a Wi-Fi network using the printer control panel	9
Before you begin	9
To connect your printer to a Wi-Fi network using the printer control panel	9
Connect your printer using a USB cable	10
Change wireless settings	10
Wireless status of the printer	10
Turn on or off the wireless capability of the printer	10
To restore the printer to the original network settings	11
Change the connection type	11
USB to a wireless connection	11
Wireless to a USB connection	12
3 Load media and paper basics	13
Load paper	13
To load standard paper	13
To load legal paper (some models only)	15

To load an envelope	17
To load cards and photo paper	19
Load an original on the scanner glass	21
To load an original on the scanner glass	21
Load an original in the document feeder (some models only)	22
To load an original in the document feeder	22
Paper basics	23
Tips for selecting and using paper	23
4 Configure your printer	25
Use Web Services	25
Set up Web Services	25
Update the printer	26
Dynamic security enabled printers	26
To update the printer using the printer control panel	26
To enable the printer to automatically check for updates	26
To update the printer using the embedded web server (EWS)	26
Configure the printer using EWS	27
To access and use EWS	27
Configure IP network settings	29
Assign or change the system password using EWS	29
Change energy-conservation settings	30
5 Print	31
Print from a Windows computer	31
Print from a Mac computer	31
Print with mobile devices	32
Print while connected to same Wi-Fi network	32
Print without connecting to same Wi-Fi network (Wi-Fi Direct)	32
Tips for successful printing	33
Ink tips	33
Paper loading tips	34
6 Copy, Scan, and Mobile Fax	35
Copy from the printer	35
Scan using HP Smart (iOS/Android, Windows 10, and macOS)	35
Scan using the HP Scan software (Windows 7)	36
Scan using Webscan	36
To enable Webscan	36
To scan using Webscan	37
Tips for copy and scan success	37
Mobile Fax	37
Use Mobile Fax in the HP Smart app	37
7 Manage cartridges	39

Dynamic security enabled printers	39
Information on cartridges and the printhead	39
Some color ink is used even when printing with black cartridge only.....	40
Check the estimated ink levels	40
To check the estimated ink levels from the printer control panel	40
Order cartridges.....	40
Replace the cartridges.....	41
To replace the cartridges	41
Use single cartridge mode.....	44
Ink cartridge issues.....	44
Store printing supplies	46
Cartridge warranty information	46
8 Solve a problem	47
Jams and paper-feed issues	47
Clear a paper jam	47
Clear a print carriage jam.....	55
Learn how to avoid paper jams.....	55
Solve paper-feed problems	56
Printer is unable to print.....	57
Printing issues	57
Fix problems with HP+ printers not printing.....	58
Fix problems with page not printing (unable to print)	58
Fix print quality issues.....	59
Copy and scan issues	60
Network and connection issues.....	60
Fix wireless connection.....	60
Fix Wi-Fi Direct connection	61
Printer hardware issues.....	61
Understand printer reports	62
Printer status report	62
Network configuration page.....	62
Print quality report	62
Wireless test report	62
Web access test report.....	62
Solve Web Services problems.....	63
Maintain the printer	63
Clean the scanner glass	63
Clean the exterior	65
Clean the document feeder (some models only)	65
Maintain the printhead and cartridges.....	66
Restore original factory defaults and settings	67
To restore the selected printer functions to the original factory settings	67
To restore the printer to the original factory defaults.....	67

To restore the printer to the original network settings	68
To use Cold Reset to restore settings	68
HP support	69
Contact HP.....	69
Register printer	70
Additional warranty options.....	70
9 HP EcoSolutions (HP and the Environment)	71
Power Management.....	71
Sleep mode	71
Auto-off.....	71
Schedule On and Off.....	71
Quiet Mode	72
To turn Quiet Mode on or off from the printer control panel	72
To create a schedule for Quiet Mode from the printer control panel.....	72
To turn Quiet Mode on or off from EWS.....	72
Optimize Printing Supplies	73
Appendix A Technical information	74
Specifications.....	74
Regulatory notices.....	76
Regulatory Model Number.....	76
FCC statement	76
Notice to users in Korea	76
VCCI (Class B) compliance statement for users in Japan.....	77
Power cord instructions.....	77
Notice to users in Japan about the power cord	77
Noise emission statement for Germany.....	77
European Union and United Kingdom Regulatory Notice	77
Products with wireless functionality.....	77
Visual display workplaces statement for Germany	78
Notice to users of the U.S. telephone network: FCC requirements.....	78
Notice to users of the Canadian telephone network.....	79
Notice to users of the German telephone network.....	80
Australia wired fax statement	80
Regulatory information for wireless products	80
Dynamic security enabled printers.....	82
Accessibility	83
Environmental product stewardship program.....	83
HP tips for reducing environmental impact	83
Eco-Tips.....	84
Paper	84
Plastics.....	84
European Union Commission Regulation 1275/2008.....	84
Safety data sheets	84
Chemical substances	84
EPEAT	84

SEPA Ecolabel User Information (China).....	84
Recycling program.....	84
HP inkjet supplies recycling program.....	85
Battery disposal in Taiwan.....	85
California Perchlorate Material Notice	85
European Union Battery Directive	85
Battery notice for Brazil.....	85
Power consumption.....	85
China Energy Label for Printer, Fax and Copier	86
Disposal of waste equipment by users	86
Waste disposal for Brazil	87
The Table of Hazardous Substances/Elements and their Content (China)	87
Regulation on the Control of Waste Electrical and Electronic Equipment (Turkey)	88
Restriction of hazardous substance (India).....	88
Declaration of the Presence Condition of the Restricted Substances Marking (Taiwan)	88

1 Get started

This section describes the printer parts, control panel features, and other printer functionalities.

Printer views

This topic describes the printer front views, printing supplies area, and printer back view.

Printer front view

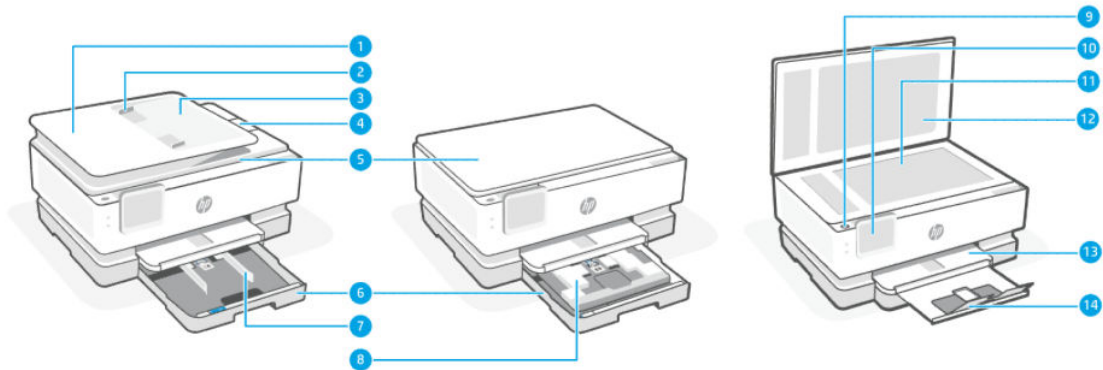

Table 1-1 Printer front view

Feature	Description
1	Document feeder
2	Document feeder paper-width guides
3	Document feeder tray
4	Document feeder output extension
5	Scanner lid
6	Main tray
7	Paper-width guides
8	Photo tray
9	Power button
10	Control panel display
11	Scanner glass
12	Scanner lid backing
13	Output tray
14	Output tray extension

Printing supplies area

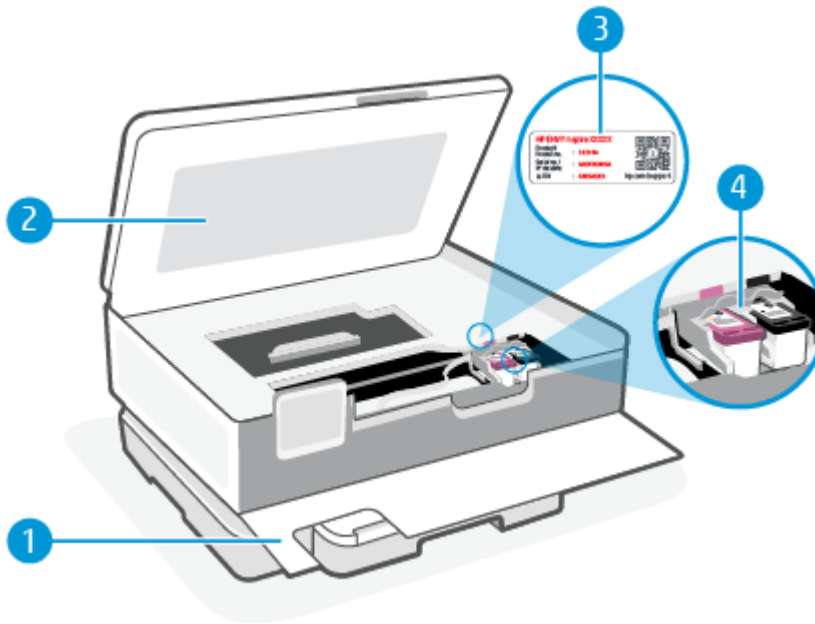

Table 1-2 Printing supplies area

Feature	Description
1	Front door
2	Cartridge access door
3	PIN code label
4	Cartridges



NOTE: Cartridges should be kept in the printer to prevent possible print quality issues or printhead damage. Avoid removing supplies for extended periods of time. Do not turn the printer off when a cartridge is missing.

Printer back view

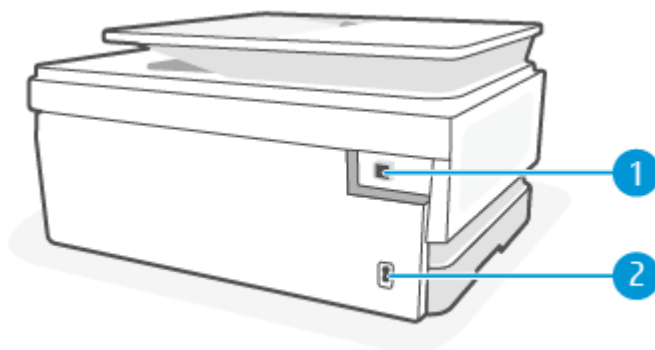

Table 1-3 Printer back view

Feature	Description
1	Rear USB port NOTE: A label is covering the USB port on this printer. Use the HP Smart app and a network connection to set up your printer and receive the HP+ offer. After setup, you can print using a USB cable connection, if desired, but the printer must also still be connected to the Internet if you have enabled HP+.
2	Power connection

Control panel features

This topic describes the printer control panel features.

Tilt the control panel

Tilt the control panel for easier viewing. Push the upper part of the control panel to tilt it upwards and push the lower part to tilt it downwards.

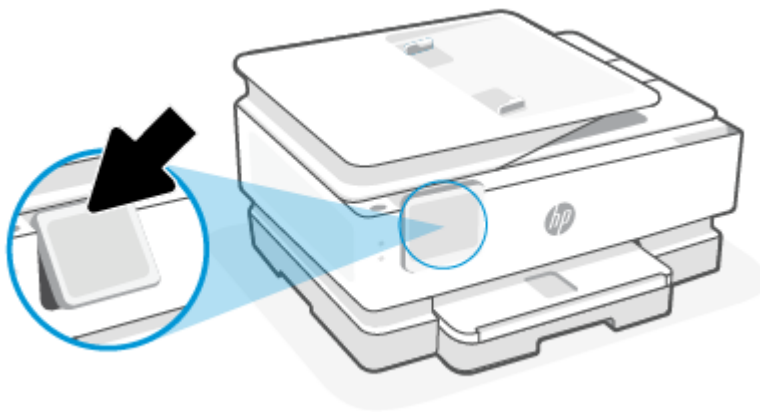

Overview of buttons and lights

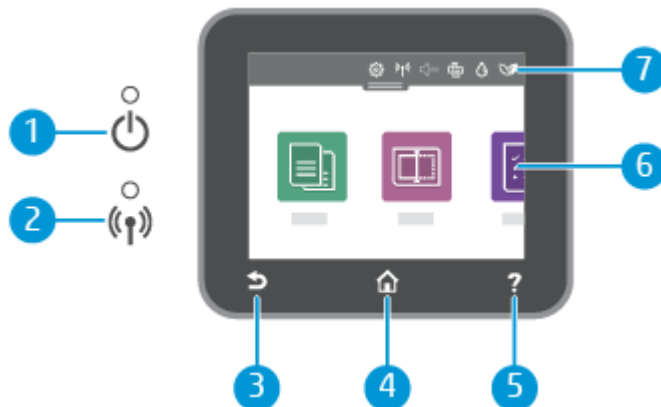

Table 1-4 Control panel overview

Feature	Description
1	Power light: Indicates whether the printer is turned on.
2	Wireless light: Indicates the status of the printer's wireless connection. <ul style="list-style-type: none"> • Solid blue light indicates that wireless connection has been established and you can print. • Slow blinking light with clear pause indicates that wireless is on, but not configured. To connect your printer, see Connect your printer. • Slow blinking light indicates that wireless is on, but the printer is not connected to a network. Make sure your printer is within the range of wireless signal. • Fast blinking light indicates wireless error. Refer to the message on the printer display. • If the wireless light is off, wireless is turned off.
3	Back button: Returns to the previous menu.
4	Home button: Returns to the home screen from any other screen.
5	Help button: Opens the Help menu when on the Home screen, or shows contextual help content if it is available for the current operation when on other screens.
6	Function buttons: Touch to perform common tasks. For more information, see Function buttons .
7	Dashboard: Swipe down for additional printer management options. For more information, see Dashboard icons .

Function buttons

Table 1-5 Function buttons

Feature	Description
Copy 	Copy document, ID card, or photo.
Scan 	Scan document.

Dashboard icons

The Dashboard on the printer control panel lets you access the icons on the display, check the status of the printer, or monitor and manage current and scheduled printer tasks.







To open the Dashboard, touch or swipe down the tab  at the top of a screen on the control panel.



Table 1-6 Dashboard icons

Feature	Description
Setup 	Setup displays the setup screen for changing preferences, network setup, Wi-Fi Direct, and other maintenance settings and generating reports.
Wireless 	Wireless displays wireless status and menu options. For more information, see Connect your printer to a Wi-Fi network using the printer control panel .
Quiet mode (if supported) 	Quiet Mode slows down printing to reduce overall noise without affecting print quality. Quiet Mode only works when printing on plain paper. To reduce printing noise, turn on Quiet Mode. To print at normal speed, turn Quiet Mode off. Quiet Mode is off by default.
Wi-Fi Direct 	Wi-Fi Direct displays the status, name, and password for Wi-Fi Direct, and the number of devices connected. You can also change settings and print a guide. NOTE: HP+ printers must remain connected to the Internet through Wi-Fi in order to function.
Ink Status 	Ink Status displays the estimated ink levels. NOTE: Ink level alerts and indicators provide estimates for planning purposes only. When you receive a low-ink alert, consider having a replacement cartridge available to avoid possible printing delays. You do not have to replace the cartridges until prompted to do so.
HP EcoSolutions 	HP EcoSolutions displays a screen where you can configure some of the printer's environmental features.

Change printer settings

Use the control panel to change the printer functions and settings, print reports, or get help for the printer.

 **TIP:** You can also change the printer settings using the printer software. For more information, see [Print](#).

To change settings for a function

The **Home** screen of the control panel display shows the available functions for the printer. Some features of the functions allows you to change settings.



1. Select **Copy** or **Scan** and then select the desired option.
2. After selecting a function, touch **Settings** , scroll through the available settings, and then touch the setting you want to change.
3. Follow the prompts on the control panel display to change the settings.

 **TIP:** Touch the **Home**  to return to the **Home** screen.

To change the printer settings

To change the printer settings or print reports, use the options available on the **Setup** menu.

1. From the printer control panel, touch or swipe down the tab at the top of the screen to open the Dashboard, and then touch **Setup** .
2. Touch and scroll through the screens.
3. Touch the screen items to select screens or options.

 **TIP:** Touch **Home**  to return to the **Home** screen.

Use the HP Smart app to print, scan, and manage

The HP Smart app can help you perform many different printer tasks, including the following:

- Set up and connect your printer.
- Print and scan documents and photos.
- Share documents through email and other applications.
- Manage printer settings, check printer status, print reports, and order supplies.

HP Smart is supported on mobile devices and computers running on iOS, Android, Windows 10, and macOS 10.13 and later.

 **NOTE:** At this time, the HP Smart app might not be available in all languages. Some features are available only on specific printers or models. HP Smart does not support all file formats. For more information, see [Get more information about HP Smart](#).

To install HP Smart and open the app

Complete the following steps to install and open HP Smart, connect your printer, and begin using the app.

1. Visit 123.hp.com to download and install HP Smart on your device.

 **NOTE:**

- **iOS, Android, Windows 10, and macOS devices:** You can also download HP Smart from the respective app stores for the device.
 - **Windows 7:** You can download the HP printer software from 123.hp.com, install the software, and connect the printer wirelessly using the software. (Windows 7 Service Pack 1 (SP1) is required to install HP printer software.)
-
2. Open HP Smart after installation.
 - **iOS/Android:** From the mobile device desktop or app menu, tap HP Smart.
 - **Windows 10:** From the computer desktop, click **Start**, and then select **HP Smart** from the app list.
 - **macOS:** From the Launchpad, select HP Smart.
 3. Connect your printer wirelessly using HP Smart. For more information, see [Connect your printer to a Wi-Fi network using HP Smart](#).
 4. When prompted, create an HP account and register the printer.

Get more information about HP Smart

To learn how to connect, print, and scan using HP Smart, visit the website for your device:

- **iOS/Android:** hp.com/go/hpsmart-help
- **Windows 10:** hp.com/go/hpsmartwin-help
- **macOS:** hp.com/go/hpsmartmac-help

Turn the printer off

Press the Power button  to turn off the printer. Wait until the power light turns off before unplugging the power cord or turning off a power strip.

⚠ CAUTION: If you incorrectly turn the printer off, the print carriage might not return to the correct position, causing problems with the cartridges and print quality issues.

2 Connect your printer

This section describes different ways to connect your printer.

Requirements for HP+ printers

This topic describes the requirements for HP+ printers.

Keep the printer connected to the Internet

HP+ printers are cloud-connected devices that must remain connected to the Internet in order to function. The Internet connection enables the printer to deliver HP+ specific app features and firmware updates.

During setup, you must connect the printer to the Internet using a supported network connection. After setup, you can print using a USB cable connection, if desired, but the printer must still be connected to the Internet.

Use Original HP cartridges

Original HP cartridges are cartridges manufactured and sold by HP in official HP packaging. If non-Original HP supplies or refilled cartridges are installed, HP+ printers will not operate as expected.

Have an HP account

Create or sign into an HP account to manage your printer.

Connect your printer to a Wi-Fi network using HP Smart

This topic describes how to connect your printer to a Wi-Fi network using HP Smart.

Install the HP Smart app on your computer or mobile device and use the app to set up or connect the printer to your Wi-Fi network.

For information about HP Smart including where to download the app, see [Use the HP Smart app to print, scan, and manage](#).

1. Make sure your computer or mobile device is connected to your Wi-Fi network. On your mobile device, turn on Bluetooth and location services.



NOTE: HP Smart uses Bluetooth for printer setup, and it does not support Print using Bluetooth.

2. If your printer Wi-Fi was previously turned off, make sure to turn it on. For more information about wireless status, see [Turn on or off the wireless capability of the printer](#).
3. If the printer is no longer in wireless setup mode, restore the printer network settings. For more information, see [To restore the printer to the original network settings](#).



NOTE: The wireless light will blink when the printer is in wireless setup mode.

4. Open the HP Smart app on your computer or mobile device. For more information, see [Use the HP Smart app to print, scan, and manage](#).

5. From HP Smart, click or touch the Plus icon **+** or **Add Printer**, and then choose the option to select or add a printer. If prompted, allow Bluetooth and location permissions.

Follow the instructions to add the printer to your network.

6. When prompted, create an HP account and register the printer.



NOTE: When the printer is connected successfully, the Wireless light stops blinking and remains lit (for all Wireless models). For more information, see [Printer views](#).

Connect your printer to a Wi-Fi network using the printer control panel

This topic describes how to connect your printer to a Wi-Fi network using the printer control panel.

Before you begin

Ensure the following before you begin setting up the printer for wireless communication:

- The wireless network is set up and working properly.
- The printer and the computers that use the printer are on the same network (subnet).



NOTE: While connecting the printer, you might be prompted to enter the wireless network name (SSID) and a wireless password.

- The wireless network name is the name of your wireless network.
- The wireless password prevents other people from connecting to your wireless network without your permission. Depending on the level of security required, your wireless network might use either a WPA passphrase or WEP key.

If you have not changed the network name or the security passkey since setting up your wireless network, you can sometimes find them on the back or side of the wireless router.

If you cannot find the network name or the security password or cannot remember this information, see the documentation provided with your computer or with the wireless router. If you still cannot find this information, contact your network administrator or the person who set up the wireless network.

To connect your printer to a Wi-Fi network using the printer control panel

Use the Wireless Setup Wizard or Wi-Fi Protected Setup from the printer control panel display to set up wireless communication.



NOTE: Before you proceed, go through the list at [Before you begin](#).

1. From the printer control panel, touch or swipe down the tab at the top of the screen to open the Dashboard, and then touch **Wireless** .
2. Touch **Settings** .
3. Touch **Wireless Settings**.

4. Touch **Wireless Setup Wizard** or **Wi-Fi Protected Setup**.
5. Follow the display instructions to complete the setup.

If you are already using the printer with a different type of connection, such as a USB connection, follow the instructions in [Change the connection type](#) to set up the printer on your wireless network.

Connect your printer using a USB cable



NOTE:

- Do not connect the printer with a USB cable when setting up for the first time. HP+ printer will not work as expected if USB is used for setting up for the first time.
- To set up and use the printer, it must be connected to the Internet at all times.

See the requirements listed in [Requirements for HP+ printers](#).

1. If necessary, remove the label covering the USB port at the back of the printer.
2. Connect the printer and computer using a USB cable.
3. Open the HP Smart app on your computer. For more information, see [Use the HP Smart app to print, scan, and manage](#).
4. From HP Smart, click or tap the Plus icon **+** or **Add Printer**, and then choose the option to select or add a printer.



Follow the instructions to add the printer.
5. When prompted, create an HP account and register the printer.

Change wireless settings

You can set up and manage the wireless connection for your printer. This includes printing information about network settings, turning the wireless function on or off, and restoring wireless settings.



Wireless status of the printer

Print the wireless test report for information about the printer wireless connection. The wireless test report provides information about the printer status, hardware (MAC) address, and IP address. If there is a problem with the wireless connection or if a wireless connection attempt failed, the wireless test report also provides diagnostic information. If the printer is connected to a network, the test report displays details about the network settings.

1. From the printer control panel, touch or swipe down the tab at the top of the screen to open the Dashboard, touch **Wireless** , and then touch **Settings** .
2. Touch **Print Details** or **Print Network Configuration**.

Turn on or off the wireless capability of the printer

The blue Wireless light on the printer control panel is lit when the wireless capability of the printer is on.

1. From the printer control panel, touch or swipe down the tab at the top of the screen to open the Dashboard, touch **Wireless** , and then touch **Settings** .
2. Touch **Wireless Settings**.
3. Touch the toggle button next to **Wireless** to switch it on or off.

 **NOTE:** If the printer has never been configured to connect to a wireless network before, turning on the wireless capability will automatically start the Wireless Setup Wizard.

To restore the printer to the original network settings

1. From the printer control panel, touch or swipe down the tab at the top of the screen to open the Dashboard, and then touch **Setup** .
2. Touch **Network Setup**.
3. Touch **Restore Network Settings**.
A message appears stating that the network defaults will be restored.
4. Touch **Yes**.
5. Print the network configuration page and verify that the network settings have been reset.

 **NOTE:** In order to get the list of detected wireless networks in the area, the wireless radio on the printer should be turned on. If it is off, the list is not displayed.

 **TIP:** You can visit the HP online support website at hp.com/support for information and utilities that can help you correct many common printer problems.

Use [HP Print and Scan Doctor](#) to automatically diagnose and resolve issues. If you are using Windows 10, you can run the HP Print and Scan Doctor from HP Smart.

Change the connection type

This topic describes how to change the way to connect your printer.

USB to a wireless connection

Windows 10/macOS

1. Unplug the USB cable from the printer.
2. Make sure your computer or mobile device is connected to your Wi-Fi network. On your mobile device, turn on Bluetooth and location services.
3. If your printer Wi-Fi was previously turned off, make sure to turn it on. For more information about wireless status, see [Turn on or off the wireless capability of the printer](#).
4. If the printer is no longer in wireless setup mode, restore the printer network settings. For more information, see [To restore the printer to the original network settings](#).
5. Open the HP Smart app on your computer or mobile device. For more information, see [Use the HP Smart app to print, scan, and manage](#).

6. When prompted, create an HP account and register the printer.
7. Follow the on-screen instructions to connect the printer to your Wi-Fi network.

Wireless to a USB connection

Windows/macOS



NOTE: Always maintain an Internet connection. For the printer to work properly (whether you are using a Wi-Fi or USB connection), it must always be connected to the Internet. For more information, see [Use the HP Smart app to print, scan, and manage](#).

1. If necessary, remove the label covering the USB port at the back of the printer.
2. Connect the printer and computer using a USB cable.
3. Open the HP Smart app on your computer. For more information, see [Use the HP Smart app to print, scan, and manage](#).
4. From HP Smart, click or tap the Plus icon **+** or **Add Printer**, and then choose the option to select or add a printer. Follow the on-screen instructions to add the printer.
5. When prompted, create an HP account and register the printer.

3 Load media and paper basics

This section describes how to change paper settings and to load different media into the printer.

Load paper

This topic describes how to load paper, envelope, cards and photos.

 **NOTE:**

- Do not load paper while the printer is printing.
 - If there is other paper in the printer tray, remove the paper before loading a different paper type or size.
-

To load standard paper

1. Open the main tray.

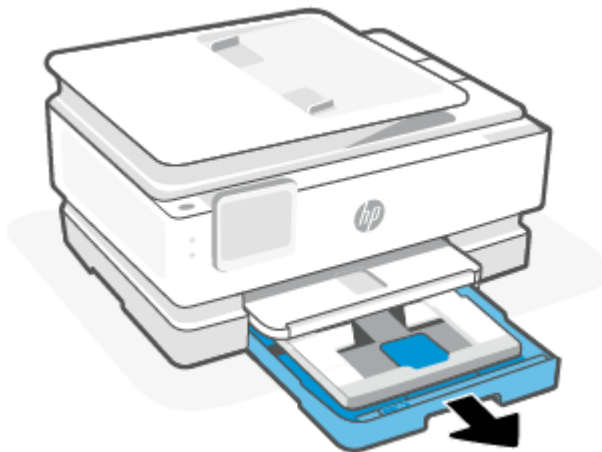

2. Push in the photo tray.



3. Slide the paper-width guides to the edges of the main tray.



4. Insert the paper in portrait orientation with the side to be printed facing down. Make sure the stack of paper is aligned with the appropriate paper size lines on the front of the tray.

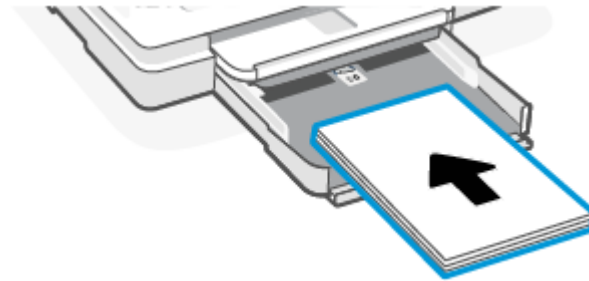

5. Adjust the paper-width guides until they touch the left and right edges of the stack of paper.

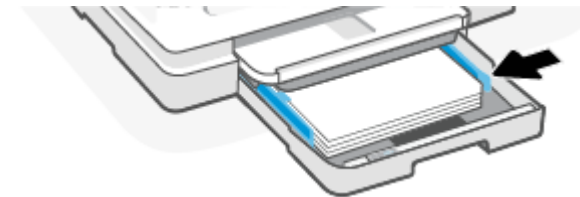

6. Close the main tray.

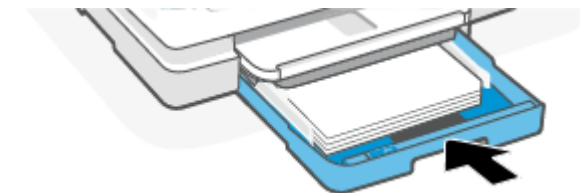

7. Change or retain the paper settings on the printer display.

8. Pull out the output tray extension.

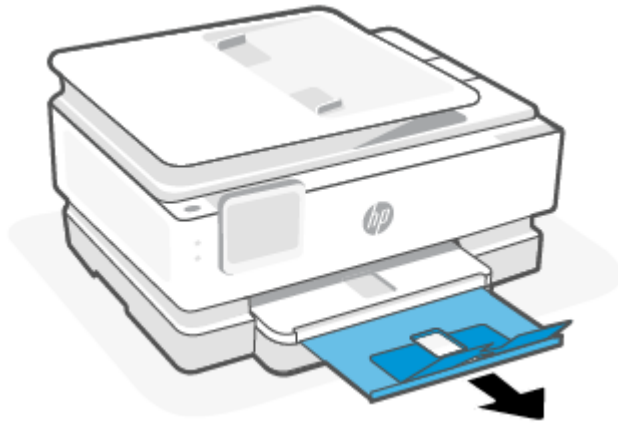

To load legal paper (some models only)

1. Open the main tray.

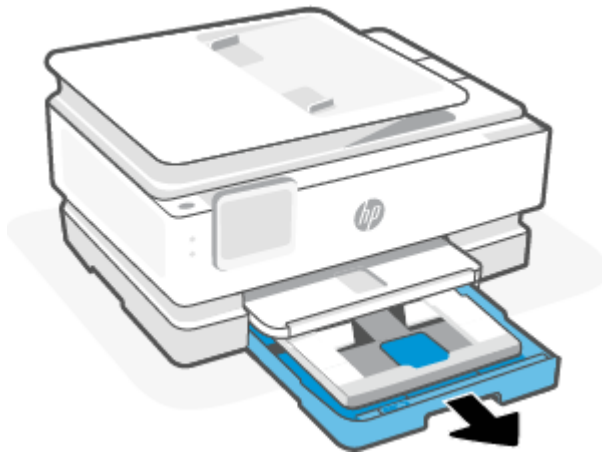

2. Push in the photo tray.



3. Slide the paper-width guides to the edges of the main tray.



4. Unlock and then open the front side of the paper tray.

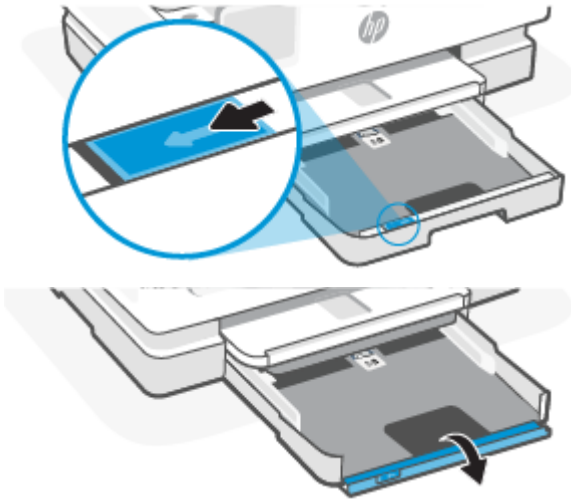

5. Insert the paper in portrait orientation with the side to be printed facing down.

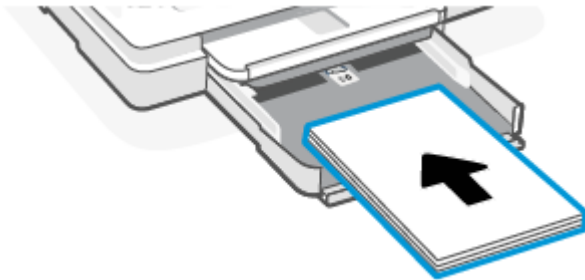

Make sure the stack of paper is aligned with the appropriate paper size lines on the front of the tray.

6. Adjust the paper-width guides until they touch the left and right edges of the stack of paper.

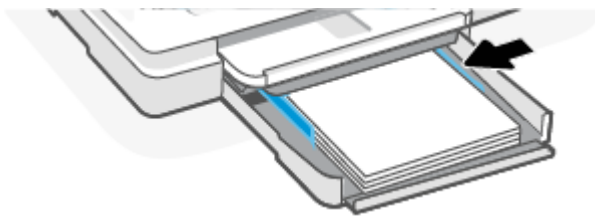

7. Close the main tray.

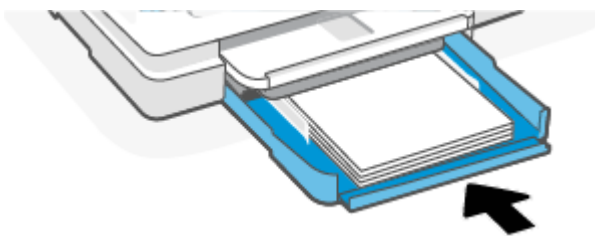

8. Change or retain the paper settings on the printer display.

9. Pull out the output tray extension.

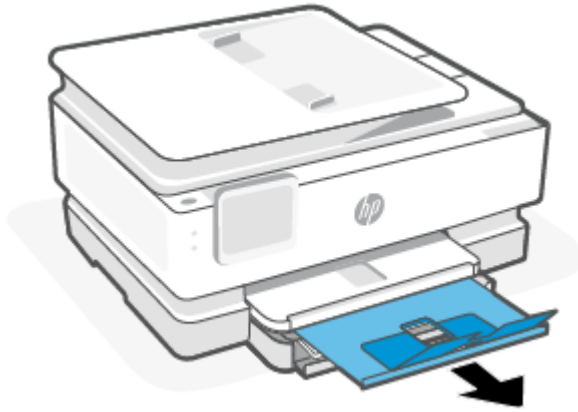

To load an envelope

1. Open the main tray.

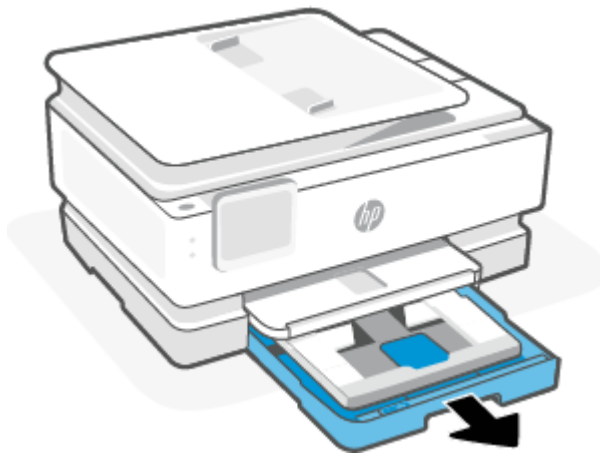

2. Push in the photo tray.

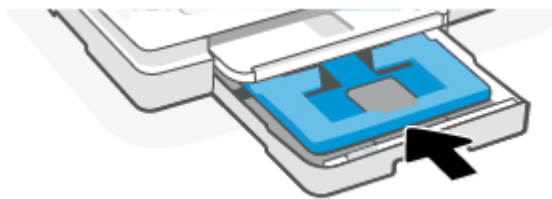

3. Slide the paper-width guides to the edges of the main tray.



4. Insert the envelope in portrait orientation and with the side to be printed facing down.



For information on the maximum number of envelope allowed in the tray, see [Specifications](#).

5. Adjust the paper-width guides until they touch the left and right edges of the stack of envelope.

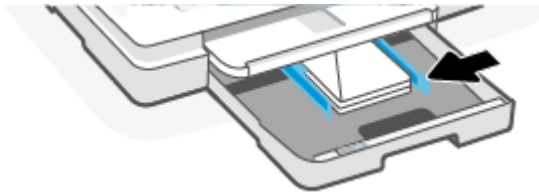

6. Close the main tray.

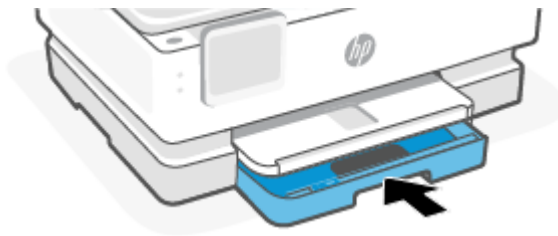

7. Change or retain the paper settings on the printer display.

8. Pull out the output tray extension.

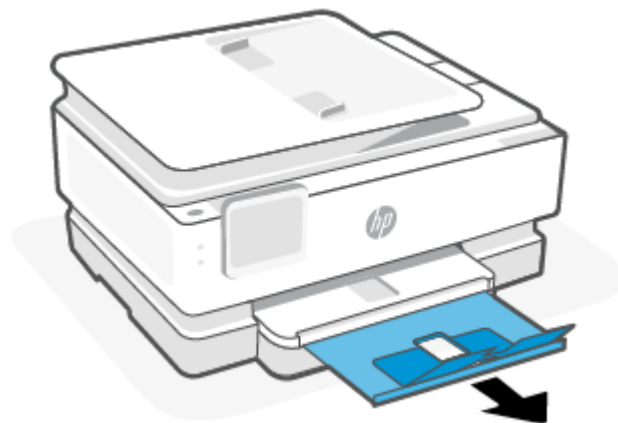

To load cards and photo paper

1. Open the main tray.

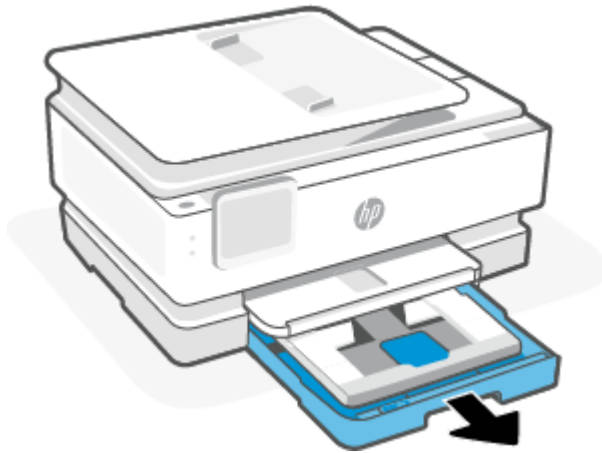

 **NOTE:**

- Remove the paper before loading a different paper type or size.
 - For printing on panoramic photo paper (4 x 12 inches), load photo paper in the main tray.
-

2. Pull out the photo tray, if necessary.



3. Slide the paper-width guides to the edges of the photo tray.



4. Insert the cards or photo paper in portrait orientation and with the side to be printed facing down.

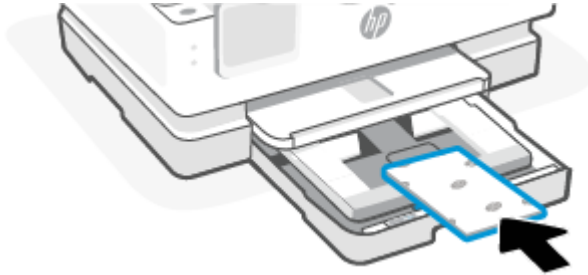

Make sure the stack of card or photo is aligned with the appropriate paper size lines on the front of the tray.

5. Adjust the paper-width guides until they touch the left and right edges of the stack of paper.



6. Close the main tray.

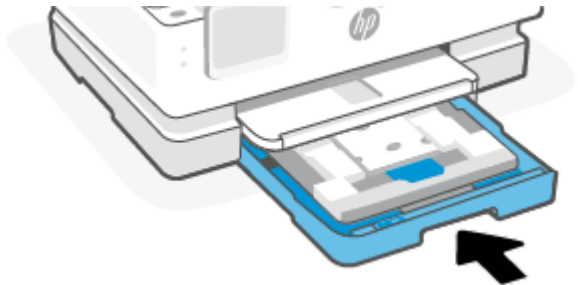

7. Change or retain the paper settings on the printer display.

8. Pull out the output tray extension.

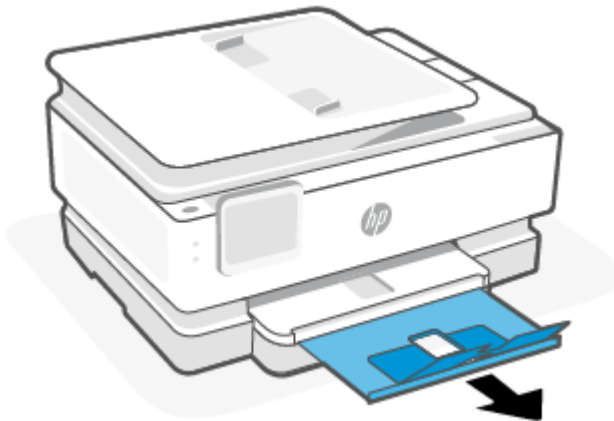

Load an original on the scanner glass

This topic describes how to load an original into the printer.

 **NOTE:**

- The scanner might not work correctly if the scanner glass and lid backing are not clean. For more information, see [Maintain the printer](#).
 - Remove all originals from the document feeder tray (some models only) before lifting the lid on the printer.
-

To load an original on the scanner glass

1. Lift the scanner lid.



2. Load your original print-side down and align it with the marking on the rear left corner of the glass.

 **TIP:** For more help on loading an original, refer to the engraved guides along the edge of the scanner glass.

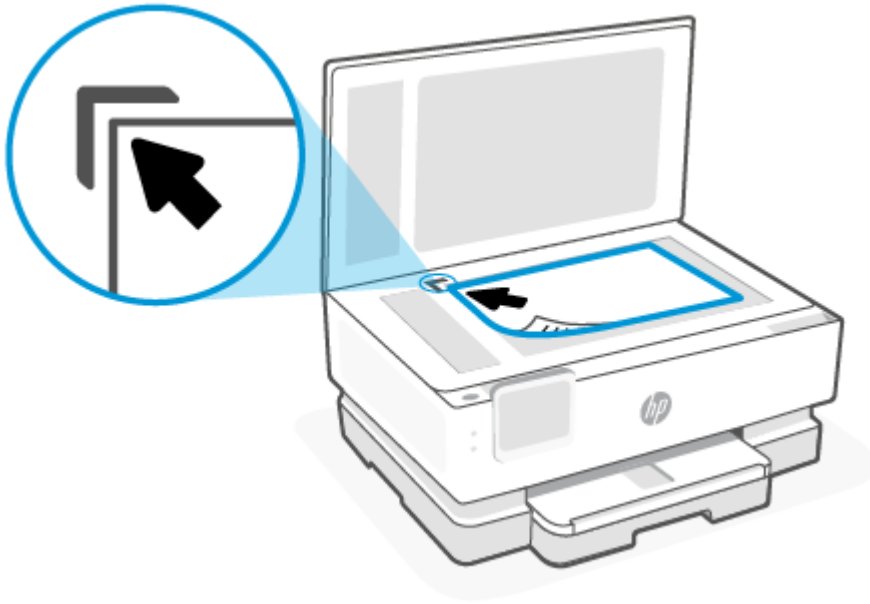

3. Close the lid.

Load an original in the document feeder (some models only)

You can copy or scan a document by placing it in the document feeder.

CAUTION: Do not load photos in the document feeder, this might cause damage to your photos. Use only paper that is supported by the document feeder.

NOTE: Some features, such as the **Fit to Page** copy feature, do not work when you load your originals in the document feeder. For those features to work, load your originals on the scanner glass.

To load an original in the document feeder

1. Load your original print-side up into the document feeder.
 - a. If you are loading an original printed in portrait orientation, place the pages so that the top edge of the document goes in first. If you are loading an original printed in landscape orientation, place the pages so that the left edge of the document goes in first.
 - b. Slide the paper into the document feeder until you hear a tone or see a message on the printer control panel display indicating that the loaded pages were detected.

TIP: For more help on loading originals in the document feeder, refer to the diagram on the document feeder tray.

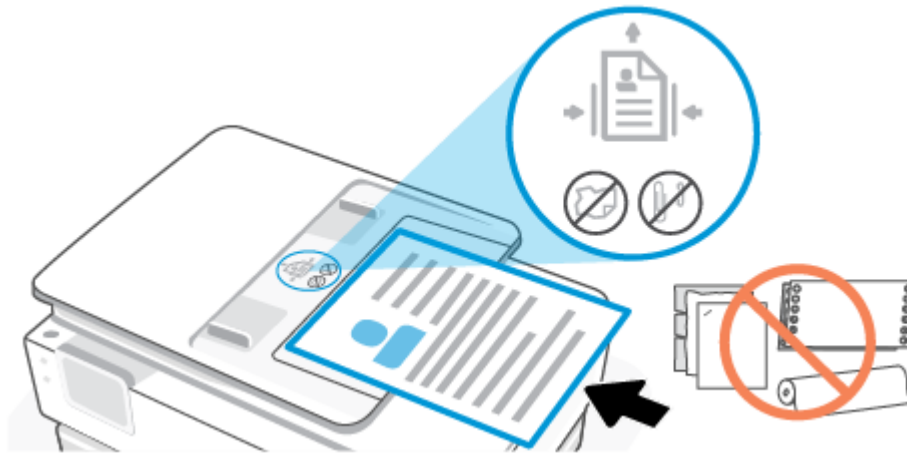

2. Slide the paper-width guides inward until they stop at the left and right edges of the paper.

Paper basics

The printer is designed to work well with most types of office paper. It is best to test a variety of print paper types before buying large quantities.

Use HP paper for optimum print quality. Visit the HP website at www.hp.com for more information about HP paper.



HP recommends plain papers with the ColorLok logo for printing everyday documents. All papers with the ColorLok logo are independently tested to meet high standards of reliability and print quality, and produce documents with crisp, vivid color, bolder blacks, and that dry faster than ordinary plain papers. Look for papers with the ColorLok logo in a variety of weights and sizes from major paper manufacturers.

Tips for selecting and using paper

For the best results, observe the following guidelines.

- Load only one type and one size of paper at a time into a tray or document feeder.
- Make sure the paper is loaded correctly when loading from the main tray or document feeder.
- Do not overload the tray or document feeder.
- To prevent jams, poor print quality, and other printing problems, avoid loading the following paper in the tray or document feeder:
 - Multipart forms
 - Media that is damaged, curled, or wrinkled
 - Media with cutouts or perforations

- Media that is heavily textured, embossed, or does not accept ink well
- Media that is too lightweight or stretches easily
- Media that contains staples or clips

4 Configure your printer

This section describes how to configure your printer.

Use Web Services

The printer offers innovative, cloud-based solutions, such as print anywhere, scan-and-save to cloud, and other services (including supplies auto replenishment).

For more information, visit the HP Smart website hpsmart.com.

 **NOTE:** To use these cloud-based solutions, the printer must be connected to the Internet. Unless otherwise agreed, HP can modify or cancel these cloud-based solution offerings at its discretion.

Set up Web Services

Before you set up Web Services, make sure your printer is connected to the Internet using a wireless connection.

To set up Web Services

1. Before you set up Web Services, make sure your printer is connected to the Internet.
2. Open the printer home page (the embedded web server or EWS). For more information, see [To access and use EWS](#).
3. Click the **HP Web Services** tab.
4. In **Web Services Settings**, click **Enable**, and follow the on-screen instructions to accept the terms of use.
5. If prompted, choose to allow the printer to check for and install printer updates.

-
-  **NOTE:**
- If prompted for a password, enter the PIN from the label on your printer. For more information, see [Things to note when accessing EWS](#).
 - If prompted for proxy settings and if your network uses proxy settings, follow the on-screen instructions to set up a proxy server. If you do not have the details, contact your network administrator or the person who set up the network.
 - If a printer update is available, the printer downloads and installs the update and then restarts automatically. Repeat the instructions above to set up **HP Web Services**.
-

6. After the printer is connected to the HP server, the printer prints an information sheet. Follow the instructions on the information sheet to finish setting up Web Services.

Update the printer

HP periodically releases firmware updates to enhance product functionality and fix issues. By default, if the printer is connected to the Internet, the printer automatically checks for updates at regular intervals. You can change the default setting for automatic updates or manually check for updates immediately.

Dynamic security enabled printers

This printer is intended to work only with cartridges that have new or reused HP electronic circuitry. Reused HP electronic circuitry enables the use of reused, remanufactured, and refilled cartridges.

The printer uses dynamic security measures to block cartridges using modified or non-HP circuitry. Periodic firmware updates delivered over the internet will maintain the effectiveness of the dynamic security measures and block cartridges that previously worked.

Updates can improve, enhance, or extend the printer's functionality and features, protect against security threats, and serve other purposes, but these updates can also block cartridges using modified or non-HP electronic circuitry from working in the printer, including cartridges that work today. Unless you are enrolled in certain HP programs such as Instant Ink or use other services that require automatic online firmware updates, most HP printers can be configured to receive updates either automatically or with a notification that allows you to choose whether to update or not. For more information on dynamic security and how to configure online firmware updates, please go to www.hp.com/learn/ds.

To update the printer using the printer control panel

1. From the top of the screen, touch or swipe down the tab to open the Dashboard, touch **Setup** .
2. Touch **Printer Maintenance**.
3. Touch **Update the Printer**.
4. Touch **Check for Printer Updates Now**.

To enable the printer to automatically check for updates



NOTE: The default setting of **Auto Update** is **On**.

1. From the printer control panel, touch or swipe down the tab at the top of the screen to open the Dashboard, and then touch **Setup** .
2. Touch **Printer Maintenance**.
3. Touch **Update the Printer**.
4. Touch **Printer Update Options**.
5. Select **Install Automatically (Recommended)**, **Alert When Available** or **Do Not Check**.

To update the printer using the embedded web server (EWS)

1. Open the EWS. For more information, see [To access and use EWS](#).
2. Click the **Tools** tab.
3. In the **Printer Updates** section, click **Firmware Updates**, and then follow the onscreen instructions.



NOTE:

- If prompted for a password, enter the PIN from the label on your printer. The PIN label can be found inside the cartridge access area.
 - If prompted for proxy settings and if your network uses proxy settings, follow the onscreen instructions to set up a proxy server. If you do not have the details, contact your network administrator or the person who set up the network.
 - If a printer update is available, the printer downloads and installs the update, and then restarts.
-

Configure the printer using EWS

Use EWS to manage printing functions from your computer.

- View printer status information
- Check the information and status of the printing supplies
- Receive notification of printer and supplies events
- View and change the network and the printer settings

To access and use EWS

You can open EWS using one of the following:

- HP Smart app
- HP printer software
- Web browser using IP address
- Web browser using Wi-Fi Direct connection

Things to note when accessing EWS

- If the web browser displays a message indicating that the website is unsafe, select the option to continue. Accessing the website will not harm your device.
- If prompted, enter the password of the printer.
 - **Password:** Open the cartridge access door, see the label inside the printer.

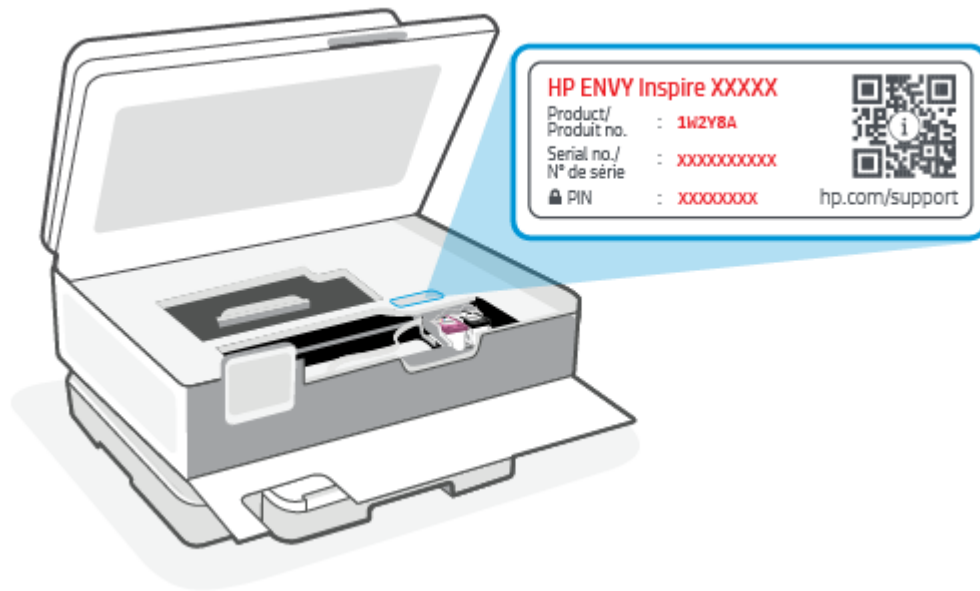

- Depending on how the printer is connected, some features in EWS might not be available.
- EWS is not accessible beyond the network firewall.

To open EWS using HP Smart (iOS, Android, and Windows 10)

1. Open the HP Smart app on your computer or mobile device. For more information, see [Use the HP Smart app to print, scan, and manage](#).
2. From HP Smart, select your printer, and then click or tap **Advanced Settings**.

To open EWS using an IP address (Wi-Fi connection)

1. Find out the IP address of the printer. From the printer control panel, touch or swipe down the tab at the top of the screen to open the Dashboard, touch **Wireless** (📶), and then touch **Settings** (⚙️).
2. Open a web browser, type the IP address or hostname in the address bar, and then click or tap **Enter**.

To open EWS using an IP address (Wi-Fi Direct connection)

1. Make sure your device and the printer are connected using Wi-Fi Direct. For more information, see [Print without connecting to same Wi-Fi network \(Wi-Fi Direct\)](#).
2. Open a web browser, type the following IP address or hostname of the printer in the address bar, and then click or tap **Enter**.

IP Address: 192.168.223.1

To open EWS using HP Printer software (Windows 7)

1. From the computer desktop, click **Start**, select **All Programs**, click **HP**, click the folder for the printer, select the icon with the printer's name, and then open **HP Printer Assistant**.
2. In the **HP Printer Assistant**, select **Print** tab.

3. Select **Printer Home Page (EWS)**.

Configure IP network settings

Use the following sections to configure the printer network settings.

View or change network settings

Use EWS to view or change IP configuration settings.

1. Open EWS. For more information, see [To access and use EWS](#).
2. Click the **Networking** tab to obtain network information. Change settings as needed.

Rename the printer on a network

To rename the printer on a network so that it can be uniquely identified, use the Embedded Web Server.

1. Open EWS. For more information, see [To access and use EWS](#).
2. Open the **System** tab.
3. On the **Device Information** page, the default printer name is in the **Device Description** field. You can change this name to uniquely identify this printer.



NOTE: Completing the other fields on this page is optional.

4. Click the **Apply** button to save the changes.

Manually configure IPv4 TCP/IP parameters

Use EWS to manually set an IPv4 address, subnet mask, and default gateway.

1. Open EWS. For more information, see [To access and use EWS](#).
2. On the **Networking** tab, click **IPv4 Configuration** in the left navigation pane.
3. From the **IP Preferred Address Method** drop-down, select **Manual**, and then edit the IPv4 configuration settings.
4. Click the **Apply** button.

Assign or change the system password using EWS

Assign an administrator password for access to the printer and EWS so that unauthorized users cannot change the printer settings.

1. Open EWS. For more information, see [To access and use EWS](#).
2. On the **System** tab, click the **Administration** link in the left navigation pane.
3. In the area labeled **Product Security**, enter the password in the **Password** field.
4. Re-enter the password in the **Confirm Password** field.

5. Click the **Apply** button.



NOTE: Make note of the password and store it in a safe place.

Change energy-conservation settings

The printer includes several economy features to conserve energy and supplies.

Set the Sleep/Auto Off After Inactivity setting

Use EWS to set the amount of idle time before the printer enters sleep mode.

Complete the following procedure to change the Sleep/Auto Off After Inactivity setting:

1. Open EWS. For more information, see [To access and use EWS](#).
2. Click the **System** tab, and then select **Energy Settings**.
3. From the **Sleep/Auto Off After Inactivity** drop-down, select the time for the delay.
4. Click the **Apply** button.

Set the Shut Down After Inactivity delay and configure the printer to use 1 watt or less of power

Use EWS to set the amount of time before the printer shuts down.



NOTE: After the printer shuts down, the power consumption is 1 watt or less.

Complete the following procedure to change the Shut Down After Inactivity setting:

1. Open EWS. For more information, see [To access and use EWS](#).
2. Click the **System** tab, and then select **Energy Settings**.
3. From the **Shut Down After Inactivity** drop-down, select the time for the delay.



NOTE: The default value is **4 hours**.

4. Click the **Apply** button.

Set the Delay Shut Down setting

Use the EWS to select whether or not the printer delays shutting down after the Power button  is pressed.

Complete the following procedure to change the Delay Shut Down setting:

1. Open EWS. For more information, see [To access and use EWS](#).
2. Click the **System** tab, and then select **Energy Settings**.
3. Select or clear the **Delay when ports are active** option.



NOTE: When this option is selected the printer will not shut down unless all ports are inactive. An active network link will prevent the printer from shutting down.

5 Print

This printer is designed to work with the HP Smart app, a software application that makes it easy to print, scan, and manage your printer from a smartphone, laptop, desktop computer, or other devices. You can print and manage the printer from all of your devices by installing the app on each device. The HP Smart app is compatible with iOS, Android, Windows 10, and Mac.

Read this section to learn more about printing with the HP Smart app as well as printing from within other software applications using the HP printer driver installed at setup. You will also find basic instructions for printing with Apple AirPrint on a Mac and printing from mobile devices using the print commands provided in the device software.

Be sure to check out the tips for successful printing to ensure you get the best results every time you print.

Print from a Windows computer

Review the requirements listed in [Requirements for HP+ printers](#).

1. Make sure you have installed the HP Smart app. For more information, see [Use the HP Smart app to print, scan, and manage](#).
2. Open the document you wish to print.
3. From the **File** menu in your software program, select the **Print** option.
4. Click the button that opens the **Properties** dialog box.

Depending on your software application, this button might be called **Properties**, **Options**, **Setup**, or **Preferences**.

5. Make sure your printer is selected.
6. Change any print settings, and Click **OK**.
7. Click **Print** or the **OK** button to print the job.

Print from a Mac computer

Review the requirements listed in [Requirements for HP+ printers](#).

1. Make sure you have installed the HP Smart app. For more information, see [Use the HP Smart app to print, scan, and manage](#).
2. From the computer, open **System Preference**, and select **Printers and Scanners**.
3. Click the Add button/icon **+**, select the printer from the printer list, and then click **Add**.
4. Once connected, open the document you wish to print and use the **Print** command.
5. Make sure the desired printer is selected.
6. Change any print settings.

7. Click **Print** to print the document.

Print with mobile devices

This topic describes how to print from mobile devices.

You can use the HP Smart app to print documents and photos from your mobile device, social media account, or cloud storage. For more information, see [Use the HP Smart app to print, scan, and manage](#).

You can also print directly from your mobile devices using AirPrint (iOS) or HP Print Service Plugin (Android):

- **iOS:** Devices running iOS 4.2 or later have AirPrint pre-installed.
- **Android:** Download the HP Print Service Plugin from the Google Play Store or your favorite app store, and then enable it on your device.



NOTE: You can print using HP Smart or AirPrint/HP Print Service Plugin when the mobile device is on the same network as the printer or a different network (using Wi-Fi Direct).

Print while connected to same Wi-Fi network

You can print documents and photos from your mobile device when the device is on the same Wi-Fi network as the printer.

Visit hp.com/go/mobileprinting for more information on mobile printing.



NOTE: Make sure your mobile device and printer are connected to the same Wi-Fi network. For more information, see [Connect your printer to a Wi-Fi network using HP Smart](#).

Print without connecting to same Wi-Fi network (Wi-Fi Direct)

With Wi-Fi Direct, you can directly connect your computer or mobile device to the printer and print wirelessly—without connecting your computer or mobile device to an existing wireless network.



Visit hp.com/go/wifidirectprinting for more information on Wi-Fi Direct.





NOTE:

- Make sure Wi-Fi Direct on your printer is turned on. If Wi-Fi Direct is turned on, then **Wi-Fi Direct**  appears on the Dashboard control panel display.
- Up to 5 computers and mobile devices can connect to the printer using Wi-Fi Direct connection.



To turn Wi-Fi Direct on or off from the control panel:

1. From the printer control panel, touch or swipe down the tab at the top of the screen to open the Dashboard, and then touch **Wi-Fi Direct** .
2. Touch **Settings** .

3. If the display shows that Wi-Fi Direct is **Off**, touch **Wi-Fi Direct**  and then switch it on.

 **TIP:** You can also turn on Wi-Fi Direct from the EWS. For more information about using the EWS, see [To access and use EWS](#).

To turn on Wi-Fi Direct

1. From the printer control panel, touch or swipe down the tab at the top of the screen to open the Dashboard, and then touch **Wi-Fi Direct** .
2. Touch **Settings** .
3. If the display shows that Wi-Fi Direct is **Off**, touch **Wi-Fi Direct**  and then switch it on.

 **TIP:** You can also turn on Wi-Fi Direct from the EWS. For more information about using the EWS, see [To access and use EWS](#).

Tips for successful printing

To print successfully, the HP cartridges should be functioning properly with sufficient ink, the paper should be loaded correctly, and the printer should have the appropriate settings.

You can check the printer settings from HP Smart, EWS, and your software applications.

Ink tips

Following are the ink tips for successful printing:

- If the print quality is not acceptable, see [Printing issues](#) for more information.
- Use Original HP cartridges.

Original HP cartridges are designed and tested with HP printers and papers to help you easily produce great results, time after time.

 **NOTE:** HP cannot guarantee the quality or reliability of non-Original HP supplies. Product service or repairs required as a result of using a non-Original HP supply will not be covered under warranty.

If you believe you purchased Original HP cartridges, go to hp.com/go/anticounterfeit.

 **NOTE:** If you have an HP+ printer, you must use Original HP cartridges. If non-Original HP or refilled cartridges are installed, the printer will not be able to print.

- Install both the black and color cartridges correctly.
For more information, see [To replace the cartridges](#).
- Check the estimated ink levels in the cartridges to make sure there is sufficient ink.

For more information, see [Check the estimated ink levels](#).



NOTE: Ink level warnings and indicators provide estimates for planning purposes only. When an indicator shows low ink levels, consider having a replacement cartridge available to avoid possible printing delays. You do not need to replace cartridges until you are prompted to.

- Always turn off the printer with the Power button  to allow the printer to protect the nozzles.

Paper loading tips

For more information, also see [Load paper](#).

- Ensure the paper is loaded in the main tray properly, and set the correct media size and media type. Upon loading paper in main tray, you will be prompted to set the media size and media type from the control panel.
- Load a stack of paper (not just one page). All the paper in the stack should be of the same size and type to avoid a paper jam.
- Load paper with the print-side down.
- Ensure that paper loaded in the main tray lays flat and the edges are not bent or torn.
- Adjust the paper-width guides in the main tray to fit snugly against all paper. Make sure the guides do not bend the paper in the tray.

6 Copy, Scan, and Mobile Fax

You can scan documents, photos, and other paper types, and send them to a variety of destinations, such as a computer or an email recipient.

When scanning documents with the HP printer software, you can scan to a format that can be searched and edited.

When scanning a borderless original, use the scanner glass and not the document feeder.

 **NOTE:** Some scan functions are only available after you have installed the HP printer software.

 **TIP:** If you have problems scanning documents, see [Copy and scan issues](#).

Copy from the printer

1. Make sure you have paper loaded in the input tray. For more information, see [Load paper](#).
2. Place your original print-side down on the scanner glass or print-side up in the document feeder.
3. From the printer control panel display, touch **Copy**.
4. Select the desired option.
5. Enter the number of copies by using the keypad or make changes to other settings.

 **TIP:** To save your settings as defaults for future jobs, touch **Copy Settings** , and then touch **Save Current Settings**.

6. Touch **Copy** .

 **TIP:**

- By default, the printer is set to copy in color. If you want to copy in black-and-white, touch **Copy Settings**  to change the default color.
 - If your device has a camera, you can use the HP Smart app to scan a printed document or photo with the device camera. You can then use HP Smart to edit, save, print, or share the image.
-

Scan using HP Smart (iOS/Android, Windows 10, and macOS)

You can use the HP Smart app to scan documents or photos from the printer's scanner, and you can also scan using your device camera. HP Smart includes editing tools that allow you to adjust the scanned image before saving or sharing. You can print, save your scans locally or in cloud storage, and share them via email, SMS, Facebook, Instagram, etc. To scan with HP Smart, follow the instructions provided in the appropriate section below, depending on the type of device you are using.

 **TIP:** Sign up for HP Smart Advance to experience premium HP Smart service such as scan documents as editable text. For more information, see hpsmart.com.

 **NOTE:** An HP account is required to use HP Smart, and not all mobile devices or regions have access to all settings at this time. Some features are available only on specific printers or models.

- **iOS/Android:** hp.com/go/hpsmart-help
- **Windows 10:** hp.com/go/hpsmartwin-help
- **macOS:** hp.com/go/hpsmartmac-help

Scan using the HP Scan software (Windows 7)

Use the HP Scan software to initiate scanning from software on your computer. You can save the scanned image as a file or send it to another software application.

 **NOTE:** Windows 7 Service Pack 1 (SP1) is required to install HP Scan software.

1. Load the document on the scanner glass according to the indicators on the printer.
2. Open the HP Printer software. From the computer desktop, click **Start**, select **All Programs**, click **HP**, click the folder for the printer, and then select the printer name.
3. Select **Scan**, and then select **Scan a Document or Photo**.
4. Adjust the settings if necessary.
5. Click **Scan**.

Scan using Webscan

Webscan is a feature of EWS that lets you scan photos and documents from your printer to your computer using a web browser.

This feature is available even if you did not install the printer software on your computer.

For more information, see [To access and use EWS](#).

 **NOTE:** By default, Webscan is off. You can enable this feature from the EWS.

If you are unable to open Webscan in the EWS, your network administrator might have turned it off. For more information, contact your network administrator or the person who set up your network.

To enable Webscan

1. Open the embedded web server. For more information, see [To access and use EWS](#).
2. Click the **Settings** tab.
3. In the **Security** section, click **Administrator Settings**.
4. Select **Webscan from EWS** to enable Webscan.
5. Click **Apply**.

To scan using Webscan

Scanning using Webscan offers basic scan options. For additional scan options or functionality, scan from the HP printer software.

1. Load the original into the document feeder or on the scanner glass. For information about how to load paper, see [Load paper](#).
2. Open the embedded web server. For more information, see [To access and use EWS](#).
3. Click the **Scan** tab.
4. Click **Webscan** in the left pane, change any settings, and then click **Start Scan**.

Tips for copy and scan success

Use the following tips to copy and scan successfully:

- Keep the glass and the back of the lid clean. The scanner interprets anything it detects on the glass as part of the image.
- Load your original print-side down on the scanner glass and align it with the marking on the rear left corner of the glass.
- To make a large copy of a small original, scan the original into the computer, resize the image in the scanning software, and then print a copy of the enlarged image.
- If you want to adjust scan size, output type, scan resolution, or file type, and so on, start scan from the printer software.
- To avoid incorrect or missing scanned text, make sure the brightness is set appropriately in the software.
- If you want to scan a document with several pages into one file instead of multiple files, start the scan with the printer software instead of selecting **Scan** from the printer display, or use document feeder to scan.
- If you scan from a mobile camera, make sure to scan in a well-lit area so that the original has good contrast with the surface it is lying on.

Mobile Fax

Use the HP Smart app to quickly scan and fax multiple pages at once from your mobile device or computer.

For more information about Mobile Fax, visit the [HP Smart website](#).

Use Mobile Fax in the HP Smart app

1. Make sure your mobile device or computer are connected to a network. Launch the HP Smart app and sign into or create your HP Account.
2. Select the Mobile Fax tile.

If you do not see the **Mobile Fax** tile, enable it as follows:

- On a mobile device: Tap **Personalize Tiles**, tap the **Mobile Fax** toggle to enable the tile, and then go back to the Home screen.

- On a Windows 10 device: Click the **Settings** , select **Personalize Tiles**, and click the **Mobile Fax** toggle to enable the tile. Then, go back to the Home screen.
- On a Mac device: From the menu bar, select **HP Smart >Personalize Tiles**. Set the Mobile Fax option to **On**.



NOTE: Mobile Fax is available in specific countries/regions. If you do not see a Mobile Fax option in the Personalize Menu, Mobile Fax might not be available in your country/region.

3. Fill out the necessary mobile fax information.
4. To add a cover page, tap the **Add a cover page** toggle, and then type a subject and message.
5. Scan the item you want to fax using your printer or mobile device camera, or attach a supported file type. Send the fax when ready.

Your fax will be securely delivered and you can track the status in the HP Smart app.

7 Manage cartridges

This section describes how to manage and order supplies.

To ensure the best print quality from the printer, you need to perform some simple maintenance procedures.

 **TIP:** If you have problems copying documents, see [Printing issues](#).

Dynamic security enabled printers

This printer is intended to work only with cartridges that have new or reused HP electronic circuitry. Reused HP electronic circuitry enables the use of reused, remanufactured, and refilled cartridges.

The printer uses dynamic security measures to block cartridges using modified or non-HP circuitry. Periodic firmware updates delivered over the internet will maintain the effectiveness of the dynamic security measures and block cartridges that previously worked.

Updates can improve, enhance, or extend the printer's functionality and features, protect against security threats, and serve other purposes, but these updates can also block cartridges using modified or non-HP electronic circuitry from working in the printer, including cartridges that work today. Unless you are enrolled in certain HP programs such as Instant Ink or use other services that require automatic online firmware updates, most HP printers can be configured to receive updates either automatically or with a notification that allows you to choose whether to update or not. For more information on dynamic security and how to configure online firmware updates, please go to www.hp.com/learn/ds.

Information on cartridges and the printhead

The following tips help maintain HP cartridges and ensure consistent print quality.

- The instructions in this guide are for replacing cartridges, and are not intended for first time installation.
- Keep all cartridges in the original sealed packages until they are needed.
- Be sure to turn off the printer properly. For more information, see [Turn the printer off](#).
- Store cartridges at room temperature (15-35° C or 59-95° F).
- Do not clean the printhead unnecessarily. This wastes ink and shortens the life of the cartridges.
- Handle cartridges carefully. Dropping, jarring, or rough handling during installation can cause temporary printing problems.
- If you are transporting the printer, do the following to prevent ink leaking from the printer or other damage from occurring to the printer:
 - Make sure you turn off the printer by pressing the Power button . Wait until all sounds of internal motion stop before unplugging the printer.
 - Make sure you leave the cartridges installed.
 - The printer must be transported sitting flat; it should not be placed on its side, back, front, or top.

- If you have an HP+ printer, you must use Original HP cartridges. If non-Original HP or refilled cartridges are installed, the printer will not be able to print.

Some color ink is used even when printing with black cartridge only

Ink is used in a number of ways throughout the inkjet printing process.

In general, ink in a cartridge is used for printing documents, photographs and other such materials. Some ink, however, must be used to maintain the health of the printhead; some ink is residual; and some ink evaporates. For more information on ink usage, visit hp.com/go/learnaboutsupplies and click **HP Ink**. (You might need to select your country/region using the **Select Country** button on the page.)

Check the estimated ink levels

You can check the estimated ink levels from the printer software or from the printer control panel.

To check the estimated ink levels from the printer control panel

- From the printer control panel, touch or swipe down the tab at the top of the screen to open the Dashboard, and then touch **Ink**  to check the estimated ink levels.

NOTE:

- Ink level alerts and indicators provide estimates for planning purposes only. When you receive a low-ink alert, consider having a replacement cartridge available to avoid possible printing delays. You do not have to replace the cartridges until prompted to do so.
 - If you have installed a refilled or remanufactured cartridge, or a cartridge that has been used in another printer, the ink level indicator might be inaccurate or unavailable.
 - Ink from the cartridges is used in the printing process in a number of different ways, including in the initialization process, which prepares the printer and cartridges for printing, and in printhead servicing, which keeps print nozzles clear and ink flowing smoothly. In addition, some residual ink is left in the cartridge after it is used. For more information, see hp.com/go/inkusage.
-

Order cartridges

This topic describes how to order cartridges.

To order cartridges, go to www.hp.com. (At this time, some portions of the HP website are available in English only.) Ordering cartridges online is not supported in all countries/regions. However, many countries have information on ordering by telephone, locating a local store and printing a shopping list. In addition, you can visit the hp.com/buy/supplies page to obtain information about purchasing HP products in your country.

Use only the replacement cartridges that have the same cartridge number as the cartridge you are replacing. You can find the cartridge number in the following places:

- Open HP Smart. Click or tap the printer image, and then click or tap **Supported Supplies**.
- In the embedded web server, click the **Tools** tab, and then click **Supply Status** under **Product Information**. For more information, see [To access and use EWS](#).
- On the printer status report (see [Understand printer reports](#)).

- On the label of the cartridge you are replacing.
- On a sticker inside the printer. Open the cartridge access door to locate the sticker.

 **NOTE:** The **Setup** cartridge that comes with the printer is not available for separate purchase.

Replace the cartridges

This section describes how to replace the cartridges.

 **NOTE:**

- For information on recycling used ink supplies, see [HP inkjet supplies recycling program](#)
If you do not already have replacement cartridges for the printer, see [Order cartridges](#).
- At this time, some portions of the HP web site are available in English only.
- Not all cartridges are available in all countries/regions.

 **CAUTION:** HP recommends that you replace any missing cartridges as soon as possible to avoid print quality issues and possible extra ink usage or damage to the ink system. Never turn off the printer when cartridges are missing.

To replace the cartridges

1. Make sure the printer is turned on.
2. Open the front door.

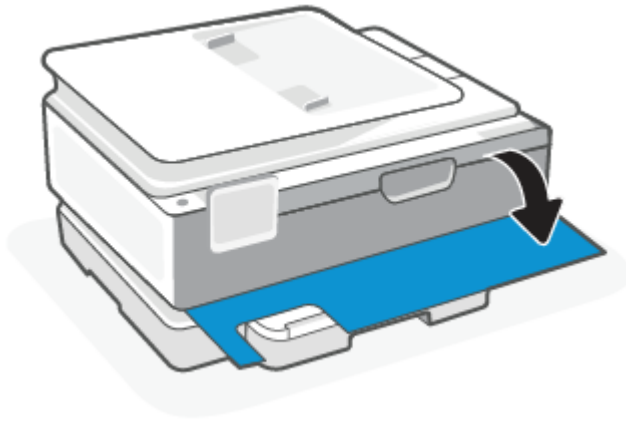

3. Open the cartridge access door.

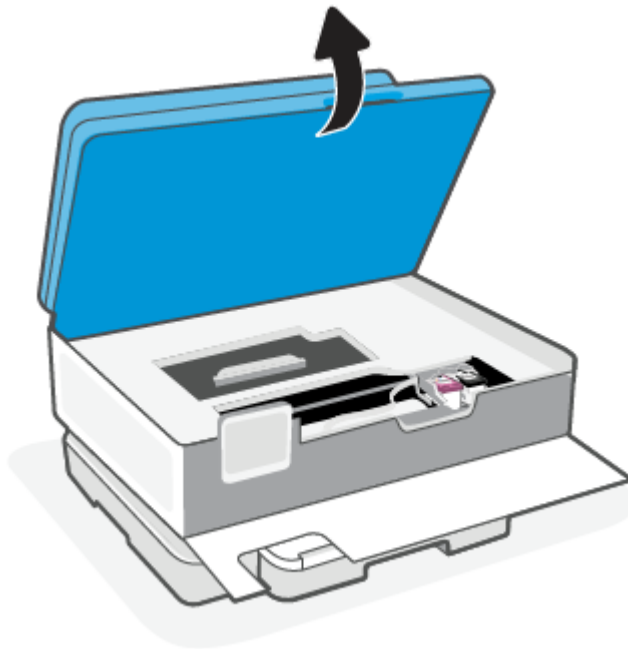

 **NOTE:**

- Wait until the print carriage stops moving before proceeding.
 - If the printer has a document feeder, do not grab or squeeze the document feeder when lifting the scanner.
-

4. Remove the cartridge from the slot.
5. Insert a new cartridge.

- Remove the new cartridge from its packaging.

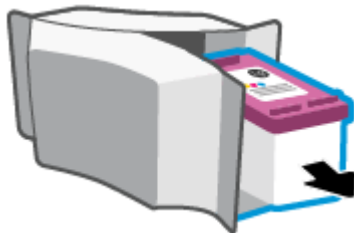

- Remove plastic tape using the pull tab.

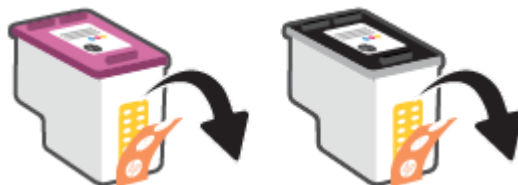

- Slide the new cartridge in the slot until it clicks.

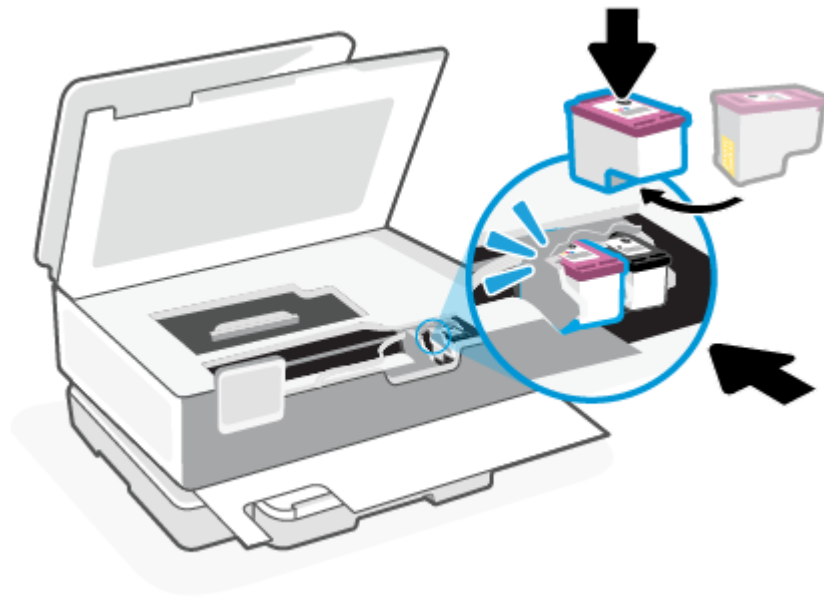

6. Close the cartridge access door.

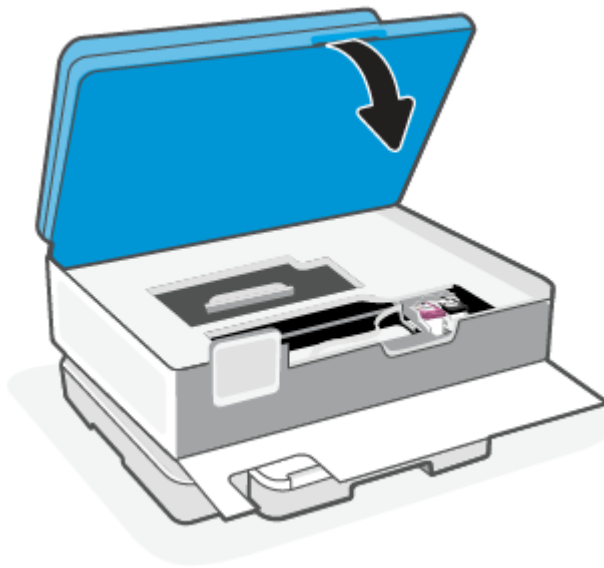

7. Close the front door.

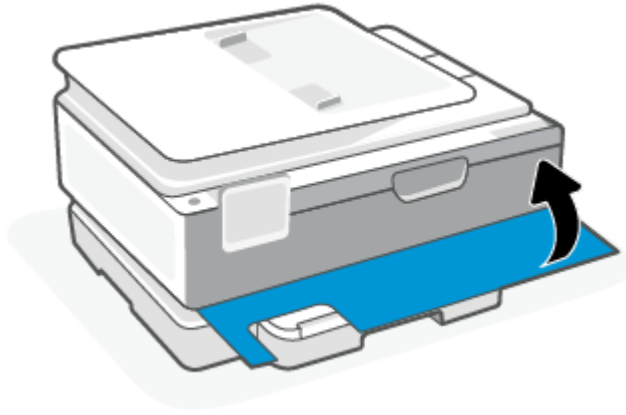

Use single cartridge mode

Use the single cartridge mode to operate the printer with only one cartridge. The single cartridge mode is initiated when one of the following occurs.

- There is only one cartridge installed in the carriage.
- A cartridge is removed from the carriage if there are two cartridges installed previously.

 **NOTE:** If the printer enters the single cartridge mode when two cartridges are installed in the printer, verify that the protective piece of plastic tape has been removed from each cartridge. When the plastic tape covers the cartridge contacts, the printer cannot detect that the cartridge is installed. If there is no plastic tape on the cartridges, try cleaning the cartridge contacts. For information about cleaning cartridge contacts, see [Ink cartridge issues](#).

To exit the single cartridge mode

- Install both the black and tri-color cartridges in the printer.

Ink cartridge issues

If a cartridge has a problem, you might get a cartridge problem message.

If an error occurs after a cartridge is installed, or if a message indicates a cartridge problem, try removing the cartridges, verifying the protective piece of plastic tape has been removed from each cartridge, and then reinserting the cartridges. If this does not work, clean the cartridge contacts. If the problem is still not resolved, replace the cartridges.

For information about replacing cartridges, see [Replace the cartridges](#).

To clean cartridge contacts

 **CAUTION:** The cleaning procedure should take only a few minutes. Make sure that the cartridges are reinstalled in the printer as soon as possible. It is not recommended to leave the cartridges outside the printer longer than 30 minutes. If cartridges are left unprotected outside the printer, their nozzles might dry out and clog up.

1. Check that power is on.

2. Open the front door.

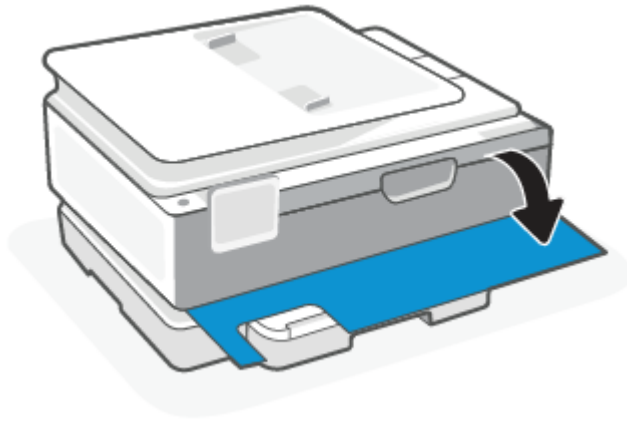

3. Open the cartridge access door.

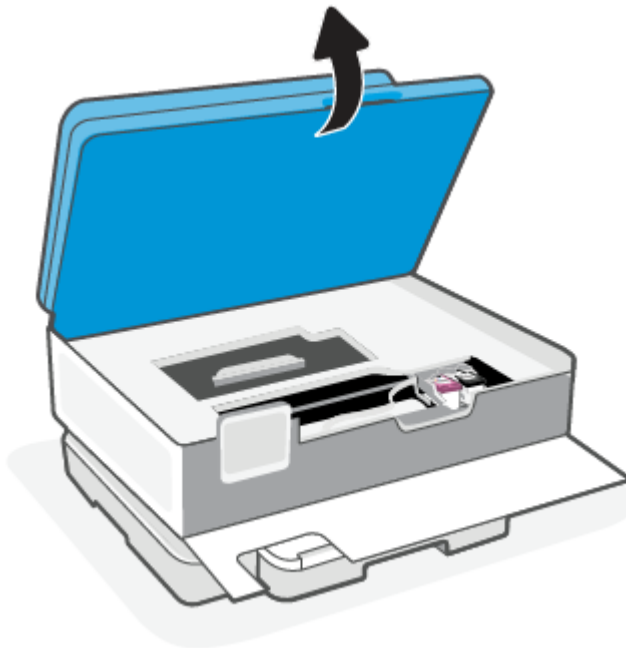

 **NOTE:**

- Wait until the print carriage stops moving before proceeding.
- If the printer has a document feeder, do not grab or squeeze the document feeder when lifting the scanner.

-
4. Wait until the carriage stops moving.
 5. Remove the cartridge indicated in the error message.
 6. Clean the cartridge contacts and printer contacts.

- a. Hold the cartridge by its sides with the bottom pointing up and locate the electrical contacts on the cartridge.

The electrical contacts are the small gold-colored dots on the cartridge.

- b. Wipe only the contacts with a dry swab or lint-free cloth.

⚠ CAUTION: Be careful to wipe only the contacts, and do not smear any of the ink or other debris elsewhere on the cartridge.

- c. On the inside of the printer, locate the contacts for the cartridge.

The printer contacts are the set of gold-colored bumps positioned to meet the contacts on the cartridge.

- d. Use a dry swab or lint-free cloth to wipe the contacts.

7. Reinstall the cartridge.

8. Close the cartridge access door.

9. Check if the error message has gone away. If you still receive the error message, turn the printer off, and then on.



NOTE: If one cartridge is causing problems, you can remove it and use the single cartridge mode to operate the printer with only one cartridge.

Store printing supplies

Cartridges can be left in the printer for extended periods of time. However, to assure optimal cartridge health, be sure to turn off the printer properly when the printer is not in use.

For more information, see [Turn the printer off](#).

Cartridge warranty information

The HP cartridge warranty is applicable when the cartridge is used in its designated HP printing device. This warranty does not cover HP cartridges that have been refilled, remanufactured, refurbished, misused, or tampered with.

During the warranty period, the cartridge is covered as long as the HP ink is not depleted and the end of warranty date has not been reached. The end of warranty date, in YYYY/MM/DD format, may be found on the cartridge as indicated:



For a copy of the HP Limited Warranty Statement, visit hp.com/go/orderdocuments.

8 Solve a problem

This section suggests solutions to common problems.

If the suggestions do not solve the problems, try getting help using one of the support services, see HP support.

You can also get help from the HP Smart app and printer control panel.

- **HP Smart:** Provides alerts for printer issues (jams and other problems), links to help content, and options to contact support for additional assistance. For more information, see [Use the HP Smart app to print, scan, and manage](#).
- **Printer control panel:** Touch the Help button  to access the Help menu, contextual help, and also animations for some tasks.

Jams and paper-feed issues

This topic helps you troubleshoot jams and paper-feed issues.

Clear a paper jam

Paper jams can occur in several locations inside the printer.

 **CAUTION:** To prevent possible damage to the printhead, clear paper jams as soon as possible.

To clear a paper jam from the main tray

1. Open the main tray.

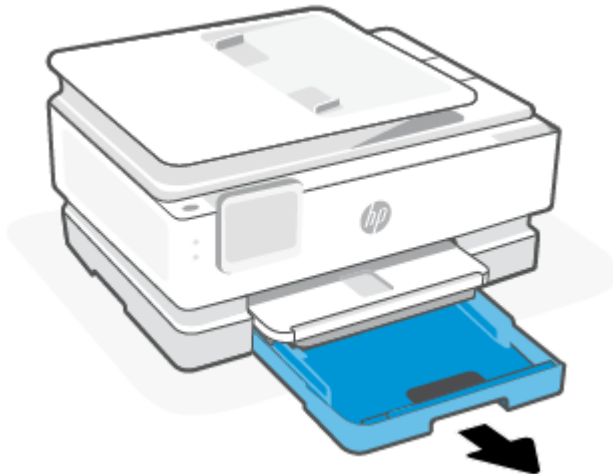

2. Lift up the output tray and then remove from the printer.

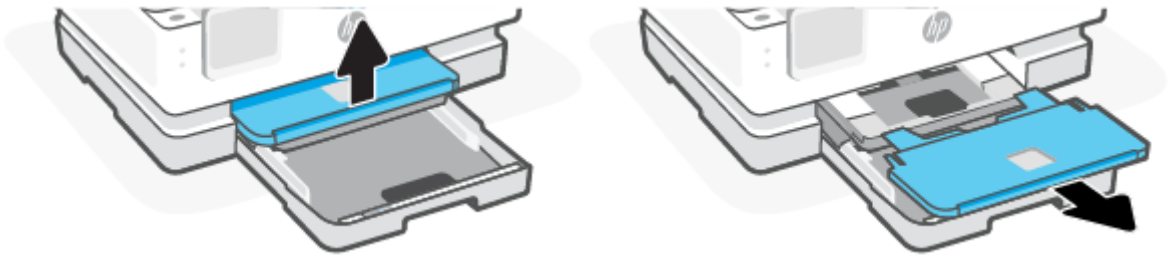

3. Remove any jammed paper in the photo tray.

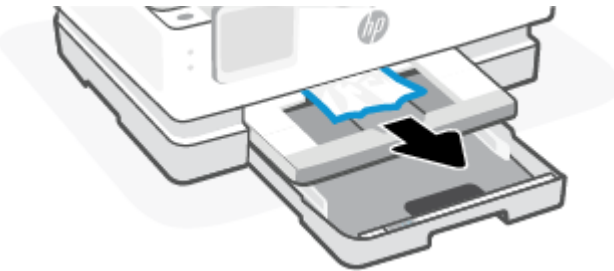

4. Push in the photo tray and then remove any jammed paper in the main tray.

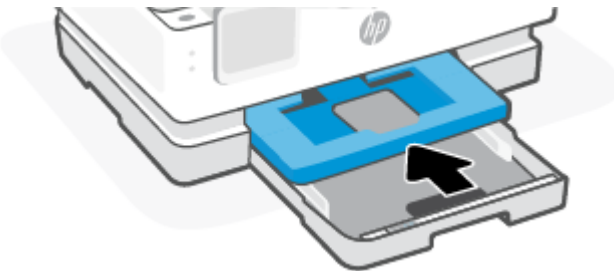

5. Insert the output tray back into the printer.

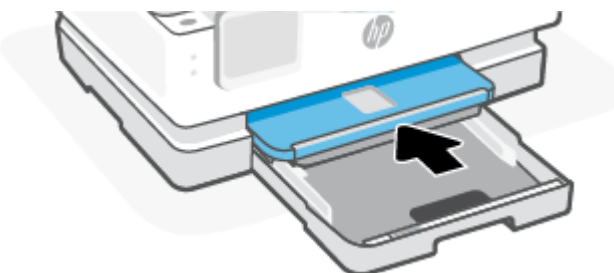

6. Close the main tray.

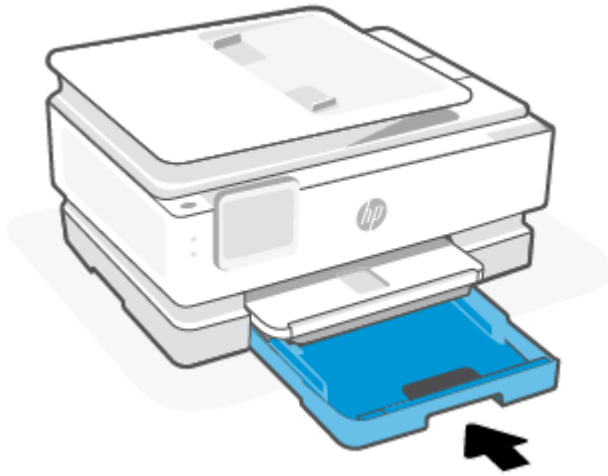

 **NOTE:** If the printer is still showing clear jam message, with the input tray extended, gently tilt the printer from the front (about 60 degrees) to remove the paper from the base of the printer.

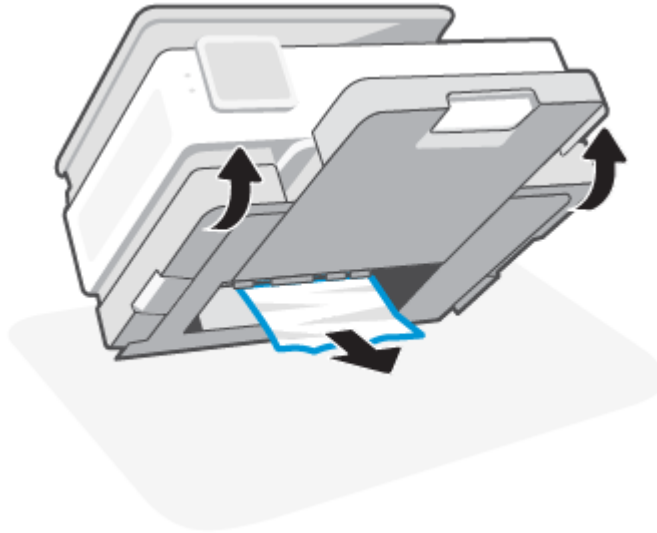

To clear a paper jam from print zone

1. Open the front door.

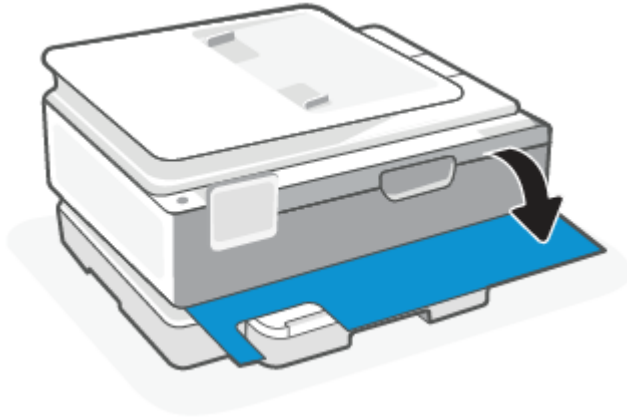

2. Open the carriage access door.

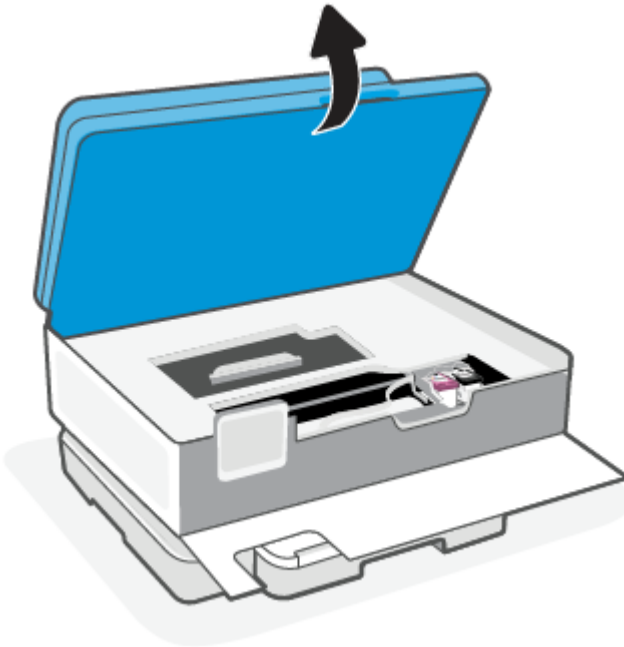

3. If the print carriage is not obstructed, gently move the print carriage to the left of the printer and then remove the jammed paper. If needed, repeat the same by gently moving the print carriage to the right of the printer.

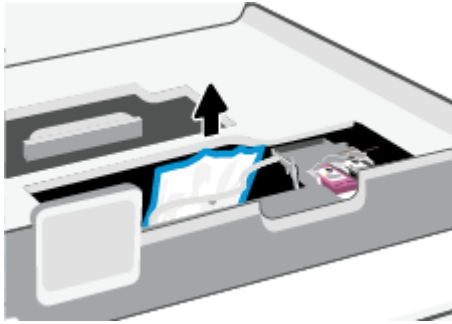

 **NOTE:** Do not move the print carriage too far to the left or the right side of the printer.

4. Lift the handle of the paper path cover and remove the cover.

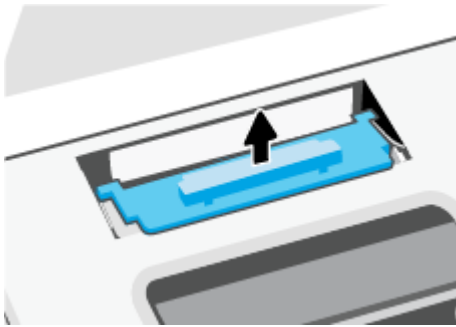

5. Locate any jammed paper inside the printer, grasp it with both hands and pull it towards you.

 **CAUTION:** If the paper tears when you are removing it from the rollers, check the rollers and wheels for torn pieces of paper that might be remaining inside the printer.

If you do not remove all the pieces of paper from the printer, more paper jams are likely to occur.

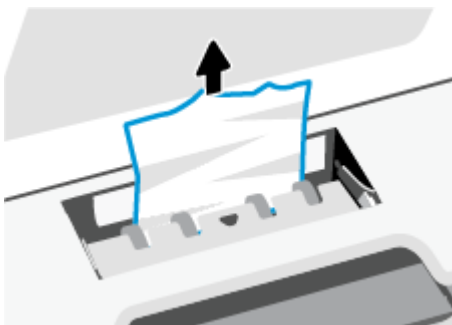

6. Reinsert the paper path cover until it snaps into place.

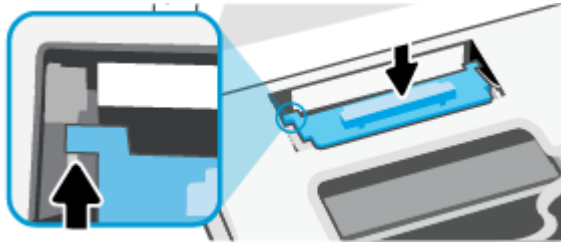

7. Close the cartridge access door.

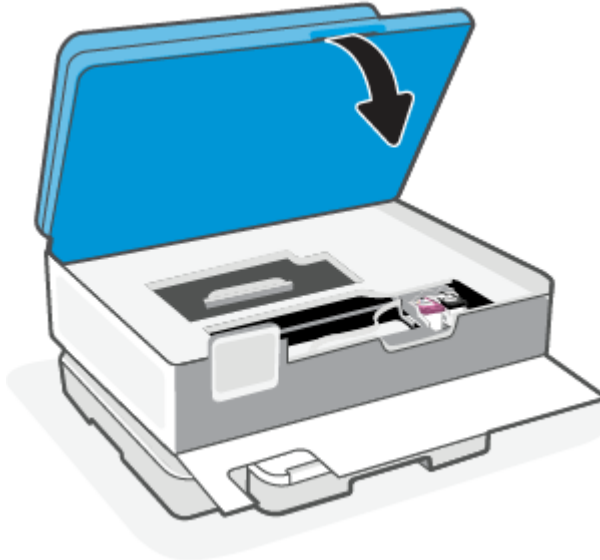

8. Close the front door.

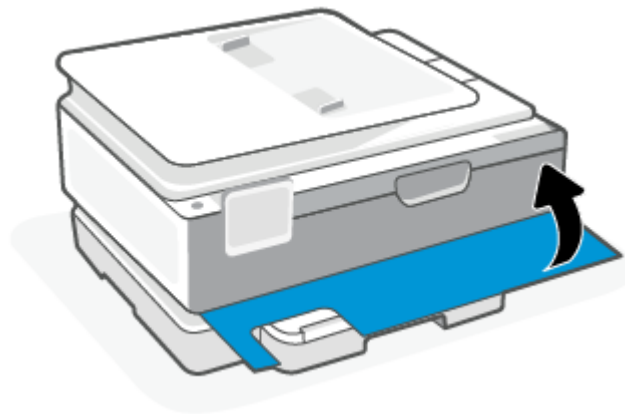

To clear a paper jam from the document feeder (some models only)

1. Lift the cover of the document feeder.



2. Pull any jammed paper out of the rollers.

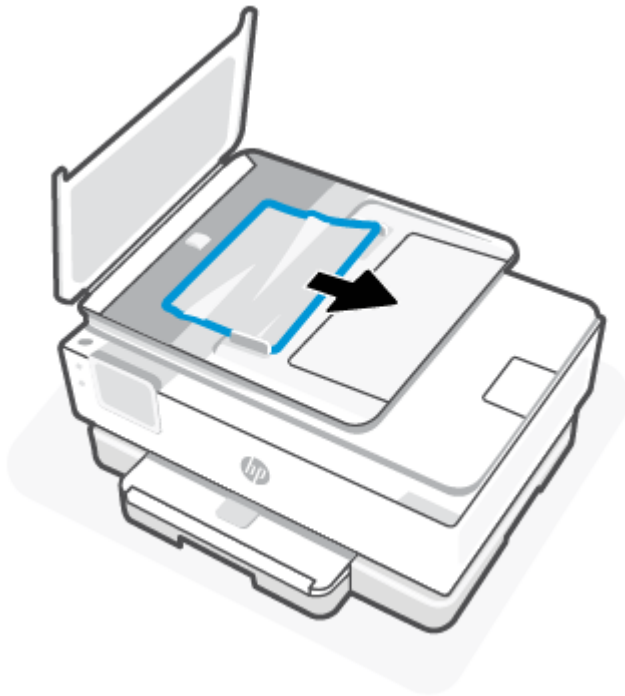

3. Close the cover of the document feeder until it snaps into space.

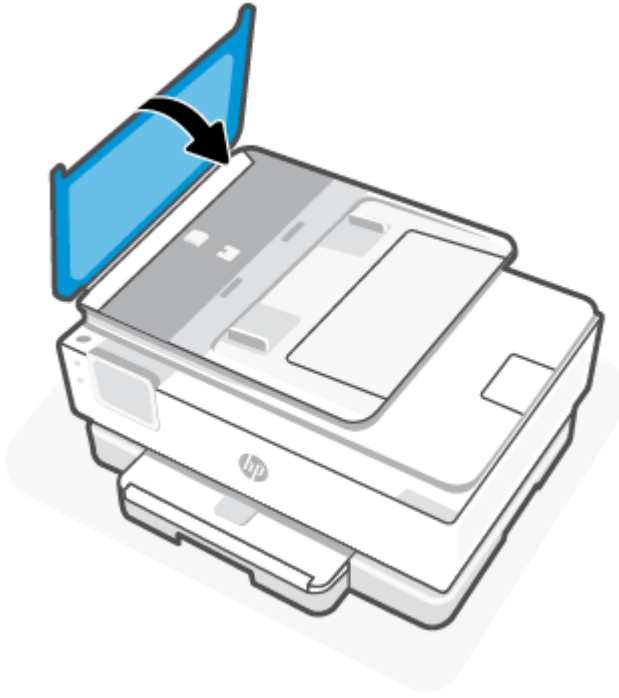

4. Lift up the document feeder tray.



5. Remove any jammed paper under the tray.



6. Put down the document feeder tray.



Clear a print carriage jam

Remove any objects, such as paper, that are blocking the print carriage.

 **NOTE:** Do not use any tools or other devices to remove jammed paper. Always use caution when removing jammed paper from inside the printer.

Learn how to avoid paper jams

To help avoid paper jams, follow these guidelines.

- Do not place too much paper in the printer trays. For information on tray capacity, see [Specifications](#).
- Remove printed papers from the output tray frequently.

- Make sure that you are printing with paper that is not wrinkled, folded, or damaged.
- Prevent curled or wrinkled paper by storing all unused paper flat in a resealable bag.
- Do not use paper that is too thick or too thin for the printer.
- Make sure that the trays are loaded correctly and are not too full. For more information, see [Load paper](#).
- Ensure that paper loaded in the main tray lays flat and the edges are not bent or torn.
- Do not mix different paper types and paper sizes in the main tray; the entire stack of paper in the main tray must be the same size and type.
- Do not force paper too far inside the main tray.
- If you are printing on both sides of a page, do not print highly saturated images on light weight paper.
- Use paper types that are recommended for the printer.
- If the printer is about to run out of paper, allow the printer to run out of paper first, and then add paper. Do not load paper when the printer is printing.

Solve paper-feed problems

The following lists the common paper-feed problems.

- **Paper is not picked up from a tray**
 - Make sure paper is loaded in the tray. For more information, see [Load paper](#). Fan the paper before loading.
 - Make sure the paper-width guides are set to the correct markings in the tray for the paper size you are loading. Also make sure the paper guides are snug, but not tight, against the stack.
 - Ensure that the stack of paper is aligned with the appropriate paper size lines on the bottom of the main tray, and does not exceed the stack height indicated by one or more label on the side or paper-width guide of the main tray.
 - Make sure paper in the tray is not curled. Uncurl paper by bending it in the opposite direction of the curl.
- **Pages are skewing**
 - Make sure the paper loaded in the main tray is aligned to the paper-width guides. If needed, open the main tray from the printer and reload the paper correctly, making sure that the paper guides are aligned correctly.
 - Load paper into the printer only when it is not printing.
 - Make sure the rear access door is securely shut.
- **Multiple pages are being picked up**
 - Make sure the paper-width guides are set to the correct markings in the tray for the paper size you are loading. Also make sure the paper-width guides are snug, but not tight, against the stack.
 - Ensure that the stack of paper is aligned with the appropriate paper size lines on the bottom of the main tray, and does not exceed the stack height indicated by one or more label on the side or paper-width guide of the main tray.

- Make sure the tray is not overloaded with paper.
- Use HP paper for optimum performance and efficiency.

Printer is unable to print

This topic describes how to troubleshoot when the printer is unable to print.

Check printer connection to the Internet

Verify that the printer is connected to the Internet. If disconnected, the printer will not work as expected.

Your printer might be occasionally disconnected from the Internet (for example, power outage, network or router issues or turning off the printer when not in use). You might be able to print a limited number of pages while the printer is disconnected, but it is critical to reconnect the printer to continue printing.

Make sure to use Original HP cartridges

Check that you are using Original HP cartridges. Original HP cartridges are manufactured and sold by HP in official HP packaging. HP+ printers require Original HP cartridges. If non-Original HP supplies or refilled cartridges are installed, HP+ printers will not operate as expected.

Check the printer settings and status

To check the printer settings and status, print a printer report and printer status report. Check this page for information about printer errors.



TIP: To set up the printer wirelessly, see [Connect your printer to a Wi-Fi network using HP Smart](#).

If you are still unable to print, visit the HP Support website at hp.com/support.

To print a printer report

1. From the printer control panel, touch or swipe down the tab at the top of the screen to open the Dashboard, touch **Setup** .
2. Touch **Reports**.
3. Select a printer report to print.

Printer status report

Use the printer status report to view current printer information and cartridge status. Also use the printer status report to help you troubleshoot problems with the printer.

The printer status report also contains a log of recent events.

If you need to call HP, it is often useful to print the printer status report before calling.

Printing issues

This topic helps you troubleshoot printing issues.

Fix problems with HP+ printers not printing

If your HP+ printer does not print, verify that it is connected to the Internet and that you are using HP Original cartridges.

HP+ printers must be connected to the Internet over Wi-Fi or Ethernet to function. Your printer might be occasionally disconnected from the Internet (for example, due to power outage, network or router issues, or turning off the printer when not in use). You might be able to print a limited number of pages while the printer is disconnected, but it is critical to reconnect the printer to continue printing.

Also, make sure you have installed Original HP cartridges. Original HP cartridges are manufactured and sold by HP in official HP packaging. HP+ printers require Original HP cartridges. If non-Original HP or refilled cartridges are installed, HP+ printers will not operate as expected.

Fix problems with page not printing (unable to print)

This topic helps you troubleshoot printing issues.

To resolve print issues

Make sure that the printer is turned on and that there is paper in the tray. If you are still unable to print, try the following in order:

1. Check for error messages and resolve them by following the on-screen instructions.
2. If your computer is connected to the printer with a USB cable, disconnect and reconnect the USB cable. If your computer is connected to the printer with a wireless connection, confirm that the connection is working.
3. Run HP Print and Scan Doctor to automatically diagnose and resolve issues.

 **TIP:** If you are using Windows 10, you can run the HP Print and Scan Doctor from HP Smart.

To check the power connection and reset the printer

1. Make sure the power cord is firmly connected to the printer.

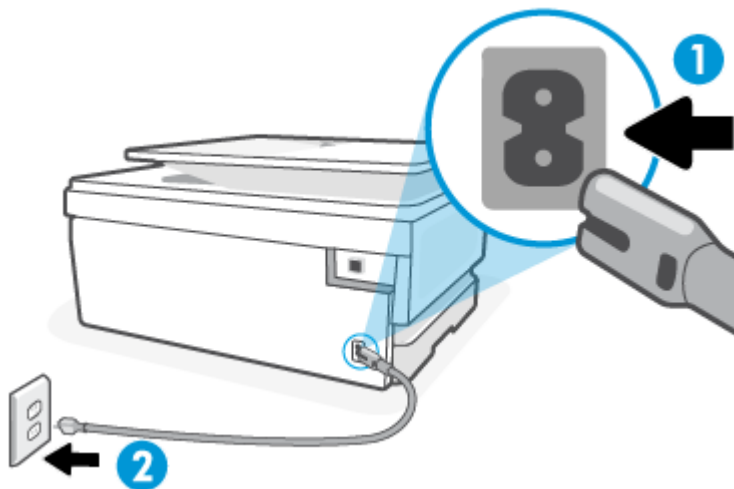

Table 8-1 Printer ports

Port	Description
1	Power connection to the printer
2	Connection to a power outlet

2. Look at the Power button located on the printer. If it is not lit, the printer is turned off. Press the Power button to turn on the printer.



NOTE: If the printer is not receiving electrical power, connect it to another power outlet.

3. With the printer turned on, disconnect the power cord from the back of the printer.
4. Unplug the power cord from the wall outlet.
5. Wait at least 15 seconds.
6. Plug the power cord back into the wall outlet.
7. Reconnect the power cord to the back of the printer.
8. If the printer does not turn on by itself, press the Power button to turn on the printer.
9. Try using the printer again.

Fix print quality issues

This topic helps you troubleshoot print quality issues.



NOTE: To avoid print quality problems, always turn the printer off using the Power button, and wait until the Power button light goes out before you pull the plug or turn off a power strip. This allows the printer to move the cartridges to a capped position, where they are protected from drying out.

To improve print quality from the printer control panel

1. Clean the printhead from the printer control panel.
 - a. Load Letter, A4, or Legal unused plain white paper into the main tray.
 - b. From the printer control panel, touch or swipe down the tab at the top of the screen to open the Dashboard, and then touch **Setup** .
 - c. Touch **Printer Maintenance**, select **Clean Cartridges**, and then follow the onscreen instructions.
2. Make sure you are using original HP cartridges.
3. Make sure you have selected the appropriate paper type and print quality.
4. Check the estimated ink levels to determine if the cartridges are low on ink. For more information, see [Check the estimated ink levels](#). If the cartridges are low on ink, consider replacing them.
5. Print a diagnostics page if the cartridges are not low on ink.
 - a. Load Letter, A4, or Legal unused plain white paper into the main tray.

- b. From the printer control panel, touch or swipe down the tab at the top of the screen to open the Dashboard, and then touch **Setup** .
 - c. Touch **Reports**.
 - d. Touch **Print Quality Report**.
6. Review the blue, magenta, yellow, and black boxes on the diagnostics page. If you are seeing streaks in the color and black boxes, or no ink in portions of the boxes, then automatically clean the printhead.
7. If cleaning the printhead does not solve the problem, contact HP support. Go to hp.com/support. This website provides information and utilities that can help you correct many common printer problems. If prompted, select your country/region, and then click **All HP Contacts** for information on calling for technical support.

Copy and scan issues

Choose one of the following troubleshooting options.

- Use an HP online troubleshooting tool to solve your copy and scan.
- Use [HP Print and Scan Doctor](#) to automatically diagnose and resolve issues. If you are using Windows 10, you can run the HP Print and Scan Doctor from HP Smart.



NOTE: The HP Print and Scan Doctor and the HP online troubleshooting wizards may not be available in all languages.

For more information, see [Tips for copy and scan success](#).

Network and connection issues

This topic helps you troubleshoot network and connection issues.

Fix wireless connection

Choose one of the following troubleshooting options.

- Restore network settings and reconnect the printer. For more information, see [Restore original factory defaults and settings](#).
- Check the network configuration or print the wireless test report to assist in diagnosing network connection issues.

1. From the Home screen, touch **Wireless**  and then touch **Settings** .

2. Touch **Print Reports**, and then touch **Network Configuration Page** or **Wireless Test Report**.

Check the top of the wireless network test report to see if something failed during the test.

- See the **DIAGNOSTICS RESULTS** section for all tests that were performed, to determine whether or not your printer passed.

- From the **CURRENT CONFIGURATION** section, find out the Network Name (SSID) to which your printer is currently connected. Make sure that the printer is connected to the same network as your computer or mobile devices.
- Use an HP online troubleshooting tool to solve your printer issues.

Fix Wi-Fi Direct connection

1. Check the printer to confirm that the Wi-Fi Direct is turned on:
From the printer control panel, touch or swipe down the tab at the top of the screen to open the Dashboard, and then touch **Wi-Fi Direct**  .
2. From your wireless computer or mobile device, turn on the Wi-Fi connection, and then search for and connect to the Wi-Fi Direct name of your printer.
3. Enter the Wi-Fi Direct password when prompted.
4. If you are using a mobile device, make sure you have installed a compatible printing app. For more information about mobile printing, visit hp.com/go/mobileprinting.

Printer hardware issues

Complete the following steps to resolve printer failure problems:

The printer shuts down unexpectedly

- Check the power and power connections.
- Make sure the printer's power cord is connected firmly to a functioning power outlet.

Printhead alignment fails

- If the alignment process fails, make sure you have loaded unused, plain white paper into the main tray. If you have colored paper loaded in the main tray when you align the printhead, the alignment fails.
- If the alignment process fails repeatedly, you may need to clean the printhead, or you might have a defective sensor. To clean the printhead, see [Maintain the printhead and cartridges](#).
- If cleaning the printhead does not solve the problem, contact HP support. Go to hp.com/support. This website provides information and utilities that can help you correct many common printer problems. If prompted, select your country/region, and then click **All HP Contacts** for information on calling for technical support.

The printer shuts down unexpectedly

- Check the power and power connections.
- Make sure the printer's power cord is connected firmly to a functioning power outlet.

Resolve printer failure

1. Press the Power button  to turn off the printer.
2. Unplug the power cord, and then plug in the power cord again.

3. Press the Power button  to turn on the printer.

If this problem persists, write down the error code provided in the message, and then contact HP support. For more information about contacting HP support, see [HP support](#).

Understand printer reports

You can print the following reports to help troubleshoot problems with the printer.

Printer status report

Use the printer status report to view current printer information and cartridge status. Also use the printer status report to help you troubleshoot problems with the printer.

The printer status report also contains a log of recent events.

If you need to call HP, it is often useful to print the printer status report before calling.

Network configuration page

If the printer is connected to a network, you can print a network configuration page to view the network settings for the printer and a list of networks detected by your printer. The last page of the report includes a list of all detectable wireless networks in the area, along with signal strength and the channels being used. This might help you select a channel for your network which is not heavily used by other networks (which will improve network performance).

The IP address is set back to the Automatic mode.



NOTE: In order to get the list of detected wireless networks in the area, the wireless radio on the printer should be turned on. If it is off, the list is not displayed.

You can use the network configuration page to help troubleshoot network connectivity problems. If you need to call HP, it is often useful to print this page before calling.

Print quality report

Print quality problems can have many causes—software settings, a poor image file, or the printing system itself. If you are unhappy with the quality of your prints, a Print Quality Report page can help you determine if the printing system is working correctly.

Wireless test report

When you print the Wireless Test Report, a number of tests are run to check various conditions of the printer wireless connection. The report shows the results of the tests. If an issue is discovered, the issue along with a message how to fix it is provided on the report. Some key wireless configuration details are provided at the bottom section of the report.

Web access test report

Print the web access report to help identify internet connectivity issues which can affect Web Services.

Solve Web Services problems

If you are having problems using Web Services, check the following:

- Make sure the printer is connected to the Internet using a supported network connection.



NOTE: You cannot use these web features if the printer is connected using a USB cable.

- Make sure the latest product updates have been installed on the printer.
- Make sure Web Services is enabled on the printer. For more information, see [To set up Web Services](#).
- Make sure the network hub, switch, or router is turned on and working correctly.
- If you are connecting the printer using a wireless connection, make sure the wireless network is functioning properly. For more information, see [Network and connection issues](#).
- If your network uses proxy settings when connecting to the Internet, make sure the proxy settings you are entering are valid:
 - Check the settings being used by the web browser you are using (such as Internet Explorer, Firefox, or Safari).
 - Check with the IT administrator or person who set up your firewall.

If the proxy settings used by your firewall have changed, you must update these settings in either the printer control panel or the embedded web server. If these settings are not updated, you will not be able to use Web Services.

For more information, see [To set up Web Services](#).

Maintain the printer

This topic describes how to maintain the printer.

Clean the scanner glass

Dust or dirt on the scanner glass, scanner lid backing, or scanner frame can slow down performance, degrade the quality of scans, and affect the accuracy of special features such as fitting copies to a certain page size.



WARNING! Before cleaning the printer, turn the printer off by pressing the Power button  and unplug the power cord from the electrical socket.

1. Lift the scanner lid.



2. Clean the scanner glass and lid backing by using a soft, lint-free cloth that has been sprayed with a mild glass cleaner.



⚠ CAUTION:

- Use only glass cleaner to clean the scanner glass. Avoid cleaners that contain abrasives, acetone, benzene, and carbon tetrachloride, all of which can damage the scanner glass. Avoid isopropyl alcohol because it can leave streaks on the scanner glass.
- Do not spray the glass cleaner directly on the scanner glass. If too much glass cleaner is applied, the cleaner could leak under the scanner glass and damage the scanner.

⚠ CAUTION:

3. Close the scanner lid, and turn on the printer.

Clean the exterior

⚠ WARNING! Before cleaning the printer, turn the printer off by pressing the Power button  and unplugging the power cord from the electrical socket.

Use a soft, damp, lint-free cloth to wipe dust, smudges, and stains off of the case. Keep fluids away from the interior of the printer, as well as from the printer control panel.

Clean the document feeder (some models only)

If the document feeder picks up multiple pages or if it does not pick up plain paper, you can clean the rollers and separator pad.

⚠ WARNING! Before cleaning the printer, turn the printer off by pressing the Power button  and unplug the power cord from the electrical socket.

1. Remove all originals from the document feeder tray.
2. Lift the document feeder cover.



This provides easy access to the rollers (1) and separator pad (2).

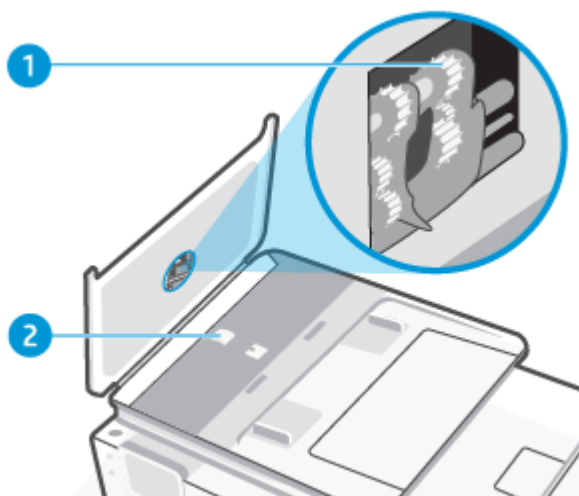

Table 8-2 Clean the document feeder

Feature	Description
1	Rollers
2	Separator pad

3. Lightly dampen a clean lint-free cloth with distilled water, then squeeze any excess liquid from the cloth.
4. Use the damp cloth to wipe any residue off the rollers or separator pad.



NOTE: If the residue does not come off using distilled water, try using isopropyl (rubbing) alcohol.

5. Close the cover of the document feeder.

Maintain the printhead and cartridges

If you are experiencing problems with printing, you might have a problem with the printhead. You should perform the procedures in the following sections only when directed to do so for resolving print quality issues.

Performing the aligning and cleaning procedures unnecessarily can waste ink and shorten the life of the cartridges.

- Clean the printhead if your printed output is streaked or has any incorrect or missing colors.

There are three stages of cleaning. Each stage lasts about two minutes, uses one sheet of paper, and uses an increasing amount of ink. After each stage, review the quality of the printed page. You should only initiate the next phase of cleaning if the print quality is poor.

If print quality still seems poor after you complete all stages of cleaning, try aligning the printhead. If print quality problems persist after cleaning and aligning, contact HP support. For more information, see [To install HP Smart and open the app](#).

- Align the printhead when the printer status page shows streaking or white lines through any of the blocks of color, or if you are having print quality issues with your printouts.

The printer automatically aligns the printhead during the initial setup.

 **NOTE:** Cleaning uses ink, so clean the printhead only when necessary. The cleaning process takes a few minutes. Some noise might be generated in the process.

Always use the Power button to turn off the printer. Turning the printer off improperly can cause print quality problems.

-
1. Load Letter or A4 unused plain white paper into the main tray. For more information, see [Load paper](#).
 2. From the printer control panel, touch or swipe down the tab at the top of the screen to open the Dashboard, and then touch **Setup** .
 3. Touch **Printer Maintenance**, select the desired option, and then follow the onscreen instructions.

 **NOTE:** You can also do the same from the HP printer software or EWS. To access the software or EWS, see [To install HP Smart and open the app](#) or [To access and use EWS](#).

Restore original factory defaults and settings

This topic describes how to restore original factory defaults and settings.

If you disable some functions or change some settings and want to change them back, you can restore the printer to the original factory settings or network settings.

To restore the selected printer functions to the original factory settings

1. From the printer control panel, touch or swipe down the tab at the top of the screen to open the Dashboard, and then touch **Setup** .
2. Touch **Printer Maintenance**.
3. Touch **Restore**.
4. Touch **Restore Settings**.
5. Select one of the following functions to restore to the original factory settings:
 - Copy
 - Scan
 - Network

Touch **Restore**.

A message appears stating that the settings will be restored.

6. Touch **Restore**.

To restore the printer to the original factory defaults

 **NOTE:** For HP+ printers, after restoring the printer, register the printer again using the HP account you used when you first set up the printer.

1. From the printer control panel, touch or swipe down the tab at the top of the screen to open the Dashboard, and then touch **Setup** .
2. Touch **Printer Maintenance**.
3. Touch **Restore**.
4. Touch **Restore Factory Defaults**.
A message appears stating that the factory defaults will be restored.
5. Touch **Continue**.

To restore the printer to the original network settings

1. From the printer control panel, touch or swipe down the tab at the top of the screen to open the Dashboard, and then touch **Setup** .
2. Touch **Network Setup**.
3. Touch **Restore Network Settings**.
A message appears stating that the network defaults will be restored.
4. Touch **Yes**.
5. Print the network configuration page and verify that the network settings have been reset.

 **NOTE:** When you reset the printer network settings, previously configured network-related settings (such as the link speed or IP address) are removed. The IP address is set back to the Automatic mode.

 **TIP:** You can visit the HP online support website at [HP support](https://www.hp.com/support) for information and utilities that can help you correct many common printer problems.

Run the [HP Print and Scan Doctor](#) to diagnose and automatically fix printing issues. If you are using Windows 10, you can run the HP Print and Scan Doctor from HP Smart.

To use Cold Reset to restore settings

Cold Reset removes all user configured settings, including saved administrator passwords, network configurations, selected country/region and language, Address Book entries, and Web Services account information.

 **NOTE:** For HP+ printers, after restoring the printer, register the printer again using the HP account you used when you first set up the printer.

You can use this feature if you are selling the printer or giving it to someone else and want to be sure that all personal information has been removed.

1. From the printer control panel, touch or swipe down the tab at the top of the screen to open the Dashboard, and then touch **Setup** .
2. Touch **Printer Maintenance**.
3. Touch **Restore**.

4. Touch **Cold Reset**.

A message appears, stating what settings will be restored.

5. Touch **Continue**.





HP support

For the latest product updates and support information, visit the product support website at:

hp.com/support.

HP online support provides a variety of options for help with your printer:



Table 8-3 HP support

Icon	Description
	View video tutorials: Learn how to set up the printer and perform common tasks.
	Get troubleshooting assistance: Find information for resolving paper jams, network connection issues, print quality issues, printer errors, and more.
	Get software and drivers: Download software, drivers, and firmware you need for the printer.
	Ask the community: Join the community forums to find solutions, ask questions, and share tips.
	HP Diagnostics Solutions: Use HP online tools to detect your printer and find recommended solutions. You can automatically diagnose and resolve printer issues with HP Print and Scan Doctor . If you are using Windows 10, you can run the HP Print and Scan Doctor from HP Smart.

Contact HP

If you need help from an HP technical support representative to solve a problem, visit the [Contact Support website](#). The following contact options are available at no cost for in-warranty customers (HP agent-assisted support for out-of-warranty customers may require a fee).

Table 8-4 Contact HP

Feature	Description
	Chat with an HP support agent or the HP Virtual Agent online.
	Call an HP support agent.

When contacting HP support, be prepared to provide the following information:

- Product name (Located on the printer)
- Product number and serial number (located near the cartridge access area)

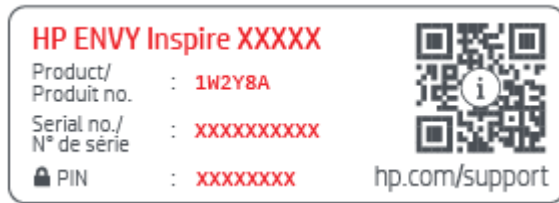

Register printer

By taking just a few quick minutes to register, you can enjoy quicker service, more efficient support, and product support alerts.

If you did not register your printer while installing the software, you can register now at register.hp.com.

Additional warranty options

Extended service plans are available for the printer at additional costs.

Go to hp.com/support, select your country/region and language, then explore the service plan options available for your printer.

9 HP EcoSolutions (HP and the Environment)

HP is committed to helping you optimize your environmental footprint and empowering you to print responsibly—at home or in the office.

For more detailed information about environmental guidelines that HP follows during the manufacturing process, see [Environmental product stewardship program](#).

Power Management

Use **Sleep Mode**, **Auto-Off**, and **Schedule On/Off** to conserve electricity.

Sleep mode

Power usage is reduced while in Sleep mode. After initial setup of printer, the printer will enter Sleep mode after five minutes of inactivity. Use **Sleep Mode**, **Auto-Off** and **Schedule On/Off** to conserve electricity. Use the following instructions to change the period of inactivity before the printer sleeps.

1. From the printer control panel, touch or swipe down the tab at the top of the screen to open the Dashboard, touch the **HP EcoSolutions** .
2. Touch **Sleep Mode**, and then touch the desired option.

Auto-off

This feature turns the printer off after 8 hours of inactivity to help reduce energy use. Auto-Off turns the printer off completely, so you must use the Power button to turn on the printer again.

If your printer supports this energy saving feature, Auto-Off is automatically enabled or disabled depending on printer capabilities and connection options. Even when Auto-Off is disabled, the printer enters Sleep mode after 5 minutes of inactivity to help reduce energy use.

- Auto-Off is enabled when the printer is turned on, if the printer does not have network, fax or Wi-Fi Direct capability, or is not using these capabilities.
- Auto-Off is disabled when a printer's wireless or Wi-Fi Direct capability is turned on or when a printer with fax, USB, or Ethernet network capability establishes a fax, USB, or Ethernet network connection.



Schedule On and Off

Use this feature to automatically turn the printer on or off on selected days. For example, you can schedule the printer to turn on at 8 a.m. and turn off at 8 p.m. from Monday to Friday. In this way, you save energy during the night and weekends.

Use the following instructions to schedule the day and time for On and Off.

1. From the printer control panel, touch or swipe down the tab at the top of the screen to open the Dashboard, touch **HP EcoSolutions** .
2. Touch **Schedule On/Off**.
3. Touch the toggle button next to **Schedule On** or **Schedule Off** to turn it on.

4. Touch the time option, and then follow the onscreen messages to set the day and time to turn the printer off and on.

 **CAUTION:** Always turn the printer off properly, using either **Schedule Off** or the Power button  located on the front left side of the printer.

If you improperly turn the printer off, the print carriage might not return to the correct position, causing problems with the cartridges and print quality issues.

Never turn off the printer when cartridges are missing. HP recommends that you replace any missing cartridges as soon as possible to avoid print quality issues, possible extra ink usage from the remaining cartridges, or damage to the ink system.

Quiet Mode

Quiet Mode slows down printing to reduce overall noise without affecting print quality. It only works when printing on plain paper. Additionally, Quiet Mode is disabled if you are printing using the best or presentation print quality. To reduce printing noise, turn on Quiet Mode. To print at normal speed, turn Quiet Mode off. Quiet Mode is off by default.

 **NOTE:** Quiet Mode does not work if you print photos or envelopes.

You can create a schedule by selecting the time when the printer prints in Quiet Mode. For example, you can schedule the printer to be in Quiet Mode from 10 p.m. to 8 a.m. everyday.

To turn Quiet Mode on or off from the printer control panel

1. From the printer control panel, touch or swipe down the tab at the top of the screen to open the Dashboard, and then touch **Quiet Mode** .
2. Touch the toggle button next to **Quiet Mode** to turn the feature on or off.

 **TIP:** While the printer is printing or while making a copy, you can turn on or turn off Quiet Mode by selecting **Quiet Mode** on the control panel screen. The new settings will take effect after the current page has printed and will only be used for the current job.

To create a schedule for Quiet Mode from the printer control panel

1. From the printer control panel, touch or swipe down the tab at the top of the screen to open the Dashboard, and then touch **Quiet Mode** .
2. Turn on **Quiet Mode**.
3. Touch the toggle button next to **Schedule** to turn it on, and then change the start time and end time of the schedule.

To turn Quiet Mode on or off from EWS

1. Open EWS. For more information, see [To access and use EWS](#).
2. Click the **Settings** tab.
3. In the **Preferences** section, select **Quiet Mode**, and then select **On** or **Off**.

4. Click **Apply**.

Optimize Printing Supplies

To optimize printing supplies such as ink and paper, try the following:

- Recycle used original HP ink cartridges through HP Planet Partners. For more information, visit hp.com/recycle.
- Optimize paper usage by printing on both sides of the paper.
- Change the print quality in the printer driver to a draft setting. The draft setting uses less ink.
- Do not clean the printhead unnecessarily. Doing so wastes ink and shortens the life of the cartridges.

A Technical information

This section contains the following topics:

- Specifications
- Regulatory notices
- Accessibility
- Environmental product stewardship program

Specifications

This topic describes information about printer specifications.

For more information, visit hp.com/support. Select your country or region. Click **Product Support & Troubleshooting**. Enter the name shown on the front of the printer, and then select **Search**. Click **Product information**, and then click **Product specifications**.

System requirements

- For information about software and system requirements or future operating system releases and support, visit the HP online support website at hp.com/support.

Environmental specifications

- Operating temperature: 5° to 40° C (41° to 104° F)
- Operating humidity: 15 to 80% RH non-condensing
- Recommended operating conditions: 15° to 32° C (59° to 90° F)
- Recommended relative humidity: 20 to 80% noncondensing

Main tray capacity

- Plain paper sheets (60 to 105 g/m² [16 to 28 lb]): Up to 125 (100 on specific models)
- Envelopes: Up to 5
- Index cards: Up to 30
- Photo paper sheets: Up to 30

Photo tray capacity

- Photo paper sheets: Up to 15

Output tray capacity

- Plain paper sheets (60 to 105 g/m² [16 to 28 lb]): Up to 60 (text printing)

Paper size and weights

For the list of supported paper sizes, see the HP printer software.

- Plain paper: 60 to 105 g/m² (16 to 28 lb)
- Envelopes: 75 to 90 g/m² (20 to 24 lb)
- Cards: 163 to 200 g/m² (90 to 110 lb)
- Photo paper: Up to 280 g/m² (75 lb)

Print specifications

- Print speeds vary according to the complexity of the document and printer model
- Method: drop-on-demand thermal inkjet
- Language: PCL3 GUI, URF, and PCLm
- **Print resolution:**

For a list of supported print resolutions, visit the printer support website at support.hp.com.

- **Print margins:**

For margin settings of different media, visit the printer support website at support.hp.com.

Power specifications

- Input voltage: 100-240 Vac (+/- 10%)
- Input frequency: 50/60 Hz (+/- 3 Hz)

Copy specifications

- Digital image processing
- Copy speeds vary according to the complexity of the document and printer model

Scan specifications

- **Resolution:** Up to 1200 x 1200 ppi optical

For more information about scan resolution, see the HP printer software.

- **Color:** 24-bit color, 8-bit grayscale (256 levels of gray)
- **Maximum scan size:**
 - Scanner glass: 216 x 297 mm (8.5 x 11.7 inches)

- Document feeder: 216 x 356 mm (8.5 x 14 inches)

Cartridge yield

- Visit hp.com/go/learnaboutsupplies for more information on estimated cartridge yields.

Regulatory notices

The printer meets product requirements from regulatory agencies in your country/region.

Regulatory Model Number

For regulatory identification purposes, your product is assigned with a Regulatory Model Number. The regulatory model number should not be confused with the marketing names or product numbers.

FCC statement

The United States Federal Communications Commission (in 47 CFR 15.105) has specified that the following notice be brought to the attention of users of this product.

This equipment has been tested and found to comply with the limits for a Class B digital device, pursuant to Part 15 of the FCC Rules. These limits are designed to provide reasonable protection against harmful interference in a residential installation. This equipment generates, uses and can radiate radio frequency energy and, if not installed and used in accordance with the instructions, may cause harmful interference to radio communications. However, there is no guarantee that interference will not occur in a particular installation. If this equipment does cause harmful interference to radio or television reception, which can be determined by turning the equipment off and on, the user is encouraged to try to correct the interference by one or more of the following measures:

- Reorient or relocate the receiving antenna.
- Increase the separation between the equipment and the receiver.
- Connect the equipment into an outlet on a circuit different from that to which the receiver is connected.
- Consult the dealer or an experienced radio/TV technician for help.



NOTE: If the product has an Ethernet / LAN port with metallic casing then use of a shielded interface cable is required to comply with the Class B limits of Part 15 of FCC rules.

Modifications (part 15.21)

Any changes or modifications made to this device that are not expressly approved by HP may void the user's authority to operate the equipment.

For further information, contact: Manager of Corporate Product Regulations, HP Inc. 1501 Page Mill Road, Palo Alto, CA 94304, U.S.A.

This device complies with Part 15 of the FCC Rules. Operation is subject to the following two conditions: (1) this device may not cause harmful interference, and (2) this device must accept any interference received, including interference that may cause undesired operation.

Notice to users in Korea

해당 무선설비는 운용 중 전파혼신 가능성이 있으므로 인명안전과 관련된 서비스는 할 수 없음.

B급 기기
(가정용 방송통신기자재)

이 기기는 가정용(B급) 전자파적합기기로서 주로 가정에서 사용하는 것을 목적으로 하며, 모든 지역에서 사용할 수 있습니다.

VCCI (Class B) compliance statement for users in Japan

この装置は、クラスB機器です。この装置は、住宅環境で使用することを目的としていますが、この装置がラジオやテレビジョン受信機に近接して使用されると、受信障害を引き起こすことがあります。
取扱説明書に従って正しい取り扱いをして下さい。 VCCI - B

Power cord instructions

Make sure your power source is adequate for the product voltage rating. The voltage rating is on the product label. The product uses either 100-240 Vac or 200-240 Vac and 50/60 Hz.

⚠ CAUTION: To prevent damage to the product, use only the power cord that is provided with the product.

Notice to users in Japan about the power cord

製品には、同梱された電源コードをお使い下さい。

同梱された電源コードは、他の製品では使用出来ません。

Noise emission statement for Germany

Geräuschemission

LpA < 70 dB am Arbeitsplatz im Normalbetrieb nach DIN 45635 T. 19

European Union and United Kingdom Regulatory Notice



Products bearing the CE marking and UK marking comply to applicable EU Directives and the equivalent UK Statutory Instruments and can operate in at least one EU Member State and in Great Britain. The full EU and UK Declaration of Conformity can be found at the following website: hp.eu/certificates (Search with the product model name or its Regulatory Model Number (RMN), which may be found on the regulatory label.)

The point of contact for regulatory matters:

For EU: HP Deutschland GmbH, HP HQ-TRE, 71025 Boeblingen, Germany

For GB: HP Inc UK Ltd, Regulatory Enquiries, Earley West, 300 Thames Valley Park Drive, Reading, RG6 1PT

Email: techregshelp@hp.com

Products with wireless functionality

EMF

This product meets international guidelines (ICNIRP) for exposure to radio frequency radiation.

If it incorporates a radio transmitting and receiving device that in normal use, a separation distance of 20 cm ensures that radio frequency exposure levels comply with EU requirements.

Wireless functionality in Europe

For products with 802.11 b/g/n or Bluetooth radio:

- Radio frequency band: 2400-2483.5 MHz, with transmit power of 20 dBm (100 mW) or less.

For products with 802.11 a/b/g/n/ac radio:

- Radio frequency band: 2400-2483.5 MHz, with transmit power of 20 dBm (100 mW) or less.
- Radio frequency band: 5170-5330 MHz, with transmit power of 23 dBm (200 mW) or less.
- Radio frequency band: 5490-5730 MHz, with transmit power of 23 dBm (200 mW) or less.
- Radio frequency band: 5735-5835 MHz, with transmit power of 13.98 dBm (25 mW) or less.



AT	BE	BG	CY	CZ
DE	DK	EE	EL	ES
FI	FR	HR	HU	IE
IT	LT	LU	LV	MT
NL	PL	PT	RO	SE
SI	SK	IS	LI	NO
CH	TR	UK(NI)		

AL	BA	MD	ME	MK
RS	UK	XK		

 **IMPORTANT:** IEEE 802.11x wireless LAN with 5.17-5.33 GHz frequency band is restricted for **indoor use only** in all countries reflected in the matrix. Using this WLAN application outdoor might lead to interference issues with existing radio services.

Visual display workplaces statement for Germany

GS-Erklärung (Deutschland)

Das Gerät ist nicht für die Benutzung im unmittelbaren Gesichtsfeld am Bildschirmarbeitsplatz vorgesehen. Um störende Reflexionen am Bildschirmarbeitsplatz zu vermeiden, darf dieses Produkt nicht im unmittelbaren Gesichtsfeld platziert werden.

Notice to users of the U.S. telephone network: FCC requirements

This equipment complies with Part 68 of the FCC rules and the requirements adopted by the ACTA. On the rear (or bottom) of this equipment is a label that contains, among other information, a product identifier in the format US:AAAEQ##TXXXX. If requested, this number must be provided to the telephone company.

Applicable connector jack Universal Service Order Codes ("USOC") for the Equipment is: RJ-11C.

A telephone cord, plug and jack used to connect this equipment to the premises wiring and telephone network must comply with the applicable FCC Part 68 rules and requirements adopted by the ACTA. HP recommends a

compliant plug, jack and 2-wire telephone cord to connect this product to the premises wiring and telephone network. See installation instructions for details.

The REN is used to determine the quantity of devices, which may be connected to the telephone line. Excessive RENs on the telephone line may result in the devices not ringing in response to an incoming call. In most, but not all, areas, the sum of the RENs should not exceed five (5.0). To be certain of the number of devices that may be connected to the line, as determined by the total RENs, contact the telephone company to determine the maximum REN for the calling area. For products approved after July 23, 2001, the REN for this product is part of the product identifier that has the format US-AAAEQ##TXXXX. The digits represented by ## are the REN without a decimal point (e.g., 01 is a REN of 0.1).

If this equipment causes harm to the telephone network, the telephone company will notify you in advance that temporary discontinuance of service may be required. If advance notice is not practical, the telephone company will notify the customer as soon as possible. Also, you will be advised of your right to file a complaint with the FCC if you believe it is necessary.

The telephone company may make changes in its facilities, equipment, operations, or procedures that could affect the operation of the equipment. If this happens, the telephone company will provide advance notice in order for you to make the necessary modifications in order to maintain uninterrupted service.

If trouble is experienced with this equipment, please contact the manufacturer, or look elsewhere in this manual, for repair and (or) warranty information. If the equipment is causing harm to the telephone network, the telephone company may request that you disconnect the equipment from the network until the problem is resolved.

Connection to Party Line Service is subject to state tariffs. Contact the state public utility commission, public service commission, or corporation commission for information.

 **CAUTION:** If your home has specially wired alarm equipment connected to the telephone line, ensure the installation of this equipment does not disable your alarm equipment. If you have questions about what will disable alarm equipment, consult your telephone company or a qualified installer.

WHEN PROGRAMMING EMERGENCY NUMBERS AND (OR) MAKING TEST CALLS TO EMERGENCY NUMBERS:

1. Remain on the line and briefly explain to the dispatcher the reason for the call.
2. Perform such activities in the off-peak hours, such as early morning or late evening.

 **NOTE:** The FCC hearing aid compatibility rules for telephones are not applicable to this equipment.

The Telephone Consumer Protection Act of 1991 makes it unlawful for any person to use a computer or other electronic devices, including FAX machines, to send any message unless such message clearly contains in a margin at the top or bottom of each transmitted page or on the first page of the transmission, the date and time it is sent and an identification of the business or other entity, or other individual sending the message and the telephone number of the sending machine or such business, other entity, or individual. (The telephone number provided may not be a 900 number or any other number for which charges exceed local or long-distance transmission charges.)

In order to program this information into your FAX machine, you should complete the steps described in the software.

Notice to users of the Canadian telephone network

Cet appareil est conforme aux spécifications techniques des équipements terminaux d'Innovation, Science et Développement Economique Canada. Le numéro d'enregistrement atteste de la conformité de l'appareil. L'abréviation ISED qui précède le numéro d'enregistrement indique que l'enregistrement a été effectué dans le cadre d'une Déclaration de conformité stipulant que les spécifications techniques d'Innovation, Science et

Développement Economique Canada ont été respectées. Néanmoins, cette abréviation ne signifie en aucun cas que l'appareil a été validé par Innovation, Science et Développement Economique Canada.

Pour leur propre sécurité, les utilisateurs doivent s'assurer que les prises électriques reliées à la terre de la source d'alimentation, des lignes téléphoniques et du circuit métallique d'alimentation en eau sont, le cas échéant, branchées les unes aux autres. Cette précaution est particulièrement importante dans les zones rurales.

 **REMARQUE:** Le numéro REN (Ringer Equivalence Number) attribué à chaque appareil terminal fournit une indication sur le nombre maximal de terminaux qui peuvent être connectés à une interface téléphonique. La terminaison d'une interface peut se composer de n'importe quelle combinaison d'appareils, à condition que le total des numéros REN ne dépasse pas 5.

Basé sur les résultats de tests FCC Partie 68, le numéro REN de ce produit est 0.1.

This equipment meets the applicable Innovation, Science and Economic Development Canada Terminal Equipment Technical Specifications. This is confirmed by the registration number. The abbreviation ISED before the registration number signifies that registration was performed based on a Declaration of Conformity indicating that Innovation, Science and Economic Development Canada technical specifications were met. It does not imply that Innovation, Science and Economic Development Canada approved the equipment.

Users should ensure for their own protection that the electrical ground connections of the power utility, telephone lines and internal metallic water pipe system, if present, are connected together. This precaution might be particularly important in rural areas.

 **NOTE:** The Ringer Equivalence Number (REN) assigned to each terminal device provides an indication of the maximum number of terminals allowed to be connected to a telephone interface. The termination on an interface might consist of any combination of devices subject only to the requirement that the sum of the Ringer Equivalence Numbers of all the devices does not exceed 5.

The REN for this product is 0.1, based on FCC Part 68 test results.

Notice to users of the German telephone network

Hinweis für Benutzer des deutschen Telefonnetzwerks

Dieses HP-Fax ist nur für den Anschluss eines analogen Public Switched Telephone Network (PSTN) gedacht. Schließen Sie den TAE N-Telefonstecker, der im Lieferumfang des HP All-in-One enthalten ist, an die Wandsteckdose (TAE 6) Code N an. Dieses HP-Fax kann als einzelnes Gerät und/oder in Verbindung (mit seriellen Anschluss) mit anderen zugelassenen Endgeräten verwendet werden.

Australia wired fax statement

In Australia, the HP device must be connected to Telecommunication Network through a line cord which meets the requirements of the Technical Standard AS/ACIF S008.

Regulatory information for wireless products

This section contains the following regulatory information pertaining to wireless products:

Exposure to radio frequency radiation

 **CAUTION:** The radiated output power of this device is far below the FCC radio frequency exposure limits. Nevertheless, the device shall be used in such a manner that the potential for human contact during normal operation is minimized. This product and any attached external antenna, if supported, shall be placed in such a manner to minimize the potential for human contact during normal operation. In order to avoid the

possibility of exceeding the FCC radio frequency exposure limits, human proximity to the antenna shall not be less than 20 cm (8 inches) during normal operation.

Notice to users in Canada (5 GHz)

⚠ CAUTION: When using IEEE 802.11a wireless LAN, this product is restricted to indoor use, due to its operation in the 5.15- to 5.25-GHz frequency range. The Innovation, Science and Economic Development Canada requires this product to be used indoors for the frequency range of 5.15 GHz to 5.25 GHz to reduce the potential for harmful interference to co-channel mobile satellite systems. High-power radar is allocated as the primary user of the 5.25- to 5.35-GHz and 5.65- to 5.85-GHz bands. These radar stations can cause interference with and/or damage to this device.

⚠ ATTENTION: Lors de l'utilisation du réseau local sans fil IEEE 802.11a, ce produit se limite à une utilisation en intérieur à cause de son fonctionnement sur la plage de fréquences de 5,15 à 5,25 GHz. Innovation, Science et Développement Economique Canada stipule que ce produit doit être utilisé en intérieur dans la plage de fréquences de 5,15 à 5,25 GHz afin de réduire le risque d'interférences éventuellement dangereuses avec les systèmes mobiles par satellite via un canal adjacent. Le radar à haute puissance est alloué pour une utilisation principale dans une plage de fréquences de 5,25 à 5,35 GHz et de 5,65 à 5,85 GHz. Ces stations radar peuvent provoquer des interférences avec cet appareil et l'endommager.

Notice to users in Taiwan (5 GHz)

應避免影響附近雷達系統之操作。

高增益指向性天線只得應用於固定式點對點系統。

Notice to users in Serbia (5 GHz)

Upotreba ovog uredjaja je ogranicna na zatvorene prostore u slucajevima koriscenja na frekvencijama od 5150-5350 MHz.

Notice to users in Thailand (5 GHz)

เครื่องวิทยุคมนาคมนี้มีระดับการแผ่คลื่นแม่เหล็กไฟฟ้าสอดคล้องตามมาตรฐานความปลอดภัยต่อสุขภาพของมนุษย์จากการใช้เครื่องวิทยุคมนาคมที่คณะกรรมการกิจการโทรคมนาคมแห่งชาติประกาศกำหนด

This radio communication equipment has the electromagnetic field strength in compliance with the Safety Standard for the Use of Radio Communication Equipment on Human Health announced by the National Telecommunications Commission.

Notice to users in Brazil

Este equipamento opera em caráter secundário, isto é, não tem direito à proteção contra interferência prejudicial, mesmo de estações do mesmo tipo, e não pode causar interferência em sistemas operando em caráter primário. Este equipamento não tem direito à proteção contra interferência prejudicial e não pode causar interferência em sistemas devidamente autorizados.

Para obter mais informações, verifique o site da ANATEL anatel.gov.br.

Notice to users in Canada

Under Innovation, Science and Economic Development Canada regulations, this radio transmitter may only operate using an antenna of a type and maximum (or lesser) gain approved for the transmitter by Innovation, Science and Economic Development Canada. To reduce potential radio interference to other users, the antenna type and its gain should be so chosen that the equivalent isotropically radiated power (e.i.r.p.) is not more than that necessary for successful communication.

This device complies with Innovation, Science and Economic Development Canada licence-exempt RSS standard(s). Operation is subject to the following two conditions: (1) this device may not cause interference, and (2) this device must accept any interference, including interference that may cause undesired operation of the device.

WARNING! Exposure to Radio Frequency Radiation. The radiated output power of this device is below the Innovation, Science and Economic Development Canada radio frequency exposure limits. Nevertheless, the device should be used in such a manner that the potential for human contact is minimized during normal operation.

To avoid the possibility of exceeding the Innovation, Science and Economic Development Canada radio frequency exposure limits, human proximity to the antennas should not be less than 20 cm (8 inches).

Conformément au Règlement d'Innovation, Science et Développement Économique Canada, cet émetteur radioélectrique ne peut fonctionner qu'avec une antenne d'un type et d'un gain maximum (ou moindre) approuvé par Innovation, Science et Développement Économique Canada. Afin de réduire le brouillage radioélectrique potentiel pour d'autres utilisateurs, le type d'antenne et son gain doivent être choisis de manière à ce que la puissance isotrope rayonnée équivalente (p.i.r.e.) ne dépasse pas celle nécessaire à une communication réussie.

Cet appareil est conforme aux normes RSS exemptes de licence d'Innovation, Science et Développement Économique Canada. Son fonctionnement dépend des deux conditions suivantes : (1) cet appareil ne doit pas provoquer d'interférences nuisibles et (2) doit accepter toutes les interférences reçues, y compris des interférences pouvant provoquer un fonctionnement non souhaité de l'appareil.

AVERTISSEMENT relatif à l'exposition aux radiofréquences. La puissance de rayonnement de cet appareil se trouve sous les limites d'exposition de radiofréquences d'Innovation, Science et Développement Économique Canada. Néanmoins, cet appareil doit être utilisé de telle sorte qu'il doive être mis en contact le moins possible avec le corps humain.

Afin d'éviter le dépassement éventuel des limites d'exposition aux radiofréquences d'Innovation, Science et Développement Économique Canada, il est recommandé de maintenir une distance de plus de 20 cm entre les antennes et l'utilisateur.

Notice to users in Taiwan

取得審驗證明之低功率射頻器材，非經核准，公司、商號或使用者均不得擅自變更頻率、加大功率或變更原設計之特性及功能。低功率射頻器材之使用不得影響飛航安全及干擾合法通信；經發現有干擾現象時，應立即停用，並改善至無干擾時方得繼續使用。前述合法通信，指依電信管理法規定作業之無線電通信。低功率射頻器材須忍受合法通信或工業、科學及醫療用電波輻射性電機設備之干擾。

Notice to users in Mexico

La operación de este equipo está sujeta a las siguientes dos condiciones: (1) es posible que este equipo o dispositivo no cause interferencia perjudicial y (2) este equipo o dispositivo debe aceptar cualquier interferencia, incluyendo la que pueda causar su operación no deseada.

Para saber el modelo de la tarjeta inalámbrica utilizada, revise la etiqueta regulatoria de la impresora.

Notice to users in Japan

この機器は技術基準適合証明又は工事設計認証を受けた無線設備を搭載しています。

Dynamic security enabled printers

This printer is intended to work only with cartridges that have new or reused HP electronic circuitry. Reused HP electronic circuitry enables the use of reused, remanufactured, and refilled cartridges.

The printer uses dynamic security measures to block cartridges using modified or non-HP circuitry. Periodic firmware updates delivered over the internet will maintain the effectiveness of the dynamic security measures and block cartridges that previously worked.

Updates can improve, enhance, or extend the printer's functionality and features, protect against security threats, and serve other purposes, but these updates can also block cartridges using modified or non-HP electronic circuitry from working in the printer, including cartridges that work today. Unless you are enrolled in certain HP programs such as Instant Ink or use other services that require automatic online firmware updates, most HP printers can be configured to receive updates either automatically or with a notification that allows you to choose whether to update or not. For more information on dynamic security and how to configure online firmware updates, please go to www.hp.com/learn/ds.

Accessibility

Learn more about our efforts to create accessible products, share your story, or connect with customer support for accessibility help—all at hp.com/accessibility.

For more information about the accessibility of your printer, please visit [Accessibility for HP inkjet printers](#).

Environmental product stewardship program

HP is committed to providing quality products in an environmentally sound manner. Design for recycling has been incorporated into this product. The number of materials has been kept to a minimum while ensuring proper functionality and reliability. Dissimilar materials have been designed to separate easily. Fasteners and other connections are easy to locate, access, and remove using common tools. High priority parts have been designed to access quickly for efficient disassembly and repair. For more information, visit HP's Commitment to the Environment website at:

hp.com/sustainableimpact

HP tips for reducing environmental impact

- Choose from a wide variety of HP papers with FSC® or PEFC™ certification, which indicates that the paper pulp came from a reputable and well-managed source.¹
- Conserve resources—look for paper made with recycled content.
- Recycle your Original HP cartridges—it's easy and free with the HP Planet Partners program, available in 47 countries and territories worldwide.²
- Save paper by printing on both sides of the page.
- Conserve energy by choosing ENERGY STAR® certified HP products.
- Lower your carbon footprint—all HP printers include power management settings that help you control energy use.
- Discover more ways HP and our customers are reducing environmental impact at [HP EcoSolutions](#).

¹ HP papers certified under FSC®C017543 or PEFC™TMPEFC/29-13-198.

² Program availability varies. Original HP cartridge return and recycling is currently available in more than 50 countries, territories, and regions in Asia, Europe, and North and South America through the HP Planet Partners program. For more information, visit: hp.com/recycle.

Eco-Tips

HP is committed to helping customers reduce their environmental footprint. Please visit the HP Eco Solutions website for more information on HP's environmental initiatives.

hp.com/sustainableimpact

Paper

This product is suited for the use of recycled paper according to DIN 19309 and EN 12281:2002.

Plastics

Plastic parts over 25 grams are marked according to international standards that enhance the ability to identify plastics for recycling purposes at the end of product life.

European Union Commission Regulation 1275/2008

For product power data, including the power consumption of the product in networked standby if all wired network ports are connected and all wireless network ports are activated, please refer to section P15 'Additional Information' of the product IT ECO Declaration at hp.com/hpinfo/globalcitizenship/environment/productdata/itecodesktop-pc.html.

Safety data sheets

Safety Data Sheets, product safety and environmental information are available at hp.com/go/ecodata or on request.

Chemical substances

HP is committed to providing our customers with information about the chemical substances in our products as needed to comply with legal requirements such as REACH (*Regulation EC No 1907/2006 of the European Parliament and the Council*). A chemical information report for this product can be found at: hp.com/go/reach.

EPEAT

Most HP products are designed to meet EPEAT. EPEAT is a comprehensive environmental rating that helps identify greener electronics equipment. For more information on EPEAT go to epeat.net.

[Click here for information on HP's EPEAT registered products.](#)

SEPA Ecolabel User Information (China)

中国环境标识认证产品用户说明

噪声大于 63.0 dB(A) 的办公设备不宜放置于办公室内，请在独立的隔离区域使用。

如需长时间使用本产品或打印大量文件，请确保在通风良好的房间内使用。

如您需要确认本产品处于零能耗状态，请按下电源关闭按钮，并将插头从电源插座断开。

您可以使用再生纸，以减少资源耗费。

Recycling program

HP offers an increasing number of product return and recycling programs in many countries/regions, and partners with some of the largest electronic recycling centers throughout the world. HP conserves resources

by reselling some of its most popular products. For more information regarding recycling of HP products, please visit: hp.com/recycle

HP inkjet supplies recycling program

HP is committed to protecting the environment. The HP Inkjet Supplies Recycling Program is available in many countries/regions, and lets you recycle used print cartridges and ink cartridges free of charge. For more information, go to the following website: hp.com/recycle

Battery disposal in Taiwan



廢電池請回收

California Perchlorate Material Notice

Perchlorate material - special handling may apply. See: dtsc.ca.gov/hazardouswaste/perchlorate

This product's real-time clock battery or coin cell battery may contain perchlorate and may require special handling when recycled or disposed of in California.

European Union Battery Directive



This product contains a battery that is used to maintain data integrity of real time clock or product settings and is designed to last the life of the product. Any attempt to service or replace this battery should be performed by a qualified service technician.

Battery notice for Brazil

A bateria deste equipamento nao foi projetada para ser removida pelo cliente.

Power consumption

HP printing and imaging equipment marked with the ENERGY STAR® logo is certified by the U.S. Environmental Protection Agency. The following mark will appear on ENERGY STAR certified imaging products:



Additional ENERGY STAR certified imaging product model information is listed at: hp.com/go/energystar

China Energy Label for Printer, Fax and Copier

复印机、打印机和传真机能源效率标识实施规则

依据“复印机、打印机和传真机能源效率标识实施规则”，该打印机具有中国能效标识。标识上显示的能效等级和操作模式值根据“复印机、打印机和传真机能效限定值及能效等级”标准（“GB 21521”）来确定和计算。

1. 能效等级

产品能效等级分3级，其中1级能效最高。能效限定值根据产品类型和打印速度由标准确定。能效等级则根据基本功耗水平以及网络接口和内存等附加组件和功能的功率因子之和来计算。

2. 能效信息

喷墨打印机

- 操作模式功率

睡眠状态的能耗按照 GB 21521 的标准来衡量和计算。该数据以瓦特 (W) 表示。

- 待机功率

待机状态是产品连接到电网电源上功率最低的状态。该状态可以延续无限长时间，且使用者无法改变此状态下产品的功率。对于“成像设备”产品，“待机”状态通常相当于“关闭”状态，但也可能相当于“准备”状态或者“睡眠”状态。该数据以瓦特 (W) 表示。

- 睡眠状态预设延迟时间

出厂前由制造商设置的时间决定了该产品在完成主功能后进入低耗模式（例如睡眠、自动关机）的时间。该数据以分钟表示。

- 附加功能功率因子之和

网络接口和内存等附加功能的功率因子之和。该数据以瓦特 (W) 表示。

标识上显示的能耗数据是根据典型配置测量得出的数据，此类配置包含登记备案的打印机依据复印机、打印机和传真机能源效率标识实施规则所选的所有配置。因此，该特定产品型号的实际能耗可能与标识上显示的数据有所不同。

要了解规范的更多详情，请参考最新版的 GB 21521 标准。

Disposal of waste equipment by users



This symbol means do not dispose of your product with your other household waste. Instead, you should protect human health and the environment by handing over your waste equipment to a designated collection point for the recycling of waste electrical and electronic equipment. For more information, please contact your household waste disposal service, or go to hp.com/recycle.

Waste disposal for Brazil



Este produto eletrônico e seus componentes não devem ser descartados no lixo comum, pois embora estejam em conformidade com padrões mundiais de restrição a substâncias nocivas, podem conter, ainda que em quantidades mínimas, substâncias impactantes ao meio ambiente. Ao final da vida útil deste produto, o usuário deverá entregá-lo à HP. A não observância dessa orientação sujeitará o infrator às sanções previstas em lei.

Após o uso, as pilhas e/ou baterias dos produtos HP deverão ser entregues ao estabelecimento comercial ou rede de assistência técnica autorizada pela HP.

Para maiores informações, inclusive sobre os pontos de recebimento, acesse:

hp.com.br/reciclar

The Table of Hazardous Substances/Elements and their Content (China)

产品中有有害物质或元素的名称及含量

根据中国《电器电子产品有害物质限制使用管理办法》



Table A-1 The Table of Hazardous Substances/Elements and their Content (China)

部件名称	有害物质					
	铅 (Pb)	汞 (Hg)	镉 (Cd)	六价铬 (Cr(VI))	多溴联苯 (PBB)	多溴二苯醚 (PBDE)
外壳和托盘	○	○	○	○	○	○
电线	○	○	○	○	○	○
印刷电路板	X	○	○	○	○	○
打印系统	X	○	○	○	○	○
显示器	X	○	○	○	○	○
喷墨打印机墨盒	○	○	○	○	○	○
驱动光盘	X	○	○	○	○	○
扫描仪	X	○	○	○	○	○
网络配件	X	○	○	○	○	○
电池板	X	○	○	○	○	○
自动双面打印系统	○	○	○	○	○	○
外部电源	X	○	○	○	○	○

本表格依据 SJ/T 11364 的规定编制。

Table A-1 The Table of Hazardous Substances/Elements and their Content (China) (continued)

部件名称	有害物质					
	铅 (Pb)	汞 (Hg)	镉 (Cd)	六价铬 (Cr(VI))	多溴联苯 (PBB)	多溴二苯醚 (PBDE)
○:表示该有害物质在该部件所有均质材料中的含量均在 GB/T 26572 规定的限量要求以下。						
X:表示该有害物质至少在该部件的某一均质材料中的含量超出 GB/T 26572 规定的限量要求。						
此表中所有名称中含“X”的部件均符合中国 RoHS 达标管理目录限用物质应用例外清单的豁免。						
此表中所有名称中含“X”的部件均符合欧盟 RoHS 立法。						
注:环保使用期限的参考标识取决于产品正常工作的温度和湿度等条件。						

Regulation on the Control of Waste Electrical and Electronic Equipment (Turkey)

Türkiye Cumhuriyeti: AEEE Yönetmeliğine uygundur

Restriction of hazardous substance (India)

This product, as well as its related consumables and spares, complies with the reduction in hazardous substances provisions of the "India E-waste (Management and Handling) Rule 2016." It does not contain lead, mercury, hexavalent chromium, polybrominated biphenyls or polybrominated diphenyl ethers in concentrations exceeding 0.1 weight % and 0.01 weight % for cadmium, except for where allowed pursuant to the exemptions set in Schedule 2 of the Rule.

Declaration of the Presence Condition of the Restricted Substances Marking (Taiwan)

台灣 限用物質含有情況標示聲明書

Taiwan Declaration of the Presence Condition of the Restricted Substances Marking

單元 unit	限用物質及其化學符號 Restricted substances and chemical symbols					
	鉛 (Pb)	汞 (Hg)	鎘 (Cd)	六價鉻 (Cr ⁶⁺)	多溴聯苯 (PBB)	多溴二苯醚 (PBDE)
列印引擎 Print engine	—	○	○	○	○	○
外殼和紙匣 External Casing and Trays	○	○	○	○	○	○
電源供應器 Power Supply	—	○	○	○	○	○
電線 Cables	○	○	○	○	○	○
印刷電路板 Print printed circuit board	—	○	○	○	○	○
控制面板 Control panel	—	○	○	○	○	○
墨水匣 Cartridge	○	○	○	○	○	○
掃描器組件 Scanner assembly	—	○	○	○	○	○
備考 1. “超出 0.1wt%”及“超出 0.01wt%”係指限用物質之百分比含量超出百分比含量基準值。 Note 1: “Exceeding 0.1 wt %” and “exceeding 0.01 wt %” indicate that the percentage content of the restricted substance exceeds the reference percentage value of presence condition. 備考 2. “○”係指該項限用物質之百分比含量未超出百分比含量基準值。 Note 2: “○” indicates that the percentage content of the restricted substance does not exceed the percentage of reference value of presence. 備考 3. “—”係指該項限用物質為排除項目 Note 3: “—” indicates that the restricted substance corresponds to the exemption.						

若要存取產品的最新使用指南或手冊，請前往 hp.com/support。選取**搜尋您的產品**，然後依照 畫面上的指示繼續執行。

To access the latest user guides or manuals for your product, go to hp.com/support. Select **Find your product**, and then follow the on-screen instructions.