

# SAMSUNG

# FULL MANUAL

---

## HW-Q900A

Imagine the possibilities

Thank you for purchasing this Samsung product.

To receive more complete service, please register your product at  
[www.samsung.com/register](http://www.samsung.com/register)

# SAFETY INFORMATION









- The following also applies to the Wireless Subwoofer (PS-WA95B).

## SAFETY WARNINGS

TO REDUCE THE RISK OF ELECTRIC SHOCK, DO NOT REMOVE THE COVER (OR BACK).

NO USER-SERVICEABLE PARTS ARE INSIDE. REFER SERVICING TO QUALIFIED SERVICE PERSONNEL.

Refer to the table below for an explanation of symbols which may be on your Samsung product.

	<b>CAUTION</b> <b>RISK OF ELECTRIC SHOCK. DO NOT OPEN.</b>	
	This symbol indicates that high voltage is present inside. It is dangerous to make any kind of contact with any internal part of this product.	
	This symbol indicates that this product has included important literature concerning operation and maintenance.	
	Class II product : This symbol indicates that a safety connection to electrical earth (ground) is not required. If this symbol is not present on a product with a power cord, the product MUST have a reliable connection to protective earth (ground).	
	AC voltage : Rated voltage marked with this symbol is AC voltage.	
	DC voltage : Rated voltage marked with this symbol is DC voltage.	
	Caution. Consult Instructions for use : This symbol instructs the user to consult the user manual for further safety related information.	

### WARNING

- To reduce the risk of fire or electric shock, do not expose this appliance to rain or moisture.
- To prevent injury, this apparatus must be securely attached to the floor/wall in accordance with the installation instructions.
- This product contains chemicals known to the State of California to cause cancer and birth defects or other reproductive harm.

### CAUTION

- Do not expose this apparatus to dripping or splashing. Do not put objects filled with liquids, such as vases, on the apparatus.
- To turn this apparatus off completely, you must pull the power plug out of the wall socket. Consequently, the power plug must be easily and readily accessible at all times.

### FCC NOTE (for U.S.A):

#### FCC Supplier's Declaration of Conformity

#### Responsible Party - U.S. Contact Information:

Samsung Electronics America, Inc.  
85 Challenger Road.  
Ridgefield Park, NJ 07660  
Phone: 1-800-SAMSUNG (726-7864)

### FCC Compliance Statement :

This device complies with Part 15 of the FCC Rules.

Operation is subject to the following two conditions:

- (1) This device may not cause harmful interference, and (2) this device must accept any interference received, including interference that may cause undesired operation.

### FCC Caution :

- Any changes or modifications not expressly approved by the party responsible for compliance could void the user's authority to operate this equipment.
- This product satisfies FCC regulations when shielded cables and connectors are used to connect the unit to other equipment. To prevent electromagnetic interference with electric appliances, such as radios and televisions, use shielded cables and connectors for connections.

### Class B FCC Statement

This equipment has been tested and found to comply with the limits for a Class B digital device, pursuant to Part 15 of the FCC Rules. These limits are designed to provide reasonable protection against harmful interference in a residential installation. This equipment generates, uses and can radiate radio frequency energy and, if not installed and used in accordance with the instructions, may cause harmful interference to radio communications. However, there is no guarantee that interference will not occur in a particular installation. If this equipment does cause harmful interference to radio or television reception, which can be determined by turning the equipment off and on, the user is encouraged to try to correct the interference by one of the following measures:

- Reorienting or relocating the receiving antenna.
- Increasing the separation between the equipment and receiver.
- Connecting the equipment to an outlet that is on a different circuit than the radio or TV.
- Consulting the dealer or an experienced radio/TV technician for help.

### FCC Radiation Exposure Statement :

This equipment complies with FCC radiation exposure limits set forth for an uncontrolled environment. This equipment should be installed and operated so there is at least 8 inches (20 cm) between the radiator and your body. This device and its antenna(s) must not be co-located or operated in conjunction with any other antenna or transmitter.

### CALIFORNIA USA ONLY (Applicable for networking models only.)

This Perchlorate warning applies only to primary CR(Manganese Dioxide) Lithium coin cells in the product sold or distributed ONLY in California USA "Perchlorate Material - special handling may apply, See [www.dtsc.ca.gov/hazardouswaste/perchlorate](http://www.dtsc.ca.gov/hazardouswaste/perchlorate)."

Dispose unwanted electronics through an approved recycler. To find the nearest recycling location, go to our website:[www.samsung.com/recycling](http://www.samsung.com/recycling) Or call, 1-800-SAMSUNG

 **WARNING: Cancer and Reproductive Harm - [www.P65Warnings.ca.gov](http://www.P65Warnings.ca.gov).**

### Important Safety Instructions

Read these operating instructions carefully before using the unit. Follow all the safety instructions listed below. Keep these operating instructions handy for future reference.

1. Read these instructions.

2. Keep these Instructions.
3. Heed all warnings.
4. Follow all instructions.
5. Do not use this apparatus near water.
6. Clean only with dry cloth.
7. Do not block any ventilation openings.  
Install in accordance with the manufacturer's instructions.
8. Do not install near any heat sources such as radiators, heat registers, stoves, or other apparatus (including amplifiers) that produce heat.
9. Do not defeat the safety purpose of the polarized or grounding-type plug.  
A polarized plug has two blades with one wider than the other. A grounding type plug has two blades and a third grounding prong. The wide blade or the third prong are provided for your safety. If the provided plug does not fit into your outlet, consult an electrician for replacement of the obsolete outlet.
10. Protect the power cord from being walked on or pinched particularly at plugs, convenience receptacles, and the point where they exit from the apparatus.
11. Only use attachments/accessories specified by the manufacturer.
12. Use only with the cart, stand, tripod, bracket, or table specified by the manufacturer, or sold with the apparatus. When a cart is used, use caution when moving the cart/apparatus combination to avoid injury from tip-over.
13. Unplug this apparatus during lightning storms or when unused for long periods of time.
14. Refer all servicing to qualified service personnel. Servicing is required when the apparatus has been damaged in any way, such as power-supply cord or plug is damaged, liquid has been spilled or objects have fallen into the apparatus, the apparatus has been exposed to rain or moisture, does not operate normally, or has been dropped.



## PRECAUTIONS

1. Ensure that the AC power supply in your house complies with the power requirements listed on the identification sticker located on the bottom of your product. Install your product horizontally, on a suitable base (furniture), with enough space around it for ventilation (3~4 inches). Make sure the ventilation slots are not covered. Do not place the unit on amplifiers or other equipment which may become hot. This unit is designed for continuous use. To fully turn off the unit, disconnect the AC plug from the wall outlet. Unplug the unit if you intend to leave it unused for a long period of time.
2. During thunderstorms, disconnect the AC plug from the wall outlet. Voltage peaks due to lightning could damage the unit.
3. Do not expose the unit to direct sunlight or other heat sources. This could lead to overheating and cause the unit to malfunction.
4. Protect the product from moisture (i.e. vases), and excess heat (e.g. a fireplace) or equipment creating strong magnetic or electric fields. Unplug the power cable from the AC wall socket if the unit malfunctions. Your product is not intended for industrial use. It is for personal use only. Condensation may occur if your product has been stored in cold temperatures. If transporting the unit during the winter, wait approximately 2 hours until the unit has reached room temperature before using.

5. The battery used with this product contains chemicals that are harmful to the environment. Do not dispose of the battery in the general household trash. Do not expose the battery to excess heat, direct sunlight, or fire. Do not short circuit, disassemble, or overheat the battery.

CAUTION : Danger of explosion if the battery is replaced incorrectly. Replace only with the same or equivalent type.

### Fabric cleaning

**Remove any dirt or stain on the product surface immediately.**

Removing and cleaning can be less effective for some substances or if left for a prolonged time.

#### CAUTION

- Use a vacuum cleaner or an adhesive lint roller to remove dust, handprints, and the likes.
  - Some cleaning brushes may damage the product, depending on the materials they contain.
  - Towels and cleaning clothes may leave lint or dirt on the product.
- Do not use a nail or other tools to scratch the dirt off. It may damage the fabric.
- To remove oil or liquid stains, use a clean white cloth moist with water. If the stain persists, wipe it with a mixture of water and neutral detergent (such as dishwashing soaps) and a cloth.
  - A non-neutral detergent or cleaner may cause discoloration or fabric damage.
  - After cleaning, use a dry cloth or hairdryer to dry the area.
  - Do not use excessive force to avoid discoloration or fabric damage.

# CONTENTS

<b>01</b>	<b>Checking the Components</b>	<b>6</b>
<b>02</b>	<b>Product Overview</b>	<b>7</b>
	Top Panel of the Soundbar .....	7
	Bottom Panel of the Soundbar .....	7
<b>03</b>	<b>Using the Soundbar Remote Control</b>	<b>9</b>
	Inserting Batteries before using the Remote Control (AA batteries X 2) .....	9
	How to Use the Remote Control .....	9
	Active Voice Amplifier (AVA) .....	10
	Using the Hidden Buttons (Buttons with more than one function) .....	10
	Output specifications for the different sound effect modes .....	11
	Adjusting the Soundbar volume with a TV remote control .....	12
<b>04</b>	<b>Connecting the Soundbar</b>	<b>13</b>
	Connecting the power and units .....	13
	– Manually connecting the Subwoofer .....	14
	– LED Indicator Lights on the Rear of Subwoofer .....	14
	– Auto EQ .....	15
	Connecting an SWA-9500S (Sold Separately) to your Soundbar .....	15
<b>05</b>	<b>Using a wired connection to the tv</b>	<b>16</b>
	Method 1. Connecting with HDMI .....	16
	– Connecting the TV that supports HDMI ARC (Audio Return Channel) .....	16
	Method 2. Connecting using an Optical Cable .....	17
<b>06</b>	<b>Using a wireless connection to the TV</b>	<b>18</b>
	Method 1. Connecting via Bluetooth .....	18
	Method 2. Connecting via Wi-Fi .....	19
<b>07</b>	<b>Connecting an External Device</b>	<b>20</b>
	Method 1. Connecting using an HDMI Cable (Capable of Dolby Atmos decoding and playback) .....	20
	Method 2. Connecting using an Optical Cable .....	21
<b>08</b>	<b>Connecting a Mobile Device</b>	<b>22</b>
	Method 1. Connecting via Bluetooth .....	22
	Method 2. Connecting via Wi-Fi (Wireless Network) .....	23
	Getting Started with Amazon Alexa (Built-in Alexa) .....	24
	Getting Started with Alexa on Amazon Product (Works with Alexa) .....	25
	Using the Tap Sound .....	26
<b>09</b>	<b>Connecting To Apple AirPlay 2</b>	<b>27</b>
	Connect and use with an Apple product .....	27



<b>10</b>	<b>Installing the Wall Mount</b>	<b>28</b>
	Installation Precautions .....	28
	Wallmount Components.....	28
<b>11</b>	<b>Installing the Soundbar above a TV Stand</b>	<b>29</b>
	Component .....	29
<b>12</b>	<b>Software Update</b>	<b>30</b>
	Auto Update.....	30
	USB Update .....	30
	Initialization.....	31
<b>13</b>	<b>Troubleshooting</b>	<b>31</b>
<b>14</b>	<b>License</b>	<b>33</b>
<b>15</b>	<b>Open Source License Notice</b>	<b>33</b>
<b>16</b>	<b>Important Notes About Service</b>	<b>33</b>
<b>17</b>	<b>Specifications and Guide</b>	<b>34</b>
	Specifications .....	34

# 01 CHECKING THE COMPONENTS



Soundbar Main Unit



Soundbar Remote Control (AH59-02767A) /  
Batteries



Subwoofer



Power Cord (Subwoofer, Soundbar)  
(3903-001117)



HDMI Cable (BN39-01997A)



Wall Mount Guide (AH63-04369C)



Holder-Screw (AH61-04110A)



Screw (6001-001202)



Bracket-Wall Mount (AH61-04119A)



Rubber-Foot (BN67-00398L)

- For more information about the power supply and power consumption, refer to the label attached to the product. (Label: Rear of the Soundbar Main Unit)
- To purchase additional components or optional cables, contact a Samsung Service Center or Samsung Customer Care.
- For more information about the wallmount or rubber-foot, see pages 28~30.
- Design, specifications, and App screen are subject to change without prior notice.
- The appearance of the accessories may differ slightly from the illustrations above.

# 02 PRODUCT OVERVIEW

## Top Panel of the Soundbar

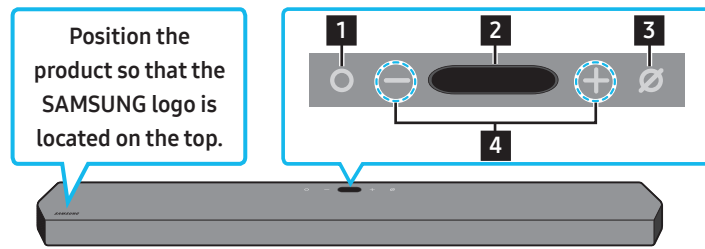

1	<b>○ (Multi Function) Button</b> <ul style="list-style-type: none"> <li>In standby mode, press the <b>○ (Multi Function)</b> button to turn on the Soundbar.</li> <li>Press the <b>○ (Multi Function)</b> button to change the input source.</li> </ul>
2	<b>Display</b> Displays the product's status and current mode. <b>D.IN → HDMI 1 → HDMI 2 → Wi-Fi → BT</b>
3	<b>⊘ (Mic On/Off) Button</b> Press the button to turn the microphone on or off.
4	<b>— + (Volume) Button</b> Adjusts the volume.

- When you plug in the AC cord, the power button will begin working in 4 to 6 seconds.
- When you turn on this unit, there will be a 4 to 5 second delay before it produces sound.
- If you hear sounds from both the TV and Soundbar, go to the **Settings** menu for the TV audio and change the TV speaker to **External Speaker**.

## Bottom Panel of the Soundbar

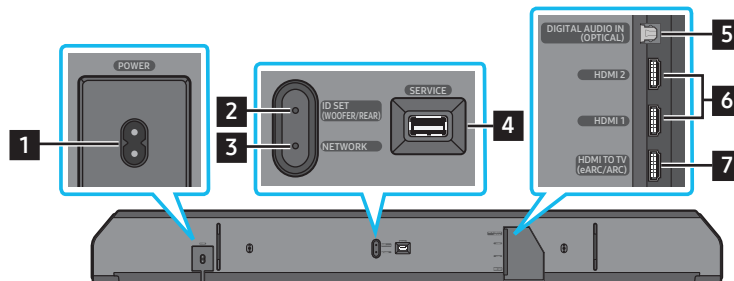

1	<b>POWER</b> Connect the Soundbar's AC power cable. (See page 13)
2	<b>ID SET (WOOFER/REAR)</b> Press to connect the Soundbar to surround speakers and a subwoofer wirelessly. (The surround speaker is sold separately.)
3	<b>NETWORK</b> Press to connect to a wireless network (Wi-Fi) via the <b>SmartThings</b> app.
4	<b>SERVICE</b> Connect a USB storage device to upgrade the product's software.
5	<b>DIGITAL AUDIO IN (OPTICAL)</b> Connect to the digital (optical) output of an external device. (See page 21)
6	<b>HDMI 1 / HDMI 2</b> Inputs digital video and audio signals simultaneously using an HDMI cable. Connect to the HDMI output of an external device. (See page 20)

- When disconnecting the power cord from a wall outlet, pull the plug. Do not pull the cable.
- Do not connect this unit or other components to an AC outlet until all connections between components are complete.

# 03 USING THE SOUNDBAR REMOTE CONTROL





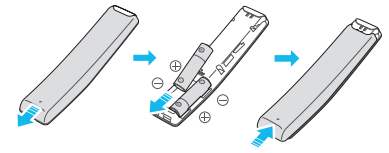

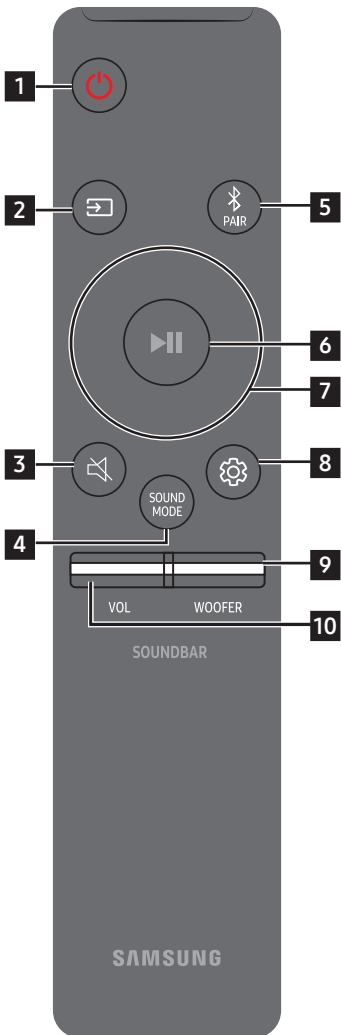

## Inserting Batteries before using the Remote Control (AA batteries X 2)







Slide the back cover in the direction of the arrow until it is completely removed. Insert 2 AA batteries (1.5V) oriented so that their polarity is correct. Slide the battery cover back into position.

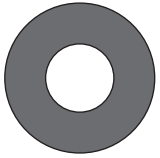

## How to Use the Remote Control

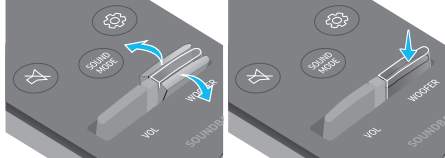

<p><b>1</b></p>	 <b>Power</b>	<p>Turns the Soundbar on and off.</p> <ul style="list-style-type: none"> <li>• <b>Auto Power Down Function</b> The unit turns off automatically in the following situations: <ul style="list-style-type: none"> <li>• In <b>D.IN / HDMI 1 / HDMI 2 / Wi-Fi / BT</b> mode if there is no audio signal for 18 minutes.</li> </ul> </li> </ul>
<p><b>2</b></p>	 <b>Source</b>	<p>Press to select a source connected to the Soundbar.</p> <ul style="list-style-type: none"> <li>• <b>Voice Feedback On/Off</b> You can turn on or off the Voice Feedback. Press and hold the  (<b>Source</b>) button on the remote control for 5 seconds while the Soundbar is off (Standby mode). Each time you change the Voice Feedback setting, the OLED Display will show "<b>AUI OFF</b>" (Default) or "<b>AUI ON</b>".</li> </ul>
<p><b>3</b></p>	 <b>Mute</b>	<p>Press the  (<b>Mute</b>) button to mute the sound. Press it again to unmute the sound.</p>
<p><b>4</b></p>	 <b>SOUND MODE</b>	<p>You can select the desired sound mode by choosing <b>STANDARD</b>, <b>SURROUND</b>, <b>GAME PRO</b>, or <b>ADAPTIVE SOUND</b>.</p> <ul style="list-style-type: none"> <li>• <b>STANDARD</b> Outputs the original sound.</li> <li>• <b>SURROUND</b> Provides a wider sound field than standard.</li> <li>• <b>GAME PRO</b> Provides stereoscopic sound to immerse you in the action while gaming.</li> <li>• <b>ADAPTIVE SOUND</b> Analyzes the content in real time and automatically provides the optimal sound field based on the characteristics of the content.</li> </ul>
<p><b>5</b></p>	 <b>Bluetooth PAIR</b>	<p>Switch the Soundbar to Bluetooth pairing mode. Press the button and wait for the "<b>BT PAIRING</b>" screen to connect to a new Bluetooth device.</p>
<p><b>6</b></p>	 <b>Play / Pause</b>	<p>You can also play or pause music by pressing the button.</p>

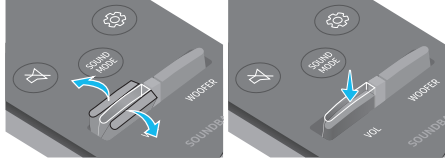
<p><b>7</b></p>	 <p>Up/Down/Left/Right</p>	 <p>Press the indicated areas to select Up/Down/Left/Right.</p> <p>Press Up/Down/Left/Right on the button to select or set functions.</p> <ul style="list-style-type: none"> <li>• <b>Music Skip</b> Press the <b>Right</b> button to select the next music file. Press the <b>Left</b> button to select the previous music file.</li> <li>• <b>ID SET</b> Use this option when the Subwoofer or Surround Speakers are not connected or need reconnection. While powered off, press and hold the <b>Up</b> button for 5 seconds to perform <b>ID SET</b>. (See page 14.)</li> </ul>
<p><b>8</b></p>	 <p>Sound Control</p>	<p>When pressed, the setting items such as <b>AUTO EQ, AVA, TREBLE, BASS, SYNC, CENTER LEVEL, SIDE LEVEL, FRONT TOP LEVEL, and VIRTUAL ON/OFF</b> are displayed in sequence. The desired item can be adjusted using the <b>Up/Down</b> buttons.</p> <ul style="list-style-type: none"> <li>• To control the volume of the treble or bass sound, select <b>TREBLE</b> or <b>BASS</b> in Sound Settings, and then adjust the volume between -6~+6 by using the <b>Up/Down</b> buttons.</li> <li>• Press and hold the  (<b>Sound Control</b>) button for about 5 seconds to adjust the sound for each frequency band. 150Hz, 300Hz, 600Hz, 1.2kHz, 2.5kHz, 5kHz, and 10kHz are selectable using the <b>Left/Right</b> buttons and each can be adjusted to a setting between -6 to +6 using the <b>Up/Down</b> buttons. (Make sure the Sound mode is set to "STANDARD".)</li> <li>• To control the volume of the each speaker select <b>CENTER LEVEL, SIDE LEVEL, or FRONT TOP LEVEL</b> in Sound Settings, and then adjust the volume between -6~+6 by using the <b>Up/Down</b> buttons.</li> <li>• If the video on the TV and audio from the Soundbar are not synchronized, select <b>SYNC</b> in Sound Control, and then set the audio delay between 0~300 milliseconds by using the <b>Up/Down</b> buttons.</li> <li>• <b>SYNC</b> is only supported for some functions.</li> <li>• If Surround Speakers are connected, select <b>REAR LEVEL</b> or <b>REAR TOP LEVEL</b> and then use the <b>Up/Down</b> buttons to adjust the volume within a -6 to +6 range.</li> <li>• The <b>VIRTUAL</b> Speaker function can be turned <b>ON/OFF</b> by using the <b>Up/Down</b> buttons.</li> <li>• You can use the <b>AUTO EQ</b> function if a subwoofer is connected.</li> </ul>
<p><b>9</b></p>	 <p>WOOFER LEVEL</p>	 <p>Push the button up or down to adjust the level of the woofer to -12 or between -6 to +6. To set the woofer volume level to 0 (Default), press the button.</p>
<p><b>10</b></p>	 <p>VOLUME</p>	 <p>Push the button up or down to adjust the volume.</p> <ul style="list-style-type: none"> <li>• <b>Mute</b> Press the <b>VOL</b> button to mute the sound. Press it again to unmute the sound.</li> </ul>

## Active Voice Amplifier (AVA)

- Analyses external noise in real time while soundbar is playing, so that voice audio can always be heard clearly.
- No data is saved during the analysis.

## Using the Hidden Buttons (Buttons with more than one function)

Hidden Button		Reference page
Remote Control Button	Function	
WOOFER (Up)	TV remote control On/Off (Standby)	page 12
Up	ID SET	page 14
 (Sound Control)	7 Band EQ	page 10

## Output specifications for the different sound effect modes

Effect	Input	Output	
		With Subwoofer only	With Subwoofer & Wireless Rear Speaker Kit
STANDARD	2.0 ch	2.1 ch	2.1 ch
	5.1 ch	5.1 ch / 7.1 ch (DTS)	5.1 ch / 7.1 ch (DTS)
	7.1 ch	7.1 ch	7.1 ch
	Dolby Atmos®, DTS:X	7.1.2 ch	7.1.4 ch
SURROUND	2.0 ch	7.1.2 ch	9.1.4 ch
	5.1 ch	7.1.2 ch	9.1.4 ch
	7.1 ch	7.1.2 ch	9.1.4 ch
	Dolby Atmos®, DTS:X	7.1.2 ch	9.1.4 ch
GAME PRO	2.0 ch	7.1.2 ch	9.1.4 ch
	5.1 ch	7.1.2 ch	9.1.4 ch
	7.1 ch	7.1.2 ch	9.1.4 ch
	Dolby Atmos®, DTS:X	7.1.2 ch	9.1.4 ch
ADAPTIVE SOUND	2.0 ch	7.1.2 ch	9.1.4 ch
	5.1 ch	7.1.2 ch	9.1.4 ch
	7.1 ch	7.1.2 ch	9.1.4 ch
	Dolby Atmos®, DTS:X	7.1.2 ch	9.1.4 ch

- The Samsung Wireless Rear Speaker Kit can be purchased separately. To purchase a Kit or the Subwoofer, contact the vendor you purchased the Soundbar from.
- The Surround Speakers will not produce sounds for 2 channel output while **STANDARD** mode is in use. To enable sound for the Surround Speakers, change the effect mode to **SURROUND**.

# Adjusting the Soundbar volume with a TV remote control







Adjust the Soundbar volume using the TV's remote control.

- This function can be used with IR remote controls only. Bluetooth remote controls (remote controls that require pairing) are not supported.
- Set the TV speaker to **External Speaker** to use this function.
- Manufacturers supporting this function:  
VIZIO, LG, Sony, Sharp, PHILIPS, PANASONIC, TOSHIBA, Hisense, RCA

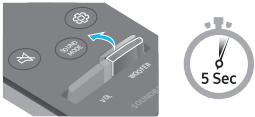
## 1. Turn Off the Soundbar.

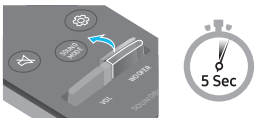
Push up and hold the **WOOFER** button for 5 seconds.

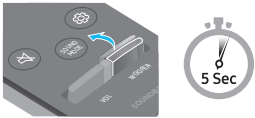
Each time you push the **WOOFER** button up and hold it for 5 seconds, the mode switches in the following order: "OFF-TV REMOTE" (Default mode), "SAMSUNG-TV REMOTE", "ALL-TV REMOTE".

Remote Control Button	Display	Status
	(Default mode) <b>OFF-TV REMOTE</b> 	Disable the TV remote control.
	<b>SAMSUNG-TV REMOTE</b> 	Enable a Samsung TV's IR remote control.
	<b>ALL-TV REMOTE</b> 	Enable a third-party TV's IR remote control.



# 04 CONNECTING THE SOUNDBAR

## Connecting the power and units

Use the Power cord to connect the Subwoofer and Soundbar to an electrical outlet in the following order:

- For more information about the required electrical power and power consumption, refer to the label attached to the product. (Label: Rear of the Soundbar Main Unit)

1. Connect the Power cord to the Subwoofer.

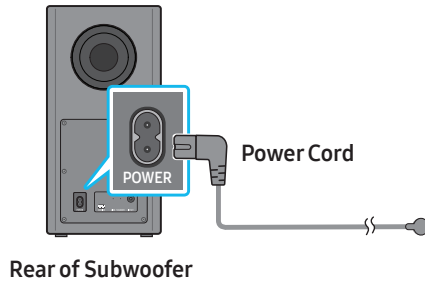

2. Connect the Power cord to the Soundbar.

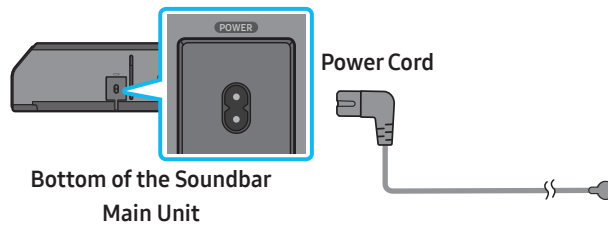

3. Connect power to the Soundbar and Subwoofer. The Subwoofer is automatically connected when the Soundbar is turned on.

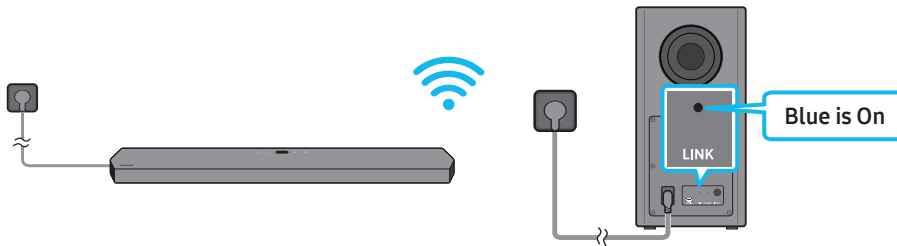

### NOTE

- Connect the Subwoofer power before connecting to the Soundbar. The Subwoofer will be automatically connected when turning on the Soundbar.
- If you unplug and reconnect the power cord when the product is turned on, the Soundbar turns on automatically.

## Manually connecting the Subwoofer

### Before performing the manual connection procedure below:

- Check whether the power cables for the Soundbar and subwoofer are connected properly.
- Make sure that the Soundbar is turned off.

1. Turn off the Soundbar main.
2. Press and hold **ID SET** on the rear of the subwoofer for at least 5 seconds.
  - The red indicator on the rear of the subwoofer turns off and the blue indicator blinks.

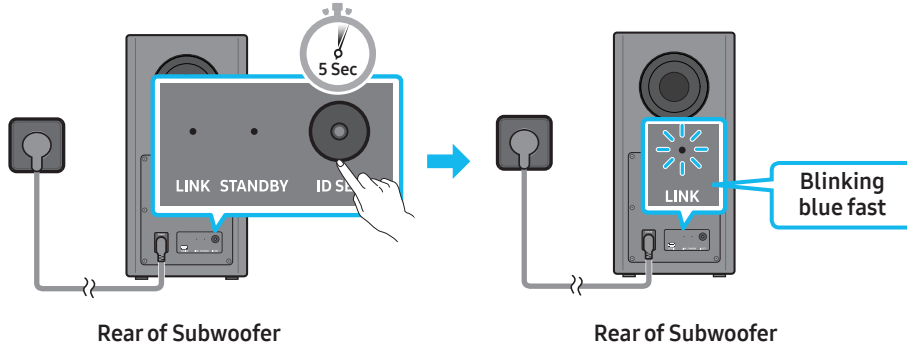

3. Press the **Up** button on the remote control for 5 seconds.
  - The **ID SET** message appears on the display of the Soundbar for a moment, and then it disappears.
  - The Soundbar will automatically power on when **ID SET** is complete.

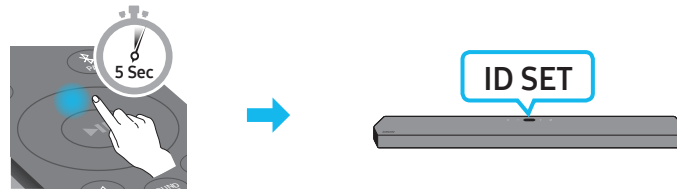

4. Check if the LINK LED is solid blue (connection complete).

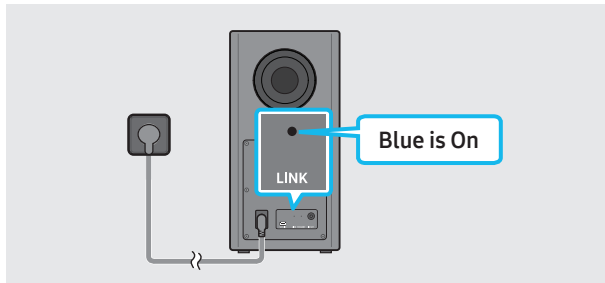

The LINK LED indicator stops blinking and glows a solid blue when a connection is established between the Soundbar and the Wireless Subwoofer.

## LED Indicator Lights on the Rear of Subwoofer

LED	Status	Description	Resolution
	On	Successfully connected (normal operation)	-
	Blinking	Recovering the connection	Check if the power cable attached to the main Soundbar unit is connected properly or wait about 5 minutes. If blinking persists, try manually connecting the subwoofer. See page 14.
	On	Standby (with the Soundbar main unit turned off)	Check if the power cable attached to the main Soundbar unit is connected properly.
		Connection failed	Connect again. See the instructions for manual connection on page 14.

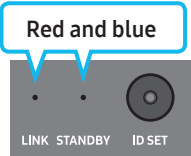
LED	Status	Description	Resolution
	Blinking	Malfunction	See the contact information for the Samsung Service Center in this manual.

#### NOTE

- If the main unit is powered off, the wireless subwoofer will go into stand-by mode and the STANDBY LED on the rear of the sub-woofer will turn red after blinking in blue several times.
- If you use a device that uses the same frequency as the Soundbar near the Soundbar, interference may cause some sound interruption.
- The maximum transmission distance of the main unit's wireless signal is about 32.8 ft (10 m), but may vary depending on your operating environment. If a steel-concrete or metallic wall is between the main unit and the wireless subwoofer, the system may not operate at all because the wireless signal cannot penetrate metal.

#### ⚠ CAUTION

- Wireless receiving antennas are built into the wireless subwoofer. Keep the unit away from water and moisture.
- For optimal listening performance, make sure that the area around the wireless subwoofer and the Wireless Receiver Module (sold separately) is clear of any obstructions.

#### Auto EQ

Samsung's **Auto EQ** Technology uses a microphone mounted in the subwoofer to detect and correct low-frequency response peaks caused by the room dimensions and the subwoofer location. The result will be a more neutral overall low-frequency response.

- Subwoofer should be placed with a **minimum of 3" (8 cm) clearance** from each side to the nearest boundary.
- You must keep the room as quiet as possible while operating the **Auto EQ** tuning.
- Do not use any buttons until the **Auto EQ** tuning is complete.
- **Auto EQ** tuning takes about 2 minutes.
- During **Auto EQ** tuning, there is no sound from the Soundbar's main unit and rear speakers.

#### If you are using the function for the first time

1. Press the  (**Sound Control**) button until **Auto EQ** is selected.
2. Press the **Up/Down** buttons to select **Tuning**, and then press the **▶||** button.
3. Tuning will start, and the progress appears in percentage.
  - To cancel tuning, press the **Up, Down, Left, Right** or **▶||** button, and then press the **▶||** button to confirm.
  - If the tuning is failed, LED blinks in red.
  - If the tuning is successful, LED blinks in blue.

#### If you have done the tuning process

1. Press the  (**Sound Control**) button until **Auto EQ** is selected.
2. Press the **Up/Down** buttons to select **Tuning**, and then press the **▶||** button.
3. Press the **Up/Down** buttons to select one of the following options.
  - **On**: Turn on the previously tuned EQ settings.
  - **Off**: Turn on the default EQ settings.
  - **Tuning**: Start the tuning process again.

## Connecting an SWA-9500S (Sold Separately) to your Soundbar

Expand to true wireless surround sound by connecting the Samsung Wireless Rear Speaker Kit (SWA-9500S, sold separately) to your Soundbar. For detailed information on connections, see the Samsung Wireless Rear Speaker Kit manual.

# 05 USING A WIRED CONNECTION TO THE TV

## Method 1. Connecting with HDMI

### ⚠ CAUTION

- When both the HDMI cable and optical cable are connected, the HDMI signal is received first.
- To connect the HDMI cable between the TV and Soundbar, be sure to connect the terminals marked ARC. Otherwise, the TV sound may not be output.
- The recommended cable is **High Speed HDMI Cable with Ethernet**.

### Connecting the TV that supports HDMI ARC (Audio Return Channel)

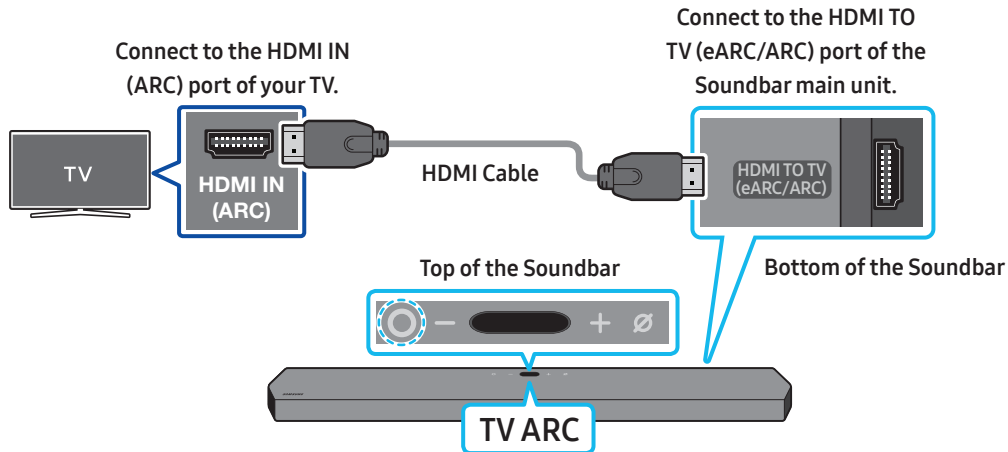

1. With the Soundbar and TV turned off, connect the HDMI cable as shown in the figure.
2. Turn on the Soundbar and TV.
3. **"TV ARC"** appears in the display window of the Soundbar main unit and the Soundbar plays TV sound.
  - When the TV sound is not output, press the **○ (Multi Function)** button at the top of the Soundbar or the **☰ (Source)** button on the remote control to select the **"D.IN"** mode. The screen displays **"D.IN"** and **"TV ARC"** in sequence, and TV sound is played.
  - When connecting a TV that supports the eARC function, **"eARC"** appears on the display and the sound is heard.
  - To connect with eARC, the eARC function in the TV menu should be set to On. Refer to the TV user manual for details on setting. (e.g. Samsung TV : Home (🏠) → Settings (⚙) → Sound → Expert Settings → HDMI-eARC Mode (Auto))
  - If **"TV ARC"** does not appear in the display window of the Soundbar main unit, confirm that the HDMI cable is connected to the correct port.
  - Use the volume buttons on the TV's remote control to change the volume on the Soundbar.

### NOTE

- When you connect the TV that supports the HDMI ARC (Audio Return Channel) to the Soundbar with an HDMI cable, you can transmit the digital video and audio data without connecting a separate optical cable.
- We recommend you use a coreless HDMI cable if possible. If you use a cored HDMI cable, use one whose diameter is less than 0.55 inches (14 mm).
- This function is not available if the HDMI cable does not support ARC.
- When the audio in a broadcast is encoded in Dolby Digital and the "Digital Output Audio Format" on your TV is set to PCM, we recommend that you change the setting to Dolby Digital. When the setting on the TV is changed, you will experience better sound quality. (The TV menu may use different words for Dolby Digital and PCM depending on the TV manufacturer.)

## Method 2. Connecting using an Optical Cable

### Pre-connection Checklist

- When both the HDMI cable and optical cable are connected, the HDMI signal is received first.
- When you use an optical cable and the terminals have covers, be sure to remove the covers.

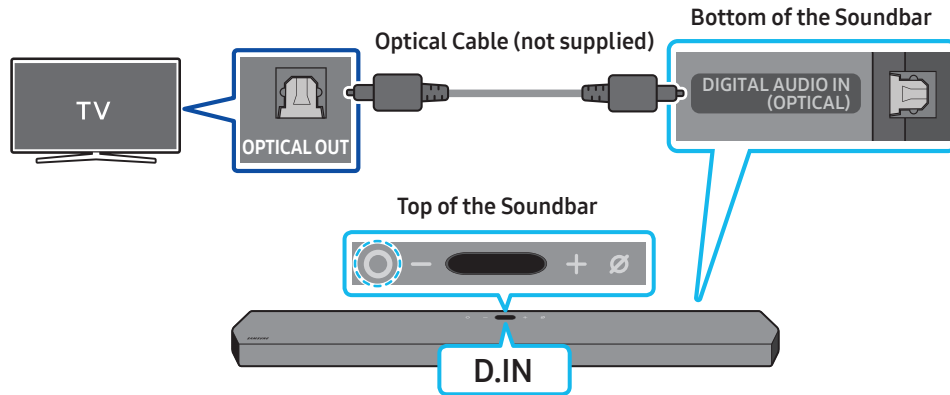

1. With the TV and Soundbar turned off, connect the **DIGITAL AUDIO IN (OPTICAL)** port on the Soundbar and the **OPTICAL** output port on the TV with the optical cable (not supplied), as shown in the figure.
2. Turn on the Soundbar and TV.
3. Press the **○ (Multi Function)** button at the top of the Soundbar or the **☰ (Source)** button on the remote control to select the **"D.IN"** mode.
4. The TV sound is output from the Soundbar.

### Using the Q-Symphony Function

For Q-Symphony, the Soundbar syncs with a Samsung TV to output sound through two devices for optimum surround effect. When the Soundbar is connected, the menu, **"TV+Soundbar"** appears under the **Sound Output** menu of the TV. Select the corresponding menu.

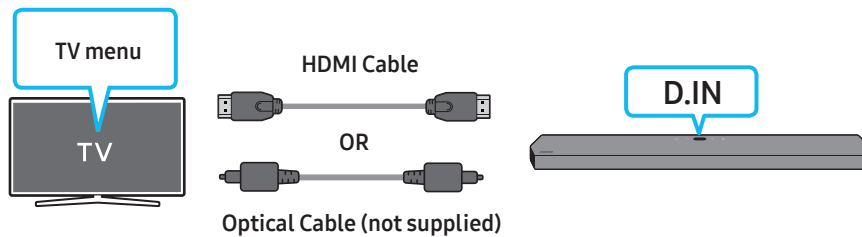

- TV menu example: **TV + [AV] Soundbar series name (HDMI)**

### NOTE

- It can operate according to the Codec supported by TV.
- This function is supported only when the HDMI Cable or Optical Cable (not supplied) is connected.
- This function is available in some Samsung TVs and some Soundbar models.
- When using Q-Symphony, you can only choose **GAME PRO** or **ADAPTIVE SOUND**.

### Using the Spacefit sound

Provides optimized sound quality by analyzing the listening spaces.

To enable this function, turn on the **Adaptive Sound+** mode on your Samsung TV menu.  
(Home (🏠) → Settings (⚙️) → General → Intelligent Mode Settings → Adaptive Sound+)

### NOTE

- The sound mode on your Soundbar will automatically change to **Adaptive Sound+** if you enable the **Adaptive Sound+** mode on your TV.
- This function works when the Soundbar connects to some of the Samsung TVs.

# 06 USING A WIRELESS CONNECTION TO THE TV

## Method 1. Connecting via Bluetooth

When a Samsung TV is connected using Bluetooth, you can hear stereo sound without the hassle of cabling.

- Only one Samsung TV can be connected at a time.
- Samsung TV that supports Bluetooth can be connected. Check the specifications of your TV.

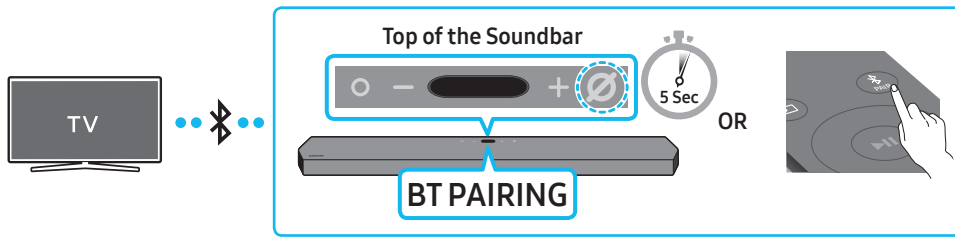

### The initial connection

1. Press the **PAIR** button on the Soundbar remote control to enter the “**BT PAIRING**” mode.

(OR) a. Press the **(Multi Function)** button on the top panel and then select “**BT**”.

“**BT**” changes to “**BT PAIRING**” in a few seconds automatically or changes to “**BT READY**” if there is a connect record.

b. When “**BT READY**” appears, press and hold the **(Mic On/Off)** button on the top panel of the Soundbar for more than 5 seconds to display “**BT PAIRING**”.

2. Select Bluetooth mode on the Samsung TV.

(e.g. Home (🏠) → Settings (⚙️) → Sound → Sound Output → Bluetooth Speaker List → [AV] Samsung Soundbar Q900A (Bluetooth))

3. Select “[AV] Samsung Soundbar Q900A” from the list on TV’s screen.

An available Soundbar is indicated with “**Need Pairing**” or “**Paired**” on the TV’s Bluetooth device list. To connect the Samsung TV to the Soundbar, select the message, and then establish a connection.

- When the Samsung TV is connected, [TV Name] → “**BT**” appears on the Soundbar’s top display.

4. You can now hear Samsung TV sound from the Soundbar.

- After you have connected the Soundbar to your Samsung TV the first time, use the “**BT READY**” mode to reconnect.

### If the device fails to connect

- If you have an existing Soundbar (e.g., [AV] Samsung Soundbar Q900A) on the list of speakers on the Samsung TV, delete it.
- Then repeat steps 1 through 3.

## Disconnecting the Soundbar from the Samsung TV

Press the **(Multi Function)** button at the top of the Soundbar or the **(Source)** button on the remote control to select the mode other than “**BT**”.

- Disconnecting takes time because the Samsung TV must receive a response from the Soundbar.  
(The time required may differ, depending on the Samsung TV model.)

## What is the difference between BT READY and BT PAIRING?

- **BT READY** : In this mode, you can reconnect any Samsung TV or mobile device that was connected before.
- **BT PAIRING** : In this mode, you can connect a new device to the Soundbar.  
(Press the **PAIR** button on the Soundbar remote control or press and hold the **(Mic On/Off)** button on the top of the Soundbar for more than 5 seconds while the Soundbar is in “**BT**” mode.)

## Notes on Bluetooth connection

- Locate a new device within 3.28 ft (1 m) to connect via Bluetooth communication.
- If asked for a PIN code when connecting a Bluetooth device, enter <0000>.
- The Soundbar automatically turns off after 18 minutes in the Ready state.
- The Soundbar may not perform Bluetooth search or connection correctly under the following circumstances:
  - If there is a strong electrical field around the Soundbar.
  - If several Bluetooth devices are simultaneously paired with the Soundbar.
  - If the Bluetooth device is turned off, not in place, or malfunctions.
- Electronic devices may cause radio interference. Devices that generate electromagnetic waves must be kept away from the Soundbar main unit - e.g., microwaves, wireless LAN devices, etc.

## Method 2. Connecting via Wi-Fi

### Pre-connection Checklist

- Wi-Fi connection is available only on Samsung TV.
- Check whether **the wireless router (Wi-Fi)** is turned on and **the TV is connected to the router**.
- The TV and Soundbar must be connected to the same wireless network (Wi-Fi).
- If your wireless router (Wi-Fi) uses a DFS channel, you will not be able to establish a Wi-Fi connection between the TV and Soundbar. Contact your Internet service provider for details.
- Because the menus may differ depending on the year of manufacture, refer to your TV manual.
- To connect the TV to the Soundbar via Wi-Fi, connect the Soundbar to the wireless router first. See page 23, for details on how to establish a Wi-Fi connection.

1. For more information about Wi-Fi connection to the Soundbar, see page 23, "**Method 2. Connecting via Wi-Fi (Wireless Network)**".
2. Change the input source of the TV by using the Audio menu to Soundbar.
  - **Samsung TVs released in 2017 or later**  
Home (🏠) → Settings (⚙️) → Sound → Sound Output → [AV] Samsung Soundbar Q900A (Wi-Fi)

# 07 CONNECTING AN EXTERNAL DEVICE

## Method 1. Connecting using an HDMI Cable (Capable of Dolby Atmos decoding and playback)

### Pre-connection Checklist

- If the Audio Output options include Secondary Audio, make sure Secondary Audio is set to Off.
- Make sure that the content supports Dolby Atmos®.

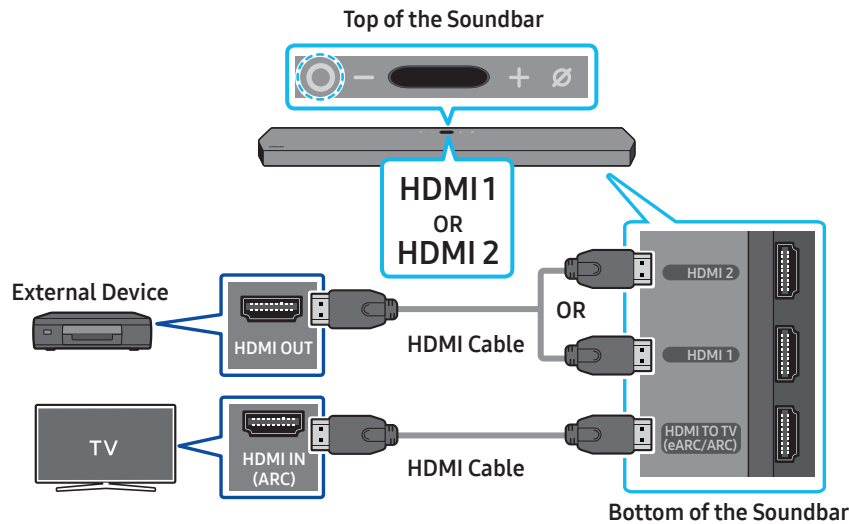

1. Use an HDMI cable to connect the HDMI OUT port on the external device and the **HDMI** port on the bottom of the Soundbar.
2. Use an HDMI cable to connect the HDMI IN port of the TV and the **HDMI TO TV (eARC/ARC)** port on the bottom of the Soundbar.
3. Turn on the Soundbar, TV, and the external device.
4. Press the **○ (Multi Function)** button on the top of the Soundbar or the **Source** button on the remote control to select “HDMI 1” or “HDMI 2” mode.
5. The Soundbar display indicates that “HDMI 1” or “HDMI 2” mode is currently selected and the Soundbar will start playing sounds.

### NOTE

- **When you use Dolby Atmos®:** If the input source is Dolby Atmos®, 7.1.2 channels are outputted.
- When Dolby Atmos® is activated, “DOLBY ATMOS” appears in the top display.
- **Configuring Dolby Atmos® on your BD player or other device**  
Open the audio output options on the settings menu of your BD player or other device and make sure that “No Encoding” is selected for Bitstream. For example, on a Samsung BD Player, go to Home Menu → Sound → Digital Output and then select Bitstream (unprocessed).

### Supported UHD Signals Specification (3840 x 2160p)

Frame rate (fps)	Color depth	RGB 4:4:4	YCbCr 4:4:4	YCbCr 4:2:2	YCbCr 4:2:0
< 60	8 bit	0	0	0	0
	10 bit	-	-	0	0
	12 bit	-	-	0	0
120	8 bit	-	-	-	-
	10 bit	-	-	-	-

- Supported specification may vary depending on the connected external device or usage conditions.



## Method 2. Connecting using an Optical Cable

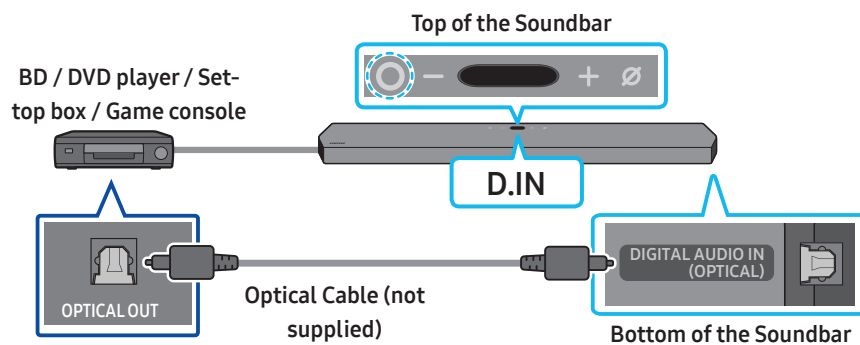

1. Use an optical cable (not supplied) to connect the **DIGITAL AUDIO IN (OPTICAL)** on the Soundbar main and the **OPTICAL OUT** port on the external device.
2. Turn on the Soundbar and external device.
3. To select **"D.IN"** mode, press the **○ (Multi Function)** button on the top of the Soundbar or the **Source** button on the remote control.
4. Your Soundbar will play sounds from the external device.

# 08 CONNECTING A MOBILE DEVICE

## Method 1. Connecting via Bluetooth

When a mobile device is connected using Bluetooth, you can hear stereo sound without the hassle of cabling.

- When you connect a paired Bluetooth device with the Soundbar off, the Soundbar automatically turns on.

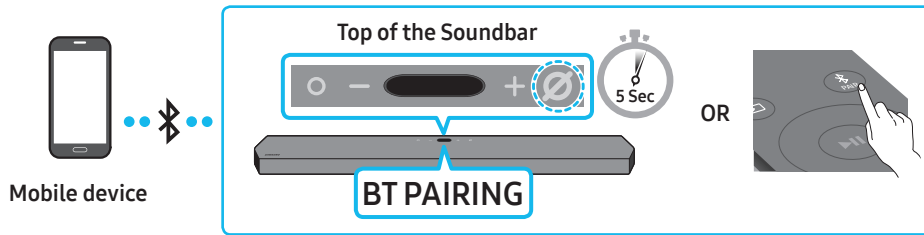

### The initial connection

- When connecting to a new Bluetooth device, make sure the device is within 3.28 ft (1 m) distance.

1. Press the **PAIR** button on the Soundbar remote control to enter the “**BT PAIRING**” mode.

(OR) a. Press the **Multi Function** button on the top panel and then select “**BT**”.

“**BT**” changes to “**BT PAIRING**” in a few seconds automatically or changes to “**BT READY**” if there is a connect record.

b. When “**BT READY**” appears, press and hold the **Mic On/Off** button on the top panel of the Soundbar for more than 5 seconds to display “**BT PAIRING**”.

2. On your device, select “[**AV**] Samsung Soundbar Q900A” from the list that appears.

- When the Soundbar is connected to the Mobile device, [**Mobile Device Name**] → “**BT**” appears in the top display.

3. Play music files from the device connected via Bluetooth through the Soundbar.

- After you have connected the Soundbar to your mobile device the first time, use the “**BT READY**” mode to reconnect.

### If the device fails to connect

- If you have an existing Soundbar (e.g., “[**AV**] Samsung Soundbar Q900A”) in the list of speakers on the Mobile device, delete it.
- Repeat steps 1 and 2.

### What is the difference between BT READY and BT PAIRING?

- **BT READY** : In this mode, you can reconnect any Samsung TV or mobile device that was connected before.

- **BT PAIRING** : In this mode, you can connect a new device to the Soundbar.

(Press the **PAIR** button on the Soundbar remote control or press and hold the **Mic On/Off** button on the top of the Soundbar for more than 5 seconds while the Soundbar is in “**BT**” mode.)

### Notes on Bluetooth connection

- Locate a new device within 3.28 ft (1 m) to connect via Bluetooth communication.
- If asked for a PIN code when connecting a Bluetooth device, enter <0000>.
- The Soundbar automatically turns off after 18 minutes in the Ready state.
- The Soundbar may not perform Bluetooth search or connection correctly under the following circumstances:
  - If there is a strong electrical field around the Soundbar.
  - If several Bluetooth devices are simultaneously paired with the Soundbar.
  - If the Bluetooth device is turned off, not in place, or malfunctions.
- Electronic devices may cause radio interference. Devices that generate electromagnetic waves must be kept away from the Soundbar main unit - e.g., microwaves, wireless LAN devices, etc.
- The Soundbar supports SBC data (44.1kHz, 48kHz).
- Connect only to a Bluetooth device that supports the A2DP (AV) function.
- You cannot connect the Soundbar to a Bluetooth device that supports only the HF (Hands Free) function.
- When connecting the Soundbar to a Bluetooth device, place them as close to each other as possible.
- The farther the Soundbar and Bluetooth device are from each other, the lower the sound quality will become. The Bluetooth connection may break when the devices are out of the effective range.
- The Bluetooth connection may not function as intended in areas with poor reception.

- A Bluetooth device may experience noise or malfunction under in the following conditions:
  - When the body is in contact with the signal transceiver on the Bluetooth device or Soundbar
  - In corners or when there is an obstacle in proximity, such as a wall or partition, where electrical changes may occur.
  - When exposed to radio interferences by other products operating on the same frequency ranges, such as medical equipment, microwave ovens, and wireless LAN devices.
  - Obstacles such as doors and walls may still impact the sound quality even when the devices are within the effective range.
- Note that your Soundbar cannot be paired with other Bluetooth devices while using the Bluetooth option.
- This wireless device may cause electrical interference during operation.

### Disconnecting the Bluetooth device from a Soundbar

You can disconnect a Bluetooth device from the Soundbar. For instructions, see the Bluetooth device’s user manual.

- The Soundbar will be disconnected.
- When the Soundbar is disconnected from the Bluetooth device, the Soundbar will display “BT DISCONNECTED” on the top display.

### Disconnecting the Soundbar from the Bluetooth device

Press the **○ (Multi Function)** button on the top of the Soundbar or the **📶 (Source)** button on the remote control to switch the mode from “BT”.

- Disconnecting takes time because the Bluetooth device must receive a response from the Soundbar. (Disconnection time may differ, depending on the Bluetooth device)
- When the Soundbar is disconnected from the Bluetooth device, the Soundbar will display “BT DISCONNECTED” on the top display.

## Method 2. Connecting via Wi-Fi (Wireless Network)

To connect a Soundbar to a mobile device via a wireless network (Wi-Fi), the SmartThings app is required.

### The initial connection

1. Install and launch the SmartThings app from your mobile device (smartphone or tablet).
2. On the app, follow the screen instructions to add the Soundbar.
  - The automatic pop-up (the second screenshot below) may not show on some devices.
 If the pop-up window does not appear, press “+” on the **Home** screen. The Soundbar is added to the app.

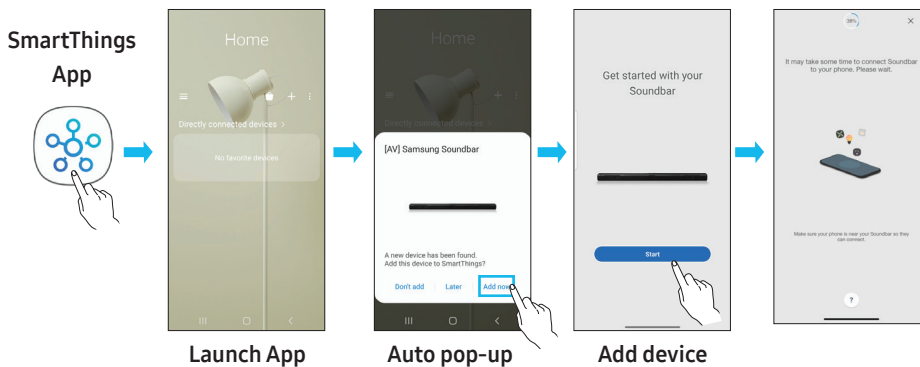

# Getting Started with Amazon Alexa (Built-in Alexa)

- Amazon Alexa is a service provided by Amazon.
- **This function may not be supported depending on the model or geographical area.**
- **This function only supports some languages, and the supported functions may differ depending on the geographical area.**
- **For product specification or compatibility, refer to the Samsung website ([www.samsung.com](http://www.samsung.com)).**

Using Alexa, you can play music, listen to news, see weather forecasts, and control home appliances.

To use Amazon Alexa, an Amazon account is required to connect the Soundbar over the network.

1. Install the **SmartThings** app on your mobile device and then launch it.
2. Enter the Alexa account by following the instructions on the app and then log in the service.

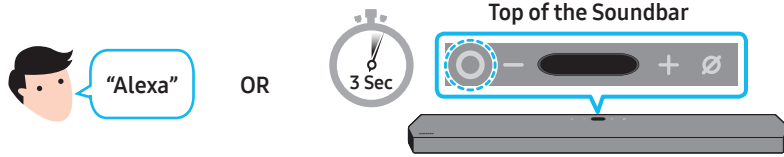

3. Call Alexa or press the **○ (Multi Function)** button on the Soundbar for 3 seconds to use the Alexa service.
  - Press the **○ (Multi Function)** button for 3 seconds to call Alexa. Say with the button pressed to enable voice recognition.

## Use voice commands to control the Soundbar

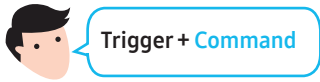

Things to try	Example of what to say
Volume control	"Alexa, <b>turn up the volume.</b> "
	"Alexa, <b>turn down the volume.</b> "
Listening to streaming content from Amazon Music	"Alexa, <b>play some jazz music.</b> "
Playback control	"Alexa, <b>play next song.</b> "
	"Alexa, <b>stop the music.</b> "
	"Alexa, <b>what is this song?</b> "
Weather information	"Alexa, <b>what's the weather?</b> "
Timer scheduling	"Alexa, <b>set a timer for 10 minutes.</b> "

## Getting Started with Alexa on Amazon Product (Works with Alexa)

- This function may not be supported depending on the model or geographical area.
- This function only supports some languages, and the supported functions may differ depending on the geographical area.
- For product specification or compatibility, refer to the Samsung website ([www.samsung.com](http://www.samsung.com)).
- This service is provided by Amazon and can be terminated at any time. Samsung does not assume responsibility for service availability.
- Amazon Alexa app screen is subject to change without prior notice.

### Connect and use with an Amazon product (Amazon Echo)

Use an Amazon Echo product to control your Soundbar and enjoy music services provided by Amazon Echo.

To use Amazon Alexa, an Amazon account is required to connect the Soundbar over the network.

1. Install the **SmartThings** app on your mobile device and then launch it.
2. Enter the Alexa account by following the instructions on the app and then log in the service.

### Use voice commands to control the Soundbar

- The Amazon Echo service you can use with your Soundbar is limited to music. Other services provided by Amazon Echo, such as news and weather, can only be accessed through your Amazon Echo product.



Trigger + Command + Speaker name

\* To use voice commands for the Soundbar named “Living room”

Action	Voice Command
To set the volume level to 5	“Alexa <b>Set the volume to 5 on Living room</b> ”
To increase the volume level	“Alexa <b>Volume up on Living room</b> ”
To mute the sound	“Alexa <b>Mute on Living room</b> ”
To listen to a radio station named KISS FM	“Alexa <b>Play Kiss FM on Living room</b> ”
To play the next song	“Alexa <b>Next song on Living room</b> ”
To stop the audio	“Alexa <b>Stop on Living room</b> ”
To turn the audio off	“Alexa <b>Turn off on Living room</b> ”

## Using the Tap Sound

Tap the Soundbar with your mobile device to play the sound of content on the mobile device through the Soundbar.

- This function may not be supported, depending on the mobile device.
- This function is only compatible with Samsung mobile devices with Android 8.1 or later.

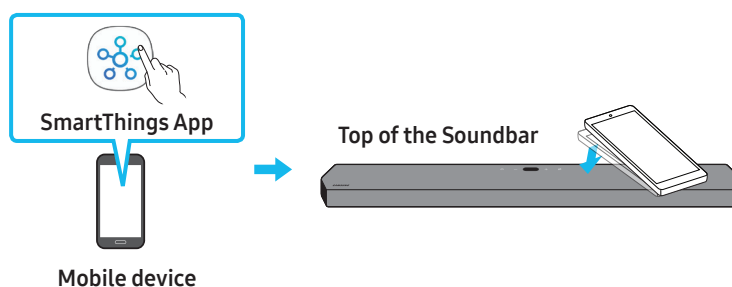

1. Turn on the **Tap Sound** function on your mobile device.
  - For details on how to turn on the function, refer to “**Setting the Tap Sound function**” below.
2. Tap the Soundbar with the mobile device. Select “**Start now**” in the displayed message window. A connection is established between the mobile device and Soundbar via Bluetooth.
3. Play the sound of content on the mobile device through the Soundbar.
  - This function connects a mobile device to the Soundbar via Bluetooth by detecting vibration that occurs when the device touches the Soundbar.
  - Make sure the mobile device does not tap a sharp corner of the Soundbar. The Soundbar or mobile device may become scratched or damaged.
  - It is recommended that the mobile device be covered with a case. Lightly tap the wide area in the upper portion of the Soundbar, without using excessive force.
  - To use this function, update the **SmartThings** app to the latest version. The function may not be supported, depending on the app version.

### Setting the Tap Sound function

Use the **SmartThings** app to turn on the **Tap View, Tap Sound** function.

1. On the mobile device, run the **SmartThings** app.
2. Select (☰ → ⚙) in the **SmartThings** app screen displayed on the mobile device.
3. Set “**Tap View, Tap Sound**” to On to allow the function to work when a mobile device moves close to the Soundbar. The function is turned on.

#### **NOTE**

- When the mobile device is in power-saving mode, the **Tap Sound** function does not work.
- The **Tap Sound** function may not work if there are devices near the Soundbar that cause radio interference such as electric devices. Make sure devices that may cause radio interference are placed at a sufficient distance away from the Soundbar.

## 09 CONNECTING TO APPLE AIRPLAY 2

This feature may not be available in some countries.

### Connect and use with an Apple product

- With AirPlay 2, you can control your home's audio system from your iPhone, iPad, HomePod, or Apple TV.
- This Samsung Soundbar supports AirPlay 2 and requires iOS 11.4 or later.

#### NOTE

- Confirm that the Soundbar is connected to Wi-Fi. (Refer to **Method 2. Connecting via Wi-Fi (Wireless Network)**)

# 10 INSTALLING THE WALL MOUNT

## Installation Precautions

- Install on a vertical wall only.
- Do not install in a place with high temperature or humidity.
- Verify whether the wall is strong enough to support the product's weight. If not, reinforce the wall or choose another installation point.
- Purchase and use the fixing screws or anchors appropriate for the kind of wall you have (plaster board, iron board, wood, etc.). If possible, fix the support screws into wall studs.
- Purchase wall mounting screws according to the type and thickness of the wall you want to mount the Soundbar on.
  - Diameter: M5
  - Length: 1 3/8 inches (35 mm) or longer recommended.
- Connect cables from the unit to external devices before you install the Soundbar on the wall.
- Make sure the unit is turned off and unplugged before you install it. Otherwise, it may cause an electric shock.

## Wallmount Components

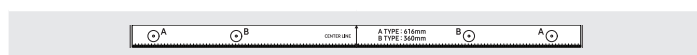

Wall Mount Guide (AH63-04369C)

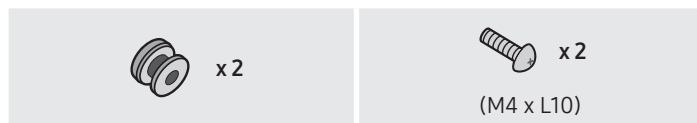

Holder-Screw (AH61-04110A)

Screw (6001-001202)



Bracket-Wall Mount (AH61-04119A)

1. Place the **Wall Mount Guide** against the wall surface.
  - The **Wall Mount Guide** must be level.
  - If your TV is mounted on the wall, install the Soundbar at least 2 inches (5 cm) below the TV.

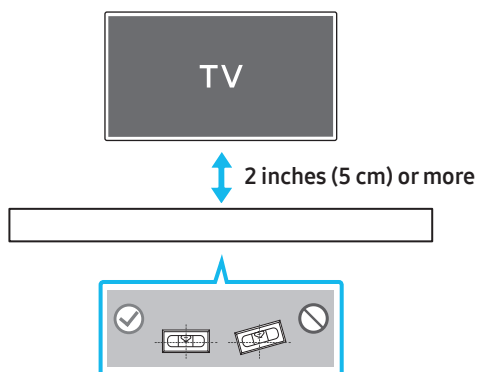

2. Align the **Wall Mount Guide's Center Line** with the center of your TV (if you are mounting the Soundbar below your TV), and then fix the **Wall Mount Guide** to the wall using tape.
  - If you are not mounting below a TV, place the **Center Line** in the center of the installation area.

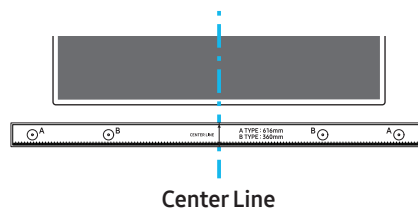

Center Line

3. Push a pen tip or sharpened pencil tip through the center of the **A-TYPE** images on each end of the Guide to mark the holes for the supporting screws, and then remove the **Wall Mount Guide**.

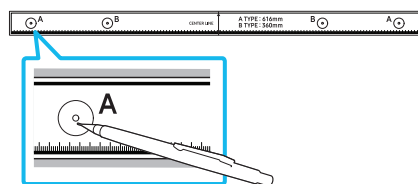

4. Using an appropriately sized drill bit, drill a hole in the wall at each marking.
  - If the markings do not correspond to the positions of studs, make sure you insert appropriate anchors or mollys into the holes before you insert the support screws. If you use anchors or mollys, make sure the holes you drill are large enough for the anchors or mollys you use.
5. Push a screw (not supplied) through each **Holder-Screw**, and then screw each screw firmly into a support screw hole.

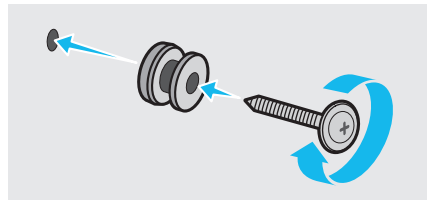

6. Install the 2 **Bracket-Wall Mounts** in the correct orientation on the bottom of the Soundbar using 2 **Screws**.

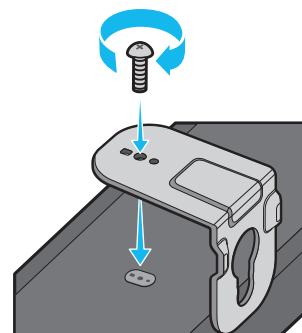

- When assembling, make sure the hanger part of the **Bracket-Wall Mounts** are located behind the rear of the Soundbar.

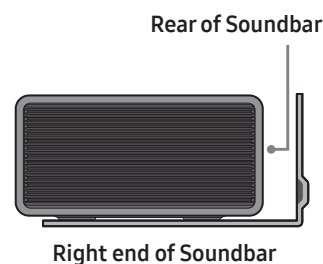



7. Install the Soundbar with the attached **Bracket-Wall Mounts** by hanging the **Bracket-Wall Mounts** on the **Holder-Screws** on the wall.

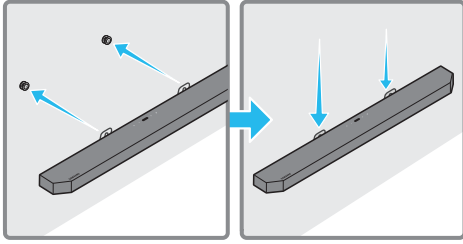

8. Slide the Soundbar down as shown below so that the **Bracket-Wall Mounts** rest securely on the **Holder-Screws**.

- Insert the **Holder-Screws** into the wide (bottom) part of the **Bracket-Wall Mounts**, and then slide the **Bracket-Wall Mounts** down so that the **Bracket-Wall Mounts** rest securely on the **Holder-Screws**.

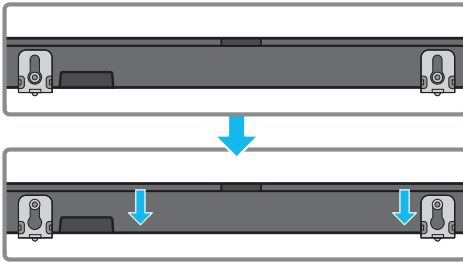

## 11 INSTALLING THE SOUNDBAR ABOVE A TV STAND

### Component



x 4

#### Rubber-Foot (BN67-00398L)

To install, attach the **Rubber-Feet** to the bottom of the Soundbar before placing it in position above the TV stand. Make sure you attach the **Rubber-Feet** so they do not lie outside the edges of the TV stand. Refer to the figure below.

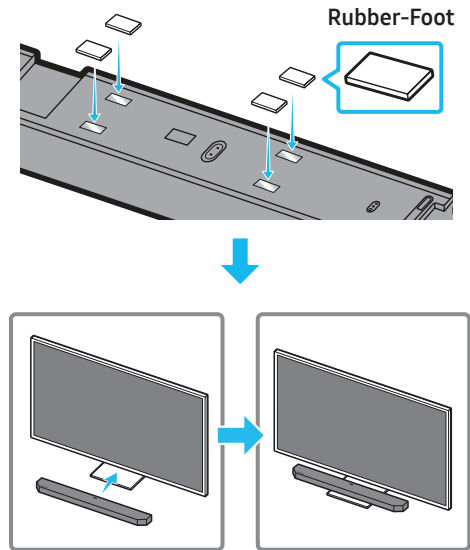

Place the Soundbar on a TV stand.

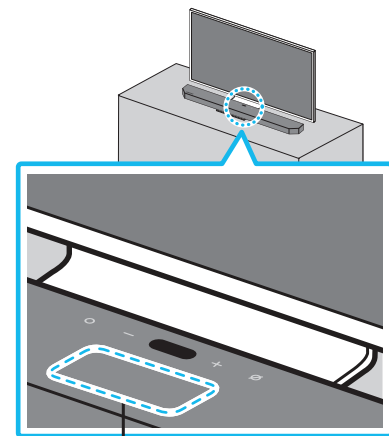

Microphone

As illustrated in the image, align the center of the Soundbar with the center of the TV, carefully place the Soundbar onto the TV stand. At this time, place the microphone at the front of the stand not to interfere with voice recognition.

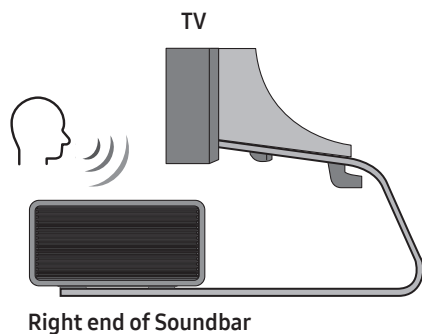

#### NOTE

- Make sure the Soundbar is placed on a flat and solid surface.
- Insufficient gap from the TV may cause voice recognition and acoustic problems.

## 12 SOFTWARE UPDATE

### Auto Update

When the Soundbar is connected to the Internet, software updates automatically occur even when the Soundbar is turned off.

- To use the Auto Update function, the Soundbar must be connected to the Internet.

The Wi-Fi connection to the Soundbar will be terminated if the Soundbar's power cord is disconnected or the power is cut off. If the power is cut off, when the power comes back on or you reconnect the power cord, turn on the Soundbar, and then reconnect it to the Internet.

### USB Update

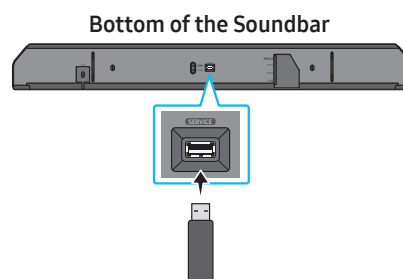

**Samsung may offer updates for the Soundbar's system firmware in the future.**

When an update is available, you can update the Soundbar by connecting the USB drive that contains the update firmware to the SERVICE port of the Soundbar.

1. Go to the Samsung Electronics website ([www.samsung.com](http://www.samsung.com)) → search for the model name from the customer support menu option.
  - For more information about update, refer to Upgrade Guide.
2. Download the upgrade file (USB type).
3. Unzip the file to create a folder with the file name.
4. Store the created folder in a USB and then connect it to the Soundbar.
5. Turn on the Soundbar. Then the product is updated within 3 minutes with displaying the message, "UPDATE".
  - During update, do not turn it off or remove the USB.
  - If "UPDATE" does not appear on the display window, remove the power cord from the Soundbar and then reconnect it.
  - When the latest version is installed, no update is performed.
  - Depending on the USB type, update may not be supported.

## Initialization

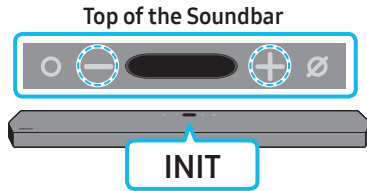

With the Soundbar on, press the **— + (Volume)** buttons on the body at the same time for at least 5 seconds. "INIT" appears on the display and then the Soundbar is initialized.

### **⚠ CAUTION**

- All the settings of the Soundbar are initialized. Be sure to perform this only when initialization is required.

## 13 TROUBLESHOOTING

Refer to the instructions below if this product does not function properly. If the problem you are experiencing is not listed below or if the instructions below do not help, turn off the product, disconnect the power cord, and contact Samsung Electronics at 1-800-SAMSUNG (1-800-726-7864).

### **Soundbar does not turn on.**

- Check whether the power cord of the Soundbar is correctly inserted into the outlet.

### **Soundbar works erratically.**

- After removing the power cord, insert it again.
- Remote the power cord from the external device and try again.
- If there is no signal, the Soundbar automatically turns off after a certain period of time. Turn on the power. (See page 9.)

### **Remote control does not work**

- Point the remote directly at the soundbar.
- Replace the batteries with new ones.

### **Sound is not output from the soundbar.**

- The volume of the Soundbar is too low or muted. Adjust the volume.
- When any external device (STB, Bluetooth device, mobile device, etc.) is connected, adjust the volume of the external device.
- For sound output of the TV, select Soundbar. (Samsung TV: Home (🏠) → Settings (⚙) → Sound → Sound Output → Select Soundbar)
- The cable connection to the Soundbar may not be loose. Remove the cable and connect again.
- Remove the power cord completely, reconnect, and turn the power on.
- Initialize the product and try again. (See page 31.)

### **Sound is not output from the subwoofer.**

- Check whether the LED indicator on the rear of the Subwoofer is on in blue. Reconnect the Soundbar and Subwoofer if the indicator is blinking in blue or turned red. (See page 14.)
- You may experience an issue if there is an obstacle between the Soundbar and Subwoofer. Move devices to an area away from obstacles.
- Other devices sending radio frequency signals in proximity may interrupt the connection.  
Keep your speaker away from such devices.
- Remove and reconnect the power plug.

### **The Subwoofer volume is too low**

- The original volume of the content you are playing may be low. Try adjusting the Subwoofer level. (See page 10.)
- Bring the Subwoofer speaker closer to you.

#### In case the TV is not connected via HDMI TO TV (eARC/ARC)

- Check whether the HDMI cable is correctly connected to the ARC terminal. (See page 16.)
- Connection may not be possible due to the connected external device (set-top box, game machine, etc.). Directly connect the Soundbar.
- HDMI-CEC may not be activated on the TV. Turn on the CEC on the TV menu. (Samsung TV: Home (🏠) → Settings (⚙️) → General → External Device Manager → Anynet+ (HDMI-CEC) ON)
- To connect with eARC, the eARC function in the TV menu should be set to On. (Samsung TV: Home (🏠) → Settings (⚙️) → Sound → Expert Settings → HDMI-eARC Mode (Auto))

#### There is no sound in when connecting to the TV in HDMI TO TV (eARC/ARC) mode

- Your device is unable to play the input signal. Change the TV's audio output to PCM or Dolby Digital. (For a Samsung TV: Home (🏠) → Settings (⚙️) → Sound → Expert Settings → Digital Output Audio Format)

#### Soundbar will not connect via Bluetooth.

- When connecting a new device, switch to "BT PAIRING" for connection. (Press the **PAIR** button on the remote control or press the **⊗ (Mic On/Off)** button on the body for at least 5 seconds.)
- If the Soundbar is connected to another device, disconnect that device first to switch the device.
- Reconnect it after removing the Bluetooth speaker list on the device to connect. (Samsung TV: Home (🏠) → Settings (⚙️) → Sound → Sound Output → Bluetooth Speaker List)
- The automatic TV connection may be disabled. While the Soundbar is in "BT READY", press and hold the **▶||** button on the Soundbar remote control for 5 seconds to select **ON-TV CONNECT**. If you see **OFF-TV CONNECT**, press and hold **▶||** button again for 5 seconds to switch the selection.
- Remove and reconnect the power plug, then try again.
- Initialize the product and try again. (See page 31.)

#### Sound drops out when connected via Bluetooth.

- Some devices can cause radio interference if they are located too close to the Soundbar. e. g. microwaves, wireless routers, etc.
- If your device that is connected via Bluetooth moves too far away from the soundbar, it may cause the sound to drop out. Move the device closer to the soundbar.
- If a part of your body is in contact with the Bluetooth transceiver or the product is installed on metal furniture, the sound may drop out. Check the installation environment and conditions for use.

#### Soundbar will not connect to Wi-Fi.

- Check whether your wireless router is on.
- Turn off the router, turn it back on, and then try again.
- The soundbar will not connect if the wireless signal is too weak. Try moving the router closer to the soundbar, or eliminating any obstacles that are between the soundbar and the router, if possible.
- If your wireless router is new, you will need to reconfigure the speaker's network settings.

#### The soundbar does not turn on automatically with the TV.

- When you turn off the Soundbar while watching TV, power synchronization with the TV is disabled. First turn off the TV.

#### The AVA function is not available in the following cases.

- The AVA function will not be available using Q-symphony function.
- The AVA function will not be available when the microphone is turned off.

#### The Auto EQ tuning process failed.

- Tuning process may fail if there is a sound output from the Soundbar or any external noise during the tuning process. Proceed the tuning process in a quiet environment.
- Do not manipulate the Soundbar during the tuning process.

## 14 LICENSE

---



Dolby, Dolby Atmos, and the double-D symbol are registered trademarks of Dolby Laboratories Licensing Corporation. Manufactured under license from Dolby Laboratories. Confidential unpublished works. Copyright © 2012-2020 Dolby Laboratories. All rights reserved.



For DTS patents, see <http://patents.dts.com>. Manufactured under license from DTS, Inc. (for companies headquartered in the U.S./ Japan/Taiwan) or under license from DTS Licensing Limited (for all other companies). DTS, DTS:X Pro, DTS:X, and the DTS:X logo are registered trademarks or trademarks of DTS, Inc. in the United States and other countries. © 2020 DTS, Inc. ALL RIGHTS RESERVED.



The terms HDMI and HDMI High-Definition Multimedia Interface, and the HDMI Logo are trademarks or registered trademarks of HDMI Licensing Administrator, Inc. in the United States and other countries.



- Use your phone, tablet or computer as a remote control for Spotify. Go to [spotify.com/connect](https://spotify.com/connect) to learn how
- The Spotify Software is subject to third party licenses found here: <https://www.spotify.com/connect/third-party-licenses>.



- Apple, AirPlay, iPhone, iPad, HomePod, and Apple TV are trademarks of Apple Inc., registered in the U.S. and other countries.
- Use of the Works with Apple badge means that an accessory has been designed to work specifically with the technology identified in the badge and has been certified by the developer to meet Apple performance standards.

## 15 OPEN SOURCE LICENSE NOTICE

To send inquiries and requests for questions regarding open sources, contact Samsung Open Source (<http://opensource.samsung.com>)

## 16 IMPORTANT NOTES ABOUT SERVICE

- Figures and illustrations in this User Manual are provided for reference only and may differ from actual product appearance.
- An administration fee may be charged if either:
  - a. An engineer is called out to your home at your request and there is no defect in the product.
  - b. You bring the unit to a repair center and there is no defect in the product.
- You will be advised of the amount of the administration fee before any work is done or a home visit is made.
- If you have a problem with this product, we strongly recommend you read the appropriate section of this manual, visit the Support page for your product at [www.samsung.com](http://www.samsung.com), or call Samsung Product Support (1-800-726-7864) to find an answer before you contact a service center for a repair.

# 17 SPECIFICATIONS AND GUIDE

## Specifications

Model Name	HW-Q900A
Weight	15.7 lbs (7.1 kg)
Dimensions (W x H x D)	48.5 x 2.7 x 5.4 inches (1232.0 x 69.5 x 138.0 mm)
Operating Temperature Range	+41°F to +95°F (+5°C to +35°C)
Operating Humidity Range	10 % ~ 75 %
AMPLIFIER Rated Output power	((18 W x 6) + (10 W x 3) + (18 W x 6)) + 160 W
Supported play formats	Dolby 5.1ch / Dolby Digital Plus / Dolby TRUE HD / Dolby ATMOS DTS 5.1ch / DTS HD / DTS-HD Master Audio / DTS:X / LPCM 8Ch

Subwoofer Name	PS-WA95B
Weight	21.6 lbs (9.8 kg)
Dimensions (W x H x D)	8.3 x 15.9 x 15.9 inches (210.0 x 403.0 x 403.0 mm)
AMPLIFIER Rated Output power	160 W

### NOTE

- Samsung Electronics Co., Ltd reserves the right to change the specifications without notice.
- Weight and dimensions are approximate.

**Precaution : The Soundbar will restart automatically if you turn on/turn off Wi-Fi.**

Wi-Fi Port deactivation method	Press the <b>ID SET</b> button on the bottom panel of the Soundbar for 30 seconds to turn Wi-Fi On / Off.
Bluetooth Port deactivation method	Press the <b>NETWORK</b> button on the bottom panel of the Soundbar for 30 seconds to turn Bluetooth On / Off.

# LIMITED WARRANTY TO ORIGINAL PURCHASER

This SAMSUNG brand product, as supplied and distributed by SAMSUNG and delivered new, in the original carton to the original consumer purchaser, is warranted by SAMSUNG against manufacturing defects in materials and workmanship for a limited warranty period of:

**One (1) Year Parts and Labor\***  
**(\*90 Days Parts and Labor for Commercial Use)**

This limited warranty begins on the original date of purchase, and is valid only on products purchased and used in the United States. To receive warranty service, the purchaser must contact SAMSUNG for problem determination and service procedures. Warranty service can only be performed by a SAMSUNG authorized service center. The original dated bill of sale must be presented upon request as proof of purchase to SAMSUNG or SAMSUNG's authorized service center. Transportation of the product to and from the service center is the responsibility of the purchaser.

SAMSUNG will repair or replace this product, at our option and at no charge as stipulated herein, with new or reconditioned parts or products if found to be defective during the limited warranty period specified above.

All replaced parts and products become the property of SAMSUNG and must be returned to SAMSUNG. Replacement parts and products assume the remaining original warranty, or ninety (90) days, whichever is longer.

SAMSUNG's obligations with respect to software products distributed by SAMSUNG under the SAMSUNG brand name are set forth in the applicable end user license agreement. Non-SAMSUNG hardware and software products, if provided, are on an "AS IS" basis.

Non-SAMSUNG manufacturers, suppliers, publishers, and service providers may provide their own warranties.

This limited warranty covers manufacturing defects in materials and workmanship encountered in normal, and except to the extent otherwise expressly provided for in this statement, noncommercial use of this product, and shall not apply to the following, including, but not limited to: damage which occurs in shipment; delivery and installation; applications and uses for which this product was not intended; altered product or serial numbers; cosmetic damage or exterior finish; accidents, abuse, neglect, fire, water, lightning or other acts of nature; use of products, equipment, systems, utilities, services, parts, supplies, accessories, applications, installations, repairs, external wiring or connectors not supplied and authorized by SAMSUNG, or which damage this product or result in service problems; incorrect electrical line voltage, fluctuations and surges; customer adjustments and failure to follow operating instructions, cleaning, maintenance and environmental instructions that are covered and prescribed in the instruction book; product removal or reinstallation; reception problems and distortion related to noise, echo, interference or other signal transmission and delivery problems. SAMSUNG does not warrant uninterrupted or error-free operation of the product.

THERE ARE NO EXPRESS WARRANTIES OTHER THAN THOSE LISTED AND DESCRIBED ABOVE, AND NO WARRANTIES WHETHER EXPRESS OR IMPLIED, INCLUDING, BUT NOT LIMITED TO, ANY IMPLIED WARRANTIES OF MERCHANTABILITY OR FITNESS FOR A PARTICULAR PURPOSE, SHALL APPLY AFTER THE EXPRESS WARRANTY PERIODS STATED ABOVE, AND NO OTHER EXPRESS WARRANTY OR GUARANTY GIVEN BY ANY PERSON, FIRM OR CORPORATION WITH RESPECT TO THIS PRODUCT SHALL BE BINDING ON SAMSUNG. SAMSUNG SHALL NOT BE LIABLE FOR LOSS OF REVENUE OR PROFITS, FAILURE TO REALIZE SAVINGS OR OTHER BENEFITS, OR ANY OTHER SPECIAL, INCIDENTAL OR CONSEQUENTIAL DAMAGES CAUSED BY THE USE, MISUSE OR INABILITY TO USE THIS PRODUCT, REGARDLESS OF THE LEGAL THEORY ON WHICH THE CLAIM IS BASED, AND EVEN IF SAMSUNG HAS BEEN ADVISED OF THE POSSIBILITY OF SUCH DAMAGES. NOR SHALL RECOVERY OF ANY KIND AGAINST SAMSUNG BE GREATER IN AMOUNT THAN THE PURCHASE PRICE OF THE PRODUCT SOLD BY SAMSUNG AND CAUSING THE ALLEGED DAMAGE. WITHOUT LIMITING THE FOREGOING, PURCHASER ASSUMES ALL RISK AND LIABILITY FOR LOSS, DAMAGE OR INJURY TO PURCHASER AND PURCHASER'S PROPERTY AND TO OTHERS AND THEIR PROPERTY ARISING OUT OF THE USE, MISUSE OR INABILITY TO USE THIS PRODUCT SOLD BY SAMSUNG NOT CAUSED DIRECTLY BY THE NEGLIGENCE OF SAMSUNG. THIS LIMITED WARRANTY SHALL NOT EXTEND TO ANYONE OTHER THAN THE ORIGINAL PURCHASER OF THIS PRODUCT, IS NONTRANSFERABLE AND STATES YOUR EXCLUSIVE REMEDY.

Some states do not allow limitations on how long an implied warranty lasts, or the exclusion or limitation of incidental or consequential damages, so the above limitations or exclusions may not apply to you. This warranty gives you specific legal rights, and you may also have other rights which vary from state to state.

To obtain warranty service, please contact SAMSUNG customer care center.

The benefits of this Limited Warranty extend only to the original purchaser of Samsung products from an authorized Samsung reseller. THIS LIMITED WARRANTY SHALL NOT APPLY TO ANY SAMSUNG PRODUCTS PURCHASED FROM UNAUTHORIZED RESELLERS OR RETAILERS, EXCEPT IN STATES WHERE SUCH RESTRICTION MAY BE PROHIBITED. For a list of Samsung authorized retailers, please go to:  
[http://www.samsung.com/us/peaceofmind/authorized\\_resellers.html](http://www.samsung.com/us/peaceofmind/authorized_resellers.html).

## QUESTIONS OR COMMENTS?

Country	Samsung Service Center 📞	Web Site	Address
IN THE US	1-800-SAMSUNG (726-7864)	<a href="http://www.samsung.com/us/support">www.samsung.com/us/support</a>	Samsung Electronics America, Inc. 85 Challenger Road Ridgefield Park, NJ 07660