

■ Multi Channel AV ■ Receiver

Operating Instructions

STR-DG520

Owner's Record

The model and serial numbers are located on the rear of the unit. Record the serial number in the space provided below. Refer to them whenever you call upon your Sony dealer regarding this product.

Model No. _____

Serial No. _____

WARNING

To reduce the risk of fire or electric shock, do not expose this apparatus to rain or moisture.

To prevent fire, do not cover the ventilation of the apparatus with newspapers, table-cloths, curtains, etc. And don't place lighted candles on the apparatus.

To prevent fire or shock hazard, do not place objects filled with liquids, such as vases, on the apparatus.

Do not install the appliance in a confined space, such as a bookcase or built-in cabinet.

Install this system so that the power cord can be unplugged from the wall socket immediately in the event of trouble.

Batteries or batteries installed apparatus shall not be exposed to excessive heat such as sunshine, fire or the like.

For customers in the United States

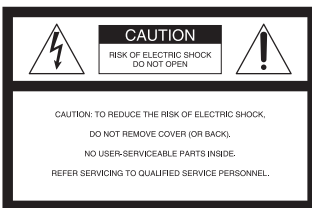

This symbol is intended to alert the user to the presence of uninsulated "dangerous voltage" within the product's enclosure that may be of sufficient magnitude to constitute a risk of electric shock to persons.



This symbol is intended to alert the user to the presence of important operating and maintenance (servicing) instructions in the literature accompanying the appliance.

WARNING

This equipment has been tested and found to comply with the limits for a Class B digital device, pursuant to Part 15 of the FCC Rules. These limits are designed to provide reasonable protection against harmful interference in a residential installation. This equipment generates, uses, and can radiate radio frequency energy and, if not installed and used in accordance with the instructions, may cause harmful interference to radio communications. However, there is no guarantee that interference will not occur in a particular installation. If this equipment does cause harmful interference to radio or television reception, which can be determined by turning the equipment off and on, the user is encouraged to try to correct the interference by one or more of the following measures:

- Reorient or relocate the receiving antenna.
- Increase the separation between the equipment and receiver.
- Connect the equipment into an outlet on a circuit different from that to which the receiver is connected.
- Consult the dealer or an experienced radio/TV technician for help.

CAUTION

You are cautioned that any changes or modification not expressly approved in this manual could void your authority to operate this equipment.

Note to CATV system installer:

This reminder is provided to call CATV system installer's attention to Article 820-40 of the NEC that provides guidelines for proper grounding and, in particular, specifies that the cable ground shall be connected to the grounding system of the building, as close to the point of cable entry as practical.

About This Manual

- The instructions in this manual are for model STR-DG520. Check your model number by looking at the lower right corner of the front panel. In this manual, models of area code U is used for illustration purposes unless stated otherwise. Any difference in operation is clearly indicated in the text, for example, “Models of area code U only”.
- The instructions in this manual describe the controls on the supplied remote. You can also use the controls on the receiver if they have the same or similar names as those on the remote.

About area codes

The area code of the receiver you purchased is shown on the lower right portion of the rear panel (see the illustration below).

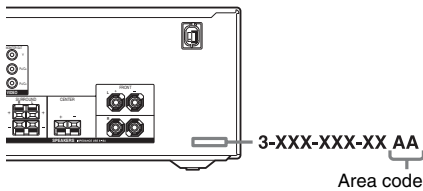

Any differences in operation, according to the area code, are clearly indicated in the text, for example, “Models of area code AA only”.

This receiver incorporates Dolby* Digital and Pro Logic Surround and the DTS** Digital Surround System.

* Manufactured under license from Dolby Laboratories.

Dolby, Pro Logic, and the double-D symbol are trademarks of Dolby Laboratories.

** Manufactured under license under U.S. Patent #'s: 5,451,942; 5,956,674; 5,974,380; 5,978,762; 6,487,535 & other U.S. and worldwide patents issued & pending. DTS and DTS Digital Surround are registered trademarks and the DTS logos and Symbol are trademarks of DTS, Inc. © 1996-2007 DTS, Inc. All Rights Reserved.

This receiver incorporates High-Definition Multimedia Interface (HDMI™) technology. HDMI, the HDMI logo and High-Definition Multimedia Interface are trademarks or registered trademarks of HDMI Licensing LLC.

Table of Contents

Getting Started

Description and location of parts.....	5
1: Installing speakers	13
2: Connecting speakers	14
3a: Connecting the audio components.....	15
3b: Connecting the video components	16
4: Connecting the antennas (aerials).....	24
5: Preparing the receiver and the remote	25
6: Adjusting the speaker levels and balance (TEST TONE).....	26

Playback

Selecting a component.....	28
Listening/Watching a component	29

Amplifier Operations

Navigating through menus.....	31
Adjusting the level (LEVEL menu).....	34
Adjusting the tone (TONE menu)	35
Settings for the surround sound (SUR menu).....	35
Settings for the tuner (TUNER menu).....	36
Settings for the audio (AUDIO menu).....	36
Settings for the system (SYSTEM menu) ...	37

Enjoying Surround Sound

Enjoying Dolby Digital and DTS Surround sound (AUTO FORMAT DIRECT)	40
Selecting a pre-programmed sound field....	42
Using only the front speakers (2CH STEREO).....	44
Listening to the sound without any adjustment (ANALOG DIRECT).....	45
Resetting sound fields to the initial settings.....	45

Tuner Operations

Listening to FM/AM radio.....	46
Presetting radio stations	47

Other Operations

Switching between digital and analog audio (INPUT MODE)	50
Enjoying the DIGITAL MEDIA PORT (DMPORT)	50
Naming inputs.....	52
Changing the display	53
Using the Sleep Timer	53
Recording using the receiver.....	54

Using the Remote

Changing button assignments	54
-----------------------------------	----

Additional Information

Glossary	55
Precautions.....	57
Troubleshooting	58
Specifications.....	61
Index	63

Description and location of parts

Front panel

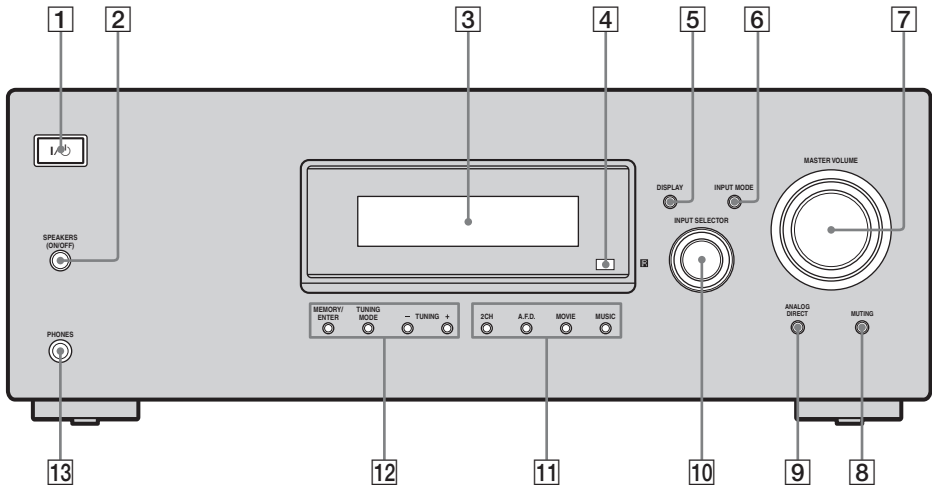

Name	Function
1 I/O (on/standby)	Press to turn the receiver on or off (page 25, 29, 30, 45, 62).
2 SPEAKERS (ON/OFF)	Press to turn the speaker system on or off (page 14).
3 Display	The current status of the selected component or a list of selectable items appears here (page 7).
4 Remote sensor	Receives signals from remote commander.
5 DISPLAY	Press to select information displayed on the display (page 53).
6 INPUT MODE	Press to select the input mode when the same components are connected to both digital and analog jacks (page 50).

Name	Function
7 MASTER VOLUME	Turn to adjust the volume level of all speakers at the same time (page 27, 28, 29, 30).
8 MUTING	Press to turn off the sound temporarily. Press MUTING again to restore the sound (page 28).
9 ANALOG DIRECT	Press to listen to high quality analog sound (page 45).
10 INPUT SELECTOR	Turn to select the input source to play back (page 28, 29, 30, 45, 46, 48, 49, 50, 52, 54).
11 2CH A.F.D. MOVIE MUSIC	Press to select a sound field (page 40).

Name	Function
12 MEMORY/ ENTER	Press to operate the tuner (FM/AM) (page 46).
TUNING MODE	
TUNING +/-	
13 PHONES jack	Connects to headphones (page 58).

About the indicators on the display

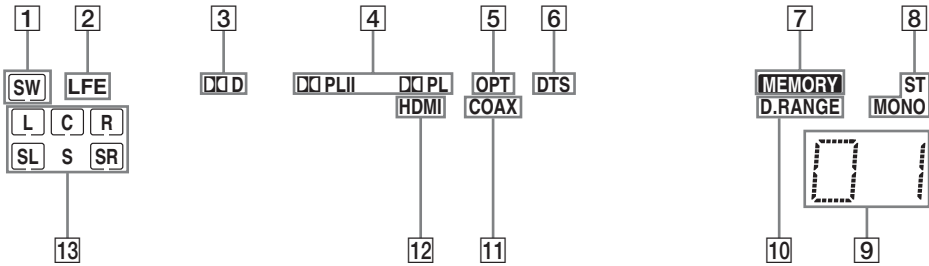

Name	Function
1 SW	Lights up when sub woofer selection is set to “YES” (page 37) and the audio signal is output from the SUB WOOFER jack.
2 LFE	Lights up when the disc being played back contains an LFE (Low Frequency Effect) channel and the LFE channel signal is actually being reproduced.
3 DDD	Lights up when the receiver is decoding Dolby Digital signals. Note When playing a Dolby Digital format disc, be sure that you have made digital connections and that INPUT MODE is set to “AUTO” (page 50).
4 DDD PL/ DDD PLII	“DDD PL” lights up when the receiver applies Pro Logic processing to 2 channel signals in order to output the center and surround channel signals. “DDD PLII” lights up when the Pro Logic II Movie/Music decoder is activated. However, these indicators do not light up if both the center and surround speakers are set to “NO” (page 33) and you select a sound field using the A.F.D. button.

Name	Function
5 OPT	Lights up when BD input is selected. However, “UNLOCK” appears on the display if no digital signal is input through the OPTICAL jack. “OPT” also lights up when SAT input is selected if INPUT MODE is set to “AUTO” and the source signal is a digital signal being input through the OPTICAL jack.
6 DTS	Lights up when the receiver is decoding DTS signals. Note When playing a DTS format disc, be sure that you have made digital connections and that INPUT MODE is set to “AUTO” (page 50).
7 MEMORY	Lights up when a memory function, such as Preset Memory (page 48), etc., is activated.
8 Tuner indicators	Lights up when using the receiver to tune in radio stations (page 46), etc.
9 Preset station indicators	Lights up when using the receiver to tune in radio stations you have preset. For details on presetting radio stations, see page 47.
10 D.RANGE	Lights up when dynamic range compression is activated (page 32).

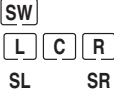
Name	Function
11 COAX	Lights up when DVD input is selected. However, "UNLOCK" appears on the display if no digital signal is input through the COAXIAL jack.
12 HDMI	Lights up when the receiver recognizes a component connected via a HDMI IN jack (page 17).
13 Playback channel indicators	<p>The letters (L, C, R, etc.) indicate the channels being played back. The boxes around the letters vary to show how the receiver downmixes the source sound (based on the speaker settings).</p> <p>L Front Left R Front Right C Center (monaural) SL Surround Left SR Surround Right S Surround (monaural or the surround components obtained by Pro Logic processing)</p> <p>Example: Recording format (Front/Surround): 3/2.1 Output channel: When surround speakers are set to "NO" (page 33) Sound Field: A.F.D. AUTO</p> <div style="text-align: center;">  </div>

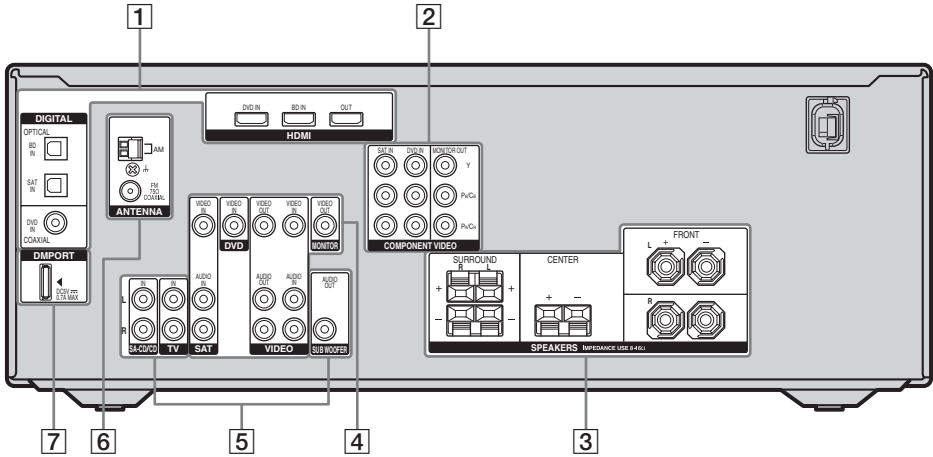

1 DIGITAL INPUT/OUTPUT section



OPTICAL IN jacks

Connects to a DVD player, etc. The **COAXIAL** jack provides a better sound quality (page 17, 20, 22).



COAXIAL IN jack



HDMI IN/OUT jacks*

Connects to a DVD player or a Blu-ray disc player. The image and the sound are output to a TV (page 17).

2 COMPONENT VIDEO INPUT/OUTPUT section



Green (Y)

COMPONENT VIDEO INPUT/OUTPUT jacks*

Connects to a DVD player, TV, or a satellite tuner. You can enjoy high quality image (page 19, 20, 22).



Blue (Pb/Cb)



Red (Pr/Cr)

3 SPEAKERS section

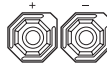

Connects to speakers (page 14).



4 VIDEO/AUDIO INPUT/OUTPUT section



White (L) AUDIO IN/OUT jacks

Connects to video and audio jacks of a VCR, a DVD player, etc. (page 19–23).



Red (R)



Yellow VIDEO IN/OUT jacks*

5 AUDIO INPUT section



White (L) AUDIO IN jacks

Connects to a Super Audio CD player, CD player, etc. (page 15).



Red (R)



Black AUDIO OUT jack

Connects to a sub woofer (page 14).

6 ANTENNA section



FM
ANTENNA
jack

Connects to the FM
wire antenna
(aerial) supplied
with this receiver
(page 24).



AM
ANTENNA
terminals

Connects to the AM
loop antenna
(aerial) supplied
with this receiver
(page 24).

7 DMPORT



DMPORT
jack

Connects to a
DIGITAL MEDIA
PORT adapter
(page 51).

* You can watch the selected input image when you connect the HDMI OUT or MONITOR OUT jack to a TV or projector (page 17, 19).

Remote commander

You can use the supplied remote to operate the receiver and to control the Sony audio/video components that the remote is assigned to operate (page 54).

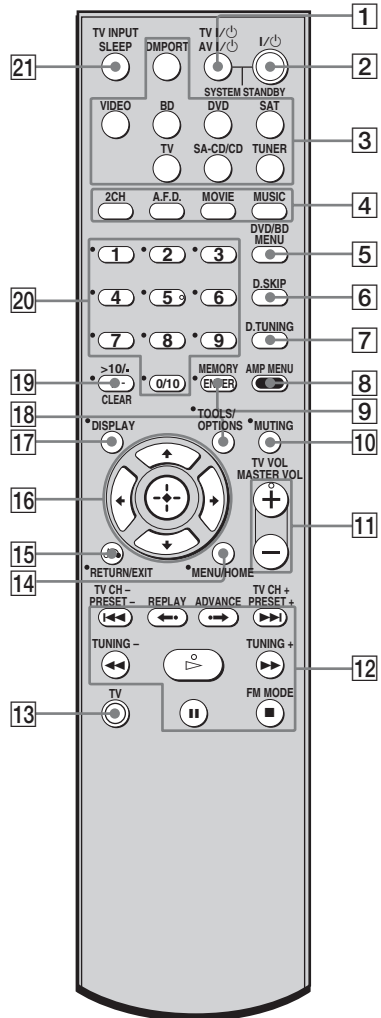

RM-AAU020



Name	Function
1 TV I/⏻ (on/standby)	Press TV I/⏻ and TV (13) at the same time to turn the TV on or off.
AV I/⏻ (on/standby)	Press to turn on or off the Sony audio/video components that the remote is assigned to operate (page 54). If you press I/⏻ (2) at the same time, it will turn off the receiver and other components (SYSTEM STANDBY). Note The function of the AV I/⏻ switch changes automatically each time you press the input buttons (3).
2 I/⏻ (on/standby)	Press to turn the receiver on or off. To turn off all components, press I/⏻ and AV I/⏻ (1) at the same time (SYSTEM STANDBY).
3 Input buttons	Press one of the buttons to select the component you want to use. When you press any of the input buttons, the receiver turns on. The buttons are factory assigned to control Sony components. You can change the button assignments following the steps in “Changing button assignments” on page 54.
4 2CH A.F.D. MOVIE MUSIC	Press to select a sound field.
5 DVD/BD MENU	Press to display the menu of the DVD or Blu-ray disc on the TV screen. Then, use ↑, ↓, ←, → and ⊕ (16) to perform menu operations.
6 D.SKIP	Press to skip a disc when using a multi-disc changer.
7 D.TUNING	Press to enter direct tuning mode.

Name	Function
8 AMP MENU	Press to display the menu of the receiver. Then, use ↑, ↓, ←, → and ⊕ (16) to perform menu operations.
9 MEMORY ENTER	Press to store a station. Press to enter the value after selecting a channel, disc or track using the numeric buttons of the TV, VCR or satellite tuner.
10 MUTING	Press to turn off the sound temporarily. Press MUTING again to restore the sound. Press MUTING and TV (13) at the same time to activate the TV's muting function.
11 TV VOL +^{a)}/– MASTER VOL +^{a)}/–	Press TV VOL +/- and TV (13) at the same time to adjust the TV volume level. Press to adjust the volume level of all speakers at the same time.
12 ◀◀/▶▶^{b)} REPLAY ◀◀ / ADVANCE ▶▶ ◀◀/▶▶^{b)}	Press to skip a track of the CD player, DVD player or Blu-ray disc player. Press to replay the previous scene or fast forward the current scene of the VCR, DVD player or Blu-ray disc player. Press to – search tracks in the forward/reverse direction of the DVD player. – start fast forward/rewind of the VCR, CD player or Blu-ray disc player.
▷^{a)}b)	Press to start playback of the VCR, CD player, DVD player or Blu-ray disc player.
 ^{b)}	Press to pause playback or recording of the VCR, CD player, DVD player or Blu-ray disc player. (Also starts recording with components in recording standby.)

continued

Name	Function
■ ^{b)}	Press to stop playback of the VCR, CD player, DVD player or Blu-ray disc player.
FM MODE	Press to select the FM monaural or stereo reception.
TV CH +/-	Press TV CH +/- and TV (13) at the same time to select preset TV channels.
PRESET +/-	Press to select – preset stations. – preset channels of the VCR or satellite tuner.
TUNING +/-	Press to scan a station.
13 TV	Press TV and the button you want at the same time to activate the buttons with orange printing.
14 MENU/HOME	Press to display the menu of the VCR, DVD player, satellite tuner or Blu-ray disc player on the TV screen. Press MENU/HOME and TV (13) at the same time to display the TV's menu. Then, use \uparrow , \downarrow , \leftarrow , \rightarrow and \oplus (16) to perform menu operations.
15 RETURN/EXIT 	Press to – return to the previous menu. – exit the menu while the menu or on-screen guide of the VCR, DVD player, satellite tuner or Blu-ray disc player is displayed on the TV screen. Press RETURN/EXIT  and TV (13) at the same time to return to the previous menu or exit the TV's menu while the menu is displayed on the TV screen.

Name	Function
16  , $\uparrow/\downarrow/\leftarrow/\rightarrow$	After pressing DVD/BD MENU (5), AMP MENU (8) or MENU/HOME (14), press \uparrow , \downarrow , \leftarrow or \rightarrow to select the settings. Then, press \oplus to enter the selection if you have pressed DVD/BD MENU or MENU/HOME previously. Press \oplus also to enter the selection of the receiver, VCR, satellite tuner, CD player, DVD player or Blu-ray disc player.
17 DISPLAY	Press to select information displayed on the TV screen of the VCR, satellite tuner, CD player, DVD player or Blu-ray disc player. Press DISPLAY and TV (13) at the same time to display TV's information on the TV screen.
18 TOOLS/OPTIONS	Press to display and select the options of the DVD player or Blu-ray disc player. Press TOOLS/OPTIONS and TV (13) at the same time to display options applicable to the Sony TV.
19 -/-	Press to select the channel entry mode, either one or two digit of the VCR. Press -/- and TV (13) at the same time to select the channel entry mode, either one or two digits of the TV.
>10/•	Press to select – track numbers over 10 of the VCR, satellite tuner or CD player. – channel numbers of the Digital CATV terminal.
CLEAR	Press to clear a mistake when you press the incorrect numeric button.

Name	Function
20 Numeric buttons (number 5^{a)})	<p>Press to</p> <ul style="list-style-type: none"> – preset/tune to preset stations. – select track numbers of the CD player, DVD player or Blu-ray disc player. Press 0/10 to select track number 10. – select channel numbers of the VCR or satellite tuner. Press the numeric buttons and TV (13) at the same time to select the TV channels.
21 TV INPUT	Press TV INPUT and TV (13) at the same time to select the input signal (TV input or video input).
SLEEP	Press to activate the Sleep Timer function and the duration which the receiver turns off automatically.

a) The number 5, MASTER VOL +, TV VOL +, and  buttons have tactile dots. Use the tactile dots as references when operating the receiver.

b) This button is also available for DIGITAL MEDIA PORT adapter operation. For details on the function of the button, see the operating instructions supplied with the DIGITAL MEDIA PORT adapter.

Notes

- Some functions explained in this section may not work depending on the model.
- The above explanation is intended to serve as an example only. Therefore, depending on the component, the above operation may not be possible or may operate differently than described.

1: Installing speakers

This receiver allows you to use a 5.1 channel system (5 speakers and one sub woofer).

To fully enjoy theater-like multi channel surround sound requires five speakers (two front speakers, a center speaker, and two surround speakers) and a sub woofer (5.1 channel).

Example of a 5.1 channel speaker system configuration

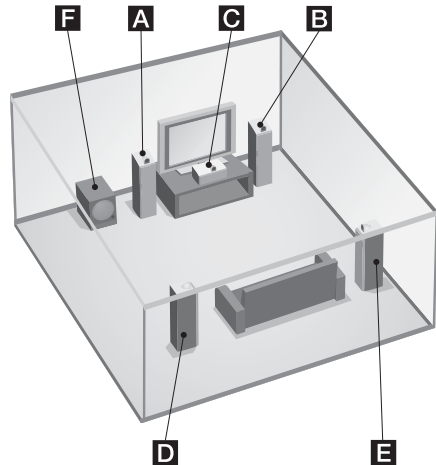

- A** Front speaker (left)
- B** Front speaker (right)
- C** Center speaker
- D** Surround speaker (left)
- E** Surround speaker (right)
- F** Sub woofer

Tip

Since the sub woofer does not emit highly directional signals, you can place it wherever you want.

2: Connecting speakers

Before connecting cords, make sure to disconnect the AC power cord (mains lead).

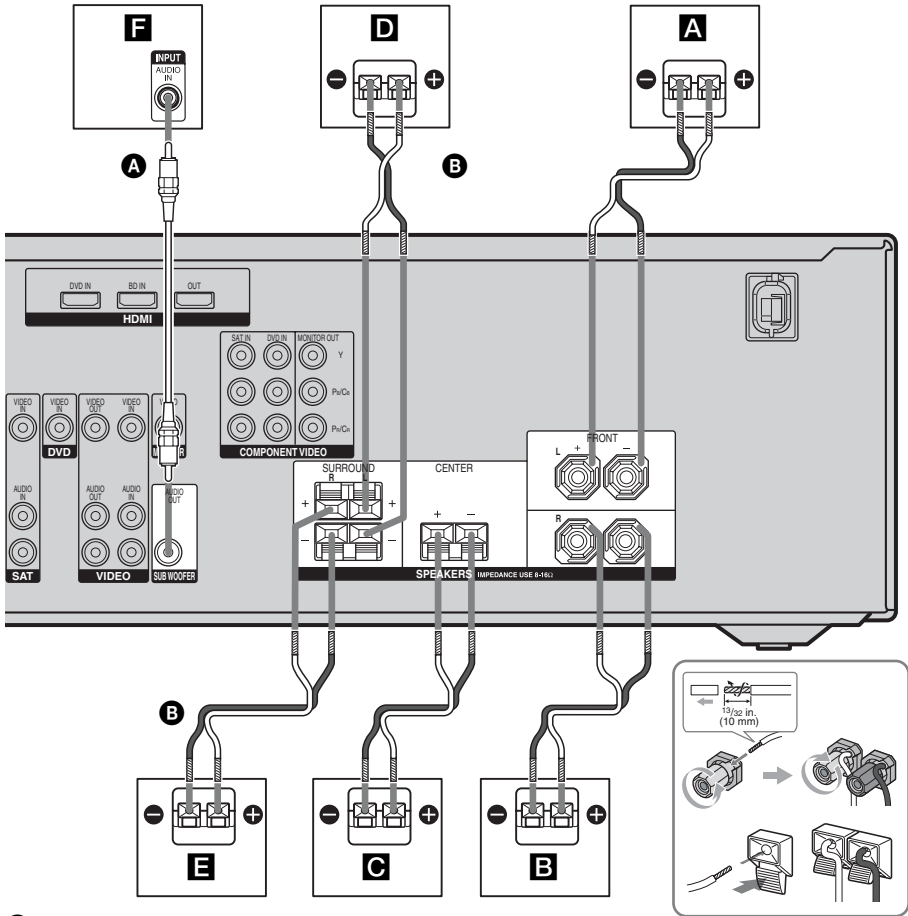

- A** Monaural audio cord (not supplied)
- B** Speaker cords (not supplied)

- A** Front speaker (left)
- B** Front speaker (right)
- C** Center speaker
- D** Surround speaker (left)
- E** Surround speaker (right)
- F** Sub woofer*

* When you connect a sub woofer with an auto standby function, turn off the function when watching movies. If the auto standby function is set to on, it turns to standby mode automatically based on the level of the input signal to a sub woofer, then sound may not be output.

Note

You can turn on or off the speaker system with the SPEAKERS (ON/OFF) button (page 5).

3a: Connecting the audio components

Connecting a Super Audio CD/CD player

The following illustration shows how to connect a Super Audio CD/CD player. After connecting your Super Audio CD/CD player, proceed to “3b: Connecting the video components” (page 16) or “4: Connecting the antennas (aerials)” (page 24).

Before connecting cords, make sure to disconnect the AC power cord (mains lead).

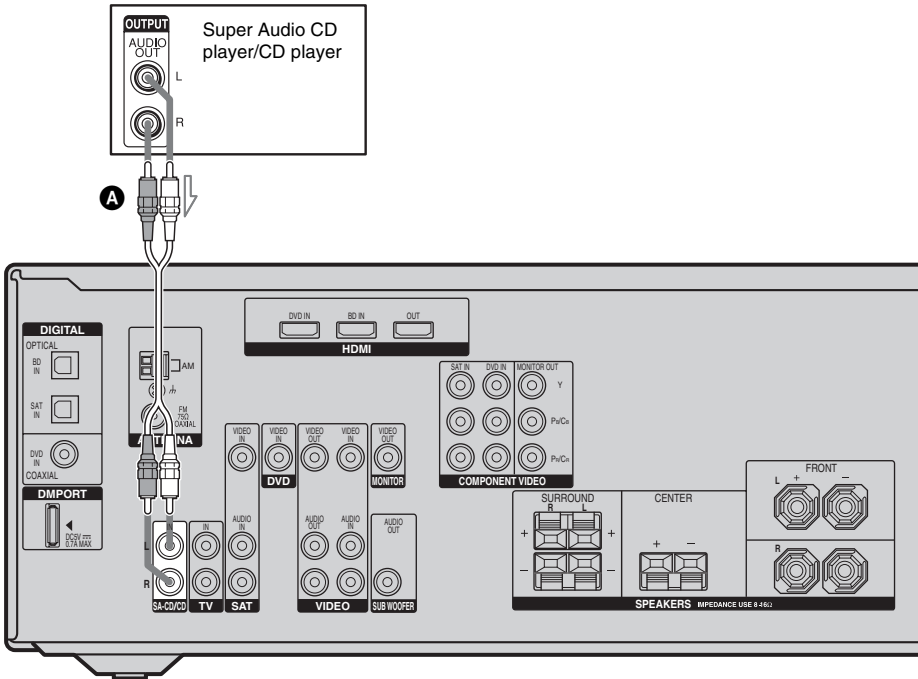

A Audio cord (not supplied)

3b: Connecting the video components

How to connect your components

This section describes how to connect your video components to this receiver. Before you begin, refer to “Component to be connected” below for the pages which describe how to connect each component.

After connecting all your components, proceed to “4: Connecting the antennas (aerials)” (page 24).

Component to be connected

Component	Page
With HDMI jack	17
TV	19
DVD player/DVD recorder	20
Satellite tuner/Set-top box	22
VCR	23

Video input/output jacks to be connected

The image quality depends on the connecting jack. Refer to the illustration that follows. Select the connection according to the jacks on your components.

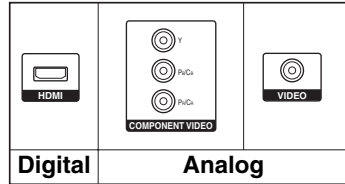

← High quality image

Connecting components with HDMI jacks

HDMI is the abbreviated name for High-Definition Multimedia Interface. It is an interface which transmits video and audio signals in digital format.

Before connecting cables, make sure to disconnect the AC power cord (mains lead).

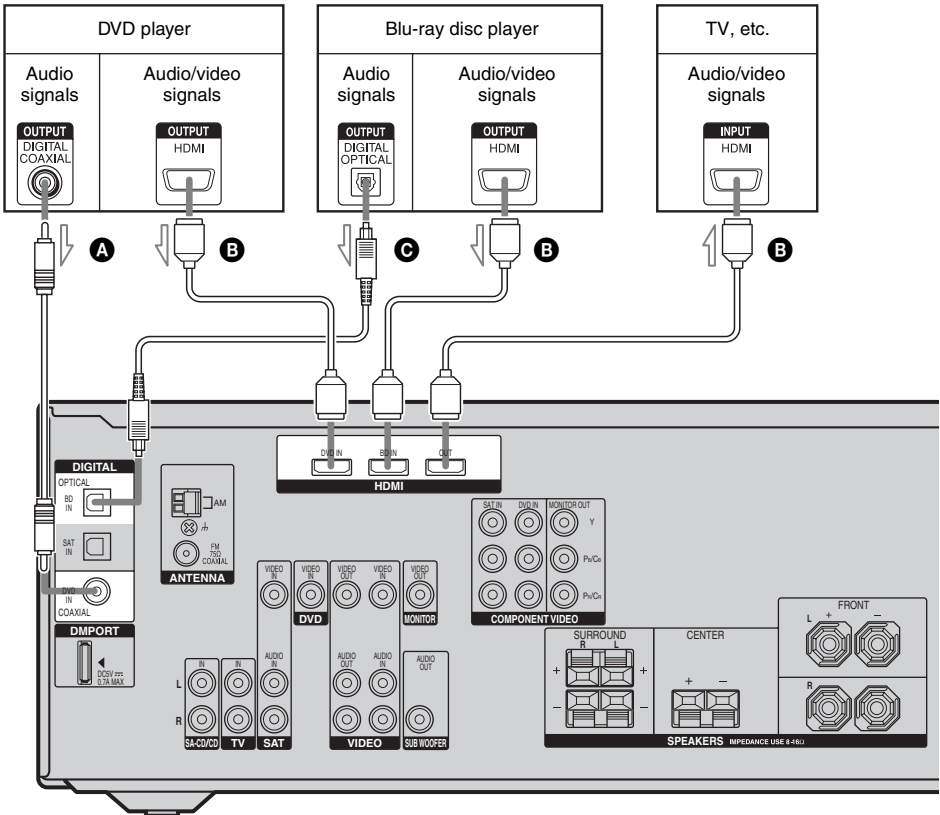

A Coaxial digital cord (not supplied)

B HDMI cable (not supplied)

We recommend that you use a Sony HDMI cable.

C Optical digital cord (not supplied)

Notes on HDMI connections

- The sound is output from the TV speaker only when a playback component and this receiver, as well as this receiver and the TV are connected via the HDMI jack. To output the sound from the speakers and to take advantage of the multi channel surround sound, be sure to
 - connect the digital audio jacks on the playback component to the receiver.
 - turn off TV's volume or activate the TV's muting function.
- The multi/stereo area audio signals of a Super Audio CD are not output.
- Video signals input to the HDMI IN jack can only be output from the HDMI OUT jack. The input video signals cannot be output from the VIDEO OUT jacks, or MONITOR OUT jacks.
- Check the setup of the connected component if an image is poor or the sound does not come out of a component connected via the HDMI cable.
- This receiver may not be able to transfer video or audio signals with certain types of components.
- Refer to the operating instructions of each component connected for details.

Notes

- Be sure to turn on the receiver when the video and audio signals of a playback component are being output to a TV via the receiver. Unless the power is turned on, neither video nor audio signals will be transmitted.
- When connecting optical digital cords, insert the plugs straight in until they click into place.
- Do not bend or tie optical digital cords.

Tip

All the digital audio jacks are compatible with 32 kHz, 44.1 kHz, 48 kHz, and 96 kHz sampling frequencies.

Connecting a TV

The image from a video component connected to this receiver can be displayed on a TV screen.

It is not necessary to connect all the cords. Connect audio and video cords according to the jacks of your components. Before connecting cords, make sure to disconnect the AC power cord (mains lead).

Note

Be sure to turn on the receiver when the video and audio signals of a playback component are being output to a TV via the receiver. Unless the power is turned on, neither video nor audio signals will be transmitted.

Tips

- You can watch the selected input image when you connect the MONITOR OUT or HDMI OUT jack to a TV or projector.
- To output the sound of the TV from the speakers connected to the receiver, be sure to:
 - connect the audio output jacks of the TV to the TV AUDIO IN jacks of the receiver.
 - turn off TV's volume or activate the TV's muting function.

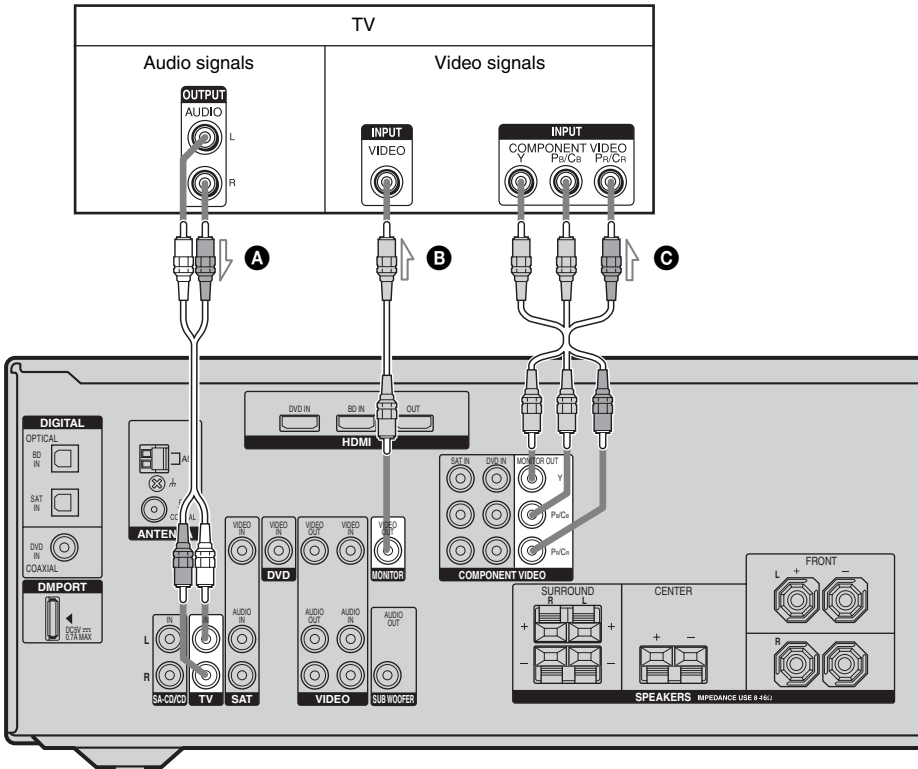

- Ⓐ Audio cord (not supplied)
- Ⓑ Video cord (not supplied)
- Ⓒ Component video cord (not supplied)

Connecting a DVD player/DVD recorder

The following illustration shows how to connect a DVD player/DVD recorder. It is not necessary to connect all the cords. Connect audio and video cords according to the jacks of your components. Before connecting cords, make sure to disconnect the AC power cord (mains lead).

Notes

- To input multi channel digital audio from the DVD player, set the digital audio output setting on the DVD player. Refer to the operating instructions supplied with the DVD player.
- As this receiver does not have analog audio input jacks for DVD, connect your DVD player to the DIGITAL COAXIAL DVD IN jack on the receiver. To output sound from the front left/right speakers only, press 2CH.

Tip

All the digital audio jacks are compatible with 32 kHz, 44.1 kHz, 48 kHz, and 96 kHz sampling frequencies.

Connecting a DVD player

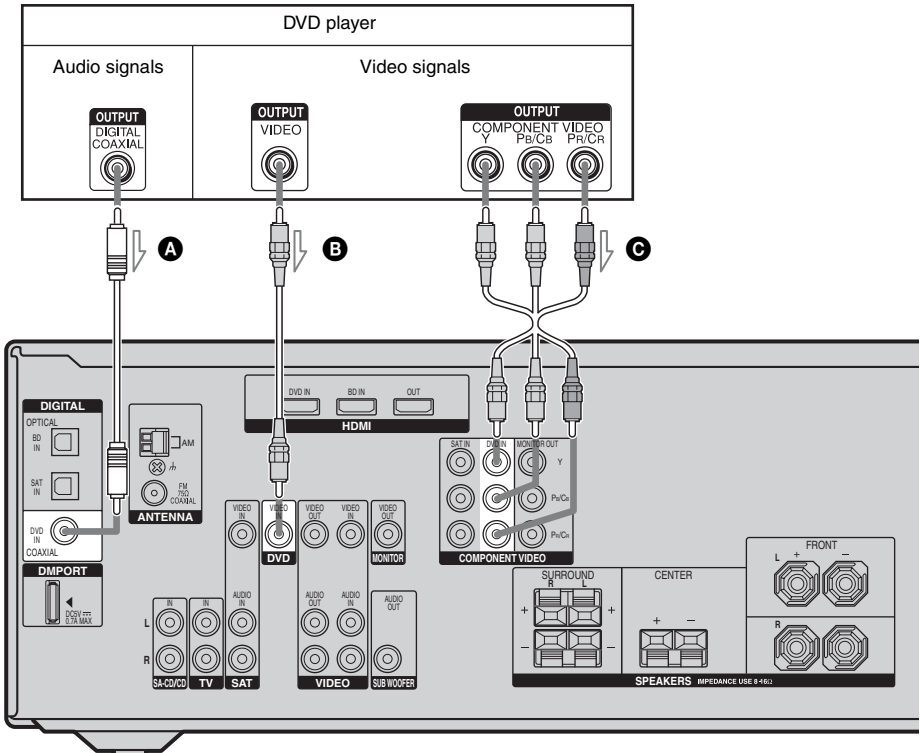

- A** Coaxial digital cord (not supplied)
- B** Video cord (not supplied)
- C** Component video cord (not supplied)

Connecting a DVD recorder

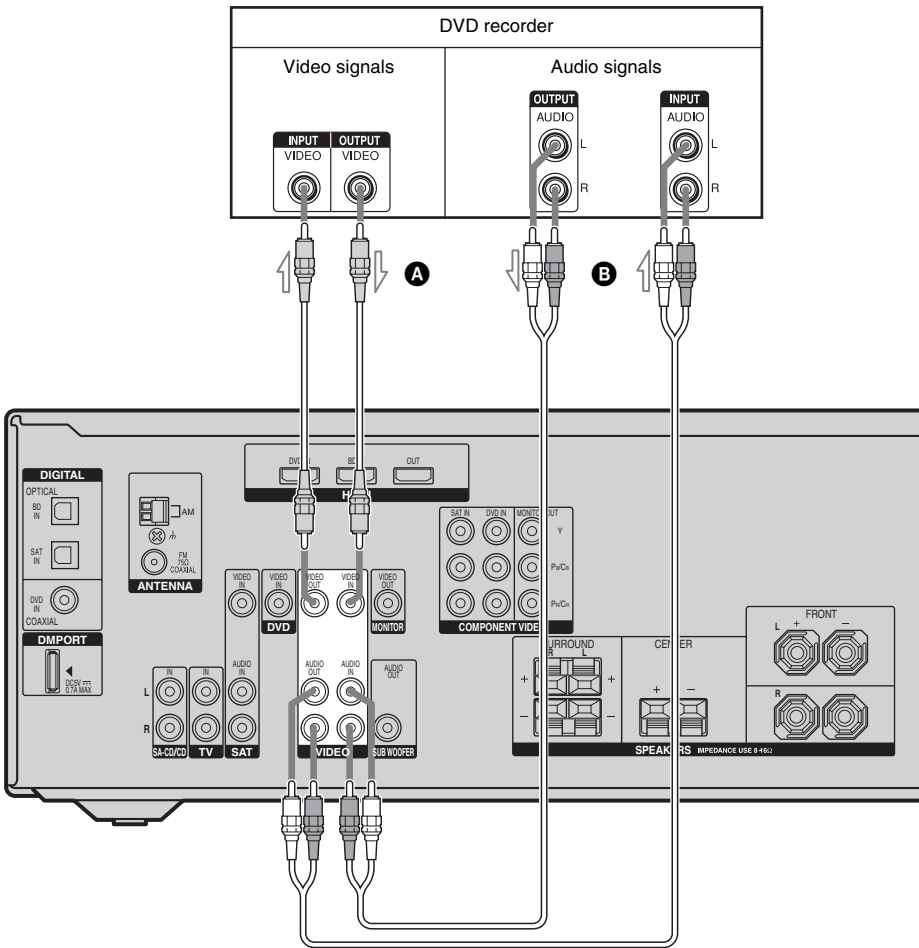

- A** Video cord (not supplied)
- B** Audio cord (not supplied)

Notes

- Be sure to change the factory setting of the VIDEO input button on the remote so that you can use the button to control your DVD recorder. For details, see “Changing button assignments” (page 54).
- You can also rename the VIDEO input so that it can be displayed on the receiver’s display. For details, see “Naming inputs” (page 52).

Connecting a satellite tuner/ set-top box

The following illustration shows how to connect a satellite tuner or a set-top box. It is not necessary to connect all the cords. Connect audio and video cords according to the jacks of your components. Before connecting cords, make sure to disconnect the AC power cord (mains lead).

Notes

- When connecting optical digital cords, insert the plugs straight in until they click into place.
- Do not bend or tie optical digital cords.

Tip

All the digital audio jacks are compatible with 32 kHz, 44.1 kHz, 48 kHz, and 96 kHz sampling frequencies.

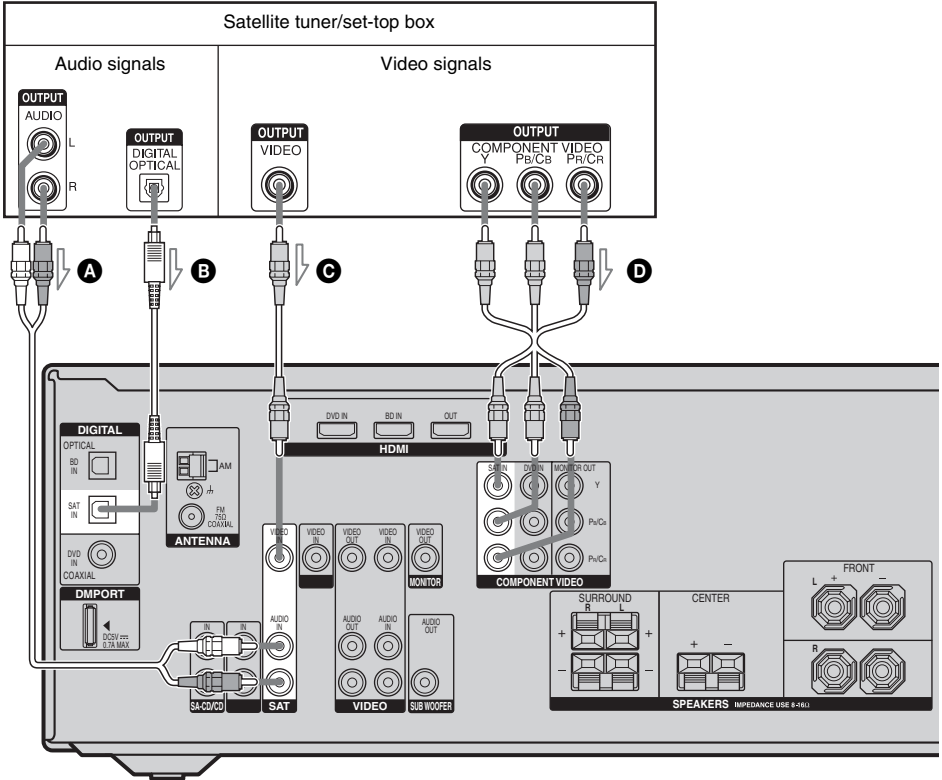

- A** Audio cord (not supplied)
- B** Optical digital cord (not supplied)
- C** Video cord (not supplied)
- D** Component video cord (not supplied)

Connecting components with analog video and audio jack

Before connecting cords, make sure to disconnect the AC power cord (mains lead).

The following illustration shows how to connect a component which has analog jacks such as a VCR, etc.

It is not necessary to connect all the cords.
Connect audio and video cords according to the jacks of your components.

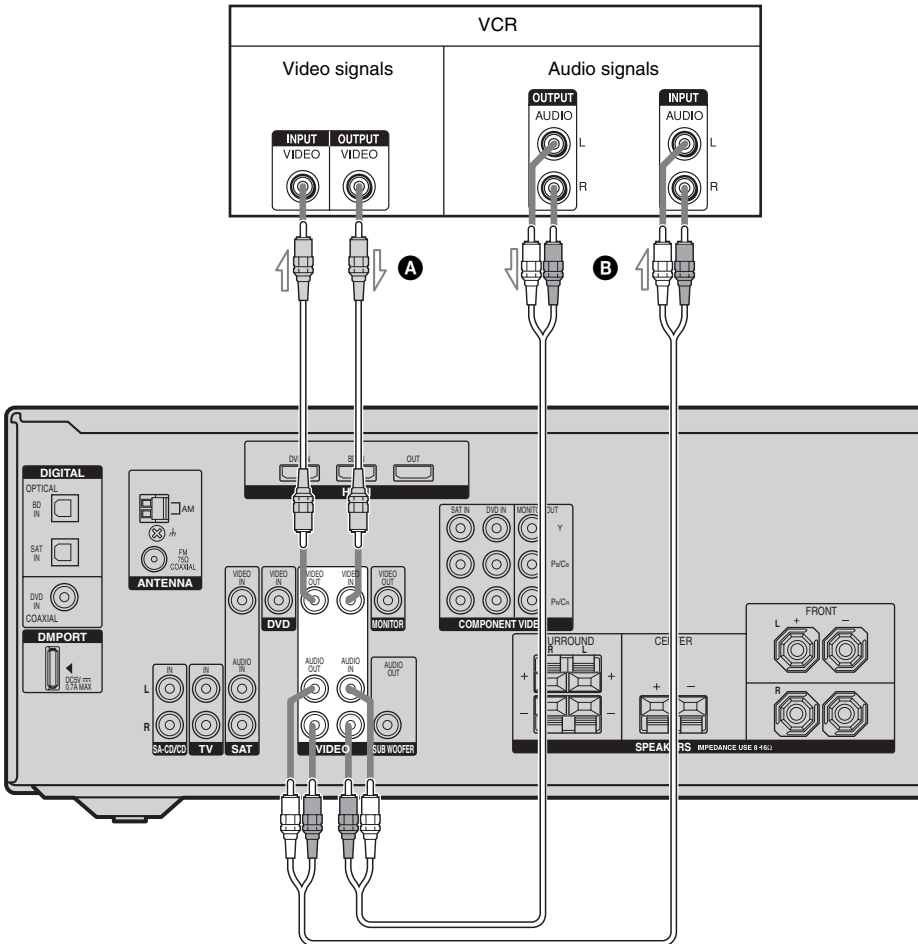

- A** Video cord (not supplied)
- B** Audio cord (not supplied)

4: Connecting the antennas (aerials)

Connect the supplied AM loop antenna (aerial) and FM wire antenna (aerial).

Before connecting the antennas, make sure to disconnect the AC power cord (mains lead).

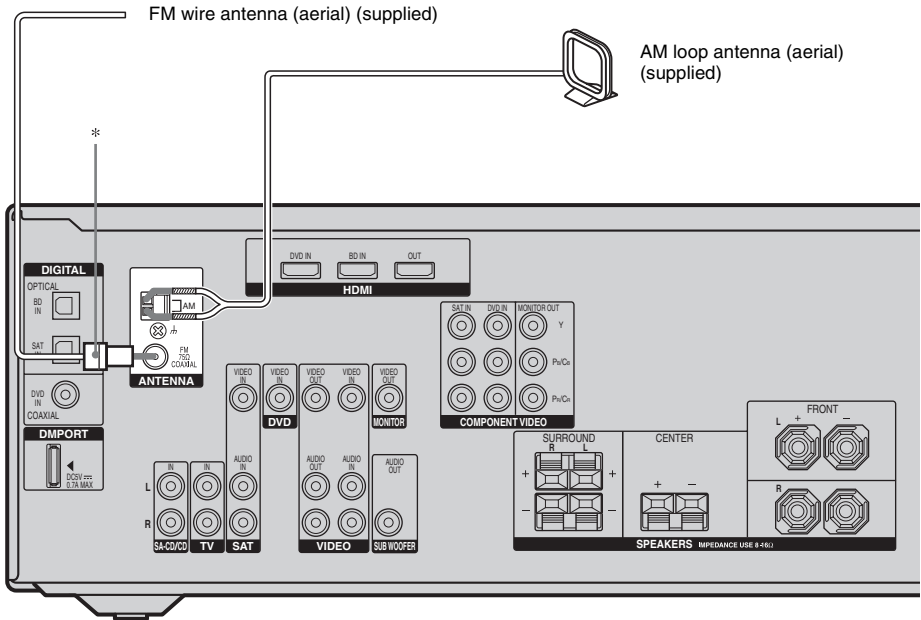

* The shape of the connector varies depending on the area code of this receiver.

Notes

- To prevent noise pickup, keep the AM loop antenna (aerial) away from the receiver and other components.
- Be sure to fully extend the FM wire antenna (aerial).
- After connecting the FM wire antenna (aerial), keep it as horizontal as possible.

5: Preparing the receiver and the remote

Connecting the AC power cord (mains lead)

Connect the AC power cord (mains lead) to a wall outlet.

Notes

- Before connecting the AC power cord (mains lead), make sure that the stripped end of the speaker cords are not touching each other between the speaker terminals.
- Connect the AC power cord (mains lead) firmly.

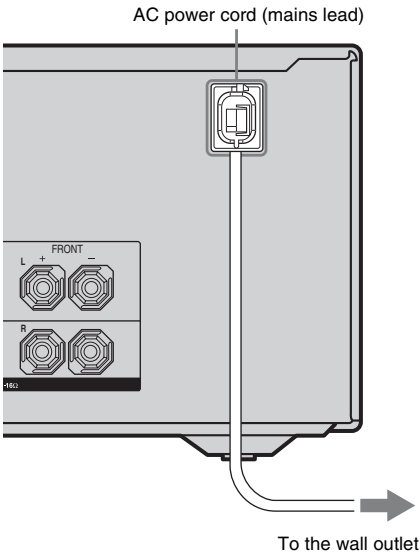

Performing initial setup operations

Before using the receiver for the first time, initialize the receiver by performing the following procedure. This procedure can also be used to return settings you have made to their factory defaults.

Be sure to use the buttons on the receiver for this operation.

1,2

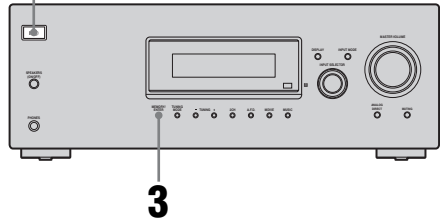

- 1 Press I/O to turn off the receiver.**
- 2 Hold down I/O for 5 seconds.**
“PUSH” and “ENTER” appears on the display alternately.
- 3 Press MEMORY/ENTER.**

After “CLEARING” appears on the display for a while, “CLEARED” appears.
All the settings you have changed or adjusted are reset to the initial settings.

Inserting batteries into the remote

Insert two R6 (size-AA) batteries in the RM-AAU020 Remote Commander. Observe the correct polarity when installing batteries.

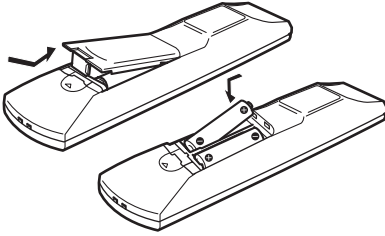

Notes

- Do not leave the remote in an extremely hot or humid place.
- Do not use a new battery with old ones.
- Do not mix manganese batteries and other kinds of batteries.
- Do not expose the remote sensor to direct sunlight or lighting apparatuses. Doing so may cause a malfunction.
- If you do not intend to use the remote for an extended period of time, remove the batteries to avoid possible damage from battery leakage and corrosion.
- When you replace the batteries, the remote buttons may be reset to their factory settings. If this happens, reassign the buttons again (page 54).

Tip

Under normal conditions, the batteries should last for about 3 months. When the remote no longer operates the receiver, replace all the batteries with new ones.

6: Adjusting the speaker levels and balance (TEST TONE)

You can adjust the speaker levels and balance while listening to the test tone from your listening position.

Tip

The receiver employs a test tone with a frequency centered at 800 Hz.

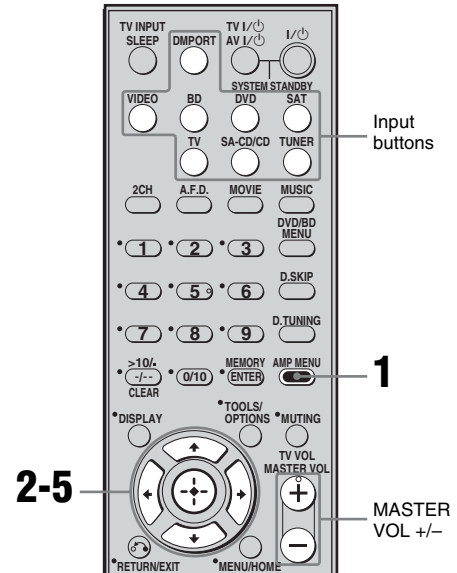

- 1 Press AMP MENU.**
“1-LEVEL” appears on the display.
- 2 Press \oplus or \rightarrow to enter the menu.**
- 3 Press \uparrow/\downarrow repeatedly to select “T. TONE”.**
- 4 Press \oplus or \rightarrow to enter the parameter.**

5 Press $\blacktriangle/\blacktriangledown$ repeatedly to select “T. TONE Y”.

The test tone is output from each speaker in sequence as follows:

Front left → Center → Front right →
Surround right → Surround left →
Sub woofer

6 Adjust the speaker levels and balance using the LEVEL menu so that the level of the test tone sounds the same from each speaker.

For details, see “Adjusting the level (LEVEL menu)” (page 34).

Tips

- To adjust the level of all speakers at the same time, press MASTER VOL +/- . You can also use MASTER VOLUME on the receiver.
- The adjusted value is shown on the display during adjustment.

7 Repeat steps 1 to 5 to select “T. TONE N”.

You can also press any input buttons.
The test tone turns off.

When a test tone is not output from the speakers

- The speaker cords may not be connected securely.
- The speaker cords may have the short-circuit problem.

Note

The test tone does not work when ANALOG DIRECT is selected.

Selecting a component

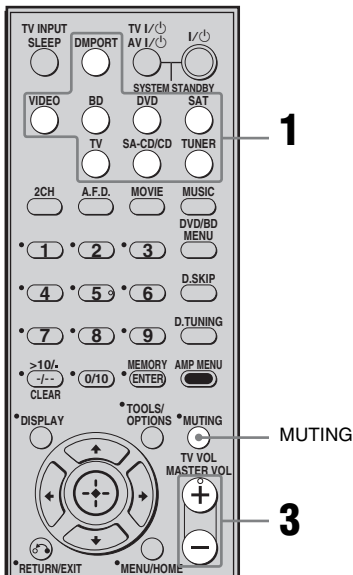

1 Press the input button to select a component.

You can also use INPUT SELECTOR on the receiver.

The selected input appears on the display.

Selected input [Display]	Components that can be played back
VIDEO [VIDEO]	VCR, etc., connected to the VIDEO jack
BD [BD]	Blu-ray disc player, etc., connected to the BD jack
DVD [DVD]	DVD player, etc., connected to the DVD jack
SAT [SAT]	Satellite tuner, etc., connected to the SAT jack
TV [TV]	TV, etc., connected to the TV jack
SA-CD/CD [SA-CD/CD]	Super Audio CD/CD player, etc., connected to the SA-CD/CD jack
TUNER [FM or AM band]	Built-in radio tuner
DMPORT [DMPORT]	DIGITAL MEDIA PORT adapter connected to DMPORT jack

2 Turn on the component and start playback.

3 Press MASTER VOL +/- to adjust the volume.

You can also use MASTER VOLUME on the receiver.

To activate the muting function

Press MUTING.

The muting function will be canceled when you do the following.

- Press MUTING again.
- Increase the volume.
- Turn off the receiver.

To avoid damaging your speakers

Before you turn off the receiver, be sure to turn down the volume level.

Listening/Watching a component

Listening to a Super Audio CD/CD

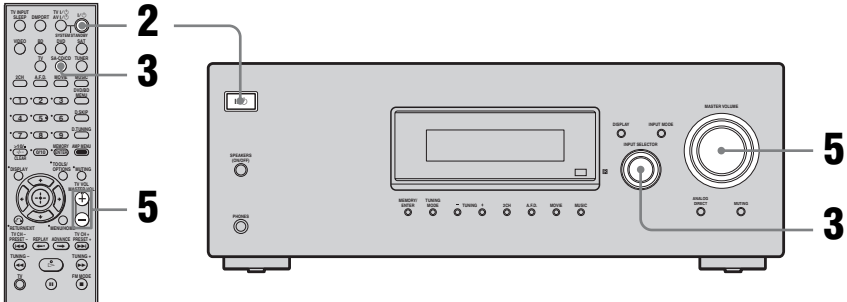

Notes

- The operation is described for a Sony Super Audio CD player.
- Refer to the operating instructions supplied with the Super Audio CD player or CD player.

Tip

You can select the sound field to suit the music. Refer to page 40 for details.

Recommended sound fields:

Classical: HALL

Jazz: JAZZ

Live concert: CONCERT

- 1 Turn on the Super Audio CD player/CD player, then place the disc on the tray.**
- 2 Turn on the receiver.**
- 3 Press SA-CD/CD.**
You can also use INPUT SELECTOR on the receiver to select "SA-CD/CD".
- 4 Play back the disc.**
- 5 Adjust to a suitable volume.**
- 6 After you have finished listening to the Super Audio CD/CD, eject the disc and turn off the receiver and Super Audio CD player/CD player.**

Watching a DVD /Blu-ray disc

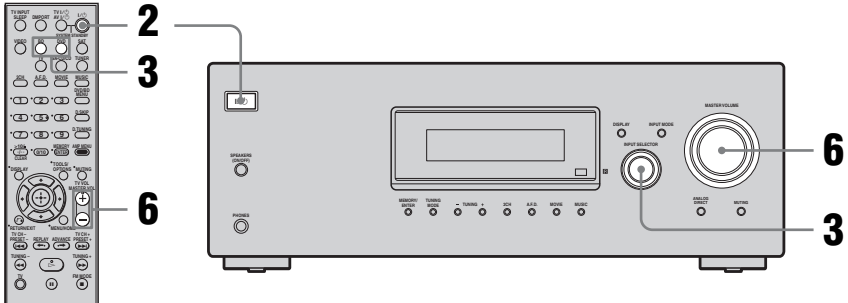

Notes

- Refer to the operating instructions supplied with the TV and DVD player or Blu-ray disc player.
- Check the following if you cannot listen to multi channel sound.
 - Be sure this receiver is connected to the DVD player or Blu-ray disc player via a digital connection.
 - Be sure the digital audio output of the DVD player or Blu-ray disc player is set up properly.

Tips

- Select the sound format of the disc to be played, if necessary.
- You can select the sound field to suit the movie/music. Refer to page 40 for details.
Recommended sound fields:
Movie: C.ST.EX
Music: CONCERT

1 Turn on the TV and DVD player or Blu-ray disc player.

2 Turn on the receiver.

3 Press DVD or BD.

You can also use INPUT SELECTOR on this receiver to select “DVD” or “BD”.

4 Switch the input of the TV so that an image of the DVD or Blu-ray disc is displayed.

5 Play back the disc.

6 Adjust to a suitable volume.

7 After you have finished watching the DVD or Blu-ray disc, eject the disc and turn off the receiver, TV and DVD player or Blu-ray disc player.

Amplifier Operations

Navigating through menus

By using the amplifier menus, you can make various adjustments to customize the receiver.

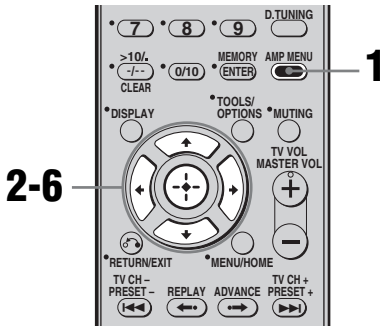

To return to the previous display

Press \leftarrow .

To exit the menu

Press AMP MENU.

Note

Some parameters and settings may appear dimmed on the display. This means that they are either unavailable or fixed and unchangeable.

- 1 Press AMP MENU.**
“1-LEVEL” appears on the display.
- 2 Press \uparrow/\downarrow repeatedly to select the menu you want.**
- 3 Press \oplus or \rightarrow to enter the menu.**
- 4 Press \uparrow/\downarrow repeatedly to select the parameter you want to adjust.**
- 5 Press \oplus or \rightarrow to enter the parameter.**
- 6 Press \uparrow/\downarrow repeatedly to select the setting you want.**
The setting is entered automatically.

Overview of the menus

The following options are available in each menu. For details on navigating through menus, see page 31.

Menu [Display]	Parameters [Display]	Settings	Initial setting
LEVEL [1-LEVEL] (page 34)	Test tone ^{a)} [T. TONE]	T. TONE N, T. TONE Y	T. TONE N
	Front speaker balance ^{a)} [FRT BAL]	BAL. L +1 to BAL. L +8, BALANCE, BAL. R +1 to BAL. R +8	BALANCE
	Center speaker level [CNT LVL]	CNT -10 dB to CNT +10 dB (1 dB step)	CNT 0 dB
	Surround left speaker level [SL LVL]	SUR L -10 dB to SUR L +10 dB (1 dB step)	SUR L 0 dB
	Surround right speaker level [SR LVL]	SUR R -10 dB to SUR R +10 dB (1 dB step)	SUR R 0 dB
	Sub woofer level [SW LVL]	SW -10 dB to SW +10 dB (1 dB step)	SW 0 dB
	Dynamic range compressor ^{a)} [D. RANGE]	COMP. OFF, COMP. STD, COMP. MAX	COMP. OFF
TONE [2-TONE] (page 35)	Front speaker bass level [BASS LVL]	BASS -6 dB to BASS +6 dB (1 dB step)	BASS 0 dB
	Front speaker treble level [TRE LVL]	TRE -6 dB to TRE +6 dB (1 dB step)	TRE 0 dB
SUR [3-SUR] (page 35)	Sound field selection ^{a)} [S.F. SELCT]	For details, see “Enjoying Surround Sound” (page 40).	A.F.D. AUTO for: VIDEO, BD, DVD, SAT; 2CH ST. for: TV, SA-CD/CD, TUNER, DMPORT
	Effect level ^{a)} [EFFECT]	EFCT. MIN, EFCT. STD, EFCT. MAX	EFCT. STD
TUNER [4-TUNER] (page 36)	FM station receiving mode ^{a)} [FM MODE]	FM AUTO, FM MONO	FM AUTO
	Naming preset stations ^{a)} [NAME IN]	For details, see “Naming preset stations” (page 49).	

Menu [Display]	Parameters [Display]	Settings	Initial setting
AUDIO [5-AUDIO] (page 36)	Digital audio input decoding priority ^{a)} [DEC. PRI.]	DEC. PCM, DEC. AUTO	DEC. AUTO
	Digital broadcast language selection ^{a)} [DUAL]	DUAL M/S, DUAL M, DUAL S, DUAL M+S	DUAL M
	Synchronizes audio and video output ^{a)} [A.V. SYNC.]	A.V.SYNC. N, A.V.SYNC. Y	A.V.SYNC. N
	Naming inputs ^{a)} [NAME IN]	For details, see “Naming inputs” (page 52).	
SYSTEM [6-SYSTEM] (page 37)	Sub woofer ^{a)} [SW SPK]	YES, NO	YES
	Front speakers ^{a)} [FRT SPK]	SMALL, LARGE	LARGE
	Center speakers ^{a)} [CNT SPK]	NO, SMALL, LARGE	LARGE
	Surround speakers ^{a)} [SUR SPK]	NO, SMALL, LARGE	LARGE
	Front speaker distance ^{a)} [FRT DIST.]	DIST. 3 ft. to DIST. 23 ft. (1 ft. step)	DIST. 10 ft.
	Center speaker distance ^{a)} [CNT DIST.]	DIST. 3 ft. to DIST. 23 ft. (1 ft. step)	DIST. 10 ft.
	Surround left speaker distance ^{a)} [SL DIST.]	DIST. 3 ft. to DIST. 23 ft. (1 ft. step)	DIST. 10 ft.
	Surround right speaker distance ^{a)} [SR DIST.]	DIST. 3 ft. to DIST. 23 ft. (1 ft. step)	DIST. 10 ft.
	Surround speaker position ^{a)} [SUR POS.]	BEHD/HI, BEHD/LO, SIDE/HI, SIDE/LO	SIDE/LO
	Speaker crossover frequency ^{a)} [CRS. FREQ]	CRS > 40 Hz to CRS > 160 Hz	CRS > 100 Hz
	Brightness of the display ^{a)} [DIMMER]	0% dim, 40% dim, 70% dim	0% dim

^{a)} For details, refer to the page in the parentheses.

Adjusting the level

(LEVEL menu)

You can use the LEVEL menu to adjust the balance and level of each speaker. These settings are applied to all sound fields. Select “1-LEVEL” in the amplifier menus. For details on adjusting the parameters, see “Navigating through menus” (page 31) and “Overview of the menus” (page 32).

LEVEL menu parameters

■ T. TONE (Test tone)

Lets you adjust the speaker levels and balance while listening to the test tone from your listening position. For details, see “6: Adjusting the speaker levels and balance (TEST TONE)” (page 26).

■ FRT BAL (Front speaker balance)

Lets you adjust the balance between front left and right speakers.

■ CNT LVL (Center speaker level)

■ SL LVL (Surround left speaker level)

■ SR LVL (Surround right speaker level)

■ SW LVL (Sub woofer level)

■ D. RANGE (Dynamic range compressor)

Lets you compress the dynamic range of the sound track. This may be useful when you want to watch movies at low volumes late at night. Dynamic range compression is possible with Dolby Digital sources only.

- COMP. OFF

The dynamic range is not compressed.

- COMP. STD

The dynamic range is compressed as intended by the recording engineer.

- COMP. MAX

The dynamic range is compressed dramatically.

Tip

Dynamic range compressor lets you compress the dynamic range of the soundtrack based on the dynamic range information included in the Dolby Digital signal.

“COMP. STD” is the standard setting, but it only enacts light compression. Therefore, we recommend using the “COMP. MAX” setting. This greatly compresses the dynamic range and lets you view movies late at night at low volumes. Unlike analog limiters, the levels are predetermined and provide a very natural compression.

Adjusting the tone (TONE menu)

You can use the TONE menu to adjust the tonal quality (bass/treble level) of the front speakers. These settings are applied to all sound fields.

Select “2-TONE” in the amplifier menus. For details on adjusting the parameters, see “Navigating through menus” (page 31) and “Overview of the menus” (page 32).

TONE menu parameters

- **BASS LVL (Front speaker bass level)**
- **TRE LVL (Front speaker treble level)**

Settings for the surround sound (SUR menu)

You can use the SUR menu to select the sound field you want for your listening pleasure.

Select “3-SUR” in the amplifier menus. For details on adjusting the parameters, see “Navigating through menus” (page 31) and “Overview of the menus” (page 32).

SUR menu parameters

■ S.F. SELCT (Sound field selection)

Lets you select the sound field you want. For details, see “Enjoying Surround Sound” (page 40).

Note

The receiver lets you apply the last selected sound field to an input whenever it is selected (Sound Field Link). For example, if you select “HALL” for the SA-CD/CD input, then change to a different input and then return to SA-CD/CD, “HALL” will automatically be applied again.

■ EFFECT (Effect level)

Lets you adjust the “presence” of the surround effect for sound fields selected with the MOVIE or MUSIC buttons and for “HP THEA” sound field.

- EFCT. MIN
The surround effect is minimum.
- EFCT. STD
The surround effect is standard.
- EFCT. MAX
The surround effect is maximum.

Settings for the tuner

(TUNER menu)

You can use the TUNER menu to set the FM station receiving mode and to name preset stations.

Select “4-TUNER” in the amplifier menus. For details on adjusting the parameters, see “Navigating through menus” (page 31) and “Overview of the menus” (page 32).

TUNER menu parameters

■ FM MODE (FM station receiving mode)

- FM AUTO
This receiver will decode the signal as stereo signal when the radio station is broadcast in stereo.
- FM MONO
This receiver will decode the signal as mono signal regardless of the broadcast signal.

■ NAME IN (Naming preset stations)

Lets you set the name of preset stations. For details, see “Naming preset stations” (page 49).

Settings for the audio

(AUDIO menu)

You can use the AUDIO menu to make settings for the audio to suit your preference. Select “5-AUDIO” in the amplifier menus. For details on adjusting the parameters, see “Navigating through menus” (page 31) and “Overview of the menus” (page 32).

AUDIO menu parameters

■ DEC. PRI. (Digital audio input decoding priority)

Lets you specify the input mode for the digital signal input to the DIGITAL IN jacks.

- DEC. PCM
PCM signals are given priority (to prevent interruption when playback starts). However, when other signals are input, there may be no sound depending on the format. In this case, set to “DEC. AUTO”.
- DEC. AUTO
Automatically switches the input mode between DTS, Dolby Digital, or PCM.

Note

When set to “DEC. AUTO” and the sound from the digital audio jacks (for a CD, etc.) is interrupted when playback starts, set to “DEC. PCM”.

■ DUAL (Digital broadcast language selection)

Lets you select the language you want to listen to during digital broadcast. This feature only functions for Dolby Digital sources.

- DUAL M/S (Main/Sub)
Sound of the main language will be output through the front left speaker and sound of the sub language will be output through the front right speaker simultaneously.
- DUAL M (Main)
Sound of the main language will be output.
- DUAL S (Sub)
Sound of the sub language will be output.
- DUAL M+S (Main + Sub)
Mixed sound of both the main and sub languages will be output.

■ A.V. SYNC. (Synchronizes audio and video output)

- A.V.SYNC. N (No) (Delay time: 0 ms)
The audio output is not delayed.
- A.V.SYNC. Y (Yes) (Delay time: 60 ms)
The audio output is delayed so that the time gap between the audio output and visual display is minimized.

Notes

- This parameter is useful when you use a large LCD or plasma TV or a projector.
- This parameter is valid only when you use a sound field selected with the 2CH or A.F.D. buttons.
- This parameter is not valid when
 - signals with a sampling frequency of more than 48 kHz is input.
 - ANALOG DIRECT function is selected.

■ NAME IN (Naming inputs)

Lets you set the name of inputs. For details, see “Naming inputs” (page 52).

Settings for the system (SYSTEM menu)

You can use the SYSTEM menu to set the size and distance of the speakers connected to this system.

Select “6-SYSTEM” in the amplifier menus. For details on adjusting the parameters, see “Navigating through menus” (page 31) and “Overview of the menus” (page 32).

SYSTEM menu parameters

■ SW SPK (Sub woofer)

- YES
If you have connected a sub woofer, select “YES”.
- NO
If you have not connected a sub woofer, select “NO”. This activates the bass redirection circuitry and outputs the LFE signals from other speakers.

Tip

In order to take full advantage of the Dolby Digital bass redirection circuitry, we recommend setting the sub woofer’s cut off frequency as high as possible.

■ FRT SPK (Front speakers)

- **SMALL**

If the sound is distorted, or you feel a lack of surround effects when using multi channel surround sound, select “SMALL” to activate the bass redirection circuitry and output the front channel bass frequencies from the sub woofer. When the front speakers are set to “SMALL”, the center and surround speakers are also automatically set to “SMALL” (unless previously set to “NO”).

- **LARGE**

If you connect large speakers that will effectively reproduce bass frequencies, select “LARGE”. Normally, select “LARGE”. When the sub woofer is set to “NO”, the front speakers are automatically set to “LARGE”.

■ CNT SPK (Center speaker)

- **NO**

If you have not connected a center speaker, select “NO”. The sound of the center channel will be output from the front speakers.

- **SMALL**

If the sound is distorted, or you feel a lack of surround effects when using multi channel surround sound, select “SMALL” to activate the bass redirection circuitry and output the center channel bass frequencies from the front speakers (if set to “LARGE”) or sub woofer.

- **LARGE**

If you connect a large speaker that will effectively reproduce bass frequencies, select “LARGE”. Normally, select “LARGE”. However, if the front speakers are set to “SMALL”, you cannot set the center speaker to “LARGE”.

■ SUR SPK (Surround speakers)

- **NO**

If you have not connected surround speakers, select “NO”.

- **SMALL**

If the sound is distorted, or you feel a lack of surround effects when using multi channel surround sound, select “SMALL” to activate the bass redirection circuitry and output the surround channel bass frequencies from the sub woofer or other “LARGE” speakers.

- **LARGE**

If you connect large speakers that will effectively reproduce bass frequencies, select “LARGE”. Normally, select “LARGE”. However, if the front speakers are set to “SMALL”, you cannot set the surround speakers to “LARGE”.

Tip

The “LARGE” and “SMALL” settings for each speaker determine whether the internal sound processor will cut the bass signal from that channel. When the bass is cut from a channel, the bass redirection circuitry sends the corresponding bass frequencies to the sub woofer or other “LARGE” speakers.

However, since bass sounds have a certain amount of directionality, it is best not to cut them, if possible. Therefore, even when using small speakers, you can set them to “LARGE” if you want to output the bass frequencies from that speaker. On the other hand, if you are using a large speaker, but prefer not to have bass frequencies output from that speaker, set it to “SMALL”.

If the overall sound level is lower than you prefer, set all speakers to “LARGE”. If there is not enough bass, you can use the tone to boost the bass levels. For details, see page 32.

■ **FRT DIST. (Front speaker distance)**

Lets you set the distance from your listening position to the front speakers (A). If both front speakers are not placed an equal distance from your listening position, set the distance to the closest speaker.

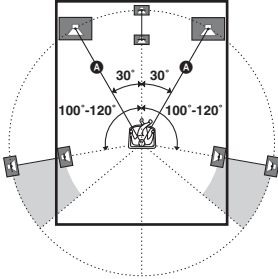

■ **CNT DIST. (Center speaker distance)**

Lets you set the distance from your listening position to the center speaker.

■ **SL DIST. (Surround left speaker distance)**

■ **SR DIST. (Surround right speaker distance)**

Lets you set the distance from your listening position to the surround speaker.

■ **SUR POS. (Surround speaker position)**

Lets you specify the location of your surround speakers for proper implementation of the surround effects in the Cinema Studio EX modes (page 43). This setup item is not available when the surround speakers are set to “NO” (page 33).

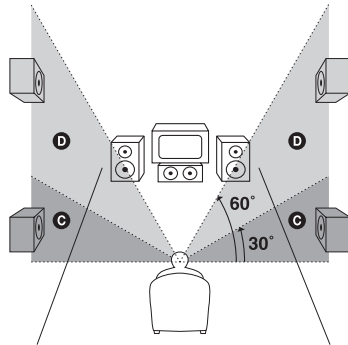
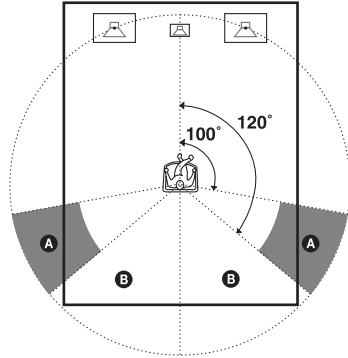

- **BEHD/HI**
Select if the location of your surround speakers corresponds to sections **B** and **D**.
- **BEHD/LO**
Select if the location of your surround speakers corresponds to sections **B** and **C**.
- **SIDE/HI**
Select if the location of your surround speakers corresponds to sections **A** and **D**.
- **SIDE/LO**
Select if the location of your surround speakers corresponds to sections **A** and **C**.

Tip

Surround speaker position is designed specifically for implementation of the Cinema Studio EX modes. For other sound fields, speaker position is not so critical.

Those sound fields were designed under the premise that the surround speakers would be located behind the listening position, but presentation remains fairly consistent even with the surround speakers positioned at a rather wide angle. However, if the speakers are pointing toward the listener from the immediate left and right of the listening position, the surround effects become unclear unless set to “SIDE/LO” or “SIDE/HI”.

Nevertheless, each listening environment has many variables, such as wall reflections, and you may obtain better results using “BEHD/HI” if your speakers are located high above the listening position, even if they are located to the immediate left and right.

Therefore, although it may result in a setting contrary to the above explanation, we recommend that you playback multi channel surround encoded software and select the setting that provides a good sense of spaciousness and that best succeeds in forming a cohesive space between the surround sound from the surround speakers and the sound of the front speakers. If you are not sure which sounds best, select “BEHD/LO” or “BEHD/HI” and then use the speaker distance parameter and speaker level adjustments to obtain proper balance.

■ CRS. FREQ (Speaker crossover frequency)

Lets you set the bass crossover frequency of the speakers that have been set to “SMALL” on the SYSTEM menu. This setup item is only available when at least one speaker is set to “SMALL” and the corresponding speaker indicator flashes on the display.

■ DIMMER (Brightness of the display)

Lets you adjust the brightness in 3 steps.

Enjoying Surround Sound

Enjoying Dolby Digital and DTS Surround sound (AUTO FORMAT DIRECT)

The Auto Format Direct (A.F.D.) mode allows you to listen to higher fidelity sound and select the decoding mode for listening to a 2 channel stereo sound as multi channel sound.

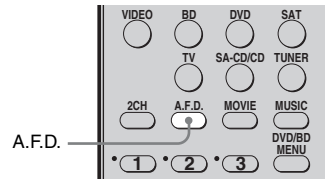

Press A.F.D. repeatedly to select the sound field you want.

For details, see “Types of A.F.D. mode” (page 41).

Types of A.F.D. mode

A.F.D. mode [Display]	Multi channel audio after decoding	Effect
A.F.D. AUTO [A.F.D. AUTO]	(Detecting automatically)	Presents the sound as it was recorded/encoded without adding any surround effects. However, this receiver will generate a low frequency signal for output to the sub woofer when there is no LFE signals.
PRO LOGIC [DOLBY PL]	4 channel	Performs Dolby Pro Logic decoding. The source recorded in 2 channel format is decoded into 4.1 channels.
PRO LOGIC II MOVIE [PLII MV]	5 channel	Performs Dolby Pro Logic II Movie mode decoding. This setting is ideal for movies encoded in Dolby Surround. In addition, this mode can reproduce sound in 5.1 channel for watching videos of overdubbed or old movies.
PRO LOGIC II MUSIC [PLII MS]	5 channel	Performs Dolby Pro Logic II Music mode decoding. This setting is ideal for normal stereo sources such as CDs.
MULTI STEREO [MULTI ST.]	(Multi Stereo)	Outputs 2 channel left/right signals from all speakers. However, sound may not be output from certain speakers depending on the speaker settings.

If you connect a sub woofer

This receiver will generate a low frequency signal for output to the sub woofer when there is no LFE signal, which is a low-pass sound effect output from a sub woofer to a 2 channel signal.

Note

- This function does not work when
- ANALOG DIRECT is selected.
 - signals with a sampling frequency of more than 48 kHz is input.

Selecting a pre-programmed sound field

You can take advantage of surround sound simply by selecting one of the receiver's pre-programmed sound fields. They bring the exciting and powerful sound of movie theaters and concert halls into your home.

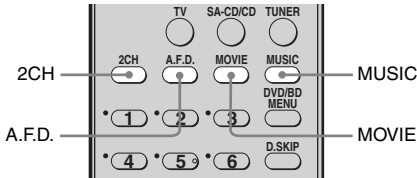

Press MOVIE repeatedly to select a sound field for movies or press MUSIC repeatedly to select a sound field for music.

For details, see “Types of sound field available” (page 43).

Types of sound field available

Sound field for	Sound field [Display]	Effect
Movie	CINEMA STUDIO EX A DCS [C.ST.EX A]	Reproduces the sound characteristics of the Sony Pictures Entertainment "Cary Grant Theater" cinema production studio. This is a standard mode, great for watching almost any type of movie.
	CINEMA STUDIO EX B DCS [C.ST.EX B]	Reproduces the sound characteristics of the Sony Pictures Entertainment "Kim Novak Theater" cinema production studio. This mode is ideal for watching science-fiction or action movies with lots of sound effects.
	CINEMA STUDIO EX C DCS [C.ST.EX C]	Reproduces the sound characteristics of the Sony Pictures Entertainment scoring stage. This mode is ideal for watching musicals or films where orchestra music is featured in the soundtrack.
Music	PORTABLE AUDIO ENHANCER [PORTABLE]	Reproduces a clear enhanced sound image from your portable audio device. This mode is ideal for MP3 and other compressed music.
	HALL [HALL]	Reproduces the acoustics of a classical concert hall.
	JAZZ CLUB [JAZZ]	Reproduces the acoustics of a jazz club.
	LIVE CONCERT [CONCERT]	Reproduces the acoustics of a 300-seat live house.
Headphone*	HEADPHONE 2CH [HP 2CH]	This mode is selected automatically if you use headphones when 2 channel mode (page 44)/A.F.D. mode (page 41) is selected. Standard 2 channel stereo sources completely bypass the sound field processing and multi channel surround formats are downmixed to 2 channels.
	HEADPHONE DIRECT [HP DIR]	Outputs the analog signals without processing by the tone, sound field, etc.
	HEADPHONE THEATER DCS [HP THEA]	This mode is selected automatically if you use headphones when a sound field for movie/music is selected. It allows you to experience a theater-like environment while listening through a pair of headphones.

* You can only select this sound field if the headphones are connected to the receiver.

Notes

- The effects provided by the virtual speakers may cause increased noise in the playback signal.
- When listening with sound fields that employ the virtual speakers, you will not be able to hear any sound coming directly from the surround speakers.
- This function does not work when:
 - ANALOG DIRECT is selected.
 - signals with a sampling frequency of more than 48 kHz is input.
- When one of the sound fields for music is selected, no sound is output from the sub woofer if all the speakers are set to “LARGE” on the SYSTEM menu. However, the sound will be output from the sub woofer if
 - the digital input signal contains LFE signals.
 - the front and surround speakers are set to “SMALL”.
 - the sound field for movie is selected.
 - the portable audio is selected.

Tips

- You can identify the encoding format of DVD software, etc., by looking at the logo on the package.
- Sound fields with **DCS** mark use DCS technology. See “Glossary” (page 55).

To turn off the surround effect for movie/music

Press 2CH to select “2CH ST.” or press A.F.D. repeatedly to select “A.F.D. AUTO”.

Using only the front speakers (2CH STEREO)

In this mode, the receiver outputs the sound from the front left/right speakers only. There is no sound from the sub woofer.

Standard 2 channel stereo sources completely bypass the sound field processing and multi channel surround formats are downmixed to 2 channel.

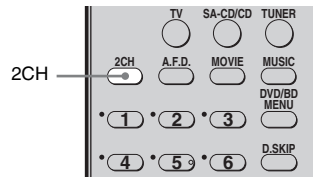

Press 2CH.

Note

No sound is output from the sub woofer in the 2CH STEREO mode. To listen to 2 channel stereo sources using the front left/right speakers and a sub woofer, select “A.F.D. AUTO” (page 41).

Listening to the sound without any adjustment (ANALOG DIRECT)

You can switch the audio of the selected input to two channel analog input. This function enables you to enjoy high quality analog sources.

When using this function, only the volume and front speaker balance can be adjusted.

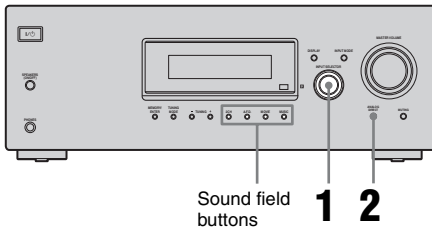

- 1 Turn INPUT SELECTOR on the receiver to select the input you want to listen to in analog audio.**

You can also use the input buttons on the remote.

- 2 Press ANALOG DIRECT on the receiver.**

The analog audio is output.

To cancel ANALOG DIRECT

Press ANALOG DIRECT on the receiver again.

You can also press any sound field buttons.

Note

When headphones are connected, "HP DIR" appears on the display.

Resetting sound fields to the initial settings

Be sure to use the buttons on the receiver for this operation.

1,2

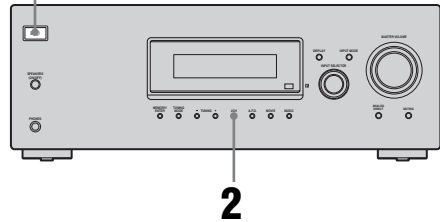

- 1 Press I/⏻ to turn off the power.**
- 2 While holding down 2CH, press I/⏻.**

"S.F. CLR." appears on the display and all sound fields are reset to their initial setting.

Tuner Operations

Listening to FM/AM radio

You can listen to FM and AM broadcasts through the built-in tuner. Before operation, make sure you have connected the FM and AM antennas (aerials) to the receiver (page 24).

Tip

The tuning scale for direct tuning differs depending on the area code as shown in the following table. For details on area codes, see page 3.

Area code	FM	AM
U, CA	100 kHz	10 kHz*

* The AM tuning scale can be changed (page 62).

Automatic tuning

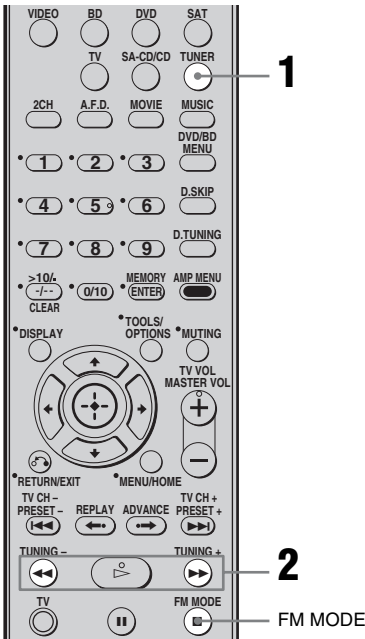

1 Press **TUNER** repeatedly to select the FM or AM band.

2 Press **TUNING +** or **TUNING -**.

Press **TUNING +** to scan from low to high; press **TUNING -** to scan from high to low.

The receiver stops scanning whenever a station is received.

Using the controls on the receiver

1 Turn **INPUT SELECTOR** to select the FM or AM band.

2 Press **TUNING MODE** repeatedly to select “AUTO T”.

3 Press **TUNING +** or **TUNING -**.

In case of poor FM stereo reception

If the FM stereo reception is poor and “ST” flashes on the display, select monaural audio so that the sound will be less distorted. Press **FM MODE** repeatedly until the “MONO” indicator lights up on the display. To return to stereo mode, press **FM MODE** repeatedly until the “MONO” indicator on the display does not light up.

Direct tuning

Enter the frequency of a station directly by using the numeric buttons.

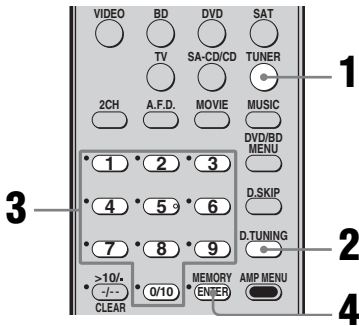

1 Press **TUNER** repeatedly to select the FM or AM band. You can also use **INPUT SELECTOR** on the receiver.

2 Press **D.TUNING**.

3 Press the numeric buttons to enter the frequency.

Example 1: FM 102.50 MHz

Select 1 → 0 → 2 → 5 → 0

Example 2: AM 1,350 kHz

Select 1 → 3 → 5 → 0

If you have tuned in an AM station, adjust the direction of the AM loop antenna (aerial) for optimum reception.

4 Press **ENTER**.

You can also use **MEMORY/ENTER** on the receiver.

If you cannot tune in a station

Make sure you have entered the right frequency. If not, repeat steps 2 to 4. If you still cannot tune in a station, the frequency is not used in your area.

Presetting radio stations

You can preset up to 30 FM stations and 30 AM stations. Then you can easily tune in the stations you often listen to.

Presetting radio stations

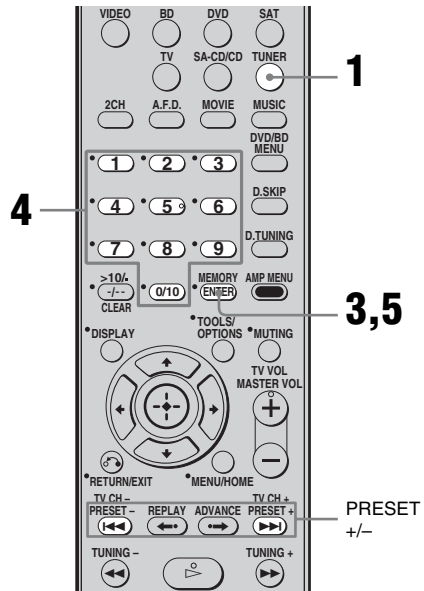

1 Press **TUNER** repeatedly to select the FM or AM band.

You can also use **INPUT SELECTOR** on the receiver.

2 Tune in the station that you want to preset using **Automatic Tuning** (page 46) or **Direct Tuning** (page 47).

Switch the FM reception mode, if necessary (page 46).

3 Press MEMORY.

You can also use MEMORY/ENTER on the receiver.

“MEMORY” lights up for a few seconds.

Perform steps 4 and 5 before

“MEMORY” goes out.

4 Press the numeric buttons to select a preset number.

You can also press PRESET + or PRESET – repeatedly to select a preset number.

If “MEMORY” goes out before you select the preset number, start again from step 3.

5 Press ENTER.

You can also use MEMORY/ENTER on the receiver.

The station is stored as the selected preset number.

If “MEMORY” goes out before you press ENTER, start again from step 3.

6 Repeat steps 1 to 5 to preset another station.

Tuning to preset stations

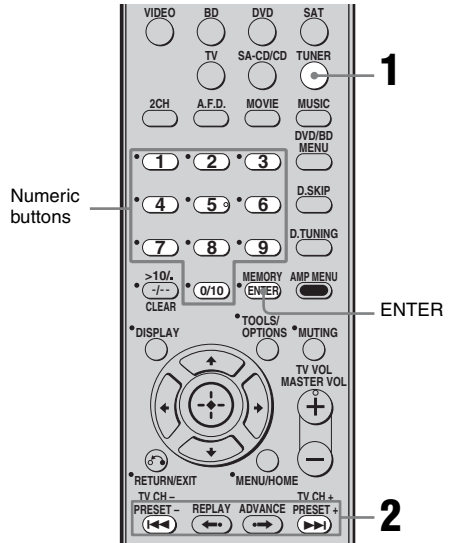

1 Press TUNER repeatedly to select the FM or AM band.

2 Press PRESET + or PRESET – repeatedly to select the preset station you want.

Each time you press the button, you can select a preset station as follows:

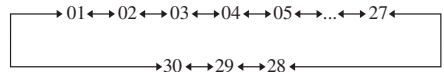

You can also press the numeric buttons to select the preset station you want. Then, press ENTER to enter the selection.

Using the controls on the receiver

- 1 Turn INPUT SELECTOR to select the FM or AM band.
- 2 Press TUNING MODE repeatedly to select “PRESET T.”.
- 3 Press TUNING + or TUNING – repeatedly to select the preset station you want.

Naming preset stations

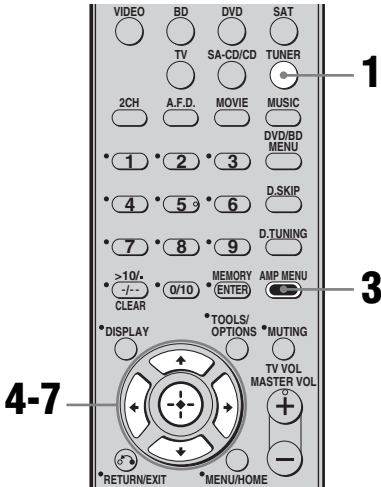

To create an index name

- 1 Use $\uparrow/\downarrow/\leftarrow/\rightarrow$ to create an index name.
Press \uparrow/\downarrow to select a character, then press \leftarrow/\rightarrow to move the cursor to the next position.

If you made a mistake

Press \leftarrow/\rightarrow until the character you want to change flashes, then press \uparrow/\downarrow to select the correct character.

Tips

- You can select the character type as follows by pressing \uparrow/\downarrow .
Alphabet (upper case) \rightarrow Numbers \rightarrow Symbols
- To enter a blank space, press \rightarrow without selecting a character.

- 2 Press \oplus .
The entered name is registered.

- 1 Press TUNER repeatedly to select the FM or AM band.

You can also use INPUT SELECTOR on the receiver.

- 2 Tune in the preset station you want to create an index name for (page 48).

- 3 Press AMP MENU.

“1-LEVEL” appears on the display.

- 4 Press \uparrow/\downarrow repeatedly to select “4-TUNER”.

- 5 Press \oplus or \rightarrow to enter the menu.

- 6 Press \uparrow/\downarrow repeatedly to select “NAME IN”.

- 7 Press \oplus or \rightarrow to enter the parameter.

The cursor flashes and you can select a character. Follow the procedure given in “To create an index name” below.

Switching between digital and analog audio (INPUT MODE)

When you connect components to both digital and analog audio input jacks (SAT) on the receiver, you can fix the audio input mode.

1 Turn INPUT SELECTOR on the receiver to select the input.

You can also use the input buttons on the remote.

2 Press INPUT MODE repeatedly on the receiver to select the audio input mode.

The selected audio input mode appears on the display.

Audio input modes

- **AUTO**
Gives priority to digital audio signals when there are both digital and analog connections. If there are no digital audio signals, analog audio signals are selected.
- **ANALOG**
Specifies the analog audio signals input to the AUDIO IN (L/R) jacks.

Notes

- Some audio input modes may not be set up depending on the input.
- When the ANALOG DIRECT function is being used, the audio input mode is set to “ANALOG” automatically. You cannot select other modes.

Enjoying the DIGITAL MEDIA PORT (DMPORT)

The DIGITAL MEDIA PORT (DMPORT) allows you to enjoy sound from a network system such as a portable audio source or computer.

By connecting a DIGITAL MEDIA PORT adapter (not supplied), you can enjoy sound from the connected component on the receiver.

For details, refer to the operating instructions supplied with the DIGITAL MEDIA PORT adapter.

Notes

- Do not connect an adapter other than the DIGITAL MEDIA PORT adapter.
- Before connecting cords, make sure to disconnect the AC power cord (mains lead).
- Do not connect or disconnect the DIGITAL MEDIA PORT adapter while the receiver is turned on.
- Depending on the DIGITAL MEDIA PORT adapter, video output may not be possible.
- The DIGITAL MEDIA PORT adapters are available for purchase depending on the area.

Connecting the DIGITAL MEDIA PORT adapter

You can listen to the sound from the component connected through the DIGITAL MEDIA PORT adapter to the DMPORT jack on the receiver.

You can also view the images on the TV screen by connecting the video output of the DIGITAL MEDIA PORT adapter to the video input of the TV.

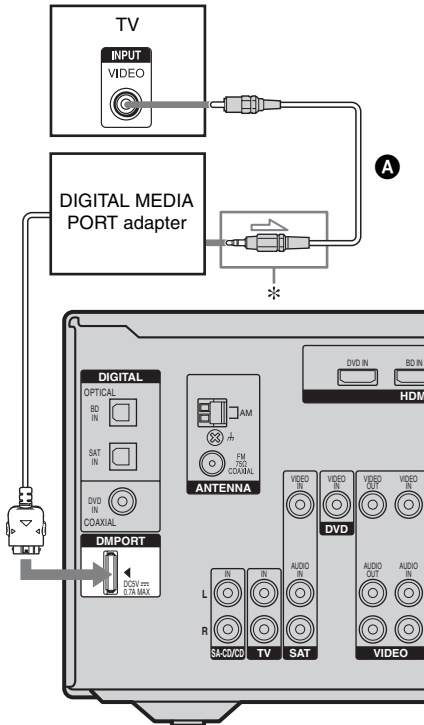

* The type of connector varies depending on the DIGITAL MEDIA PORT adapter. For details, refer to the operating instructions supplied with the DIGITAL MEDIA PORT adapter.

A Video cord (not supplied)

To detach the DIGITAL MEDIA PORT adapter from DMPORT jack

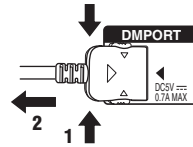

Press and hold both sides of the connector and then pull out the connector.

Notes

- When connecting the DIGITAL MEDIA PORT adapter, be sure the connector is inserted with the arrow mark facing towards the arrow mark on the DMPORT jack.
- Be sure to make DMPORT connections firmly, insert the connector straight in.
- As the connector of the DIGITAL MEDIA PORT adapter is fragile, be sure to handle with care when placing or moving the receiver.

Listening/Watching to a connected component through DMPORT connection

1 Press DMPORT.

You can also use the INPUT SELECTOR on the receiver to select “DMPORT”.

2 Start playback of the connected component.

The sound is played back on the receiver and the image appears on the TV.

For details, refer to the operating instructions supplied with the DIGITAL MEDIA PORT adapter.

Notes

- Depending on the type of DIGITAL MEDIA PORT adapter, you can operate the connected component by using the remote. For details on the remote button operation, see page 10.
- Be sure you have made the video connection from DIGITAL MEDIA PORT adapter to the TV (page 51).
- Depending on the DIGITAL MEDIA PORT adapter, video output may not be possible.

Tip

When listening to MP3 or other compressed music using a portable audio source, you can enhance the sound. Press MUSIC repeatedly to select “PORTABLE” (page 42).

Naming inputs

You can enter a name of up to 8 characters for inputs and display it on the receiver’s display. This is convenient for labeling the jacks with the names of the connected components.

1 Press the input button to select the input you want to create an index name for.

You can also use INPUT SELECTOR on the receiver.

2 Press AMP MENU.

“1-LEVEL” appears on the display.

3 Press \uparrow/\downarrow repeatedly to select “5-AUDIO”.

4 Press \oplus or \rightarrow to enter the menu.

5 Press \uparrow/\downarrow to select “NAME IN”.

6 Press \oplus or \rightarrow to enter the parameter.

The cursor flashes and you can select a character. Follow the procedure given in “To create an index name” (page 49).

Changing the display

You can check the sound field, etc., by changing the information on the display. Be sure to use the buttons on the receiver for this operation.

Press DISPLAY repeatedly.

Each time you press the button, the display changes cyclically as follows.

All inputs except the FM and AM band

Index name of the input* → Selected input → Sound field currently applied

FM and AM band

Preset station name* → Frequency → Sound field currently applied

* Index name appears only when you have assigned one to the input or preset station (page 49, 52).
Index name does not appear when only blank spaces have been entered, or it is the same as the input name.

Note

Character or marks may not be displayed for some languages.

Using the Sleep Timer

You can set the receiver to turn off automatically at a specified time.

Press SLEEP repeatedly while the power is on.

Each time you press the button, the display changes cyclically as follows:

2-00-00 → 1-30-00 → 1-00-00 → 0-30-00
→ OFF

When sleep timer is activated, the display dims.

Note

If you press any buttons on the remote or receiver after the display dims, the display brightens up. After a while, the display dims again if no button is pressed.

Tip

To check the remaining time before the receiver turns off, press SLEEP. The remaining time appears on the display. If you press SLEEP again, the sleep timer will be canceled.

Recording using the receiver

Recording onto a recording media

You can record from a video component using the receiver. See the operating instructions supplied with your recording component.

1 Press one of the input buttons to select the playback component.

You can also use INPUT SELECTOR on the receiver.

2 Prepare the playback component for playing.

For example, insert the video tape you want to copy into the VCR.

3 Prepare the recording component.

Insert a blank video tape, etc. into the recording component (VIDEO) for recording.

4 Start recording on the recording component, then start playback on the playback component.

Note

Some sources contain copy guards to prevent recording. In this case, you may not be able to record from the source.

Using the Remote

Changing button assignments

You can change the factory settings of the input buttons to suit the components in your system. For example, if you connect a DVD recorder to the VIDEO jacks on the receiver, you can set the VIDEO button on this remote to control the DVD recorder.

1 Hold down the input button of which you want to change the assignment.

Example: Hold down VIDEO.

2 Referring to the table below, press the corresponding button for the category you want.

Example: Press 4.

Now you can use the VIDEO button to control the DVD recorder.

Categories and the corresponding buttons

Categories	Press
VCR (command mode VTR 3) ^{a)}	1
VCR (command mode VTR 2) ^{a)}	2
DVD player/DVD recorder (command mode DVD1) ^{b)}	3
DVD recorder (command mode DVD3) ^{b)}	4
CD player	5
Euro Digital Satellite Receiver	6
DVR (Digital CATV terminal)	7
DSS (Digital Satellite Receiver)	8
Blu-ray disc player (command mode BD1) ^{c)}	9
Blu-ray disc recorder (command mode BD3) ^{c)}	0/10
TV	-/--
Not assigned	ENTER/ MEMORY

^{a)} Sony VCRs are operated with a VTR 2 or VTR 3 setting which corresponds to 8 mm and VHS respectively.

^{b)} Sony DVD recorders are operated with a DVD1 or DVD3 setting. For details, refer to the operating instructions supplied with the DVD recorders.

^{c)} For details on the BD1 or BD3 setting, refer to the operating instructions supplied with the Blu-ray disc player or Blu-ray disc recorder.

To clear all remote button assignments

Press I/⏻, DMPORT and MASTER VOL – at the same time.

The remote is reset to its factory settings.

Additional Information

Glossary

■ Cinema Studio EX

A surround sound mode that can be regarded as the compilation of Digital Cinema Sound technology, delivers the sound of a dubbing theater using three technologies: “Virtual Multi Dimensions”, “Screen Depth Matching”, and “Cinema Studio Reverberation”.

“Virtual Multi Dimensions”, the virtual speaker technology, creates a virtual multi-surround environment with actual speakers up to 7.1 channels, and brings the surround sound experience of a theater with the latest facilities into your home.

“Screen Depth Matching” reproduces treble attenuation, fullness, and depth of sound usually created in a theater using sound emission from behind the screen. This is then added to the front and center channels.

“Cinema Studio Reverberation” reproduces the sound characteristics of state-of-the-art dubbing theaters and recording studios, including Sony Pictures Entertainment’s dubbing studios. There are three modes, A/B/C, available according to the studio type.

■ Component video

A format for transmitting video signal information consisting of three separate signals: luminance Y, chrominance Pb, and chrominance Pr. High quality pictures, such as DVD video or HDTV pictures, are transmitted more faithfully. The three jacks are color-coded green, blue and red.

■ Composite video

A standard format for transmitting video signal information. The luminance signal Y and chrominance signal C are combined and transmitted together.

■ Digital Cinema Sound (DCS)

A unique sound reproduction technology for home theater developed by Sony, in cooperation with Sony Pictures Entertainment, for enjoying the exciting and powerful sound of movie theaters at home. With this “Digital Cinema Sound” developed by integrating a DSP (Digital Signal Processor) and measured data, the ideal sound field intended by filmmakers can be experienced at home.

■ Dolby Digital

Digital audio encoding/decoding technology developed by Dolby Laboratories, Inc. It consists of front (left/right), center, surround (left/right) and sub woofer channels. It is a designated audio standard for DVD-video and also known as 5.1 channel surround. Since surround information is recorded and reproduced in stereo, more realistic sound with fuller presence is delivered than with Dolby surround.

■ Dolby Pro Logic II

This technology converts 2 channel stereo recorded audio into 5.1 channel for playback. There is a MOVIE mode for movies and MUSIC mode for stereo sources such as music. Old movies encoded in the traditional stereo format can be enhanced with 5.1 channel surround sound.

■ Dolby Surround (Dolby Pro Logic)

Audio processing technology developed by Dolby Laboratories, Inc. Center and mono surround information is matrixed into two stereo channels. When reproduced, audio is decoded and output in 4 channel surround sound. This is the most common audio processing method for DVD-video.

■ DTS Digital Surround

Digital audio encoding/decoding technology for theaters developed by DTS, Inc. It compresses audio less than Dolby Digital, delivering a higher quality sound reproduction.

■ HDMI (High-Definition Multimedia Interface)

HDMI (High-Definition Multimedia Interface) is an interface that supports both video and audio on a single digital connection, allowing you to enjoy high quality digital picture and sound. The HDMI specification supports HDCP (High-bandwidth Digital Contents Protection), a copy protection technology that incorporates coding technology for digital video signals.

■ L.F.E. (Low Frequency Effects)

Sound effects of low frequencies which are output from a sub woofer in Dolby Digital or DTS, etc. By adding a deep bass with a frequency between 20 to 120 Hz, audio becomes more powerful.

■ Sampling frequency

To convert analog audio to digital, analog data should be quantified. This process is called sampling, and the number of times per second the analog data is quantified is called the sampling frequency. A standard music CD stores data quantified at 44,100 times per second, which is expressed as a sampling frequency of 44.1 kHz. Generally speaking, a higher sampling frequency means better sound quality.

Precautions

On safety

Should any solid object or liquid fall into the cabinet, unplug the receiver and have it checked by qualified personnel before operating it any further.

On power sources

- Before operating the receiver, check that the operating voltage is identical with your local power supply.
The operating voltage is indicated on the nameplate on the back of the receiver.
- The unit is not disconnected from the AC power source (mains) as long as it is connected to the wall outlet, even if the unit itself has been turned off.
- If you are not going to use the receiver for a long time, be sure to disconnect the receiver from the wall outlet. To disconnect the AC power cord (mains lead), grasp the plug itself; never pull the cord.
- One blade of the plug is wider than the other for the purpose of safety and will fit into the wall outlet only one way. If you are unable to insert the plug fully into the outlet, contact your dealer.
- The AC power cord (mains lead) must be changed only at a qualified service shop.

On heat buildup

Although the receiver heats up during operation, this is not a malfunction. If you continuously use this receiver at a large volume, the cabinet temperature of the top, side and bottom rises considerably. To avoid burning yourself, do not touch the cabinet.

On placement

- Place the receiver in a location with adequate ventilation to prevent heat buildup and prolong the life of the receiver.
- Do not place the receiver near heat sources, or in a place subject to direct sunlight, excessive dust, or mechanical shock.
- Do not place anything on top of the cabinet that might block the ventilation holes and cause malfunctions.
- Do not place the receiver near equipment such as a television, VCR, or tape deck. If the receiver is being used in combination with a television, VCR, or tape deck, and is placed too close to that equipment, noise may result, and picture quality may suffer. This is especially likely when using an indoor antenna (aerial). Therefore, we recommend using an outdoor antenna (aerial).
- Use caution when placing the receiver on surfaces that have been specially treated (with wax, oil, polish, etc.) as staining or discoloration of the surface may result.

On operation

Before connecting other components, be sure to turn off and unplug the receiver.

On cleaning

Clean the cabinet, panel, and controls with a soft cloth slightly moistened with a mild detergent solution. Do not use any type of abrasive pad, scouring powder, or solvent, such as alcohol or benzine.

If you have any questions or problems concerning your receiver, please consult your nearest Sony dealer.

Troubleshooting

If you experience any of the following difficulties while using the receiver, use this troubleshooting guide to help you remedy the problem.

Audio

There is no sound, no matter which component is selected, or only a very low-level sound is heard.

- Check that the speakers and components are connected correctly and securely.
- Check that both the receiver and all components are turned on.
- Check that MASTER VOLUME is not set to “VOL MIN”.
- Check that the SPEAKERS (ON/OFF) is not set to “SPK OFF”.
- Check that headphones are not connected.
- Press MUTING to cancel the muting function.
- Check that you have selected the correct component with the input buttons.
- The protective device on the receiver has been activated. Turn off the receiver, eliminate the short-circuit problem, and turn on the power again.

There is no sound from a specific component.

- Check that the component is connected correctly to the audio input jacks for that component.
- Check that the cord(s) used for the connection is (are) fully inserted into the jacks on both the receiver and the component.

There is no sound from one of the front speakers.

- Connect a pair of headphones to the PHONES jack to verify that sound is output from the headphones. If only one channel is output from the headphones, the component may not be connected to the receiver correctly. Check that all the cords are fully inserted into the jacks on both the receiver and the component. If both channels are output from the headphones, the front speaker may not be connected to the receiver correctly. Check the connection of the front speaker which is not outputting any sound.
- Make sure you have connected to both the L and R jacks of an analog component, and not only to either the L or R jack. Use an audio cord (not supplied).

There is no sound from digital sources (from OPTICAL input jack) when selecting SAT input.

- Check that the INPUT MODE is not set to “ANALOG” (page 50).
- Check that ANALOG DIRECT is not set to on.

The left and right sounds are unbalanced or reversed.

- Check that the speakers and components are connected correctly and securely.
- Adjust the balance parameters using the LEVEL menu.

“UNLOCK” appears on the display.

- Check that your component is connected to the COAXIAL or OPTICAL jack. If no signal is input through the COAXIAL or OPTICAL jack, “UNLOCK” appears on the display and this is not a malfunction.
-

There is severe hum or noise.

- Check that the speakers and components are connected securely.
- Check that the connecting cords are away from a transformer or motor, and at least 10 feet away from a TV set or fluorescent light.
- Move your audio components away from the TV.
- The plugs and jacks are dirty. Wipe them with a cloth slightly moistened with alcohol.

There is no sound, or only a very low-level sound is heard from the center/surround speakers.

- Select a CINEMA STUDIO EX mode (page 43).
- Adjust the speaker level (page 26).
- Make sure the center/surround speakers are set to either “SMALL” or “LARGE” (page 33).

There is no sound from the sub woofer.

- Check that the sub woofer is connected correctly and securely.
- Make sure you have turned on your sub woofer.
- Make sure the sub woofer is set to “YES” (page 33).
- There is no sound from the sub woofer depending on the sound field.

There is no sound from the component connected to the DIGITAL MEDIA PORT adapter.

- Adjust the volume of this receiver.
- The DIGITAL MEDIA PORT adapter and/or component is not connected correctly. Turn off the receiver, then reconnect the DIGITAL MEDIA PORT adapter and/or component.
- Check the DIGITAL MEDIA PORT adapter and/or component device to make sure it supports this receiver.

There is no sound from the speakers of the receiver when you connect the receiver and the playback component via a HDMI connection.

- Make sure that you have connected the digital audio jacks on the playback component to the receiver. Then, turn off TV’s volume or activate the TV’s muting function.

The surround effect cannot be obtained.

- Make sure the sound field function is on (press MOVIE, or MUSIC).
- Sound fields do not function for signals with a sampling frequency of more than 48 kHz.

Dolby Digital or DTS multi channel sound is not reproduced.

- Check that the DVD, etc. you are playing is recorded in Dolby Digital or DTS format.
- When connecting the DVD player, etc., to the digital input jacks of this receiver, check the audio setting (the settings for the audio output) of the connected component.

Video

There is no picture or an unclear picture appears on the TV screen.

- Select the appropriate input using the input buttons.
- Set your TV to the appropriate input mode.
- Move your audio components away from the TV.

The source image input to the HDMI jack on the receiver is not output from the TV.

- Check the HDMI connection.
- Depending on the playback component, you may need to set up the component. Refer to the operating instructions supplied with each component.

Recording cannot be carried out.

- Check that the components are connected correctly.
 - Select the source component using the input buttons.
-

Tuner

The FM reception is poor.

- Use a 75-ohm coaxial cable (not supplied) to connect the receiver to an outdoor FM antenna (aerial) as shown below. If you connect the receiver to an outdoor antenna (aerial), ground it against lightning. To prevent a gas explosion, do not connect the ground wire to a gas pipe.

Outdoor FM antenna (aerial)

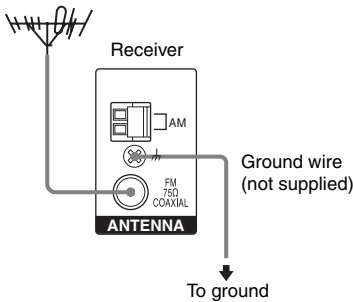

Radio stations cannot be tuned in.

- Check that the antennas (aerials) are connected securely. Adjust the antennas (aerials) and connect an external antenna (aerial), if necessary.
 - The signal strength of the stations is too weak (when tuning in with automatic tuning). Use direct tuning.
 - Make sure you set the tuning interval correctly (when tuning in AM stations with direct tuning).
 - No stations have been preset or the preset stations have been cleared (when tuning by scanning preset stations). Preset the stations (page 47).
 - Press DISPLAY repeatedly on the receiver so that the frequency appears on the display.
-

Remote commander

The remote does not function.

- Point the remote at the remote sensor on the receiver.
 - Remove any obstacles in the path between the remote and the receiver.
 - Replace all the batteries in the remote with new ones, if they are weak.
 - Make sure you select the correct input on the remote.
-

Error messages

If there is a malfunction, the display shows a message. You can check the condition of the system by the message. Refer to the following table to solve the problem. If any problem persists, consult your nearest Sony dealer.

PROTECT

Irregular current is output to the speakers. The receiver will automatically turn off after a few seconds. Check the speaker connection and turn on the power again.

If you are unable to remedy the problem using the troubleshooting guide

Clearing the receiver's memory may remedy the problem (page 25). However, note that all memorized settings will be reset to their factory settings and you will have to readjust all settings on the receiver.

If the problem persist

Consult your nearest Sony dealer. Note that if service personnel changes some parts during repair, these parts may be retained.

Reference sections for clearing the receiver's memory

To clear	See
All memorized settings	page 25
Customized sound fields	page 45

Specifications

AUDIO POWER SPECIFICATIONS

POWER OUTPUT AND TOTAL HARMONIC DISTORTION: (Models of area code U only)

With 8 ohm loads, both channels driven, from 20 – 20,000 Hz; rated 90 watts per channel minimum RMS power, with no more than 0.09% total harmonic distortion from 250 milliwatts to rated output.

Amplifier section

Models of area code U, CA¹⁾

Minimum RMS Output Power (8 ohms, 20 Hz – 20 kHz, THD 0.09%)

90 W + 90 W

Stereo Mode Output Power (8 ohms, 1 kHz, THD 1%)

100 W + 100 W

Surround Mode Output Power²⁾ (8 ohms, 1 kHz, THD 10%)

130 W/ch

¹⁾Measured under the following conditions:

Area code	Power requirements
U, CA	120 V AC, 60 Hz

²⁾Reference power output for front, center and surround speakers. Depending on the sound field settings and the source, there may be no sound output.

Frequency response

Analog 10 Hz – 70 kHz
+0.5/-2 dB (with sound field and tone bypassed)

Inputs

Analog	Sensitivity: 500 mV/ 50 kohms S/N ³⁾ : 96 dB (A, 500 mV ⁴⁾)
Digital (Coaxial)	Impedance: 75 ohms S/N: 100 dB (A, 20 kHz LPF)
Digital (Optical)	S/N: 100 dB (A, 20 kHz LPF)

Outputs (Analog)

AUDIO OUT	Voltage: 500 mV/10 kohms
SUB WOOFER	Voltage: 2 V/1 kohm

Tone

Gain levels	±6 dB, 1 dB step
-------------	------------------

³⁾INPUT SHORT (with sound field and tone bypassed).

⁴⁾Weighted network, input level.

FM tuner section

Tuning range	87.5 - 108.0 MHz
Antenna	FM wire antenna
Antenna terminals	75 ohms, unbalanced
Intermediate frequency	10.7 MHz

AM tuner section

Tuning range

Area code	Tuning scale	
	10 kHz step	9 kHz step
U, CA	530 – 1,710 kHz ⁵⁾	531 – 1,710 kHz ⁵⁾

Antenna	Loop antenna
Intermediate frequency	450 kHz

⁵⁾You can change the AM tuning scale to 9 kHz or 10 kHz. After tuning in any AM station, turn off the receiver. While holding down TUNING MODE, press I/⏪. All preset stations will be erased when you change the tuning scale. To reset the scale to 10 kHz (or 9 kHz), repeat the procedure.

Video section

Inputs/Outputs

Video:	1 V _{p-p} /75 ohms
COMPONENT VIDEO:	
Y:	1 V _{p-p} /75 ohms
PB/CB:	0.7 V _{p-p} /75 ohms
PR/CR:	0.7 V _{p-p} /75 ohms
	80 MHz HD Pass Through

General

Power requirements

Area code	Power requirements
U, CA	120 V AC, 60 Hz

Power output (DIGITAL MEDIA PORT)

DC OUT:	5 V, 0.7 A MAX
---------	----------------

Power consumption

Area code	Power consumption
U	220 W
CA	300 VA

Power consumption (during standby mode)
0.3 W

Dimensions (w/h/d) (Approx.)

430 × 157.5 × 318 mm
(16 7/8 × 6 2/8 × 12 5/8
inches) including
projecting parts and
controls

Mass (Approx.) 7.7 kg (16 lb 16 oz)

Supplied accessories

- Operating Instruction (this manual)
- Quick Setup Guide (1)
- FM wire antenna (aerial) (1)
- AM loop antenna (aerial) (1)
- Remote commander (RM-AAU020) (1)
- R6 (size-AA) batteries (2)

For details on the area code of the component you are using, see page 3.

Design and specifications are subject to change without notice.

Index

Numerics

- 2 channel 44
- 2CH STEREO 44
- 5.1 channel 13

A

- AUTO FORMAT DIRECT
(A.F.D.) 40

B

- Blu-ray disc player
 - connecting 17
 - playback 30

C

- CD player
 - connecting 15
 - playback 29

D

- Digital Cinema Sound
(DCS) 43
- DIGITAL MEDIA PORT
 - connecting 51
 - input 28
- Dolby Digital 56
- DTS 56
- DVD player
 - connecting 20
 - playback 30
- DVD recorder
 - connecting 20

E

- Error messages 61

H

- HDMI
 - connecting 17

I

- Initial setup 25
- INPUT MODE 50

M

- Menu
 - AUDIO 36
 - LEVEL 34
 - SUR 35
 - SYSTEM 37
 - TONE 35
 - TUNER 36
- Muting 28

N

- Naming 49, 52

R

- Recording onto a recording
media 54

S

- Satellite tuner
 - connecting 22
- Selecting
 - component 28
 - sound field 42
- Set-top box
 - connecting 22
- Sleep Timer 53
- Sound fields
 - resetting 45
 - selecting 42
- Speakers
 - connecting 14
- Super Audio CD player
 - connecting 15
 - playback 29

T

- TEST TONE 26
- Tuner
 - connecting 24
- Tuning
 - automatically 46
 - directly 47
 - to preset stations 48
- TV
 - connecting 19

V

- VCR
 - connecting 23



* 3 2 8 4 0 8 3 1 2 * (1)