

WF-C5710/WF-C5790 User's Guide

Contents

WF-C5710/WF-C5790 User's Guide	15
Product Basics	16
Using the Control Panel	16
Control Panel Buttons and Lights	17
Status Icon Information	18
Changing LCD Screen Language.....	19
Selecting the Date and Time	19
Selecting Your Country or Region	21
Setting a Password and Locking the Control Panel	21
Entering Characters on the LCD Screen.....	23
Using Presets.....	23
Setting User Feature Restrictions (Access Control)	26
Adjusting Control Panel Sounds	27
Adjusting the Screen Brightness.....	28
Turning Off the Operation Time Out Setting	28
Preventing PC Connection via USB	29
Product Parts Locations	30
Product Parts - Front	31
Product Parts - Inside	33
Product Parts - Back.....	35
Using Power Saving Settings	36
Changing the Sleep Timer Settings	36
Changing the Power Off Timer Settings	37
Epson Connect Solutions for Smartphones, Tablets, and More	37
Setting Up Epson Connect Services.....	38
Using Epson Email Print	40
Using the Epson iPrint Mobile App	40
Using Epson Remote Print	41
Using Epson Scan to Cloud.....	41
Using AirPrint	42

Using Google Cloud Print	43
Setting Up Google Cloud Print on a Chromebook	44
Android Printing Using the Epson Print Enabler	45
Using Fire OS Printing	45
Using Windows 10 Mobile Printing	46
Using Epson Print and Scan App with Windows Tablets	46
Printing and Scanning with NFC from Your Android Device	47
Wi-Fi or Wired Networking.....	49
Network Security Recommendations	49
Wi-Fi Infrastructure Mode Setup.....	50
Selecting Wireless Network Settings from the Control Panel	51
Wi-Fi Direct Mode Setup	53
Enabling Wi-Fi Direct Mode	54
Wi-Fi Protected Setup (WPS).....	55
Using WPS to Connect to a Network	56
Printing a Network Status Sheet.....	57
Configuring Email Server Settings.....	57
Changing or Updating Network Connections	59
Accessing the Web Config Utility	59
Changing a USB Connection to a Wi-Fi Connection.....	60
Changing a Wi-Fi Connection to a Wired Network Connection.....	60
Connecting to a New Wi-Fi Router	61
Disabling Wi-Fi Features	61
Enabling Epson Universal Print Driver (PCL) or PostScript Printing.....	63
Installing the Epson Universal Print Driver - Windows	63
Installing the PostScript (PS3) Printer Software - Windows	67
Installing the PostScript (PS3) Printer Software - Mac	67
Selecting PDL (Page Description Language) Settings	68
PDL Print Configuration Options.....	70
Selecting Printer Language and Interface Settings	72
Printing Language and Interface Options	74
Printing a PCL or PS3 (PostScript) Status Sheet	74

Loading Paper	76
Installing the Optional Paper Cassette Unit.....	76
Enabling the Optional Paper Cassette - Windows	78
Enabling the Optional Paper Cassette - Mac	80
Loading Paper in the Cassette	81
Loading Paper or Envelopes in the Rear Paper Feed Slot	84
Paper Loading Capacity	87
Double-sided Printing Capacity	90
Compatible Epson Papers.....	91
Paper or Media Type Settings - Printing Software.....	93
Selecting the Paper Settings for Each Source - Control Panel	94
Paper Type Settings - Control Panel	95
Selecting Default Paper Settings - Administrator.....	96
Selecting the Default Printer Settings	96
Paper Source Settings Options.....	98
Selecting the Universal Print Settings.....	99
Universal Print Settings Options	99
Placing Originals on the Product	101
Placing Originals on the Scanner Glass	101
Placing Originals in the Automatic Document Feeder	102
Copying.....	107
Copying Documents or Photos.....	107
Copying Options.....	108
Printing from a Computer	112
Printing with the Standard Epson Printer Software - Windows	112
Selecting Basic Print Settings - Windows	113
Paper Source Options - Windows	115
Print Quality Options - Windows	115
Multi-Page Printing Options - Windows.....	115
Selecting Double-sided Printing Settings - Windows	116
Double-sided Printing Options - Windows.....	118
Print Density Adjustments - Windows	119
Selecting Additional Layout and Print Options - Windows	120

Custom Color Correction Options - Windows.....	122
Image Options and Additional Settings - Windows.....	123
Header/Footer Settings - Windows	124
Selecting a Printing Preset - Windows.....	125
Selecting Extended Settings - Windows	127
Extended Settings - Windows	128
Printing Your Document or Photo - Windows.....	129
Locking Printer Settings - Windows	130
Locked Setting Options.....	132
Entering a User ID and Password for Printing	133
Selecting Default Print Settings - Windows.....	134
Changing the Language of the Printer Software Screens	135
Changing Automatic Update Options	136
Printing with the Built-in Epson Driver - Windows 10 S.....	137
Selecting Print Settings - Windows 10 S.....	137
Printing with the Epson Standard Printer Software - Mac.....	141
Selecting Basic Print Settings - Mac	142
Paper Source Options - Mac.....	145
Print Quality Options - Mac	145
Print Options - Mac	146
Selecting Page Setup Settings - Mac	146
Selecting Print Layout Options - Mac.....	147
Selecting Double-sided Printing Settings - Mac.....	148
Double-sided Printing Options and Adjustments - Mac.....	149
Managing Color - Mac	150
Color Matching and Color Options - Mac	151
Selecting Printing Preferences - Mac	152
Printing Preferences - Mac.....	153
Printing Your Document or Photo - Mac	154
Checking Print Status - Mac.....	155
Printing with the Epson Universal Print Driver - Windows.....	155
Synchronizing Printer Settings - Epson Universal Print Driver - Windows	156
Selecting Basic Print Settings - Epson Universal Print Driver - Windows	157

Selecting Additional Layout and Print Options - Epson Universal Print Driver - Windows	160
Selecting Maintenance Options - Epson Universal Print Driver - Windows.....	162
Extended Settings - Epson Universal Print Driver - Windows	163
Selecting Default Print Settings - Epson Universal Print Driver - Windows.....	164
Locking Printer Settings - Epson Universal Print Driver - Windows	166
Epson Universal Print Driver Locked Setting Options	167
Adding Network Printers - Epson Universal Print Driver - Windows.....	168
Printing with the PostScript (PS3) Printer Software - Windows	170
Enabling the Optional Paper Cassettes - PostScript Printer Software - Windows	170
Selecting Basic Print Settings - PostScript Printer Software - Windows	171
Selecting Additional Layout and Print Options - PostScript Printer Software - Windows	175
Selecting Default Print Settings - PostScript Printer Software - Windows.....	176
Printing with the PostScript (PS3) Printer Software - Mac	177
Enabling the Optional Paper Cassettes - PostScript Printer Software - Mac	178
Selecting Basic Print Settings - PostScript Printer Software - Mac	179
Selecting Page Setup Settings - PostScript Printer Software - Mac	184
Selecting Print Layout Options - PostScript Printer Software - Mac.....	185
Sizing Printed Images - PostScript Printer Software - Mac	186
Managing Color - PostScript Printer Software - Mac	186
Printing Your Document or Photo - PostScript Printer Software - Mac	187
Checking Print Status - PostScript Printer Software - Mac	188
Cancelling Printing Using a Product Button.....	188
Scanning	190
Starting a Scan.....	190
Starting a Scan Using the Product Control Panel	190
Scanning to a Network Folder or FTP Server.....	192
Scanning to Email	194
Adding and Assigning Scan Jobs with Document Capture Pro - Windows	196
Adding and Assigning Scan Jobs with Document Capture - Mac.....	199
Scanning to a Memory Device	199
Scanning to the Cloud.....	201
Scanning Using Web Services for Devices (WSD) - Windows.....	202
Control Panel Scanning Options.....	203

Starting a Scan Using the Epson Scan 2 Icon	205
Starting a Scan from a Scanning Program.....	207
Starting a Scan from a Smart Device.....	208
Entering a User ID and Password for Scanning.....	209
Scanning with Document Capture or Document Capture Pro	210
Setting the Operation Mode on the Product Control Panel	211
Scanning with Document Capture Pro in Simple View - Windows	211
Scanning with Document Capture Pro in Standard View - Windows	214
Scanning with Document Capture - Mac	217
Scanning in Epson Scan 2	220
Available Document Source Settings	223
Additional Scanning Settings - Main Settings Tab	223
Additional Scanning Settings - Advanced Settings Tab	224
Saving Scanned Documents as a Searchable PDF Using Epson Scan 2	225
Image Format Options	226
Scan Resolution Guidelines	227
Scanning Special Projects.....	228
Scanning to a SharePoint Server or Cloud Service - Windows.....	228
Scanning to a SharePoint Server or Cloud Service - Mac	231
Scanning Multi-Page Originals as Separate Files - Windows	232
Faxing.....	236
Connecting a Telephone or Answering Machine	236
Setting Up Fax Features	239
Setting Up Basic Fax Features	239
Using the Fax Setting Wizard.....	239
Selecting the Line Type.....	241
Setting the Number of Rings to Answer	242
Selecting Advanced Fax Settings	243
Send Settings - Fax.....	244
Receive Settings - Fax	245
Report Settings - Fax	247
Basic Settings - Fax	248
Security Settings - Fax	250

Setting Up the Fax Utility - Windows.....	250
Setting Up Fax Features Using the Fax Utility - Mac	252
Setting Up Contacts and Contact Groups.....	253
Setting Up Contacts Using the Product Control Panel.....	254
Creating a Contact.....	254
Editing or Deleting a Contact	256
Creating a Contact Group	257
Editing or Deleting a Contact Group.....	259
Importing Contacts Using the Fax Utility - Windows	260
Setting Up Speed/Group Dial Lists Using the Fax Utility - Mac.....	263
Sending Faxes	265
Sending Faxes from the Product Control Panel.....	265
Sending a Fax Using the Keypad, Contact List, or History.....	266
Fax Sending Options	268
Sending a Fax at a Specified Time	270
Sending a Fax on Demand	271
Sending a Stored Fax	272
Dialing Fax Numbers from a Connected Telephone	273
Sending Faxes Using the Fax Utility - Windows	274
Sending Faxes Using the Fax Utility - Mac	277
Receiving Faxes.....	280
Fax Reception	280
Receiving Faxes Automatically	281
Receiving Faxes Manually.....	281
Forwarding Received Faxes.....	282
Receiving a Fax by Polling	282
Saving Faxes to an External USB Device	283
Saving and Viewing Received Faxes	284
Selecting Received Fax Options Using the Fax Utility - Windows	285
Checking Fax Status	288
Printing Fax Reports.....	289
Fax Report Options	289

Using External USB Devices with Your Product.....	291
Connecting a USB Device	291
USB Device File Specifications	291
Disconnecting a USB Device.....	292
Viewing and Printing from the LCD Screen	292
Printing JPEG Photos	292
Printing TIFF Files	294
Printing PDF Files.....	295
Print Setting Options - Device Mode	295
Transferring Files on a USB Device	297
Setting Up File Sharing for File Transfers from Your Computer.....	297
Transferring Files from a USB Device to Your Computer	298
Replacing Ink Supply Units (Ink Packs) and Maintenance Boxes	299
Check Ink and Maintenance Box Status.....	299
Checking Ink Status on the LCD Screen.....	299
Checking Ink and Maintenance Box Status - Windows.....	300
Checking Ink and Maintenance Box Status - Mac	302
Purchase Epson Ink Packs and Maintenance Boxes	304
Ink Supply Unit (Ink Pack) Part Numbers.....	304
Removing and Installing Ink Packs.....	305
Printing with Black Ink and Expended Color Ink Packs	308
Printing with Expended Color Ink Packs - Windows	308
Printing with Expended Color Ink Packs - Mac	309
Conserving Low Black Ink with Windows	310
Maintenance Box Replacement	311
Adjusting Print Quality.....	312
Print Head Maintenance.....	312
Print Head Nozzle Check.....	313
Checking the Nozzles Using the Product Control Panel	313
Checking the Nozzles Using a Computer Utility	315
Print Head Cleaning	317
Cleaning the Print Head Using the Product Control Panel	317
Cleaning the Print Head Using a Computer Utility.....	318

Print Head Alignment	320
Aligning the Print Head Using the Product Control Panel	321
Cleaning the Paper Guide	322
Cleaning and Transporting Your Product	324
Cleaning Your Product	324
Transporting Your Product	327
Solving Problems	332
Checking for Software Updates.....	332
Product Status Messages	333
Job Status Error Codes	335
Running a Product Check	339
Resetting Control Panel Defaults	341
Solving Setup Problems	342
Product Does Not Turn On or Off.....	343
Noise After Ink Installation	343
Software Installation Problems	343
Solving Network Problems	344
Product Cannot Connect to a Wireless Router or Access Point	344
Network Software Cannot Find Product on a Network.....	346
Product Does Not Appear in Mac Printer Window	347
Cannot Print Over a Network.....	347
Cannot Scan Over a Network	348
Solving Copying Problems	349
Product Makes Noise, But Nothing Copies.....	350
Product Makes Noise When It Sits for a While.....	350
Originals Do Not Feed From the Automatic Document Feeder.....	350
Solving Paper Problems	351
Paper Feeding Problems	352
Paper Jams Inside the Product.....	352
Paper Ejection Problems	353
Solving Problems Printing from a Computer.....	353
Nothing Prints	354
Product Icon Does Not Appear in Windows Taskbar	354

Printing is Slow	355
Solving PostScript Printing Problems	357
Nothing Prints Using the PostScript Printing Software.....	357
Documents Print Incorrectly Using the PostScript Printing Software	357
Accessing Printer Properties - PostScript - Windows	358
Solving Page Layout and Content Problems	358
Inverted Image.....	359
Too Many Copies Print	359
Blank Pages Print	359
Incorrect Margins on Printout.....	360
Incorrect Characters Print.....	360
Incorrect Image Size or Position	361
Slanted Printout	362
Solving Print Quality Problems	362
White or Dark Lines in Printout	363
Blurry or Smeared Printout	363
Faint Printout or Printout Has Gaps	365
Grainy Printout.....	366
Incorrect Colors	367
Solving Scanning Problems	368
Scanning Software Does Not Operate Correctly	368
Cannot Start Epson Scan 2	369
Solving Scanned Image Quality Problems	369
Image Consists of a Few Dots Only.....	370
Line of Dots Appears in All Scanned Images.....	370
Straight Lines in an Image Appear Crooked	371
Image is Distorted or Blurry	371
Image Colors are Patchy at the Edges	372
Image is Too Dark	372
Back of Original Image Appears in Scanned Image	372
Ripple Patterns Appear in an Image	372
Scanned Image Colors Do Not Match Original Colors.....	373
Scanned Image Edges are Cropped	373

Solving Faxing Problems.....	373
Cannot Send or Receive Faxes.....	374
Cannot Receive Faxes with a Telephone Connected to Your Product.....	376
Fax Memory Full Error Appears.....	376
Sent Fax Quality is Poor.....	377
Sent Fax is Received in an Incorrect Size.....	377
Received Fax Quality is Poor.....	378
Received Fax is Not Printed.....	378
Solving USB Device Problems.....	378
Cannot View or Print from a USB Device.....	379
Cannot Save Files on a USB Device.....	379
Cannot Transfer Files To or From a USB Device.....	380
Uninstall Your Product Software.....	380
Uninstalling Product Software - Windows.....	380
Uninstalling Product Software - Mac.....	381
Where to Get Help.....	382
Technical Specifications	383
Windows System Requirements.....	383
Mac System Requirements.....	384
Paper Specifications.....	385
Printable Area Specifications.....	386
Automatic Document Feeder (ADF) Specifications.....	387
Scanning Specifications.....	388
Fax Specifications.....	388
Ink Pack Specifications.....	389
Dimension Specifications.....	390
Electrical Specifications.....	390
Environmental Specifications.....	391
Interface Specifications.....	391
External USB Device Specifications.....	392
Network Interface Specifications.....	392
Safety and Approvals Specifications.....	393
PostScript Fonts (WF-C5790).....	394

PCL Fonts (WF-C5790).....	395
PCL Mode 5 Symbol Sets (WF-C5790).....	398
Notices	402
Important Safety Instructions.....	402
General Product Safety Instructions	402
Ink Pack Safety Instructions	404
Wireless Connection Safety Instructions	405
LCD Screen Safety Instructions.....	405
Telephone Equipment Safety Instructions	405
FCC Compliance Statement.....	406
Binding Arbitration and Class Waiver	408
Trademarks	412
Copyright Notice.....	412
libTIFF Software Acknowledgment.....	413
A Note Concerning Responsible Use of Copyrighted Materials.....	413
Default Delay Times for Power Management for Epson Products	414
Copyright Attribution	414

WF-C5710/WF-C5790 User's Guide

Welcome to the WF-C5710/WF-C5790 *User's Guide*.

For a printable PDF copy of this guide, [click here](#).

Product Basics

See these sections to learn about the basic features of your product.

Note: Printing software instructions in this manual are intended for use with the standard Epson printer software. For more information on using the Printer Command Language (PCL) or PostScript (PS3) printer software, please see the appropriate sections (WF-C5790).

[Using the Control Panel](#)

[Product Parts Locations](#)

[Using Power Saving Settings](#)

[Epson Connect Solutions for Smartphones, Tablets, and More](#)

[Using AirPrint](#)

[Using Google Cloud Print](#)

[Setting Up Google Cloud Print on a Chromebook](#)

[Android Printing Using the Epson Print Enabler](#)

[Using Fire OS Printing](#)

[Using Windows 10 Mobile Printing](#)

[Using Epson Print and Scan App with Windows Tablets](#)

[Printing and Scanning with NFC from Your Android Device](#)

Using the Control Panel

See these sections to learn about the control panel and select control panel settings.

[Control Panel Buttons and Lights](#)

[Changing LCD Screen Language](#)

[Selecting the Date and Time](#)

[Selecting Your Country or Region](#)

[Setting a Password and Locking the Control Panel](#)

[Setting User Feature Restrictions \(Access Control\)](#)

[Adjusting Control Panel Sounds](#)

[Adjusting the Screen Brightness](#)

[Turning Off the Operation Time Out Setting](#)

[Preventing PC Connection via USB](#)

Control Panel Buttons and Lights

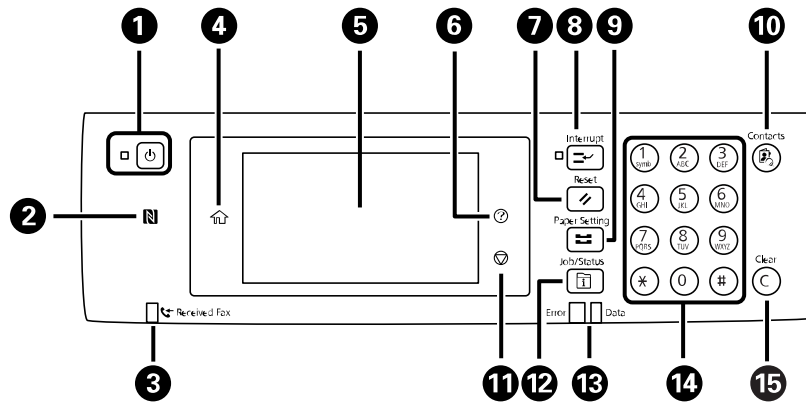



















- 1 power button and power light
- 2 NFC (Near Field Communication) tag
- 3 **Received Fax** light
- 4 home button
- 5 LCD screen
- 6 help button
- 7 **Reset** button
- 8 **Interrupt** button
- 9 **Paper Setting** button
- 10 **Contacts** button
- 11 stop button
- 12 **Job/Status** button
- 13 **Error** and **Data** lights
- 14 Numeric keypad
- 15 **C Clear** button



Status Icon Information

Parent topic: [Using the Control Panel](#)

Status Icon Information

Your product displays status icons on the LCD screen for certain product status conditions. Press the   icon to view or change the current network settings.

Icons	Description
	Displays additional information or instructions, such as loading paper or placing a document.
	Displays the Printer Status screen.
	Quiet Mode is enabled. Noise is reduced during printing, but the print speed may be reduced. Press this icon to change the settings.
	Quiet Mode is disabled. Press this icon to change the settings.
	The Mute setting is enabled. The product does not make any sound when you press buttons on the control panel.
	Displays the Fax Data Information screen.
	Press this icon to enable sleep mode and turn off the LCD screen.
	The indicated setting has changed.
	There is a problem with the indicated setting. Press the icon to resolve the problem.
	No Ethernet connection.
	An Ethernet connection is established.
	No Wi-Fi connection.
	A Wi-Fi network error has occurred or the product is searching for a connection.
	A Wi-Fi connection is established. The number of bars indicates the connection's signal strength.
	No Wi-Fi Direct connection.
	A Wi-Fi Direct connection is established.

Icons	Description
	Access to the product's functions are restricted to authorized users. Press the icon to log in to the product using a user name and password. Contact your administrator if you do not know the login information.
	Access to the product's functions are restricted to authorized users and a user is currently logged in. Press the icon to log out of the current user account.

Parent topic: [Control Panel Buttons and Lights](#)

Changing LCD Screen Language

You can change the language used on the LCD screen.

1. Press the  home button, if necessary.
2. Select **Settings** > **General Settings** > **Basic Settings** > **Language**.

You see a screen like this:



3. Select a language and select **Close**.

Parent topic: [Using the Control Panel](#)

Selecting the Date and Time

Before faxing, select the current date, time, and daylight saving phase in your area, and choose your preferred date and time format.

1. Press the  home button, if necessary.
2. Select **Settings** > **General Settings** > **Basic Settings** > **Date/Time Settings**.

You see a screen like this:

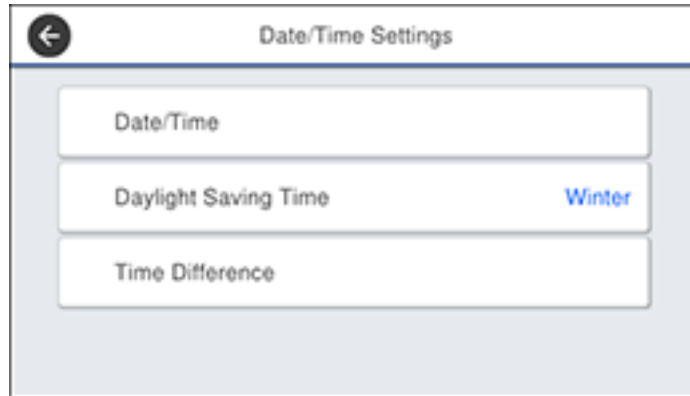

3. Select **Daylight Saving Time**.
4. Select the setting that applies to your area:
 - **Winter**: it is winter or your region does not use Daylight Saving Time (DST)
 - **Summer**: it is spring or summer and your region uses Daylight Saving Time (DST)

Note: If your region uses Daylight Saving Time (DST), you must change this setting to match the season. When you change from **Winter** to **Summer**, your product automatically sets its clock ahead one hour. When you change from **Summer** to **Winter**, it sets its clock back one hour.

5. Select **Date/Time**.
6. Select the date format you want to use.
7. Use the numeric keypad to enter the current date.
8. Select the time format you want to use.
9. Use the numeric keypad to enter the current time.

Parent topic: [Using the Control Panel](#)

Selecting Your Country or Region

Before using your product, select the country or region in which you are using your product.

Note: If you change the country or region, your fax settings return to their defaults and you must select them again. This setting can be locked by an administrator. If you cannot access or change this setting, contact your administrator for assistance.

1. Press the  home button, if necessary.
2. Select **Settings**.
3. Select **General Settings > Basic Settings**.



4. Scroll down and select **Country/Region**.
5. Scroll up or down, if necessary, and select your country or region.
You see a confirmation screen.
6. If the setting is correct, select **Yes**. (If not, select **No** and try again.)

Parent topic: [Using the Control Panel](#)

Setting a Password and Locking the Control Panel

You can set an administrator password to lock the following settings and prevent them from being changed:

- Certain Basic Settings and Printer Settings

- System Administration Settings
- Presets
- Contacts
- Network Settings
- Web Service Settings
- Scan Settings
- Fax Settings

Note: For more information on administration settings, see the [Administrator's Guide](#).

1. Press the  home button, if necessary.
2. Select **Settings > General Settings > System Administration > Security Settings > Admin Settings > Admin Password > Register**.

You see a screen like this:

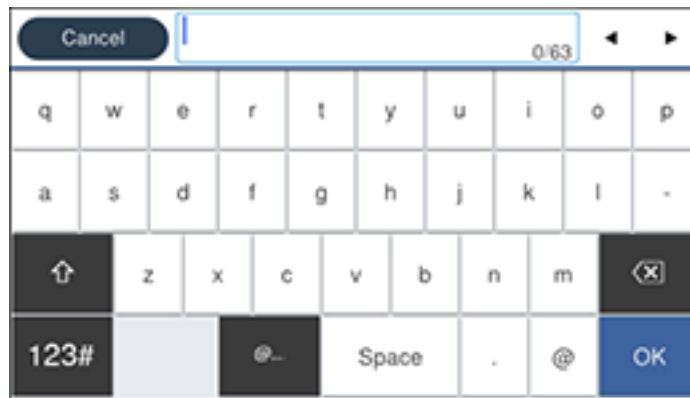

3. Use the displayed keyboard to enter a password, then select **OK**.
4. Enter your password again to confirm.
5. Select **OK**.
6. Select **Lock Setting** and select **On**.

When the control panel is locked, you must enter the password to access any of the locked settings.

Note: If you forget your password, contact Epson for assistance.

[Entering Characters on the LCD Screen](#)
[Using Presets](#)

Parent topic: [Using the Control Panel](#)



Related tasks

[Entering Characters on the LCD Screen](#)

Entering Characters on the LCD Screen

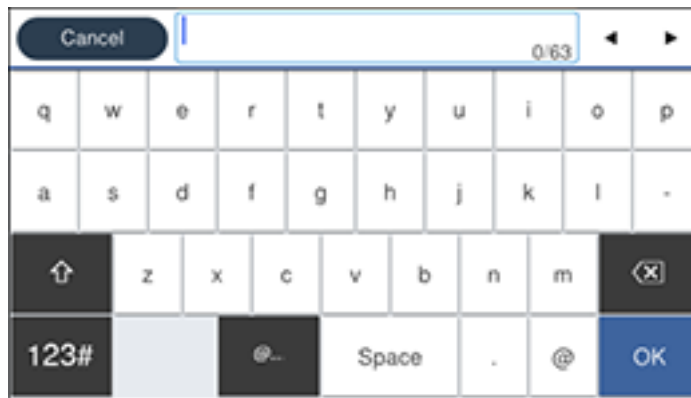
Follow these guidelines to enter characters for passwords and other settings.



- To move the cursor, select the left or right arrows.
- To change the case of letters, select .
- To delete the previous character, select .
- To enter numbers or symbols, select **123#**.
- To enter a space, select **Space**.

Parent topic: [Setting a Password and Locking the Control Panel](#)

Using Presets

You can save frequently used copy, fax, and scan settings as presets. This lets you easily reuse them whenever necessary.

Note: This setting can be locked by an administrator. If you cannot access this setting, contact your administrator for assistance.

1. Press the  home button, if necessary.
2. Select **Presets**.

You see a screen like this:



3. Select **Add New**.
4. Select the function for which you want to set up a preset, such as **Copy**.

You see the main screen for that function:

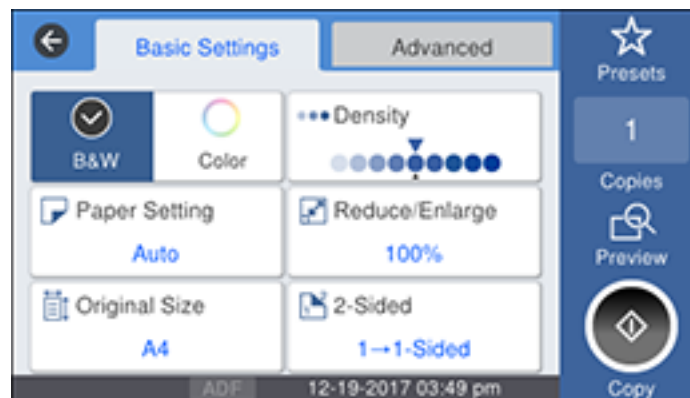

5. Select the settings you want to save and select **Register**.

You see a screen like this:

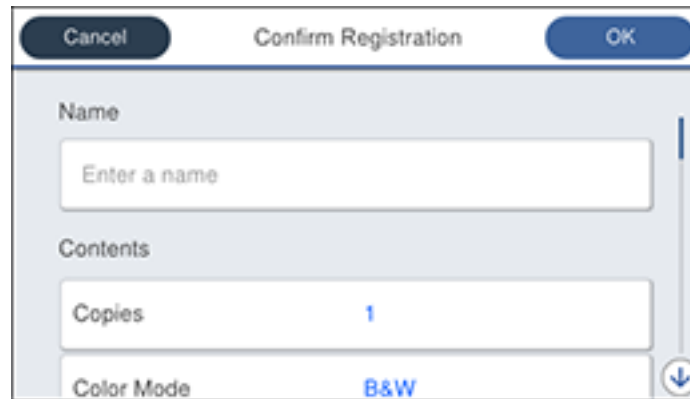

6. Select **Name**.

You see a screen like this:

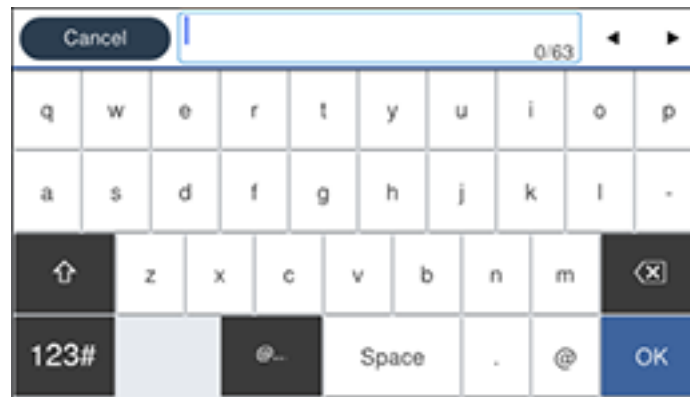

7. Use the displayed keyboard to enter a name for the preset and select **OK**.

8. Select **OK**.

When you copy, fax, or scan, you can use the preset by selecting **Presets** and selecting your preset name from the list.

Parent topic: [Setting a Password and Locking the Control Panel](#)

Related tasks

[Entering Characters on the LCD Screen](#)

Setting User Feature Restrictions (Access Control)

Using Web Config Access Control settings, you can restrict access to product features for individual users to prevent misuse of the product. Restricted features require the user to enter an ID and password on the product control panel.

After you set up feature restrictions, you must enable them using the product control panel.

Note: For more information on administration settings, see the [Administrator's Guide](#).

1. Press the  home button, if necessary.
2. Select **Settings** > **General Settings** > **System Administration** > **Security Settings** > **Access Control**.

You see a screen like this:

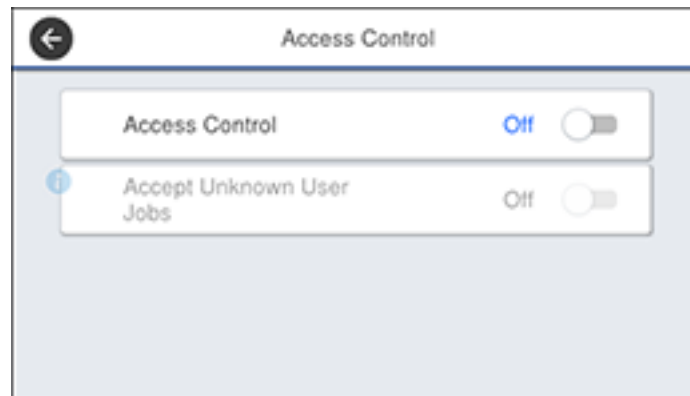

3. Select the **Access Control** field to turn the setting on.
4. If you want to allow users to print from generic drivers or use WSD scanning, select the **Accept Unknown User Jobs** field to turn the setting on.
5. Press the  home button to exit.

Parent topic: [Using the Control Panel](#)

Related tasks

[Setting a Password and Locking the Control Panel](#)

Adjusting Control Panel Sounds

You can adjust the sound level heard when you press buttons on the control panel.

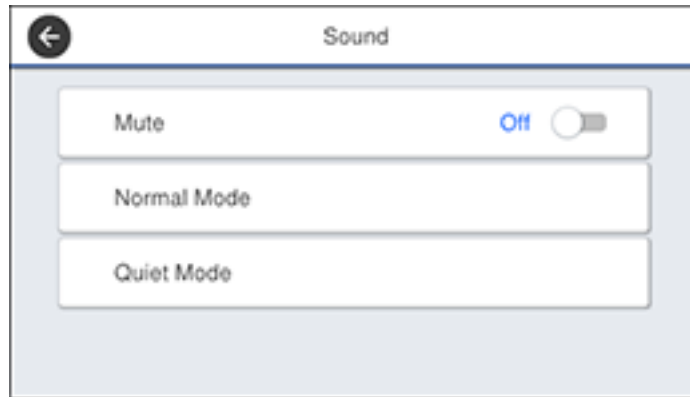

1. Press the  home button, if necessary.
2. Select **Settings** > **General Settings** > **Basic Settings** > **Sound**.

You see a screen like this:



3. Do one of the following:
 - To mute all control panel sounds, turn the **Mute** setting off.
 - To select a specific sound level, select **Normal Mode** or **Quiet Mode**.

Note: Press the  icon on the home screen to switch between Normal Mode and Quiet Mode.

4. If you did not mute the sounds, select **Button Press** to adjust the volume level.
5. Press  to decrease or  to increase the volume.
6. Select **OK** to exit.

Note: You can also adjust the **Sound Type** and the sound level for various product functions.

Parent topic: [Using the Control Panel](#)

Adjusting the Screen Brightness

You can adjust the brightness of the LCD screen.

1. Press the  home button, if necessary.
2. Select **Settings > General Settings > Basic Settings > LCD Brightness**.

You see a screen like this:

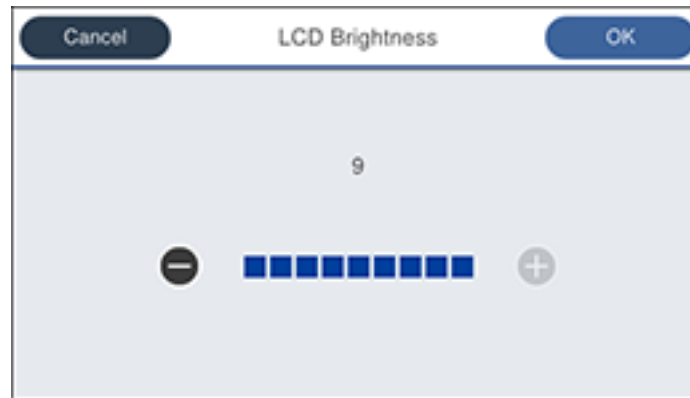

3. Press the – or + icons to decrease or increase the brightness.
4. Select **OK** to exit.

Parent topic: [Using the Control Panel](#)

Turning Off the Operation Time Out Setting

The Operation Time Out setting causes the LCD screen to return to the Home screen after a few minutes of inactivity. This feature is enabled by default, but you can turn it off.

Note: This setting can be locked by an administrator. If you cannot access this setting, contact your administrator for assistance.

1. Press the  home button, if necessary.

2. Select **Settings** > **General Settings** > **Basic Settings** > **Operation Time Out**.



3. Select **Off**.

Parent topic: [Using the Control Panel](#)

Preventing PC Connection via USB

You can disable access to your product from a USB-connected computer. This restricts non-network access to the product and protects the security of confidential scanned documents.

Note: This setting can be locked by an administrator. If you cannot access this setting, contact your administrator for assistance.

1. Press the  home button, if necessary.
2. Select **Settings** > **General Settings** > **Printer Settings** > **PC Connection via USB**.

You see a screen like this:



3. Select **Disable**.

Parent topic: [Using the Control Panel](#)

Product Parts Locations

See these sections to identify the parts on your product.

[Product Parts - Front](#)

[Product Parts - Inside](#)

[Product Parts - Back](#)

Parent topic: [Product Basics](#)

Product Parts - Front

Certain parts are labeled with a letter and number code. If you encounter any paper jams or errors, you can use these codes to locate and correct the problem.

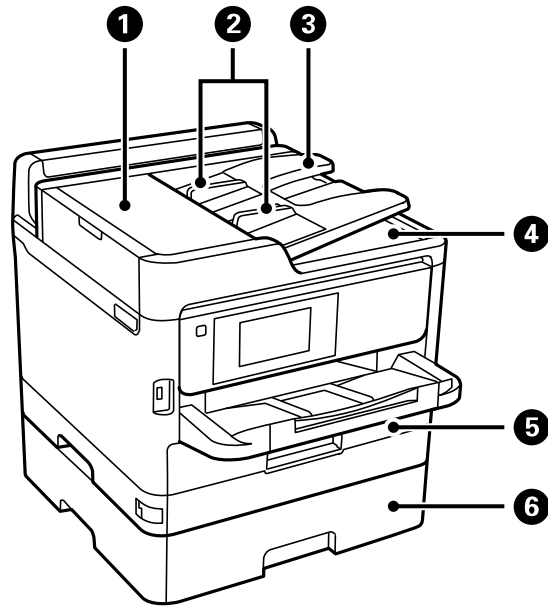

- 1 Automatic Document Feeder (ADF) cover (F)
- 2 ADF edge guides
- 3 ADF input tray
- 4 ADF output tray
- 5 Paper cassette 1 (C1)

6 Optional cassette 2 (C2)

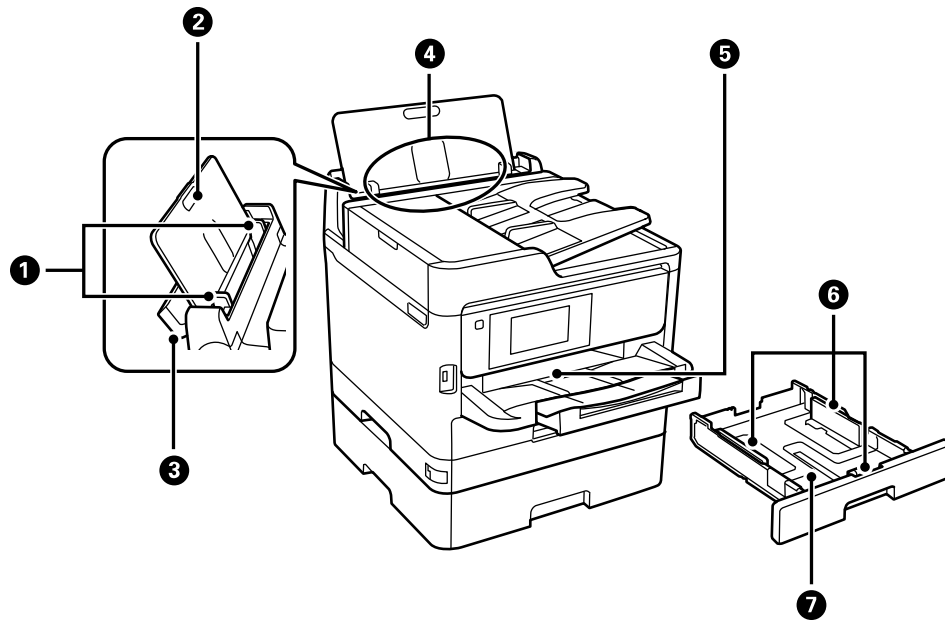

- 1 Rear paper feed edge guides
- 2 Paper support and extension
- 3 Feeder guard
- 4 Rear paper feed slot (B)
- 5 Output tray
- 6 Paper cassette edge guides
- 7 Paper cassette

Parent topic: [Product Parts Locations](#)

Product Parts - Inside

Certain parts are labeled with a letter and number code. If you encounter any paper jams or errors, use these codes to locate and correct the problem.

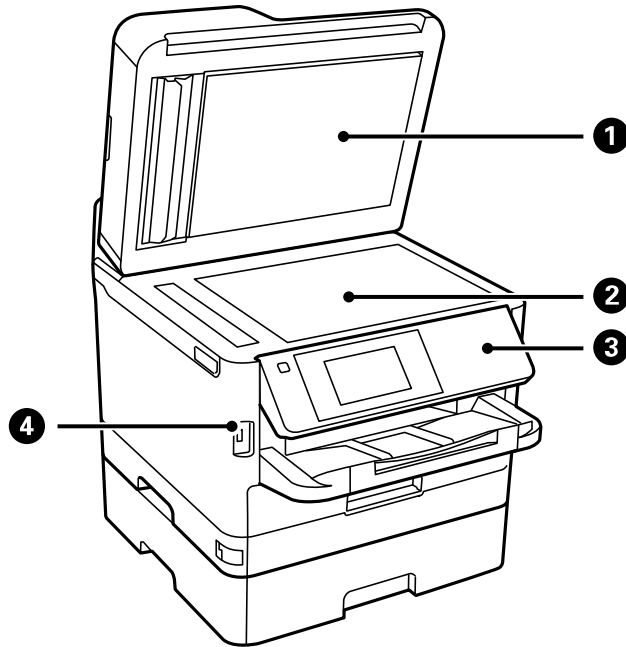

- 1 Document cover
- 2 Scanner glass
- 3 Control panel

4 USB Type A port for external devices

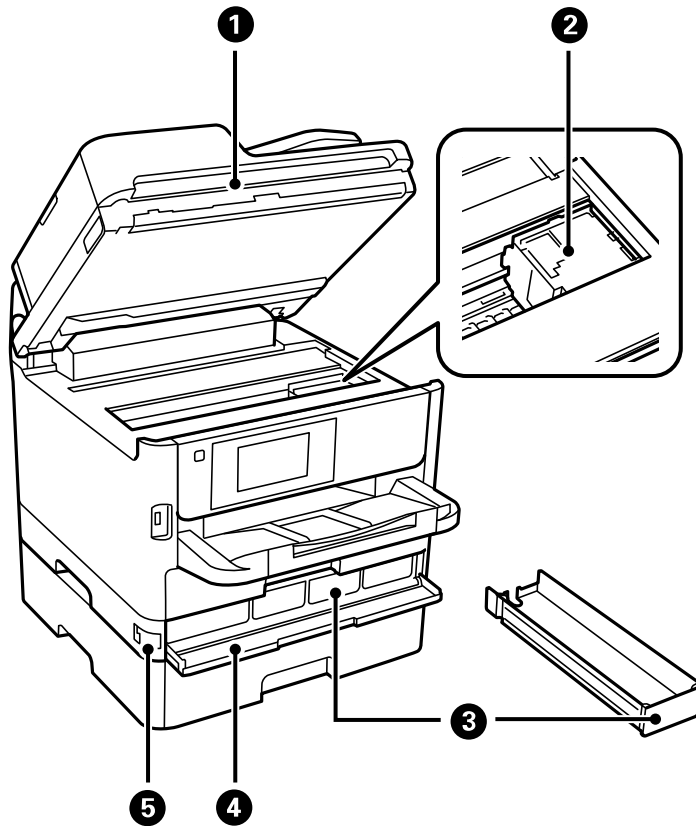

- 1 Scanner unit (J)
- 2 Print head
- 3 Ink pack tray
- 4 Front cover (A)
- 5 Front cover lock

Parent topic: [Product Parts Locations](#)

Product Parts - Back

Certain parts are labeled with a letter and number code. If you encounter any paper jams or errors, use these codes to locate and correct the problem.

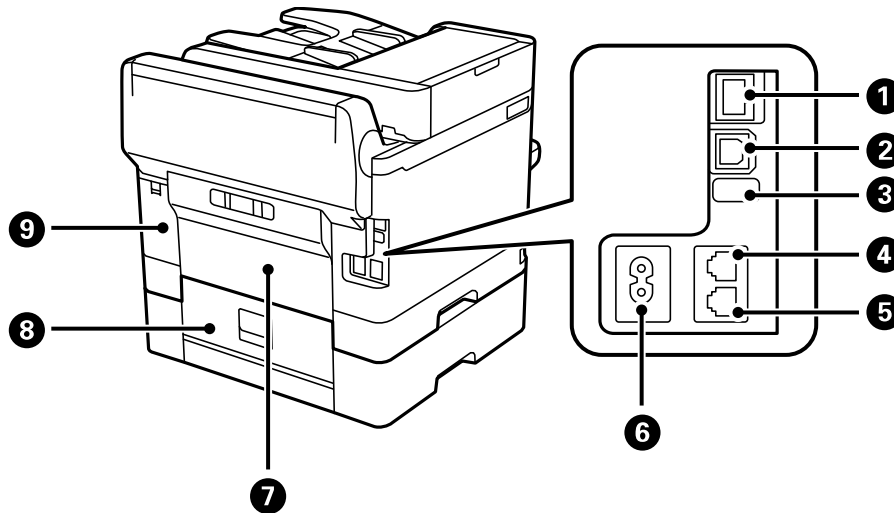

- 1 **LAN** port
- 2 **USB** port
- 3 Service USB port for future use (do not remove sticker)
- 4 **Line** port
- 5 **EXT** port
- 6 AC inlet
- 7 Rear cover (D)
- 8 Paper cassette rear cover (E)
- 9 Maintenance box cover (H)

Parent topic: [Product Parts Locations](#)

Using Power Saving Settings

Your product enters sleep mode automatically and turns off the LCD screen if it is not used for a period of time. You can make the time period shorter and select other options to save energy and resources.

[Changing the Sleep Timer Settings](#)

[Changing the Power Off Timer Settings](#)

Parent topic: [Product Basics](#)

Changing the Sleep Timer Settings

You can adjust the time period before your product enters sleep mode and turns off the LCD screen.

Note: This setting can be locked by an administrator. If you cannot access this setting, contact your administrator for assistance.

1. Press the  home button, if necessary.
2. Select **Settings** > **General Settings** > **Basic Settings** > **Sleep Timer**.

You see a screen like this:

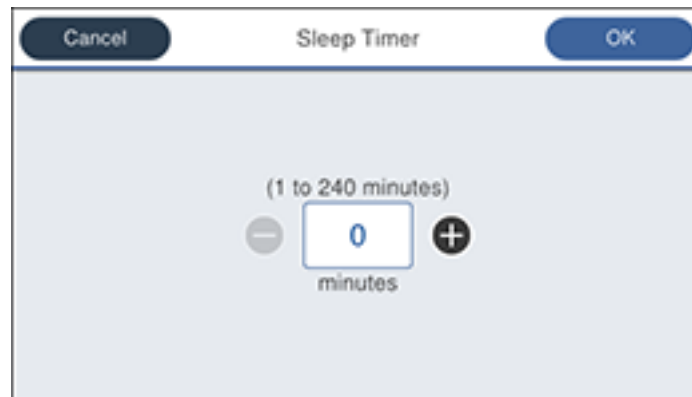

3. Do one of the following:
 - Select the **-** or **+** icon to decrease or increase the number of minutes.
 - Select the number of minutes on the LCD screen, select the number of minutes from the on-screen keypad, and select **OK**.

4. Select **OK**.

Parent topic: [Using Power Saving Settings](#)

Changing the Power Off Timer Settings

You can have the product turn off automatically if it is not used for a specified period of time.

Note: This setting can be locked by an administrator. If you cannot access this setting, contact your administrator for assistance.

1. Press the  home button, if necessary.
2. Select **Settings** > **General Settings** > **Basic Settings** > **Power Off Timer**.

You see a screen like this:



3. Select a time period between **30minutes** and **12h** (12 hours).

Parent topic: [Using Power Saving Settings](#)

Epson Connect Solutions for Smartphones, Tablets, and More

Use your smartphone, tablet, or computer to print and scan documents, photos, emails, and web pages from your home, office, or even across the globe.

Note: If you are using your Epson product with the Windows 10 S operating system, you cannot use the software described in this section. You also cannot download and install any Epson product software

from the Epson website for use with Windows 10 S; you must obtain software only from the Windows Store.

Print from anywhere with these Epson Connect solutions:

- Epson Email Print
- Epson iPrint Mobile App
- Epson Remote Print

Scan and send a file as an email or upload it to an online service directly from your Epson product with Epson Scan to Cloud or the Epson iPrint Mobile App.

[Setting Up Epson Connect Services](#)

[Using Epson Email Print](#)

[Using the Epson iPrint Mobile App](#)

[Using Epson Remote Print](#)

[Using Epson Scan to Cloud](#)

Parent topic: [Product Basics](#)

Setting Up Epson Connect Services

If you did not activate your product's email address for use with Epson Connect when you set up your product, you can activate it using the product control panel.

1. Press the  home button, if necessary.
2. Select **Settings**.
3. Select **General Settings**.

You see a screen like this:



4. Select **Web Service Settings**.
5. Select **Epson Connect Services**.

You see a screen like this:



6. Select **Register**.
7. Follow the instructions on the screen to activate your product's email address.

Parent topic: [Epson Connect Solutions for Smartphones, Tablets, and More](#)

Using Epson Email Print

With Epson Email Print, you can print from any device that can send email, such as your smartphone, tablet, or laptop. Just activate your product's unique email address. When you want to print, attach a PDF, Microsoft Office document, or photo to an email and send it to your product. Both the email and the attachments will print automatically.

1. Connect your product to your network. See the link below.
2. If you did not already set up Email Print when you installed your product software, see the link below to use your product control panel to activate your unique email address. Or visit epson.com/connect (U.S), epson.ca/connect (Canada), or epsonconnect.com (Caribbean) to learn more about Email Print, create your Epson Connect account, and register your product to the Epson Connect service.
3. Now you are ready to send and print emails to your product's Email Print address.

Note: Go to epsonconnect.com and log into your Epson Connect account to personalize your product's email, adjust print settings, and set up other Epson Connect services.

Parent topic: [Epson Connect Solutions for Smartphones, Tablets, and More](#)

Related topics

[Wi-Fi or Wired Networking](#)

Using the Epson iPrint Mobile App

Use this free Apple and Android app to print and scan with networked Epson products. Epson iPrint lets you print PDFs, Microsoft Office documents, photos, and web pages over a wireless network. You can scan and save a file on your device, send it as an email, or upload it to an online service such as Box, Dropbox, Evernote, or Google Drive.

1. Connect your product to your wireless network. See the link below.
2. Visit epson.com/connect (U.S), epson.ca/connect (Canada), or epson.com.jm/connect (Caribbean) to learn more about Epson iPrint and check the compatibility of your mobile device.
3. Download Epson iPrint from the Apple App Store or Google Play.
4. Connect your mobile device to the same wireless network as your product.
5. Open Epson iPrint and select your Epson product.

Now you are ready to print or scan with your mobile device and your Epson product.

Parent topic: [Epson Connect Solutions for Smartphones, Tablets, and More](#)

Related topics

[Wi-Fi or Wired Networking](#)

Using Epson Remote Print

With Epson Remote Print software, you can print from your laptop or desktop computer to an Epson Email-enabled product anywhere in the world.

1. Connect your Epson product to your wireless network. See the link below.
2. If you did not already set up an Epson Connect account when you installed your product software, visit epsonconnect.com to create your account and register your product to the Epson Connect service.

Note: Make a note of your product's email address.

3. Visit epsonconnect.com to learn more about Remote Print and how to download the Remote Print Driver software.
4. Download and install the Remote Print software.
5. Enter the email address and optional access key of your Epson product during Remote Print setup.
6. Now you are ready to print remotely. Select the print command in your laptop or desktop computer application and choose the Remote Print option for your Epson product.

Parent topic: [Epson Connect Solutions for Smartphones, Tablets, and More](#)

Related topics

[Wi-Fi or Wired Networking](#)

Using Epson Scan to Cloud

The Epson Scan to Cloud service allows you to scan and send a file as an email or upload it to an online service directly from your Epson product. Register an email address or online services such as Box, DropBox, Evernote, or Google Drive with your Epson Connect account.

1. Connect your Epson product to your network. See the link below.
2. If you did not already set up an Epson Connect account when you installed your product software, visit epsonconnect.com to create your account and register your product to the Epson Connect service.

Note: Make a note of your product's email address and password.

3. Visit epsonconnect.com to sign into your account with the email address and password you selected.
4. Select your product, select **Scan to Cloud**, and select **Destination List**.
5. Click **Add**, then follow the instructions on the screen to create your destination list.
6. Now you are ready to use Scan to Cloud. Select the setting for scanning to Scan to Cloud on your Epson product control panel.

Parent topic: [Epson Connect Solutions for Smartphones, Tablets, and More](#)

Related tasks

[Scanning to Email](#)

Related topics

[Wi-Fi or Wired Networking](#)

Using AirPrint

AirPrint enables instant wireless printing from iPhone, iPad, and iPod touch with the latest version of iOS, and Mac with the latest version of OS X or macOS.



Note: If you disabled paper configuration messages on your product control panel, you cannot use AirPrint. See the link below to enable the messages, if necessary.

1. Load paper in your product.
2. Set up your product for wireless printing. See the link below.
3. Connect your Apple device to the same wireless network that your product is using.
4. Print from your device to your product.

Note: For details, see the AirPrint page on the Apple website.

Parent topic: [Product Basics](#)

Related references

[Paper Source Settings Options](#)

Related topics

[Wi-Fi or Wired Networking](#)

Using Google Cloud Print

With a Google Account, you can print from your Apple or Android device to your Epson product. You can also print from Chromebooks and the Google Chrome browser without drivers or cables.

1. Connect your Epson product to your wireless network. See the link below.
2. Note your product's IP address by checking your network status. See the link below.
3. Connect your computer or your Apple or Android device to the same wireless network as your Epson product.
4. Enter your product's IP address into the address bar of a web browser.
5. Select the **Google Cloud Print Services** option.

Note: If you don't see the **Google Cloud Print Services** option, turn your product off and back on. If the option still doesn't appear, select the **Firmware Update** option and follow the on-screen instructions to update your product.

6. Click **Register**.
7. Select the checkbox to agree to the Usage Advisory and click **Next**.
8. Click **OK** to launch the sign-in page.
A separate browser window opens.
9. Enter your Google Account username and password and click **Sign in**, or, if you don't have an account, click **Sign up for a new Google Account** and follow the on-screen instructions.
10. Click **Finish printer registration** to complete setup and print a test page.

Your product is now linked to your Google Account and can be accessed from any Chromebook, computer, Apple or Android device with Internet access. Visit [Epson Support for Google Cloud Print \(U.S\)](#) or [Epson Support for Google Cloud Print \(Canada\)](#) for more information on using Google Cloud Print, or the [Google Cloud Print](#) website for a list of [supported apps](#).

Parent topic: [Product Basics](#)

Related tasks

[Printing a Network Status Sheet](#)

Related topics

[Wi-Fi or Wired Networking](#)

Setting Up Google Cloud Print on a Chromebook

With a Google Account, you can print from a Chromebook without drivers or cables.

1. Connect your Epson product to your wireless network. See the link below.
2. Turn on your Chromebook and connect it to the same wireless network as your product.

Note: See your Chromebook's documentation for details on connecting to a network.

3. Do one of the following:
 - Click **Add to Cloud Print** in the notification that appears in the corner of your Chromebook screen.

Note: If you do not see a notification, check to see if a number appears in the status area at the lower-right corner of the screen. Click this number to open the notifications menu, then click **Add to Cloud Print**.

- Open a web browser and enter **chrome://devices** in the address bar. Skip to step 5.
 - If you see a registration confirmation screen instead, click **Register**.
4. Click **Add Device**.
 5. Click the **Register** button that appears next to your product.
 6. Click **Register** on the confirmation screen. Your product's LCD screen displays a confirmation message.
 7. Select **OK** or press the **OK** button on your product to confirm the Google Cloud Print connection and print a test page.

Your product is now linked to your Google Account and can be accessed from any Chromebook, iPhone, or Android phone with Internet access. Visit [Epson Support for Google Cloud Print \(U.S\)](#) or [Epson Support for Google Cloud Print \(Canada\)](#) for more information on using Google Cloud Print, or the [Google Cloud Print](#) website for a list of [supported apps](#).

Parent topic: [Product Basics](#)

Related topics

[Wi-Fi or Wired Networking](#)

Android Printing Using the Epson Print Enabler

You can wirelessly print your documents, emails, photos, and web pages right from your Android phone or tablet (Android v4.4 or later). With a few taps, your Android device will discover your nearby Epson product and print.

1. Connect your Epson product to your wireless network. See the link below.
2. On your Android device, download the Epson Print Enabler plug-in from Google Play.
3. Go to **Settings** on your Android device, select **Printing**, and enable the Epson plug-in.
4. Connect your Android device to the same wireless network as your product.
5. Now you are ready to print. From an Android application such as Chrome or Gmail, tap the menu icon and print whatever is on the screen.

Note: If you do not see your product, tap **All Printers** and select your product.

Parent topic: [Product Basics](#)

Related topics

[Wi-Fi or Wired Networking](#)

Using Fire OS Printing

You can wirelessly print from Amazon Fire tablets and phones to your nearby networked Epson product. There is no software to download, no drivers to install, and no cables to connect. With just a few taps in Email, Calendar, Contacts, and WPS Office, you can send whatever is on the screen to an Epson product.

1. Connect your Epson product to your wireless network. See the link below.
2. Connect your Amazon device to the same wireless network as your product.
3. Now you are ready to print. From your Amazon application, tap the print option and select your product to print whatever is on the screen.

Note: If you see a message telling you that a plug-in is required, tap **OK** and tap **Download**. If your Amazon Fire product uses Fire OS 5 and above, your device automatically uses the built-in Mopria Print Service app to print.

Visit epson.com/connect (U.S), epson.ca/connect (Canada), or epson.com.jm/connect (Caribbean) to learn more about Fire OS Printing (one of many Epson Connect Partner Solutions) and check the compatibility of your mobile device.

Parent topic: [Product Basics](#)

Related topics

[Wi-Fi or Wired Networking](#)

Using Windows 10 Mobile Printing

You can wirelessly print from Windows 10 Mobile tablets and phones to your nearby networked Epson product. There is no software to download, no drivers to install, and no cables to connect. Look for the print option in your Windows 10 application to send whatever is on the screen to an Epson product.

1. Connect your Epson product to your wireless network. See the link below.
2. Connect your Windows 10 Mobile device to the same wireless network as your product.
3. Now you are ready to print. From your Windows 10 application, tap the print option and select your product to print whatever is on the screen.

Visit epson.com/connect (U.S), epson.ca/connect (Canada), or epson.com.jm/connect (Caribbean) to learn more about Windows 10 Mobile Printing (one of many Epson Connect Partner Solutions) and check the compatibility of your mobile device.

Parent topic: [Product Basics](#)

Related topics

[Wi-Fi or Wired Networking](#)

Using Epson Print and Scan App with Windows Tablets

You can use this free app to print photos and scan from your Windows (Windows 8 or higher) Surface RT or Pro tablet with networked Epson products. Epson Print and Scan App allows you to scan and capture images right to your tablet or to Microsoft OneDrive.

Note: The Epson Print and Scan App does not support Windows 10 Mobile printing.

1. Connect your Epson product to your wireless network. See the link below.
2. Download Epson Print and Scan App from the Microsoft Windows Store.
3. Connect your Windows tablet to the same wireless network as your product.
4. Open Epson Print and Scan App and select your Epson product.

Now you are ready to print photos or scan.

Visit epson.com/connect (U.S), epson.ca/connect (Canada), or epson.com.jm/connect (Caribbean) to learn more about Epson Print and Scan App.

Parent topic: [Product Basics](#)

Related topics

[Wi-Fi or Wired Networking](#)

Printing and Scanning with NFC from Your Android Device

You can easily connect your Android 4.0 or later device to your product using NFC (Near Field Communication). Once connected, you can print and scan using Epson iPrint.

1. Make sure Epson iPrint is installed on your Android device.
2. Make sure Simple AP mode or Wi-Fi Direct is enabled on your product and that you are using the default Wi-Fi Direct password.

Note: NFC printing and scanning will not work if you changed the default Wi-Fi Direct password.

3. Do one of the following:
 - If you are going to print, make sure paper is loaded in the product.
 - If you are going to scan, place your original on the product for scanning.

4. Touch the NFC antenna of your Android device to the NFC tag on your product.

Note: The location of your mobile device's NFC antenna varies. See your mobile device documentation for details.

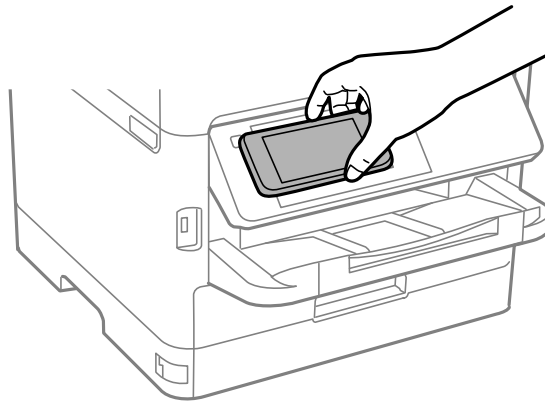

Epson iPrint opens on your device.

Note: If you do not have Epson iPrint installed, the app store page for the Epson iPrint app opens on your device. Install Epson iPrint and repeat this step.

5. Touch the NFC antenna of your Android device to the product NFC tag on your product again.
The product and Android device connect.

Note: If the Android device and product disconnect, try to print or scan a document. The Android device and product should reconnect automatically.

6. If you are going to print, open the file you want to print in Epson iPrint.
7. Touch the NFC antenna of your Android device to the NFC tag on your product to start printing or scanning.

Parent topic: [Product Basics](#)

Wi-Fi or Wired Networking

See these sections to use your product on a Wi-Fi or wired network.

[Network Security Recommendations](#)

[Wi-Fi Infrastructure Mode Setup](#)

[Wi-Fi Direct Mode Setup](#)

[Wi-Fi Protected Setup \(WPS\)](#)

[Printing a Network Status Sheet](#)

[Configuring Email Server Settings](#)

[Changing or Updating Network Connections](#)

Network Security Recommendations

To help deter unauthorized access to your product over a network, you should protect your network environment using appropriate security measures.

Security measures such as these can help deter threats such as loss of user data, use of telephone and fax lines, and other intrusions:

- **Enable security on your wireless LAN**

Enable the appropriate security on the wireless LAN you plan to use with your product. Network security such as a network password can deter interception of traffic over the wireless LAN. Your router may already have a default password enabled by your Internet service provider (ISP). See your ISP and router documentation for instructions on how to change the default password and better secure your network.

- **Connect your product only to a network protected by a firewall**

Connecting your product directly to the Internet may leave it vulnerable to security threats. Instead, connect it to a router or other network connection protected by a firewall. Your router may already have a firewall set up by your Internet service provider; check with your ISP for confirmation. For best results, set up and use a private IP address for your network connection.

- **Change the default administrator password on your product**

If your product has an option to set an administrator password, change the default administrator password to deter access by unauthorized users to personal data stored on your product, such as IDs, passwords, and contact lists.

Parent topic: [Wi-Fi or Wired Networking](#)

Wi-Fi Infrastructure Mode Setup

You can set up your product to communicate with your computer using a wireless router or access point. The wireless router or access point can be connected to your computer over a wireless or wired network.

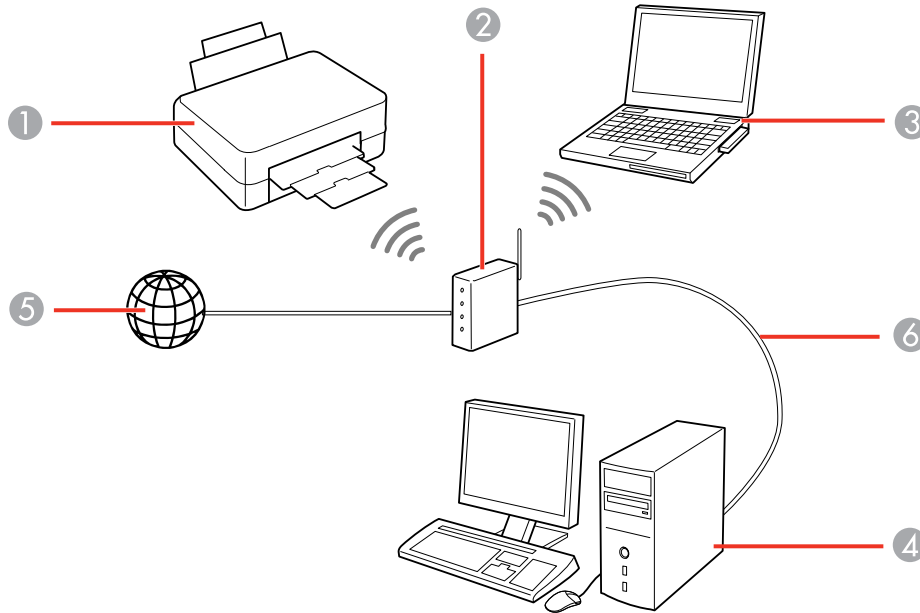

- 1 Epson product
- 2 Wireless router or access point
- 3 Computer with a wireless interface
- 4 Computer
- 5 Internet
- 6 Ethernet cable (used only for wired connection to the wireless router or access point)

[Selecting Wireless Network Settings from the Control Panel](#)



Parent topic: [Wi-Fi or Wired Networking](#)

Selecting Wireless Network Settings from the Control Panel

You can select or change wireless network settings using your product control panel.

To install your product on a wireless network, follow the instructions on the *Start Here* sheet and install the necessary software by downloading it from the Epson website. The installer program guides you through network setup.

Note: Breakdown or repair of this product may cause loss of fax and network data and settings. Epson is not responsible for backing up or recovering data and settings during or after the warranty period. We recommend that you make your own backup or print out your fax and network data and settings.

1. Press the  home button, if necessary.
2. Press the   icon.

You see a screen like this:

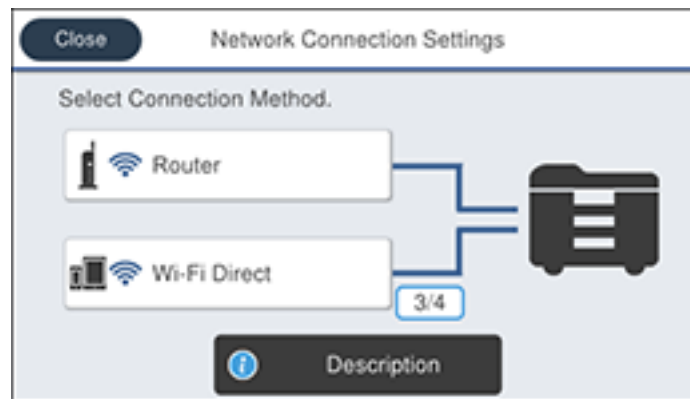

3. Select **Router**.
4. Select **Start Setup** or **Change Settings**.
5. Select **Wi-Fi Setup Wizard**.
6. Select the name of your wireless network or select **Enter Manually** to enter the name manually. Use the displayed keyboard to enter your network name.

7. Select the **Password** field and enter your wireless password using the displayed keyboard.

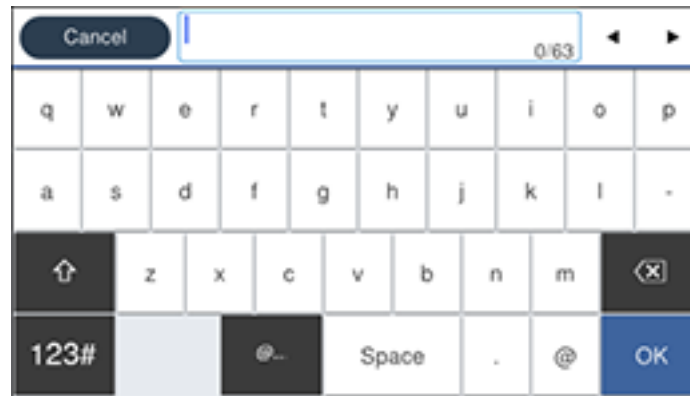

Note: The network name and password are case sensitive. Be sure to correctly enter uppercase and lowercase letters, and numeric or special characters.

- To move the cursor, select the left or right arrows.

- To change the case of letters, select .

- To delete the previous character, select .

- To enter numbers and symbols, select .

- To enter a space, select **Space**.

8. Select **OK** when you finish entering your password.
9. Confirm the displayed network settings and select **Start Setup** to save them.
10. If you want to print a network setup report, select **Print Check Report**. (Otherwise, select **OK**.)
11. Press the  home button to exit.

You see the  icon on the LCD screen and should be able to connect to your product directly from your computer or device, and then print. If you are printing from a computer, make sure you installed the network software as described on the *Start Here* sheet.

Note: If you don't see the  icon, you may have selected the wrong network name or entered the password incorrectly. Repeat these steps to try again.

Parent topic: [Wi-Fi Infrastructure Mode Setup](#)

Related references

[Status Icon Information](#)

Related tasks

[Entering Characters on the LCD Screen](#)

Wi-Fi Direct Mode Setup

You can set up your product to communicate directly with your computer or another device without requiring a wireless router or access point. In Wi-Fi Direct Mode, the product itself acts as a network access point for up to 4 devices.

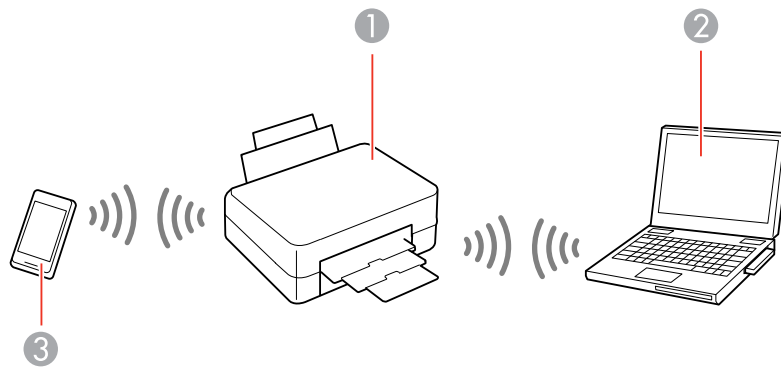



- 1 Epson product
- 2 Computer with a wireless interface
- 3 Other wireless device

[Enabling Wi-Fi Direct Mode](#)

Parent topic: [Wi-Fi or Wired Networking](#)

Enabling Wi-Fi Direct Mode

You can enable Wi-Fi Direct mode to allow direct communication between your product and computer or other devices without a wireless router or access point.

1. Press the  home button, if necessary.
2. Press the   icon.

You see a screen like this:

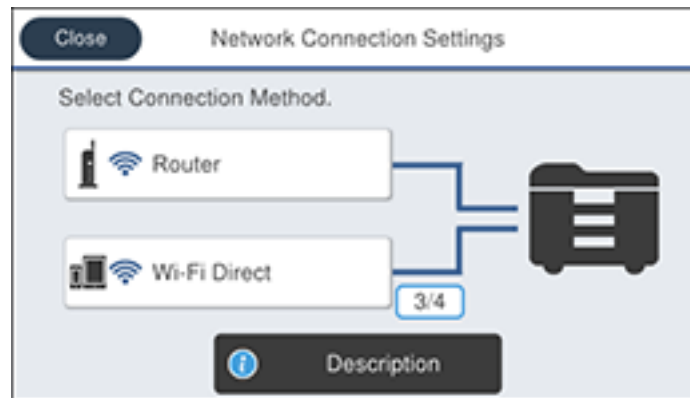

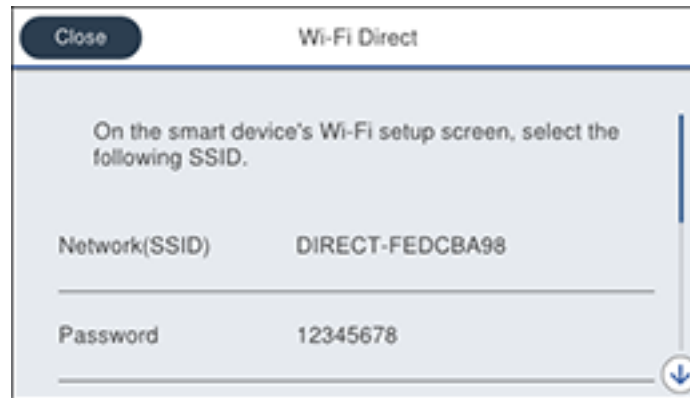

3. Select **Wi-Fi Direct**.
4. Scroll down and select **Start Setup**.
5. Select **Start Setup** again.

You see a screen like this:



6. Use your computer or wireless device to select the Wi-Fi network name (SSID) displayed on the LCD screen, then enter the password shown.
7. Press the  home button to exit.

You see the  icon on the LCD screen and should be able to connect to your product directly from your computer or device, and then print. If you are printing from a computer, make sure you installed the network software as described on the *Start Here* sheet.

Note: If you don't see the  icon on the LCD screen, you may have selected the wrong network name or entered the password incorrectly. Repeat these steps to try again.

Parent topic: [Wi-Fi Direct Mode Setup](#)

Related references

[Status Icon Information](#)

Wi-Fi Protected Setup (WPS)

If your network uses a WPS-enabled wireless router or access point, you can quickly connect your product to the network using Wi-Fi Protected Setup (WPS).



Note: To check if your router is WPS-enabled, look for a button labeled **WPS** on your router or access point. If there is no hardware button, there may be a virtual WPS button in the software for the device. Check your network product documentation for details.

Using WPS to Connect to a Network

Parent topic: [Wi-Fi or Wired Networking](#)

Using WPS to Connect to a Network

If you have a WPS-enabled wireless router or access point, you can use Wi-Fi Protected Setup (WPS) to connect your product to the network.

1. Press the  home button, if necessary.
2. Press the   icon.

You see a screen like this:

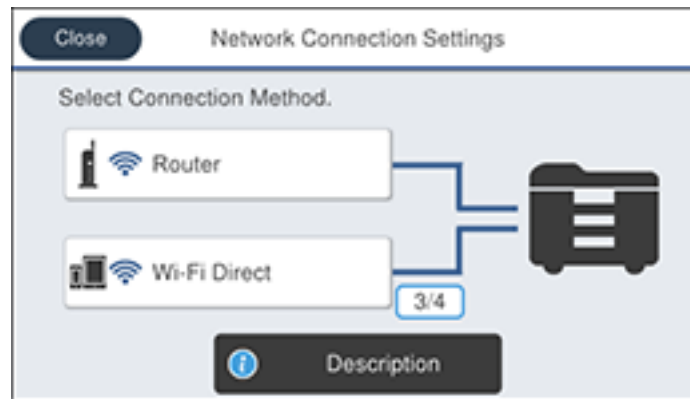

3. Select **Router**.
4. Select **Push Button Setup (WPS)**.
5. Follow the instructions on the LCD screen to complete WPS setup.
6. Press the  home button to exit.

You see the  icon on the LCD screen and should be able to connect to your product directly from your computer or device, and then print. If you are printing from a computer, make sure you installed the network software as described on the *Start Here* sheet.

Note: If you don't see the  icon, repeat these steps to try again.

Parent topic: [Wi-Fi Protected Setup \(WPS\)](#)

Printing a Network Status Sheet

You can print a network status sheet to help you determine the causes of any problems you may have using your product on a network.

1. Press the  home button, if necessary.
2. Select **Settings**.
3. Select **General Settings**.

You see a screen like this:



4. Select **Network Settings > Network Status > Print Status Sheet**.
5. Select **Print** to print the sheet.

Examine the settings shown on the network status sheet to diagnose any problems you may have.

Parent topic: [Wi-Fi or Wired Networking](#)

Configuring Email Server Settings

To use features such as scanning to email or forwarding faxes to email, you need to configure the email server. You can select settings for the email server using the control panel on the product.

Note: These settings can be locked by an administrator. If you cannot access these settings, contact your administrator for assistance.

1. Press the  home button, if necessary.
2. Select **Settings**.
3. Select **General Settings > Network Settings**.

You see a screen like this:

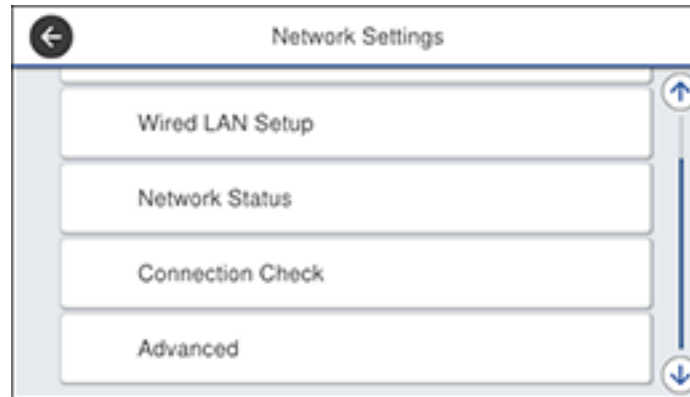

4. Scroll down and select **Advanced**.
5. Select **Email Server > Server Settings**.

You see a screen like this:



6. Select one of the options shown above, then select the settings you want to use. Contact your internet service provider if necessary to confirm the authentication method for the email server.
7. Select **Proceed** to save your settings.
8. Select **Close** to exit.
9. Select **Connection Check** to verify the connection to the email server.

Parent topic: [Wi-Fi or Wired Networking](#)

Related tasks

[Scanning to Email](#)

[Forwarding Received Faxes](#)

Changing or Updating Network Connections

See these sections to change or update how your product connects to a network.

[Accessing the Web Config Utility](#)

[Changing a USB Connection to a Wi-Fi Connection](#)

[Changing a Wi-Fi Connection to a Wired Network Connection](#)

[Connecting to a New Wi-Fi Router](#)

[Disabling Wi-Fi Features](#)

Parent topic: [Wi-Fi or Wired Networking](#)

Accessing the Web Config Utility

You can select your product's network settings and confirm its operating status using a web browser. You do this by accessing your product's built-in Web Config utility from a computer or other device that is connected to the same network as your product.

Note: For more information on the Web Config utility, see the [Administrator's Guide](#).

1. Print a network status sheet.
2. Locate the IP address for your product that is listed on the network status sheet.
3. On a computer or other device connected to the same network as your product, open a web browser.
4. Enter your product's IP address into the address bar.
You see the available Web Config utility options.

Parent topic: [Changing or Updating Network Connections](#)

Related tasks

[Printing a Network Status Sheet](#)

Changing a USB Connection to a Wi-Fi Connection

If you have already connected your product to your computer using a USB connection, you can change to a Wi-Fi connection.

1. Disconnect the USB cable from your product.
2. Uninstall your product software.
3. Download and install your product software from the Epson website using the instructions on the *Start Here* sheet.

Parent topic: [Changing or Updating Network Connections](#)

Related concepts

[Uninstall Your Product Software](#)

Changing a Wi-Fi Connection to a Wired Network Connection

If you have already connected your product to your computer wirelessly, you can change to a wired network connection if necessary.

1. Disable your product's Wi-Fi features.
2. Connect one end of an Ethernet network cable to the product's **LAN** port.
3. Connect the other end to any available LAN port on your router or access point.
4. Uninstall your product software.
5. Download and install your product software from the Epson website.
6. Follow the on-screen instructions to install the software.
7. When you see the Select Your Connection screen, select **Wired network connection**.
8. If you see a Select Setup Option screen, select **Set up printer for the first time**.
9. Continue following the rest of the on-screen instructions.

Parent topic: [Changing or Updating Network Connections](#)

Related concepts

[Uninstall Your Product Software](#)

Related tasks

[Disabling Wi-Fi Features](#)

Connecting to a New Wi-Fi Router

If you change the wireless router you have been using on your network, you need to update your product's Wi-Fi connection to the new router.

Note: If you switch to a 5 GHz wireless router, set the router to operate in dual band (2.4 GHz and 5 GHz) mode. See your router documentation for instructions.

1. Do one of the following:
 - **Windows:** Uninstall your product software.
 - **Mac:** Go to the next step.
2. Download and install your product software from the Epson website using the instructions on the *Start Here* sheet.

Parent topic: [Changing or Updating Network Connections](#)



Related tasks

[Uninstalling Product Software - Windows](#)

Disabling Wi-Fi Features

You may need to disable your product's Wi-Fi features if you change your network connection type or need to solve a problem with your network connection.

Note: Before disabling Wi-Fi features, make a note of your product's SSID (network name) and password, and any network settings selected for the Epson Connect services you may use.

1. Press the  home button, if necessary.
2. Press the   icon.

You see a screen like this:

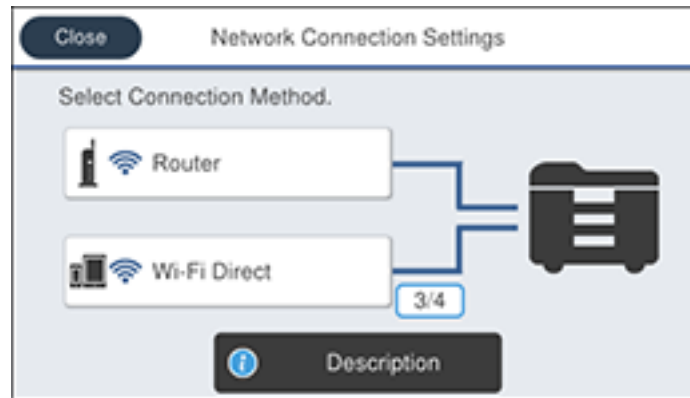

3. Select **Router** > **Change Settings** > **Others** > **Disable Wi-Fi**.
4. Select **Yes** to disable Wi-Fi.

Parent topic: [Changing or Updating Network Connections](#)

Enabling Epson Universal Print Driver (PCL) or PostScript Printing

Before enabling Epson Universal Print Driver (PCL) or PostScript printing on your product, make sure you have installed the software as described on the *Start Here* sheet (WF-C5790).

To download the Epson Universal Print Driver or PostScript drivers, visit epson.com/support (U.S.), epson.ca/support (Canada), or epson.com.jm/support (Caribbean) and select your product.

[Installing the Epson Universal Print Driver - Windows](#)

[Installing the PostScript \(PS3\) Printer Software - Windows](#)

[Installing the PostScript \(PS3\) Printer Software - Mac](#)

[Selecting PDL \(Page Description Language\) Settings](#)

[Selecting Printer Language and Interface Settings](#)

[Printing a PCL or PS3 \(PostScript\) Status Sheet](#)

Installing the Epson Universal Print Driver - Windows

The Epson Universal Print Driver supports multiple printer languages, such as PCL and ESC/P-R, and can be installed on a Windows computer.

Note: Make sure your product is turned on and connected to the same network as your computer before installing the printer software. Depending on your model, not all printer languages may be supported.

1. To download the **EPSON Universal Print Driver** file, visit epson.com/support (U.S.), epson.ca/support (Canada), or epson.com.jm/support (Caribbean) and select your product.
2. Double-click the downloaded package.

3. Follow the on-screen instructions until you see this screen:

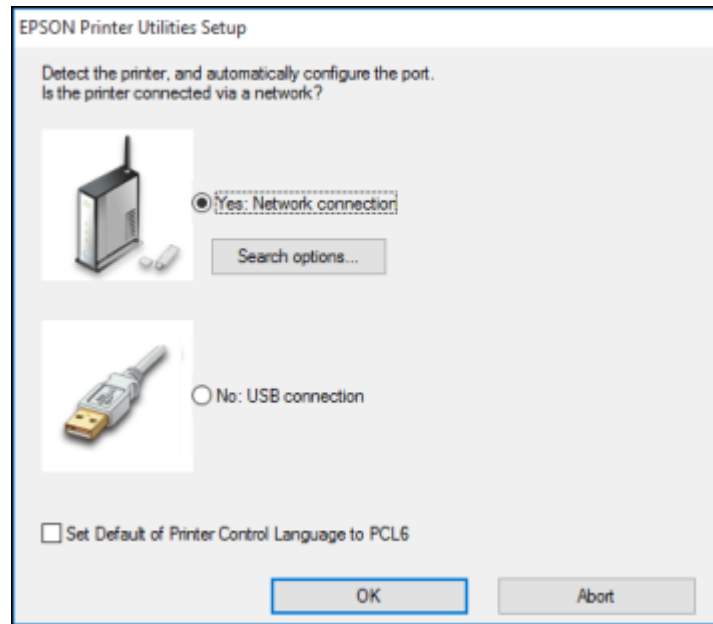

4. Select **Yes: Network connection** and click **OK**.

Note: Select the **Set Default of Printer Control Language to PCL6** checkbox if you want to set the default printer language to PCL6. Leave this option deselected to set the printer language to ESC/P-R. (You can change this setting later as needed.)

After the software finishes searching for products, you see a screen like this:

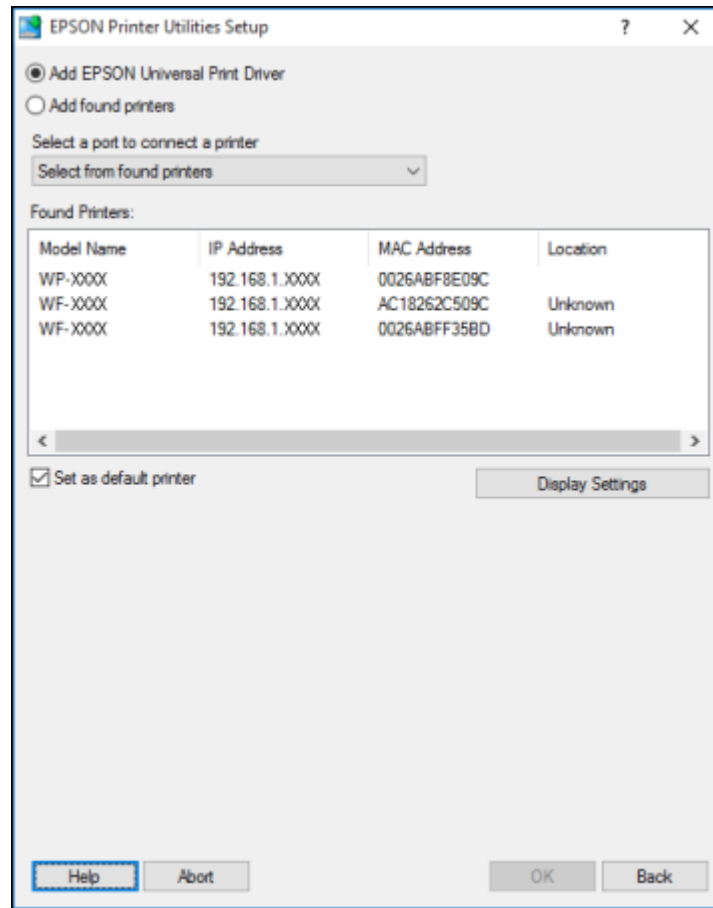

5. Do one of the following:
 - If you are installing one product, make sure **Add EPSON Universal Print Driver** is selected and continue with the next step.
 - If you are installing more than one product, select **Add found printers** and go to step 9.

Note: You can customize and filter your product search results by clicking **Display Settings**.

6. Open the **Select a port to connect a printer** menu and select an existing printer port, if necessary. Otherwise, skip this option to create a new port automatically.
7. Select the product you want to install from the Found Printers list.

Note: Deselect the **Set as default printer** checkbox if you do not want the product to be set as your default printer.

8. Click **OK**, then skip the remaining steps.
9. If you are installing more than one product, select the products from the Found Printers list and click **Add to Printer Folder**.

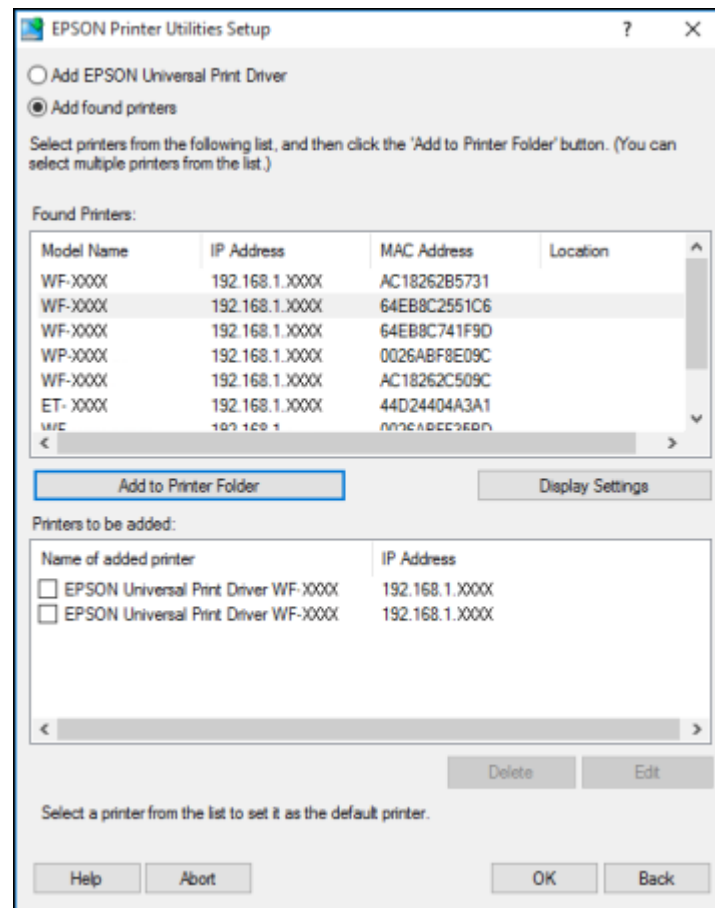

The selected products appear in the lower section of the screen.

10. Select the checkbox next to the product you want to make your default printer, if necessary.
11. Click **OK**.

Parent topic: [Enabling Epson Universal Print Driver \(PCL\) or PostScript Printing](#)

Installing the PostScript (PS3) Printer Software - Windows

If you did not install the standard Epson printer software or Epson Universal Print Driver, you need to install the PostScript (PS3) printer software before you can adjust the print settings and print to your network printer.

Note: Make sure your product is turned on and connected to the same network as your computer before installing the printer software.

1. To download the **Drivers and Utilities Combo Package - PS3 PostScript** file, visit epson.com/support (U.S.), epson.ca/support (Canada), or epson.com.jm/support (Caribbean) and select your product.
2. Double-click the downloaded package.
3. Click **OK**.
4. Click **Accept**.
5. Click **Install**.
6. Click **Next** and follow the on-screen instructions.

Parent topic: [Enabling Epson Universal Print Driver \(PCL\) or PostScript Printing](#)

Installing the PostScript (PS3) Printer Software - Mac

If you did not install the standard Epson printer software, you need to install the PostScript (PS3) printer software before you can adjust the print settings and print to your network printer.

Note: Make sure your product is turned on and connected to the same network as your computer before installing the printer software.

1. To download the **Drivers and Utilities Combo Package - PS3 PostScript** file, visit epson.com/support (U.S.), epson.ca/support (Canada), or epson.com.jm/support (Caribbean) and select your product.
2. Double-click the downloaded package.

3. Double-click **EPSON**.
4. Click **Continue** on the next two screens.
5. Click **Agree**.
6. Click **Install**.
7. If necessary, enter the administrator password.
8. Click **Start** and follow the on-screen instructions.

Parent topic: [Enabling Epson Universal Print Driver \(PCL\) or PostScript Printing](#)

Selecting PDL (Page Description Language) Settings

You can select settings for PCL and PostScript printing using the control panel on the product.

Note: These settings can be locked by an administrator. If you cannot access these settings, contact your administrator for assistance.

1. Press the  home button, if necessary.
2. Select **Settings**.
3. Select **General Settings**.

You see a screen like this:



4. Select **Printer Settings**.

You see a screen like this:

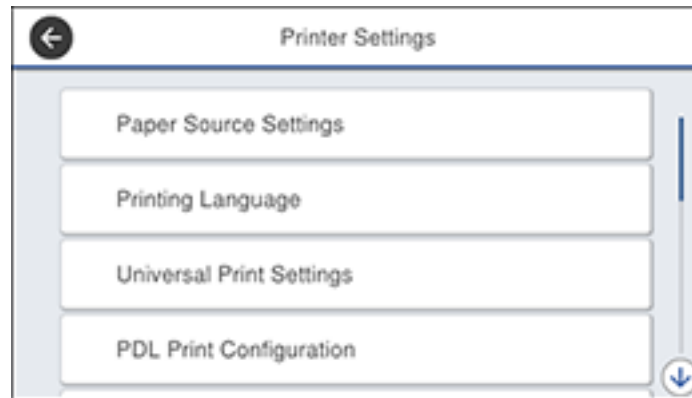

5. Select **PDL Print Configuration**.

You see a screen like this:



6. Select one of the options shown above, then select the PDL print configuration options you want to use.
7. When you are finished, press the  home button to exit.

[PDL Print Configuration Options](#)

Parent topic: [Enabling Epson Universal Print Driver \(PCL\) or PostScript Printing](#)

PDL Print Configuration Options

Select the **PDL Print Configuration** options you want to use for PCL or PostScript printing.

PDL Print Configuration option	Available settings	Description
Common Settings		
Paper Size	Various sizes	Sets the default paper size for PCL or PostScript printing
Paper Type	Various paper types	Sets the default paper type for PCL or PostScript printing
Orientation	Portrait	Sets the default orientation for PCL or PostScript printing
	Landscape	
Quality	Draft	Sets the quality for PCL or PostScript printing
	Standard	
	Best	
Ink Save Mode	On/Off	Saves ink by reducing print density
Print Order	Last Page on Top	Starts printing from the first page of a file
	First Page on Top	Starts printing from the last page of a file
Number of Copies	1 to 999	Selects the number of copies to print
Binding Margin	Left Edge	Specifies the binding edge for double-sided documents
	Top Edge	
Auto Paper Ejection	On/Off	Ejects paper automatically when printing is stopped during a print job
2-Sided Printing	On/Off	Selects duplex printing
PCL Menu		
Font Source	Resident	Uses a font preinstalled on the printer
	Download	Uses a font you have downloaded

PDL Print Configuration option	Available settings	Description
Font Number	1 to 111	Selects the default font number for the default font source
Pitch	0.44 to 99.99 cpi	Selects the default font pitch if the font is scalable and fixed-pitch (availability depends on font source and number settings)
Height	4.00 to 999.75 pt	Selects the default font height if the font is scalable and proportional (availability depends on font source and number settings)
Symbol Set	Various	Selects the default symbol set. If the selected font is not available for the selected symbol set, the font source and number are replaced with IBM-US (the default setting).
Form	5 to 128 lines	Sets the number of lines for the selected paper size and orientation. Changes the line spacing (VMI) stored in the printer. Later changes in page size or orientation cause changes in the Form value based on the stored VMI.
CR Function	CR	Selects the carriage return and line feed commands when printing with a driver from a specific operating system
	CR+LF	
LF Function	LF	
	CR+LF	
Paper Source Assign	4	Makes the paper source select command compatible with HP LaserJet 4
	4K	Makes the paper source select command compatible with HP LaserJet 4000, 5000, and 8000
	5S	Makes the paper source select command compatible with HP LaserJet 5S
PS3 Menu		
Error Sheet	On/Off	Prints a sheet showing the status when errors occur during PostScript or PDF printing

PDL Print Configuration option	Available settings	Description
Coloration	Color	Selects the color mode for PostScript printing
	Mono	
Binary	On/Off	Enable when printing files that contain binary images (available when the product is connected to the network). Allows you to print binary images even if the driver is set to ASCII.
PDF Page Size	Various sizes	Selects the paper size when printing a PDF file. If Auto is selected, the paper size is determined based on the size of the first page.

Parent topic: [Selecting PDL \(Page Description Language\) Settings](#)

Selecting Printer Language and Interface Settings

You can select printer language and interface settings using the control panel on the product.

Note: These settings can be locked by an administrator. If you cannot access these settings, contact your administrator for assistance.

1. Press the  home button, if necessary.
2. Select **Settings**.
3. Select **General Settings**.

You see a screen like this:



4. Select **Printer Settings**.

You see a screen like this:

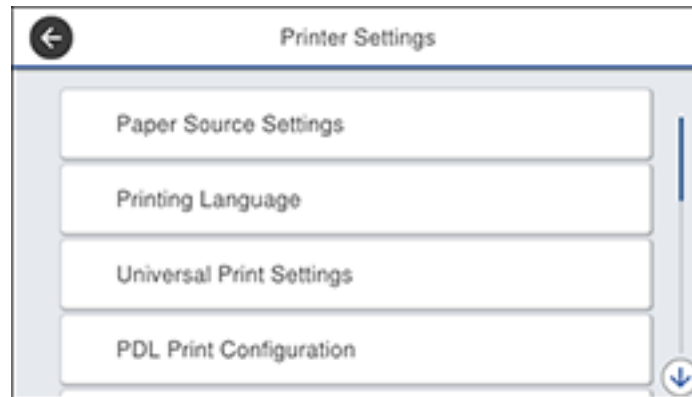

5. Select **Printing Language**.
6. Select the printing language and interface options for your connection type.
7. When you are finished, press the  home button to return to the Home screen.

[Printing Language and Interface Options](#)

Parent topic: [Enabling Epson Universal Print Driver \(PCL\) or PostScript Printing](#)

Printing Language and Interface Options

Select the printing language and interface options you want to use.

Option	Available settings	Description
USB I/F Timeout Setting	0.5 to 300 seconds	Specify the length of time before ending USB communication from a computer using the PCL or PostScript driver. This setting is necessary to avoid endless USB communication.
Printing Language	Auto	Select the printing language for the USB or network interface, or select Auto to automatically detect the language
	PCL	
	PS3	
	PDF	
PC Connection via USB	Enable	Select whether to allow a USB connection between a PC and the product
	Disable	

Parent topic: [Selecting Printer Language and Interface Settings](#)

Printing a PCL or PS3 (PostScript) Status Sheet

You can print a PCL or PS3 (PostScript) status sheet to confirm the current font information.

1. Press the  home button, if necessary.
2. Select **Settings**.

You see a screen like this:

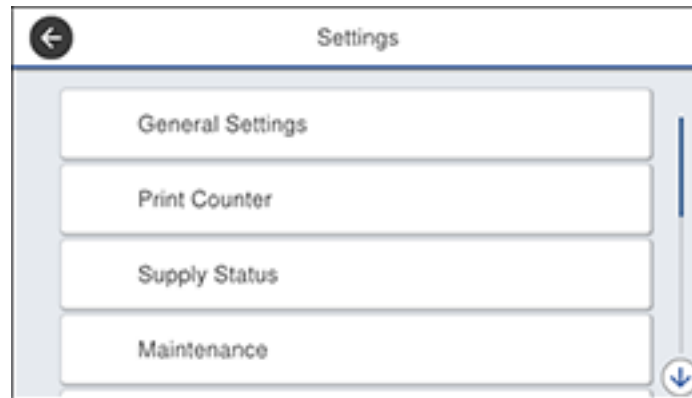

3. Scroll down and select **Print Status/Print**.
4. Select **Print Status Sheet**.
5. Select **PCL Font List** or **PS3 Font List**.
6. Select **Print** to print the status sheet.

Parent topic: [Enabling Epson Universal Print Driver \(PCL\) or PostScript Printing](#)

Loading Paper

Before you print, load paper for the type of printing you will do.

Note: Load only plain paper when printing with the PCL or PostScript (PS3) printer software (WF-C5790).

[Installing the Optional Paper Cassette Unit](#)

[Loading Paper in the Cassette](#)

[Loading Paper or Envelopes in the Rear Paper Feed Slot](#)

[Paper Loading Capacity](#)

[Double-sided Printing Capacity](#)

[Compatible Epson Papers](#)

[Paper or Media Type Settings - Printing Software](#)

[Selecting the Paper Settings for Each Source - Control Panel](#)

[Selecting Default Paper Settings - Administrator](#)

Installing the Optional Paper Cassette Unit

You can install an optional paper cassette unit to provide more paper capacity.

1. Turn off the product, and unplug the power cord and any connected cables.

Warning: To avoid electric shock, make sure you unplug the power cord.

2. Remove the paper cassette unit from its packaging and remove any protective materials.

3. Lift up your product and gently lower it onto the paper cassette unit with the corners aligned.

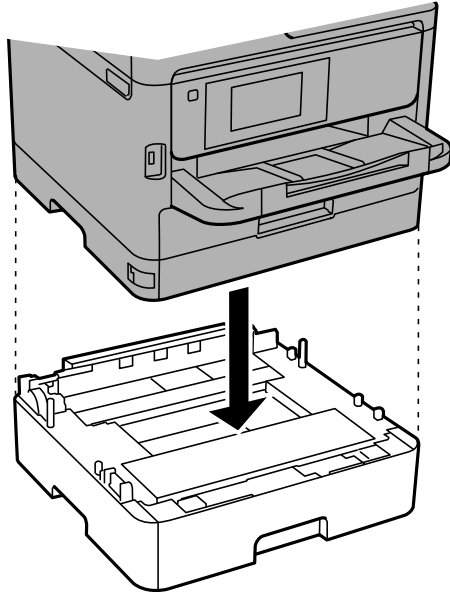

Warning: To lift the product, have two people hold it as shown here. Lifting from other areas may cause the product to fall or cause you to pinch your fingers when placing the product down.

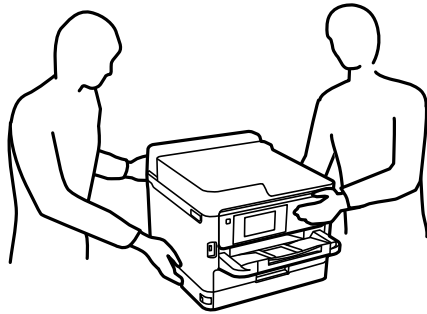

4. Place the cassette number sticker on the cassette unit.

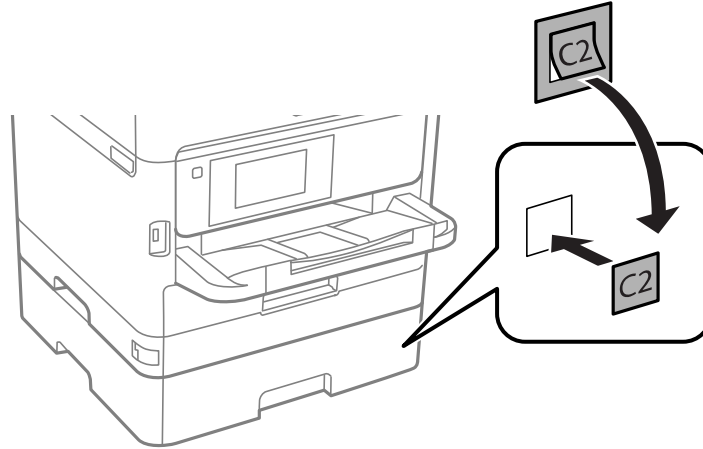

5. Connect the power cord and other connection cables, then plug in the product.
6. Turn on the product.
7. Pull out and reinsert the paper cassette in the optional paper cassette unit, and confirm that the cassette unit number appears on the screen.
8. Enable the optional paper cassette unit in the product software.

[Enabling the Optional Paper Cassette - Windows](#)

[Enabling the Optional Paper Cassette - Mac](#)



Parent topic: [Loading Paper](#)

Enabling the Optional Paper Cassette - Windows

You need to enable the optional paper cassette unit before you can use it with the printer software.

Note: If you are using the Epson Universal Print Driver or PostScript (PS3) printer software, see the link below to enable the optional cassette unit.

1. Do one of the following:
 - **Windows 10:** Click  and select  (Settings) > **Devices** > **Printers & scanners**. Select your product name and select **Manage** > **Printer properties**.

- **Windows 8.x:** Navigate to the **Apps** screen and select **Control Panel > Hardware and Sound > Devices and Printers**. Right-click your product name and select **Printer properties**.
- **Windows 7:** Click  and select **Devices and Printers**. Right-click your printer name and select **Printer properties**.
- **Windows Vista:** Click  and select **Control Panel**. Click **Printer** under **Hardware and Sound**, then right-click your printer name and select **Properties**.

2. Click the **Optional Settings** tab.

You see a window like this:

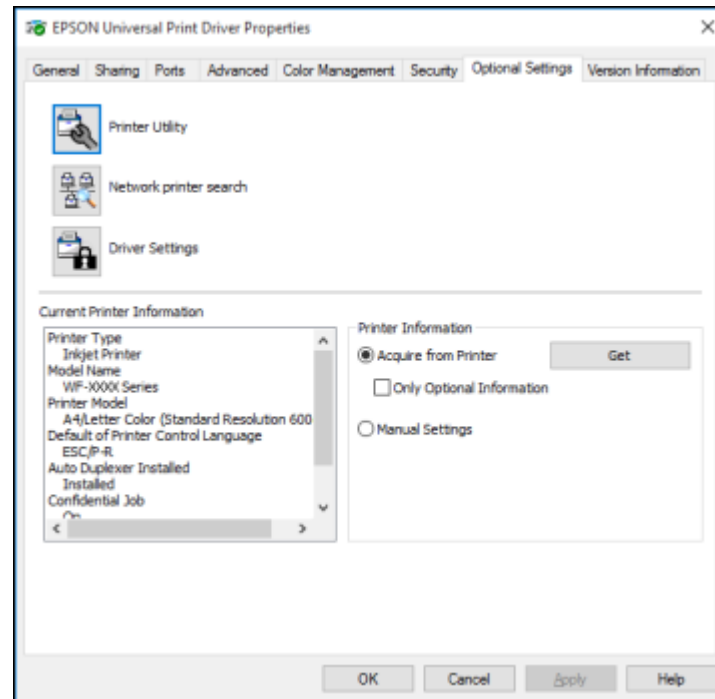

3. Make sure **Acquire from Printer** is selected, then click **Get**.

The optional paper sources are listed in the Current Printer Information section.

4. Click **OK**.

The optional paper cassette is now enabled.

Parent topic: [Installing the Optional Paper Cassette Unit](#)

Related tasks

[Enabling the Optional Paper Cassettes - PostScript Printer Software - Windows](#)

Enabling the Optional Paper Cassette - Mac

You need to enable the optional paper cassette unit before you can use it with the printer software.

Note: If you are using the PostScript (PS3) printer software, see the link below to enable the optional cassette unit.

1. In the Apple menu or the Dock, select **System Preferences**.
2. Select **Print & Fax**, **Print & Scan**, or **Printers & Scanners**, select your product, and select **Options & Supplies**.
3. Select **Driver** or **Options**.

You see a screen like this:

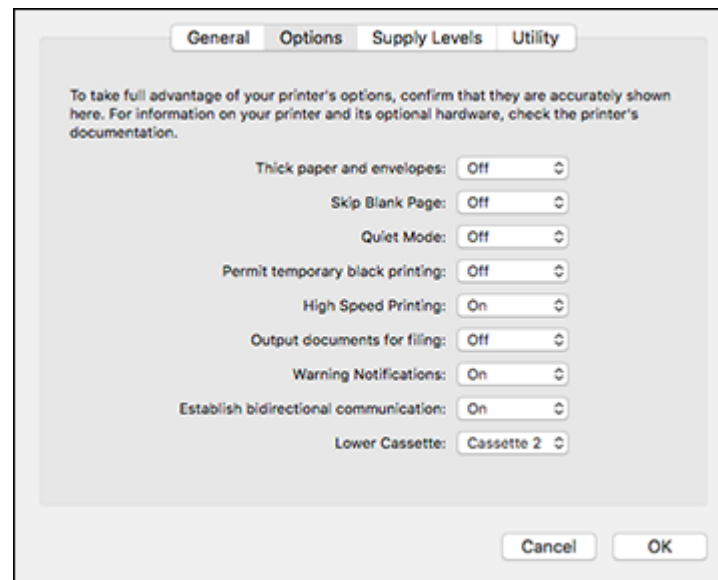

4. Select the optional cassette unit you installed as the **Lower Cassette** setting.

5. Click **OK**.

The optional paper cassette is now enabled.

Parent topic: [Installing the Optional Paper Cassette Unit](#)

Related tasks

[Enabling the Optional Paper Cassettes - PostScript Printer Software - Mac](#)

Loading Paper in the Cassette

You can load paper up to this size in the paper cassette: Legal (8.5 × 14 inches [216 × 356 mm])

Note: If the optional paper cassette unit is installed, do not remove more than one cassette at a time.

1. Make sure the product is not operating and pull out the paper cassette.

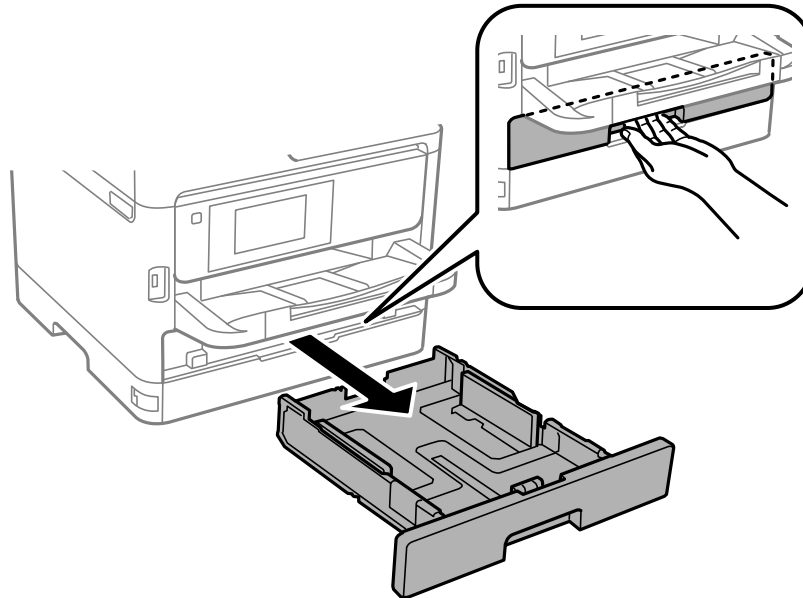

2. Slide the front edge guide outward all the way, then slide the side edge guides to the paper size you are using.

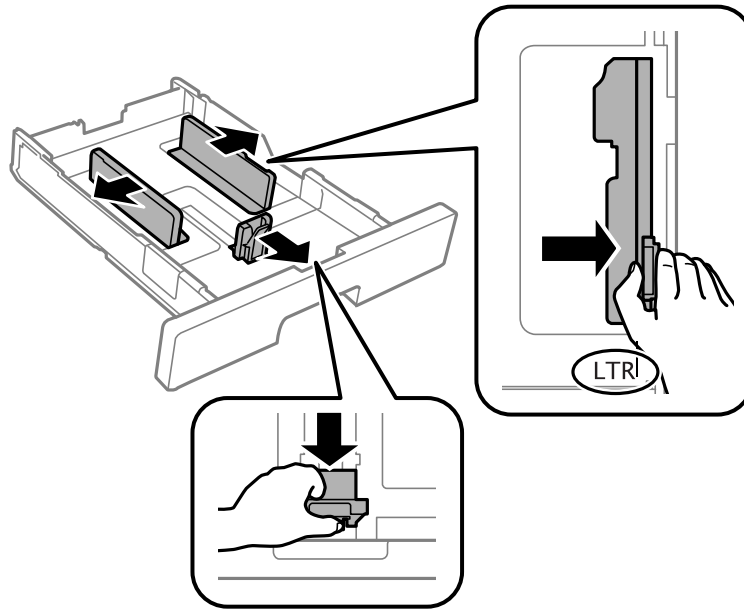

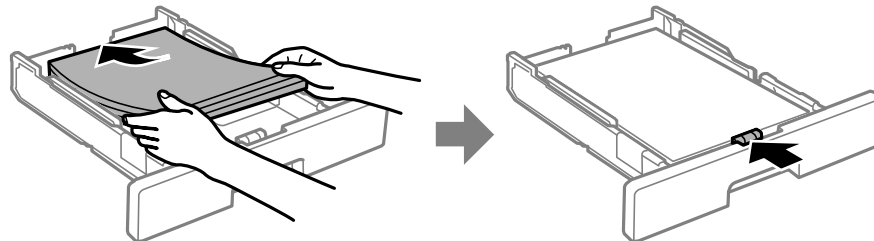

3. Load paper with the printable side facedown and slide the front edge guide against the paper.

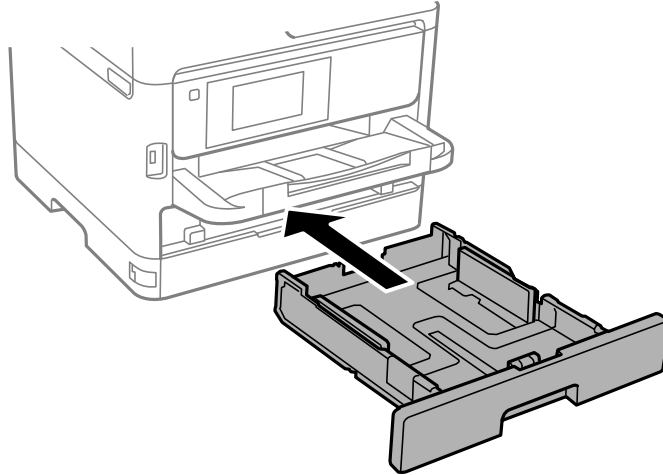

Note: Make sure the paper fits beneath the arrow mark inside the edge guides.

4. Insert the paper cassette all the way into the product.



5. Do one of the following:
 - Select the size and type of paper you loaded on the LCD screen.
 - Press the  **Paper Setting** button and select the paper source, then select the size and type of paper you loaded.
 - Select the size and type of paper you loaded in the **Settings > General Settings > Printer Settings > Paper Source Settings > Paper Setup** menu.

Always follow these paper loading guidelines:

- Load only the recommended number of sheets.
- Load paper short edge first, no matter which way your document faces.
- Load the printable side facedown.
- Load letterhead or pre-printed paper top edge first.
- Do not load paper above the line underneath the arrow mark inside the edge guides.
- Check the paper package for any additional loading instructions.

Parent topic: [Loading Paper](#)

Related references

[Paper Loading Capacity](#)

Related tasks

[Loading Paper or Envelopes in the Rear Paper Feed Slot](#)

Loading Paper or Envelopes in the Rear Paper Feed Slot

You can print envelopes or documents in a variety of paper types and sizes in the rear paper feed slot.

1. Open the feeder guard and pull up the paper support.

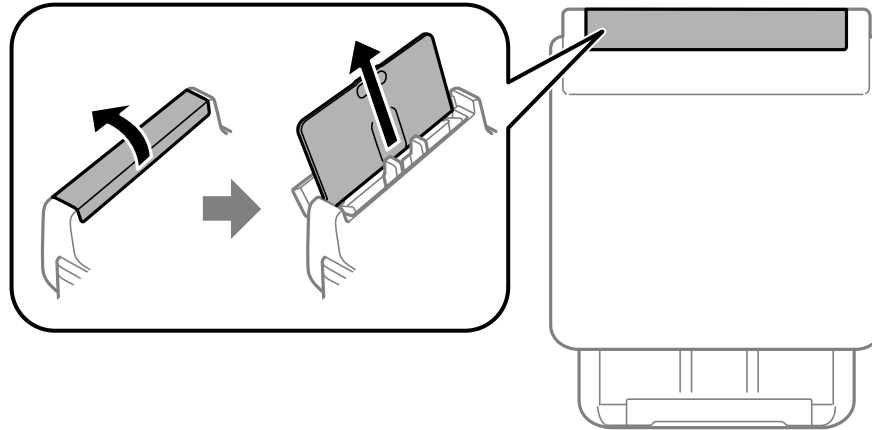

2. Slide the edge guides outward.

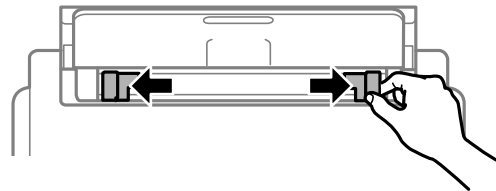

3. If you are inserting a stack of paper, fan the sheets and tap the stack on a flat surface to even the edges.

Note: You can load one sheet of binder paper with holes on one of the long edges as shown. Do not select automatic 2-sided printing for this type of paper.

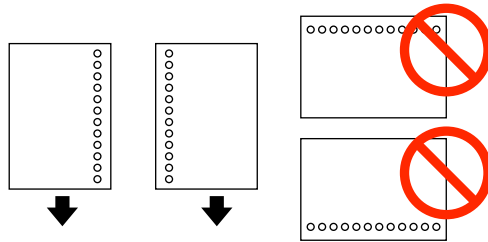

4. Do one of the following:

- Insert paper, glossy or printable side up and short edge first, in the center of the slot.

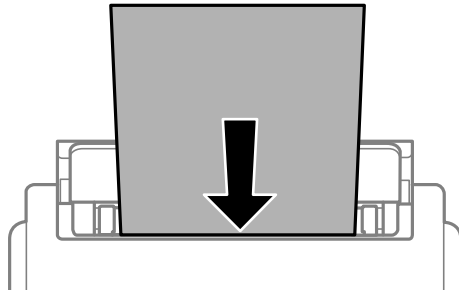

Caution: To prevent paper feeding problems, make sure you do not load paper above the arrow marks inside the edge guides.

- Load envelopes short edge first, with the flap facing down and the flap edge to the left, in the center of the slot.

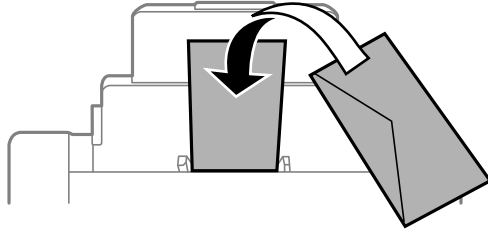

5. Slide the edge guides against the paper or envelopes, but not too tightly.

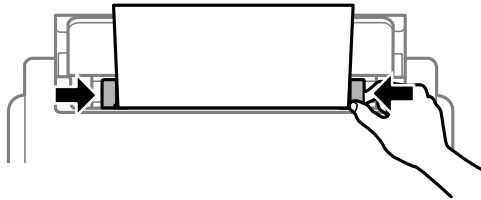

6. Extend the output tray.

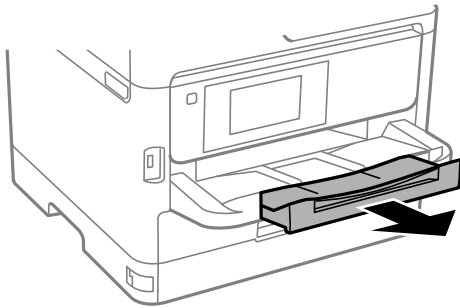

7. Do one of the following:
 - Select the size and type of paper you loaded on the LCD screen.

- Press the  **Paper Setting** button and select the paper source, then select the size and type of paper you loaded.
- Select the size and type of paper you loaded in the **Settings > General Settings > Printer Settings > Paper Source Settings > Paper Setup** menu.

Always follow these paper loading guidelines:

- Load only the recommended number of sheets.
- Load paper short edge first, no matter which way your document faces.
- Load the printable side faceup.
- Load letterhead or pre-printed paper top edge first.
- Do not load paper above the line under the arrow mark inside the edge guides.
- If you have trouble loading a stack of envelopes, press each envelope flat before loading it or load one envelope at a time.
- If print quality declines when printing multiple envelopes, try loading one envelope at a time.
- Do not load envelopes that are curled, folded, or too thin.
- Do not load windowed envelopes or envelopes with adhesive surfaces on the flaps.
- Check the paper package for any additional loading instructions.

Parent topic: [Loading Paper](#)

Related references



[Paper Loading Capacity](#)

Related tasks

[Loading Paper in the Cassette](#)

Paper Loading Capacity

As described in the tables below, do not load paper in the paper cassettes above the arrow marks on these stickers inside the cassette:

- Use this guide for standard paper: 
- Use this guide for thick paper: 

Standard and Thick Paper Capacity

You can load up to the following number of sheets in the rear paper feed slot:

- 80 sheets of standard paper; load only 1 sheet of paper in a user-defined size between 14 inches (355.6 mm) and 236 inches (6000 mm) long
- 30 sheets of thick paper (24 to 68 lb [91 to 256 g/m²]); load only 1 sheet of thick paper in a user-defined size between 14 inches (355.6 mm) and 44 inches (1117.6 mm) long (available only when printing from a computer)
- 10 envelopes

Paper type	Paper size	Loading capacity	
		Cassette 1	Cassette 2 (optional)
Plain paper Letterhead paper Recycled paper Colored paper	Supported paper sizes* User defined (4 × 5.8 inches [100 × 148 mm] to 8.5 × 14 inches [216 × 355.6 mm])	Up to the arrow mark on the cassette sticker	
Pre-printed paper High-quality plain paper	User defined (2.5 × 5 inches [64 × 127 mm] to 3.5 × 5 inches [89 × 127 mm]) User defined (8.5 × 14 to 236 inches [216 × 355.6 to 6000 mm])	—	—
	User defined (3.5 × 5 inches [89 × 127 mm] to 4 × 5.8 inches [100 × 148 mm])	Up to the arrow mark on the cassette sticker	—
Envelopes	#10	10	—

Paper type	Paper size	Loading capacity	
		Cassette 1	Cassette 2 (optional)
Thick paper (24 to 43 lb [91 to 160 g/m ²])	Supported paper sizes* User defined (4 × 5.8 inches [100 × 148 mm] to 8.5 × 14 inches [216 × 355.6 mm])	90	250
	User defined (3.5 × 5 inches [89 × 127 mm] to 4 × 5.8 inches [100 × 148 mm])	90	—
	User defined (2.5 × 5 inches [64 × 127 mm] to 3.5 × 5 inches [89 × 127 mm]) User defined (8.5 × 14 to 44 inches [216 × 355.6 to 1117.6 mm])	—	—

* Select the paper specification link below to view the list of supported paper sizes.

Note: Half Letter size is not available when printing with the PostScript printer driver (WF-C5790).

Epson Paper Capacity

Paper type	Loading capacity		
	Cassette 1	Cassette 2 (optional)	Rear paper feed slot
Epson Bright White Paper	200 sheets	400 sheets	50 sheets
Epson Presentation Paper Matte	80 sheets	—	70 sheets

Paper type	Loading capacity		
	Cassette 1	Cassette 2 (optional)	Rear paper feed slot
Epson Photo Paper Glossy Epson Premium Photo Paper Glossy Epson Premium Photo Paper Semi-gloss Epson Ultra Premium Photo Paper Glossy Epson Premium Presentation Paper Matte	50 sheets	—	20 sheets
Epson Premium Presentation Paper Matte Double-sided	20 sheets	—	20 sheets

Note: When printing at a user defined size on genuine Epson paper, you can only print at **Standard** or **Normal** print quality. Even if the print driver allows you to choose a better print quality, the printer will print using **Standard** or **Normal** print quality.

Parent topic: [Loading Paper](#)

Related references

[Paper Specifications](#)

Double-sided Printing Capacity

Automatic Double-sided Printing

You can automatically print double-sided from any paper source on the following sizes of standard and thick papers (up to 43 lb [160 g/m²]):

- Letter (8.5 × 11 inches [216 × 279 mm])
- A4 (8.3 × 11.7 inches [210 × 297 mm])
- Executive (7.25 × 10.5 inches [184 × 267 mm])
- A5 (5.8 × 8.2 inches [148 × 210 mm])

- B5 (7.2 × 10.1 inches [182 × 257 mm])

Manual Double-sided Printing

You can use the rear paper feed to manually print double-sided pages on the following papers:

Paper type	Size	Manual Double-sided Printing Capacity
Plain paper	Supported paper sizes ¹	30 sheets
Copier paper	User defined (8.5 × 14 to 236 inches [216 × 355.6 to 6000 mm]) ²	1 sheet
Letterhead paper		
Recycled paper		
Colored paper		
Pre-printed paper		
High quality plain paper		
Epson Bright White Paper	Letter (8.5 × 11 inches [216 × 279 mm])	30 sheets
Epson Premium Presentation Paper Matte Double-sided	Letter (8.5 × 11 inches [216 × 279 mm])	1 sheet
Thick paper 1 (25 to 43 lb [91 to 160 g/m ²])	Supported paper sizes ¹	5 sheets
Thick paper 2 (43 to 68 lb [161 to 256 g/m ²])	User defined (8.5 × 14 to 44 inches [216 × 355.6 to 1117.6 mm]) ²	1 sheet

¹: Use the paper specification link below to view the list of supported paper sizes.

²: Only available when printing from a computer.

Parent topic: [Loading Paper](#)

Related references

[Paper Specifications](#)

Compatible Epson Papers

You can purchase genuine Epson ink, maintenance boxes, and paper at epson.com (U.S. sales), epson.ca (Canadian sales), or epson.com.jm (Caribbean sales). You can also purchase supplies from

an Epson authorized reseller. To find the nearest one, call 800-GO-EPSON (800-463-7766) in the U.S. or 800-807-7766 in Canada.

Note: Paper/media availability varies by country.

Paper Type	Size	Part number	Sheet count
Epson Bright White Paper	Letter (8.5 × 11 inches [216 × 279 mm])	S041586	500
Epson Presentation Paper Matte	Legal (8.5 × 14 inches [216 × 356 mm])	S041067	100
	Letter (8.5 × 11 inches [216 × 279 mm])	S041062	100
Epson Premium Presentation Paper Matte	8 × 10 inches (203 × 254 mm)	S041467	50
	Letter (8.5 × 11 inches [216 × 279 mm])	S041257 S042180	50 100
Epson Premium Presentation Paper Matte Double-sided	Letter (8.5 × 11 inches [216 × 279 mm])	S041568	50
Epson Photo Paper Glossy	4 × 6 inches (102 × 152 mm)	S041809 S042038	50 100
	Letter (8.5 × 11 inches [216 × 279 mm])	S041141	20
		S041649 S041271	50 100
Epson Premium Photo Paper Glossy	4 × 6 inches (102 × 152 mm)	S041727	100
	5 × 7 inches (127 × 178 mm)	S041464	20
	8 × 10 inches (203 × 254 mm)	S041465	20
	Letter (8.5 × 11 inches [216 × 279 mm])	S042183	25
		S041667	50
11 × 14 inches (279 × 356 mm)	S041466	20	

Paper Type	Size	Part number	Sheet count
Epson Ultra Premium Photo Paper Glossy	4 × 6 inches (102 × 152 mm)	S042181	60
		S042174	100
	5 × 7 inches (127 × 178 mm)	S041945	20
	8 × 10 inches (203 × 254 mm)	S041946	20
Epson Premium Photo Paper Semi-gloss	Letter (8.5 × 11 inches [216 × 279 mm])	S042182	25
		S042175	50
Epson Premium Photo Paper Semi-gloss	4 × 6 inches (102 × 152 mm)	S041982	40
	Letter (8.5 × 11 inches [216 × 279 mm])	S041331	20

Parent topic: [Loading Paper](#)

Paper or Media Type Settings - Printing Software

For this paper	Select this paper Type or Media Type setting
Plain paper Epson Bright White Paper	Plain Paper / Bright White Paper
High-quality plain paper	High-Quality Plain Paper
Letterhead paper	Letterhead
Recycled paper	Recycled
Colored paper	Color
Pre-printed paper	Preprinted
Envelopes	Envelope
Epson Ultra Premium Photo Paper Glossy	Ultra Premium Photo Paper Glossy
Epson Premium Photo Paper Glossy	Premium Photo Paper Glossy
Epson Photo Paper Glossy	Photo Paper Glossy
Epson Premium Photo Paper Semi-gloss	Premium Photo Paper Semi-Gloss

For this paper	Select this paper Type or Media Type setting
Epson Presentation Paper Matte Epson Premium Presentation Paper Matte Epson Premium Presentation Paper Matte Double-sided	Premium Presentation Paper Matte
Thick paper (25 to 43 lb [91 to 160 g/m ²])	Card Stock 1
Thick paper (43 to 68 lb [161 to 256 g/m ²])	Card Stock 2

Note: The settings listed here are available only when printing from your computer; they do not apply to your product's control panel settings.

Parent topic: [Loading Paper](#)

Selecting the Paper Settings for Each Source - Control Panel

You can change the default paper size and paper type for each source using the control panel on the product.

1. Press the  **Paper Setting** button.

You see a screen like this:

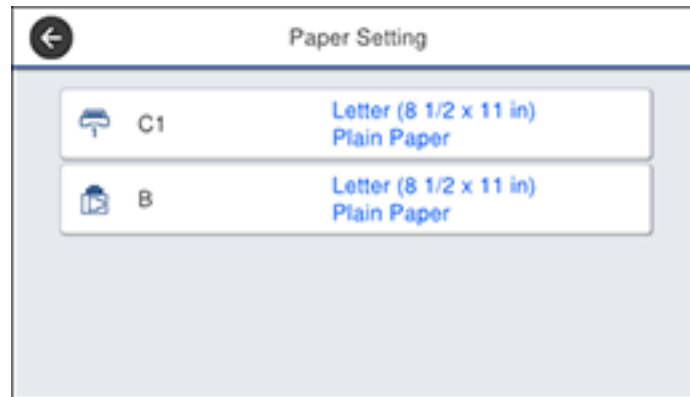

2. Select the paper source you want to select settings for.

You see a screen like this:

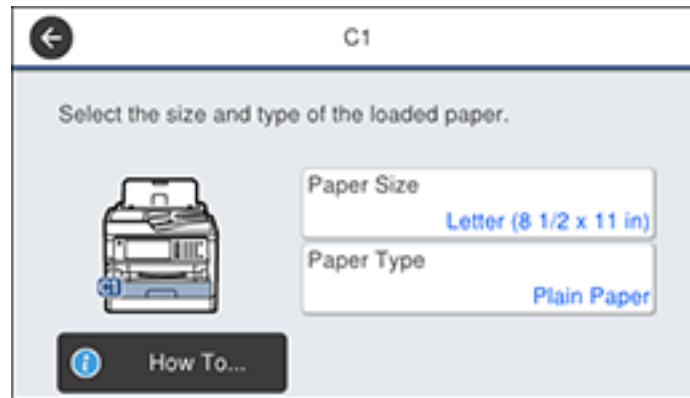

3. Select **Paper Size**.
4. Select the paper size you loaded.
5. Select **Paper Type**.
6. Select the paper type for the paper you loaded.
7. Select the back arrow to select another paper source or press the  home button to exit.

[Paper Type Settings - Control Panel](#)

Parent topic: [Loading Paper](#)

Paper Type Settings - Control Panel

Select a **Paper Type** setting that matches the paper you loaded.

Paper type loaded	Paper Type setting
Plain paper	Plain Paper
Epson Bright White Paper	
Letterhead paper	Letterhead
Recycled paper	Recycled
Colored paper	Color

Paper type loaded	Paper Type setting
Pre-printed paper	Preprinted
High-quality plain paper	High Quality Plain Paper
Envelopes	Envelope
Epson Ultra Premium Photo Paper Glossy	Ultra Glossy
Epson Premium Photo Paper Glossy	Prem. Glossy
Epson Photo Paper Glossy	Glossy
Epson Premium Photo Paper Semi-gloss	Prem. Semi-Gloss
Epson Presentation Paper Matte Epson Premium Presentation Paper Matte Epson Premium Presentation Paper Matte Double-sided	Prem. Matte
Thick paper up to 25 to 43 lb (91 to 160 g/m ²)	Card Stock 1
Thick paper up to 43 to 68 lb (161 to 256 g/m ²)	Card Stock 2

Parent topic: [Selecting the Paper Settings for Each Source - Control Panel](#)

Selecting Default Paper Settings - Administrator

As an administrator, you can adjust default paper settings that apply to all print jobs sent to the product.

Note: These settings can be locked by an administrator. If you cannot access these settings, contact your administrator for assistance.

[Selecting the Default Printer Settings](#)

[Selecting the Universal Print Settings](#)

Parent topic: [Loading Paper](#)

Selecting the Default Printer Settings

You can change default printer settings using the control panel on the product.

Note: These settings can be locked by an administrator. If you cannot access these settings, contact your administrator for assistance.

1. Press the  home button, if necessary.
2. Select **Settings**.
3. Select **General Settings**.

You see a screen like this:



4. Select **Printer Settings**.

You see a screen like this:

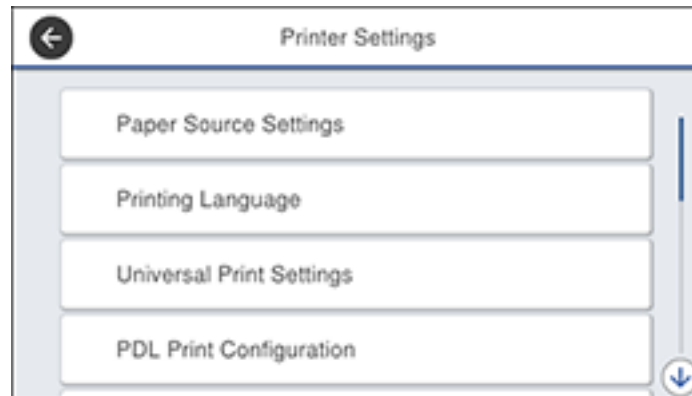

5. Select one of these options for the **Auto Error Solver** setting:
 - Turn on this setting to display a warning and print single-sided when a 2-sided printing error occurs, or to print only what the printer could process when a full memory error occurs.
 - Turn off this setting to display an error message and stop printing if an error occurs.
6. Select **Paper Source Settings**.
7. Select the Paper Source Settings options you want to use.
8. When you are finished, press the  home button to exit.

[Paper Source Settings Options](#)

Parent topic: [Selecting Default Paper Settings - Administrator](#)

Paper Source Settings Options

Select the paper source options you want to use for your print jobs.

Paper Source Settings option	Available settings	Description
Paper Setting	Various	Select the paper size and type for each paper source
Rear Paper Feed Priority	On	Select On to give printing priority to paper loaded in the rear paper feed slot
	Off	
A4/Letter Auto Switching	On	Select On to switch the selected paper size to match the loaded paper (Letter or A4) if the wrong size is selected
	Off	
Auto Select Settings	Copy	Select On for any of these settings to automatically print on paper from any source containing paper that matches your paper settings
	Fax	
	Other	
Error Notice	Paper Size Notice	Select On for either of these settings to display an error message when the selected paper type or size does not match the loaded paper
	Paper Type Notice	
Paper Setup Auto Display	On	Select On to automatically display a menu that lets you select the paper size and type when you load paper in the product Note: If you disable this setting, you will not be able to print using AirPrint.
	Off	

Parent topic: [Selecting the Default Printer Settings](#)

Selecting the Universal Print Settings

You can change the default universal print settings using the control panel on the product.

Note: These settings can be locked by an administrator. If you cannot access these settings, contact your administrator for assistance.

1. Press the  home button, if necessary.
2. Select **Settings** > **General Settings** > **Printer Settings** > **Universal Print Settings**.

You see this screen:



3. Adjust the settings as necessary.
4. When you are finished, press the  home button to exit.

[Universal Print Settings Options](#)

Parent topic: [Selecting Default Paper Settings - Administrator](#)

Universal Print Settings Options

Select the universal print setting options you want to use for your print jobs.

Universal Print Settings option	Available settings	Description
Top Offset	—	Adjust the top or left margin
Left Offset		
Top Offset in Back	—	Adjust the top or left margin of the back page when printing double-sided.
Left Offset in Back		
Check Paper Width	On	Select On to check the paper width before printing. This prevents printing beyond the edges of the paper when the paper size settings are incorrect, but may reduce the printing speed.
	Off	
Skip Blank Page	On	Select On to skip printing of blank pages automatically
	Off	

Parent topic: [Selecting the Universal Print Settings](#)

Placing Originals on the Product

Follow the instructions here to place your original documents or photos on the product.

Caution: Do not place anything on top of your product or use its cover as a writing surface to avoid damaging it.

[Placing Originals on the Scanner Glass](#)

[Placing Originals in the Automatic Document Feeder](#)

Placing Originals on the Scanner Glass

You can place originals up to this size on the scanner glass: Letter (8.5 × 11 inches [216 × 279 mm]) or A4 (8.3 × 11.7 inches [210 × 297 mm]).

Note: When originals are placed in the ADF and on the scanner glass, priority is given to the originals in the ADF.

1. Open the document cover.

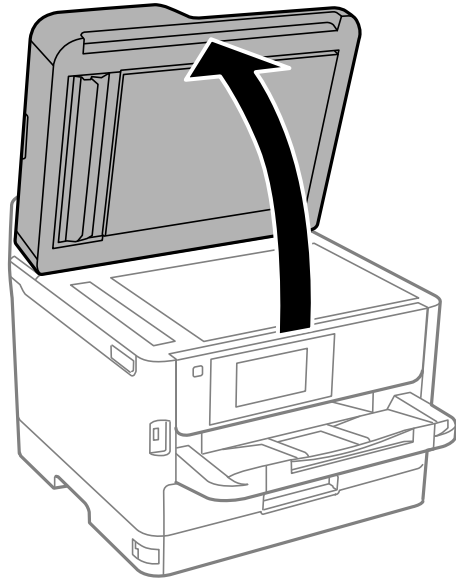

2. Place your original facedown on the scanner glass with the top facing into the corner. Slide the original to the edges of the indicated corner.

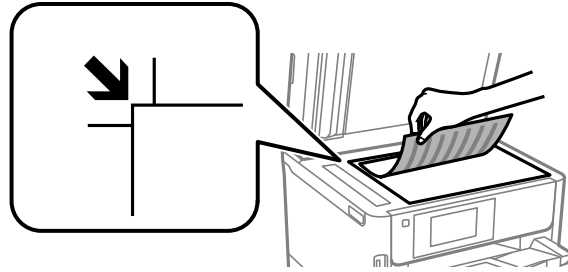

Note: The edges of your original may be cropped by 0.06 inch (1.5 mm) from the edge of the scanner glass. Manually position your original away from the edges to prevent cropping.

3. Close the document cover gently to keep your original in place.

Caution: Do not push down on the document cover or scanner glass or you may damage the product.

Parent topic: [Placing Originals on the Product](#)

Related topics

[Copying](#)

[Scanning](#)

[Faxing](#)

Placing Originals in the Automatic Document Feeder

You can place single- or multi-page original documents in the Automatic Document Feeder (ADF). You can also use the ADF to scan both sides of a 2-sided document. Make sure the originals meet the Automatic Document Feeder specifications before loading them.

Caution: Make sure your originals are not creased or folded, and do not contain holes, staples, tape, or other materials that could obstruct the feeder.

Caution: Do not place photographs or valuable artwork in the ADF. Place fragile or valuable originals on the scanner glass to avoid wrinkling or damaging them.

Note: When originals are placed in the ADF and on the scanner glass, priority is given to the originals in the ADF.

1. Slide the ADF edge guides outward.

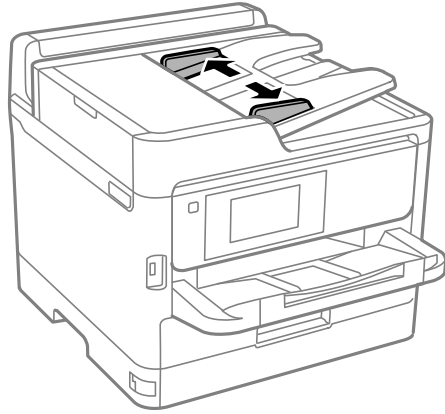

2. Fan your stack of originals and tap them gently on a flat surface to even the edges.

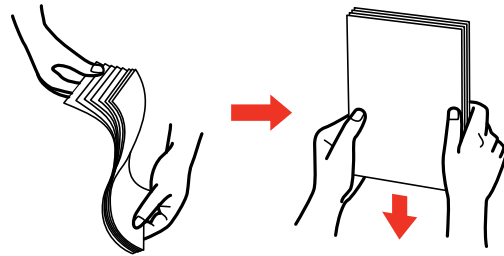

3. Insert the originals into the ADF faceup and top-edge first.

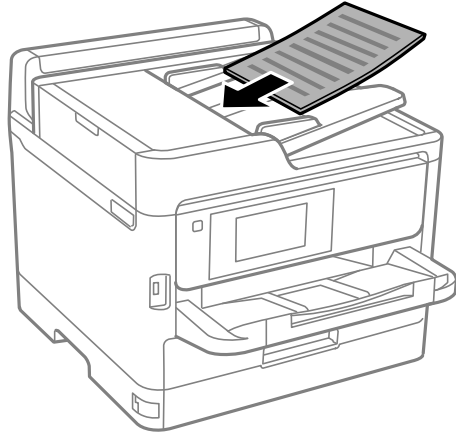

Note: Do not load originals above the arrow mark on the ADF edge guide.

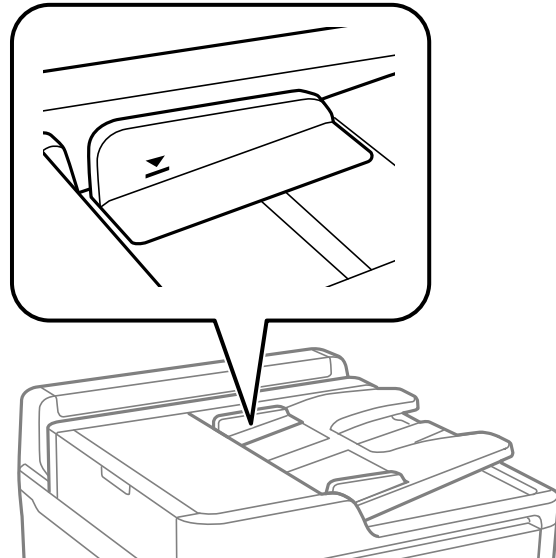

The **ADF** icon on the Copy, Scan, and Fax screens lights up.

4. Slide the ADF edge guides against the originals, but not too tightly.

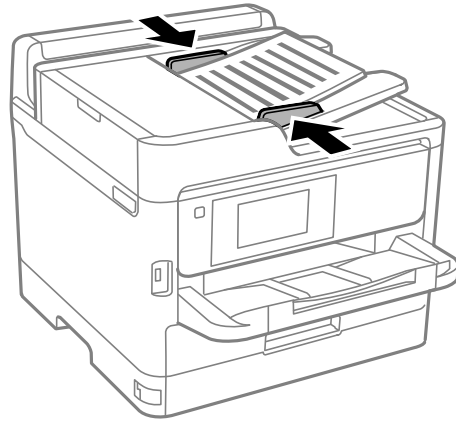

Note: If you are copying two originals onto one sheet, make sure the originals are loaded as shown. Select the link below to select the copy orientation setting that matches how you loaded your original.

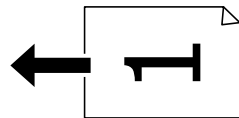
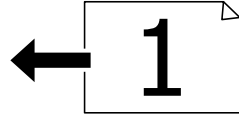

Parent topic: [Placing Originals on the Product](#)

Related references

[Automatic Document Feeder \(ADF\) Specifications](#)

[Copying Options](#)

Related topics

[Copying](#)

Scanning
Faxing

Copying

See the information here to copy documents or photos using your product.

Note: Copies may not be exactly the same size as your originals.

[Copying Documents or Photos](#)

[Copying Options](#)

Copying Documents or Photos

You can copy documents or photos onto various sizes and types of paper, including Epson special papers.

1. Place your original document or photo on the scanner glass, or place multi-page documents in the ADF.
2. Load the paper you want to print on.
3. Press the  home button, if necessary.
4. Select **Copy**.

You see a screen like this:

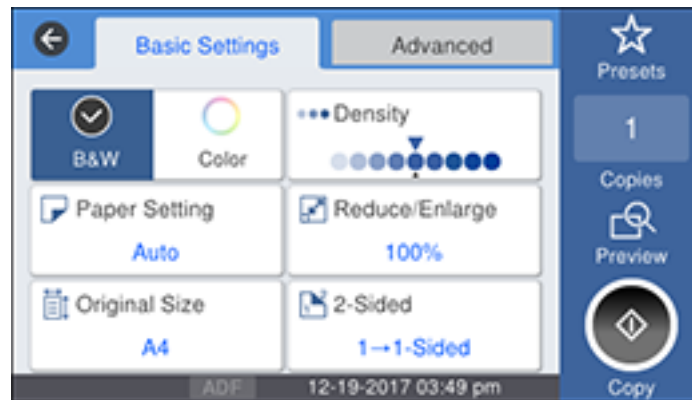

5. To print more than one copy, press a number key on the product's control panel, or select **Copies** and use the displayed keypad to enter the number of copies.

6. Change any of the displayed settings as necessary.
7. Select **Advanced** to view and change additional copy settings, if necessary.
8. Select **Preview** to preview your copy on the LCD screen.
9. Select **Presets** to save your copy settings.

Note: Presets can be locked by an administrator. If you can't access or change this setting, contact your administrator for assistance.

10. When you are ready to copy, press the **Copy** icon.

Note: To cancel printing, press the  stop button or select **Cancel**.

Parent topic: [Copying](#)

Related references

[Copying Options](#)

[Compatible Epson Papers](#)

Related tasks

[Using Presets](#)

[Loading Paper in the Cassette](#)

Related topics

[Placing Originals on the Product](#)

Copying Options

Select the copying options you want to use for your copies.

Note: Not all options or settings may be available, depending on other copying settings.

Basic Settings

Copying option	Available settings	Description
B&W	—	Copies the document in black and white
Color	—	Copies the document in color

Copying option	Available settings	Description
Paper Setting	Various sources	Select the paper source that you want to use. If you select Auto , paper is fed automatically depending on the paper settings you selected for the paper sources.
Original Size	Various sizes	Select the document size of your original
Density	Varying levels	Adjusts the lightness or darkness of copies
Reduce/Enlarge	Auto Fit Page	Automatically sizes the image to fit the paper size you selected
	100%	Copies the original at its full size
	195%→45% and other conversions	Automatically converts from one size to another
	%	Automatically increases or decreases the size of the image by the percentage you enter (range is 25% to 400%)
2-Sided	1>1-Sided	Select to make 2-sided copies. When you select 1>2-Sided or 2>1-Sided , also select the Advanced tab to select the orientation and binding edge for your originals or copies.
	2>2-Sided	
	1>2-Sided	
	2>1-Sided	

Advanced settings

Copying option	Available settings	Description
Multi-Page	Single Page	Copies each page of the original onto an individual sheet
	2-up	Copies multiple page documents onto one sheet. Scroll down and select the document orientation and layout order settings as necessary.
	4-up	
Original Type	Text	Specifies the document type of your originals and adjusts the quality of your copies
	Text & Image	
	Photo	
	Text & Image(Best)	

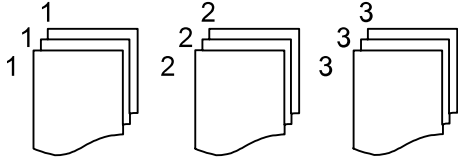
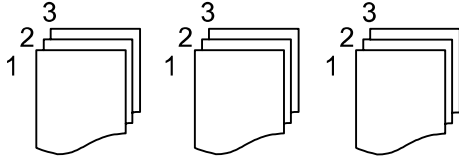
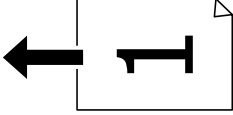
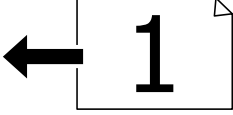
Copying option	Available settings	Description
Finishing	Group (Same Pages)	Select to print multiple copies of a multi-page document in unordered groups 
	Collate (Page Order)	Select to print multiple copies of a multi-page document in ordered sets 
Orientation (Original)	Up Direction	Specifies the orientation of your originals Up Direction: 
	Left Direction	Left Direction: 
Image Quality	Various settings	Select advanced quality settings such as Saturation and Sharpness
Remove Shadow	Off	Select On to erase the shadows that appear in the center of a document when copying a book or that appear around a document when copying thick paper
	On	
Remove Punch Holes	Off	Select On to erase the binding holes on a document
	On	

Copying option	Available settings	Description
ID Card Copy	Off	Select On to copy both sides of an ID card onto one side of a sheet of paper
	On	

Parent topic: [Copying](#)

Printing from a Computer

Before printing from your computer, make sure you have set up your product and installed its software as described on the *Start Here* sheet.

Note: If you have an Internet connection, it is a good idea to check for updates to your product software on Epson's support website. If you see a Software Update screen, select **Enable automatic checking** and click **OK**. The update scans your system to see if you have the latest product software. Follow the on-screen instructions.

[Printing with the Standard Epson Printer Software - Windows](#)

[Printing with the Built-in Epson Driver - Windows 10 S](#)

[Printing with the Epson Standard Printer Software - Mac](#)

[Printing with the Epson Universal Print Driver - Windows](#)

[Printing with the PostScript \(PS3\) Printer Software - Windows](#)

[Printing with the PostScript \(PS3\) Printer Software - Mac](#)

[Cancelling Printing Using a Product Button](#)

Printing with the Standard Epson Printer Software - Windows

You can print with the standard Epson printer software using any Windows printing program, as described in these sections.

[Selecting Basic Print Settings - Windows](#)

[Selecting Double-sided Printing Settings - Windows](#)

[Selecting Additional Layout and Print Options - Windows](#)

[Selecting a Printing Preset - Windows](#)

[Selecting Extended Settings - Windows](#)

[Printing Your Document or Photo - Windows](#)

[Locking Printer Settings - Windows](#)

[Entering a User ID and Password for Printing](#)

[Selecting Default Print Settings - Windows](#)

[Changing Automatic Update Options](#)

Parent topic: [Printing from a Computer](#)

Selecting Basic Print Settings - Windows

Select the basic settings for the document or photo you want to print.

1. Open a photo or document for printing.
2. Select the print command in your application.

Note: You may need to select a print icon on your screen, the **Print** option in the **File** menu, or another command. See your application's help utility for details.

3. If necessary, select your product name as the printer you want to use.

Note: You may also need to select **Properties** or **Preferences** to view your print settings.

You see the **Main** tab of your printer settings window:

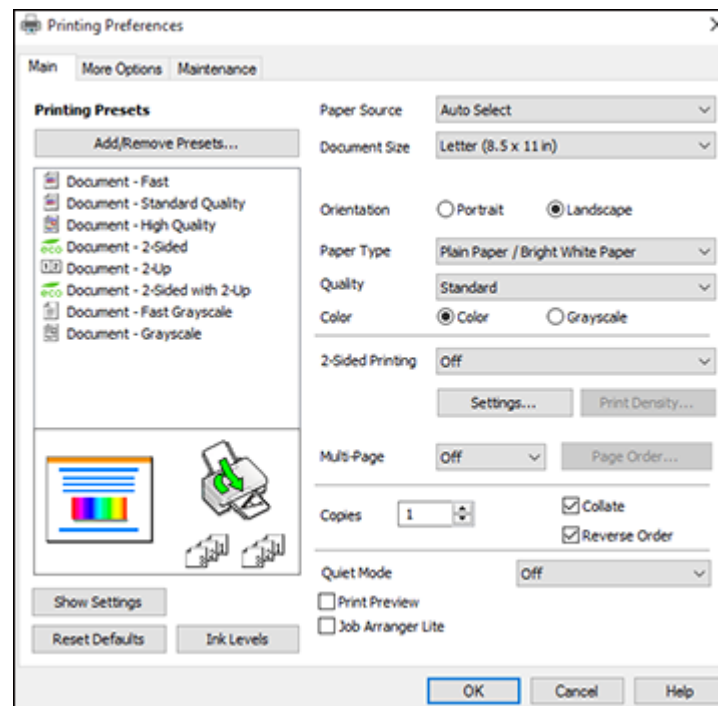

4. For the **Paper Source** setting, select where you loaded the paper you want to print on.
5. Select the size of the paper you loaded as the **Document Size** setting.

Note: You can also select the **User-Defined** setting to create a custom paper size.

6. Select the orientation of your document.

Note: If you are printing an envelope, select **Landscape**.

7. Select the type of paper you loaded as the **Paper Type** setting.

Note: The setting may not exactly match the name of your paper. Check the paper type settings list for details.

8. Select the **Quality** setting that matches the print quality you want to use.
9. Select a Color option:
 - To print a color document or photo, select the **Color** setting.
 - To print text and graphics in black or shades of gray, select the **Grayscale** setting.
10. To print on both sides of the paper, select the **2-Sided Printing** setting and select the options you want.
11. To print multiple pages on one sheet of paper, or print one image on multiple sheets of paper, select one of the settings in the **Multi-Page** menu and select the printing options you want.
12. To print multiple copies and arrange their print order, select the **Copies** options.
13. To preview your job before printing, select **Print Preview**.
14. To save your print job as a project that can be modified and combined with other print jobs, select **Job Arranger Lite**.
15. To reduce noise during printing when you select **Plain Paper/Bright White Paper**, select **On** in the Quiet Mode menu.

Note: Enabling **Quiet Mode** may reduce printing speed.

[Paper Source Options - Windows](#)

[Print Quality Options - Windows](#)

[Multi-Page Printing Options - Windows](#)

Parent topic: [Printing with the Standard Epson Printer Software - Windows](#)

Related references

[Paper or Media Type Settings - Printing Software](#)

Related tasks

[Selecting Double-sided Printing Settings - Windows](#)

Paper Source Options - Windows

You can select any of the available options in the Paper Source menu to print on the paper loaded in that source.

Note: **Paper Cassette 2** is available only if you have installed the optional cassette.

Auto Select

Automatically selects the paper source based on the selected paper size.

Paper Cassette 1

Selects the paper in cassette 1 as the paper source.

Paper Cassette 2

Selects the paper in cassette 2 as the paper source.

Rear Paper Feed

Selects the paper in the rear feed slot as the paper source.

Parent topic: [Selecting Basic Print Settings - Windows](#)

Print Quality Options - Windows

You can select any of the available Quality options to fine-tune the quality of your print. Some settings may be unavailable, depending on the paper type and border setting you have chosen.

Draft

For draft printing on plain paper.

Standard

For everyday text and image printing.

High

For photos and graphics with high print quality.

Parent topic: [Selecting Basic Print Settings - Windows](#)

Multi-Page Printing Options - Windows

You can select any of the available options in the Multi-Page menu to set up your multi-page print job.

2-Up and 4-Up

Prints 2 or 4 pages on one sheet of paper. Click the **Page Order** button to select page layout and border options.

2×1 Poster, 2×2 Poster, 3×3 Poster, 4×4 Poster

Prints one image on multiple sheets of paper to create a larger poster. Click the **Settings** button to select image layout and guideline options.

Parent topic: [Selecting Basic Print Settings - Windows](#)

Selecting Double-sided Printing Settings - Windows

You can print on both sides of the paper by selecting one of the **2-Sided Printing** options on the **Main** tab.

Note: Some options may be pre-selected or unavailable, depending on other settings you have chosen or if you are accessing the product over a network.

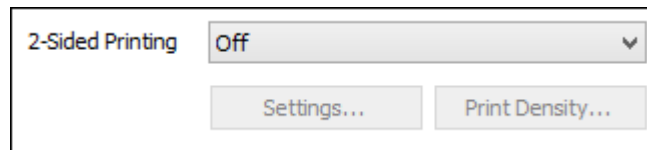



1. Select one of the following options for **2-Sided Printing**:
 - **Auto (Long-edge binding)** to print your double-sided print job by automatically flipping the paper on the long edge.
 - **Auto (Short-edge binding)** to print your double-sided print job by automatically flipping the paper on the short edge.
 - **Manual (Long-edge binding)** to print your double-sided print job by printing one side and prompting you to flip the paper over on the long edge to print the other side (recommended for paper types that do not support automatic duplexing).
 - **Manual (Short-edge binding)** to print your double-sided print job by printing one side and prompting you to flip the paper over on the short edge to print the other side (recommended for paper types that do not support automatic duplexing).
2. Click the **Settings** button.

You see this window:

Binding Settings

Binding Edge

Left Long-edge Top Short-edge Right Long-edge

Binding Margin

Front Page 0.00 [0.00 ... 1.18]

Back Page 0.00 [0.00 ... 1.18]

Unit mm inch



Start Page

From Front From Back

Create Folded Booklet

Booklet

Center Binding Side Binding

 

OK Cancel Help

3. Select the double-sided printing options you want to use.
4. Click **OK** to return to the **Main** tab.

5. Click the **Print Density** button.

You see this window:

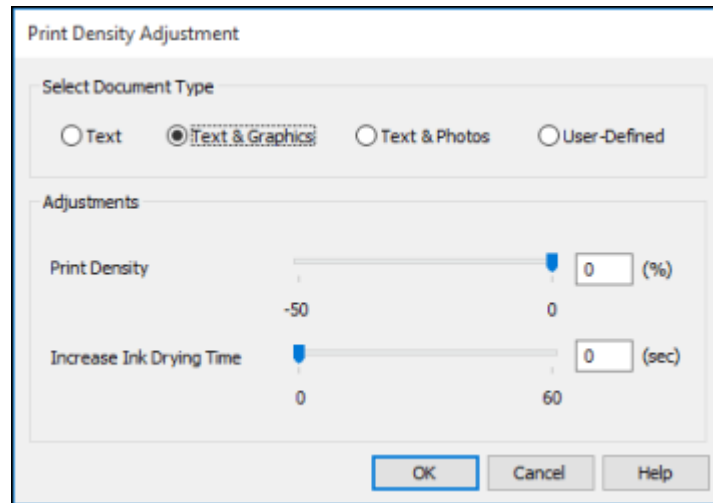

6. Select the type of document you are printing as the Document Type setting. The software automatically sets the **Adjustments** options for that document type.
7. If necessary, select the **Adjustments** options you want to use.
8. Click **OK** to return to the **Main** tab.
9. Print a test copy of your double-sided document to test the selected settings.
10. Follow any instructions displayed on the screen during printing.

[Double-sided Printing Options - Windows](#)

[Print Density Adjustments - Windows](#)

Parent topic: [Printing with the Standard Epson Printer Software - Windows](#)

Related tasks

[Selecting Basic Print Settings - Windows](#)

Double-sided Printing Options - Windows

You can select any of the available options on the Binding Settings window to set up your double-sided print job.

Binding Edge Options

Select a setting that orients double-sided print binding in the desired direction.

Binding Margin Options

Select options that define a wider margin to allow for binding.

Start Page

Selects whether printing starts on the front or back page.

Create Folded Booklet Options

Select the **Booklet** checkbox and a binding option to print double-sided pages as a booklet.

Parent topic: [Selecting Double-sided Printing Settings - Windows](#)

Print Density Adjustments - Windows

You can select any of the available options on the Print Density Adjustment window to adjust the print quality of your double-sided print job.

Print Density

Sets the level of ink coverage for double-sided printing.

Increase Ink Drying Time

Sets the amount of time required for drying ink after printing on one side of the paper before printing the other side in double-sided printing to prevent ink smearing.

Parent topic: [Selecting Double-sided Printing Settings - Windows](#)

Selecting Additional Layout and Print Options - Windows

You can select a variety of additional layout and printing options for your document or photo on the **More Options** tab.

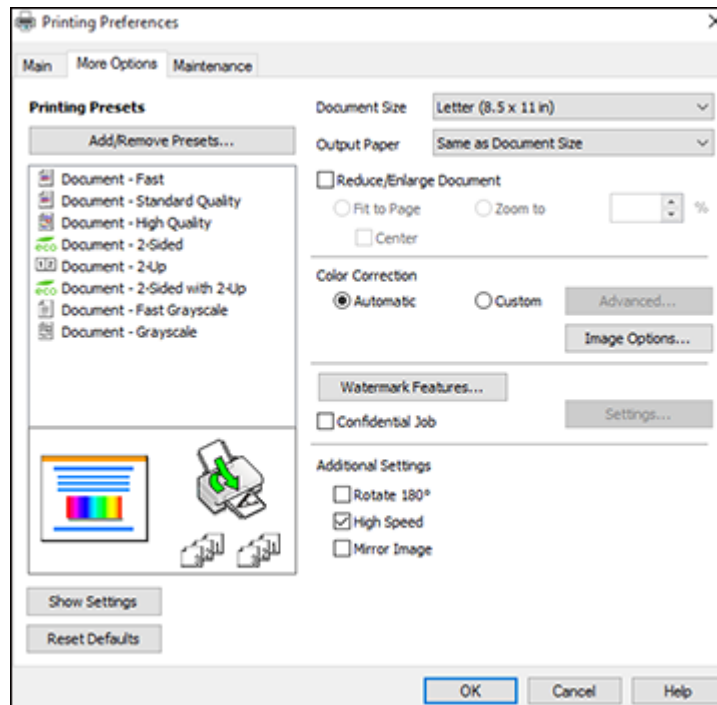

1. To change the size of your printed document or photo, select the **Reduce/Enlarge Document** checkbox and select one of these sizing options:
 - Select the **Fit to Page** option to size your image to fit the paper you loaded. Select the size of your document or photo as the **Document Size** setting, and the size of your paper as the **Output Paper** setting. If you want to center your image on the paper, select the **Center** option.
 - Select the **Zoom to** option to reduce or enlarge your document or photo by a specific percentage. Select the percentage in the % menu.
2. Select one of the following Color Correction options:
 - Select **Automatic** to automatically adjust the sharpness, brightness, contrast, and color saturation for your image.

- Select **Custom** and click the **Advanced** button to manually adjust the color correction settings or turn off color management in your printer software.
- Select **Image Options** to access additional settings for improving printed images.

Note: You can also select **Color Universal Print** settings.

3. To add the following features, click the **Watermark Features** button:

- **Anti-Copy Pattern:** adds a watermark that only appears when your printout is copied
- **Watermark:** adds a visible watermark to your printout
- **Header/Footer:** adds information such as the date and time to the top or bottom of your printout

Note: Click the **Settings** button to customize the text and location of the header or footer.

4. To add a password to your print job, select the **Confidential Job** checkbox, then enter a password. Confidential jobs are stored in the product's memory without being printed. To print the job, enter the password for the confidential job on the product's control panel.

Note: Confidential print jobs are cleared from the product's memory after printing.

5. Select any of the Additional Settings options to customize your print.

[Custom Color Correction Options - Windows](#)

[Image Options and Additional Settings - Windows](#)

[Header/Footer Settings - Windows](#)

Parent topic: [Printing with the Standard Epson Printer Software - Windows](#)

Custom Color Correction Options - Windows

You can select any of the available options in the Color Correction window to customize the image colors for your print job.

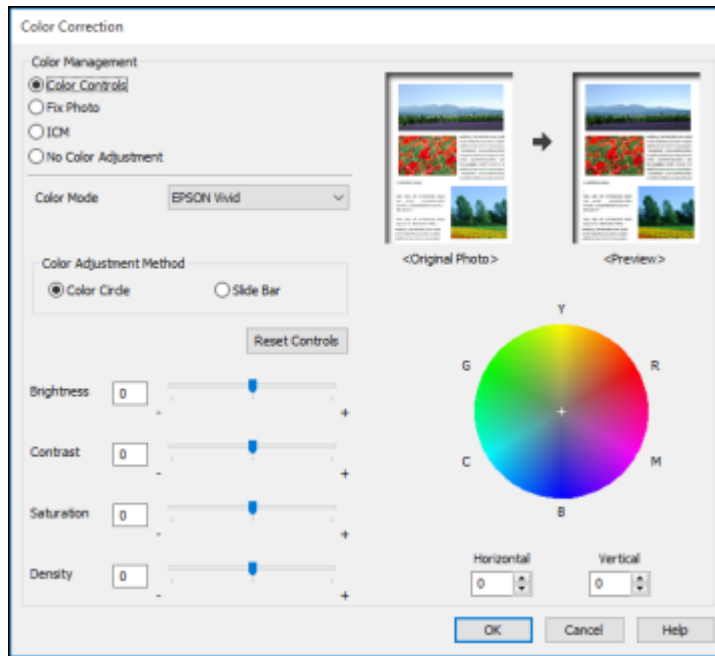

Color Controls

Lets you select a **Color Mode** setting, individual settings for **Brightness**, **Contrast**, **Saturation**, and **Density**, and individual color tones. Depending on the selected color mode, you can also adjust the midtone density using the **Gamma** setting.

Fix Photo

Improves the color, contrast, and sharpness of flawed photos.

Note: Fix Photo uses a sophisticated face recognition technology to optimize photos that include faces. For this to work, both eyes and the nose must be visible in the subject's face. If your photo includes a face with an intentional color cast, such as a statue, you may want to turn off **Fix Photo** to retain the special color effects.

ICM

Lets you manage color using installed color printing profiles.

No Color Adjustment

Turns off color management in your printer software so you can manage color using only your application software.

Parent topic: [Selecting Additional Layout and Print Options - Windows](#)

Image Options and Additional Settings - Windows

You can select any of the Image Options and Additional Settings to customize your print. Some options may be pre-selected or unavailable, depending on other settings you have chosen.

Image Options**Emphasize Text**

Adjusts the weight of printed text to increase readability.

Emphasize Thin Lines

Adjusts the weight of printed lines to increase visibility.

Edge Smoothing

Smooths jagged edges in low-resolution images such as screen captures or images from the Web.

Fix Red-Eye

Reduces or removes red-eye in photos.

Print Text in Black

Prints colored text in black.

For Color Text

Prints colored text on a background pattern or underlined.

For Color Graphs and Images

Prints colored graphics and images with overlay patterns.

For Color Text, Graphs, and Images

Prints colored text, graphics, and images with overlay patterns.

Enhancement Options

Specifies Color Universal Print enhancement settings for text, graphics, and images.

Additional Settings Options**Rotate 180°**

Prints the image rotated 180° from its original orientation.

High Speed

Speeds up printing but may reduce print quality.

Mirror Image

Flips the printed image left to right.

Parent topic: [Selecting Additional Layout and Print Options - Windows](#)

Header/Footer Settings - Windows

You can select any of the Header/Footer Settings options to add headers or footers when you print. The items are available to print at the top or bottom of your pages, in either the left, right, or center of the page.

Note: These settings are not saved with your document.

Top Left	Top Center	Top Right
User Name	None	Date/Time
Bottom Left	Bottom Center	Bottom Right
None	None	None

Reset Defaults OK Cancel Help

You can select to print the following information:

- User Name
- Computer Name
- Date
- Date/Time
- Document Name
- Collate Number (copy number)

Note: The user name, computer name, date, and time come from the Windows Control Panel on your computer.

Parent topic: [Selecting Additional Layout and Print Options - Windows](#)

Selecting a Printing Preset - Windows

For quick access to common groups of print settings, you can select a printing preset on the **Main** or **More Options** tab.

Note: You can create your own preset by clicking the **Add/Remove Presets** button.

1. Click the **Main** or **More Options** tab.

You see the available **Printing Presets** on the left:

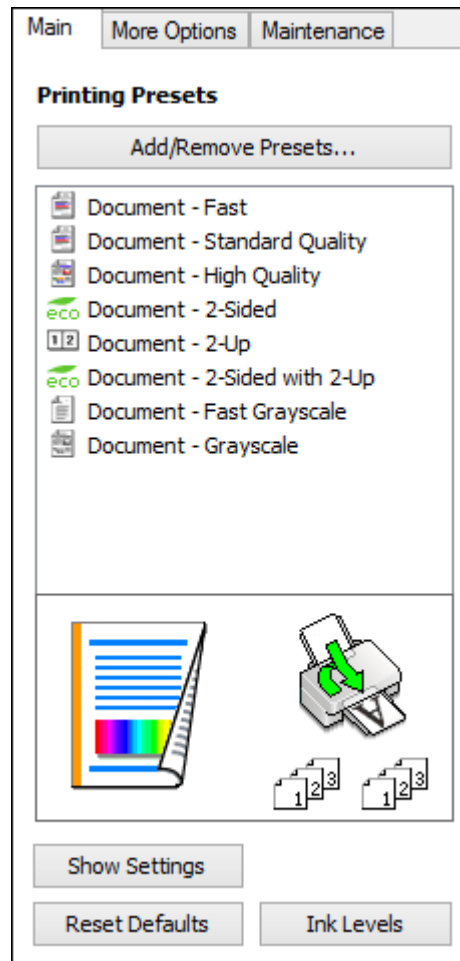



2. Place your cursor over one of the **Printing Presets** to view its list of settings.
3. Click on a preset to change its settings, or use any of the available options on the screen to control your printing presets.
4. To choose a preset for printing, select it.
5. Click **OK**.

Parent topic: [Printing with the Standard Epson Printer Software - Windows](#)

Selecting Extended Settings - Windows

You can select additional settings that apply to all the print jobs you send to your product.

1. Access the Windows Desktop and right-click the  icon for your product in the right side of the Windows taskbar, or click the up arrow and right-click .
2. Select **Printer Settings**.
3. Click the **Maintenance** tab.

You see the maintenance options:

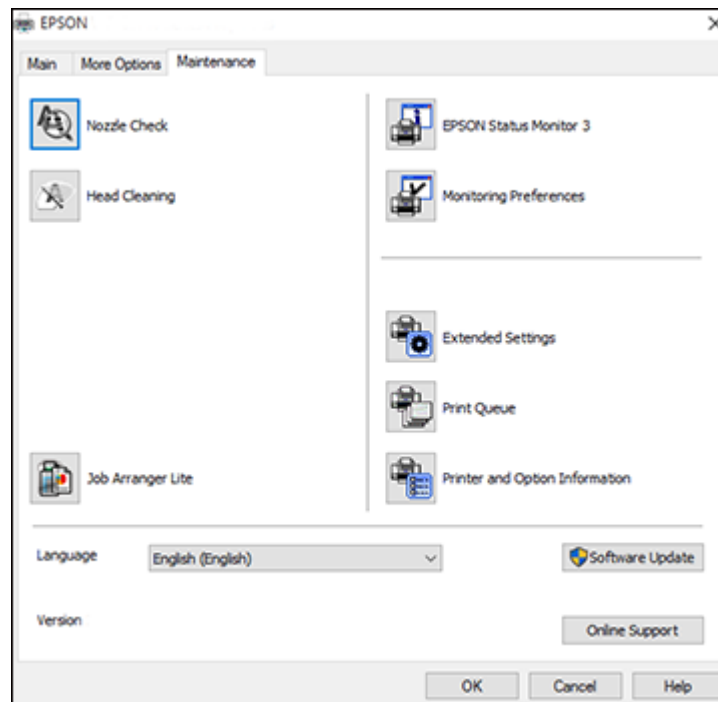

4. Click the **Extended Settings** button.

You see this window:

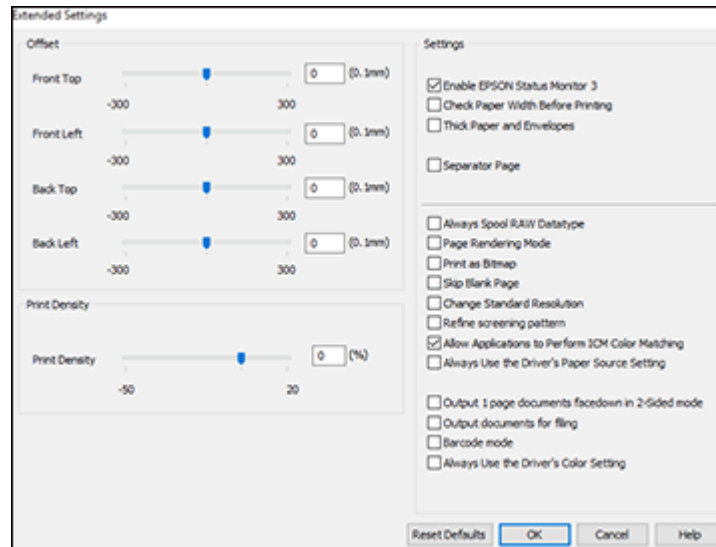

5. Select any of the extended settings to customize your print.
6. Click **OK** to close the Extended Settings window.
7. Click **OK** to close the printer software window.

[Extended Settings - Windows](#)

Parent topic: [Printing with the Standard Epson Printer Software - Windows](#)

Extended Settings - Windows

You can select from these settings on the Extended Settings window.

Enable EPSON Status Monitor 3

Enables product monitoring for ink and paper supplies and other issues.

Check Paper Width Before Printing

Prevents printing beyond the edges of the paper if the paper size setting is incorrect; may reduce print speed.

Thick Paper and Envelopes

Prevents ink from smearing when you print on envelopes or other thick paper.

Separator Page

Before each document, prints a separator page containing the title, user, date, and time.

Always Spool RAW Datatype

Increases print speed and may solve other printing problems.

Page Rendering Mode

Increases print speed when printing is extremely slow or the print head stops during printing.

Print as Bitmap

Increases print speed when printing is extremely slow or the print head stops during printing, and other settings do not help.

Skip Blank Page

Ensures that your product does not print pages that contain no text or images.

Change Standard Resolution

Reduces the resolution of print data to correct printing problems.

Refine screening pattern

Prints graphics with a finer screening pattern.

Allow Applications to Perform ICM Color Matching

Allows applications to perform ICM color matching.

Always Use the Driver's Paper Source Setting

Prints using the paper source setting in the printer driver, rather than the setting in your application.

Output 1 page documents facedown in 2-Sided mode

Outputs single-sided pages in a 2-sided print job facedown instead of faceup.

Output documents for filing

Outputs all landscape, portrait, 1-sided, and 2-sided documents in the same orientation for easier filing.

Barcode mode

Reduces bleeding when printing barcodes on plain paper, letterhead paper, recycled paper, preprinted paper, envelopes, and thick paper.

Always Use the Driver's Color Setting

Prioritizes color settings from the printer driver software.

Parent topic: [Selecting Extended Settings - Windows](#)

Printing Your Document or Photo - Windows

Once you have selected your print settings, you are ready to save your settings and print.

1. Click **OK** to save your settings.

You see your application's Print window, such as this one:

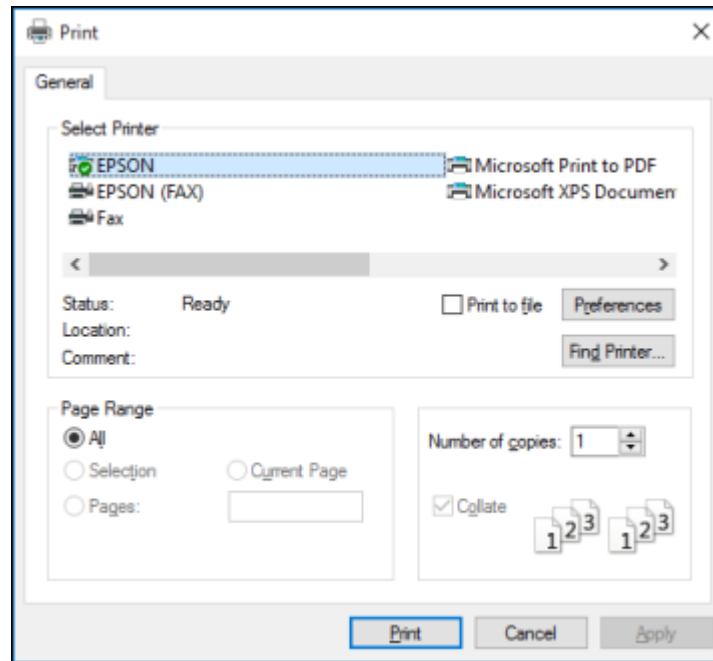



2. Click **OK** or **Print** to start printing.

Parent topic: [Printing with the Standard Epson Printer Software - Windows](#)

Locking Printer Settings - Windows

Windows administrators can lock access to some printer settings to prevent unauthorized changes.

1. Do one of the following:

- **Windows 10:** Click  and select  (Settings) > **Devices** > **Printers & scanners**. Select your product name and select **Manage** > **Printer properties**.
- **Windows 8.x:** Navigate to the **Apps** screen and select **Control Panel** > **Hardware and Sound** > **Devices and Printers**. Right-click your product and select **Printer properties**.
- **Windows 7:** Click  and select **Devices and Printers**. Right-click your product and select **Printer properties**.

- **Windows Vista:** Click  and select **Control Panel**. Click **Printer** under **Hardware and Sound**, then right-click your product and select **Properties**.
2. Click the **Optional Settings** tab.

Note: You can prevent access to the **Optional Settings** tab by changing the user or group permissions in the **Security** tab.

3. Click **Driver Settings**.

You see this window:

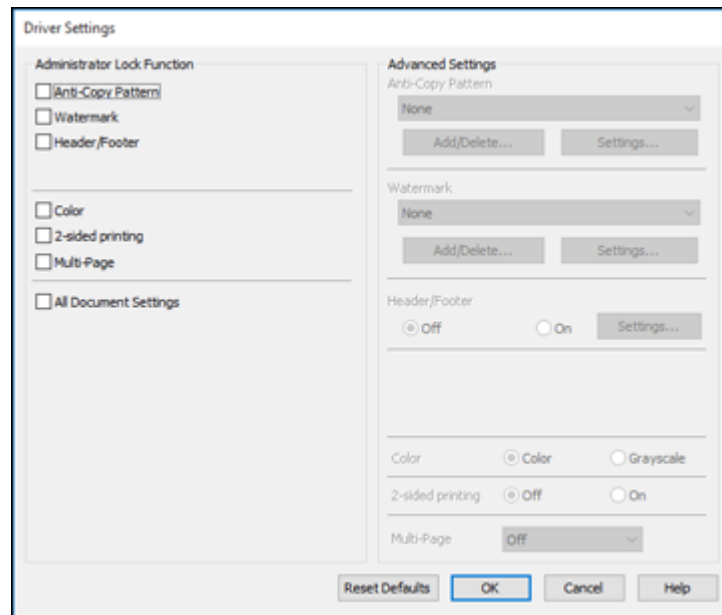

4. Select the checkbox for each setting you want to lock. To lock all print settings, select **All Document Settings**.
5. Under **Advanced Settings**, select the setting option you want to use for each locked setting.
6. Click **OK**.

[Locked Setting Options](#)

Parent topic: [Printing with the Standard Epson Printer Software - Windows](#)

Locked Setting Options

Select the options you want to use for any locked print settings.



Setting	Options	Description
Anti-Copy Pattern	Various data items	Lets you select the data to use for the pattern or prohibit anti-copy patterns
	Add/Delete	Lets you add or delete a customized anti-copy pattern
	Settings	Lets you select the arrangement, size, and other settings for the custom anti-copy pattern
Watermark	Various text watermarks	Lets you select the text for the watermark or prohibit watermarks
	Add/Delete	Lets you add or delete a customized text or image-based watermark
	Settings	Lets you select the size, position, and other watermark settings
Header/Footer	Off	Prohibits headers or footers
	On	Allows headers and footers
	Settings	Lets you select the text and position for printing headers and footers
Color	Color	Allows color printing
	Grayscale	Allows printing in black or shades of gray only
2-sided printing	Off	Allows printing on one side of the paper only
	On	Allows printing on both sides of the paper
Multi-Page	Off	Prohibits multi-page settings
	2-Up	Allows printing of 2 pages on one sheet of paper
	4-Up	Allows printing of 4 pages on one sheet of paper

Parent topic: [Locking Printer Settings - Windows](#)

Entering a User ID and Password for Printing

If you enabled Access Control on the product, you must enter a user ID and password in the printer driver to be able to print.

Note: If you do not know the user ID or password, contact your administrator for assistance.

1. Access the Windows Desktop and right-click the  icon for your product in the right side of the Windows taskbar, or click the up arrow and right-click . Select **Printer Settings** and click the **Maintenance** tab.

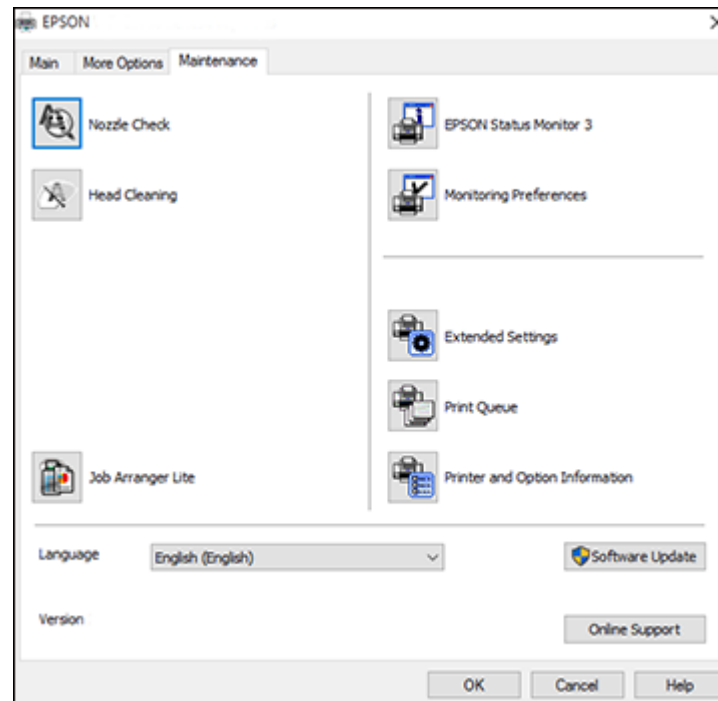



2. Click the **Printer and Option Information** button.
3. Select the **Save Access Control Settings** checkbox.
4. Click the **Settings** button.
5. Enter your user name and password.

6. Click **OK**.

Parent topic: [Printing with the Standard Epson Printer Software - Windows](#)

Selecting Default Print Settings - Windows

When you change your print settings in a program, the changes apply only while you are printing in that program session. If you want to change the print settings you use in all your Windows programs, you can select new default print settings.

1. Access the Windows Desktop and right-click the  icon for your product in the right side of the Windows taskbar, or click the up arrow and right-click .
2. Select **Printer Settings**.

You see the printer settings window:

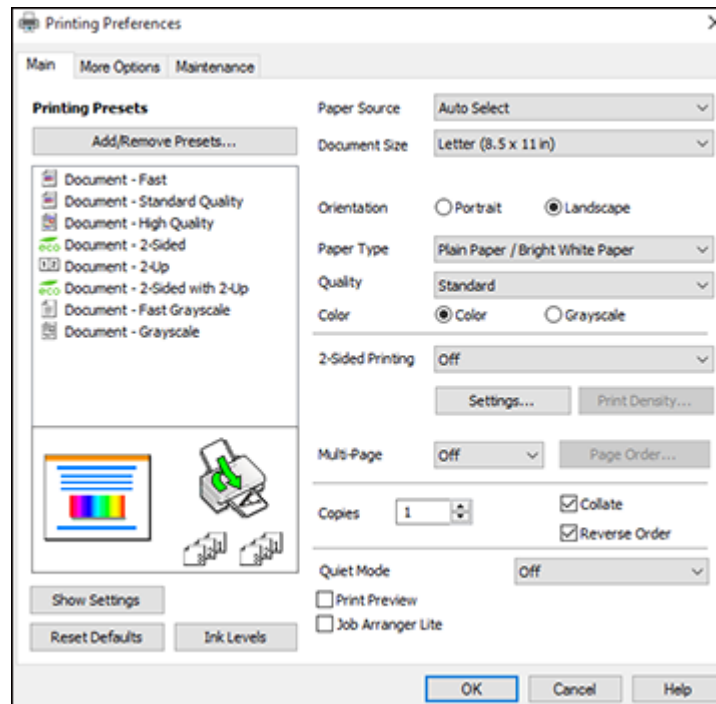

3. Select the print settings you want to use as defaults in all your Windows programs.

4. Click **OK**.



These settings are now the defaults selected for printing. You can still change them as needed for printing in any program session.

[Changing the Language of the Printer Software Screens](#)

Parent topic: [Printing with the Standard Epson Printer Software - Windows](#)

Changing the Language of the Printer Software Screens

You can change the language used on the Windows printer software screens.

1. Access the Windows Desktop and right-click the  icon for your product in the right side of the Windows taskbar, or click the up arrow and right-click .

2. Select **Printer Settings**.

You see the printer settings window.

3. Click the **Maintenance** tab.

You see the maintenance options:

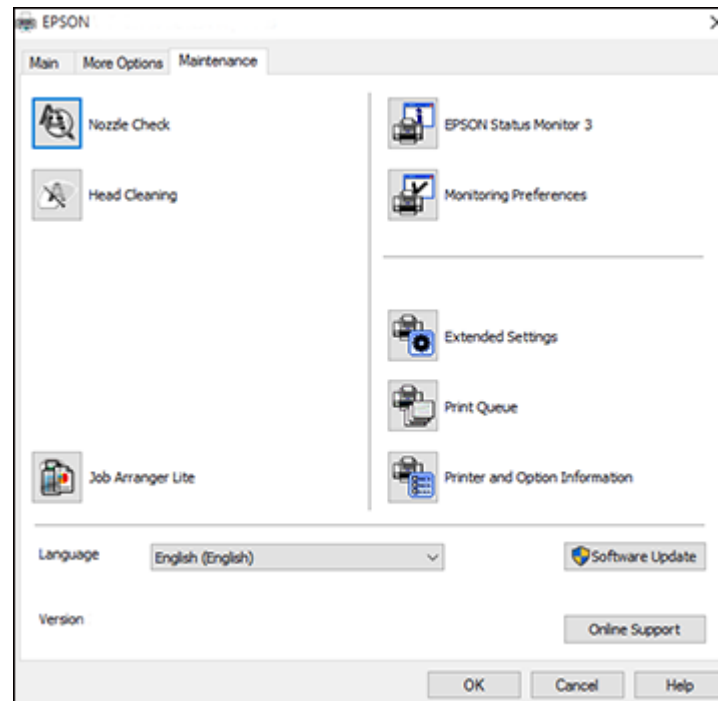



4. Select the language you want to use as the **Language** setting.
5. Click **OK** to close the printer software window.

The printer software screens appear in the language you selected the next time you access them.

Parent topic: [Selecting Default Print Settings - Windows](#)

Changing Automatic Update Options

Your printer software for Windows automatically checks for updates to the product software. You can change how often the software checks for updates or disable this feature.

1. Access the Windows Desktop and right-click the  icon for your product in the right side of the Windows taskbar, or click the up arrow and right-click .
2. Select **Software Update Settings**.

You see this window:

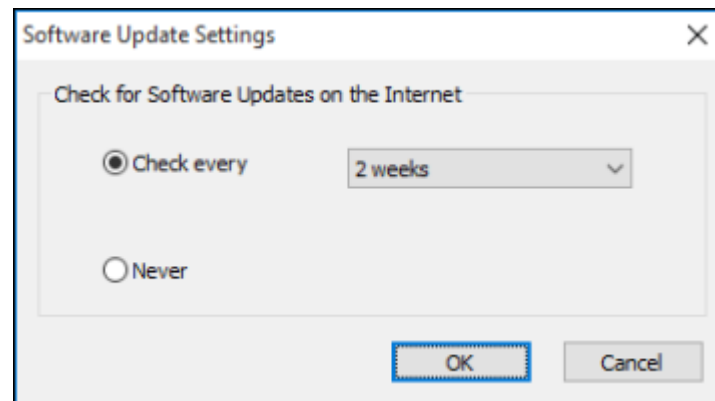

3. Do one of the following:
 - To change how often the software checks for updates, select a setting in the **Check every** menu.
 - To disable the automatic update feature, select the **Never** option.
4. Click **OK** to exit.

Note: If you choose to disable the automatic update feature, you can check for updates manually.

Parent topic: [Printing with the Standard Epson Printer Software - Windows](#)

Printing with the Built-in Epson Driver - Windows 10 S

You can print with the built-in Epson printer driver using any printing program on Windows 10 S, as described in these sections.

Note: The built-in Epson driver in Windows 10 S does not include all the available print settings for your product. To print with additional settings, download and install the Epson Print and Scan utility from the Windows Store. You cannot download and install any Epson product software from the Epson website for use with Windows 10 S; you must obtain software only from the Windows Store.

[Selecting Print Settings - Windows 10 S](#)

Parent topic: [Printing from a Computer](#)

Selecting Print Settings - Windows 10 S

Select the settings for your print job in your Windows 10 S application.

1. Open a photo or document for printing.
2. Select the print command in your application.

Note: You may need to select a print icon on your screen, the **Print** option in the **File** menu, or another command. See your application's help utility for details.

3. If necessary, select your product name as the printer you want to use.

Note: You may also need to select **Properties** or **Preferences** to view your print settings.

You see a window like this:

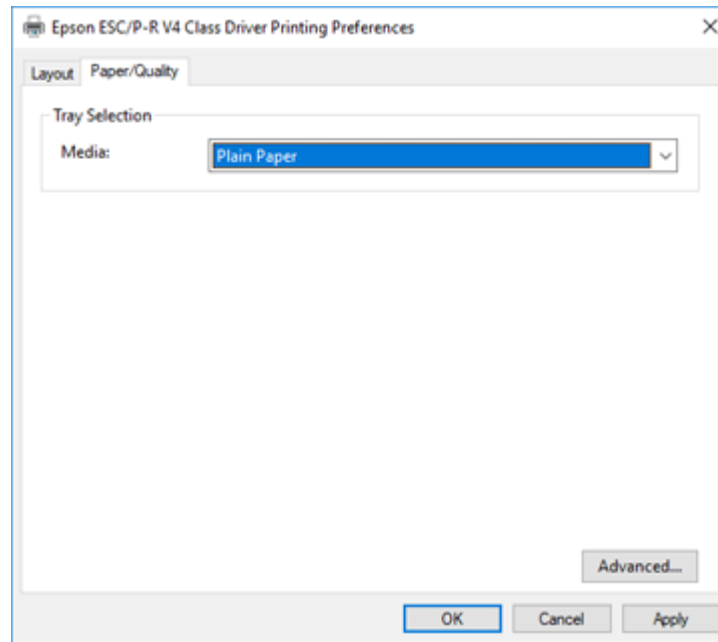

4. Select the type of paper you loaded as the **Media** setting.

Note: The setting may not exactly match the name of your paper. Check the paper type settings list for details.

5. Click the **Advanced** button.

You see a window like this:

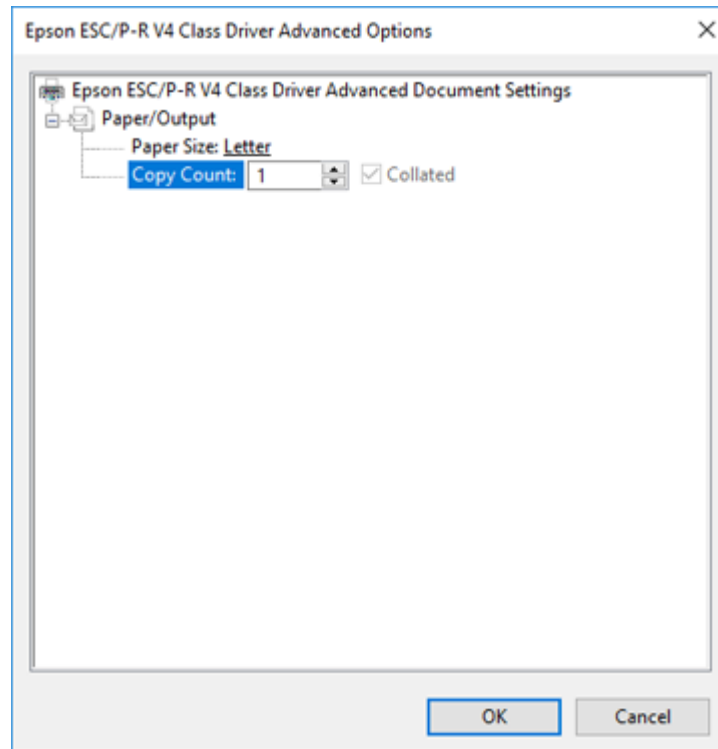

6. Select the size of the paper you loaded as the **Paper Size** setting.
7. To print multiple copies, select or enter the number as the **Copy Count** setting.
8. To print multiple copies of multi-page documents in sets, select the **Collated** checkbox.
9. Click **OK**.

You return to the printing preferences window.

10. Select the **Layout** tab.

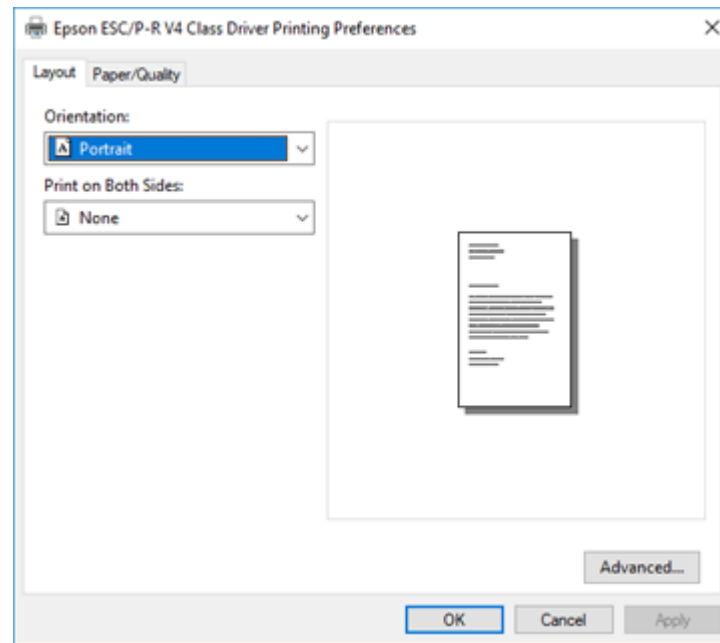

11. Select the orientation of your document as the **Orientation** setting.

- To print double-sided, select one of the **Print on Both Sides** options, depending on how you want to orient the page layout. The icon next to each option shows the layout.

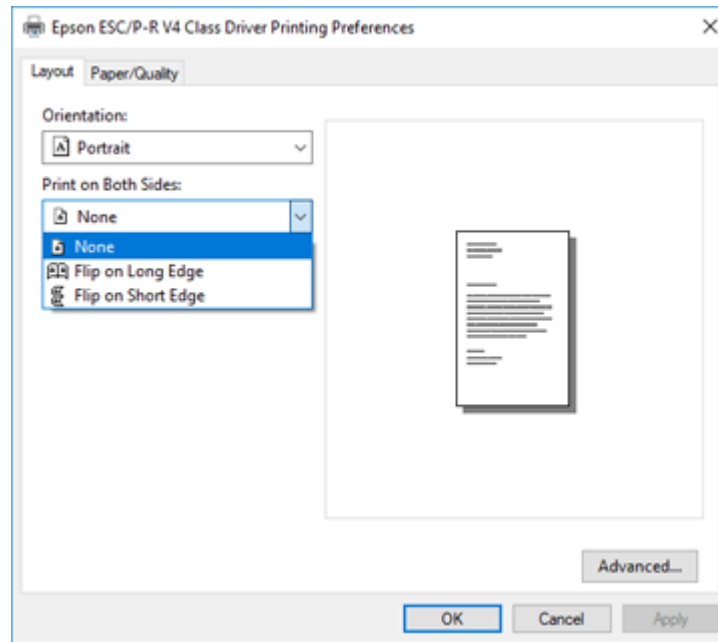

- Click **OK** to save your settings.

You see your application's **Print** window.

- Click **OK** or **Print** to start printing.

Parent topic: [Printing with the Built-in Epson Driver - Windows 10 S](#)

Printing with the Epson Standard Printer Software - Mac

You can print with your product using any Mac printing program, as described in these sections.

Note: If you have an Internet connection, it is a good idea to check for updates to your product software on Epson's support website.

[Selecting Basic Print Settings - Mac](#)

[Selecting Page Setup Settings - Mac](#)

- [Selecting Print Layout Options - Mac](#)
 - [Selecting Double-sided Printing Settings - Mac](#)
 - [Managing Color - Mac](#)
 - [Selecting Printing Preferences - Mac](#)
 - [Printing Your Document or Photo - Mac](#)
- Parent topic:** [Printing from a Computer](#)

Selecting Basic Print Settings - Mac

Select the basic settings for the document or photo you want to print.

1. Open a photo or document for printing.
2. Select the print command in your application.

Note: You may need to select a print icon on your screen, the **Print** option in the File menu, or another command. See your application's help utility for details.

3. Select your product as the **Printer** setting.

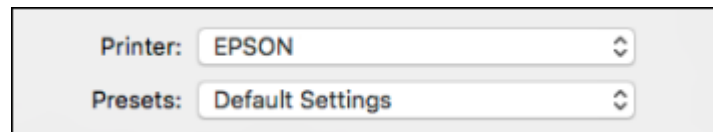

4. If necessary, click the arrow next to the Printer setting or the **Show Details** button to expand the print window.

You see the expanded printer settings window for your product:

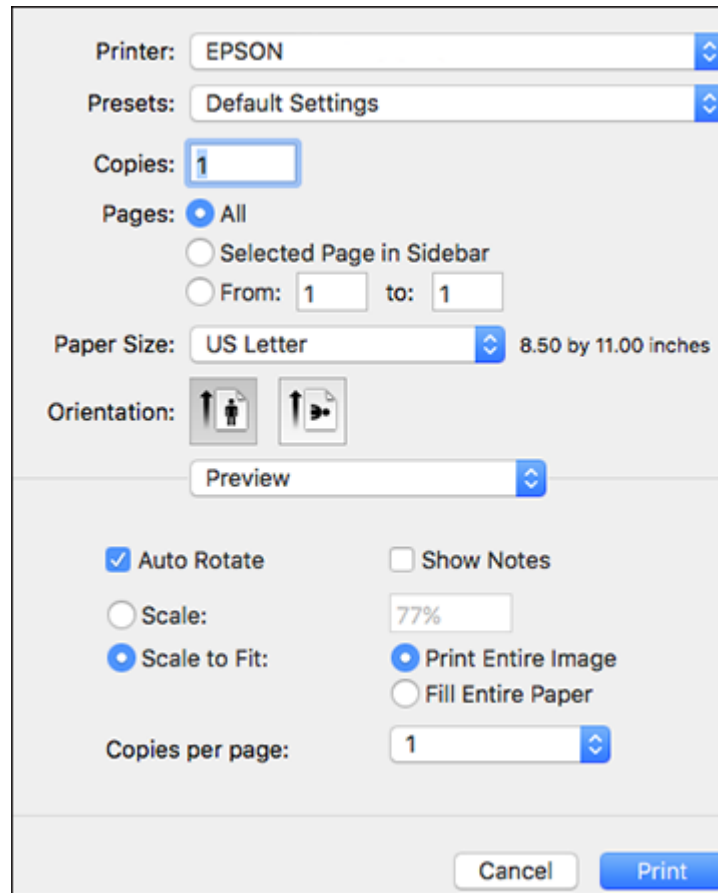

Note: The print window may look different, depending on the Mac OS version and the application you are using.

5. Select the **Copies** and **Pages** settings as necessary.

Note: If you do not see these settings in the print window, check for them in your application before printing.

6. Select the page setup options: **Paper Size** and **Orientation**.

Note: If you do not see these settings in the print window, check for them in your application before printing. They may be accessible by selecting **Page Setup** from the File menu.

7. Select any application-specific settings that appear on the screen, such as those shown in the image above for the Preview application.
8. Select **Print Settings** from the pop-up menu.

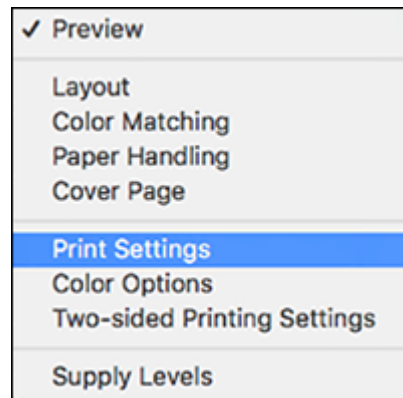

You see these settings:

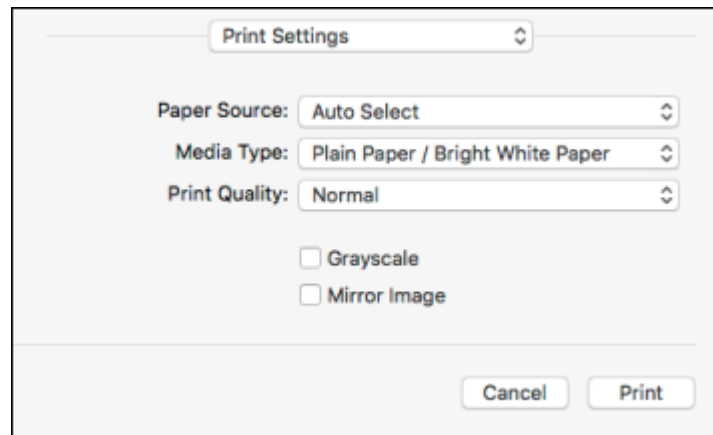

9. Select the **Paper Source** you wish to print from.
10. Select the type of paper you loaded as the **Media Type** setting.

Note: The setting may not exactly match the name of your paper. Check the paper type settings list for details.

11. Select the **Print Quality** setting you want to use.
12. Select any of the available print options.

[Paper Source Options - Mac](#)

[Print Quality Options - Mac](#)

[Print Options - Mac](#)

Parent topic: [Printing with the Epson Standard Printer Software - Mac](#)

Related references

[Paper or Media Type Settings - Printing Software](#)

Related tasks

[Selecting Page Setup Settings - Mac](#)

Paper Source Options - Mac

You can select any of the available options in the Paper Source menu to print on the paper loaded in that source.

Auto Select

Automatically selects the paper source based on the selected paper size.

Cassette 1

Selects the paper in cassette 1 as the paper source.

Cassette 2

Selects the paper in cassette 2 as the paper source.

Rear Paper Feed

Selects the paper in the rear feed slot as the paper source.

Parent topic: [Selecting Basic Print Settings - Mac](#)

Print Quality Options - Mac

You can select any of the available Print Quality options to fine-tune the quality of your print. Some settings may be unavailable, depending on the paper type setting you have chosen.

Draft

For draft printing on plain paper.

Normal

For everyday text and image printing.

Fine

For text and graphics with good quality and print speed.

Best Quality

For the best print quality, but the slowest print speed.

Parent topic: [Selecting Basic Print Settings - Mac](#)

Print Options - Mac

You can select any of the print options to customize your print. Some options may be unavailable, depending on other settings you have chosen.

Grayscale

Prints text and graphics in black or shades of gray.

Mirror Image

Lets you flip the printed image horizontally.

Parent topic: [Selecting Basic Print Settings - Mac](#)

Selecting Page Setup Settings - Mac

Depending on your application, you may be able to select the paper size and orientation settings from the print window.

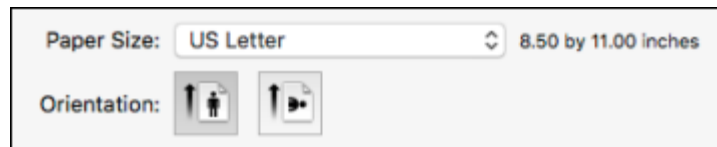

Note: If you do not see these settings in the print window, check for them in your application before printing. They may be accessible by selecting **Page Setup** from the File menu.

1. Select the size of the paper you loaded as the **Paper Size** setting.
2. Select the orientation of your document or photo as shown in the print window.

Note: If you are printing an envelope, select the  icon.

Note: You can reduce or enlarge the size of the printed image by selecting **Paper Handling** from the pop-up menu and selecting a scaling option.

Parent topic: [Printing with the Epson Standard Printer Software - Mac](#)

Selecting Print Layout Options - Mac

You can select a variety of layout options for your document or photo by selecting **Layout** from the pop-up menu on the print window.

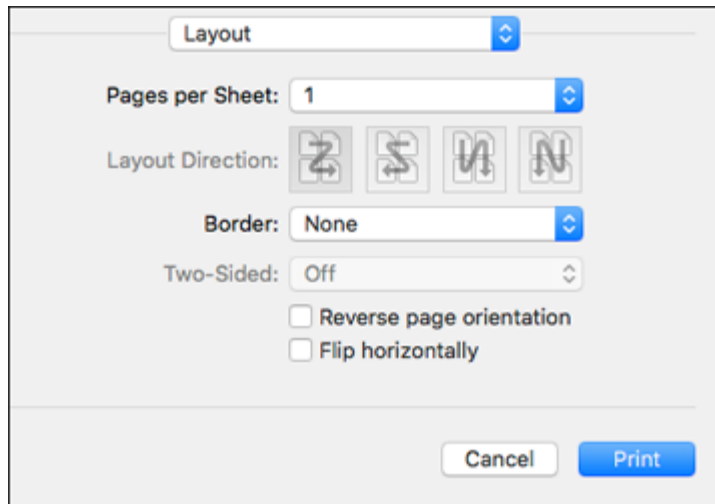

- To print multiple pages on one sheet of paper, select the number of pages in the **Pages per Sheet** pop-up menu. To arrange the print order of the pages, select a **Layout Direction** setting.
- To print borders around each page on the sheet, select a line setting from the **Border** pop-up menu.
- To invert or flip the printed image, select the **Reverse page orientation** or **Flip horizontally** settings.

Parent topic: [Printing with the Epson Standard Printer Software - Mac](#)

Selecting Double-sided Printing Settings - Mac

You can print on both sides of the paper by selecting **Two-sided Printing Settings** from the pop-up menu on the print window.

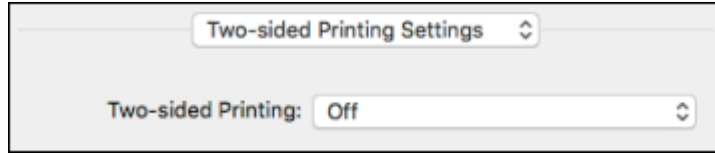

Note: Some options may be pre-selected or unavailable, depending on other settings you have chosen or if you are accessing the product over a network. This screen may be different, depending on the Mac OS version you are using.

1. Select one of the **Two-sided Printing** options.

2. Select the type of document you are printing as the **Document Type** setting. The software automatically sets the Adjustments options for that document type.

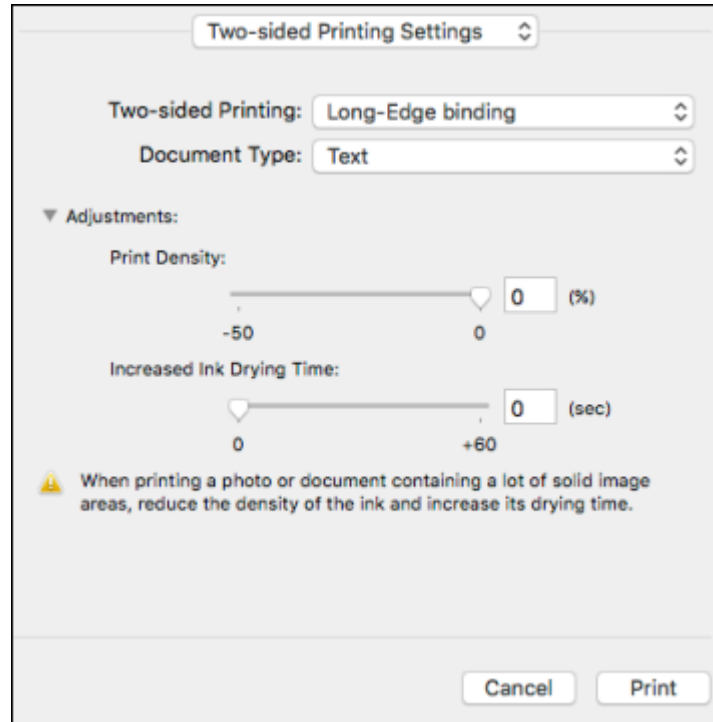

3. If necessary, customize the Adjustments settings as instructed on the screen.
4. Print a test copy of your double-sided document to test the selected settings.
5. Follow any instructions displayed on the screen during printing.

[Double-sided Printing Options and Adjustments - Mac](#)

Parent topic: [Printing with the Epson Standard Printer Software - Mac](#)

Related tasks

[Selecting Basic Print Settings - Mac](#)

Double-sided Printing Options and Adjustments - Mac

You can select any of the available options in the **Two-sided Printing Settings** pop-up menu to set up your double-sided print job.

Long-Edge binding

Orients double-sided printed pages to be bound on the long edge of the paper.

Short-Edge binding

Orients double-sided printed pages to be bound on the short edge of the paper.

Print Density

Sets the level of ink coverage for double-sided printing.

Increased Ink Drying Time

Sets the amount of time required for drying ink after printing on one side of the paper before printing the other side in double-sided printing.

Parent topic: [Selecting Double-sided Printing Settings - Mac](#)

Managing Color - Mac

You can adjust the Color Matching and Color Options settings to fine-tune the colors in your printout, or turn off color management in your printer software.

1. Select **Color Matching** from the pop-up menu in the print window.

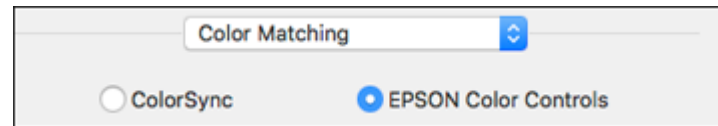

2. Select one of the available options.

3. Select **Color Options** from the pop-up menu in the print window.

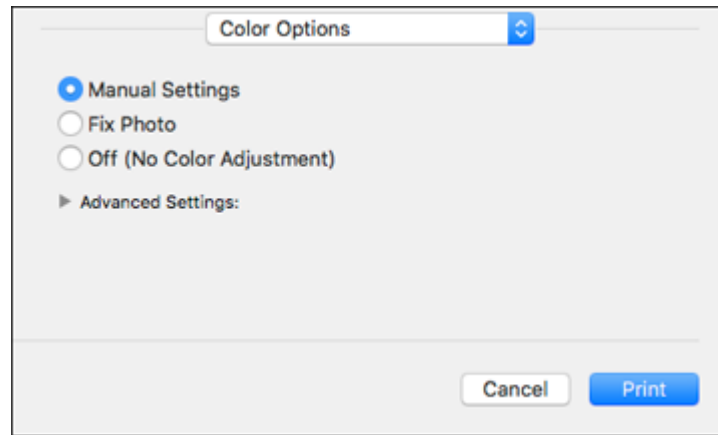

Note: The available settings on the Color Options menu depend on the option you selected on the Color Matching menu.

4. Select one of the available options.

[Color Matching and Color Options - Mac](#)

Parent topic: [Printing with the Epson Standard Printer Software - Mac](#)

Color Matching and Color Options - Mac

You can select from these settings on the **Color Matching** and **Color Options** menus.

Color Matching Settings

EPSON Color Controls

Lets you manage color using controls in your printer software or turn off color management.

ColorSync

Prints using standard color profiles for your product and paper to help match image colors. You can customize the conversion method and filter settings on the ColorSync pop-up menu in the print window.

Color Options Settings

Manual Settings

Lets you select manual color adjustments. Click the arrow next to **Advanced Settings** and select settings for **Brightness**, **Contrast**, **Saturation**, and individual color tones. You can also select a color **Mode** setting for printing photos and graphics and the **Fix Red-Eye** setting to reduce or remove red-eye in photos. Depending on the selected color mode, you can also adjust the midtone density using the **Gamma** setting.

Fix Photo

Improves the color, contrast, and sharpness of flawed photos. Click the arrow next to **Advanced Settings** and select the **Fix Red-Eye** setting to reduce or remove red-eye in photos.

Note: Fix Photo uses a sophisticated face recognition technology to optimize photos that include faces. For this to work, both eyes and the nose must be visible in the subject's face. If your photo includes a face with an intentional color cast, such as a statue, you may want to turn off **Fix Photo** to retain the special color effects.

Off (No Color Adjustment)

Turns off color management in your printer software so you can manage color using only your application software.

Note: An ICC profile is required if color management is turned off.

Parent topic: [Managing Color - Mac](#)

Selecting Printing Preferences - Mac

You can select printing preferences that apply to all the print jobs you send to your product.

1. In the Apple menu or the Dock, select **System Preferences**.
2. Select **Print & Fax**, **Print & Scan**, or **Printers & Scanners**, select your product, and select **Options & Supplies**.
3. Select **Driver** or **Options**.

You see a screen like this:

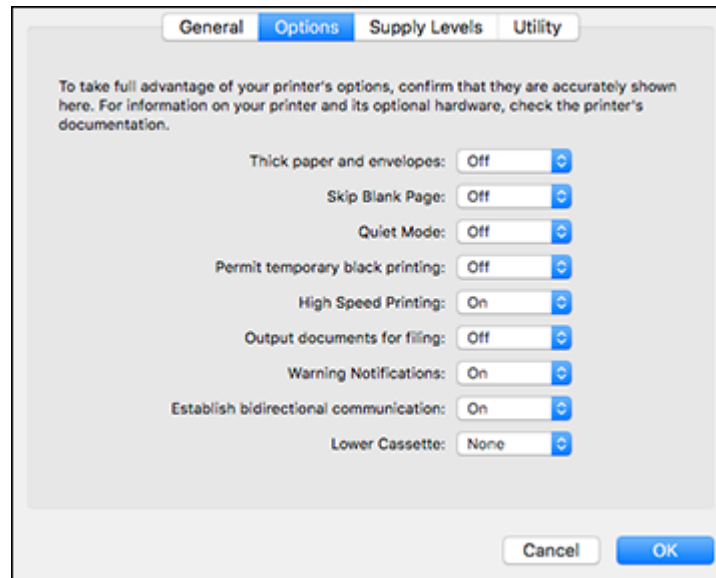

4. Select any of the available printing preferences.
5. Click **OK**.

[Printing Preferences - Mac](#)

Parent topic: [Printing with the Epson Standard Printer Software - Mac](#)

Printing Preferences - Mac

You can select from these settings on the **Options** or **Driver** tab.

Thick Paper and Envelopes

Prevents ink from smearing when you print on envelopes or other thick paper.

Skip Blank Page

Ensures that your product does not print pages that contain no text or images.

Quiet Mode

Lessens noise during printing but may decrease print speed.

Permit temporary black printing

Allows you to print using black ink when color ink is expended.

High Speed Printing

Speeds up printing but may reduce print quality.

Output documents for filing

Outputs all landscape, portrait, 1-sided, and 2-sided documents in the same orientation for easier filing.

Warning Notifications

Lets you choose whether or not to receive warning notifications from the printer software for various operating conditions.

Establish bidirectional communication

Allows the product to communicate with the computer. Do not change the default setting unless you experience issues when using a shared printing pool.

Lower Cassette

Specifies whether the optional cassette is present.

Parent topic: [Selecting Printing Preferences - Mac](#)

Printing Your Document or Photo - Mac

Once you have selected your print settings, you are ready to print.

Click **Print** at the bottom of the print window.

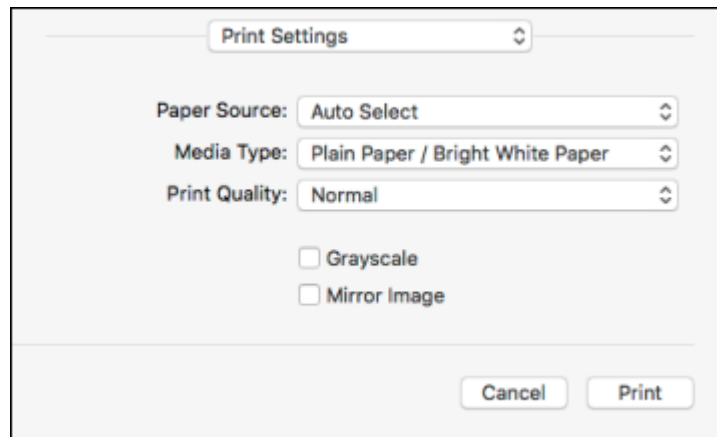

[Checking Print Status - Mac](#)

Parent topic: [Printing with the Epson Standard Printer Software - Mac](#)

Checking Print Status - Mac



During printing, you can view the progress of your print job, control printing, and check ink status.

1. Click the printer icon when it appears in the Dock.

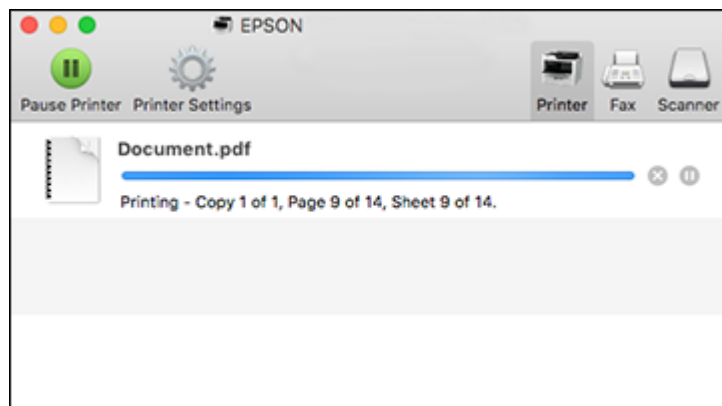
You see the print status window:



2. Select the following options as necessary for your Mac OS version:

- To cancel printing, click the print job and click  or **Delete**.
- To pause a print job, click the print job and click  or **Hold**. To resume a print job, click the paused print job and click  or **Resume**.
- To pause printing for all queued print jobs, click **Pause** or **Pause Printer**.
- To display other printer information, click **Settings**, **Printer Settings**, or **Supply Levels**.

Parent topic: [Printing Your Document or Photo - Mac](#)

Printing with the Epson Universal Print Driver - Windows

You can print with the Epson Universal Print Driver using any Windows printing program, as described in these sections.

[Synchronizing Printer Settings - Epson Universal Print Driver - Windows](#)

[Selecting Basic Print Settings - Epson Universal Print Driver - Windows](#)

[Selecting Additional Layout and Print Options - Epson Universal Print Driver - Windows](#)

[Selecting Maintenance Options - Epson Universal Print Driver - Windows](#)

[Selecting Default Print Settings - Epson Universal Print Driver - Windows](#)

[Locking Printer Settings - Epson Universal Print Driver - Windows](#)

[Adding Network Printers - Epson Universal Print Driver - Windows](#)





Parent topic: [Printing from a Computer](#)

Synchronizing Printer Settings - Epson Universal Print Driver - Windows

You may need to synchronize the printer driver with the product if the printer driver does not detect the correct information or settings from the product.

Note: You must sync the printer driver before you can use any optional equipment installed on the product, such as an optional cassette unit.

1. Do one of the following:

- **Windows 10:** Click  and select  (Settings) > **Devices** > **Printers & scanners**. Select **EPSON Universal Print Driver** and select **Manage** > **Printer properties**.
- **Windows 8.x:** Navigate to the **Apps** screen and select **Control Panel** > **Hardware and Sound** > **Devices and Printers**. Right-click **EPSON Universal Print Driver** and select **Printer properties**.
- **Windows 7:** Click  and select **Devices and Printers**. Right-click **EPSON Universal Print Driver** and select **Printer properties**.
- **Windows Vista:** Click  and select **Control Panel**. Click **Printer** under **Hardware and Sound**, then right-click **EPSON Universal Print Driver** and select **Properties**.

2. Click the **Optional Settings** tab.

You see this window:

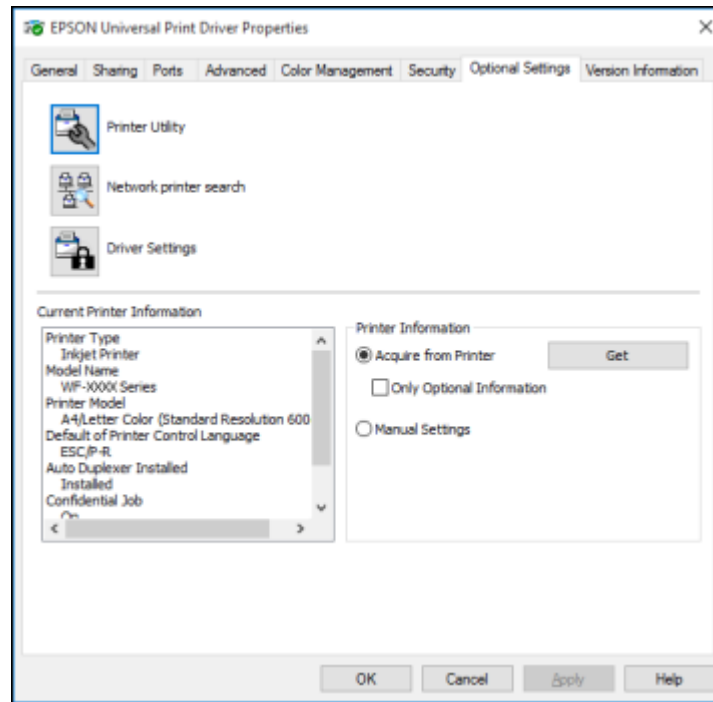

3. Make sure **Acquire from Printer** is selected and click **Get**.

Note: Select the **Only Optional Information** checkbox if you only want to enable optional equipment, such as an optional cassette unit.

The product's settings and other information appears in the Current Printer Information area.

4. Click **OK**.

Parent topic: [Printing with the Epson Universal Print Driver - Windows](#)

Selecting Basic Print Settings - Epson Universal Print Driver - Windows

Select the basic settings for the document or photo you want to print.

Note: The names of settings on the universal print driver screens may vary slightly, depending on the version of the print driver you have installed.

1. Open a photo or document for printing.
2. Select the print command in your application.

Note: You may need to select a print icon on your screen, the **Print** option in the **File** menu, or another command. See your application's help utility for details.

3. If necessary, select **EPSON Universal Print Driver** as the printer you want to use.

Note: You may also need to select **Properties** or **Preferences** to view your print settings.

You see the **Main** tab of your printer settings window:

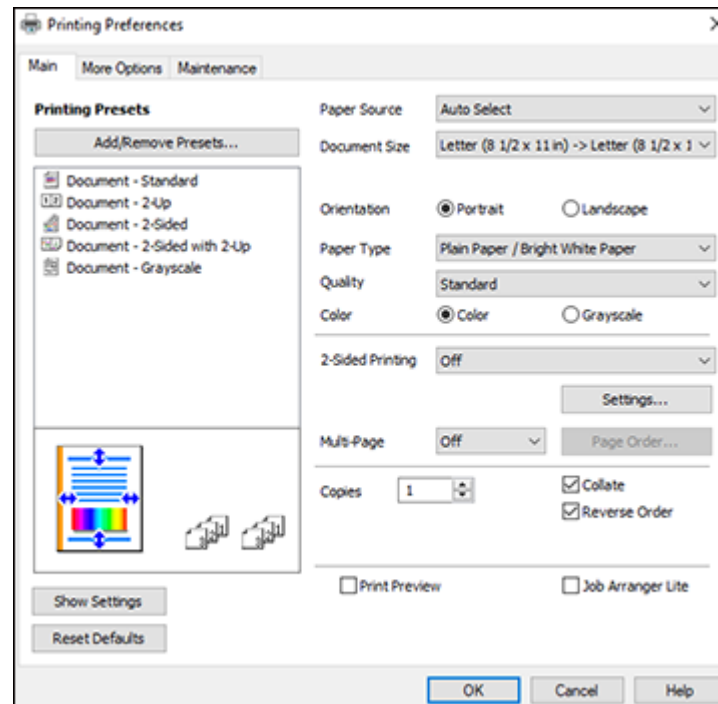

Note: For more information about a setting, right-click it and select **Help**.

4. For the **Paper Source** setting, select where you loaded the paper you want to print on.
5. Select the size of the paper you loaded as the **Document Size** setting.

Note: You can also select the **User-Defined** setting to create a custom paper size.

6. Select the orientation of your document.

Note: If you are printing an envelope, select **Landscape**.

7. Select the type of paper you loaded as the **Paper Type** setting.

Note: The setting may not exactly match the name of your paper. Check the paper type settings list for details.

8. Select the **Quality** setting that matches the print quality you want to use.
9. Select a Color option:
 - To print a color document or photo, select the **Color** setting.
 - To print text and graphics in black or shades of gray, select the **Grayscale** setting.
10. To print on both sides of the paper, select one of the **2-Sided Printing** settings.
11. To print multiple pages on one sheet of paper, or print one image on multiple sheets of paper, select one of the settings in the **Multi-Page** menu and select the printing options you want.
12. To print multiple copies and arrange their print order, select the **Copies** options.
13. To preview your job before printing, select **Print Preview**.
14. To save your print job as a project that can be modified and combined with other print jobs, select **Job Arranger Lite**.

Parent topic: [Printing with the Epson Universal Print Driver - Windows](#)

Selecting Additional Layout and Print Options - Epson Universal Print Driver - Windows

You can select a variety of additional layout and printing options for your document or photo on the **More Options** tab.

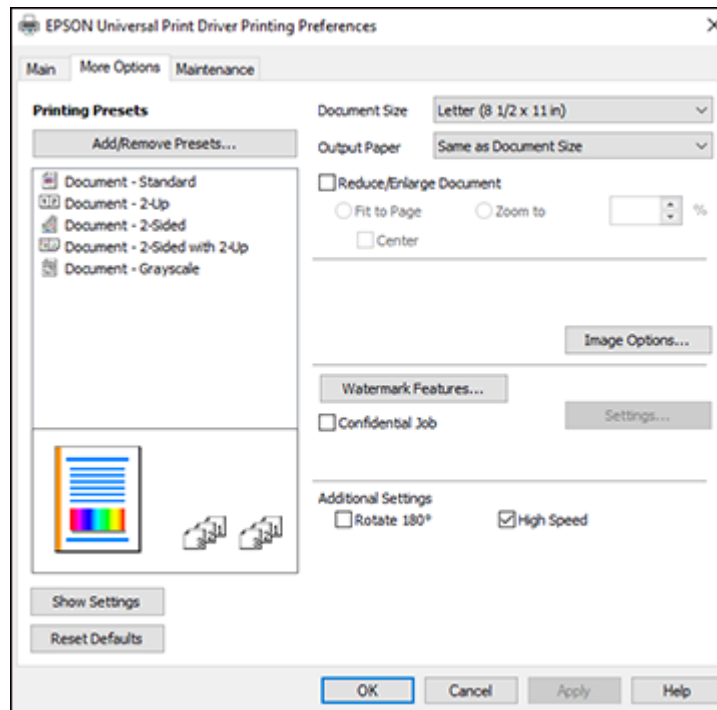

Note: For more information about a setting, right-click it and select **Help**.

1. To change the size of your printed document or photo, select the **Reduce/Enlarge Document** checkbox and select one of these sizing options:
 - Select the **Fit to Page** option to size your image to fit the paper you loaded. Select the size of your document or photo as the **Document Size** setting, and the size of your paper as the **Output Paper** setting. If you want to center your image on the paper, select the **Center** option.
 - Select the **Zoom to** option to reduce or enlarge your document or photo by a specific percentage. Select the percentage in the % menu.

2. Select **Image Options** to access additional settings for improving printed images.

3. To add the following features, click the **Watermark Features** button:

- **Watermark:** adds a visible watermark to your printout.

Note: Click the **Add/Delete** button to create your own watermark, and click the **Settings** button to customize the watermark.

- **Header/Footer:** adds information such as the date and time to the top or bottom of your printout.

Note: Click the **Settings** button to customize the text and location of the header or footer.

4. To add a password to your print job, select the **Confidential Job** checkbox, then enter a password. Confidential jobs are stored in the product's memory without being printed. To print the job, enter the password for the confidential job on the product's control panel.

Note: Confidential print jobs are cleared from the product's memory after printing.

5. Select any of the Additional Settings options to customize your print.

Parent topic: [Printing with the Epson Universal Print Driver - Windows](#)

Selecting Maintenance Options - Epson Universal Print Driver - Windows

You can select maintenance and other optional settings on the **Maintenance** tab.

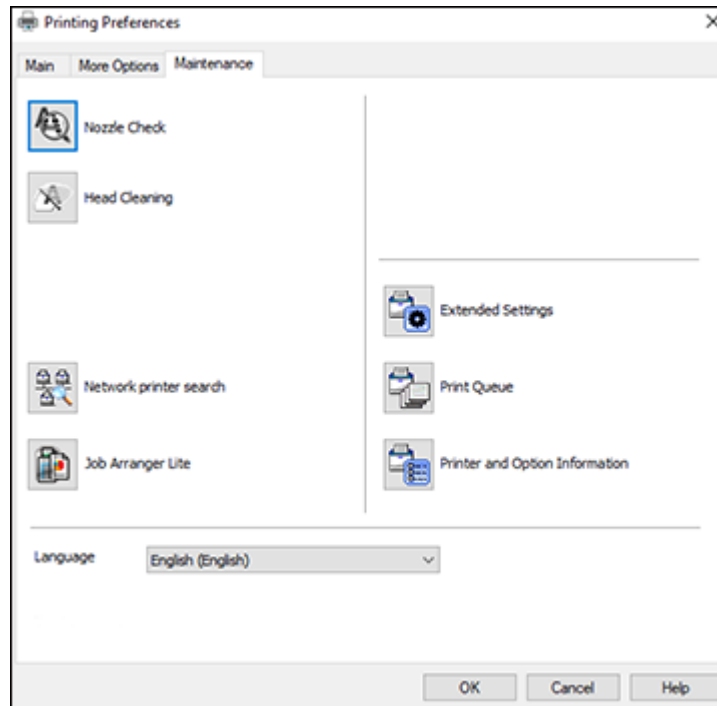

Note: For more information about a setting, right-click it and select **Help**.

- **Nozzle Check** lets you print a nozzle check pattern to check for clogged nozzles.
- **Head Cleaning** lets you clean the print head.
- **Network printer search** lets you search for and connect to a product on the network.
- **Job Arranger Lite** lets you save your print job as a project that can be modified and combined with other print jobs.
- **Extended Settings** lets you change a variety of print settings.
- **Print Queue** displays all the print jobs in queue. You can also cancel or restart print jobs.

- **Printer and Option Information** displays information on the printer settings and any optional equipment installed.
- **Language** lets you change the language of the printer software screens.

[Extended Settings - Epson Universal Print Driver - Windows](#)

Parent topic: [Printing with the Epson Universal Print Driver - Windows](#)

Extended Settings - Epson Universal Print Driver - Windows

You can select from these settings on the Extended Settings window.

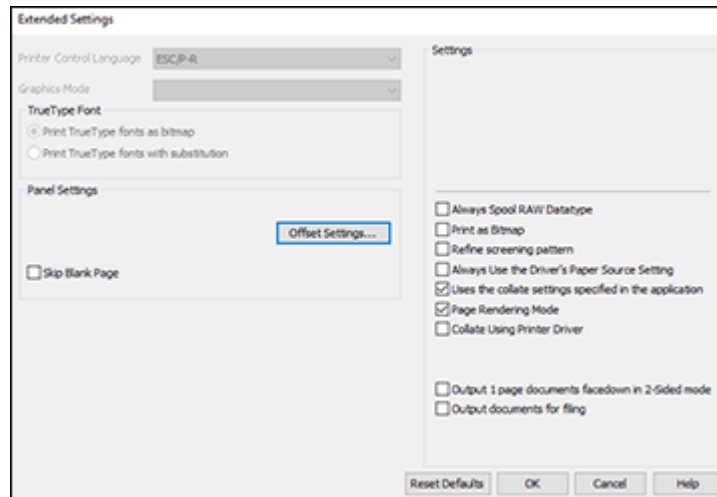

Printer Control Language

Lets you select the printer control language.

Graphics Mode

Lets you select the mode by which to output PDL commands to the product.

TrueType Font

Lets you select how you want to print TrueType fonts.

Offset Settings

Lets you make fine-tune adjustments to the print position of data on your printout.

Skip Blank Page

Ensures that your product does not print pages that contain no text or images.

Always Spool RAW Datatype

Increases print speed and may solve other printing problems.

Print as Bitmap

Increases print speed when printing is extremely slow or the print head stops during printing, and other settings do not help.

Refine screening pattern

Prints graphics with a finer screening pattern.

Always Use the Driver's Paper Source Setting

Prints using the paper source setting in the printer driver, rather than the setting in your application.

Uses the collate settings specified in the application

Prints using the collate setting in your application.

Page Rendering Mode

Increases print speed when printing is extremely slow.

Collate Using Printer Driver

Prints and collates multi-page documents using the printer driver. Deselect this checkbox to use the product to collate your print jobs instead. (This setting is automatically enabled if there is not enough memory on the product to collate your print job.)

Output 1 page documents facedown in 2-Sided mode

Outputs single-sided pages in a 2-sided print job facedown instead of faceup.

Output documents for filing



Outputs all landscape, portrait, 1-sided, and 2-sided documents in the same orientation for easier filing.



Parent topic: [Selecting Maintenance Options - Epson Universal Print Driver - Windows](#)

Selecting Default Print Settings - Epson Universal Print Driver - Windows

When you change your print settings in a program, the changes apply only while you are printing in that program session. If you want to change the print settings you use in all your Windows programs, you can select new default print settings.

1. Do one of the following:

- **Windows 10:** Click  and select  (Settings) > **Devices** > **Printers & scanners**. Select **EPSON Universal Print Driver** and select **Manage** > **Printing Preferences**.
- **Windows 8.x:** Navigate to the **Apps** screen and select **Control Panel** > **Hardware and Sound** > **Devices and Printers**. Right-click **EPSON Universal Print Driver** and select **Print Preferences**.

- **Windows 7:** Click  and select **Devices and Printers**. Right-click **EPSON Universal Print Driver** and select **Printing Preferences**.
- **Windows Vista:** Click  and select **Control Panel**. Click **Printer** under **Hardware and Sound**, right-click **EPSON Universal Print Driver**, and select **Printing Preferences**.

You see the printer settings window:

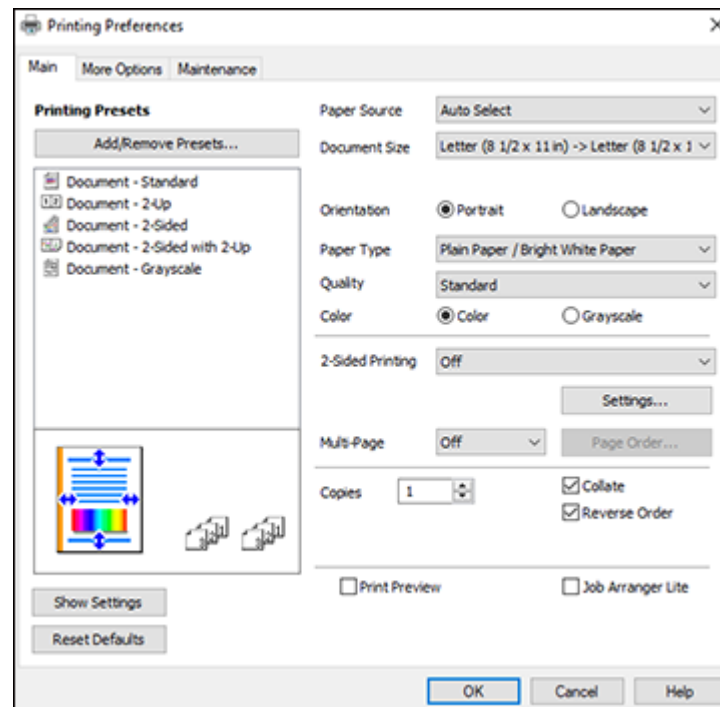

Note: For more information about a setting, right-click it and select **Help**.





2. Select the print settings you want to use as defaults in all your Windows programs.
3. Click **OK**.

These settings are now the defaults selected for printing. You can still change them as needed for printing in any program session.

Parent topic: [Printing with the Epson Universal Print Driver - Windows](#)

Locking Printer Settings - Epson Universal Print Driver - Windows

Administrators can lock some printer settings to prevent unauthorized changes.

1. Do one of the following:
 - **Windows 10:** Click  and select  (Settings) > **Devices** > **Printers & scanners**. Select **EPSON Universal Print Driver** and select **Manage** > **Printer properties**.
 - **Windows 8.x:** Navigate to the **Apps** screen and select **Control Panel** > **Hardware and Sound** > **Devices and Printers**. Right-click **EPSON Universal Print Driver** and select **Printer properties**.
 - **Windows 7:** Click  and select **Devices and Printers**. Right-click **EPSON Universal Print Driver** and select **Printer properties**.
 - **Windows Vista:** Click  and select **Control Panel**. Click **Printer** under **Hardware and Sound**, then right-click **EPSON Universal Print Driver** and select **Properties**.
2. Click the **Optional Settings** tab.
3. Click **Driver Settings**.

You see this window:

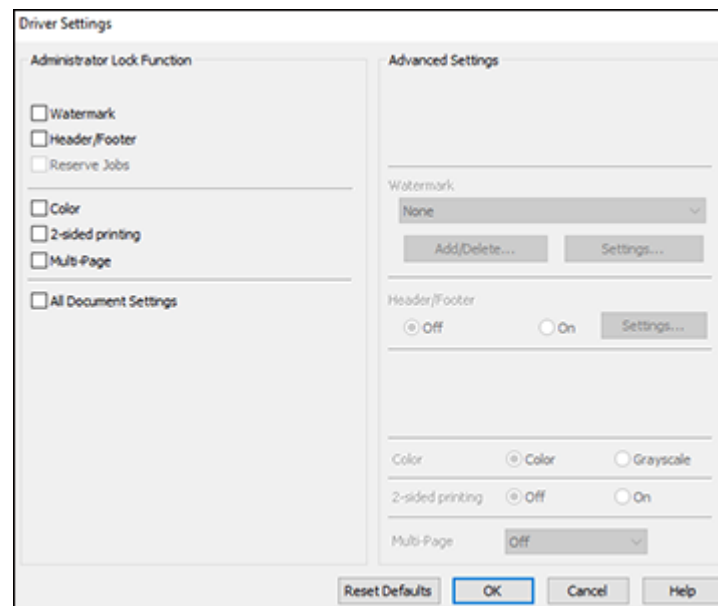

4. Select the checkbox for the settings you want to lock. To lock all print settings, select **All Document Settings**.
5. Under **Advanced Settings**, select the setting option you want to use for each locked setting.
6. Click **OK**.

[Epson Universal Print Driver Locked Setting Options](#)

Parent topic: [Printing with the Epson Universal Print Driver - Windows](#)

Epson Universal Print Driver Locked Setting Options

Select the options you want to use for any locked print settings.





Setting	Options	Description
Watermark	Various text watermarks	Lets you select the text for the watermark or prohibit watermarks
	Add/Delete	Lets you add or delete a customized text or image-based watermark
	Settings	Lets you select the size, position, and other watermark settings
Header/Footer	Off	Prohibits headers or footers
	On	Allows headers and footers
	Settings	Lets you select the text and position for printing headers and footers
Color	Color	Allows color printing
	Grayscale	Allows printing in black or shades of gray only
2-sided printing	Off	Allows printing on only one side of the paper
	On	Allows printing on both sides of the paper
Multi-Page	Off	Prohibits multi-page settings
	2-Up	Allows printing of 2 pages on one sheet of paper
	4-Up	Allows printing of 4 pages on one sheet of paper

Parent topic: [Locking Printer Settings - Epson Universal Print Driver - Windows](#)

Adding Network Printers - Epson Universal Print Driver - Windows

You can use the Epson Universal Print Driver to find and add network printers.

1. Do one of the following:

- **Windows 10:** Click  and select  (Settings) > **Devices** > **Printers & scanners**. Select **EPSON Universal Print Driver** and select **Manage** > **Printer properties**.
- **Windows 8.x:** Navigate to the **Apps** screen and select **Control Panel** > **Hardware and Sound** > **Devices and Printers**. Right-click **EPSON Universal Print Driver** and select **Printer properties**.
- **Windows 7:** Click  and select **Devices and Printers**. Right-click **EPSON Universal Print Driver** and select **Printer properties**.
- **Windows Vista:** Click  and select **Control Panel**. Click **Printer** under **Hardware and Sound**, then right-click **EPSON Universal Print Driver** and select **Properties**.

2. Click the **Optional Settings** tab.

You see this window:

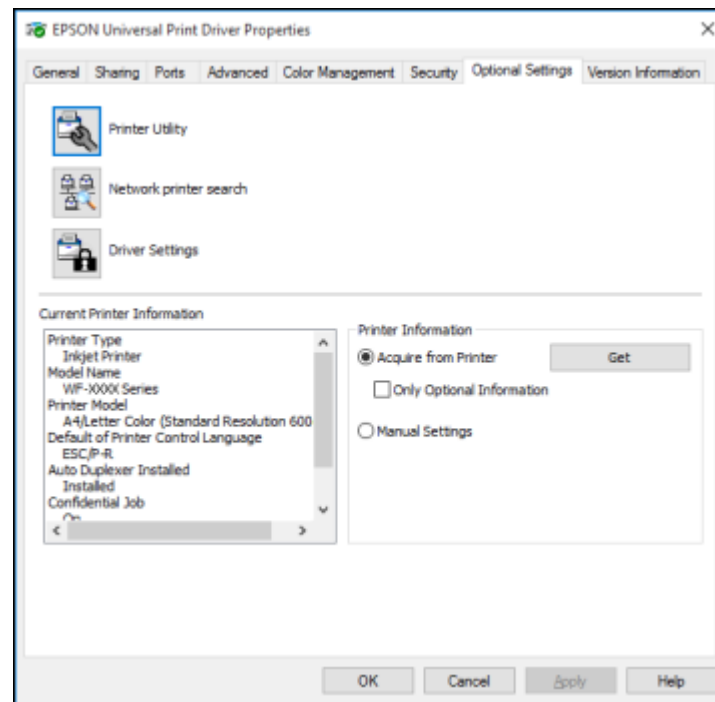

3. Click **Network printer search**.
4. When you see the search results, select **Add found printers**.
You see a screen like this:

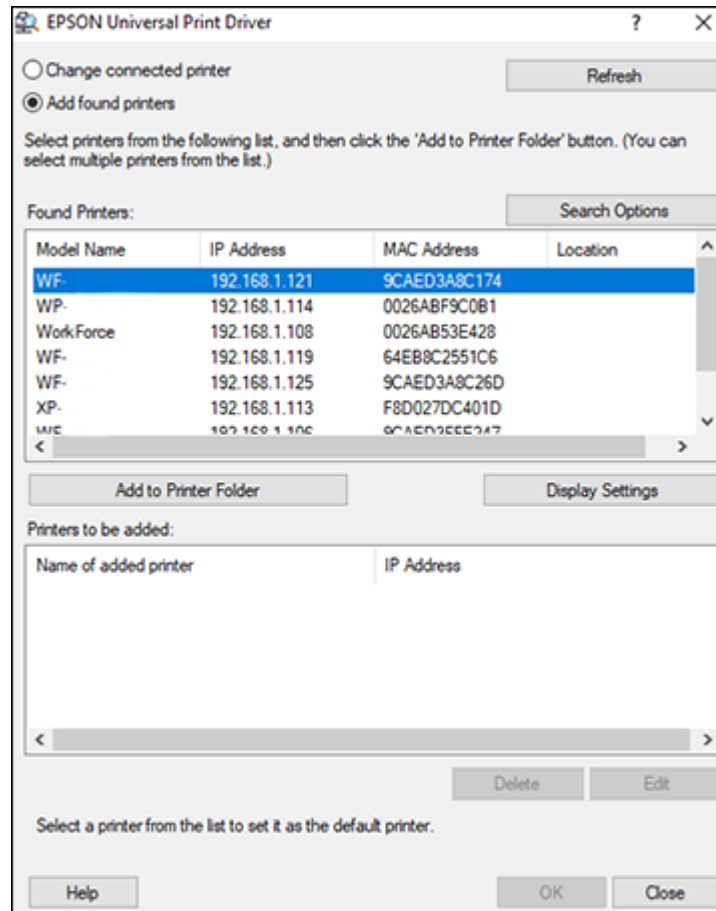

5. Select the printer or printers you want to add.
6. Click **Add to Printer Folder**.
The selected printer or printers appear in the lower section of the screen.
7. Select the checkbox next to the product you want to make your default printer, if necessary.

8. Click **OK**.

Parent topic: [Printing with the Epson Universal Print Driver - Windows](#)

Printing with the PostScript (PS3) Printer Software - Windows

You can print with the PostScript (PS3) printer software using any Windows printing program, as described in these sections.

Note: The PostScript printer software supports products that are connected via Ethernet. If your product is connected via USB, you will need to install the standard Epson printer software. To download the standard Epson printer software, visit epson.com/support (U.S.), epson.ca/support (Canada), or epson.com.jm/support (Caribbean) and select your product.

[Enabling the Optional Paper Cassettes - PostScript Printer Software - Windows](#)

[Selecting Basic Print Settings - PostScript Printer Software - Windows](#)

[Selecting Additional Layout and Print Options - PostScript Printer Software - Windows](#)





[Selecting Default Print Settings - PostScript Printer Software - Windows](#)

Parent topic: [Printing from a Computer](#)

Enabling the Optional Paper Cassettes - PostScript Printer Software - Windows

If you installed optional paper cassette units, you need to enable the optional cassette units before you can use them with the PS3 printer software.

1. Do one of the following:

- **Windows 10:** Click  and select  (Settings) > **Devices** > **Printers & scanners** . Select your product name and select **Manage** > **Printer properties**.
- **Windows 8.x:** Navigate to the **Apps** screen and select **Control Panel** > **Hardware and Sound** > **Devices and Printers**. Right-click your product name and select **Printer properties**.
- **Windows 7:** Click  and select **Devices and Printers**. Right-click your product name and select **Printer Properties**.
- **Windows Vista:** Click  and select **Control Panel**. Click **Printer** under **Hardware and Sound**, then right-click your product name, and select **Properties**.

2. Click the **Device Settings** tab.

You see a window like this:

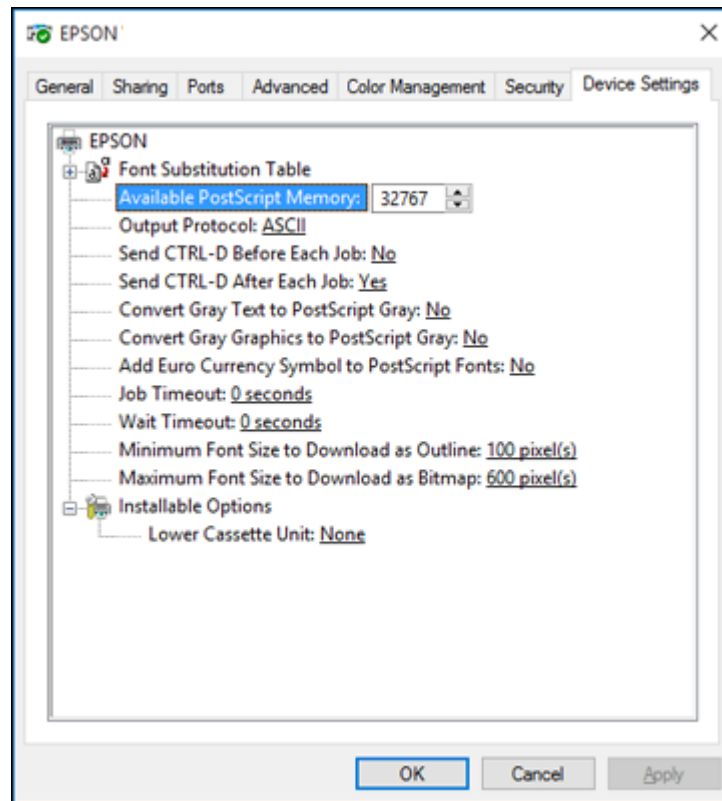

3. Select the number of optional cassettes installed as the Lower Cassette Unit setting.
4. Click **OK**.

The optional paper cassettes are now enabled.

Parent topic: [Printing with the PostScript \(PS3\) Printer Software - Windows](#)

Selecting Basic Print Settings - PostScript Printer Software - Windows

Select the basic settings for the document or photo you want to print.

The PostScript printer software supports plain paper printing on these paper and envelope sizes:

- Letter (8.5 × 11 inches [216 × 279 mm])

- A4 (8.3 × 11.7 inches [210 × 297 mm])
 - Legal (8.5 × 14 inches [216 × 356 mm])
 - A5 (5.8 × 8.2 inches [148 × 210 mm])
 - B5 (7.2 × 10.1 inches [182 × 257 mm])
 - A6 (4.1 × 5.8 inches [105 × 148 mm])
 - B6 (5 × 7.2 inches [128 × 182 mm])
 - Executive (7.25 × 10.5 inches [184 × 267 mm])
 - Folio (8.5 × 13 inches [216 × 330 mm])
 - No. 10 (4.1 × 9.5 inches [105 × 241 mm])
1. Open a photo or document for printing.
 2. Select the print command in your application.

Note: You may need to select a print icon on your screen, the **Print** option in the **File** menu, or another command. See your application's help utility for details.

3. If necessary, select your product name as the printer you want to use, and then click the **Preferences** button.

You see the **Paper/Quality** tab of your printer settings window:

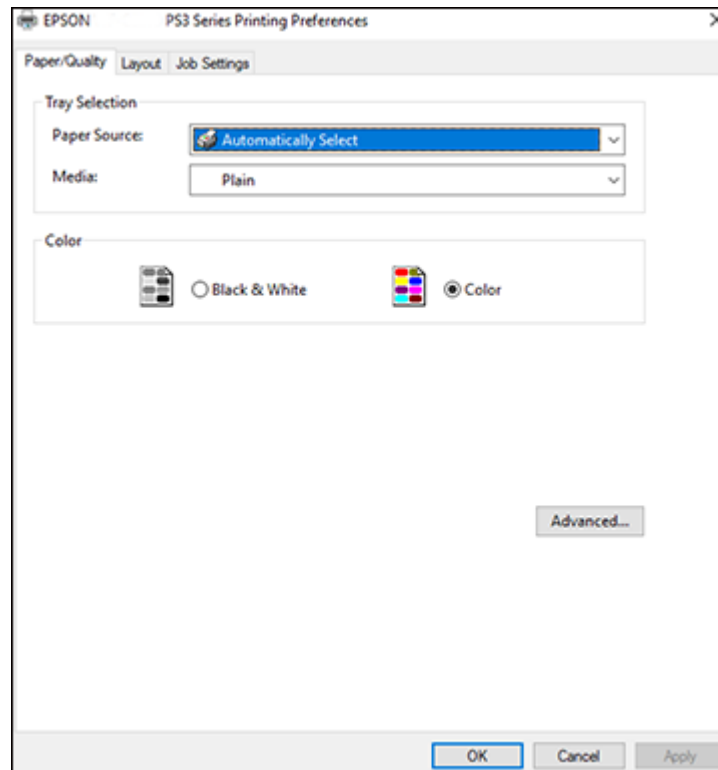

4. Select the **Paper Source** that matches where you loaded the paper you want to print on.
5. Select **Plain** as the **Media** setting.
6. Select one of the following as the Color setting:
 - To print a color document or photo, select the **Color** setting.
 - To print text and graphics in black only, select the **Black & White** setting.
7. Click the **Layout** tab.

You see this window:

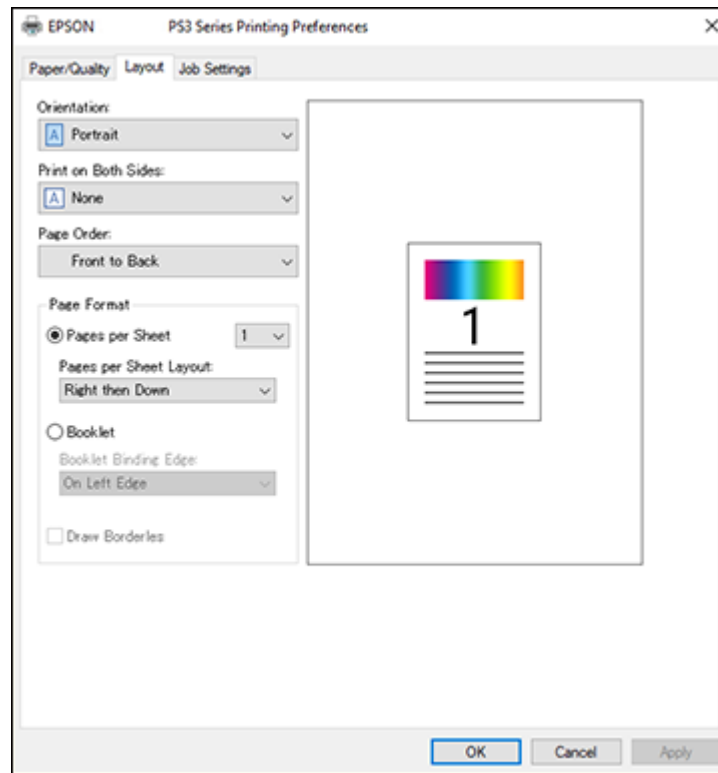

8. Select the orientation of your document.
9. To print on both sides of the paper, select one of the **Print on Both Sides** settings.
10. To change the printing order of the pages, select one of the **Page Order** settings.
11. To print multiple pages on one sheet of paper, adjust the **Pages per Sheet** setting.
12. To create a folded booklet out of your photo or document, select the **Booklet** option.

Parent topic: [Printing with the PostScript \(PS3\) Printer Software - Windows](#)

Selecting Additional Layout and Print Options - PostScript Printer Software - Windows

You can select a variety of additional layout and printing options for your document or photo by clicking the **Advanced** button on the **Paper/Quality** tab.

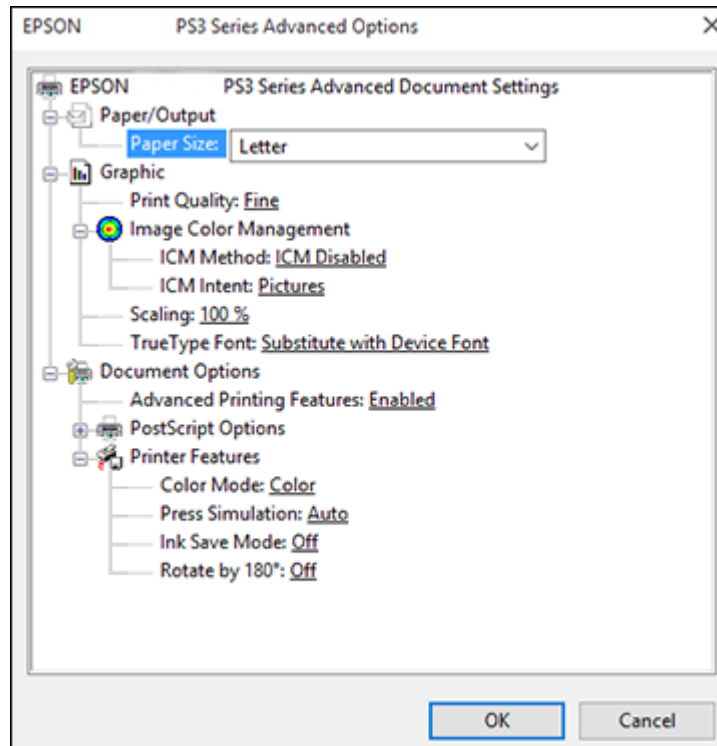

1. Select the size of the paper you loaded as the **Paper Size** setting.
2. Select the **Print Quality** option that matches the print quality you want to use.
3. To use the Windows Image Color Management system, set the **ICM Method** setting to one of the **ICM Handling** options and select the **ICM Intent** setting you want to use.
4. Adjust the **Scaling** setting to reduce or enlarge your document or photo by a specific percentage.
5. Select the **TrueType Font** setting to determine font substitutes.
6. Enable the **Advanced Printing Features** setting to allow detailed settings for printing features.
7. Expand the PostScript Options heading to access the advanced PostScript printer software features.





8. Select any of the remaining **Printer Features** options to customize your printouts.

Parent topic: [Printing with the PostScript \(PS3\) Printer Software - Windows](#)

Selecting Default Print Settings - PostScript Printer Software - Windows

When you change your print settings in a program, the changes apply only while you are printing in that program session. If you want to change the print settings you use in all your Windows programs, you can select new default print settings.

1. Do one of the following:

- **Windows 10:** Click  and select  (Settings) > **Devices** > **Printers & scanners**. Select your product name and select **Manage** > **Printing preferences**.
- **Windows 8.x:** Navigate to the **Apps** screen and select **Control Panel** > **Hardware and Sound** > **Devices and Printers**. Right-click your product name and select **Print Preferences**.
- **Windows 7:** Click  and select **Devices and Printers**. Right-click your product name and select **Printing Preferences**.
- **Windows Vista:** Click  and select **Control Panel**. Click **Printer** under **Hardware and Sound**, right-click your product name, and select **Printing Preferences**.

2. Click the **Layout** tab.

You see the printer settings window:

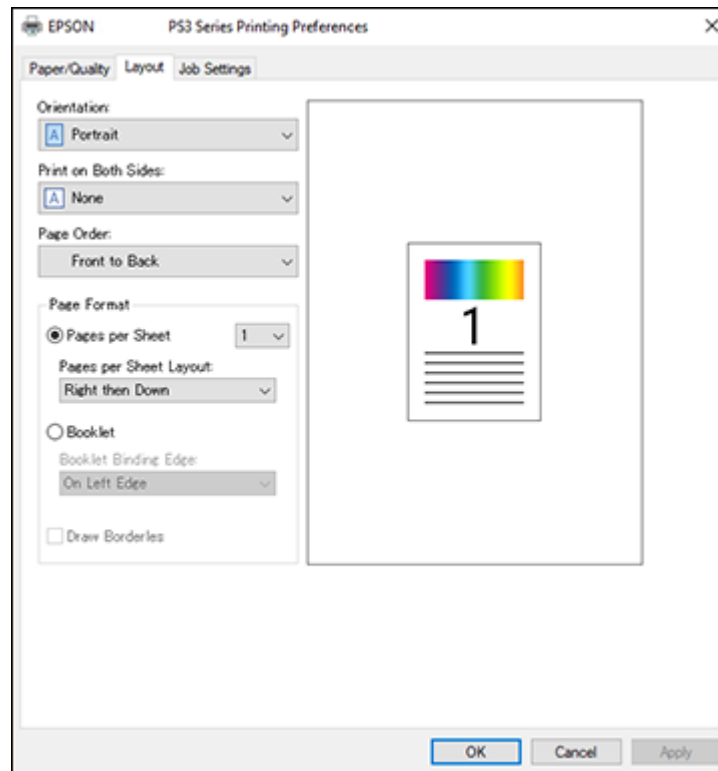

3. Select the print settings you want to use as defaults in all your Windows programs.
4. Click **OK**.

These settings are now the defaults selected for printing. You can still change them as needed for printing in any program session.

Parent topic: [Printing with the PostScript \(PS3\) Printer Software - Windows](#)

Printing with the PostScript (PS3) Printer Software - Mac

You can print with the PostScript (PS3) printer software using any Mac printing program, as described in these sections.

Note: The PostScript printer software supports products that are connected via Ethernet. If your product is connected via USB, you will need to install the standard Epson printer software. To download the standard Epson printer software, visit epson.com/support (U.S.), epson.ca/support (Canada), or epson.com.jm/support (Caribbean) and select your product.

[Enabling the Optional Paper Cassettes - PostScript Printer Software - Mac](#)

[Selecting Basic Print Settings - PostScript Printer Software - Mac](#)

[Selecting Page Setup Settings - PostScript Printer Software - Mac](#)

[Selecting Print Layout Options - PostScript Printer Software - Mac](#)

[Sizing Printed Images - PostScript Printer Software - Mac](#)

[Managing Color - PostScript Printer Software - Mac](#)

[Printing Your Document or Photo - PostScript Printer Software - Mac](#)

Parent topic: [Printing from a Computer](#)

Enabling the Optional Paper Cassettes - PostScript Printer Software - Mac

If you installed optional paper cassette units, you need to enable the optional cassette units before you can use them with the PS3 printer software.

1. In the Apple menu or the Dock, select **System Preferences**.
2. Select **Print & Fax**, **Print & Scan**, or **Printers & Scanners**, select your product, and select **Options & Supplies**.
3. Select **Driver** or **Options**.

You see a screen like this:

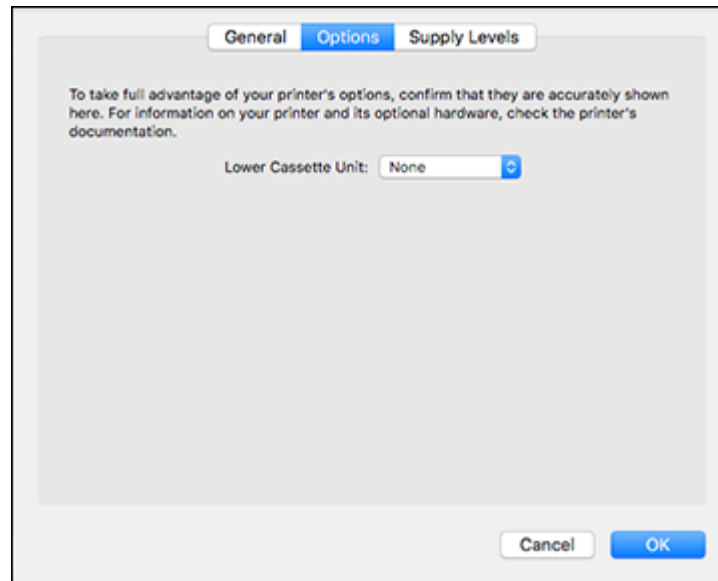

4. Select the number of optional cassettes installed as the Lower Cassette Unit setting.
5. Click **OK**.

The optional paper cassettes are now enabled.

Parent topic: [Printing with the PostScript \(PS3\) Printer Software - Mac](#)

Selecting Basic Print Settings - PostScript Printer Software - Mac

Select the basic settings for the document or photo you want to print.

The PostScript printer software supports plain paper printing on these paper and envelope sizes:

- A4 (8.3 × 11.7 inches [210 × 297 mm])
- Letter (8.5 × 11 inches [216 × 279 mm])
- No. 10 (4.1 × 9.5 inches [105 × 241 mm])
- A5 (5.8 × 8.2 inches [148 × 210 mm])
- B5 (7.2 × 10.1 inches [182 × 257 mm])

- A6 (4.1 × 5.8 inches [105 × 148 mm])
- B6 (5 × 7.2 inches [128 × 182 mm])
- Executive (7.25 × 10.5 inches [184 × 267 mm])
- Legal (8.5 × 14 inches [216 × 356 mm])
- Folio (8.5 × 13 inches [216 × 330 mm])

1. Open a photo or document for printing.
2. Select the print command in your application.

Note: You may need to select a print icon on your screen, the **Print** option in the **File** menu, or another command. See your application's help utility for details.

3. Select your product as the **Printer** setting.

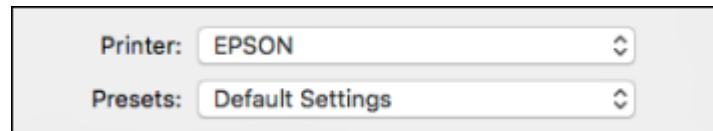

4. If necessary, click the arrow next to the Printer setting or the **Show Details** button to expand the print window.

You see the expanded printer settings window for your product:

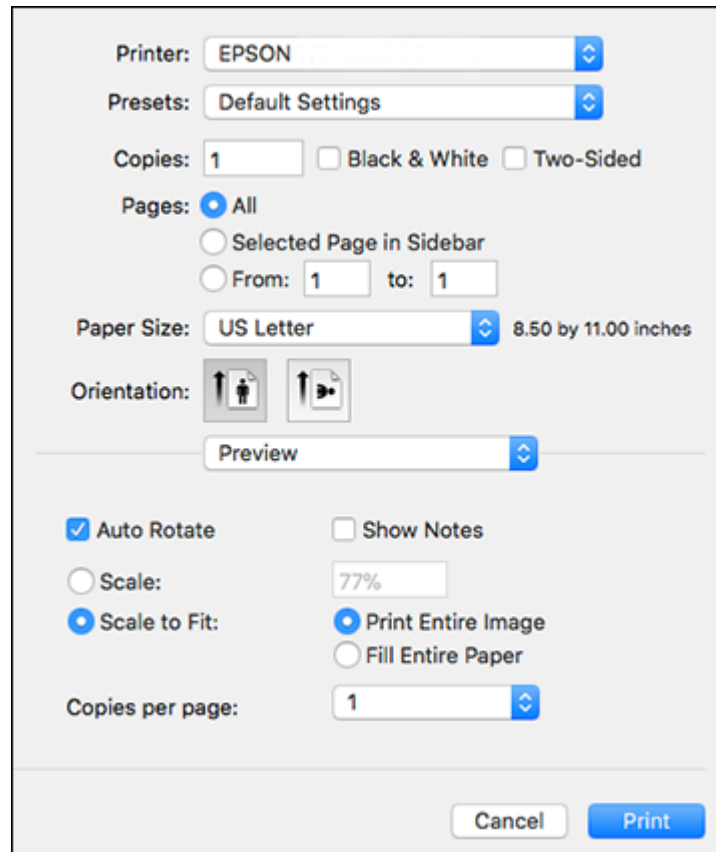

Note: The print window may look different, depending on the Mac OS version and the application you are using.

5. Select the **Copies**, **Black & White**, **Two-Sided**, and **Pages** settings as necessary.

Note: If you do not see these settings in the print window, check for them in your application before printing.

6. Select the page setup options: **Paper Size** and **Orientation**.

Note: If you do not see these settings in the print window, check for them in your application before printing. They may be accessible by selecting **Page Setup** from the File menu.

7. Select any application-specific settings that appear on the screen, such as those shown in the image above for the Preview application.
8. Select **Paper Feed** from the pop-up menu.

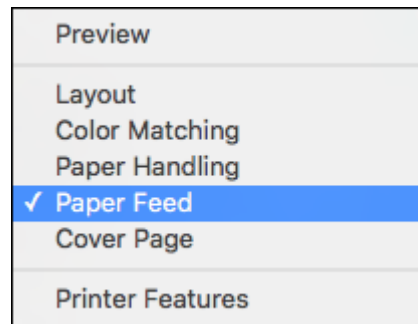

You see these settings:

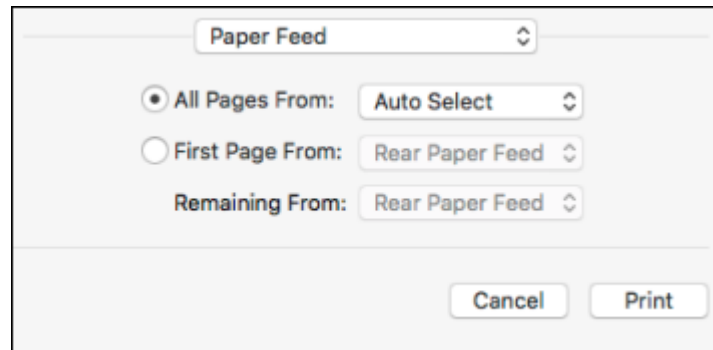

9. Select **All Pages From** or **First Page From** and select the paper source you want to print from.

10. Select **Printer Features** from the pop-up menu.

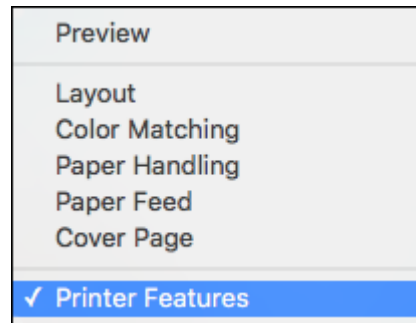

You see these settings:

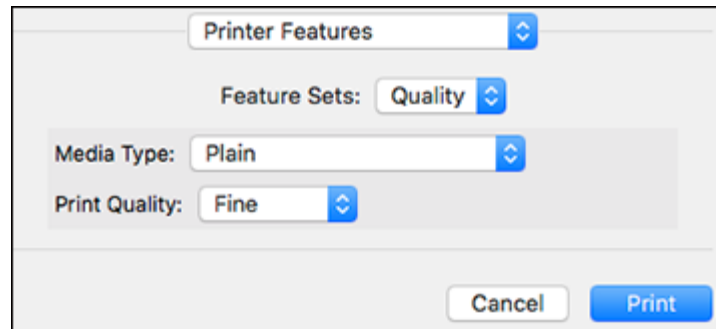

11. Select **Plain** as the **Media Type** setting.

12. Select one of the following **Print Quality** options:

- For fast printing with reduced quality, select **Fast**.
- For printing text and graphics with good quality and print speed, select **Fine**.
- For the best printing with reduced speed, select **Maximum**.

13. Select **Color** from the Feature Sets pop-up menu.

You see these settings:

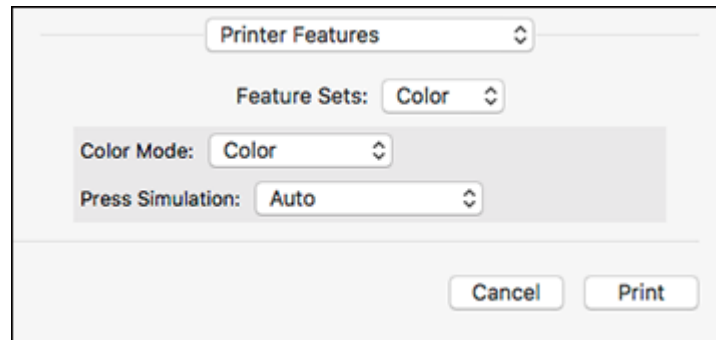

14. Select a **Color Mode** option:

- To print a color document or photo, select the **Color** setting.
- To print text and graphics in black only, select the **Monochrome** setting.

15. Select any of the available print options.

Parent topic: [Printing with the PostScript \(PS3\) Printer Software - Mac](#)

Selecting Page Setup Settings - PostScript Printer Software - Mac

Depending on your application, you may be able to select the paper size and orientation settings from the print window.

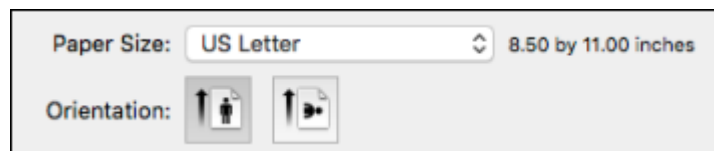

Note: If you do not see these settings in the print window, check for them in your application before printing. They may be accessible by selecting **Page Setup** from the File menu.

1. Select the size of the paper you loaded as the **Paper Size** setting. You can also select a custom setting to create a custom paper size.
2. Select the orientation of your document or photo as shown in the print window.

Note: You can reduce or enlarge the size of the printed image by selecting **Paper Handling** from the pop-up menu and selecting a scaling option.

Parent topic: [Printing with the PostScript \(PS3\) Printer Software - Mac](#)

Selecting Print Layout Options - PostScript Printer Software - Mac

You can select a variety of layout options for your document or photo by selecting **Layout** from the pop-up menu on the print window.

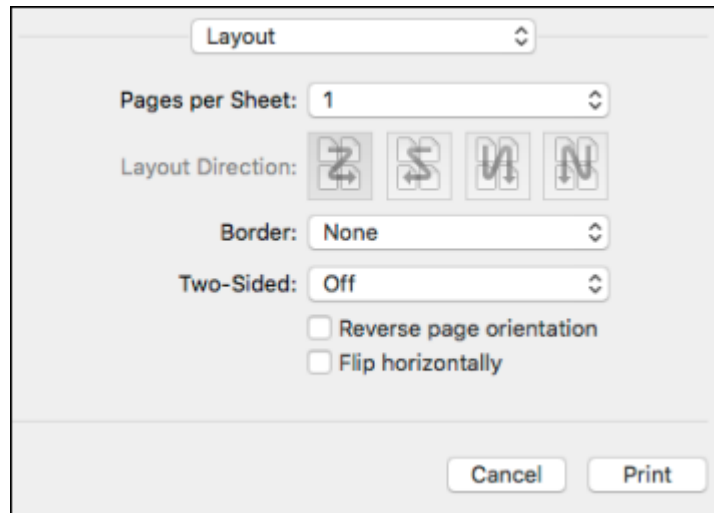

- To print multiple pages on one sheet of paper, select the number of pages in the **Pages per Sheet** pop-up menu. To arrange the print order of the pages, select a **Layout Direction** setting.
- To print borders around each page on the sheet, select a line setting from the **Border** pop-up menu.
- To print on both sides of the page, select one of the **Two-Sided** settings.
- To invert or flip the printed image, select the **Reverse page orientation** or **Flip horizontally** settings.

Parent topic: [Printing with the PostScript \(PS3\) Printer Software - Mac](#)

Sizing Printed Images - PostScript Printer Software - Mac

You can adjust the size of the image as you print it by selecting **Paper Handling** from the pop-up menu on the Print window.

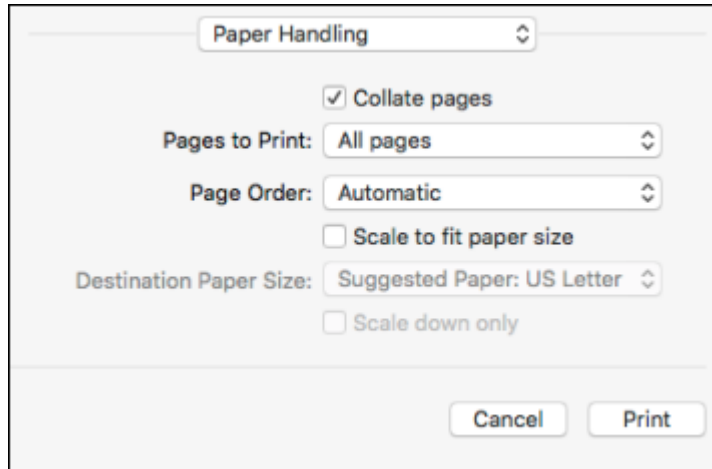

- To print only selected pages in a multi-page document, select an option from the **Pages to Print** pop-up menu.
- To adjust the order in which pages are printed, select an option from the **Page Order** pop-up menu.
- To scale the image to fit on a specific paper size, select the **Scale to fit paper size** checkbox and select a paper size from the **Destination Paper Size** pop-up menu.

Parent topic: [Printing with the PostScript \(PS3\) Printer Software - Mac](#)

Managing Color - PostScript Printer Software - Mac

You can adjust the Color Matching settings to fine-tune the colors in your printout.

1. Select **Color Matching** from the pop-up menu in the print window.

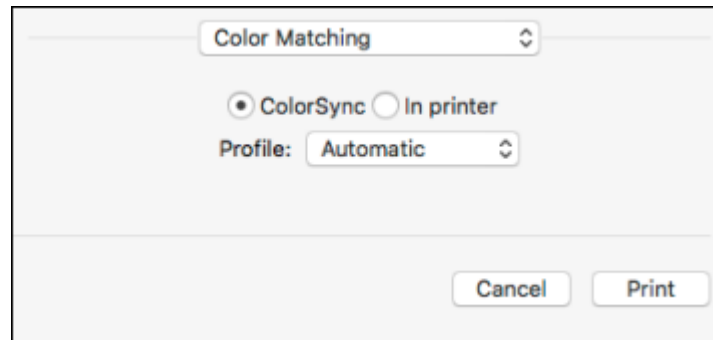

2. Do one of the following:
 - To print using standard color profiles for your product and paper to help match image colors, select **ColorSync**. Select one of the available **Profile** options to change the active color profile.
 - To use the product's default color matching, select **In printer**.

Parent topic: [Printing with the PostScript \(PS3\) Printer Software - Mac](#)

Printing Your Document or Photo - PostScript Printer Software - Mac

Once you have selected your print settings, you are ready to print.

Click **Print** at the bottom of the print window.

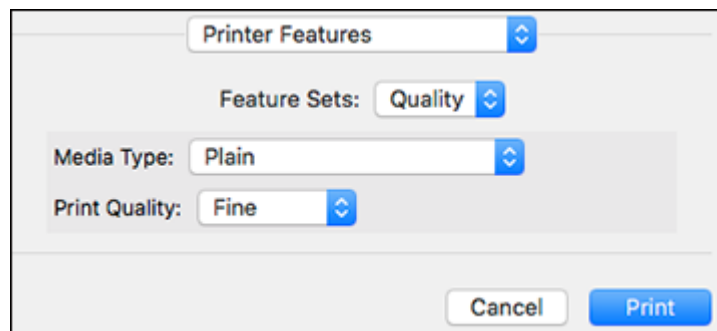

[Checking Print Status - PostScript Printer Software - Mac](#)

Parent topic: [Printing with the PostScript \(PS3\) Printer Software - Mac](#)

Checking Print Status - PostScript Printer Software - Mac



During printing, you can view the progress of your print job, control printing, and check ink status.

1. Click the printer icon when it appears in the Dock.

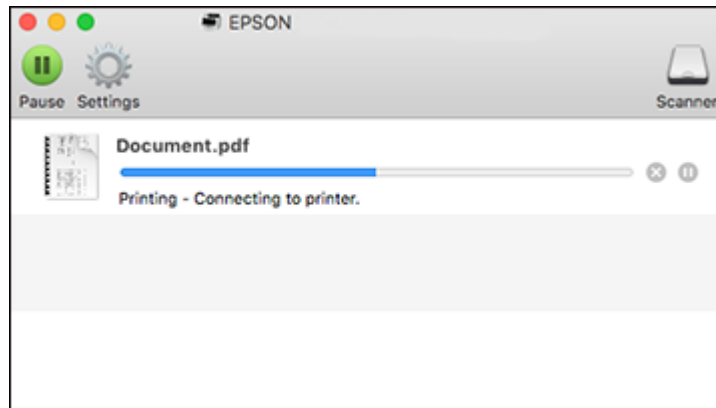
You see the print status window:



2. Select the following options as necessary for your Mac OS version:

- To cancel printing, click the print job and click  or **Delete**.
- To pause a print job, click the print job and click  or **Hold**. To resume a print job, click the paused print job and click  or **Resume**.
- To pause printing for all queued print jobs, click **Pause** or **Pause Printer**.
- To display other printer information, click **Settings** or **Supply Levels**.

Parent topic: [Printing Your Document or Photo - PostScript Printer Software - Mac](#)

Cancelling Printing Using a Product Button

If you need to cancel printing in progress, press the  stop button.

If you want to cancel stored jobs or jobs waiting to print, follow the instructions below.

1. Press the  **Job/Status** button.

2. Select the **Active** tab.
3. Select the job you want to cancel and select **Cancel**.

Parent topic: [Printing from a Computer](#)

Scanning

You can scan your originals and save them as digital files.

[Starting a Scan](#)

[Scanning with Document Capture or Document Capture Pro](#)

[Scanning in Epson Scan 2](#)

[Scanning Special Projects](#)

Starting a Scan

After placing your originals on your product for scanning, start scanning using one of these methods.

Note: You can also scan using Document Capture Pro (Windows) or Document Capture (Mac).

[Starting a Scan Using the Product Control Panel](#)

[Starting a Scan Using the Epson Scan 2 Icon](#)

[Starting a Scan from a Scanning Program](#)

[Starting a Scan from a Smart Device](#)

[Entering a User ID and Password for Scanning](#)

Parent topic: [Scanning](#)

Starting a Scan Using the Product Control Panel

You can scan an image to a variety of destinations using your product's control panel.

1. Make sure you installed the product software and connected the product to your computer or network.

Note: Restart your computer after installing the product software to enable scanning from the control panel.

2. Place your original on the product for scanning.

Note: To scan a double-sided or multi-page document, place your originals in the ADF.

3. Press the  home button, if necessary.
4. Select **Scan**.

You see a screen like this:

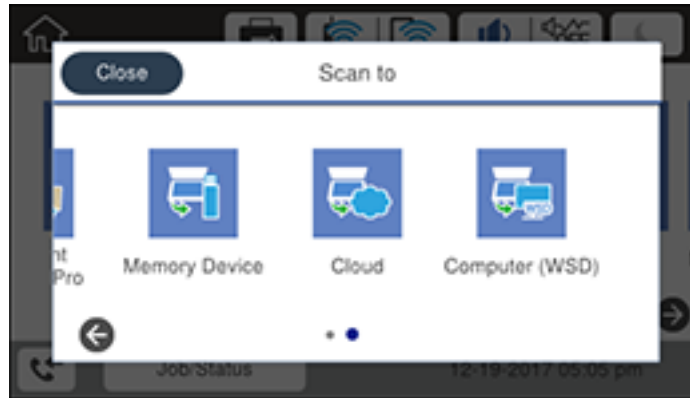

5. Select one of the following **Scan to** options:
 - **Network Folder/FTP** saves your scan file to a specified folder on a network.
 - **Email** lets you send scanned files through a pre-configured email server.
 - **Document Capture Pro** lets you scan over a network using your saved job settings in Document Capture Pro or Document Capture.

Note: You cannot use this option to scan an image to Document Capture or Document Capture Pro when your product is connected to your computer's USB port.

- **Memory Device** saves your scan file on a USB device inserted in your product's external USB port and lets you select the file format, quality, and other settings.
 - **Cloud** sends your scanned files to a destination that you have registered with Epson Connect.
 - **Computer (WSD)** lets you manage network scanning in Windows 10, Windows 8.x, Windows 7, or Windows Vista (English only). To use this feature on Windows 7 or Windows Vista, you must first set up WSD (Web Services for Devices) on the computer.
6. Follow the instructions in the links below to complete your scan.

[Scanning to a Network Folder or FTP Server](#)

[Scanning to Email](#)

[Adding and Assigning Scan Jobs with Document Capture Pro - Windows](#)

[Adding and Assigning Scan Jobs with Document Capture - Mac](#)

[Scanning to a Memory Device](#)

[Scanning to the Cloud](#)

[Scanning Using Web Services for Devices \(WSD\) - Windows](#)

[Control Panel Scanning Options](#)

Parent topic: [Starting a Scan](#)

Related tasks

[Using Presets](#)

[Entering Characters on the LCD Screen](#)

[Using Epson Scan to Cloud](#)

Related topics

[Placing Originals on the Product](#)

Scanning to a Network Folder or FTP Server

You can scan an image and save it to a network folder using your product's control panel. You can either enter the folder path directly on the product's control panel or select a folder from the **Contacts** list.

Note: Make sure the date and time are set correctly before using this feature.

1. Place your original on the product for scanning.

Note: To scan a double-sided or multi-page document, place your originals in the ADF.

2. Press the  home button, if necessary.
3. Select **Scan**.

You see a screen like this:

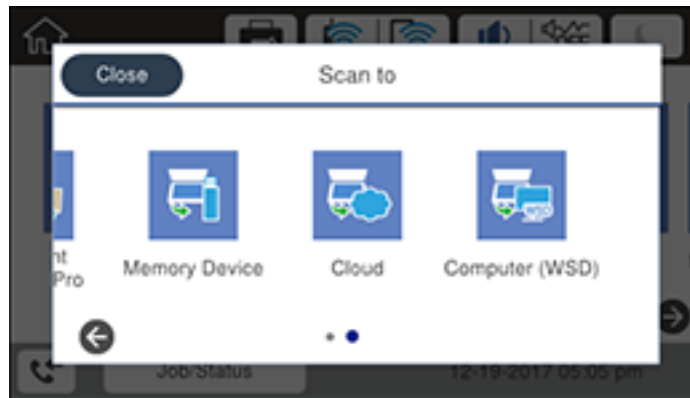

4. Select **Network Folder/FTP**.

You see a screen like this:

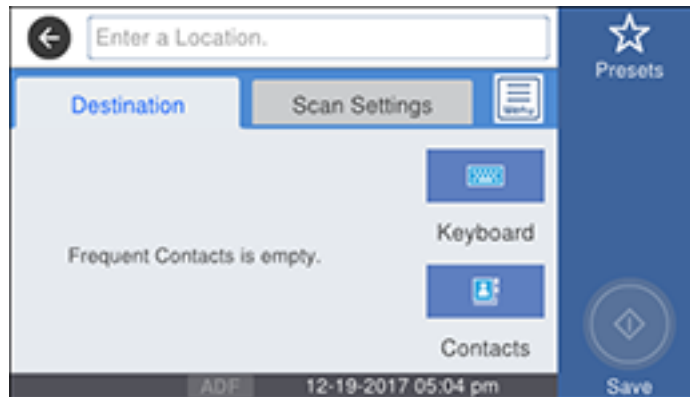

5. Do one of the following:
 - Select from any displayed frequent contacts.
 - Select **Keyboard**, select the **Communication Mode** field, and select **Network Folder (SMB)** or **FTP**. Then select the **Location** field and enter the folder location, and press **OK**. Enter other information as necessary.

Enter the folder path name for the **Location** setting in one of the following formats depending on the **Communication Mode** setting you selected:

- **SMB:** \\host name\folder
 - **FTP:** ftp://host name/folder name
 - Select **Contacts** and choose a saved folder from the **Contacts** list.
6. Select **Scan Settings**.
 7. Select **File Format** to choose the file format for your scan.
 8. Scroll down and change the **File Name** setting, if necessary.
 9. Select any additional scan settings as necessary.
 10. Select **Presets** to save your scan settings.

Note: Presets can be locked by an administrator. If you cannot access or change this setting, contact your administrator for assistance.

11. Press the **Save** icon.

Your product scans your original and saves it in the selected location.

Parent topic: [Starting a Scan Using the Product Control Panel](#)

Related tasks

[Entering Characters on the LCD Screen](#)

Related topics

[Setting Up Contacts Using the Product Control Panel](#)

Scanning to Email

You can scan an original and email the scanned file using your product's control panel. You need to have a preconfigured email server before you can scan to email. You can either enter the email address directly on the product's control panel or select an address from the **Contacts** list. Make sure the date and time are set correctly so the time stamps on your emails are accurate.

Note: You can also use the Scan to Document Capture Pro function to scan and email the scanned file.

1. Place your original on the product for scanning.

Note: To scan a double-sided or multi-page document, place all of the pages in the ADF.

2. Press the  home button, if necessary.
3. Select **Scan**.

You see a screen like this:

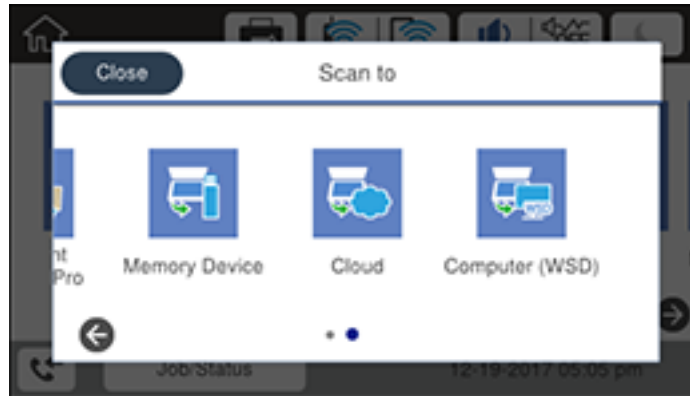

4. Select **Email**.

You see a screen like this:

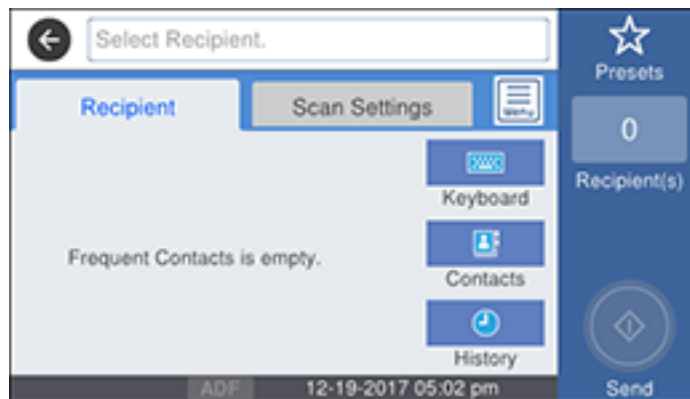

5. Do one of the following:
 - Select from any displayed frequent contacts.

- Select **Keyboard** to use the displayed keyboard to enter the address for the recipient and press **OK**.
 - Select **Contacts** and choose an email address from the **Contacts** list.
 - Select **History** to choose an email address from your recent scan history.
6. Select **Scan Settings**.
 7. Select **File Format** to choose the file format for your scan.
 8. Scroll down and change the **Subject** and **File Name** settings, if necessary.
 9. Select any additional scan settings as necessary.
 10. Select **Presets** to save your scan settings.

Note: Presets can be locked by an administrator. If you cannot access or change this setting, contact your administrator for assistance.

11. Press the **Send** icon.

Your product scans your original and emails the scanned file.

Parent topic: [Starting a Scan Using the Product Control Panel](#)

Related tasks

[Entering Characters on the LCD Screen](#)

[Configuring Email Server Settings](#)

Related topics

[Setting Up Contacts Using the Product Control Panel](#)

[Placing Originals on the Product](#)

Adding and Assigning Scan Jobs with Document Capture Pro - Windows

You can use Document Capture Pro to create, edit, and delete scan jobs. Scan jobs allow you to save commonly-used scanning options. You can also determine which scan jobs are listed when you scan to Document Capture Pro using the control panel on your product.

Note: The settings may vary, depending on the software version you are using. See the help information in Document Capture Pro for details.

1. Do one of the following to start Document Capture Pro:
 - **Windows 10:** Click  and select **Epson Software > Document Capture Pro**.

- **Windows 8.x:** Navigate to the **Apps** screen and select **Document Capture Pro**.
- **Windows (other versions):** Click  or **Start**, and select **All Programs** or **Programs**. Select **Epson Software > Document Capture Pro**.

You see the Document Capture Pro window.

2. If you see a **Switch to Simple View** button in the upper right corner of the window, click it.

You see a window like this:

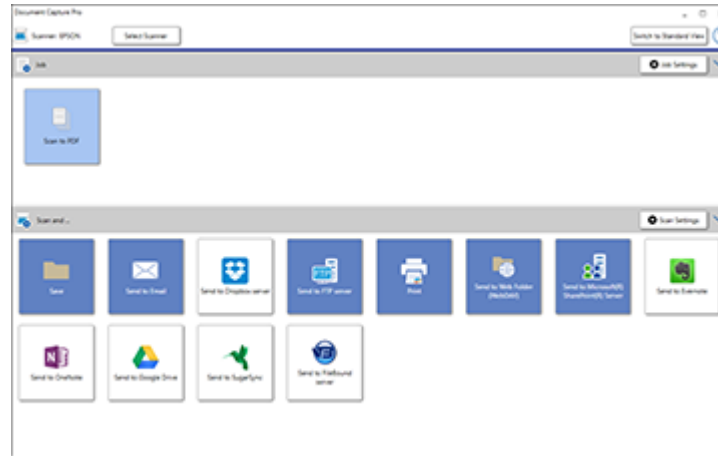

3. Click the **Job Settings** button.

Note: If you do not see the button, click the < symbol in the **Job** bar.

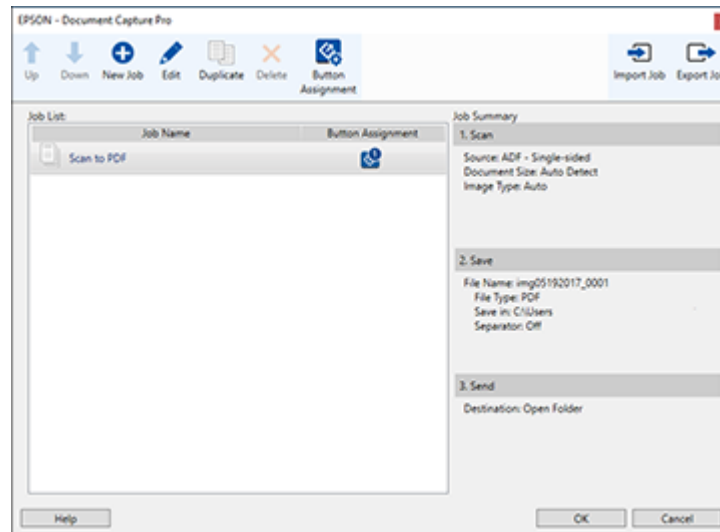

You see a window like this:



4. To add a scan job, click the  **New Job** icon, enter a name for the new job, select settings as necessary, and click **OK**.

You can now use the new scan job when you scan with Document Capture Pro.

Note: See the Help information in Document Capture Pro for details.

5. To add the scan job to the list of selectable jobs when scanning to Document Capture Pro from the control panel, click the  **Button Assignment** icon.
6. Select the job that you want to add to the list from the  drop-down list.

Note: You can assign scan jobs to each available button assignment. The order of the assigned scan jobs is also the order in which the scan jobs appear on the control panel.

7. Click **OK**, then click **OK** again.

You can now select the assigned scan job when you scan to Document Capture Pro using your product's control panel.

Parent topic: [Starting a Scan Using the Product Control Panel](#)

Adding and Assigning Scan Jobs with Document Capture - Mac

You can use Document Capture to create, edit, and delete scan jobs. Scan jobs allow you to save commonly-used scanning options. You can also determine which scan jobs are listed when you scan to Document Capture using the control panel on your product.

1. Start Document Capture on a computer connected to the product.
2. Click the  Manage Job icon from the toolbar at the top of the window.
You see a window showing the current scan job list.
3. To add a scan job, click the **+** icon, enter a name for the new job, select settings as necessary, and click **OK**.

You can now use the new scan job when you scan with Document Capture.

Note: See the Help information in Document Capture for details.

4. To add the scan job to the list of selectable jobs when scanning to Document Capture from the control panel, click the  icon at the bottom of the window and click **Event Settings**.
5. Select the job that you want to add to the list from the **1** drop-down list.

Note: You can assign scan jobs to each available button assignment. The order of the assigned scan jobs is also the order in which the scan jobs appear on the control panel.

6. Click **OK**, then click **OK** again.

You can now select the assigned scan job when you scan to Document Capture using your product's control panel.

Parent topic: [Starting a Scan Using the Product Control Panel](#)

Scanning to a Memory Device

You can scan an original and save the scanned image to a external USB device connected to your product.

1. Insert a external USB device into the product's USB port.

2. Place your original on the product for scanning.

Note: To scan a double-sided or multi-page document, place all of the pages in the ADF.

3. Press the  home button, if necessary.
4. Select **Scan**.

You see a screen like this:

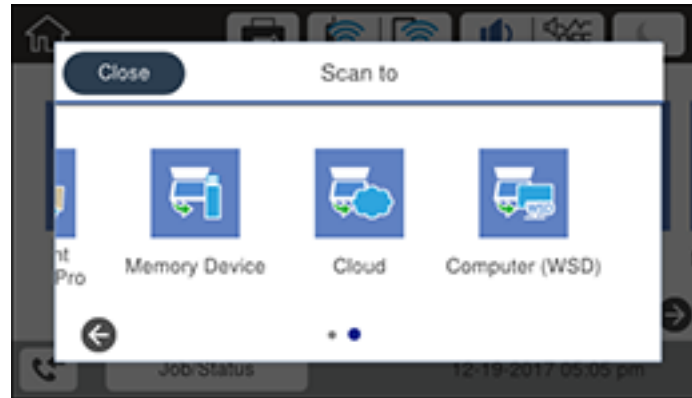

5. Select **Memory Device**.

You see a screen like this:

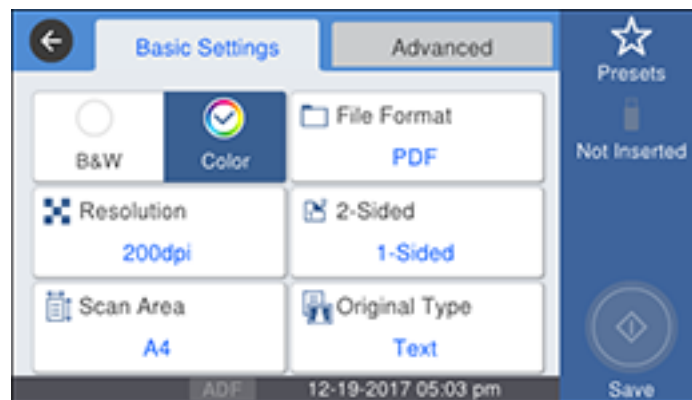

6. Select **Basic Settings** options as necessary.
7. Select the **Advanced** tab and select options as necessary.
8. Select **Presets** to save your scan settings.

Note: Presets can be locked by an administrator. If you cannot access or change this setting, contact your administrator for assistance.

9. Press the **Save** icon.

Your product scans your original and saves the scanned file to a memory device.

Parent topic: [Starting a Scan Using the Product Control Panel](#)

Scanning to the Cloud

You can use the control panel to send your scanned files to a destination that you have registered with Epson Connect.

Note: Make sure to set up your product using Epson Connect before using this feature.

1. Place your original on the product for scanning.

Note: To scan a double-sided or multi-page document, place all of the pages in the ADF.

2. Press the  home button, if necessary.
3. Select **Scan**.

You see a screen like this:

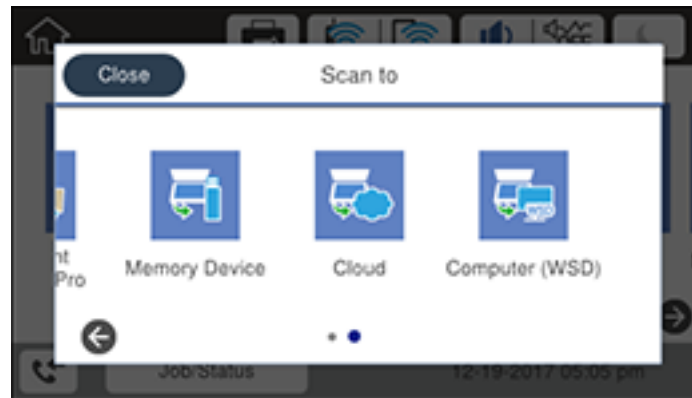

4. Select **Cloud**.

You see a screen like this:

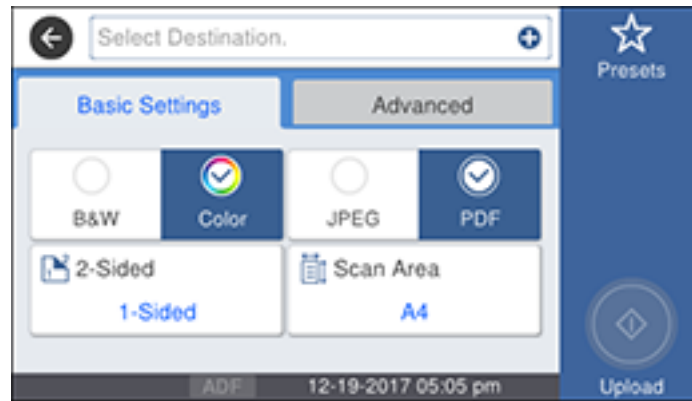

5. Press the plus sign and select a cloud destination.
6. Select **Basic Settings** options as necessary.
7. Select the **Advanced** tab and select options as necessary.
8. Select **Presets** to save your scan settings.

Note: Presets can be locked by an administrator. If you cannot access or change this setting, contact your administrator for assistance.

9. Press the **Upload** icon.

Your product scans your original and saves the scanned file to the selected destination.

Parent topic: [Starting a Scan Using the Product Control Panel](#)

Scanning Using Web Services for Devices (WSD) - Windows

You can scan originals to a computer from the product control panel using WSD (Web Services for Devices) for network scanning in Windows 10, Windows 8.x, Windows 7, or Windows Vista (English only).

Note: To use this feature on Windows 7 or Windows Vista, you must first set up WSD on the computer. See Windows help for instructions.

1. Make sure you installed the product software and connected the product to your computer or network.
2. Place your original on the product for scanning.
3. Press the  home button, if necessary.
4. Select **Scan**.
5. Select **Computer (WSD)**.
6. Select a computer.
7. Select the **Start** icon.

The scanned image is transferred to the selected computer.

Note: If you do not use this feature, you can remove the icon from the home screen by selecting **Settings > System Administration > WSD Settings > Disable**.

Parent topic: [Starting a Scan Using the Product Control Panel](#)

Control Panel Scanning Options

Select the options you want to use for scanning.

Note: Not all options or settings may be available, depending on the **Scan to** option selected.

Scan to setting	Available options	Description
Destination menu		
Keyboard	Communication Mode	Lets you select Network Folder (SMB) or FTP
	Location	Lets you enter a folder path in which to save scanned images
	User Name	Lets you enter a user name for the selected folder path
	Password	Lets you enter a password for the selected folder path
	Connection Mode	Lets you select the connection mode
	Port Number	Lets you enter a port number

Scan to setting	Available options	Description
Contacts	—	Select an email address or folder path to send or save scanned images
Scan Settings menu		
Color Mode	Color	Select whether to scan images in color or black and white
	B&W	
File Format	JPEG	Select for photos. You can also select the Compression Ratio .
	PDF	Select for documents. You can also select the Compression Ratio and PDF Settings .
	TIFF (Single Page)	Select for scanned files that you can print from a device. Multi Page TIFF documents are scanned in black and white.
	TIFF (Multi Page)	
Resolution	200dpi	Select for documents
	300dpi	Select for photos
	600dpi	Select for highest quality printing
2-Sided	1-Sided 2-Sided	Lets you scan 2-sided originals placed in the ADF. If you select 2-Sided , you can also select the Binding (Original) setting.
	Orientation (Original)	Lets you specify the direction of text on the scanned originals:
	Binding (Original)	Lets you specify which side of the scanned original is bound.
Scan Area	Auto Detect	Select to automatically adjust the scan area
	Various sizes	Select the page size for documents
	Auto Cropping	Select for photos with dark edges
	Max Area	Select for most photos
	Orientation (Original)	Lets you specify the direction of text on the scanned originals:

Scan to setting	Available options	Description
Original Type	Text	Specifies the type of original you are scanning
	Text & Image	
	Photo	
Density	-4 to +4	Adjusts the lightness or darkness of scanned images.
Remove Shadow	On	Select Center to erase the shadows that appear in the center of a document when copying a book or Surround to remove the shadows that appear around a document when copying thick paper
	Off	
Remove Punch Holes	On	Erases the binding holes on a document. Select the side of the original with the binding holes and select the orientation of the original (Up Direction or Left Direction). Enter the number of millimeters to erase from the edge of the original in the Erase Amount field.
	Off	
Subject	—	Lets you enter a subject for your email
Attached File Max Size	Various sizes	Lets you select the maximum file size that can be attached to an email
File Name	—	Lets you enter a prefix, the date, and the time to the file name for your scanned file



Note: When you turn on password settings, you can use the LCD screen keyboard to set the password.

Parent topic: [Starting a Scan Using the Product Control Panel](#)

Starting a Scan Using the Epson Scan 2 Icon

You can start the Epson Scan 2 program to select scan settings, scan, and save the scanned image to a file.

Note: If you are using your Epson product with the Windows 10 S operating system, you cannot use the software described in this section. You also cannot download and install any Epson product software from the Epson website for use with Windows 10 S; you must obtain software only from the Windows Store.

- **Windows 10:** Click  and select **EPSON > Epson Scan 2**.
- **Windows 8.x:** Navigate to the **Apps** screen and select **Epson Scan 2**.
- **Windows (other versions):** Click  or **Start**, and select **All Programs** or **Programs**. Select **EPSON > Epson Scan 2 > Epson Scan 2**.
- **Mac:** Open the **Applications** folder, open the **Epson Software** folder, and select **Epson Scan 2**.

You see an Epson Scan 2 window like this:

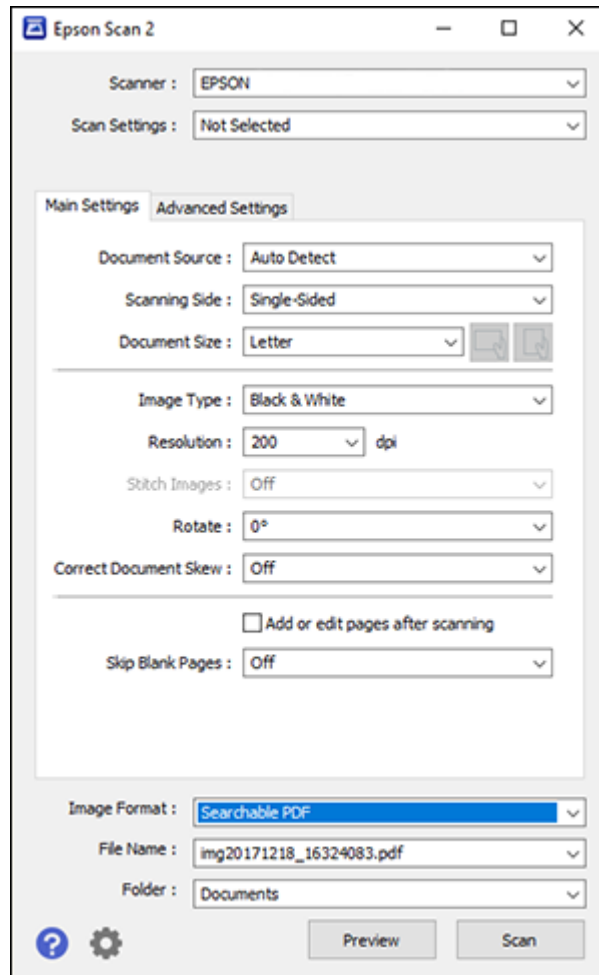

Parent topic: [Starting a Scan](#)

Starting a Scan from a Scanning Program

You can start Epson Scan 2 from a TWAIN-compliant scanning program to select scan settings, scan, and open the scanned image in the program.

Note: If you are using your Epson product with the Windows 10 S operating system, you cannot use the software described in this section. You also cannot download and install any Epson product software from the Epson website for use with Windows 10 S; you must obtain software only from the Windows Store.

1. Open your scanning program and select its scanning option. (See your scanning program help for instructions.)
2. Select your product.

Note: In certain programs, you may need to select your product as the "source" first. If you see a **Select Source** option, choose it and select your product. With Windows, do not select a **WIA** option for your product; not all scan functions will be available.

You see an Epson Scan 2 window like this:

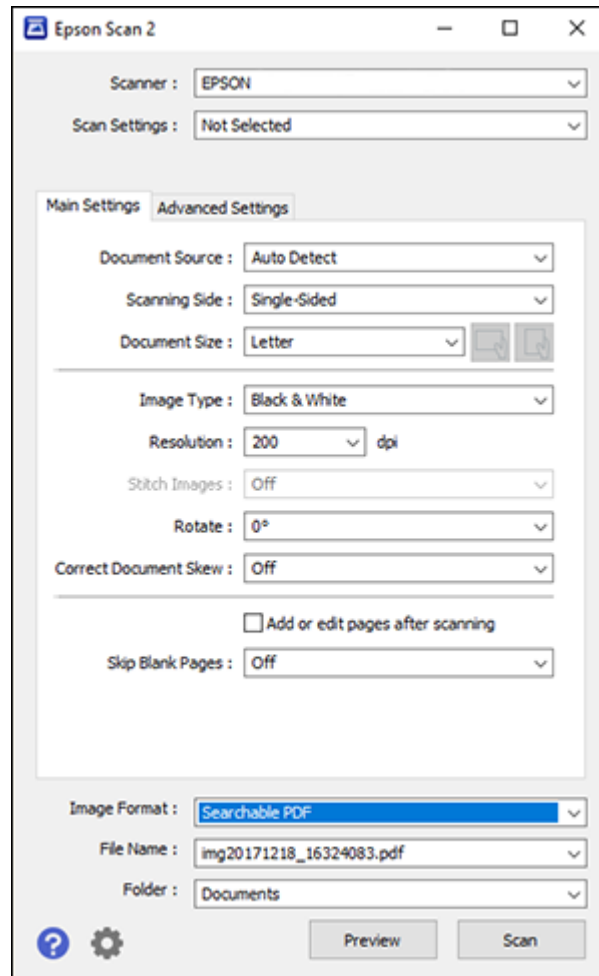

Parent topic: [Starting a Scan](#)

Starting a Scan from a Smart Device

You can start a scan from a smart device using the Epson iPrint app. You can save the scanned document to your device or a cloud service, e-mail it, or print it.

Note: If you are using your Epson product with the Windows 10 S operating system, you cannot use the software described in this section. You also cannot download and install any Epson product software from the Epson website for use with Windows 10 S; you must obtain software only from the Windows Store.

Note: Your device must be connected to the same wireless network as your Epson product. If you have an NFC-enabled device, you can also scan with the Epson iPrint app by placing the device against the NFC tag on the front of the product.

1. Download the Epson iPrint app from your device's app store or from Epson's website.
2. Place your original on the product for scanning.
3. Open the Epson iPrint app and select your product.
4. Select the scan settings and scan your original.
5. Save your scanned image to a file or cloud location.

Parent topic: [Starting a Scan](#)

Related tasks

[Using the Epson iPrint Mobile App](#)

[Using Epson Remote Print](#)

[Using Epson Email Print](#)

[Using Epson Scan to Cloud](#)

Entering a User ID and Password for Scanning

If you enabled Access Control on your product, a user ID and password may be required to scan. You can enter the user ID and password in Epson Scan 2.

Note: If you do not know the user ID or password, contact your administrator for assistance.

1. Start Epson Scan 2.
2. Select **Settings** from the **Scanner** drop-down list.

You see this window:

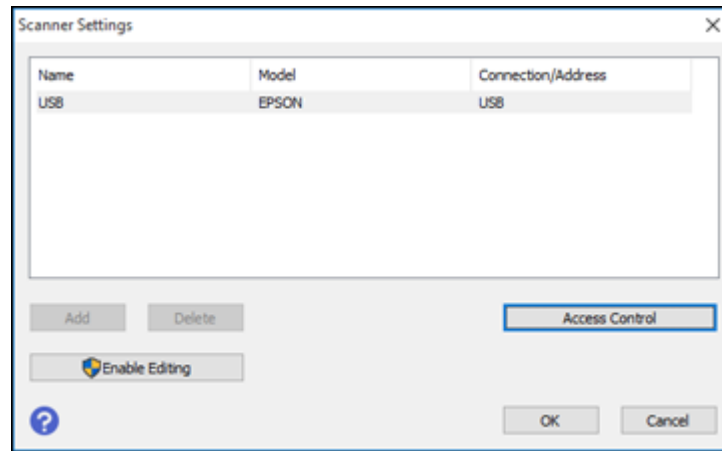

3. Select **Access Control**.
4. Enter your user name and password.
5. Click **OK**.

Parent topic: [Starting a Scan](#)

Scanning with Document Capture or Document Capture Pro

Follow the instructions in these sections to scan using Document Capture (Mac) or Document Capture Pro (Windows).

Note: The Document Capture (Mac) or Document Capture Pro (Windows) software must be installed on your computer.

[Setting the Operation Mode on the Product Control Panel](#)

[Scanning with Document Capture Pro in Simple View - Windows](#)

[Scanning with Document Capture Pro in Standard View - Windows](#)

[Scanning with Document Capture - Mac](#)

Parent topic: [Scanning](#)

Setting the Operation Mode on the Product Control Panel

Before scanning to Document Capture Pro, set the operation mode on the control panel.

1. Make sure you installed the product software and connected the product to your computer or network.
2. Press the  home button, if necessary.
3. Select **Settings**.
4. Select **General Settings > Scan Settings > Document Capture Pro**.

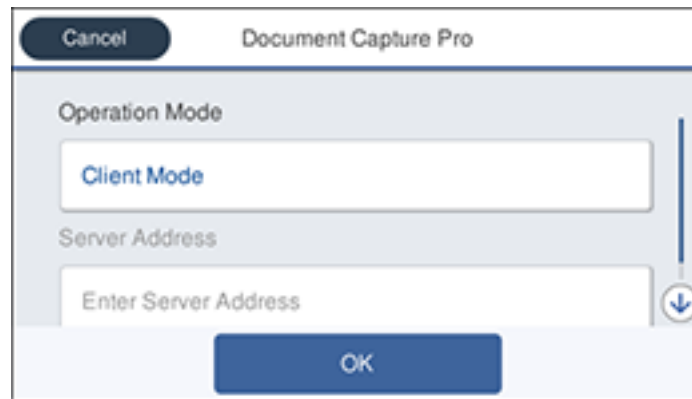



5. Choose from the following Operation Mode options:
 - Select **Client Mode** if Document Capture Pro is installed on a Windows or Mac computer.
 - Select **Server Mode** if Document Capture Pro is installed on a Windows Server computer. Enter the server address.
6. Click **OK**.

Parent topic: [Scanning with Document Capture or Document Capture Pro](#)

Scanning with Document Capture Pro in Simple View - Windows

You can use Document Capture Pro in Simple View to quickly select options and scan.

Note: The settings may vary, depending on the software version you are using. See the help information in Document Capture Pro for details.

1. Load your original in the product.
2. Do one of the following to start Document Capture Pro:
 - **Windows 10:** Click  and select **Epson Software > Document Capture Pro**.
 - **Windows 8.x:** Navigate to the **Apps** screen and select **Document Capture Pro**.
 - **Windows (other versions):** Click  or **Start**, and select **All Programs** or **Programs**. Select **Epson Software > Document Capture Pro**.

You see the Document Capture Pro window. (You may see a screen asking you to select your scanner first; if you do, select your product.)

3. If you see a **Switch to Simple View** button in the upper right corner of the window, click it.
You see a window like this:

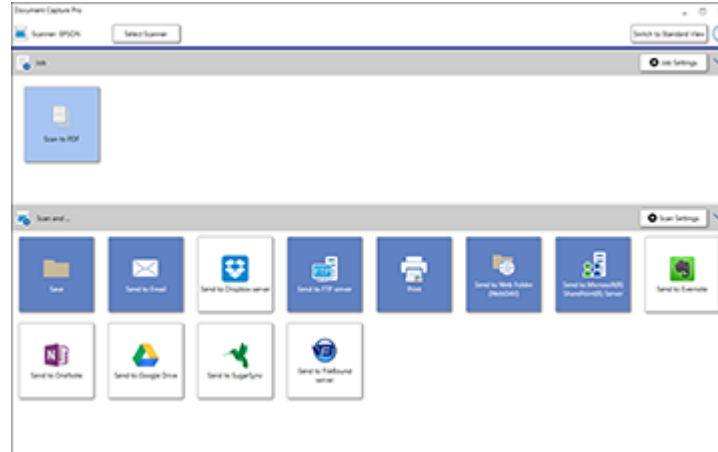

4. Click **Select Scanner** and select your scanner from the scanner list, if necessary.
5. If you want to use a scan job, click one of the job icons in the **Job** section of the window to complete and send your scan with one click.

Note: If you do not see any icons, click the < symbol in the **Job** bar.

6. If you want to select scan settings for a particular destination, click the **Scan Settings** button, select any displayed settings you want to use, and click **OK**.

Note: See the help information in Document Capture Pro for details. If you do not see the **Scan Settings** button, click the < symbol in the **Scan and...** bar.

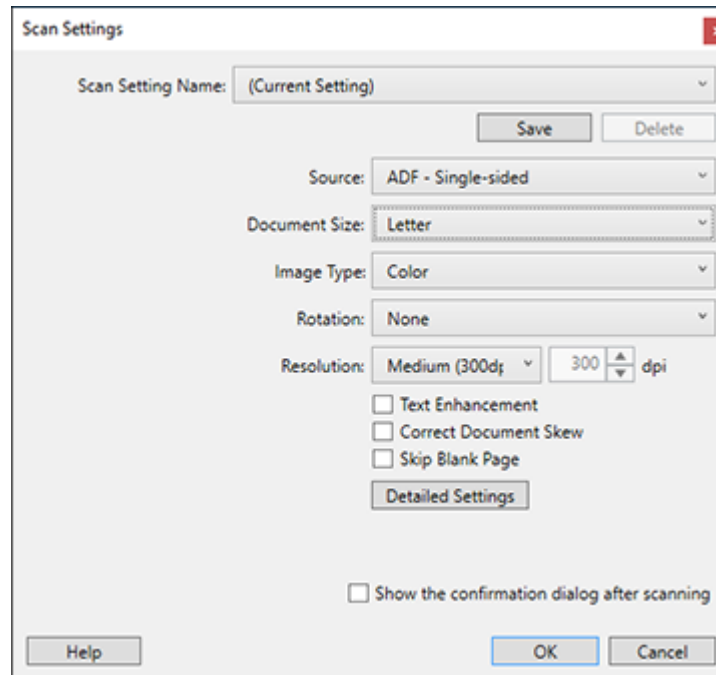

7. Click one of the destination icons in the **Scan and...** section of the window. Your product starts scanning and you see the settings window.
8. Select any destination settings as necessary and click **OK**.

Note: See the help information in Document Capture Pro for details.



9. Confirm your settings and click **OK** or **Close**.

Parent topic: [Scanning with Document Capture or Document Capture Pro](#)

Scanning with Document Capture Pro in Standard View - Windows

You can use Document Capture Pro in Standard View to select settings, preview, and change the scanned file settings as necessary.

Note: The settings may vary, depending on the software version you are using. See the help information in Document Capture Pro for details.

1. Load your original in the product.
2. Do one of the following to start Document Capture Pro:
 - **Windows 10:** Click  and select **Epson Software > Document Capture Pro**.
 - **Windows 8.x:** Navigate to the **Apps** screen and select **Document Capture Pro**.
 - **Windows (other versions):** Click  or **Start**, and select **All Programs** or **Programs**. Select **Epson Software > Document Capture Pro**.

You see the Document Capture Pro window. (You may see a screen asking you to select your scanner first; if you do, select your product.)

3. If you see a **Switch to Standard View** button in the upper right corner of the window, click it.

You see a window like this:

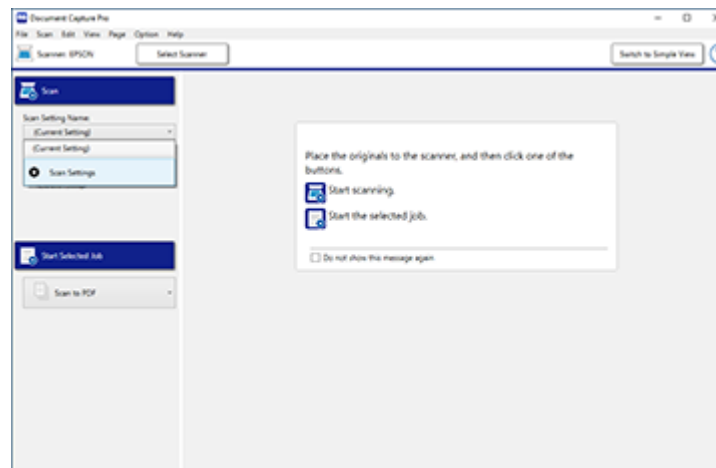

4. Select **Scan Settings** from the Scan Setting Name list (or select **Scan > Scan Settings** from the menu bar).

You see a window like this:

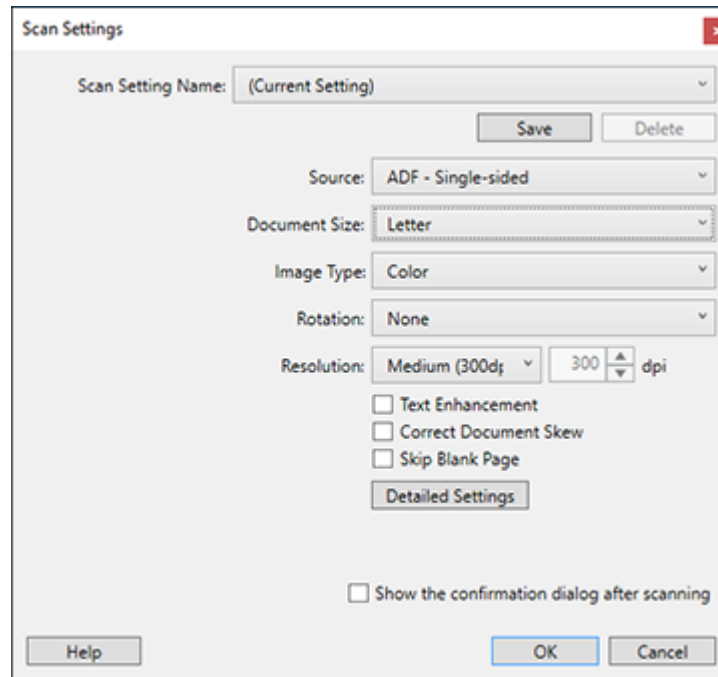

5. Select any displayed settings you want to use and click **OK**.

Note: See the help information in Document Capture Pro for details.

6. Click **Scan**.

You see a preview of your scan in the Document Capture Pro window.

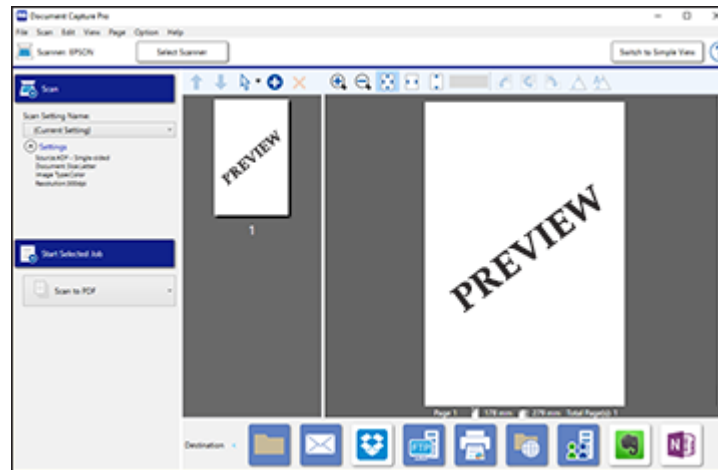

Note: You may have to close the Epson Scan 2 window to view your scan in the Document Capture Pro window.

7. If you would like to scan additional originals and add them to the current captured images, click the  Add Page(s) icon and follow the instructions on the screen.
8. Check the scanned images and edit them as necessary.

Note: See the help information in Document Capture Pro for details.

9. Click one of the Destination icons to choose where to send your scanned files. (If you cannot see all of the icons below, click the arrows next to the icons.)



10. Depending on the destination you chose, click **OK** or **Send** to complete the scan.

Parent topic: [Scanning with Document Capture or Document Capture Pro](#)

Scanning with Document Capture - Mac

When you scan with Document Capture, the program automatically saves your scanned file on your computer in the folder you specify. You can select settings, preview, and change the scanned file settings as necessary.

Note: The settings may vary, depending on the software version you are using. See the Help information in Document Capture for details.

1. Load your original in the product.
2. Open the **Applications** folder, open the **Epson Software** folder, and select **Document Capture**.

You see a window like this:

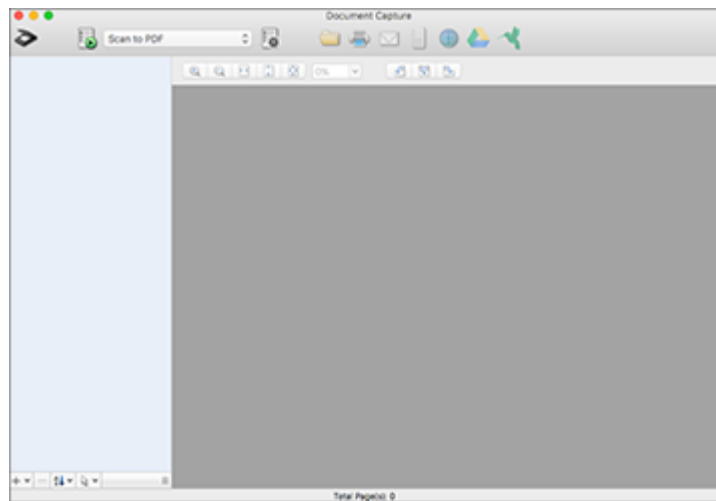

Note: You may need to select your scanner from the scanner list.

3. Click the  **Scan** icon.

You see a window like this:

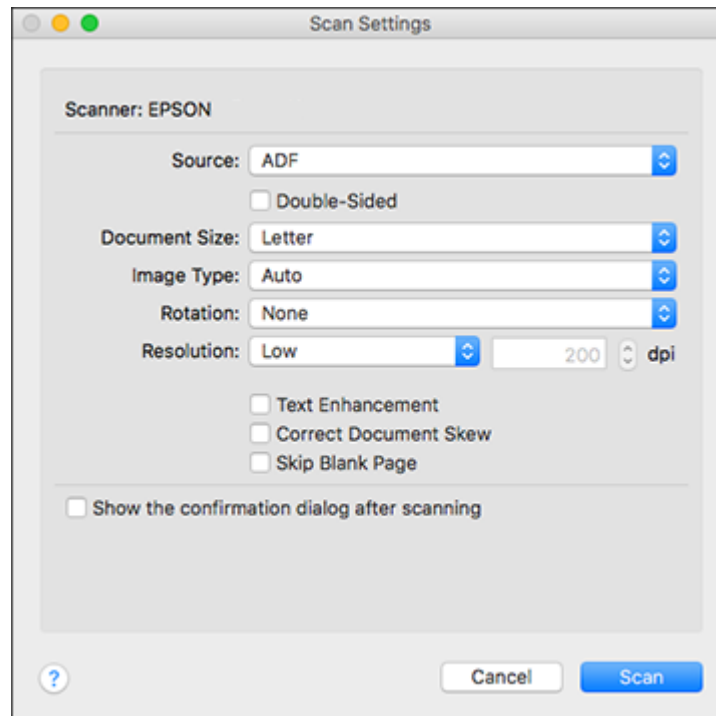

Note: If you want to use a scan job that you created instead, select it from the Job list in the Document Capture window, click the  Start Job button, and skip the rest of these steps.

4. Select any displayed scan settings you want to use.

Note: See the Help information in Document Capture for details.

5. If you want to select detailed scan settings, close the Scan Settings window, open the **Scan** menu at the top of the Mac desktop, and select **Displays the EPSON Scan Setup Screen**.
6. Click the  Scan icon and select any detailed scan settings you want to use from the Epson Scan 2 window.
7. Click **Scan**.

You see a preview of your scan in the Document Capture window.

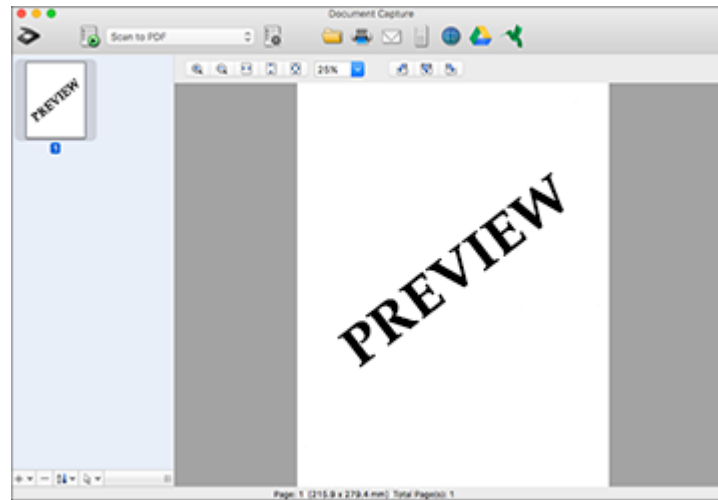

Note: You may have to close the Epson Scan 2 window to view your scan in the Document Capture window.

8. If you would like to scan additional originals and add them to the current captured images, click the + icon, select **Acquire from Scanner**, and repeat the previous steps.
9. Check the scanned images and edit them as necessary.
10. Click one of the Destination icons to choose where to send your scanned files. (If you cannot see all of the icons below, click the arrow next to the icons.)



11. Depending on the destination you chose, click **OK** or **Send** to complete the operation.

Parent topic: [Scanning with Document Capture or Document Capture Pro](#)

Scanning in Epson Scan 2

Epson Scan 2 automatically scans your document and saves the scanned file in PDF format in your operating system's Documents or My Documents folder, or opens it in your scanning program. You can select settings, preview, and change the scanned file settings as necessary.

Note: If you are using your Epson product with the Windows 10 S operating system, you cannot use the software described in this section. You also cannot download and install any Epson product software from the Epson website for use with Windows 10 S; you must obtain software only from the Windows Store.

1. Start Epson Scan 2.

You see this window:

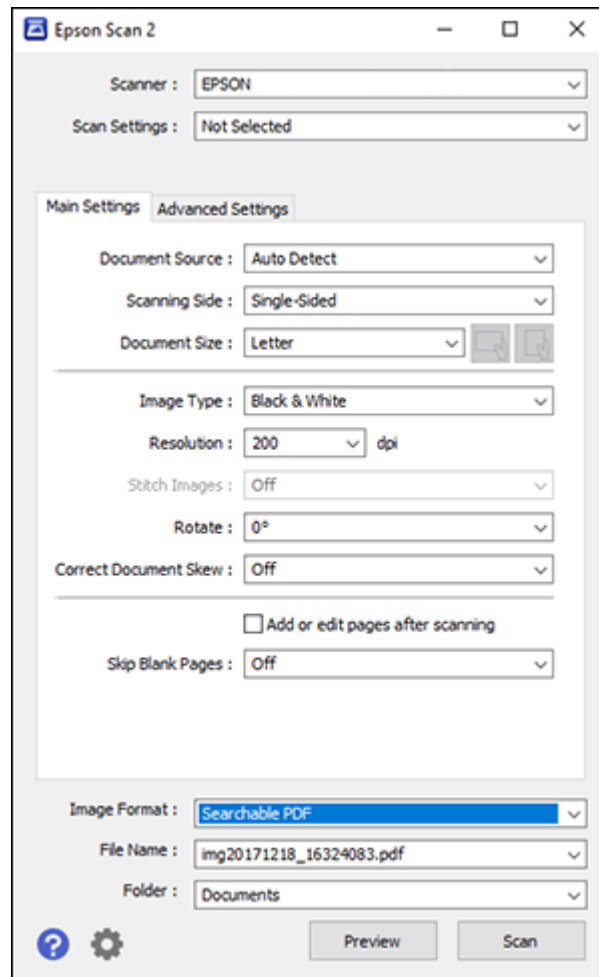

2. Select the **Document Source** setting that matches where you placed your original, or select **Auto Detect** to have Epson Scan 2 automatically detect the source.
3. Select the **Scanning Side** setting if you are scanning from the ADF.

4. Select the **Document Size** setting that matches the size of your original, or select **Auto Detect** to have Epson Scan 2 automatically detect the size. You can select **Customize** to enter a custom size, if necessary.
5. Select the image type of your original and how you want it scanned as the **Image Type** setting.
6. Select the **Resolution** setting you want to use for your scan.
7. Click the **Preview** button.

Epson Scan 2 previews your original and displays the results in the Epson Scan 2 window.

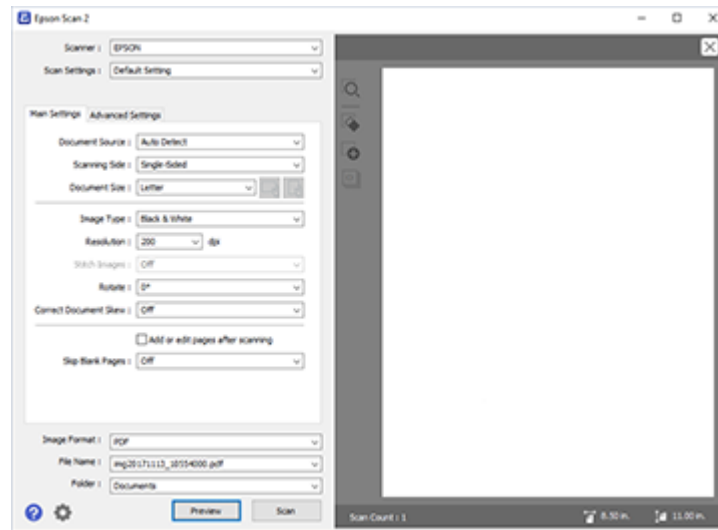

8. Reinsert your original into the ADF, if necessary.
9. Select any of the additional settings that you want to use on the Main Settings tab.
10. Click the **Advanced Settings** tab and select any settings that you want to use.
11. Select the format in which you want to save your scanned file as the **Image Format** setting. If necessary, select **Options** and select any desired format options.
12. Enter the file name for your scanned file in the **File Name** field. If necessary, select **Settings** to modify the file name settings.
13. Select the location in which you want to save your scanned file as the **Folder** setting. If necessary, select **Select** to create a new folder.
14. Click **Scan**.

The product scans your original and saves the scanned file in the location you specified.

[Available Document Source Settings](#)

[Additional Scanning Settings - Main Settings Tab](#)

[Additional Scanning Settings - Advanced Settings Tab](#)

[Saving Scanned Documents as a Searchable PDF Using Epson Scan 2](#)

[Image Format Options](#)

[Scan Resolution Guidelines](#)

Parent topic: [Scanning](#)

Available Document Source Settings

You can select these Document Source options in Epson Scan 2:

Auto Detect

Automatically detects where the originals are placed on your product for scanning.

ADF

Selects the Automatic Document Feeder as the location where the originals are placed on your product for scanning.

Scanner Glass

Selects the scanner glass as the location where the originals are placed on your product for scanning.

Parent topic: [Scanning in Epson Scan 2](#)

Additional Scanning Settings - Main Settings Tab

You can select these additional scanning settings on the Epson Scan 2 Main Settings tab. Not all adjustment settings may be available, depending on other settings you have chosen.

After Scanning Option

When scanning multi-page originals, lets you add additional pages or add and edit the pages in a job and save all of the scanned pages as one file.

Note: You must select a file format that supports multi-page such as **PDF** or **Multi-TIFF**.

Stitch Images

When scanning double-sided originals, lets you lay out images from both sides of the original onto one scanned page.

Rotate

Rotates the original image clockwise to the desired angle before scanning it. Select **Auto** to allow your product to automatically rotate the image based on the orientation of the text (may take longer to scan).

Correct Document Skew

Corrects skewed originals, image contents, or both.

Add or edit pages after scanning

Lets you add, remove, or edit the pages in a scan, including rotating pages and changing the page order.

Note: To save multiple pages in a single file, you must select a file format that supports multiple pages such as **PDF** or **Multi-TIFF**. If you select another file format, each scanned image or page is saved as a separate file.

Skip Blank Pages

If the scanner detects marks from the other side of a blank page and adds the marks to the scanned image, adjust this setting to prevent this.

Parent topic: [Scanning in Epson Scan 2](#)

Additional Scanning Settings - Advanced Settings Tab

You can select these additional scanning settings on the Epson Scan 2 Advanced Settings tab. Not all adjustment settings may be available, depending on other settings you have chosen.

Remove Background

Removes the background of the originals.

Text Enhancement

Sharpens the appearance of letters in text documents.

Auto Area Segmentation

Makes black and white images clearer and text recognition more accurate by separating the text from the graphics.

Threshold

Adjusts the level at which black areas in text and line art are delineated, improving text recognition in OCR (Optical Character Recognition) programs.

Color Enhance

Enhances the shades of the color you select in the scanned image. This setting is available only if you select **Grayscale** or **Black & White** as the Image Type setting.

Brightness

Adjusts the overall lightness and darkness of the scanned image.

Contrast

Adjusts the difference between the light and dark areas of the overall scanned image.

Gamma

Adjusts the midtone density of the scanned image.

Unsharp Mask

Makes the edges of certain image areas clearer. Turn off this option to leave softer edges.

Descreening

Removes the ripple pattern that might appear in subtly shaded image areas, such as skin tones. This option improves results when scanning magazines or newspapers. (The results of descreening do not appear in the preview image, only in your scanned image.)

Edge Fill

Corrects shadowing around the edges of the image by filling the shadows with black or white.

Dual Image Output

Scans the original image twice using different output settings (Windows only).

Parent topic: [Scanning in Epson Scan 2](#)

Saving Scanned Documents as a Searchable PDF Using Epson Scan 2

You can scan a document and save the text in a searchable PDF. In a searchable PDF, text is recognized using Optical Character Recognition (OCR) and then embedded in the scanned original.

Note: The required Epson Scan 2 OCR Component is installed automatically when you install your product software as instructed on the *Start Here* sheet. If you install your scanner software programs individually, be sure to also install this component if you want to perform OCR.

1. Load your original in the product for scanning.
2. Start Epson Scan 2.
3. Select your scan settings.
4. Click **Preview** and adjust the area you want to scan, if necessary.
5. If you are using the ADF, reload the ejected original.
6. Select **Searchable PDF** as the Image Format setting.
7. Select **Options** from the Image Format list.

You see this window:

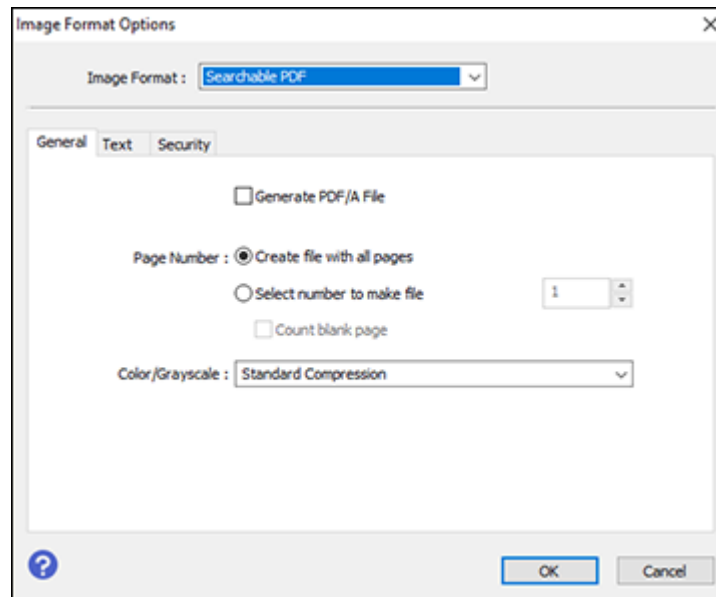

8. Select any of the options on the **General** tab.
9. Select the **Text** tab.
10. Make sure the language used in the document text is selected as the **Text Language** setting.
11. Select the **Security** tab if you want to add a password to the PDF or protect printing or editing properties.
12. Click **OK**.
13. Confirm the **File Name** setting and select a **Folder** setting for your document.
14. Click **Scan**.

The scanned image is saved as a searchable PDF.

Parent topic: [Scanning in Epson Scan 2](#)

Image Format Options

You can select different image formats and related options. For details on available options, click the ? icon on the Epson Scan 2 Image Format Options window. Not all image formats have options.

Bitmap (*.bmp)

A standard image file format for most Windows programs.

JPEG (*.jpg)

An image format that lets you highly compress image data. However, the higher the compression, the lower the image quality. (The TIFF format is recommended when you need to modify or retouch your scanned image.)

PNG (*.png)

An image format that does not lose quality during editing.

TIFF (*.tif)

A file format created for exchanging data between many programs, such as graphic and DTP software.

Multi-TIFF (*.tif)

A TIFF file format when multiple pages are saved to the same file, allowing you to edit the images using a compatible program.

PDF (*.pdf)

A document format that is readable by Windows and Mac systems using Adobe Reader, Acrobat, or other programs. You can save multi-page documents in one PDF file.

Searchable PDF (*.pdf)

A document format that is readable by Windows and Mac systems using Adobe Reader, Acrobat, or other programs. You can save multi-page documents in one PDF file. Recognized text in the scanned document can be searched.

Parent topic: [Scanning in Epson Scan 2](#)

Scan Resolution Guidelines

The **Resolution** setting, measured in dpi (dots per inch), controls the amount of detail captured in your scans. Increasing the resolution raises the amount of detail captured but comes with the following disadvantages:

- Larger file sizes
- It takes longer to scan your originals, send/receive your scans by email or fax, and to print your scans
- The image may become too large to fit on your display or print on paper

If you plan to enlarge a scanned image so you can print it at a larger size, you may need to increase the resolution from the default resolution set by Epson Scan 2. Follow these guidelines to determine the resolution setting you need:

- You will scan the image at its original size but enlarge it later in an image-editing program.

Increase the Epson Scan 2 Resolution setting in your scan. Increase the resolution by the same amount you will increase the image size to retain a high image quality. For example, if the resolution is 300 dpi (dots per inch) and you will double the image size later, change the Resolution setting to 600 dpi.

- You will scan the image at 100% or smaller size.

Select the Epson Scan 2 Resolution setting based on how you will use the scanned image:

- Email/view on a computer screen/post on the web: 96 to 200 dpi
- Print/fax/convert to editable text (OCR)/create searchable PDF: 200 to 300 dpi

Parent topic: [Scanning in Epson Scan 2](#)

Scanning Special Projects

Your product's scanning software offers various options to help you quickly complete special scan projects.

[Scanning to a SharePoint Server or Cloud Service - Windows](#)

[Scanning to a SharePoint Server or Cloud Service - Mac](#)



[Scanning Multi-Page Originals as Separate Files - Windows](#)

Parent topic: [Scanning](#)

Scanning to a SharePoint Server or Cloud Service - Windows

You can use Document Capture Pro (Windows) to upload scanned images to a SharePoint server or a cloud service.

Note: The settings may vary, depending on the software version you are using. See the help information in Document Capture Pro for details.

1. Load your original in the product.
2. Do one of the following to start Document Capture Pro:
 - **Windows 10:** Click  and select **Epson Software > Document Capture Pro**.
 - **Windows 8.x:** Navigate to the **Apps** screen and select **Document Capture Pro**.
 - **Windows (other versions):** Click  or **Start**, and select **All Programs** or **Programs**. Select **Epson Software > Document Capture Pro**.
3. If you see a **Switch to Simple View** button in the upper right corner of the window, click it.

You see a window like this:

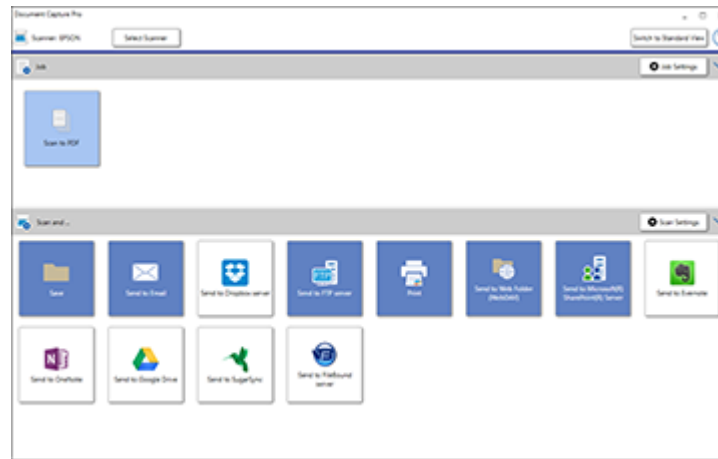

4. Click the **Scan Settings** button.

Note: If you do not see any icons, click the < symbol in the **Job** bar.

You see a window like this:

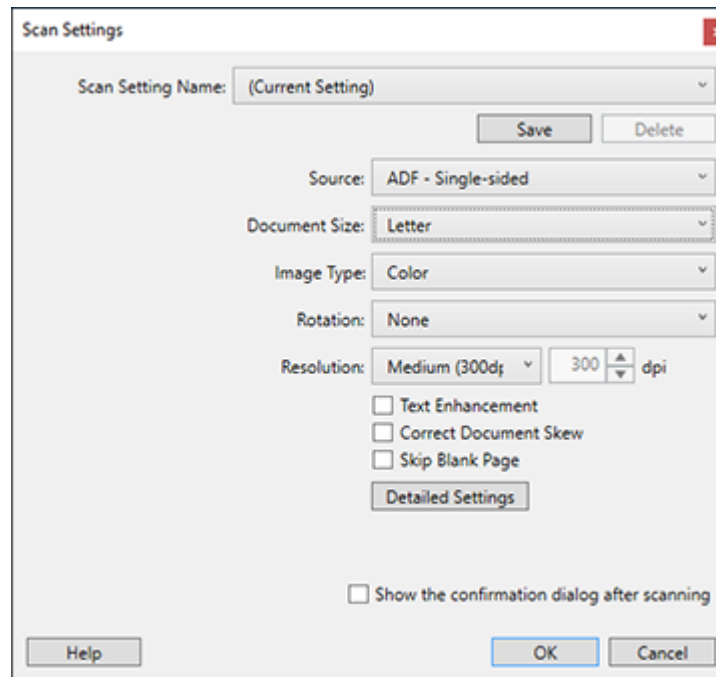

5. Select any displayed settings you want to use and click **OK**.

Note: See the help information in Document Capture Pro for details.

6. Click one of the cloud server or service destination icons in the **Scan and...** section of the window. Your product starts scanning and you see the settings window.

Note: If you cannot see all of the icons, the service software may not be installed or the service may not be available on your platform.

7. Enter any required information to set up the destination. You may need to log in to your cloud service to authenticate the connection and allow Document Capture Pro to access the cloud service. If you have previously created a saved setting for the destination, select it from the drop-down list.

8. Adjust any settings and click **OK**.

Note: See the help information in Document Capture Pro for details.

Your originals are uploaded to the indicated server or cloud service.

Parent topic: [Scanning Special Projects](#)

Scanning to a SharePoint Server or Cloud Service - Mac

You can use Document Capture to upload scanned images to a SharePoint server or a cloud service.

1. Open the **Applications** folder, open the **Epson Software** folder, and select **Document Capture**.

You see a window like this:

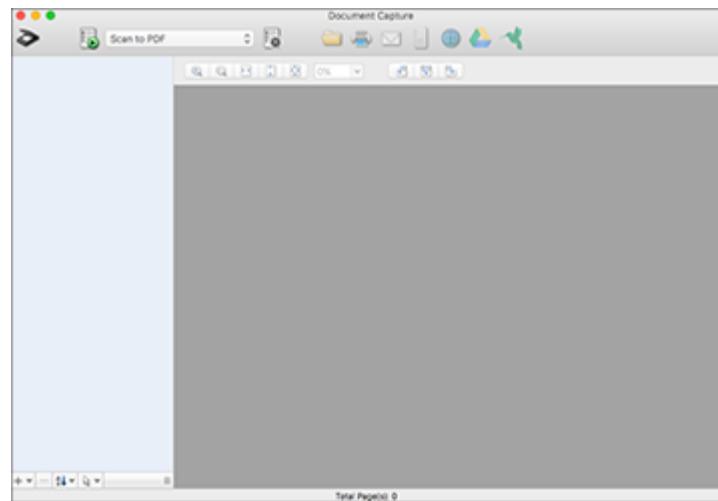

Note: You may need to select your scanner from the scanner list.

2. Click the  **Scan** icon.
3. Select any displayed scan settings you want to use.

Note: See the Help information in Document Capture for details.

4. Click **Scan**.

You see a preview of your scan in the Document Capture window.

5. Click one of the cloud service Destination icons to choose where to save your scanned file. (If you cannot see all of the icons, the service software may not be installed, the service may not be available on your platform, or you need to click the arrow next to the icons.)

You see the Transfer Settings window.

6. Enter any required information to set up the destination. You may need to log in to your cloud service to authenticate the connection and allow Document Capture to access the cloud service. If you have previously created a saved setting for the destination, select it from the drop-down list.
7. Adjust any save settings, then click **OK** or **Send**, depending on the destination.



Your originals are scanned and uploaded to the indicated server or cloud service.

Parent topic: [Scanning Special Projects](#)

Scanning Multi-Page Originals as Separate Files - Windows

You can use Document Capture Pro (Windows) to scan multi-page originals as separate scanned files. You indicate how the separate files are created by defining a maximum page count per file or by inserting blank pages, barcodes, or characters that can be detected by the software as separation markers.

Note: The settings may vary, depending on the software version you are using. See the help information in Document Capture Pro for details.

1. Load your multi-page original in the product.
2. Do one of the following to start Document Capture Pro:
 - **Windows 10:** Click  and select **Epson Software > Document Capture Pro**.
 - **Windows 8.x:** Navigate to the **Apps** screen and select **Document Capture Pro**.
 - **Windows (other versions):** Click  or **Start**, and select **All Programs** or **Programs**. Select **Epson Software > Document Capture Pro**.

You see the Document Capture Pro window.

3. If you see a **Switch to Simple View** button in the upper right corner of the window, click it.

You see a window like this:

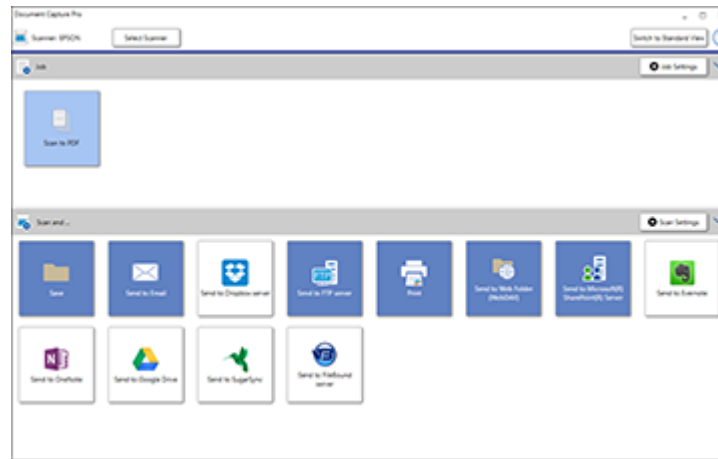

4. Click the **Scan Settings** button.

Note: If you do not see any icons, click the < symbol in the **Job** bar.

You see a window like this:

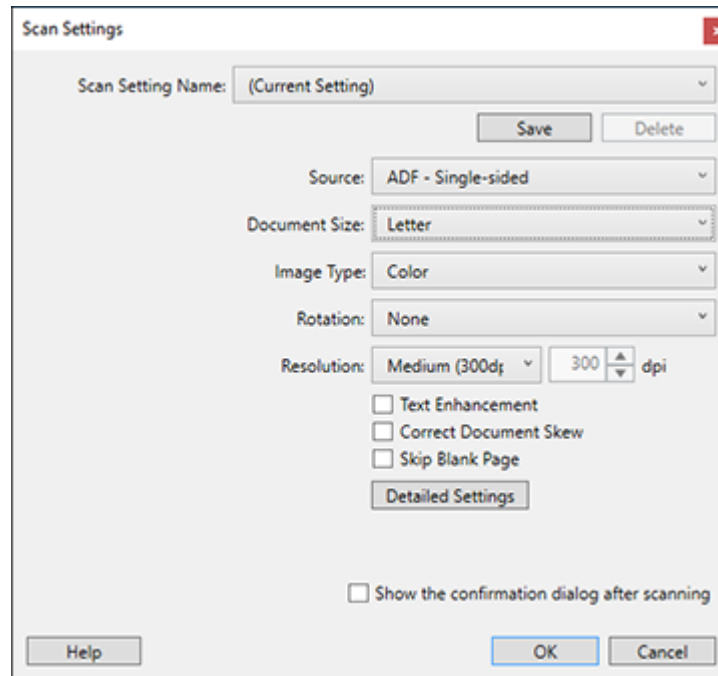

5. Select any displayed settings you want to use and click **OK**.

Note: See the help information in Document Capture Pro for details.

6. Click one of the destination icons (except **Print**) in the **Scan and...** section of the window. Your product starts scanning and you see the settings window.
7. Select the **Apply job separation** checkbox.
8. Click **Separation Settings**.

You see a window like this:

The screenshot shows a dialog box titled "Job Separation Settings" with a close button (X) in the top right corner. The dialog is divided into several sections:

- Separator:** A dropdown menu set to "Fixed Page".
- Page:** A numeric input field containing "3" with up and down arrow buttons.
- Count blank pages in total**
- Create Folder**
 - Folder Name:** A dropdown menu set to "Customizing".
 - Prefix:** A text input field containing "folder".
 - Digit Number:** A dropdown menu set to "3".
 - Start Number:** A numeric input field containing "1" with up and down arrow buttons.
 - Current Folder Name:** A label below the folder settings.
- Add job separation**
 - Separator:** A dropdown menu set to "Barcode".
 - Settings:** A button next to the separator dropdown.

At the bottom of the dialog are three buttons: "Help", "OK", and "Cancel".

9. Select the method you used to separate the originals as the **Separator** setting.

Note: See the help information in Document Capture Pro for details.

10. If necessary, select **Create Folder** and select a folder name.
11. Select any other folder naming settings you want and click **OK**, then click **OK** again.

Your originals are saved into separate files and folders as specified.

Parent topic: [Scanning Special Projects](#)

Faxing

See these sections to fax using your product.

Note: This product allows you to store names, telephone numbers, and fax data in its memory even when the power is turned off. Make sure you restore all of the default settings if you give away or dispose of the product. This will erase all of your network settings and fax data.

Note: When using the Epson Universal Print Driver or PostScript (PS3) printer software with the product, you can fax using the printer buttons or the utilities included with the standard Epson printer software. To download the standard Epson printer software, visit epson.com/support (U.S.), epson.ca/support (Canada), or epson.com.jm/support (Caribbean) and select your product.

[Connecting a Telephone or Answering Machine](#)

[Setting Up Fax Features](#)

[Setting Up Contacts and Contact Groups](#)

[Sending Faxes](#)

[Receiving Faxes](#)

[Checking Fax Status](#)

[Printing Fax Reports](#)

Connecting a Telephone or Answering Machine

You must connect your product to a telephone wall jack to send or receive faxes. If you want to use the same telephone line to receive calls, you can connect a telephone or answering machine to your product using an additional phone cable.

Note: If you do not connect a telephone to your product, make sure Receive Mode is set to **Auto**. Otherwise, you cannot receive faxes.

1. Connect a phone cable to your telephone wall jack and to the **LINE** port on your product.

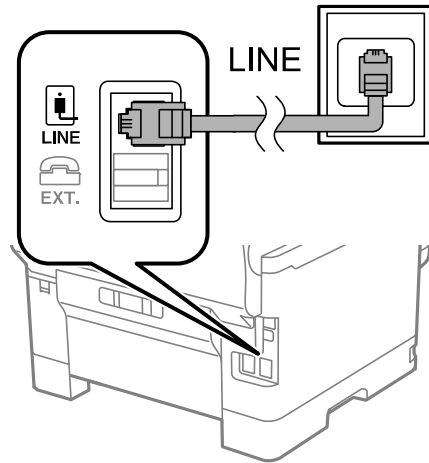

Note: If you have a DSL or ISDN connection, you must connect the appropriate DSL filter, or ISDN terminal adapter or router to the wall jack to be able to use the line for faxing or voice calls using your product. Contact your DSL or ISDN provider for the necessary equipment.

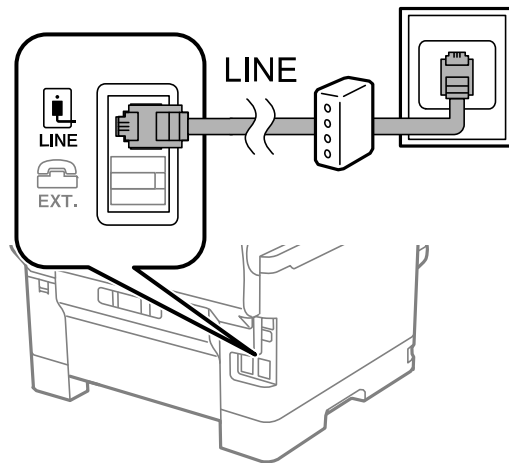

2. If you are connecting a telephone or answering machine to your product using a second phone cable, remove the cap from the **EXT** port on your product.

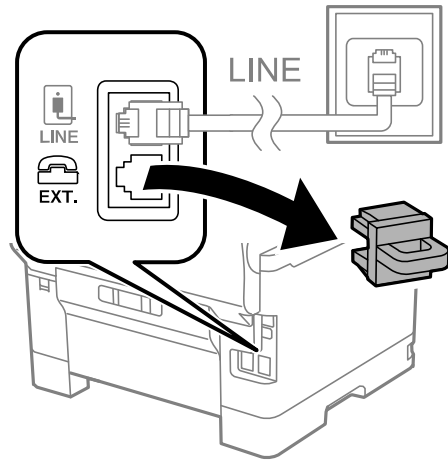

3. Connect a second phone cable to your telephone or answering machine and to the **EXT** port on your product.

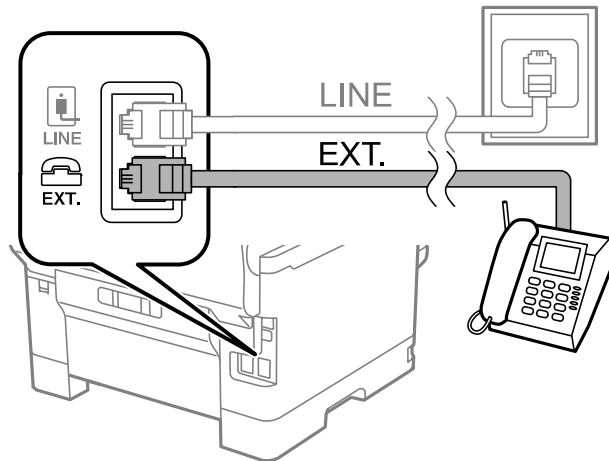

Note: If you connect an answering machine and Receive Mode is set to **Auto**, set the number of rings before your product answers a call to a number that is higher than your answering machine's setting for the number of rings.

Any phone or answering machine must be connected to the **EXT** port for your product to detect an incoming fax call when the phone is picked up. Epson cannot guarantee compatibility with VoIP, cable phone systems, or fiberoptic digital services such as FIOS.

Parent topic: [Faxing](#)

Related tasks

[Receiving Faxes Automatically](#)

Setting Up Fax Features

Before faxing with your product, set up your fax header and select the fax features you want to use.

Note: If you leave your product unplugged for a long period of time, you may need to reset the date and time settings for faxes.

[Setting Up Basic Fax Features](#)

[Selecting Advanced Fax Settings](#)

[Setting Up the Fax Utility - Windows](#)

[Setting Up Fax Features Using the Fax Utility - Mac](#)

Parent topic: [Faxing](#)

Setting Up Basic Fax Features

See these sections to select the basic settings you need to use the product's fax features.

[Using the Fax Setting Wizard](#)

[Selecting the Line Type](#)

[Setting the Number of Rings to Answer](#)

Parent topic: [Setting Up Fax Features](#)

Using the Fax Setting Wizard

You can setup the product's basic fax settings using the Fax Setting Wizard. This wizard is automatically displayed when the product is turned on for the first time. You can also change these settings individually from the Fax Settings menu.

1. Press the  home button, if necessary.

2. Select **Settings** > **General Settings** > **Fax Settings** > **Fax Setting Wizard**.

You see the following screen:



3. Connect your phone line and select **Proceed**
4. On the next screen, use the displayed keypad to enter the sender name for your fax source, such as your name or a business name. You can enter up to 40 characters. Select **OK** when complete.
5. On the next screen, use the displayed keypad to enter your fax number, up to 20 characters. Select **OK** when complete.

Note: The name and phone number in the fax header identifies the source of the faxes you send.

6. On the Distinctive Ring Setting screen, do one of the following:
 - If you have subscribed to a distinctive ring service from your telephone company, select **Proceed**. Select the ring pattern to be used for incoming faxes.
 - If you do not have a distinctive ring service, select **Skip**.

Note: Distinctive ring services allows you to have several phone numbers on one phone line. Each number is assigned a different ring pattern. You can use one number for voice calls and another for fax calls. Select the ring pattern assigned to fax calls in the Distinctive Ring Setting. If you select a ring pattern other than **All**, Receive Mode is automatically set to **Auto**.

7. On the Receive Mode Setting screen, do one of the following:
 - If you have connected an external telephone or answering machine to the product, select **Yes**.

- If you did not connect an external telephone or answering machine, select **No**. (Receive Mode is automatically set to **Auto**; otherwise you cannot receive faxes.)
8. On the next Receive Mode Setting screen, select **Yes** to receive faxes automatically or select **No** to receive faxes manually.

Note: If you connect an external answering machine and select to receive faxes automatically, make sure the **Rings to Answer** setting is correct. If you select to receive faxes manually, you need to answer every call and operate the product's control panel or your phone to receive faxes.

9. On the Proceed screen, confirm the displayed settings and select **Proceed**, or press the back arrow to change the settings.
10. On the Run Check Fax Connection screen, select **Start Checking** and follow the on-screen instructions to check the fax connection and print a report of the check result. If there are any errors reported, try the solutions on the report and run the check again.

If the Select Line Type screen appears, select the correct line type.

If the Select Dial Tone Detection screen appears, select **Disable**. However, disabling the dial tone detection function may drop the first digit of a fax number and send the fax to the wrong number.

Parent topic: [Setting Up Basic Fax Features](#)

Related tasks

[Entering Characters on the LCD Screen](#)

Selecting the Line Type

If you connect the product to a PBX phone system or terminal adapter, you must change the product's line type. PBX (Private Branch Exchange) is used in office environments where an external access code such as "9" must be dialed to call an outside line. The default Line Type setting is PSTN (Public Switched Telephone Network), which is a standard home phone line.

1. Press the  home button, if necessary.
2. Select **Settings > General Settings > Fax Settings > Basic Settings > Line Type > PBX**.

You see a screen like this:

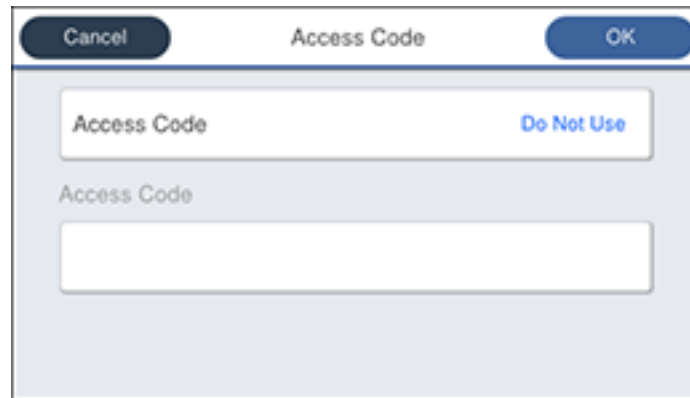

3. Select **Access Code** and select **Use**.
4. Select the **Access Code** field and use the displayed keypad to enter the access code, such as 9. Then select **OK**.
5. Select **OK** to exit.

Parent topic: [Setting Up Basic Fax Features](#)

Related tasks

[Entering Characters on the LCD Screen](#)

Setting the Number of Rings to Answer

If you connect an external answering machine and select to receive faxes automatically, make sure the Rings to Answer setting is correct. The number of rings should be higher than the number of rings your answering machine is set to for answering a call.

1. Press the  home button, if necessary.
2. Select **Settings > General Settings > Fax Settings > Basic Settings > Rings to Answer**.

You see a screen like this:



3. Select the number of rings and select **OK**. Make sure to select a number higher than the number of rings your answering machine is set to for answering a call.

Note: An answering machine picks up every call faster than the product, but the product can detect fax tones and start receiving faxes. If you answer the phone and hear a fax tone, check that the product has started receiving the fax, then hang up the phone.

Parent topic: [Setting Up Basic Fax Features](#)

Selecting Advanced Fax Settings

You can select a variety of advanced fax settings.

1. Press the  home button, if necessary.
2. Select **Settings** > **General Settings** > **Fax Settings**.

You see a screen like this:



3. If you want to create shortcuts for up to three fax operations, select **Quick Operation Button** and select a setting and a shortcut button.

Note: These shortcuts are displayed on the Fax Settings tab in the main **Fax** screen.

4. Select the group of settings you want to change.

[Send Settings - Fax](#)

[Receive Settings - Fax](#)

[Report Settings - Fax](#)

[Basic Settings - Fax](#)

[Security Settings - Fax](#)

Parent topic: [Setting Up Fax Features](#)

Send Settings - Fax

Select the send options you want to use for outgoing faxes.

Setting	Options	Description
Batch Send	Off	Sorts outgoing faxes by recipient in the product's memory, and then sends them as a batch
	On	

Setting	Options	Description
Save Failure Data	Off	Saves faxes that failed to be sent in the product's memory. You can resend the faxes from the product's Job/Status menu.
	On	

Parent topic: [Selecting Advanced Fax Settings](#)

Receive Settings - Fax

Select the save/forward or print options you want to use for incoming faxes.

Save/Forward Settings

Setting	Options	Description
Unconditional Save/Forward	Save to Inbox	Saves received faxes in printer's inbox
	Save to Computer	Converts received faxes to PDFs and saves them on a computer connected to the printer
	Save to Memory Device	Converts received faxes to PDFs and saves them on an external memory device connected to the printer
	Forward	Forwards received faxes to another fax machine, or converts them to PDFs and forwards them to a shared folder on a network or an email address. Forwarded faxes are deleted from the printer.
	Email Notifications	Sends an email notification after a fax is received, printed, saved, or forwarded
Conditional Save/Forward	—	Sets up conditions to save, forward, or print received faxes. Select the arrow icon to enter conditions and other settings. Select Enable to enable a condition.
Common Settings	Inbox Settings	Sets up what happens when the fax memory is full, or sets up a password for the inbox
	Forward Settings	Specifies a subject when forwarding a fax to an email address

Print Settings

Setting	Options	Description
Auto Reduction	On	Select to reduce the size of large received faxes to fit on the paper size in the selected paper source
	Off	Select to print large incoming faxes at their original size on multiple sheets, if necessary
Split Page Settings	Delete Print Data After Split	Select how to split large incoming faxes across multiple sheets
	Overlap When Split	
Acting Print	On (Split to Pages)	Select to split large incoming faxes across multiple sheets.
	On (Reduce to Fit)	Select to reduce the size of large received faxes to fit on the paper size in the selected paper source.
	Off	Select to print large incoming faxes at their original size on multiple sheets, if necessary.
Auto Rotation	On	If you have loaded A5-size paper, select On to rotate landscape-oriented incoming faxes so that they print correctly on the paper
	Off	
Add Reception Information	On	Select On to include the date, time, the sender's information, and a page number in the header of your incoming faxes
	Off	
2-Sided	On	Select On to print incoming faxes double sided. You can also select the Binding Margin .
	Off	
Print Start Timing	All Pages Received	Select to print incoming faxes after the product receives all of the pages of the document
	First Page Received	Select to print incoming faxes as soon as the product receives the first page of the document
Collation Stack	On	Select On to print incoming faxes so that the pages are stacked in the correct page order. (When the product is low on memory, this option may not be available.)
	Off	

Setting	Options	Description
Print Suspend Time	Off	Select On to set a time period to stop automatic printing of faxes or reports and save received faxes in the product's memory. (Make sure there is enough free memory before using this function.)
	On	
	Time to Stop	
	Time to Restart	
Quiet Mode	On	Select On to reduce noise during printing. (Printing speed may be reduced.)
	Off	

Parent topic: [Selecting Advanced Fax Settings](#)

Report Settings - Fax

Select the options you want to use for fax reports.

Setting	Options	Description
Forwarding Report	Print on Error	Prints a report after forwarding a received document only if an error occurs
	Print	Prints a report after forwarding a received document
	Do Not Print	Does not print a report after forwarding a received document
Back Up Error Report	On	Select On to print a report when a backup error for sending faxes occurs
	Off	
Fax Log Auto Print	Off	Does not print a fax log
	On(Every 30)	Prints a fax log after every 30 fax jobs are completed
	On(Time)	Prints a fax log at a specified time. If the number of completed fax jobs exceeds 30, the fax log prints before the specified time.
Attach Fax Image to Report	Off	Does not include an image on the Transmission Report
	On(Large Image)	Prints a Transmission Report that includes the upper part of the first page of the sent document
	On(Small Image)	Prints a Transmission Report that includes a reduced size of the entire first page of the sent document

Setting	Options	Description
Report Format	Simple	Prints a simple fax report
	Detail	Prints a fax report that includes error codes
Output Method	Print	Prints fax reports
	Save to Memory Device	Saves fax reports to a memory device
	Forward	Forwards fax reports to a specified destination

Parent topic: [Selecting Advanced Fax Settings](#)

Basic Settings - Fax

Select the basic options you want to use for incoming and outgoing faxes.

Setting	Options	Description
Fax Speed	Fast(33,600bps)	Sets the speed at which you send and receive faxes
	Medium(14,400bps)	
	Slow(9,600bps)	
ECM	On	Turns on Error Correction Mode (ECM) to automatically correct errors in sent or received fax data
	Off	Turns off Error Correction Mode (ECM); color faxes cannot be sent or received
Dial Tone Detection	On	Automatically dials the number you enter for faxing when the product detects a dial tone
	Off	Turns off automatic dial tone detection, which may be necessary if the product is connected to a PBX (Private Branch Exchange) or a TA (Terminal Adapter). However, turning this setting off may cause the product to drop the first digit of a fax number.

Setting	Options	Description
Line Type	PSTN	Selects a standard phone line (Public Switched Telephone Network)
	PBX	Selects Private Branch Exchange, the type of phone line used in office environments where an access code such as 9 must be used to call an outside line
Header	Your Phone Number	Select to enter the header information and your phone number for inclusion on outgoing faxes
	Fax Header	
Receive Mode	Manual	Lets you confirm whether an incoming fax should be printed; a telephone must be connected to the product
	Auto	Automatically receives and prints faxes
Distinctive Ring	All	If you are using a Distinctive Ring Service on your phone line, your telephone company can assign two or more phone numbers to the same line and assign different ring patterns to each. If you use this service, select the number of rings for your fax number so your product can receive faxes on the correct number of rings. Select All for phones lines that do not use this service.
	Single	
	Double	
	Triple	
	Double&Triple	
Rings to Answer	1 to 9	Sets the number of rings before your product receives a fax. If Receive Mode is set to Auto and an answering machine is connected to the product, make sure this setting is set higher than the number of rings your answering machine is set to answer a call.
Remote Receive	Off	Lets you start receiving faxes using your phone instead of operating the product (if the Receive Mode is set to Auto). When you select On , you must also set a Start Code . If you are using a cordless handset with its base connected to the product, you can start receiving the fax by entering the code using the handset.
	On	
	Start Code	

Setting	Options	Description
Rejection Fax	Various	Lets you automatically reject faxes from blocked numbers, with blank headers, or from unrecognized contacts

Parent topic: [Selecting Advanced Fax Settings](#)

Security Settings - Fax

Select the security options you want to use for fax data.



Setting	Options	Description
Direct Dialing Restrictions	Off	Does not restrict dialed fax numbers
	On	Allows faxing only to numbers stored in the contacts list or history
	Enter Twice	Requires you to enter fax numbers twice to prevent errors
Confirm Address List	Off	Selects whether or not to display a recipient confirmation screen before a fax is sent
	On	
Backup Data Auto Clear	Off	Automatically erases sent or received fax data from your product's memory
	On	
Clear Backup Data	—	Deletes all sent or received fax data remaining in your product's memory; run this function if you are giving away or disposing of your product

Parent topic: [Selecting Advanced Fax Settings](#)

Setting Up the Fax Utility - Windows

You can set up the FAX Utility for Windows for use with your product.

Note: Before using the FAX Utility for Windows, make sure you have set up the fax features on your product using the product control panel. Also first confirm that you can send and receive faxes using the control panel.

1. Do one of the following:
 - **Windows 10:** Click  and select **EPSON Software**.
 - **Windows 8.x:** Navigate to the **Apps** screen.
 - **Windows (other versions):** Click  or **Start > Programs** or **All Programs > EPSON Software**.
2. Select **FAX Utility**.

The first time you use the FAX Utility, you see this introduction window:

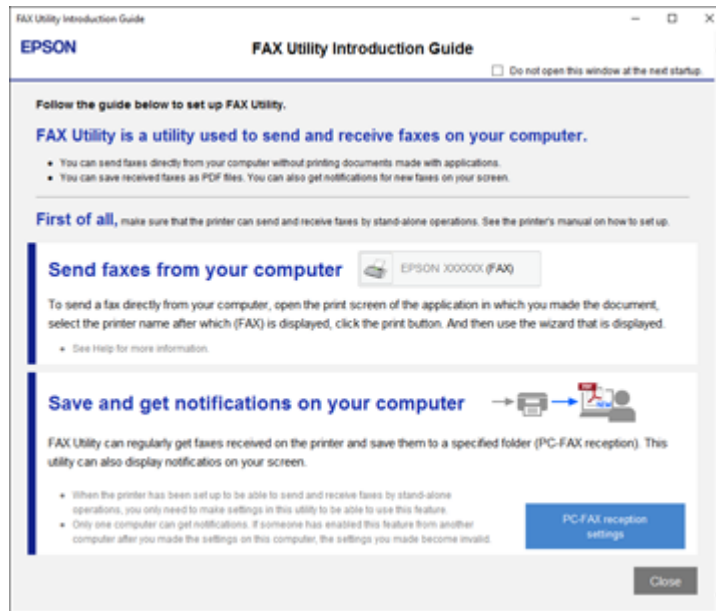

3. Read about the FAX Utility and click **Close** at the bottom of the window.

You see this window:

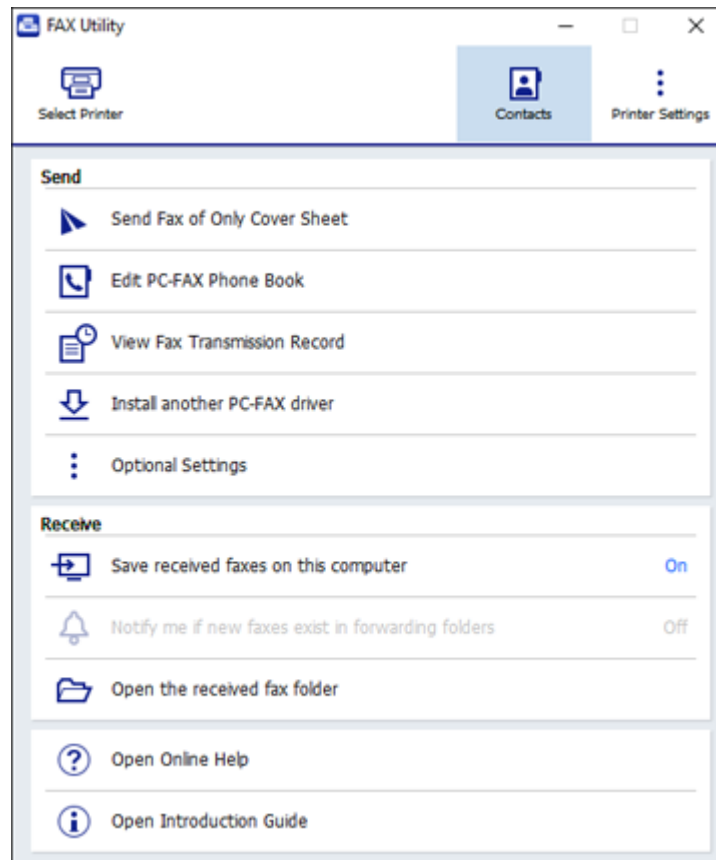

4. Click **Select Printer** and follow the on-screen instructions to transfer your product's fax settings to the FAX Utility.

Note: For detailed information, click **Help** or **Open Online Help**.

Parent topic: [Setting Up Fax Features](#)

Setting Up Fax Features Using the Fax Utility - Mac

You can set up your fax header and select your fax settings using the FAX Utility for Mac.

1. In the Apple menu or the Dock, select **System Preferences**. Select **Print & Fax**, **Print & Scan**, or **Printers & Scanners**, select the **FAX** option for your product, and select **Options & Supplies**. Select **Utility** and select **Open Printer Utility**.
2. Double-click **FAX Utility**, if necessary.

You see this window:



3. Select your **FAX** product in the Printer list.
4. Select **Fax Settings**.
5. Follow the prompts that appear on the screen to enter your fax header information and select your fax settings.

Note: For detailed information, select the FAX Utility ? icon.

Parent topic: [Setting Up Fax Features](#)

Setting Up Contacts and Contact Groups

You can set up a list of contacts and their fax numbers so you can quickly select them for faxing. You can also set up contact groups to send a fax message to multiple contacts.

[Setting Up Contacts Using the Product Control Panel](#)

[Importing Contacts Using the Fax Utility - Windows](#)

[Setting Up Speed/Group Dial Lists Using the Fax Utility - Mac](#)

Parent topic: [Faxing](#)

Setting Up Contacts Using the Product Control Panel

You can set up your contacts and contact groups using the control panel on your product.

Note: Contacts can be locked by an administrator. If you cannot access or change contacts, contact your administrator for assistance.

[Creating a Contact](#)

[Editing or Deleting a Contact](#)

[Creating a Contact Group](#)

[Editing or Deleting a Contact Group](#)

Parent topic: [Setting Up Contacts and Contact Groups](#)

Creating a Contact

You can create a list of contacts to save frequently used fax numbers.

Note: You can create up to 200 contacts and contact groups combined.

1. Press the  home button, if necessary.
2. Select **Fax**.

You see a screen like this:

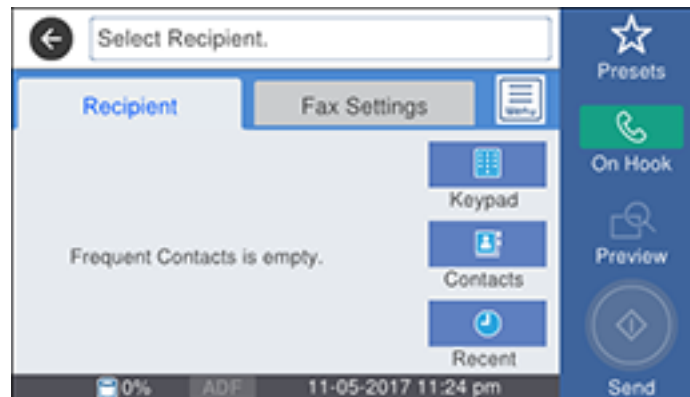

3. Select **Contacts**.

You see a screen like this:

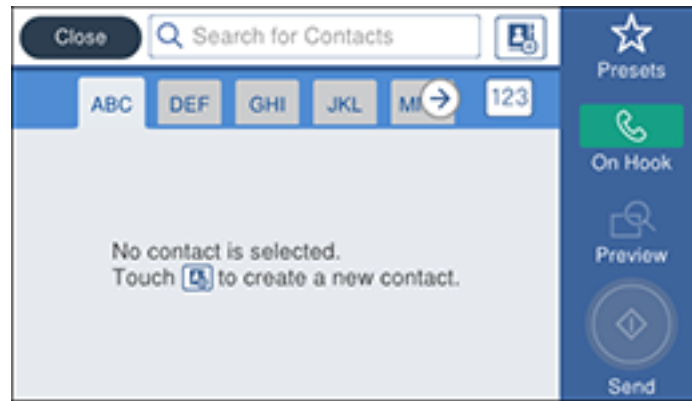

4. Select the  icon.

5. Select **Add Contact**.

You see a screen like this:

A screenshot of a mobile application form titled 'Add Entry'. The form has three buttons at the top: 'Cancel' on the left, 'Add Entry' in the center, and 'OK' on the right. Below the buttons are three input fields. The first field is labeled 'Registry Number' and contains the text '0001'. The second field is labeled 'Name' and contains the placeholder text 'Enter Name.'. The third field is labeled 'Index Word' and is currently empty. A small blue arrow icon pointing down is located at the bottom right corner of the form.

6. Select the registry number you want to use for the contact you are adding.

7. Select the **Name** field, use the displayed keyboard to enter the contact name (up to 30 characters), and select **OK**.
8. Select the **Index Word** field, use the displayed keyboard to enter a word to use when searching for an entry (up to 30 characters), and select **OK**. (This field is optional.)
9. Select the **Fax Number** field, use the displayed keypad or the buttons on the product to enter the fax number, and select **OK**. You can enter up to 64 characters.

Note: If necessary, enter an outside line access code (such as **9**) at the beginning of the fax number. If the access code has been set up in the **Line Type** setting, enter the **#** pound sign instead of the code.

10. If you are sending a fax to a confidential box or relay box, enter a sub-address and password in the **Subaddress (SUB/SEP)** and **Password (SID/PWD)** fields.
11. Select any additional settings as necessary.
12. Select **OK** to save the entry.

Parent topic: [Setting Up Contacts Using the Product Control Panel](#)

Editing or Deleting a Contact

You can edit or delete any of the contacts on your list.

1. Press the  home button, if necessary.
2. Select **Fax**.

You see a screen like this:

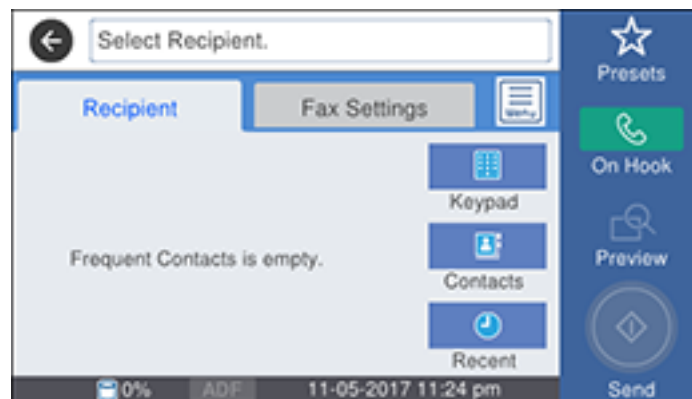

3. Select **Contacts**.
4. Select the tab containing the first letter of the contact name, then select the > icon next to the contact you want to edit or delete.

You see a screen like this:



5. Do one of the following:
 - To delete the contact, select **Delete** and select **Yes** on the confirmation screen.
 - To edit the contact, select **Edit**, select the item you want to change, enter the correct information, and select **OK**. When you are finished editing, select **OK**.

Parent topic: [Setting Up Contacts Using the Product Control Panel](#)

Creating a Contact Group

You can create a group of contacts so that you can easily send faxes to multiple recipients.

Note: You can create up to 200 contacts and contact groups combined. You must create a contact before creating a contact group.

1. Press the  home button, if necessary.
2. Select **Fax**.

You see a screen like this:

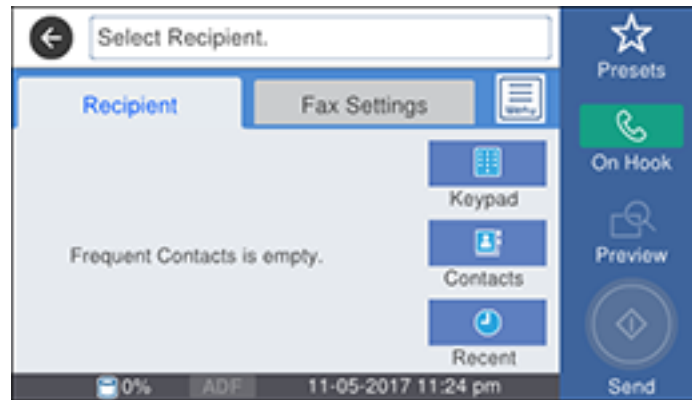

3. Select **Contacts**.

4. Select the  icon.

5. Select **Add Group**.

You see a screen like this:

6. Select the registry number you want to use for the group you are adding.

7. Select the **Group Name** field, use the displayed keyboard to enter the group name (up to 30 characters), and select **OK**.

8. Select the **Index Word** field, use the displayed keyboard to enter a word to use when searching for a group (up to 30 characters), and select **OK**. (This field is optional.)
9. Select the **Contact(s) Added to the Group** field.
You see your contacts list.
10. Select each contact you want to include in your group.
A check mark appears next to each selected contact.
11. Select **Close** when complete.
12. Select **Assign to Frequent Use** to list the group on the **Recipient** tab.
13. Select **OK** to save the group.

Parent topic: [Setting Up Contacts Using the Product Control Panel](#)

Editing or Deleting a Contact Group

You can edit an existing contact group to add or delete entries. You can also delete the entire contact group.

1. Press the  home button, if necessary.
2. Select **Fax**.

You see a screen like this:

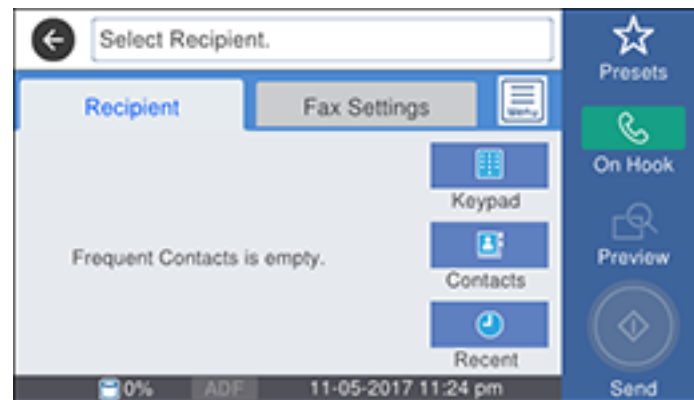

3. Select **Contacts**.
4. Select the > icon next to the group you want to edit or delete.

You see a screen like this:

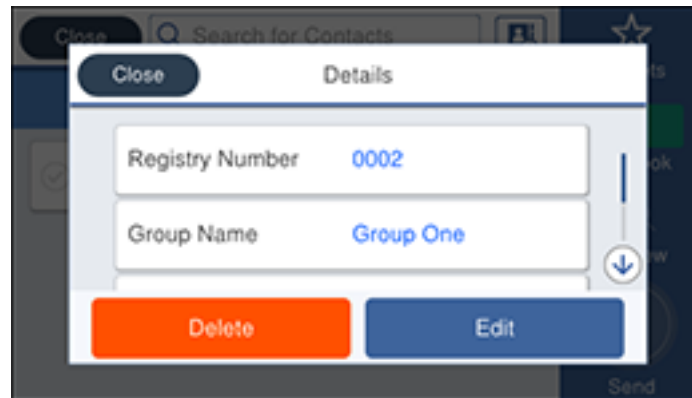



5. Do one of the following:
 - To delete the group, select **Delete** and select **Yes** on the confirmation screen.
 - To edit the group, select **Edit** and change the group name or contacts included as necessary.
6. Select **OK** when complete.

Parent topic: [Setting Up Contacts Using the Product Control Panel](#)

Importing Contacts Using the Fax Utility - Windows

You can edit contacts stored in your product and import contacts from your Windows Address Book to the PC-FAX Phone Book in the FAX Utility for Windows.

1. Do one of the following:
 - **Windows 10:** Click  and select **EPSON Software**.
 - **Windows 8.x:** Navigate to the **Apps** screen.
 - **Windows (other versions):** Click  or **Start > Programs** or **All Programs > EPSON Software**.
2. Select **FAX Utility**.

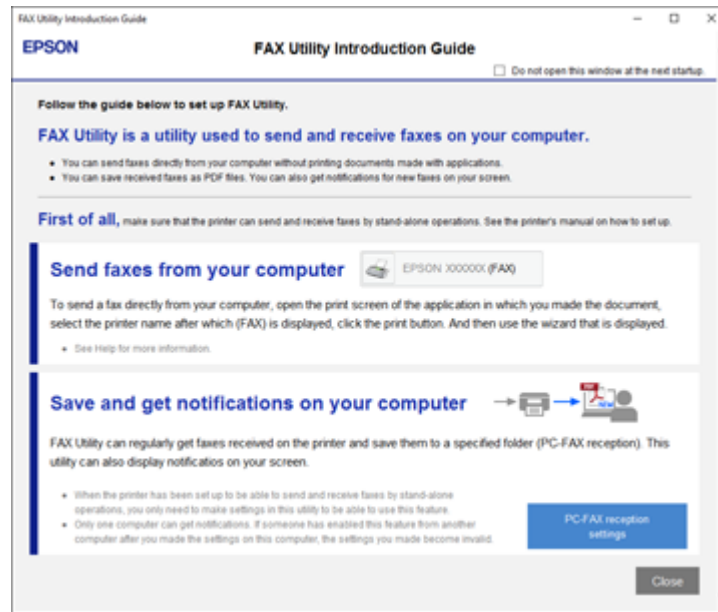

The first time you use the FAX Utility, you see this introduction window:

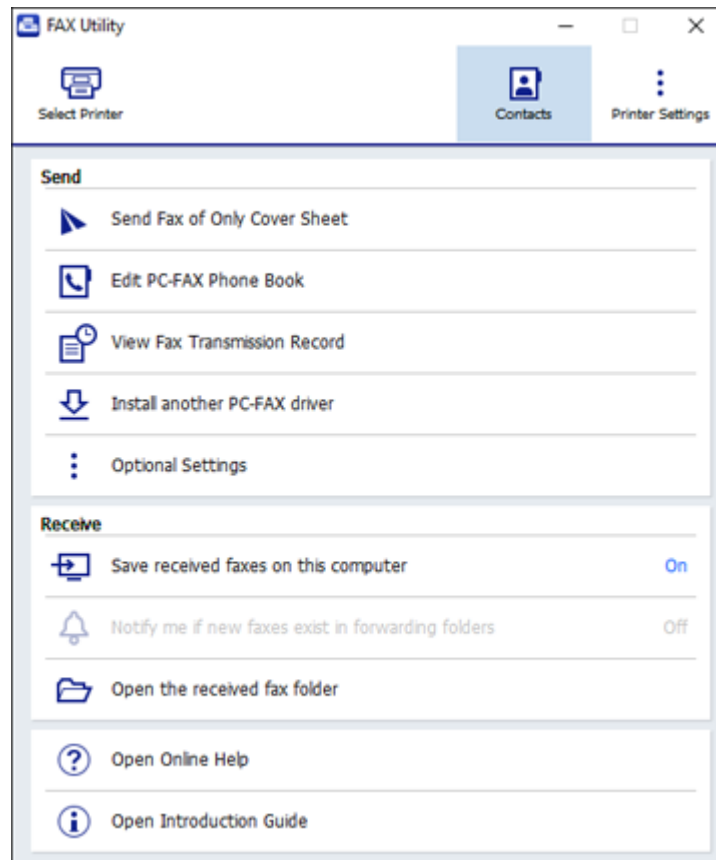

3. Read about the FAX Utility and click **Close** at the bottom of the window.

You see this window:



4. To edit the contacts list on your product, click **Contacts**.
5. Do one of the following:
 - To edit a contact, select it in the list and click the  icon.
 - To delete a contact, select it in the list and click the   icon.
6. To import fax numbers from your Windows Address Book into the FAX Utility PC-FAX Phone Book, select **Edit PC-FAX Phone Book**.

You see this window:

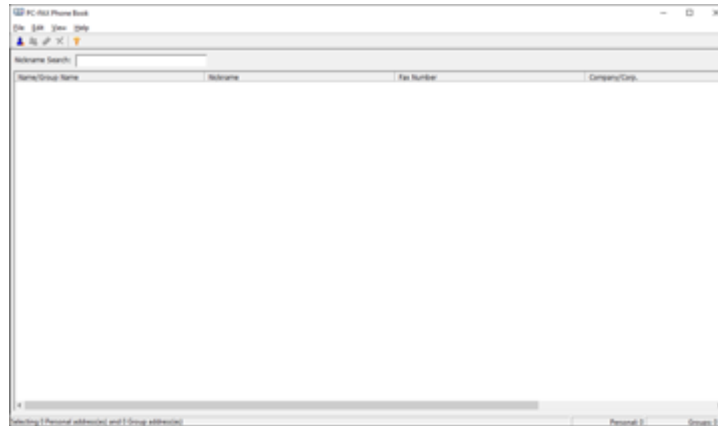

7. Select **File > Import From Windows Address Book**.
8. Select the contacts you want to import and click **OK**.

Note: For detailed information, select **Help** or **Open Online Help**.

Parent topic: [Setting Up Contacts and Contact Groups](#)

Setting Up Speed/Group Dial Lists Using the Fax Utility - Mac

You can set up your speed dial and group dial lists using the FAX Utility. The utility also lets you import fax numbers from the MacAddress Book and back up fax numbers to your product's memory.

Note: You can create up to 60 speed dial and group dial entries combined.

1. In the Apple menu or the Dock, select **System Preferences**. Select **Print & Fax**, **Print & Scan**, or **Printers & Scanners**, select the **FAX** option for your product, and select **Options & Supplies**. Select **Utility** and select **Open Printer Utility**.
2. Double-click **FAX Utility**, if necessary.

You see this window:

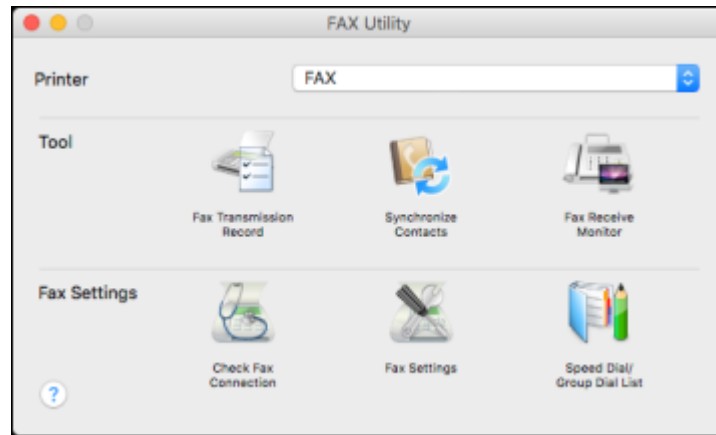

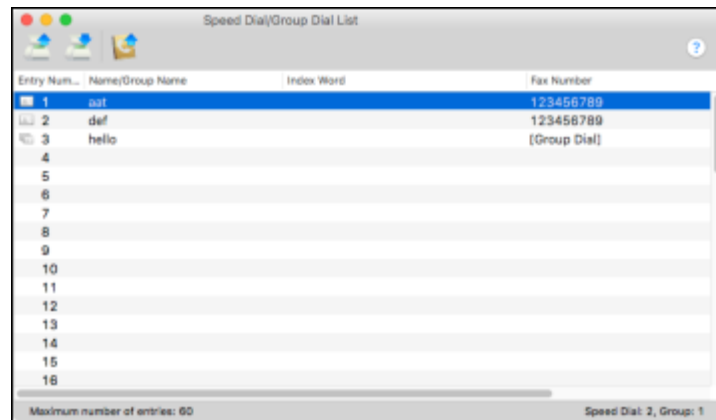

3. Select your **FAX** product in the Printer list.
4. Select **Speed Dial/Group Dial List**.

You see this window:



5. To add an entry, double-click an empty entry.

Note: To edit an entry, select it and change the information. To delete an entry, select it and press the **Delete** key on your keyboard.

6. Do one of the following:
 - To create a speed dial entry, select **Speed Dial**, enter a name and fax number, and click **OK**.
 - To create a group dial entry, select **Group Dial**, enter a name, select your desired fax numbers, and click **OK**.
7. Repeat the previous steps as necessary to add all your speed dial or group dial entries.
8. To import entries from your MacAddress book, click the  icon.
9. When you are finished, click the  icon to save the entries to your product's memory.

Parent topic: [Setting Up Contacts and Contact Groups](#)

Sending Faxes

See these sections to send faxes using your product.

[Sending Faxes from the Product Control Panel](#)

[Sending Faxes Using the Fax Utility - Windows](#)

[Sending Faxes Using the Fax Utility - Mac](#)

Parent topic: [Faxing](#)

Sending Faxes from the Product Control Panel

See these sections to send faxes using the product's control panel.

[Sending a Fax Using the Keypad, Contact List, or History](#)

[Fax Sending Options](#)

[Sending a Fax at a Specified Time](#)

[Sending a Fax on Demand](#)

[Sending a Stored Fax](#)

[Dialing Fax Numbers from a Connected Telephone](#)

Parent topic: [Sending Faxes](#)

Sending a Fax Using the Keypad, Contact List, or History

You can send a fax from your product control panel by entering the fax number, or selecting the number from either the contact list or fax history.

Note: You can send a black-and-white fax to up to 100 contacts or 99 groups at a time, or send a color fax to one recipient at a time. If your recipient's fax machine does not print in color, your fax is automatically sent in black-and-white.

1. Place your original on the product for faxing.
2. Press the  home button, if necessary.
3. Select **Fax**.

You see a screen like this:

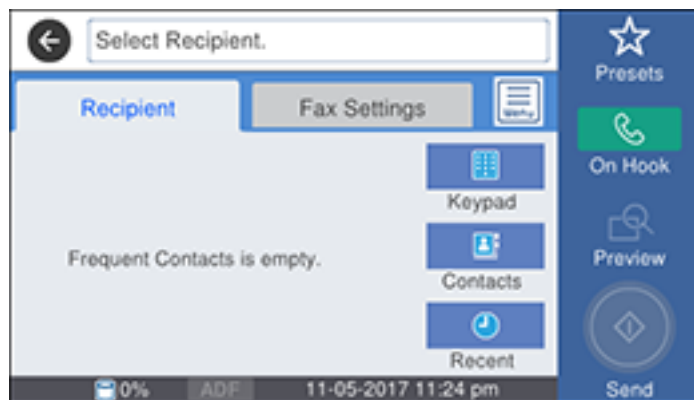

Note: To fax a double-sided document, place your document in the ADF and turn on the **ADF 2-Sided** setting. (You cannot fax double-sided documents in color.)

4. Do one of the following to select fax recipients:
 - **Manually enter a fax number:** Select **Keypad** and enter a fax number. Select **OK** when done. To add another fax number, repeat the same steps. You can also use the numeric keypad on the control panel to enter a fax number.

Note: If direct dialing has been restricted, you can only select the number from the contact list or fax history. If necessary, enter an outside line access code (such as 9) at the beginning of the fax

number. If the access code has been set up in the **Line Type** setting, enter the # pound sign instead of the code. If your fax number requires a brief pause, select the - icon to insert a pause symbol (–).

- **Select from the contact list:** Select **Contacts** to display the contact list. Select one or more contacts (select the contacts again to deselect it). You can also select the **Search for Contacts** field to search for recipients by name, index name, or entry number. Select **Close** when you are finished.
- **Select from the sent fax history:** Select **Recent** to display the sent fax history. Select a recipient from the list.

Note: To delete entered recipients, select the **Select Recipient** field, select the recipient you want to delete, and select **Remove**.

5. If you need to change any fax settings, select **Fax Settings** and select your settings.
6. If you want to preview your fax in black-and-white on the LCD, press the  icon. (If the preview looks incorrect, select **Retry**, reposition the document or change the fax settings, and repeat this step.) You cannot send the fax in color after previewing it.

Note: If you do not touch the preview screen for 20 seconds, your product sends the fax automatically. You cannot preview images when the Direct Send setting is turned on.

7. If you want to save your fax settings for later use, select **Presets** and add a new entry.
8. Press the **Send** icon.

Note: To cancel faxing, select **Cancel**.

Your product scans your original and prompts you to place additional pages, if necessary. After scanning your originals, your product dials the number and sends the fax.

Note: Your product does not save sent color faxes to its memory. If the **Settings > General Settings > Fax Settings > Send Settings > Save Failure Data** setting is enabled, faxes that failed to send are stored to the product's memory and you can resend them from the **Job/Status** menu.

Parent topic: [Sending Faxes from the Product Control Panel](#)

Related references[Fax Sending Options](#)**Related tasks**[Selecting the Line Type](#)[Using Presets](#)**Related topics**[Placing Originals on the Product](#)[Setting Up Contacts Using the Product Control Panel](#)**Fax Sending Options**

While sending a fax, you can select **Fax Settings** and select these options.

Setting	Options	Description
Original Size (Glass)	Various sizes	Sets the size for a document placed on the scanner glass
Original Type	Text	Specifies the document type of your originals and adjusts the quality of your copies
	Text & Image	
	Photo	
Color Mode	B&W	Select whether to scan images in black and white or color
	Color	
Resolution	Standard	Adjusts the scan resolution and print quality of outgoing faxes
	Fine	
	Super Fine	
	Ultra Fine	
Density	Varying levels	Lets you select from various density levels
Remove Background	Auto	Automatically removes any background color on scanned images
	Varying levels available	Lets you select from various levels of background color adjustment
Sharpness	Varying levels available	Lets you adjust the sharpness level of outgoing faxes

Setting	Options	Description
ADF 2-Sided	Off	Select On to enable 2-sided faxing from the ADF. The Direct Send option and color faxing are disabled when you turn on this setting.
	On	
Continuous Scan (ADF)	Off	<p>Select On to have the product to prompt if you want to scan another page after a document in the ADF has finished scanning.</p> <p>Note: If you leave the printer with the prompt displayed for 20 seconds, the product will start sending the document.</p> <p>If you load multiple sizes of documents in a single batch, they will be sent at the size of the largest document. To send them at their original size, do not mix sizes in the ADF.</p>
	On	
Direct Send	Off	Select On to send black-and-white faxes to a single recipient as soon as the connection is made, without saving the scanned image to memory. You cannot use this setting when sending a color fax or sending a fax to multiple recipients.
	On	
Priority Send	Off	Select On to send the current fax before other faxes waiting to be sent
	On	
Send Fax Later	Off	Select On to send the current fax at a selected time
	On	
Add Sender Information	Off	Lets you include a header, your phone number, or a destination list in the selected location on your outgoing faxes
	Outside of Image	
	Inside of Image	
Notify Send Result	Off	Sends a notification to the selected email address when an outgoing fax is sent
	On	
Transmission Report	Print on Error	Lets you select when to print transmission reports
	Print	
	Do Not Print	

Setting	Options	Description
Backup	Off	Saves a copy of the scanned fax to the selected email address or network folder/FTP location
	On	

Parent topic: [Sending Faxes from the Product Control Panel](#)

Sending a Fax at a Specified Time

You can send a fax at a time of your choice.

Note: Make sure the product's date and time settings are correct. You can only send faxes in black-and-white when you use this option.

1. Place your original on the product for faxing.
2. Press the  home button, if necessary.
3. Select **Fax**.

You see a screen like this:

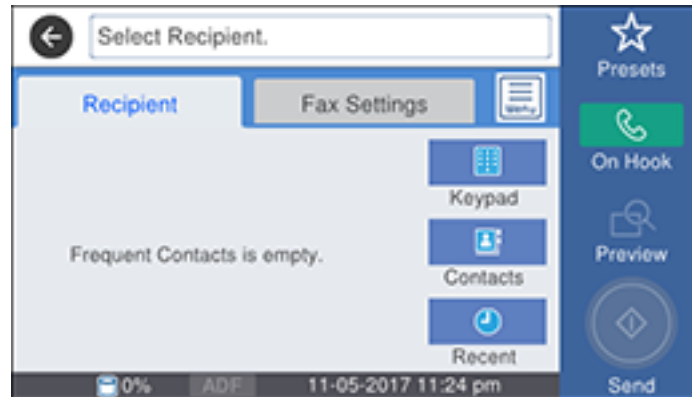

4. Enter a fax number or select a number from the Contacts or Recent lists.
5. Select **Fax Settings**.
6. Select **Send Fax Later**.
7. Select **On**.

8. Select **Time**, use the displayed keypad on the LCD screen to enter your desired time, and select **OK**.
9. Select **Send**.

Note: To cancel faxing, select **Cancel**.

After scanning your originals, your product dials the number and sends the fax at the specified time.

Note: If the product is turned off at the specified time, the fax is sent when it is powered on.

Parent topic: [Sending Faxes from the Product Control Panel](#)

Sending a Fax on Demand



You can store up to 10 scanned documents (up to 100 black-and-white pages) and have them sent automatically when another fax machine requests them. Other fax users can receive the document by calling your fax number and using the polling receive function on their fax machines.

Note: If you try to store more than 10 jobs or 100 pages, they overwrite previously stored documents. Be sure to check how many fax jobs are stored before storing additional jobs.

1. Place your original on the product for faxing.
2. Press the  home button, if necessary.
3. Select **Fax Box**.

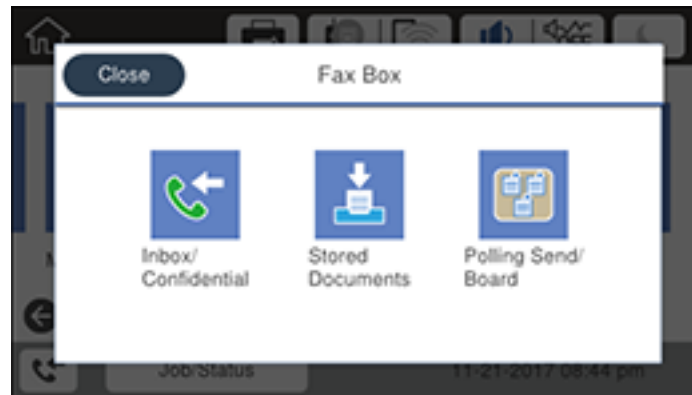
You see a screen like this:



4. Select **Polling Send/Board**.
5. Select **Polling Send**.
6. If you need to change any fax settings, select the  icon, select **Settings**, and change the settings.
7. Select **Add Document**.
8. Select  **Store**.

Your document is scanned and stored until you overwrite it or delete it.

Note: To display the stored job, press the  **Job/Status** button.

Parent topic: [Sending Faxes from the Product Control Panel](#)

Sending a Stored Fax



You can store up to 10 scanned documents (up to 100 black-and-white pages) and send them whenever necessary.

Note: If you try to store more than 10 jobs or 100 pages, they overwrite previously stored documents. Be sure to check how many fax jobs are stored before storing additional jobs by running a Fax Report.

1. Place your original on the product for faxing.
2. Press the  home button, if necessary.
3. Select **Fax**.

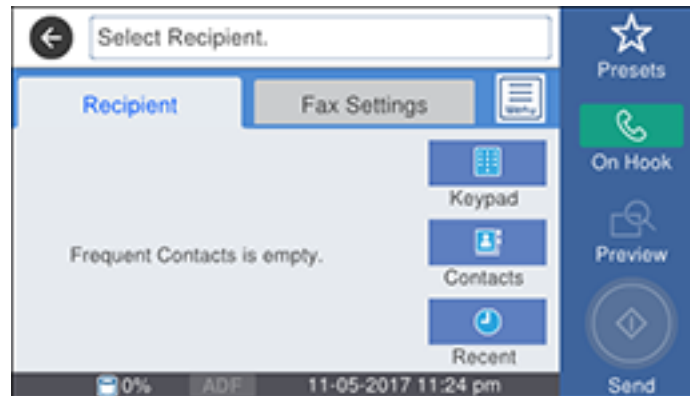
You see a screen like this:



4. Select the  icon.
5. Select **Extended Fax**.
6. Select **Store Fax Data** to turn on the setting and select **Close**.
7. Select any other fax settings as necessary and select **Close**.
8. Select **Store**.
9. When you are ready to send the document, press the  home button if necessary and select **Fax Box**.
10. Select **Stored Documents**.
11. Select the stored fax job you want to send.
12. Select **Start Sending**.

Parent topic: [Sending Faxes from the Product Control Panel](#)

Related tasks

[Printing Fax Reports](#)

Dialing Fax Numbers from a Connected Telephone

If you connected a telephone to the **EXT** port on your product, you can send a fax by dialing the fax number from the connected telephone. If the recipient's phone number and fax number are the same, you can speak to the recipient before sending the fax.

1. Place your original on the product for faxing.
2. Press the  home button, if necessary.
3. Dial the fax number from the connected telephone. Speak to the recipient if necessary.

Note: If you are using a pre-paid calling card, enter the number and password required to use the card before entering the destination fax number.

4. Select **Fax** on the LCD screen.

You see this screen:

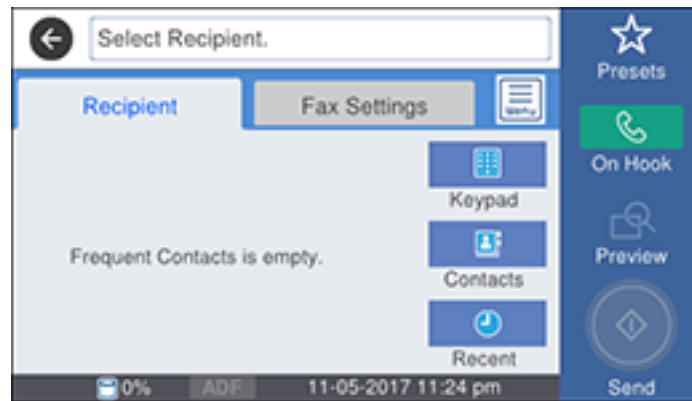

5. Select **Fax Settings** and select settings as necessary.

Note: Your product now communicates with the recipient's fax machine. Do not hang up the telephone.

6. When you hear a fax tone, select **Send** to start sending the fax.

Note: If your recipient's fax machine does not print in color, your fax is automatically sent in black-and-white.

7. Hang up the telephone.

Parent topic: [Sending Faxes from the Product Control Panel](#)

Sending Faxes Using the Fax Utility - Windows

You can send a fax from a printing program in Windows. You can fax up to 100 pages at a time, including a cover sheet.

1. Open the file you want to fax and select the print command.

You see a window like this:

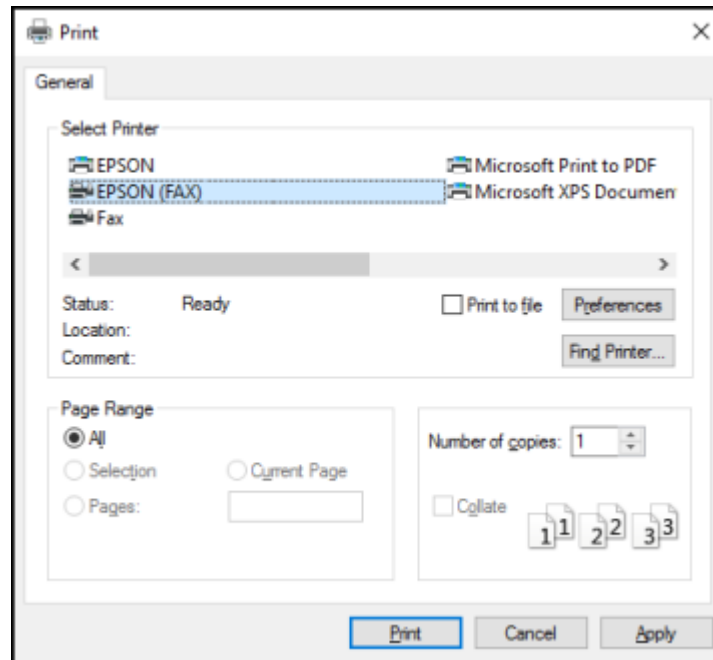

2. Select your product with the **FAX** option as the printer.
3. To change the Paper Size, Orientation, Color, Image Quality, or Character Density settings, click the **Preferences** or **Properties** button.

Note: If you see a **Setup**, **Printer**, or **Options** button, click it. Then click **Preferences** or **Properties** on the next screen. For more information about selecting fax print settings, click **Help**.

4. Select the Page Range as necessary. (Leave the Number of copies set to 1.)
5. Click **Print** or **OK**.

If you're faxing for the first time, you see a window like this one:

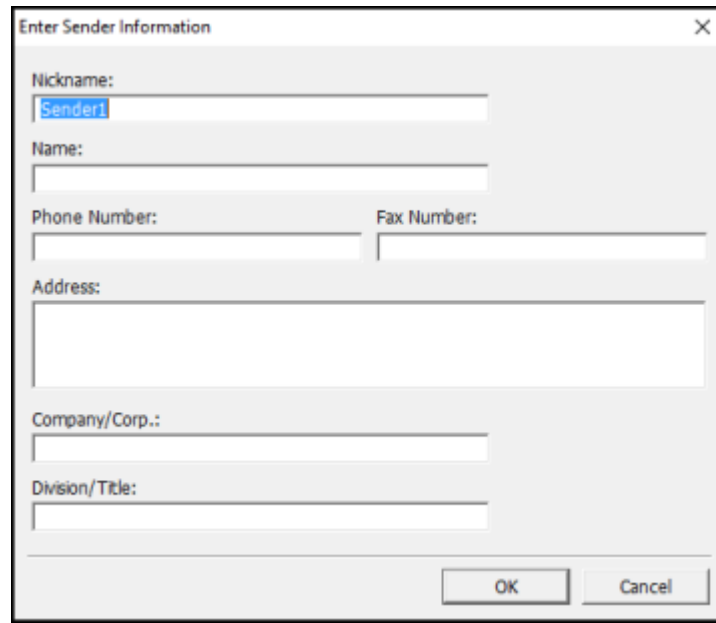

The image shows a dialog box titled "Enter Sender Information" with a close button (X) in the top right corner. The dialog contains several input fields: "Nickname:" with the text "Sender1" entered; "Name:" which is empty; "Phone Number:" and "Fax Number:" which are empty; "Address:" which is a large empty text area; "Company/Corp.:" which is empty; and "Division/Title:" which is empty. At the bottom right, there are two buttons: "OK" and "Cancel".

6. Enter your sender information so that recipients can identify the origin of the fax. Then click **OK** to save the sender information.

You see a window like this:

Recipient Settings (1 / 3)

Recipient List: Recipient Total: 0

Name/Group Name	Fax Number	Company/Corp.	Division/Title
-----------------	------------	---------------	----------------

Phone Book | Manual Dial

Name: Fax Number:

Title: Because "-" acts as a pause, do not use it to punctuate phone numbers.

Company/Corp.: Division/Title:

7. Enter the recipient's name and fax number or select a recipient from the phonebook, then click **Next**.

Note: For detailed instructions on using the Epson FAX Utility, click **Help**.

8. Select a cover sheet and enter a subject and message, then click **Next**.
9. Click **Send** to transmit your fax.

Parent topic: [Sending Faxes](#)

Sending Faxes Using the Fax Utility - Mac

You can send a fax from a Mac printing program using the FAX Utility. You can fax up to 100 pages at a time, including a cover sheet.

1. Open the file you want to fax.

2. Select the print command in your application.

Note: You may need to select a print icon on your screen, the **Print** option in the **File** menu, or another command. See your application's help utility for details.

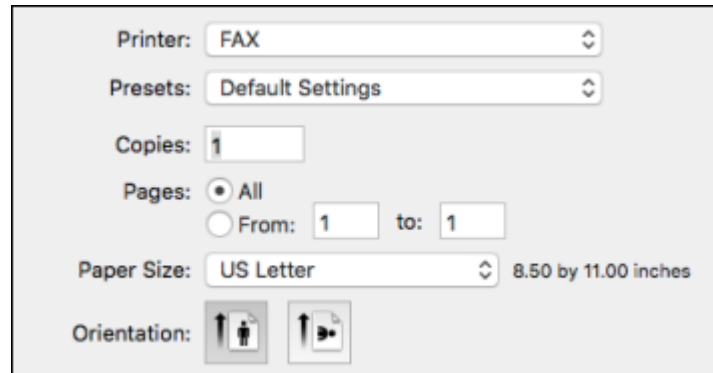

The image shows a print settings dialog box with the following controls:

- Printer:** A dropdown menu set to "FAX".
- Presets:** A dropdown menu set to "Default Settings".
- Copies:** A text input field containing the number "1".
- Pages:** Radio buttons for "All" (selected), "From: 1 to: 1".
- Paper Size:** A dropdown menu set to "US Letter" with the dimensions "8.50 by 11.00 inches" displayed to the right.
- Orientation:** Two icons: one for portrait orientation (vertical arrow) and one for landscape orientation (horizontal arrow).

3. Select your product **FAX** option as the **Printer** setting.
4. If necessary, click the arrow next to the Printer setting or the **Show Details** button to expand the print window.
5. Select the number of pages you are faxing as the **Pages** setting.

Note: Leave the **Copies** setting set to **1**.

6. Select **Recipient Settings** from the pop-up menu.

You see this window:

Recipient Settings

Recipient List:

Name	Company/Corp.	Fax Number
------	---------------	------------

Add:

Name:

Company/Corp.:

Fax Number:

A hyphen (-) is available only at the beginning of the phone number because it acts as a pause in dialing.

External Access Prefix:

Cancel Fax

7. Do one of the following to choose your recipient:
 - Select a name or group from the **Recipient List**.
 - Enter a name, company, and fax number and click the **+** button.
 - Click the  icon and select a recipient from your address book.
8. Select **Fax Settings** from the pop-up menu.

You see this window:

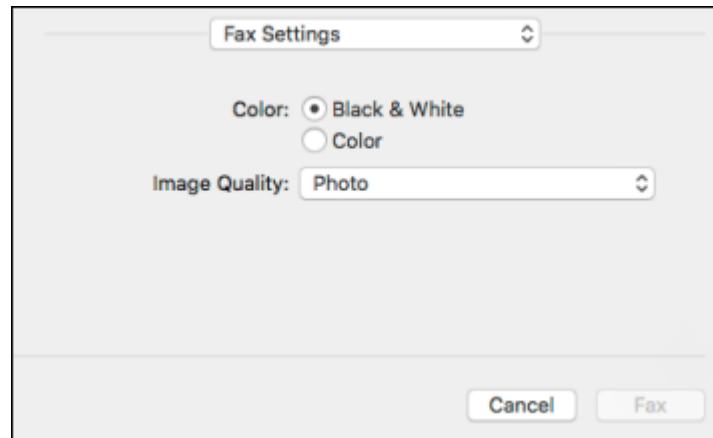

9. Select the **Color** and **Image Quality** settings you want to use for your fax.
10. Click **Fax**.

Parent topic: [Sending Faxes](#)

Receiving Faxes

See these sections to receive faxes with your product.

[Fax Reception](#)

[Receiving Faxes Automatically](#)

[Receiving Faxes Manually](#)

[Forwarding Received Faxes](#)

[Receiving a Fax by Polling](#)

[Saving Faxes to an External USB Device](#)

[Saving and Viewing Received Faxes](#)

[Selecting Received Fax Options Using the Fax Utility - Windows](#)

Parent topic: [Faxing](#)

Fax Reception

Your product will automatically receive and print faxes when you set the Receive Mode to **Auto**.

If you connected a telephone to your product so you can use the same phone line for faxes and voice calls, you can also set your product to receive faxes manually. This allows you to check for a fax tone using the telephone and press a button on your product to receive the fax.

Make sure to load paper in your product and select your fax settings before receiving a fax.

Note: If you run out of paper during fax printing, load more paper and press the button indicated on your product's LCD screen to continue.

Parent topic: [Receiving Faxes](#)

Receiving Faxes Automatically

To receive faxes automatically, make sure **Receive Mode** is set to **Auto** (the default setting for the product).

To change the Receive Mode if necessary, select **Settings > General Settings > Fax Settings > Basic Settings > Receive Mode**.

If an answering machine is connected, make sure the product's **Rings to Answer** setting is set higher than the number of rings your answering machine is set to answer a call. For example, if the answering machine is set to pick up on the fourth ring, set the product to pick up on the fifth ring or later.

Parent topic: [Receiving Faxes](#)

Related references

[Basic Settings - Fax](#)

Related tasks

[Receiving Faxes Manually](#)

Receiving Faxes Manually

You can set up your product to receive faxes manually by setting the Receive Mode to **Manual**. This lets you check for a fax tone on the connected telephone before receiving a fax.

1. To change the Receive Mode, select **Settings > General Settings > Fax Settings > Basic Settings > Receive Mode** and select **Manual**.
2. When the connected telephone rings, answer the call.
3. If you hear a fax tone, select **Fax** on the LCD screen.
4. Select **Send/Receive**.
5. Select **Receive**.

6. Select **Receive** again to start receiving the fax.
7. Hang up the telephone.

Parent topic: [Receiving Faxes](#)

Related references

[Basic Settings - Fax](#)

Related tasks

[Receiving Faxes Automatically](#)

Forwarding Received Faxes

You can forward received faxes to another fax machine, or convert the faxes into PDF documents and forward them to a shared folder on the network or to an email address. Forwarded faxes are deleted from the product's memory.

Before using this feature, make sure the date and time are set correctly, the forwarding destination is set up in the contact list, and the email server settings are configured.

1. Press the  home button, if necessary.
2. Select **Settings > General Settings > Fax Settings > Receive Settings > Save/Forward Settings > Unconditional Save/Forward > Forward**.
3. Select **Yes**.

Note: If you want to print the fax automatically before forwarding it, select **Yes and Print**.

4. Select **Add Entry**, select the forwarding destination from the contacts list, and select **Close**.
5. Confirm the displayed forwarding destinations and select **Close**.
6. Under Options When Forwarding Failed, select whether you want to print the faxes or save them in the printer's inbox if forwarding the received fax fails.

Parent topic: [Receiving Faxes](#)

Receiving a Fax by Polling

You can use polling to receive a fax from another fax machine (such as a fax information service).

Note: You cannot use polling to receive a fax from a fax information service that uses audio guidance.

1. Press the  home button, if necessary.

2. Select **Fax**.

You see a screen like this:

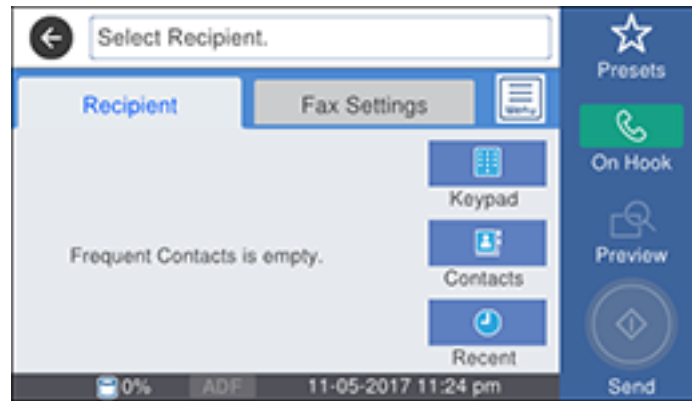

3. Select the  icon.
4. Select **Extended Fax**.
5. Select **Polling Receive** to turn on the setting and select **Close**.
6. Select **Close**.
7. Enter the fax number you expect to receive the fax from.
8. Select **Polling** to start receiving the fax.

Parent topic: [Receiving Faxes](#)

Saving Faxes to an External USB Device

You can save incoming faxes to an external USB device connected to your product.

1. Insert an external USB device into the product's USB port.
2. Press the  home button, if necessary.
3. Select **Settings > General Settings > Fax Settings > Receive Settings > Save/Forward Settings > Unconditional Save/Forward**.
4. Select **Save to Memory Device**
5. Select **Yes** to save the fax or **Yes and Print** to save and print the fax.

Parent topic: [Receiving Faxes](#)



Related tasks

[Connecting a USB Device](#)

Saving and Viewing Received Faxes

You can save received faxes in your product's memory and view them on the LCD screen. The inbox and confidential boxes can hold a maximum of 200 faxes in total.

Note: The inbox can be locked by an administrator. If you cannot access the inbox, contact your administrator for assistance.

1. Press the  home button, if necessary.
2. Select **Settings > General Settings > Fax Settings**.
3. To save received faxes, select **Receive Settings > Save/Forward Settings > Unconditional Save/Forward**.
4. Select **Save to Inbox** to turn on the setting.
5. Press the  home button again.
6. Select **Fax Box**.

You see a screen like this:

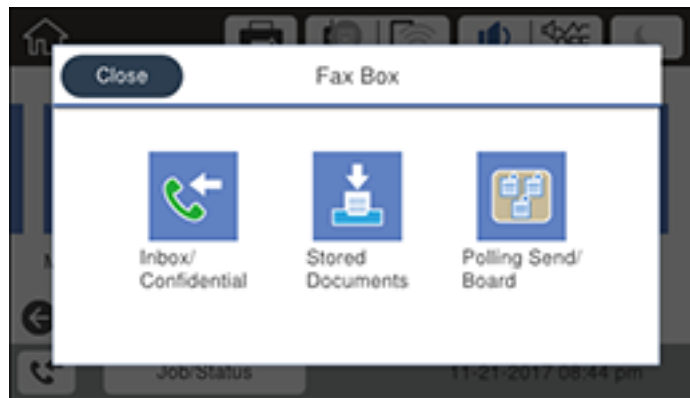

7. Do one of the following to view stored faxes:
 - Select **Inbox/Confidential** to view received faxes.



- Select **Stored Documents** to view saved faxes that have not been sent (available only when **Store Fax Data** is turned on).
 - Select **Polling Send/Board** to view faxes that are stored for fax polling or stored in a bulletin board.
8. Select the fax you want to view.
The LCD screen displays the fax contents.
 9. If you want to print or forward a stored fax, select the  icon.
 10. Select one of the printing or forwarding options, and follow the on-screen instructions.

Note: Delete faxes after you print or view them to free up the product's memory. When the memory is full, you can only forward or print incoming faxes.

Parent topic: [Receiving Faxes](#)

Selecting Received Fax Options Using the Fax Utility - Windows

You can select options for use with received faxes using the FAX Utility for Windows.

1. Do one of the following:
 - **Windows 10:** Click  and select **EPSON Software**.
 - **Windows 8.x:** Navigate to the **Apps** screen.
 - **Windows (other versions):** Click  or **Start > Programs** or **All Programs > EPSON Software**.
2. Select **FAX Utility**.

The first time you use the FAX Utility, you see this introduction window:

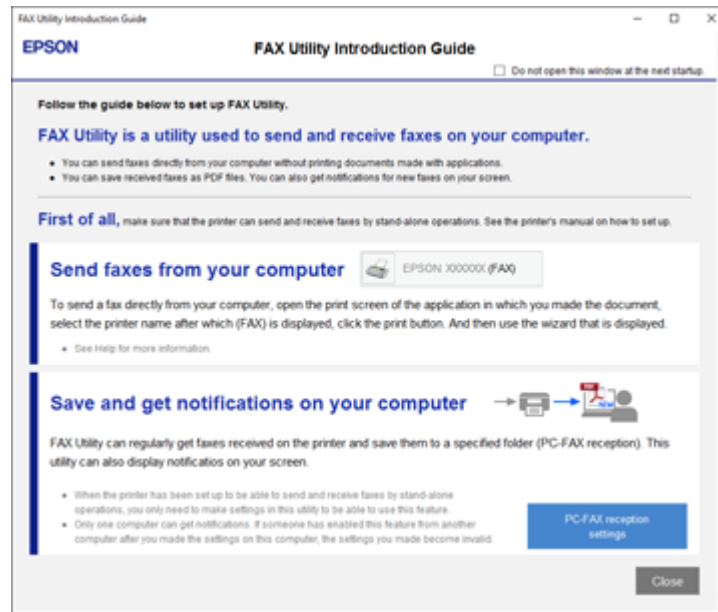

3. Read about the FAX Utility and click **Close** at the bottom of the window.

You see this window:

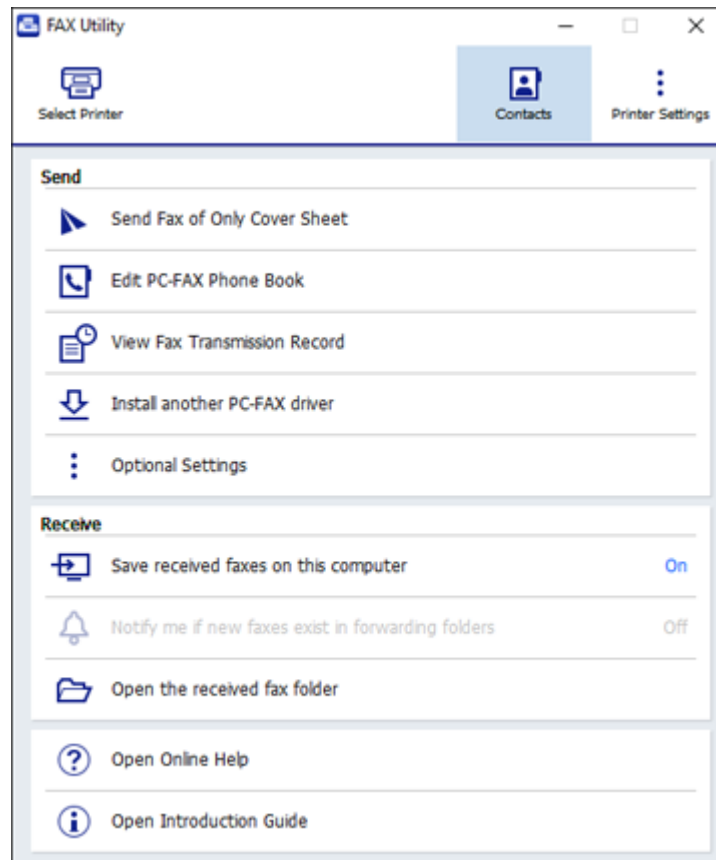

4. To save faxes received by your product on your computer, select **Save received faxes on this computer**.
5. Select the destination folder and other options, and click **OK**.
You return to the FAX Utility window.
6. To receive notifications when received faxes arrive in the selected destination folder on your computer, select **Notify me if new faxes exist in forwarding folders**.

7. Select how often you want to be notified of received faxes and click **OK**.

Note: For detailed information, click **Help** or **Open Online Help**.

Parent topic: [Receiving Faxes](#)

Checking Fax Status



You can check the status of fax jobs on the product control panel.

1. Press the  home button, if necessary.
2. Select **Fax**.

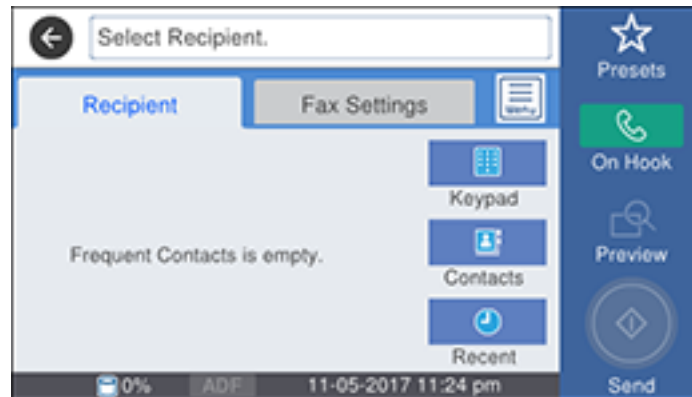
You see a screen like this:



3. Select the  icon.
4. To check the history of faxes that have been sent or received, select **Transmission Log** and select the job you want to check.

Note: If you see a numbered icon above the  icon on your product's LCD screen or the  **Received Fax** light is flashing, received faxes have been temporarily saved to the product's memory.

5. To check the status of a fax in progress, press the  **Job/Status** button.

Parent topic: [Faxing](#)

Printing Fax Reports

You can print several types of fax reports whenever necessary. You can also print the fax log automatically by turning on **Fax Log Auto Print**.

1. Press the  home button, if necessary.
2. Select **Fax**.

You see a screen like this:

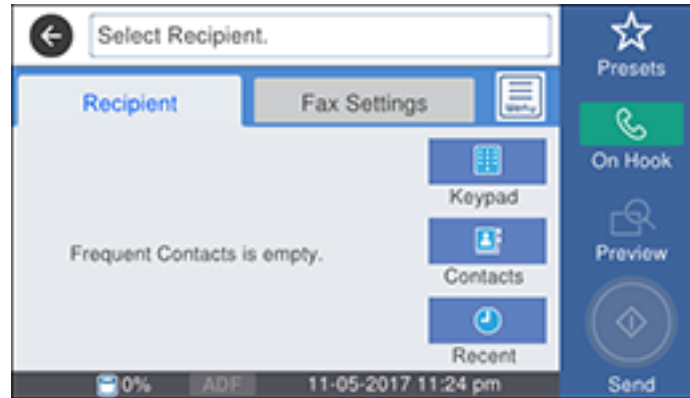

3. Press the  icon.
4. Select **Fax Report**.
5. Select the fax report you want to print.

[Fax Report Options](#)

Parent topic: [Faxing](#)

Fax Report Options

Select the fax report or list you want to print.

Last Transmission

Print a report on the fax that was previously sent or received through polling.

Fax Log

Print a report on recent fax transmissions.

Stored Fax Documents

Print a list of the fax jobs currently stored in the product's memory.

Fax Settings List

Print a list of the current fax communication settings.

Conditional Save/Forward List

Print a list of the current conditional save/forward settings.

Protocol Trace

Print a detailed report for the previously sent or received fax.

Parent topic: [Printing Fax Reports](#)

Using External USB Devices with Your Product

Follow the instructions here to work with an external USB device connected to your product.

[Connecting a USB Device](#)

[Disconnecting a USB Device](#)

[Viewing and Printing from the LCD Screen](#)

[Transferring Files on a USB Device](#)

Connecting a USB Device

Connect a USB device or its USB cable to the USB port on the front of the product.

Note: Epson cannot guarantee the compatibility of your device. Make sure the files on the device are compatible with the product.

[USB Device File Specifications](#)

Parent topic: [Using External USB Devices with Your Product](#)

USB Device File Specifications

You can use USB devices with your product containing files that meet these specifications.

File format	JPEG with the DCF (Design Rule for Camera File system) version 1.0 or 2.0 standard* TIFF 6.0-compliant uncompressed images: RGB full-color or binary (not CCITT-encoded) PDF version 1.7 compliant data file (WF-C5790)
Image size	80 × 80 pixels to 10200 × 10200 pixels
File size	Up to 2GB
Number of files	JPEG: Up to 9990** TIFF: Up to 999 PDF: Up to 999

* Files stored on digital cameras with built-in memory are not supported.

** If there are more than 999 files, the JPEGs will be displayed in groups.

Parent topic: [Connecting a USB Device](#)

Disconnecting a USB Device

After you finish working with a USB device, follow these steps to remove it.

1. If your product is connected to your computer using a USB cable, do one of the following:
 - **Windows:** Open the **My Computer**, **Computer**, **This PC**, or **Windows Explorer** utility. Then right-click the name of your USB device (listed as a removable disk) and select **Eject**.
 - **Mac:** Drag the removable disk icon for your USB device from the desktop into the trash.

Caution: Do not remove a USB device before completing the procedure above or you may lose data from the flash drive.

2. Pull the USB device or cable out of the USB port on the front of the product.

Parent topic: [Using External USB Devices with Your Product](#)

Viewing and Printing from the LCD Screen

See these sections to view and print photos or other files displayed on your product's LCD screen.

[Printing JPEG Photos](#)

[Printing TIFF Files](#)

[Printing PDF Files](#)

[Print Setting Options - Device Mode](#)

Parent topic: [Using External USB Devices with Your Product](#)

Printing JPEG Photos

You can select JPEG photos for printing as you view them on the LCD screen.

1. Press the  home button, if necessary.
2. Select **Memory Device > JPEG**.

Note: If you have more than 999 JPEG images on your device, the images are divided into groups, and you must first select the group you want to display.

You see a screen like this:



3. Do one of the following to select your photos:
 - In **Single View**, select the thumbnail image of the photo you want to print, then press the left or right arrow buttons to scroll through and select additional photos. Or you can select **Tile View** to select additional photos.
 - In **Tile View**, select the thumbnail images of the photos you want to print.
 - To select all photos, select the  icon and select **Select All Images**. Select **Yes**.
4. Select **Proceed to Print**.

You see a screen like this:

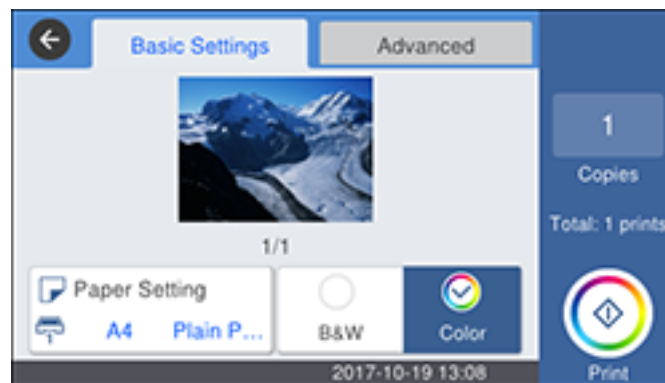

5. Do the following as necessary:
 - To change the print settings, select **Basic Settings** or **Advanced** and select the necessary settings.
 - To print more than one copy, select **Copies** and use the displayed keypad to select the number of copies (up to 99).
6. When you are ready to print, select **Print**.

Note: To cancel printing, select **Cancel**, then select **Cancel** again to confirm.

Parent topic: [Viewing and Printing from the LCD Screen](#)

Related references

[Print Setting Options - Device Mode](#)

Printing TIFF Files

You can select and print TIFF files from a USB flash drive.

1. Press the  home button, if necessary.
2. Select **Memory Device > TIFF**.
You see a list of the available files.
3. Select the file you want to print.
You see information about the file.
4. Do the following as necessary:
 - To change the print settings, select **Basic Settings** or **Advanced** and select the necessary settings.
 - To print more than one copy, select **Copies** and use the displayed keypad to select the number of copies (up to 99).
5. When you are ready to print, select **Print**.

Note: To cancel printing, select **Cancel**, then select **Cancel** again to confirm.

Parent topic: [Viewing and Printing from the LCD Screen](#)

Related references

[Print Setting Options - Device Mode](#)

Printing PDF Files

You can select and print PDF files from a USB flash drive (WF-C5790).

1. Press the  home button, if necessary.
2. Select **Memory Device > PDF**.
You see a list of the available files.
3. Select the file you want to print.
You see information about the file.
4. Do the following as necessary:
 - To change the print settings, select **Basic Settings** or **Advanced** and select the necessary settings.
 - To print more than one copy, select **Copies** and use the displayed keypad to select the number of copies (up to 99).
5. When you are ready to print, select **Print**.

Note: To cancel printing, select **Cancel**, then select **Cancel** again to confirm.

Parent topic: [Viewing and Printing from the LCD Screen](#)

Print Setting Options - Device Mode

Select the print settings you want to use when printing from a USB device.

Note: Not all options or settings may be available, depending on the file format.

Basic Settings

Print settings	Available options	Description
Paper Setting	Various paper size and type settings	Indicates the source that contains the paper size and type you want to print on
Color Mode	B&W	Prints the photo in black and white
	Color	Prints the photo in color

Advanced settings

Print settings	Available options	Description
Layout	1-Up	Leaves a small margin around the image
	20-up	Prints 20 images on one page
	Index	Prints thumbnail images with file information
Fit Frame	On	Automatically crops the photo to fit into the selected photo layout
	Off	Turns off automatic cropping
Quality	Standard	Provides good quality for most prints
	Best	Provides the highest quality for special prints
Date	Various date formats	Prints the date the photo was taken on the photo in the format you select
Fix Photo	Auto	Automatically adjusts the brightness, contrast, and saturation of the photo based on the setting that is selected
	People	
	Landscape	
	Night Scene	
	Enhance Off	Turns off automatic adjustments; see Note below
Fix Red-Eye	On	Automatically fixes the red-eye effect in photos
	Off	
Print Order	Last Page on Top	Select the order for printing multi-page TIFF files
	First Page on Top	
2-Sided	On	Select whether to print PDF files using 2-sided printing (WF-C5790). When set to On , you can also select a binding direction using the Binding(Copy) setting.
	Off	

Note: Fix Photo uses a sophisticated face recognition technology to optimize photos that include faces. For this to work, both eyes and the nose must be visible in the subject's face. If your photo includes a face with an intentional color cast, such as a statue, you may want to turn off **Fix Photo** to retain the special color effects.

Parent topic: [Viewing and Printing from the LCD Screen](#)

Transferring Files on a USB Device

You can transfer files to and from a USB device inserted into the USB port on the front of your product.

[Setting Up File Sharing for File Transfers from Your Computer](#)

[Transferring Files from a USB Device to Your Computer](#)

Parent topic: [Using External USB Devices with Your Product](#)

Setting Up File Sharing for File Transfers from Your Computer

Before you transfer files from a computer to a USB device inserted into the USB port on the front of your product, you may need to set up your product's file sharing settings.

Caution: Remove the USB device before you change this setting or you may lose data from the device.

1. Press the  home button, if necessary.
2. Select **Settings** > **General Settings** > **Printer Settings** > **Memory Device Interface**.

You see a screen like this:

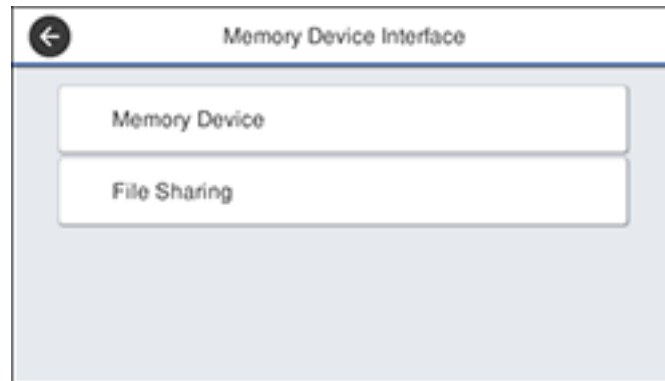

3. Select **Memory Device** and make sure **Enable** is selected.
4. Select **File Sharing**.
5. Select the way your computer is connected to the product: either **USB** or **Network**.

Parent topic: [Transferring Files on a USB Device](#)

Transferring Files from a USB Device to Your Computer

You can transfer files to and from a USB device inserted into the USB port on the front of your product and a computer connected to your product.

Note: Do not transfer files to and from a USB device while you are printing from the device.

1. Make sure your product is connected to a computer.
2. Insert a USB device or its USB cable into the USB port on the front of your product.
3. Do one of the following to access your USB device files from your computer:
 - **Windows:** Open the **My Computer**, **Computer**, **This PC**, or **Windows Explorer** utility, then select the removable disk icon.
 - **Mac with a USB connection:** Look for the removable disk icon on your desktop, then select it.
 - **Mac with a network connection:** Select the hard drive icon on your desktop or select **Computer** from the **Go** menu, select your product in the **SHARED** section of the sidebar (you may need to widen the sidebar to see the name), and select the **USBSTORAGE** icon.
4. Select the folder that contains your files.
5. Drag the files you want to transfer to the desired folder on your computer or on your USB device.

Note: Your product's LCD screen does not update to display new information about your USB device after you copy files to it or delete files from it. Remove and insert the USB device to update the information.

Parent topic: [Transferring Files on a USB Device](#)

Replacing Ink Supply Units (Ink Packs) and Maintenance Boxes

When ink is expended in an ink pack or the maintenance box is at the end of its service life, you need to replace it. The maintenance box stores ink that gets flushed from the system during print head cleaning.

Note: Please dispose of your used Epson branded ink packs and maintenance boxes responsibly and in accordance with local requirements. If you would like to return your used ink packs and maintenance boxes to Epson for proper disposal, please go to [epson.com/recycle](https://www.epson.com/recycle) for more information.

- [Check Ink and Maintenance Box Status](#)
- [Purchase Epson Ink Packs and Maintenance Boxes](#)
- [Removing and Installing Ink Packs](#)
- [Printing with Black Ink and Expended Color Ink Packs](#)
- [Conserving Low Black Ink with Windows](#)
- [Maintenance Box Replacement](#)

Check Ink and Maintenance Box Status

Your product and its software will let you know when ink is low or expended, or when the maintenance box needs to be replaced.

Note: When using the Epson Universal Print Driver or PostScript (PS3) printer software with the product (WF-C5790), you can check ink and maintenance box status by using the product buttons or the utilities included with the standard Epson printer software. To download the standard Epson printer software, visit [epson.com/support](https://www.epson.com/support) (U.S.), [epson.ca/support](https://www.epson.ca/support) (Canada), or [epson.com.jm/support](https://www.epson.com.jm/support) (Caribbean) and select your product.



- [Checking Ink Status on the LCD Screen](#)
- [Checking Ink and Maintenance Box Status - Windows](#)
- [Checking Ink and Maintenance Box Status - Mac](#)

Parent topic: [Replacing Ink Supply Units \(Ink Packs\) and Maintenance Boxes](#)

Checking Ink Status on the LCD Screen

When one of your ink packs is low or expended, you see a message on the LCD screen. Select **How To** and follow the steps on the LCD screen to replace the ink pack.

You can also check the status of the ink packs and maintenance box from the product control panel.

1. Press the  home button, if necessary.
2. Select the  icon.

You see a screen like this:

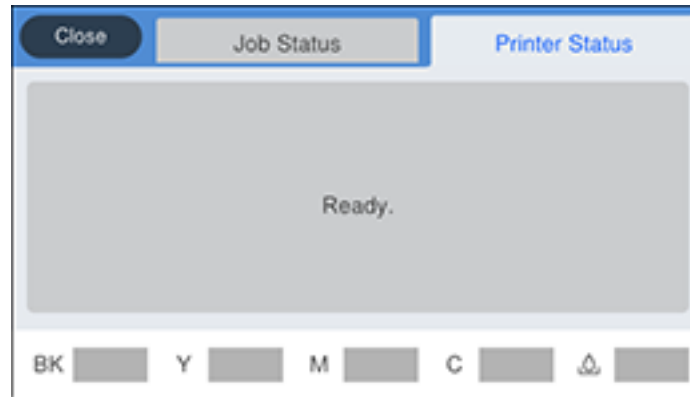

The ink and maintenance box levels are displayed at the bottom of the screen.

Note: The displayed ink and maintenance box levels are approximate.

3. For more information, select the ink images at the bottom of the screen.

Parent topic: [Check Ink and Maintenance Box Status](#)

Related concepts



[Maintenance Box Replacement](#)

Related tasks

[Removing and Installing Ink Packs](#)

Checking Ink and Maintenance Box Status - Windows

A low ink reminder appears if you try to print when ink is low. You can also check your ink or maintenance box status at any time using a utility on your Windows computer.

1. To check your status, access the Windows Desktop and double-click the  icon for your product in the right side of the Windows taskbar, or click the up arrow and right-click . Then click **Details**.

You see this window:



2. Replace or reinstall the maintenance box or ink pack as indicated on the screen.

Note: If any of the ink packs installed in the product is broken, incompatible with the product model, or improperly installed, Epson Status Monitor will not display an accurate ink status.

3. To disable promotional offers, right-click the product icon in the Windows taskbar and select **Monitoring Preferences**.

You see this window:

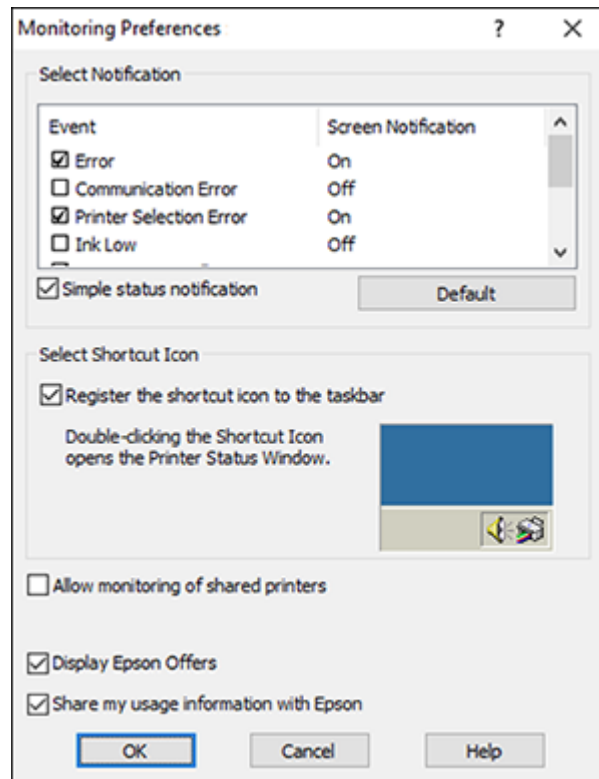

4. Deselect the **Display Epson Offers** checkbox.

Parent topic: [Check Ink and Maintenance Box Status](#)

Related concepts

[Maintenance Box Replacement](#)

Related tasks

[Removing and Installing Ink Packs](#)

Checking Ink and Maintenance Box Status - Mac

You can check the status of your ink and maintenance box using a utility on your Mac.

1. In the Apple menu or the Dock, select **System Preferences**. Select **Print & Fax**, **Print & Scan**, or **Printers & Scanners**, select your product, and select **Options & Supplies**. Select **Utility** and select **Open Printer Utility**.
2. Select **EPSON Status Monitor**.

You see this window:

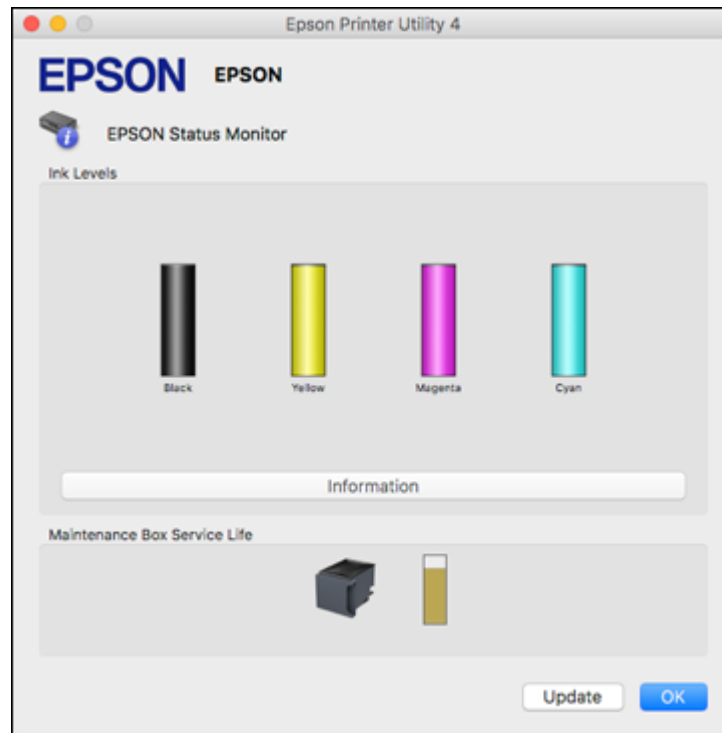

3. Do the following as necessary:
 - You can update the ink and maintenance box status by clicking **Update**.
 - Replace or reinstall the maintenance box or an ink pack as indicated on the screen.

Note: If an ink pack installed in the product is broken, incompatible with the product model, or improperly installed, Epson Status Monitor will not display an accurate ink status.

Parent topic: [Check Ink and Maintenance Box Status](#)

Related concepts[Maintenance Box Replacement](#)**Related tasks**[Removing and Installing Ink Packs](#)

Purchase Epson Ink Packs and Maintenance Boxes

You can purchase genuine Epson ink, maintenance boxes, and paper at epson.com (U.S. sales), epson.ca (Canadian sales), or epson.com.jm (Caribbean sales). You can also purchase supplies from an Epson authorized reseller. To find the nearest one, call 800-GO-EPSON (800-463-7766) in the U.S. or 800-807-7766 in Canada.

Note: This printer is designed for use with Epson ink packs only, not third-party ink packs or ink. Other brands of ink supplies are not compatible and, if described as compatible, may not function properly or continuously. Such restrictions can be avoided with some other printers such as Epson EcoTank cartridge-free printers.

The included initial ink packs are designed for reliable printer setup and cannot be used as replacement ink packs or resold. After setup, the remaining ink is available for printing. Yields are based on ISO 24711 in default mode, printing continuously. Yields vary due to print images, settings, and temperatures. Printing infrequently or primarily with one color reduces yields. All ink packs must be installed with ink for printing and printer maintenance. For print quality, some ink remains in replaced ink packs.

[Ink Supply Unit \(Ink Pack\) Part Numbers](#)**Parent topic:** [Replacing Ink Supply Units \(Ink Packs\) and Maintenance Boxes](#)

Ink Supply Unit (Ink Pack) Part Numbers

Use these part numbers when you order or purchase new ink packs.

Maintenance box part number: T6716

Ink color	Part number		
	Standard-capacity	High-capacity	Extra High-capacity
Black	902	902XL	902XXL
Cyan	902	902XL	—
Magenta	902	902XL	—

Ink color	Part number		
	Standard-capacity	High-capacity	Extra High-capacity
Yellow	902	902XL	—

Parent topic: [Purchase Epson Ink Packs and Maintenance Boxes](#)

Removing and Installing Ink Packs

Make sure you have your replacement ink packs handy before you begin. You must install new ink packs immediately after removing the old ones.

1. If an ink pack is low or expended, you see a message on your product's LCD screen and on your computer screen. Note which ink packs need to be replaced.
2. Unlock and open the front cover.

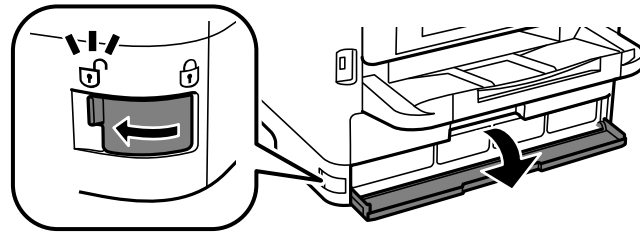

3. Press the ink pack tray until it clicks and pull it out.

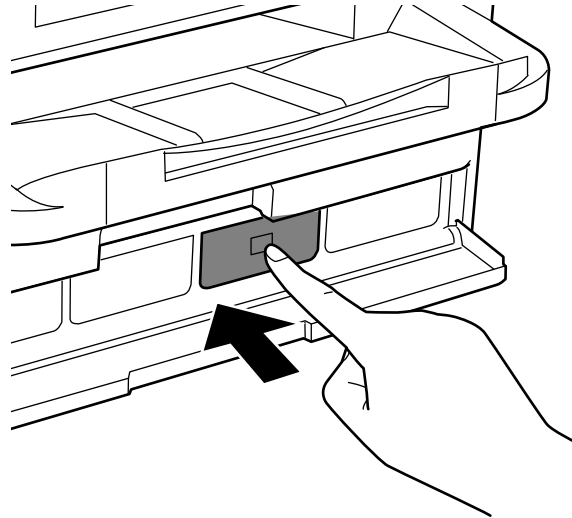

4. Remove the used ink pack from the tray.

Note: Dispose of used ink packs carefully. Do not take the used ink pack apart or try to refill it.

Warning: If ink gets on your skin, wash it thoroughly with soap and water. If ink gets into your eyes, flush them immediately with water. Seek medical advice if problems persist. If ink gets into your mouth, spit it out and see a doctor right away. Keep ink packs out of the reach of children.

5. Shake the new ink pack 10 times and remove it from the packaging.

Caution: Do not touch the green chip on the ink pack.

6. Insert the new ink pack into the ink pack tray as shown. Make sure the top of the ink pack is level with the top of the tray.

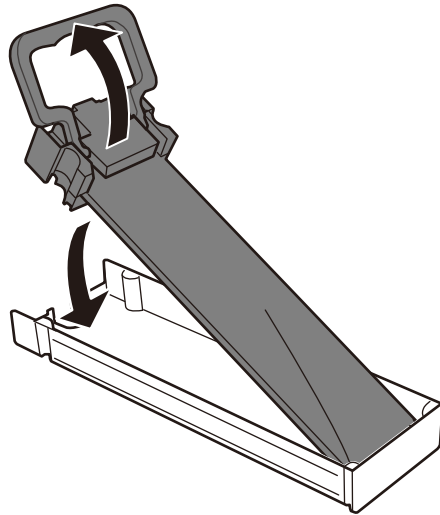

7. Slide the ink pack tray into the product until it clicks.

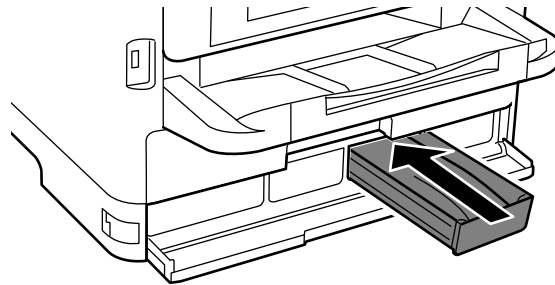

Note: If you cannot insert the tray all the way, make sure you are inserting the correct color ink pack and that the top of the ink pack is level with the top of the tray. The ink packs can only be inserted into the proper location.

8. Repeat these steps for each ink pack you want to install.

9. When you are finished, close and lock the front cover.

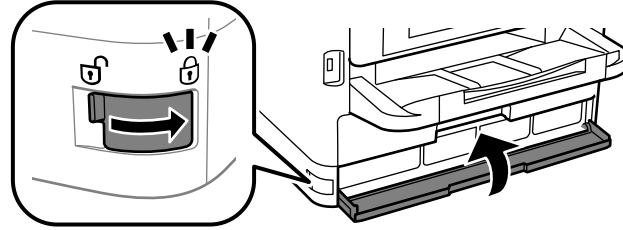

10. Follow the on-screen instructions to charge your product's ink.

Parent topic: [Replacing Ink Supply Units \(Ink Packs\) and Maintenance Boxes](#)

Related concepts

[Purchase Epson Ink Packs and Maintenance Boxes](#)

Printing with Black Ink and Expended Color Ink Packs

When a color ink pack is expended, you can temporarily continue printing from your computer using black ink. Replace the expended color ink pack as soon as possible for future printing.

Note: You cannot print with expended color ink using your product's control panel.

[Printing with Expended Color Ink Packs - Windows](#)

[Printing with Expended Color Ink Packs - Mac](#)

Parent topic: [Replacing Ink Supply Units \(Ink Packs\) and Maintenance Boxes](#)

Printing with Expended Color Ink Packs - Windows

If you see a message during printing telling you that you can temporarily print in black ink with an expended color ink supply unit, you can cancel your print job and select settings to print on plain paper or on an envelope.

Note: To use this feature, Epson Status Monitor must be enabled.

1. Click **Cancel** or **Cancel Print** to cancel your print job.

Note: If the message screen appears on another computer on a network, you may need to cancel the print job using the product control panel.

2. Load plain paper or an envelope in your product.
3. Access the print settings in your print application.
4. Click the **Main** tab.
5. Select **Plain Paper/Bright White Paper** or **Envelope** as the paper type setting.
6. Select the **Black/Grayscale** or **Grayscale** checkbox.
7. Click **OK**.
8. Print your document.
Epson Status Monitor 3 displays a print message.
9. Click **Print in Black** to print your document.

Parent topic: [Printing with Black Ink and Expended Color Ink Packs](#)

Printing with Expended Color Ink Packs - Mac

If printing stops, you can cancel your print job and select settings to temporarily print with only black ink on plain paper or on an envelope.

1. Click the printer icon in the Dock.
2. If you see a message telling you that you can temporarily print with only black ink, click the **Delete** or  icon to cancel your print job. (If an error message is displayed, click **OK**.)

Note: If the message screen appears on another computer on a network, you may need to cancel the print job using the product control panel.

3. In the Apple menu or the Dock, select **System Preferences**.
4. Select **Print & Fax**, **Print & Scan**, or **Printers & Scanners**, select your product, and select **Options & Supplies**.
5. Select **Driver** or **Options**.

You see a screen like this:

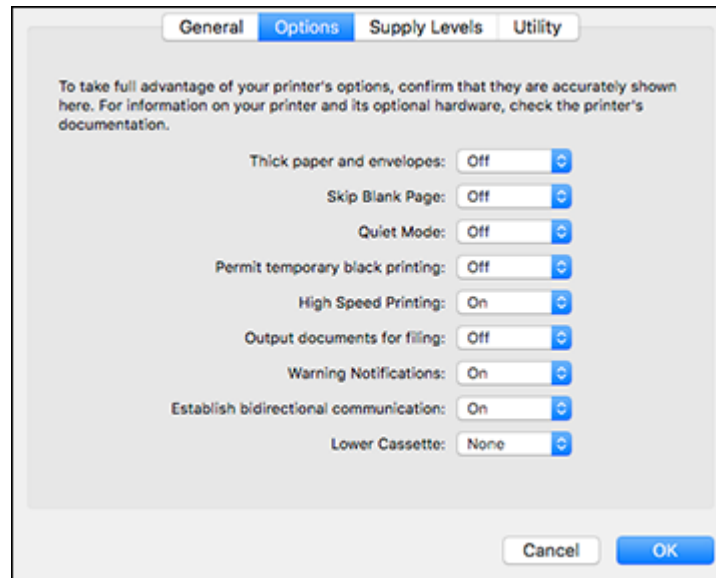

6. Select **On** as the **Permit temporary black printing** setting.
7. Click **OK**.
8. Close the utility window.
9. Load plain paper or an envelope in your product.
10. Access the print settings in your print application.
11. Select **Print Settings** from the pop-up menu.
12. Select **Plain Paper/Bright White Paper** or **Envelope** as the paper type setting.
13. Select the **Grayscale** option.
14. Click **Print** to print your document.

Parent topic: [Printing with Black Ink and Expended Color Ink Packs](#)

Conserving Low Black Ink with Windows

When black ink runs low and there is more color ink, you may see a message telling you that you can print with a mixture of color inks to create composite black.

Note: The window appears only when you have selected **Plain Paper/Bright White Paper** as the paper type setting, and depends on other selected print settings. To use this feature, Epson Status Monitor must be enabled.

- Click **Yes** to use a mixture of color inks to create black, or **No** to continue using the remaining black ink for the document you are printing.
- Click **Disable this feature** to continue using the remaining black ink.

Note: If you disable this feature, it remains disabled until you replace the black ink pack.

Parent topic: [Replacing Ink Supply Units \(Ink Packs\) and Maintenance Boxes](#)

Maintenance Box Replacement

The maintenance box stores surplus ink that gets flushed from the system during print head cleaning. When you see a message on the LCD screen, follow the on-screen instructions to replace the maintenance box.

Note the following precautions when replacing the maintenance box:

- Do not remove the maintenance box or its cover except when replacing the maintenance box.
- Do not touch the green chip on the side of the maintenance box.
- Do not tilt the maintenance box after removing it or ink may leak.
- Do not touch the openings in the maintenance box or you may get ink on you.
- Do not drop the maintenance box or subject it to strong shocks.
- If you cannot replace the cover, the maintenance box may not be installed correctly. Remove and reinstall the maintenance box.
- Do not store the maintenance box in high or freezing temperatures.

Caution: Do not reuse a maintenance box that has been removed and left uninstalled for a long period. Keep the maintenance box away from direct sunlight.

Note: The maintenance box is a user-replaceable part and is not covered by the product warranty.

Parent topic: [Replacing Ink Supply Units \(Ink Packs\) and Maintenance Boxes](#)

Related concepts

[Purchase Epson Ink Packs and Maintenance Boxes](#)

Adjusting Print Quality

If your print quality declines, you may need to run a utility to clean or align the print head.

Note: If you are using your Epson product with the Windows 10 S operating system, you cannot use the software described in this section. You also cannot download and install any Epson product software from the Epson website for use with Windows 10 S; you must obtain software only from the Windows Store.

Note: When using the Epson Universal Print Driver or PostScript (PS3) printer software with the product (WF-C5790), you can clean the print head, adjust the print quality, and run a nozzle check by using the product buttons or the utilities included with the standard Epson printer software. To download the standard Epson printer software, visit epson.com/support (U.S.), epson.ca/support (Canada), or epson.com.jm/support (Caribbean) and select your product.

If running these utilities does not solve the problem, you may need to replace the ink packs.

[Print Head Maintenance](#)

[Print Head Alignment](#)

[Cleaning the Paper Guide](#)

Print Head Maintenance

If your printouts become too light, or you see dark or light bands across them, you may need to clean the print head nozzles. Cleaning uses ink, so clean the nozzles only if print quality declines.

You can check for clogged nozzles before you clean them so you don't clean them unnecessarily.

Note: You cannot clean the print head if ink is expended, and may not be able to clean it when ink is low. You must replace the ink pack first.

[Print Head Nozzle Check](#)

[Print Head Cleaning](#)

Parent topic: [Adjusting Print Quality](#)

Related tasks

[Removing and Installing Ink Packs](#)

Print Head Nozzle Check

You can print a nozzle check pattern to check for clogged nozzles.

[Checking the Nozzles Using the Product Control Panel](#)

[Checking the Nozzles Using a Computer Utility](#)

Parent topic: [Print Head Maintenance](#)

Checking the Nozzles Using the Product Control Panel

You can check the print head nozzles using the control panel on your product.

1. Make sure there are no errors on the LCD screen.
2. Load a few sheets of plain paper in the product.
3. Press the  home button, if necessary.
4. Select **Settings** > **Maintenance** > **Print Head Nozzle Check**.

You see a screen like this:



5. Select **Start**.
The nozzle pattern prints.

6. Check the printed pattern to see if there are gaps in the lines.

Print head is clean

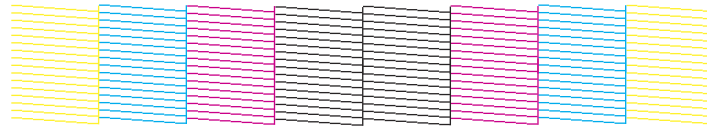

Print head needs cleaning



7. Do one of the following:
 - If there are no gaps, select **O**.
 - If there are gaps or the pattern is faint, select **X** and continue.
8. Follow the instructions on the screen to clean the print head, check the nozzles, and repeat the process as necessary.

Caution: Never turn off the product or open the front cover during a cleaning cycle or you may not be able to print.

If you don't see any improvement after cleaning the print head up to 4 times, wait at least 6 hours without printing. Then try cleaning the print head again. If quality still does not improve, contact Epson.

Parent topic: [Print Head Nozzle Check](#)

Related concepts

[Print Head Cleaning](#)

Related tasks



[Removing and Installing Ink Packs](#)

[Loading Paper in the Cassette](#)

[Checking the Nozzles Using a Computer Utility](#)

Checking the Nozzles Using a Computer Utility

You can check the print head nozzles using a utility on your Windows or Mac computer.

1. Make sure there are no errors on the LCD screen.
2. Load a few sheets of plain paper in the product.
3. Do one of the following:
 - **Windows:** Access the Windows Desktop and right-click the  icon for your product in the right side of the Windows taskbar, or click the up arrow and right-click .
 - **Mac:** In the Apple menu or the Dock, select **System Preferences**. Select **Print & Fax**, **Print & Scan**, or **Printers & Scanners**, select your product, and select **Options & Supplies**. Select **Utility** and select **Open Printer Utility**.
4. Select **Nozzle Check**.

You see a window like this:

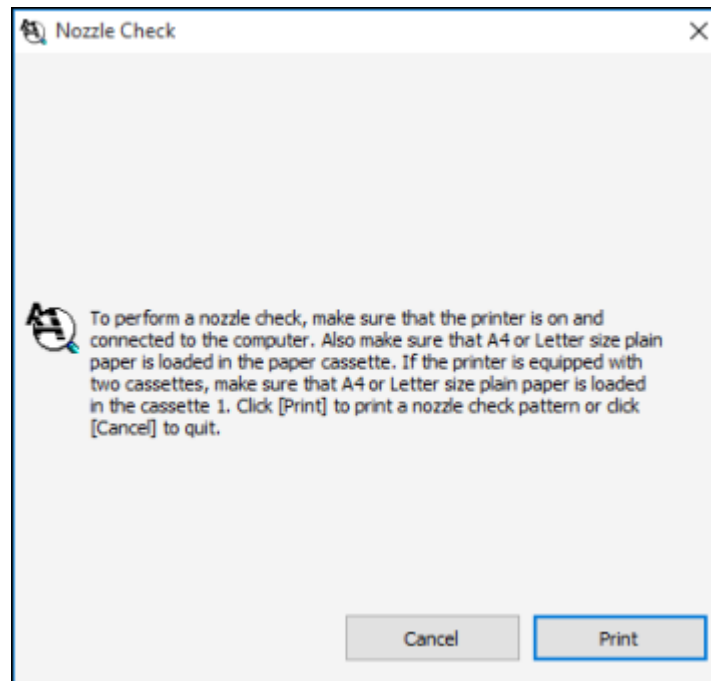

5. Click **Print**.
6. Check the printed pattern to see if there are gaps in the lines.

Print head is clean



Print head needs cleaning



7. If there are no gaps, click **Finish**.

Caution: Never turn off the product or open the front cover during a cleaning cycle or you may not be able to print.

If there are gaps or the pattern is faint, clean the print head.

If you don't see any improvement after cleaning the print head up to 4 times, wait at least 6 hours without printing. Then try cleaning the print head again. If quality still does not improve, contact Epson.

Parent topic: [Print Head Nozzle Check](#)

Related concepts

[Print Head Cleaning](#)

Related tasks

[Removing and Installing Ink Packs](#)

[Loading Paper in the Cassette](#)

[Checking the Nozzles Using the Product Control Panel](#)

Print Head Cleaning

If print quality has declined and the nozzle check pattern indicates clogged nozzles, you can clean the print head.

Note: You cannot clean the print head if ink is expended, and may not be able to clean it when ink is low. You must replace the ink pack first.

[Cleaning the Print Head Using the Product Control Panel](#)

[Cleaning the Print Head Using a Computer Utility](#)

Parent topic: [Print Head Maintenance](#)

Related tasks

[Removing and Installing Ink Packs](#)

Cleaning the Print Head Using the Product Control Panel

You can clean the print head using the control panel on your product.

1. Make sure there are no errors on the LCD screen.
2. Load a few sheets of plain paper in the product.
3. Press the  home button, if necessary.
4. Select **Settings** > **Maintenance** > **Print Head Cleaning**.

You see a screen like this:

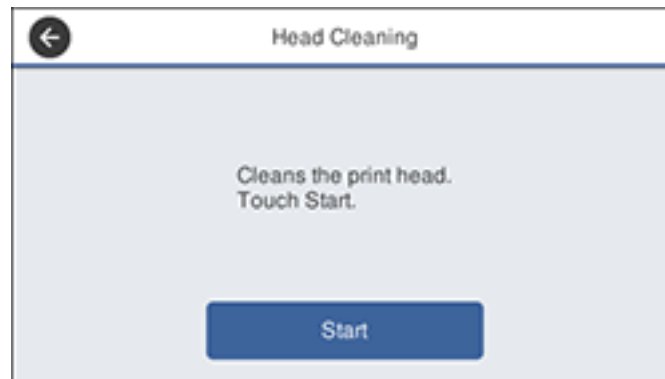

5. Select **Start** to clean the print head.

When the cleaning cycle is finished, you see a message on the screen.

Caution: Never turn off the product or open the front cover during a cleaning cycle or you may not be able to print.

6. Select **Yes** if you want to print a new nozzle check pattern.
7. Select **Start** to print a nozzle check pattern and confirm that the print head is clean.
8. Check the printed pattern to see if there are gaps in the lines.

Print head is clean



Print head needs cleaning



If you don't see any improvement after cleaning the print head up to 4 times, wait at least 6 hours without printing. Then try cleaning the print head again. If quality still does not improve, contact Epson.

Parent topic: [Print Head Cleaning](#)

Related tasks

[Loading Paper in the Cassette](#)



[Cleaning the Print Head Using a Computer Utility](#)

Cleaning the Print Head Using a Computer Utility

You can clean the print head using a utility on your Windows computer or Mac.

1. Make sure there are no errors on the LCD screen.
2. Load a few sheets of plain paper in the product.

3. Do one of the following:

- **Windows:** Access the Windows Desktop and right-click the  icon for your product in the right side of the Windows taskbar, or click the up arrow and right-click .
- **Mac:** In the Apple menu or the Dock, select **System Preferences**. Select **Print & Fax**, **Print & Scan**, or **Printers & Scanners**, select your product, and select **Options & Supplies**. Select **Utility** and select **Open Printer Utility**.

4. Select **Head Cleaning**.

You see a window like this:

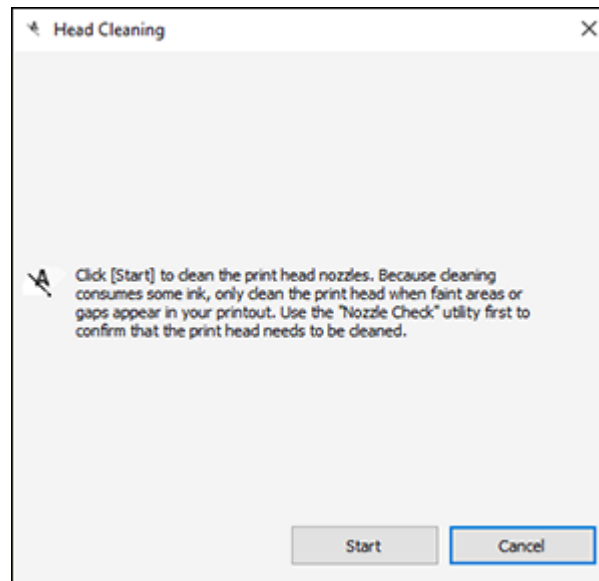

5. Click **Start** to begin the cleaning cycle.

The  power light flashes throughout the cleaning cycle and stays on when the cleaning cycle is finished.

Caution: Never turn off the product or open the front cover during a cleaning cycle or you may not be able to print.

- When the cleaning cycle is finished, you can check to see if the nozzles are clean; click **Print Nozzle Check Pattern** and click **Print**.
- Check the printed pattern to see if there are gaps in the lines.

Print head is clean



Print head needs cleaning



- If there are no gaps, click **Finish**.
- If there are gaps or the pattern is faint, click **Clean** to clean the print head again.

If you don't see any improvement after cleaning the print head up to 4 times, wait at least 6 hours without printing. Then try cleaning the print head again. If quality still does not improve, contact Epson.

Parent topic: [Print Head Cleaning](#)

Related tasks

[Loading Paper in the Cassette](#)

[Cleaning the Print Head Using the Product Control Panel](#)

Print Head Alignment

If your printouts become grainy or blurry, you notice misalignment of vertical lines, or you see dark or light horizontal bands, you may need to align the print head.

Note: Banding may also occur if your print head nozzles need cleaning.

[Aligning the Print Head Using the Product Control Panel](#)

Parent topic: [Adjusting Print Quality](#)

Related concepts

[Print Head Cleaning](#)

Aligning the Print Head Using the Product Control Panel

You can align the print head using the control panel on your product.

1. Make sure there are no errors on the LCD screen.
2. Load a few sheets of plain paper in the product.
3. Press the  home button, if necessary.
4. Select **Settings** > **Maintenance** > **Print Head Alignment**.
5. Select one of the following options:
 - **Ruled Line Alignment** if your printout is blurry.
 - **Horizontal Alignment** if your printout contains horizontal banding.
6. Follow the on-screen instructions to print an alignment sheet.

Note: Do not cancel printing while you are printing head alignment patterns.

7. Check the printed patterns on the alignment sheet and select the following on the LCD screen, depending on the alignment pattern you printed:
 - **Ruled Line Alignment:** Select the number representing the pattern with the least amount of separation or overlap.

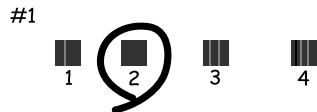

Select the number representing the pattern with the least misaligned vertical line.

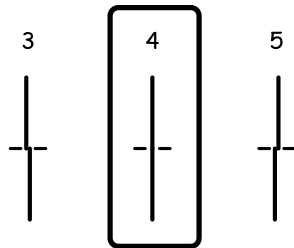

- **Horizontal Alignment:** Select the number representing the pattern with the least amount of separation or overlap.

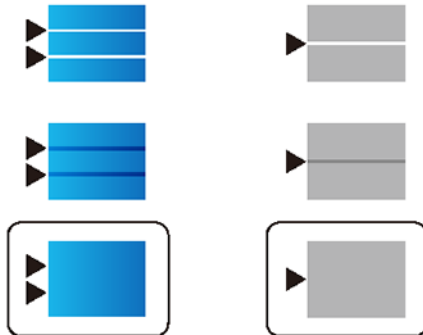

8. Select **Done**.

Parent topic: [Print Head Alignment](#)

Related tasks

[Loading Paper in the Cassette](#)

Cleaning the Paper Guide

If you see ink on the back of a printout, you can clean the paper guide rollers to remove any excess ink.

1. If printouts are smeared or scuffed, load plain paper in the paper source that you want to clean in one of these sizes: Letter (8.5 × 11 inches [216 × 279 mm]) or A4 (8.3 × 11.7 inches [210 × 297 mm]).

2. Press the  home button, if necessary.
3. Select **Settings** > **Maintenance** > **Paper Guide Cleaning**.
4. Select the paper source you want to clean.
5. Follow the on-screen instructions to clean the paper guide.
6. Repeat these steps as necessary until the paper comes out clean.

Note: If the paper is still smeared or scuffed, repeat these steps to clean the other paper sources.

Parent topic: [Adjusting Print Quality](#)

Related topics

[Loading Paper](#)

Cleaning and Transporting Your Product

See these sections if you need to clean or transport your product.

[Cleaning Your Product](#)

[Transporting Your Product](#)

Cleaning Your Product

To keep your product working at its best, you should clean it several times a year.

Caution: Do not use a hard brush, benzene, alcohol, or paint thinner to clean the product or you may damage it. Do not use oil or other lubricants inside the product or let water get inside it. Close the rear paper feed slot when you are not using it, to keep out dust.

1. Turn off the product.
2. Wait for the ⏻ power light to turn off, then unplug the power cable.
3. Disconnect any connected cables.
4. Remove all the paper from the product.
5. Clean the outer case and control panel with a soft, dry cloth. Do not use liquid or chemical cleansers.
6. Clean any paper cassettes using a soft brush.

7. Clean the scanner glass and the glass area on the left with a soft, lint-free cloth (microfiber is recommended), moistened with a little glass cleaner.

Caution: Do not spray glass cleaner directly on the glass and do not press the glass surface with any force.

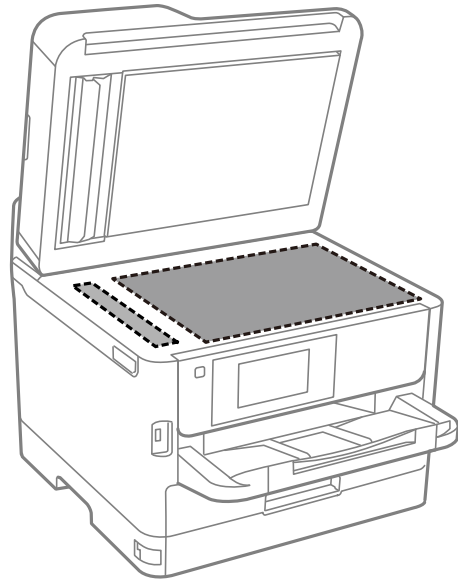

Note: If lines appear on the printout or in scanned images, carefully clean the scanner glass on the left.

8. Open the ADF cover.

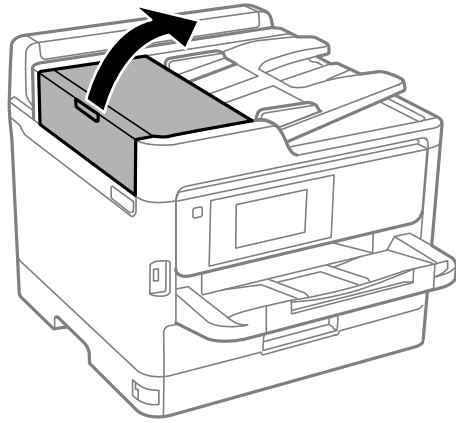

9. Use a soft, dry, lint-free cloth (microfiber is recommended) to clean the rollers and the interior of the ADF.

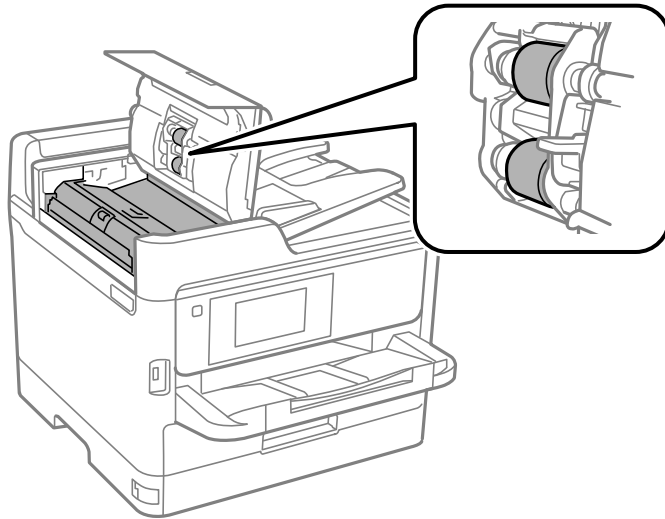

Parent topic: [Cleaning and Transporting Your Product](#)

Transporting Your Product

If you need to store your product or transport it a long distance, prepare it for transportation as described here.

Caution: During transportation and storage, follow these guidelines:

- Because the product is heavy, two or more people should lift and carry it using the hand positions shown here:

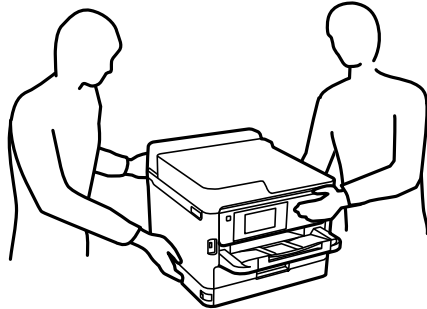

- Avoid tilting the product, placing it vertically, or turning it upside down; otherwise ink may leak.
- Leave the ink packs installed. Removing the packs can dry out the print head and may prevent the product from printing.

Note: Before storing your product for a long period, replace low, expended, or expired ink to help prevent the print head from drying out. Store your product in a cool, dry place.

1. Turn off the product.
2. Wait for the  power light to turn off, then unplug the power cable.
3. Disconnect any connected cables.
4. Remove all the paper from the product and make sure there are no originals on the scanner glass.
5. Lift up the scanner unit.
6. Make sure the print head is in the home position on the right.

7. Secure the print head to the case with tape as shown.

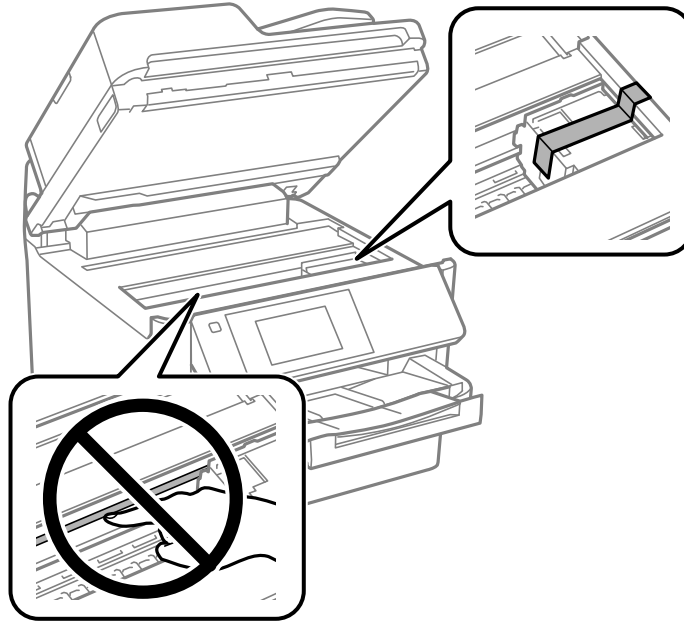

Caution: Do not touch the translucent film inside the product; otherwise, you may damage your product.

8. Lower the scanner unit.

9. Uninstall the optional paper cassette, if necessary.

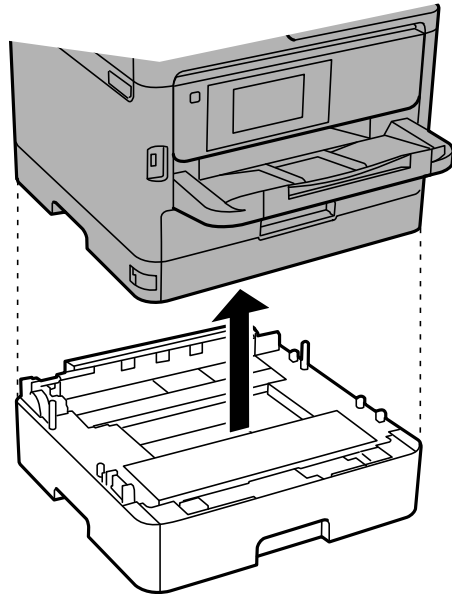

10. Close the rear paper feed slot and output tray and lower the control panel.

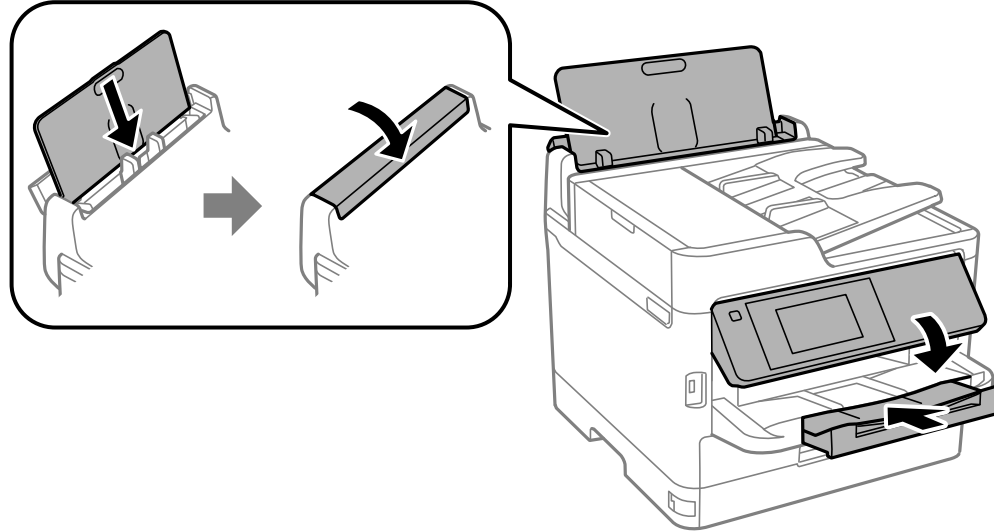

11. Remove the output tray.

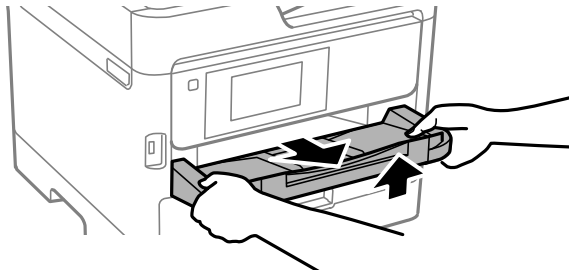

12. Place the product in its original packing materials, if possible, or use equivalent materials with cushioning around the product.

Keep the product level during transportation. If print quality has declined when you print again, clean and align the print head. Make sure you remove the tape securing the print head before using the printer.

Parent topic: [Cleaning and Transporting Your Product](#)

Related concepts

[Print Head Cleaning](#)

[Print Head Alignment](#)

Solving Problems

Check these sections for solutions to problems you may have using your product.

[Checking for Software Updates](#)

[Product Status Messages](#)

[Job Status Error Codes](#)

[Running a Product Check](#)

[Resetting Control Panel Defaults](#)

[Solving Setup Problems](#)

[Solving Network Problems](#)

[Solving Copying Problems](#)

[Solving Paper Problems](#)

[Solving Problems Printing from a Computer](#)

[Solving PostScript Printing Problems](#)

[Solving Page Layout and Content Problems](#)

[Solving Print Quality Problems](#)

[Solving Scanning Problems](#)

[Solving Scanned Image Quality Problems](#)

[Solving Faxing Problems](#)

[Solving USB Device Problems](#)



[Uninstall Your Product Software](#)

[Where to Get Help](#)

Checking for Software Updates

Periodically, it's a good idea to check Epson's support website for free updates to your product software. Visit epson.com/support (U.S.), epson.ca/support (Canada), or epson.com.jm/support (Caribbean) and select your product.

Note: Epson periodically provides firmware updates to address issues of security, performance, minor bug fixes and ensure your printer functions as designed. Your printer was designed to work only with genuine Epson ink packs, therefore some updates may affect the functionality of third-party ink.

- **Windows:** Your printer software automatically checks for updates. You can also manually update the software by selecting **Software Update** here:
 - Access the Windows Desktop and right-clicking the  icon for your product in the right side of the Windows taskbar, or clicking the up arrow and right-clicking .
 - On the **Maintenance** tab in the printer settings window

You can also update the software by selecting **EPSON Software Updater** in the **EPSON** or **EPSON Software** program group, accessible by the **Start** button, or on the **Start** or **Apps** screens, depending on your version of Windows.
- **OS X:** You can manually update the software by opening the **Applications > Epson Software** folder and selecting **EPSON Software Updater**.
- **macOS 10.12.x or 10.13.x:** You can manually update the software by opening the **App Store**, selecting **Updates**, searching for a software update option for Epson Software, and selecting **Update**.

Parent topic: [Solving Problems](#)

Product Status Messages

You can often diagnose problems with your product by checking the messages and status icons on its LCD screen. You can also check for errors by pressing the  **Job/Status** button and selecting **Printer Status**.

Note: If the LCD screen is dark, press the screen to wake the product from sleep mode.

LCD screen message	Condition/solution
Printer error. Turn the power off and on again. If the problem persists, contact Epson Support.	<p>Turn the product off and then back on again. If the error persists, check for and remove any jammed paper or protective materials from the product. If the error still persists, contact Epson for support.</p> <p>If you see any of the following error codes, make sure you have not exceeded the loading capacity for any paper source:</p> <ul style="list-style-type: none"> • 000181 • 000184
Printer error. Contact Epson Support. Non-printing features are available.	The product may be damaged, but features such as scanning are still available. Contact Epson for support.

LCD screen message	Condition/solution
Printer error. For details, see your documentation.	The product may be damaged. Contact Epson for support.
Paper out in XX. Load paper. Paper Size: XX/Paper Type: XX	Load the size and type of paper in the indicated paper source .
Too many paper cassette units are installed. Turn the power off and uninstall the extra units. See your documentation for details.	You can install one optional paper cassette unit. Remove any extra units.
Unsupported Paper Cassette Units have been installed. Turn the power off and uninstall. For details, see your documentation.	
Cannot print because XX is out of order. You can print from another cassette.	Turn the product off and then back on again. Reinsert the indicated paper cassette. If the error persists, contact Epson for support.
You need to replace Ink Supply Unit(s).	Replace the indicated ink packs.
Paper Configuration is set to Off. Some features may not be available. For details, see your documentation.	AirPrint is not available when the Paper Setup Auto Display setting is turned off. Change the Paper Setup Auto Display setting to On .
No dial tone detected.	Make sure the phone cable is connected correctly and the phone line works. If you connected the product to a PBX (Private Branch Exchange) phone line or Terminal Adapter, change the Line Type setting to PBX . Use a # (hash) instead of the actual access code when entering an outside fax number. This makes the connection more secure. If you still cannot send a fax, turn off the Dial Tone Detection setting. (Turning off the Dial Tone Detection setting may cause the product to drop the first digit of a fax number.)
Failed to receive faxes because the fax data capacity is full. Touch the Job/Status at the bottom of the Home Screen for details.	Press the  Job/Status button, select Printer Status , and resolve any printer errors that prevented faxes from printing. Make sure the product is connected to a computer or that an external USB device is connected to the product.

LCD screen message	Condition/solution
The combination of the IP address and the subnet mask is invalid. See your documentation for more details.	Contact your product administrator.
To use cloud services, update the root certificate from the Epson Web Config utility.	Contact your product administrator.
Check that the printer driver is installed on the computer and that the port settings for the printer are correct.	On a Windows computer, go to Control Panel > Hardware and Sound > Devices and Printers . Right-click the printer and select Printer Properties . Make sure the printer port is selected correctly in the Ports tab. Select the USBXXX setting for a USB connection or EpsonNet Print Port for a network connection.
Recovery mode	Contact your product administrator.

Parent topic: [Solving Problems](#)

Related references

[Paper Jams Inside the Product](#)

[Paper Source Settings Options](#)

[Where to Get Help](#)

Related tasks

[Removing and Installing Ink Packs](#)

[Connecting a Telephone or Answering Machine](#)

Related topics

[Wi-Fi or Wired Networking](#)

Job Status Error Codes

If a job does not complete successfully, you can check the error code for the reason. Press the  **Job/Status** button, select **Job Status > Log**, and select the incomplete job to display the error code and additional information.

Code	Condition/solution
001	The product was turned off by a power failure.
101	Memory is full. Reduce the size of the print job.

Code	Condition/solution
102	Collated printing has failed due to a lack of available memory. Clear fonts and macros from the product's memory using the PDL Font > Macro option from the Settings > General Settings > System Administration > Clear Internal Memory Data list, reduce the size of the print job, or print one copy at a time.
103	Print quality was decreased due to a lack of available memory. If the quality of the printout is unacceptable, try simplifying the page by reducing the number of graphics or the number and size of the fonts.
104	Reverse printing has failed due to a lack of available memory. Clear fonts and macros from the product's memory using the PDL Font > Macro option from the Settings > General Settings > System Administration > Clear Internal Memory Data list or reduce the data size of the print job.
106	Cannot print from the computer due to access control settings. Contact your product administrator.
107	User authentication failed and the job has been canceled. Make sure the user name and password are correct. If you still cannot print, select Settings > General Settings > System Administration > Security Settings > Access Control . Enable the user restriction function and allow the job without authentication information.
108	Confidential job data was deleted when the product was turned off.
109	The received fax was already deleted.
110	The job was printed 1-sided because the loaded paper does not support 2-sided printing. If you want to print on both sides, load paper that supports 2-sided printing.
111	Available memory is running low. Reduce the size of the print job.
120	Cannot communicate with a server using an open platform. Check the server or network for errors.
201	The product's memory is full. You can send pages individually, or print received faxes and delete them to free up memory space. If you are sending a monochrome fax to a single destination, you can send it by using Direct Send .
202	The line was disconnected by the recipient's fax machine. Wait a moment, then try again.

Code	Condition/solution
203	The product cannot detect a dial tone. Make sure the phone cable is connected correctly and the phone line works. If you connected the product to a PBX (Private Branch Exchange) phone line or Terminal Adapter, change the Line Type setting to PBX . If you still cannot send a fax, turn off the Dial Tone Detection setting. (Turning off the Dial Tone Detection setting may cause the product to drop the first digit of a fax number.)
204	The recipient's fax machine is busy. Wait a moment, then try again.
205	The recipient's fax machine does not answer. Wait a moment, then try again.
206	The phone cable is incorrectly connected to the product's LINE and EXT ports. Connect the phone cable correctly.
207	The phone cable is not connected. Connect the phone cable.
208	The fax could not be sent to some of the specified recipients. Print a fax log to check which recipients failed to receive the fax. If the Save Failure Data setting is turned on, you can resend a fax from Job Status in the Job/Status menu.
301 401	There is not enough storage space available to save the data in the external memory device. Clear space on the device, reduce the number of documents, reduce the size of the scanned image, or use a different device.
302 402	The external USB memory device is write-protected. Disable write protection.
303	No folder is available for saving the scanned file. Create a folder or use a different USB memory device.
304 404	The external USB memory device has been removed. Reinsert the device.
305	An error occurred while saving data to an external memory device. If the device is accessed from a computer, wait a moment, then try again.
306	The product's memory is full. Wait until current jobs are finished processing.
311 321 411 421	A DNS error has occurred. Check the DNS settings for the server, computer, or access point in the Settings > General Settings > Network Settings > Advanced > TCP/IP menu. If the problem cannot be cleared, contact your product administrator.

Code	Condition/solution
312 412	An authentication error has occurred. Check the authentication settings in the Settings > General Settings > Scan Settings > Email Server > Server Settings menu. If the problem cannot be cleared, contact your product administrator.
313 413	A communication error has occurred. Check the network connection or the authentication settings in the Settings > General Settings > Scan Settings > Email Server > Server Settings menu. The authentication method of the settings and the email server may not match. When you select Off as the authentication method, make sure the authentication method of the email server is set to None . If the problem cannot be cleared, contact your product administrator.
314	The data size exceeds the maximum size for the attached files. Increase the Attached File Max Size setting in the Scan Settings menu on your product or lower the file size of the scanned image.
315 327	The memory is full. Retry after other ongoing jobs have finished.
322	An authentication error occurred. Check the Location settings in your scan destination or contact.
323	A communication error has occurred. Check the Location settings in your scan destination or contact, or check the network connection.
324	A file with the same name already exists in the specified folder. Delete the duplicate file or change the file name prefix in the Scan Settings > File Settings menu.
325 326	There is not enough storage space available in the specified folder. Increase the storage space in the specified folder, delete unnecessary files, or lower the file size of the scanned image.
328	The destination was wrong or the destination does not exist. Check the Location settings in your scan destination or contact.
331	A communication error occurred. Make sure the product is connected to the network correctly.
332	There is not enough space available for saving the scanned files in the specified folder. Delete unnecessary files from the specified folder.
333	The destination could not be found because the destination information was uploaded to the server before sending the scanned data. Select the destination again.
334	An error occurred while sending the scanned data.

Code	Condition/solution
341	A communication error has occurred. Make sure the product is connected to the computer or network correctly. Make sure you have installed Document Capture or Document Capture Pro. If the problem cannot be cleared, contact your product administrator.
405	An error occurred while saving data to an external USB memory device. Reinsert the USB memory device or use a different USB memory device on which you created a folder using the Create a folder to save fax data setting.
422	An authentication error has occurred. Make sure the settings are correct for the folder selected in Settings > General Settings > Fax Settings > Receive Settings > Save/Forward Settings .
423	A communication error has occurred. Check the network connection, or make sure the settings are correct for the folder selected in Settings > General Settings > Fax Settings > Receive Settings > Save/Forward Settings . If the problem cannot be cleared, contact your product administrator.
425	There is not enough storage space available in the forwarding destination folder. Increase the storage space in the destination folder.
428	The destination was wrong or the destination does not exist. Make sure the settings are correct for the folder selected in Settings > General Settings > Fax Settings > Receive Settings > Save/Forward Settings .

Parent topic: [Solving Problems](#)

Related concepts

[Scan Resolution Guidelines](#)

Related tasks

[Connecting a Telephone or Answering Machine](#)

[Printing a Network Status Sheet](#)

Related topics

[Wi-Fi or Wired Networking](#)

[Sending Faxes](#)

Running a Product Check

Running a product check helps you determine if your product is operating properly.

1. Disconnect any interface cables connected to your product.
2. Load plain paper in the paper cassette.
3. Press the  home button, if necessary.
4. Select **Settings**.
5. Select **Maintenance**.

You see a screen like this:

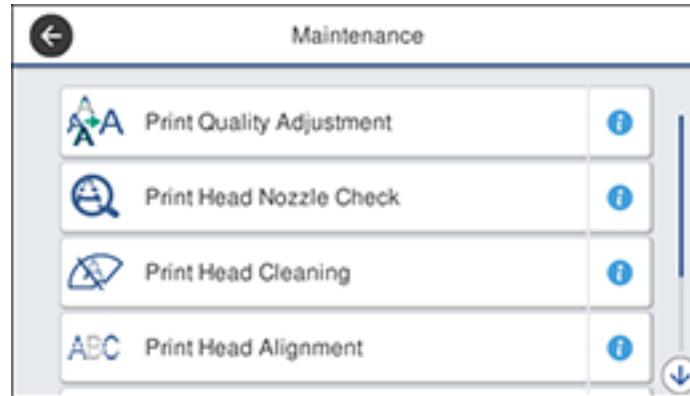

6. Select **Print Head Nozzle Check**.

You see a screen like this:



7. Select **Start**.
The nozzle pattern prints.
8. Do one of the following, depending on the results of the product check:
 - If the page prints and the nozzle check pattern is complete, the product is operating properly. Any operation problem you may have could be caused by your computer, cable, software, or selected settings. Check the other solutions in this guide or try uninstalling and reinstalling your printer software.
 - If the page prints but the nozzle check pattern has gaps, clean the print head.
 - If the page does not print, the product may have a problem. Check the other solutions in this manual. If they do not work, contact Epson.

Parent topic: [Solving Problems](#)

Related concepts

[Print Head Cleaning](#)

[Uninstall Your Product Software](#)

Related references

[Where to Get Help](#)

Resetting Control Panel Defaults

If you have a problem with settings on the product control panel, you can reset them to their factory defaults. You can choose which settings to reset or reset them all.

Note: This setting can be locked by an administrator. If you cannot access or change this setting, contact your administrator for assistance.

1. Press the  home button, if necessary.
2. Select **Settings** > **General Settings** > **System Administration**. Enter the administrator password, if necessary.
3. Scroll down and select **Restore Default Settings**.

You see a screen like this:



4. Select one of these options:
 - **Network Settings:** Resets all network settings
 - **Copy Settings:** Resets all settings for copying
 - **Scan Settings:** Resets all settings for scanning
 - **Fax Settings:** Resets all settings for faxing
 - **Clear All Data and Settings:** Resets all control panel settings including the contacts listYou see a confirmation screen.
5. Select **Yes** to reset the selected settings. (Select **No** if you want to cancel the operation.)

Parent topic: [Solving Problems](#)

Solving Setup Problems

Check these sections if you have problems while setting up your product.

[Product Does Not Turn On or Off](#)

[Noise After Ink Installation](#)

[Software Installation Problems](#)

Parent topic: [Solving Problems](#)

Product Does Not Turn On or Off

If you cannot turn the product on or off, try these solutions:

- If you cannot turn on your product, make sure the power cord is securely connected and hold down the power button a little longer.
- If you cannot turn off your product, hold down the power button a little longer. If you still cannot turn off your product, unplug the power cord, plug the power cord back in, then turn your product on and off again using the power button.

Parent topic: [Solving Setup Problems](#)

Noise After Ink Installation

If you hear noises from your product after installing ink, check the following:

- The first time you install the ink packs, the product must charge its print head. Wait until charging finishes before you turn off the product, or it may charge improperly and use excess ink the next time you turn it on.
- If the product's print head stops moving or making noise, and the charging process has not finished after approximately 5 minutes, turn off your product. Turn it back on and check to see if charging is still in progress. If it is still in progress, contact Epson for help.

Parent topic: [Solving Setup Problems](#)

Related tasks

[Removing and Installing Ink Packs](#)

Software Installation Problems

If you have problems while installing your product software, try these solutions:

- Make sure your product is turned on and any necessary cables are securely connected at both ends. If you still have problems installing software, disconnect the cable and carefully follow the instructions on the *Start Here* sheet. Also make sure your system meets the requirements for your operating system.
- Close any other programs, including screen savers and virus protection software, and install your product software again.
- In Windows, make sure your product is selected as the default printer and the correct port is shown in the printer properties.
- If you see any error message or your software does not install correctly in Windows, you may not have software installation privileges. Contact your system administrator.
- If you are printing over a network, make sure your product is set up properly on the network.

Parent topic: [Solving Setup Problems](#)

Related concepts

[Uninstall Your Product Software](#)

Related references

[Windows System Requirements](#)

[Mac System Requirements](#)

Solving Network Problems

Check these solutions if you have problems setting up or using your product on a network.

Note: Breakdown or repair of this product may cause loss of fax and network data and settings. Epson is not responsible for backing up or recovering data and settings during or after the warranty period. We recommend that you make your own backup or print out your fax and network data and settings.

[Product Cannot Connect to a Wireless Router or Access Point](#)

[Network Software Cannot Find Product on a Network](#)

[Product Does Not Appear in Mac Printer Window](#)

[Cannot Print Over a Network](#)

[Cannot Scan Over a Network](#)

Parent topic: [Solving Problems](#)

Product Cannot Connect to a Wireless Router or Access Point

If your product has trouble finding or connecting to a wireless router or access point, try these solutions:

- If you are connecting the product via Wi-Fi Protected Setup (WPS) and the Wi-Fi icon on your product's LCD screen is not lit or does not appear, make sure you select one of the WPS options from the product control panel within 2 minutes of pressing the WPS button on your router.
- Make sure to place your product within contact range of your 2.4 GHz router or access point. Avoid placing your product near a microwave oven, 2.4 GHz cordless phone, or large metal object, such as a filing cabinet.

Note: If you are using a 5 GHz wireless router, set the router to operate in dual band (2.4 GHz and 5 GHz) mode. If your router uses a single network name (SSID) for both the 2.4 GHz and 5 GHz band, give each band its own network name (SSID) instead, such as Home Network 2.4 GHz and Home Network 5 GHz. See your router documentation or contact your internet service provider for instructions.

- Verify that your router or access point is operating correctly by connecting to it from your computer or another device.
- You may need to disable the firewall and any anti-virus software on your wireless router or access point.
- Check to see if access restrictions, such as MAC address filtering, are set on the router or access point. If access restrictions are set, add your product's MAC address to your router's address list. To obtain your product's MAC address, print a network status sheet. Then follow the instructions in your router or access point documentation to add the address to the list.
- If your router or access point does not broadcast its network name (SSID), follow the instructions that came with your product to enter your wireless network name manually.
- If your router or access point has security enabled, determine the kind of security it is using and any required password or passphrase for connection. Then make sure to enter the exact WEP key or WPA passphrase correctly.
- Check if your computer is restricting the available wireless channels. If so, verify that your wireless access point is using one of the usable channels and change to a usable channel, if necessary.
- If you are using a Wi-Fi Direct connection that suddenly disconnects, the Wi-Fi direct password on your device may have been changed. If necessary, delete the existing **DIRECT-xxxxxxx** connection settings from your device and enter a new password. See your device documentation for instructions.
- If you connected your product to a Windows computer using Wi-Fi Direct and it automatically selected Access Point Mode, you may have trouble accessing a low-priority Internet connection. Check the network connection or adapter settings in the Windows Control Panel and set the **Internet metric** setting to **100** for your version of the Internet Protocol.

Parent topic: [Solving Network Problems](#)

Related concepts

[Wi-Fi Direct Mode Setup](#)

Related tasks

[Selecting Wireless Network Settings from the Control Panel](#)

[Printing a Network Status Sheet](#)

Related topics

[Wi-Fi or Wired Networking](#)

Network Software Cannot Find Product on a Network

If EpsonNet Setup cannot find your product on a network, try these solutions:

- Make sure your product is turned on and connected to your network. Verify connection using your product control panel.
- Check if your network name (SSID) contains non-ASCII characters. Your product cannot display non-ASCII characters.
- Make sure your product is not connected to a guest network.
- If necessary, reinstall your product software and try running EpsonNet Setup again:
 1. Reset your product's network settings to their factory defaults.
 2. **Windows only:** Uninstall your product software.
 3. Initialize your router following the instructions in your router documentation.

Note: If you are reading these instructions online, you will lose your Internet connection when you initialize your router, so note the next step before initializing it.

4. Download your product software from the Epson website using the instructions on the *Start Here* sheet.
- If you have replaced your router, reinstall your product software to connect to the new router.

Note: If you are using a 5 GHz wireless router, set the router to operate in dual band (2.4 GHz and 5 GHz) mode. If your router uses a single network name (SSID) for both the 2.4 GHz and 5 GHz band, give each band its own network name (SSID) instead, such as Home Network 2.4 GHz and Home Network 5 GHz. See your router documentation or contact your internet service provider for instructions.

- Check to see if your wireless router or access point has an enabled Privacy Separator function that is preventing detection of your device over the network. See your router or access point documentation for instructions on disabling the Privacy Separator function.

Parent topic: [Solving Network Problems](#)

Related concepts

[Uninstall Your Product Software](#)

[Wi-Fi Direct Mode Setup](#)

Product Does Not Appear in Mac Printer Window

If your product does not appear in the Mac printer window, try these solutions:

- Turn your product off, wait 30 seconds, then turn it back on again.
- If you are connecting the product via Wi-Fi Protected Setup (WPS) and the Wi-Fi icon on your product's LCD screen is not lit, make sure you select one of the WPS options from the product control panel within 2 minutes of pressing the WPS button on your router.
- If you are connecting the product wirelessly via EpsonNet Setup and you do not see the Wi-Fi antenna icon with connection bars on your LCD screen, make sure your product software was installed correctly. If necessary, reinstall your software.

Note: If you are using a 5 GHz wireless router, set the router to operate in dual band (2.4 GHz and 5 GHz) mode. If your router uses a single network name (SSID) for both the 2.4 GHz and 5 GHz band, give each band its own network name (SSID) instead, such as Home Network 2.4 GHz and Home Network 5 GHz. See your router documentation or contact your internet service provider for instructions.

Parent topic: [Solving Network Problems](#)

Related concepts

[Uninstall Your Product Software](#)

Cannot Print Over a Network

If you cannot print over a network, try these solutions:

- Make sure that your product is turned on.
- Make sure you install your product's network software as described in your product documentation.
- Print a network status sheet and verify that the network settings are correct. If the network status is **Disconnected**, check any cable connections and turn your product off and then on again.
- If you are using TCP/IP, make sure the product's IP address is set correctly for your network. If your network does not assign IP addresses using DHCP, set the IP address manually.
- Make sure your computer and product are both using the same wireless network.
- If network printing is slow, print a network status sheet and check the signal strength. If it is poor, place your product closer to your router or access point. Avoid placing your product near a microwave oven, 2.4 GHz cordless phone, or large metal object, such as a filing cabinet.

Note: If you are using a 5 GHz wireless router, set the router to operate in dual band (2.4 GHz and 5 GHz) mode. See your router documentation for instructions.

- Check to see if your wireless router or access point has an enabled Privacy Separator function that is preventing printing from a device over the network. See your router or access point documentation for instructions on disabling the Privacy Separator function.
- If you are connecting the product via Wi-Fi Protected Setup (WPS) and the Wi-Fi icon does not appear on your product's LCD screen, make sure you select one of the WPS options from the product control panel within 2 minutes of pressing the WPS button on your router.
- Check your wired LAN router or access point to see if the LED for the port to which your product is connected is on or flashing. If the link LED is off, try the following:
 - Make sure the Ethernet cable is securely connected to your product and to your router, access point, switch, or hub.
 - Try connecting your product to a different port or a different router, access point, switch, or hub.
 - Try connecting with a different Ethernet cable.
 - Try printing to your product from another computer on the network.

Note: If you are using a 5 GHz wireless router, set the router to operate in dual band (2.4 GHz and 5 GHz) mode. See your router documentation for instructions.

- If you are connecting the product via EpsonNet Setup and the Wi-Fi icon does not appear lit on the LCD screen, make sure your product software was installed correctly. If necessary, reinstall your software.

Parent topic: [Solving Network Problems](#)

Related concepts

[Uninstall Your Product Software](#)

Related tasks

[Printing a Network Status Sheet](#)

Related topics

[Wi-Fi or Wired Networking](#)

Cannot Scan Over a Network

If you cannot start Epson Scan 2 for scanning over a network, try these solutions:

- If you cannot scan from your product control panel, make sure you restarted your computer after installing the product software. Make sure the Event Manager program is not being blocked by your firewall or security software.

Note: If you are using a 5 GHz wireless router, set the router to operate in dual band (2.4 GHz and 5 GHz) mode. If your router uses a single network name (SSID) for both the 2.4 GHz and 5 GHz band, give each band its own network name (SSID) instead, such as Home Network 2.4 GHz and Home Network 5 GHz. See your router documentation or contact your internet service provider for instructions.

- If you are scanning a large original at a high resolution, a network communication error may occur. Try scanning again at a lower resolution.
- If network communication was interrupted while starting Epson Scan 2, exit Epson Scan 2, wait a few seconds, and restart it. If Epson Scan 2 cannot restart, turn off your product, turn it back on, and try restarting Epson Scan 2 again.
- Check the scanner setting and reset the connection if necessary using Epson Scan 2 Utility:

Windows 10: Click  and select **EPSON > Epson Scan 2 Utility**. Make sure your product is selected. If necessary, select the **Other** tab and click **Reset**.

Windows 8.x: Navigate to the **Apps** screen, select **EPSON**, and select **Epson Scan 2 Utility**. Make sure your product is selected. If necessary, select the **Other** tab and click **Reset**.

Windows (other versions): Click  or **Start > All Programs** or **Programs > EPSON > Epson Scan 2 > Epson Scan 2 Utility**. Make sure your product is selected. If necessary, select the **Other** tab and click **Reset**.

Mac: Open the **Applications** folder, click **Epson Software**, and click **Epson Scan 2 Utility**. Make sure your product is selected. If necessary, select the **Other** tab and click **Reset**.

- You may need to disable the firewall and any anti-virus software on your wireless router or access point.

Parent topic: [Solving Network Problems](#)

Related tasks

[Starting a Scan Using the Product Control Panel](#)

[Starting a Scan Using the Epson Scan 2 Icon](#)

[Starting a Scan from a Scanning Program](#)

[Starting a Scan from a Smart Device](#)

Solving Copying Problems

Check these solutions if you have problems copying with your product.

[Product Makes Noise, But Nothing Copies](#)

[Product Makes Noise When It Sits for a While](#)
[Originals Do Not Feed From the Automatic Document Feeder](#)
Parent topic: [Solving Problems](#)

Product Makes Noise, But Nothing Copies

If your product makes a noise, but nothing copies, try these solutions:

- Run a nozzle check to see if any of the print head nozzles are clogged. Then clean the print head, if necessary.
- If the nozzle check page does not print, but the product's power is on, make sure your product software is installed correctly.
- Make sure your product is level (not tilted).

Parent topic: [Solving Copying Problems](#)

Related concepts

[Print Head Cleaning](#)

[Print Head Nozzle Check](#)

Product Makes Noise When It Sits for a While

Your product is performing routine maintenance. This is normal.

Parent topic: [Solving Copying Problems](#)

Originals Do Not Feed From the Automatic Document Feeder

If your originals do not feed when placed in the ADF, try these solutions:

- Make sure the **ADF** icon lights up on the Copy, Fax, or Scan screen on the LCD screen. If not, reload the originals.
- Make sure the size, weight, and number of your originals are supported by the ADF.
- Make sure the originals are loaded correctly.
- Make sure the document is not curled or creased.
- Try cleaning the inside of the ADF.

- Do not load originals above the arrow mark on the ADF edge guide.

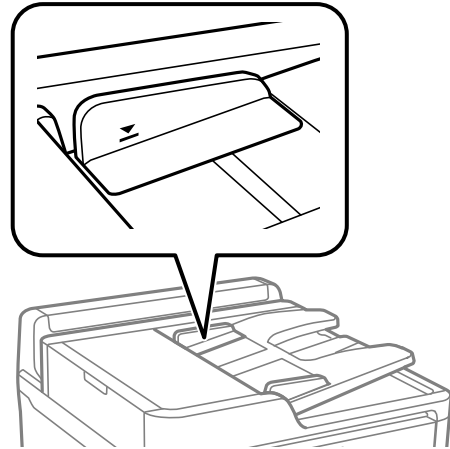

Parent topic: [Solving Copying Problems](#)

Related references

[Paper Feeding Problems](#)

[Paper Jams Inside the Product](#)

[Automatic Document Feeder \(ADF\) Specifications](#)

Related tasks

[Cleaning Your Product](#)

Solving Paper Problems

Check these sections if you have problems using paper with your product.

[Paper Feeding Problems](#)

[Paper Jams Inside the Product](#)

[Paper Ejection Problems](#)

Parent topic: [Solving Problems](#)

Paper Feeding Problems

If you have problems feeding paper, try these solutions:

- If paper does not feed for printing, remove it from the rear feed slot or cassette. Reload it, then adjust the edge guides. Make sure the paper stack is not above the tab on the edge guides inside the cassette or rear feed slot.
- Place the product on a flat surface and operate it in the recommended environmental conditions.
- Be sure to insert the paper cassette all the way into your product.
- If multiple pages feed at once, remove the paper, fan the edges to separate the sheets, and reload it.
- Do not load more than the recommended number of sheets.
- Make sure your paper meets the specifications for your product.
- If paper jams when you print on both sides of the paper, try loading fewer sheets.
- Make sure the paper size and paper type settings are correct for the paper source.
- If you installed an optional paper cassette unit, be sure to enable the cassette unit in the printing software.
- If your product pauses during printing, make sure the front cover is closed.
- For best results, follow these guidelines:
 - Use new, smooth, high-quality paper that is not curled, creased, old, too thin, or too thick.
 - Load paper in the cassette printable side down.
 - Do not load binder paper with holes in the cassette.
 - Follow any special loading instructions that came with the paper.

Parent topic: [Solving Paper Problems](#)

Paper Jams Inside the Product

If you see a message that paper has jammed in the product, follow the on-screen instructions to locate and remove the jammed paper.

Take the following precautions when removing jammed paper from the product:

- Remove the jammed paper carefully. Using too much force may damage the product.
- Unless specifically instructed, avoid tilting the product, placing it on its side, or turning it upside down, as ink may spill.

Warning: Never touch the buttons on the control panel while your hand is inside the product. If the product starts operating, it may cause an injury. Do not touch any protruding parts inside the product.

Parent topic: [Solving Paper Problems](#)

Related references

[Paper Feeding Problems](#)

[Paper Loading Capacity](#)

Paper Ejection Problems

If you have problems with paper ejecting properly, try these solutions:

- If paper does not eject fully, you may have set the wrong paper size. Cancel printing to eject the paper. Select the correct paper size when you reprint.
- If paper is wrinkled when it ejects, it may be damp or too thin. Load new paper and be sure to select the correct paper type setting when you reprint.

Parent topic: [Solving Paper Problems](#)

Related references

[Paper Jams Inside the Product](#)

[Paper Type Settings - Control Panel](#)

Related topics

[Loading Paper](#)

Solving Problems Printing from a Computer

Check these sections if you have problems while printing from your computer.

Note: When printing using AirPrint, the available print settings are different from those covered in this manual. See the Apple website for details.

Note: For problems while printing with the Epson Universal Print Driver or PostScript (PS3) printer software, see the sections covering that software in this manual.

[Nothing Prints](#)

[Product Icon Does Not Appear in Windows Taskbar](#)

[Printing is Slow](#)

Parent topic: [Solving Problems](#)

Nothing Prints

If you have sent a print job and nothing prints, try these solutions:

- Make sure your product is turned on and connected to your computer.
- Make sure any interface cables are connected securely at both ends.
- If you connected your product to a USB hub, make sure it is a first-tier hub. If it still does not print, connect your product directly to your computer instead of the hub.
- Make sure the printer status is not offline or pending.
- Run a product check to see if a test page prints. If the test page prints, check to see if your product software is installed correctly.
- In Windows, make sure your product is selected as the default printer.
- In Windows, delete all jobs from the Windows Spooler. Click **Print Queue** on the Maintenance tab in the printer settings window, and cancel any stalled print jobs.
- On a Mac, make sure the printer is added to the printer list.
- On a Mac, make sure the printer is not paused.
- Make sure the **Printer Settings > Printing Language** setting is set to **Auto** or **PS3**.
- Make sure your product is selected as the printer in your printing program.
- In Windows, the product may not print if a large number of print jobs are sent. Try selecting **Print directly to the printer** on the Advanced tab in the printer properties.

Parent topic: [Solving Problems Printing from a Computer](#)



Related tasks



[Running a Product Check](#)

Product Icon Does Not Appear in Windows Taskbar

If you do not see your product icon in the Windows taskbar, first try restarting your computer. If that does not work, try this solution:

1. Do one of the following:

- **Windows 10:** Click  and select  (Settings) > **Devices > Printers & scanners**. Select your product name and select **Manage > Printing preferences**.
- **Windows 8.x:** Navigate to the **Apps** screen and select **Control Panel > Hardware and Sound > Devices and Printers**. Right-click your product name, select **Printing Preferences**, and select your product name again if necessary.

- **Windows 7:** Click  and select **Devices and Printers**. Right-click your product name, select **Printing Preferences**, and select your product name again if necessary.
 - **Windows Vista:** Click , select **Control Panel**, and click **Printer** under **Hardware and Sound**. Right-click your product name, select **Printing Preferences**, and select your product name again if necessary.
2. Click the **Maintenance** tab.
 3. Click the **Extended Settings** button.
 4. Select **Enable EPSON Status Monitor 3** and click **OK**.
 5. Click the **Monitoring Preferences** button.
 6. Click the checkbox for the option that adds the shortcut icon to the taskbar.
 7. Click **OK** to close the open program windows.

Parent topic: [Solving Problems Printing from a Computer](#)

Printing is Slow

If printing becomes slow, try these solutions:

- Make sure your system meets the requirements for your operating system. If you are printing a high-resolution image, you may need more than the minimum requirements. If necessary, increase your system's memory.
- If you are using Windows 7, close the **Devices and Printers** window before you print.
- Make sure **Quiet Mode** is turned off.
- Clear space on your hard drive or run a defragmentation utility to free up existing space.
- Close any programs you are not using when you print.
- If your product is connected to a USB hub, connect it directly to your computer instead.
- If printing becomes slower after printing continuously for a long time, the product may have automatically slowed down to protect the print mechanism from overheating or becoming damaged. Let the product rest with the power on for 30 minutes, then try printing again.
- If you are using the Windows PostScript printer software, try selecting **Fast** as the **Print Quality** setting on the Advanced tab of the printer software.

For the fastest printing, select the following settings in your product software:

- Make sure the paper type setting matches the type of paper you loaded.
- Turn on any high speed settings in your product software.

- Select a lower print quality setting.
- Make sure the ink drying time has not been increased for double-sided printing.
- **Windows:** Click the **Maintenance** or **Utility** tab, select **Extended Settings** or **Speed and Progress**, and select the following settings:
 - **Always Spool RAW Datatype**
 - **Page Rendering Mode**
 - **Print as Bitmap**
- **Windows:** Select **Printer Properties**, click the **More Options** tab, and make sure the **High Speed** setting is enabled.
- **Mac:** Select **System Preferences**, select **Printers & Scanners**, and select your product. Select **Options & Supplies**, select **Options** (or **Driver**), and enable the **High Speed Printing** setting.

If printing is still slow and you are using Windows 7 or Windows Vista, try the following:

1. Click  and select **Computer** or **My Computer**. Double-click the **C:** drive and open these folders: **ProgramData > EPSON > PRINTER**.

Note: If you do not see the ProgramData folder, open the **Organize** menu and select **Folder and search options**. In the window that appears, click the **View** tab, select **Show hidden files, folders, and drives** in the Advanced settings list, and click **OK**.

2. Right-click the **EPAUDF01.AUD** file and select **Delete**.
3. Restart your computer and try printing again.

Parent topic: [Solving Problems Printing from a Computer](#)

Related references

[Paper or Media Type Settings - Printing Software](#)

[Windows System Requirements](#)

[Mac System Requirements](#)

Related tasks

[Selecting Basic Print Settings - Windows](#)

[Selecting Double-sided Printing Settings - Windows](#)

[Selecting Extended Settings - Windows](#)

[Selecting Basic Print Settings - Mac](#)

Solving PostScript Printing Problems

Check these solutions if you have problems using the PostScript printing software.

[Nothing Prints Using the PostScript Printing Software](#)

[Documents Print Incorrectly Using the PostScript Printing Software](#)

[Accessing Printer Properties - PostScript - Windows](#)

Parent topic: [Solving Problems](#)

Nothing Prints Using the PostScript Printing Software

If your document doesn't print, try these solutions:

- Make sure your product is turned on and connected to your computer.
- Make sure the **Printer Settings > Printing Language** setting is set to **Auto** or **PS3**.
- Make sure your product is selected as the printer in your printing program.
- In Windows, the product may not print if a large number of print jobs are sent. Try selecting **Print directly to the printer** on the Advanced tab in the printer properties.

Parent topic: [Solving PostScript Printing Problems](#)

Related tasks

[Running a Product Check](#)

Documents Print Incorrectly Using the PostScript Printing Software

If your document does not print correctly, try these solutions:

- If the file you are printing was created in an application that allows you to change the data format, such as Adobe Photoshop, make sure the settings in the application match the printer software settings.
- EPS files created in binary format may not print correctly. Try creating the file in ASCII format instead.
- In Windows, the product cannot print binary data if it is connected to the computer using a USB cable. Try selecting **ASCII** or **TBCP** as the **Output Protocol** setting on the Device Settings tab in the printer properties.
- In Windows, select the appropriate substitution fonts on the Device Settings tab in the printer properties.
- In Windows, if the printed colors are incorrect, try adjusting the **Color Mode** setting on the Advanced tab of the printer software.





- In Windows, if printing is slow, try selecting **Fast** as the **Print Quality** setting on the Advanced tab of the printer software.

Parent topic: [Solving PostScript Printing Problems](#)

Accessing Printer Properties - PostScript - Windows

You can access the printer properties to view and change product settings for PostScript printing.

1. Do one of the following:

- **Windows 10:** Click  and select  (Settings) > **Devices** > **Printers & scanners**. Select your product name and select **Manage** > **Printer properties**.
- **Windows 8.x:** Navigate to the **Apps** screen and select **Control Panel** > **Hardware and Sound** > **Devices and Printers**. Right-click the postscript driver for your product, and select **Printer properties**.
- **Windows 7:** Click  and select **Devices and Printers**. Right-click the postscript driver for your product and select **Printer properties**.
- **Windows Vista:** Click  and select **Control Panel**. Click **Printer** under **Hardware and Sound**, then right-click the postscript driver for your product and select **Properties**.

2. Click any tab to view and change the printer property settings.

Parent topic: [Solving PostScript Printing Problems](#)

Solving Page Layout and Content Problems

Check these sections if you have problems with the layout or content of your printed pages.

Note: When printing using AirPrint, the available print settings are different from those covered in this manual. See the Apple website for details.

[Inverted Image](#)

[Too Many Copies Print](#)

[Blank Pages Print](#)

[Incorrect Margins on Printout](#)

[Incorrect Characters Print](#)

[Incorrect Image Size or Position](#)

[Slanted Printout](#)

Parent topic: [Solving Problems](#)

Inverted Image

If your printed image is inverted unexpectedly, try these solutions:

- Turn off any mirror or inversion settings in your printing application.
- Turn off the **Mirror Image**, **Flip horizontally**, or **Reverse page orientation** settings in your printer software. (This option has different names, depending on your operating system version.)

Parent topic: [Solving Page Layout and Content Problems](#)

Related tasks

[Selecting Basic Print Settings - Windows](#)

[Selecting Additional Layout and Print Options - Windows](#)

Too Many Copies Print

Make sure that the **Copies** setting in your printing program or printer software is not set for multiple copies.

Parent topic: [Solving Page Layout and Content Problems](#)

Related tasks

[Selecting Basic Print Settings - Windows](#)

[Selecting Basic Print Settings - Mac](#)

Blank Pages Print

If blank pages print unexpectedly, try these solutions:

- Make sure you selected the correct paper size settings in your printing program and printer software.
- If a blank page exists in a document you are printing and you want to skip printing it, select the **Skip Blank Page** setting in your printer software, if available.
- Run a print head nozzle check to see if any of the nozzles are clogged. Then clean the print head, if necessary.
- Make sure your product is selected as the printer in your printing program.

Parent topic: [Solving Page Layout and Content Problems](#)

Related concepts

[Print Head Cleaning](#)

[Print Head Nozzle Check](#)

Related tasks

[Selecting Basic Print Settings - Windows](#)

[Selecting Extended Settings - Windows](#)

[Selecting Basic Print Settings - Mac](#)

Incorrect Margins on Printout

If your printed page has incorrect margins, try these solutions:

- Make sure you selected the correct paper size settings in your printing program and printer software.
- Make sure you selected the correct margins for your paper size in your printing program.
- Make sure your paper is positioned correctly for feeding into the product.
- When placing originals on the scanner glass, align the corner of the original with the corner indicated by the arrow. If the edges of the copy are cropped, move the original slightly away from the corner.
- Clean the scanner glass and the document cover. If there is dust or stains on the glass, the copy area may extend to include the dust or stains.

You can use the preview option in your printer software to check your margins before you print.

Parent topic: [Solving Page Layout and Content Problems](#)

Related tasks

[Selecting Basic Print Settings - Windows](#)

[Selecting Basic Print Settings - Mac](#)

[Placing Originals on the Scanner Glass](#)

[Cleaning Your Product](#)

Related topics

[Loading Paper](#)

Incorrect Characters Print

If incorrect characters appear in your prints, try these solutions before reprinting:

- Make sure any cables are securely connected at both ends.
- In Windows, delete all jobs from the Windows Spooler. Click **Print Queue** on the Maintenance tab in the printer settings window, and cancel any stalled print jobs.
- If your product is connected to a USB hub, connect it directly to your computer instead.
- If your computer entered sleep mode the last time you printed, the next print job after your computer exits sleep mode may contain garbled characters. Print your document again.

- If incorrect characters still appear in your prints, try connecting your product using a different cable.
- **Windows or Mac:** Make sure you are using the printer software for this product. Check the product name at the top of the driver window.
- If you are using the PostScript printer software, EPS files created in binary format may not print correctly. Try creating the file in ASCII format instead.
- If you are using the Windows PostScript printer software, the product cannot print binary data if it is connected to the computer using a USB cable. Try selecting **ASCII** or **TBCP** as the **Output Protocol** setting on the Device Settings tab in the printer properties.
- If you are using the Windows PostScript printer software, select the appropriate substitution fonts on the Device Settings tab in the printer properties.

Parent topic: [Solving Page Layout and Content Problems](#)

Incorrect Image Size or Position

If your printed image is the wrong size or in the wrong position, try these solutions:

- Make sure you selected the correct paper size and layout settings in your printing program and printer software.
- Make sure you selected the correct paper size on the control panel.
- Make sure your paper is positioned correctly for feeding into the printer.
- Slide the edge guides against the edges of the paper.
- Clean the scanner glass and document cover.
- If the edges of a copy are cropped, slightly move the original away from the edges of the scanner glass.
- Be sure to select the correct **Original Size** setting for your original in the Copy settings.

You can use the preview option in your printer software to check your margins before you print.

Parent topic: [Solving Page Layout and Content Problems](#)

Related tasks

[Selecting Basic Print Settings - Windows](#)

[Selecting Additional Layout and Print Options - Windows](#)

[Selecting Basic Print Settings - Mac](#)

[Selecting Page Setup Settings - Mac](#)

Slanted Printout

If your printouts are slanted, try these solutions:

- Slide the edge guides against the edges of the paper.
- Select a higher print quality setting in your printer software.
- Turn off any high speed settings in your product software.
- Align the print head.
- Adjust the print quality.
- Make sure the product is not printing while tilted or at an angle.

Parent topic: [Solving Page Layout and Content Problems](#)

Related tasks

[Selecting Basic Print Settings - Windows](#)

[Selecting Basic Print Settings - Mac](#)

Related topics

[Loading Paper](#)

Solving Print Quality Problems

Check these sections if your printouts have problems with print quality, but your image looks fine on your computer screen.

Note: When printing using AirPrint, the available print settings are different from those covered in this manual. See the Apple website for details.

[White or Dark Lines in Printout](#)

[Blurry or Smearred Printout](#)

[Faint Printout or Printout Has Gaps](#)

[Grainy Printout](#)

[Incorrect Colors](#)

Parent topic: [Solving Problems](#)

White or Dark Lines in Printout

If you notice white or dark lines in your prints (also called banding), try these solutions before you reprint:

- Run a nozzle check to see if any of the print head nozzles are clogged. Then clean the print head, if necessary.
- Make sure the paper type setting matches the type of paper you loaded.
- Make sure you loaded the printable side of the paper correctly for your product.
- Turn off any high speed settings in your product software.
- Align the print head.
- Adjust the print quality in the product software.
- You may need to replace an ink pack.

Parent topic: [Solving Print Quality Problems](#)

Related concepts

[Print Head Alignment](#)

[Print Head Cleaning](#)

[Print Head Nozzle Check](#)

Related references

[Paper or Media Type Settings - Printing Software](#)

Related tasks

[Selecting Additional Layout and Print Options - Windows](#)

[Selecting Printing Preferences - Mac](#)

[Removing and Installing Ink Packs](#)

Related topics

[Loading Paper](#)

Blurry or Smearred Printout

If your printouts are blurry or smearred, try these solutions:

- Make sure your paper is not damp, curled, old, or loaded incorrectly in your product.
- Slide the edge guides to the edges of the paper.
- Use a support sheet with special paper, or load special paper one sheet at a time.
- Make sure your paper meets the specifications for your product.

- Use Epson papers to ensure proper saturation and absorption of genuine Epson inks.
- Make sure the paper type setting in your product software matches the type of paper you loaded.
- Make sure you loaded the printable side of the paper correctly for your product.
- If you are printing on thick paper or envelopes, turn on the **Thick Paper** setting from the control panel or select **Thick Paper and Envelopes** in the Extended Settings of the printer software. (Turning this setting on will decrease print speed.)
- If you are printing on thick paper, select a thick paper **Paper Type** setting on the control panel.
- Remove each sheet from the output tray as it is printed.
- Avoid handling printouts on glossy paper right after printing to allow the ink to set.
- Turn off any high speed settings in your product software.
- If you print on both sides of a sheet of paper, smudges may appear on the reverse side of heavily saturated or dark images. If one side of a sheet will contain a lighter image or text, print that side first. Make sure the ink has dried before reloading the paper to print on the other side. Adjust the density and/or ink drying time settings.
- If printed copies are smeared, lower the copy density setting on the product control panel.
- Run a nozzle check to see if any of the print head nozzles are clogged. Then clean the print head, if necessary.
- Align the print head.
- Adjust the print quality in the product software.
- Clean the paper path.
- Do not press too hard on the original or the document cover when you are scanning originals on the scanner glass.
- Clean the scanner glass.
- Clean the ADF.

Note: Your product will not operate properly while tilted at an angle. Place it on a flat, stable surface that extends beyond the base of the product in all directions.

Parent topic: [Solving Print Quality Problems](#)

Related concepts

[Print Head Alignment](#)

[Print Head Cleaning](#)

Related references

[Compatible Epson Papers
Paper Specifications](#)

Related tasks

[Cleaning the Paper Guide](#)
[Selecting Basic Print Settings - Windows](#)
[Selecting Double-sided Printing Settings - Windows](#)
[Selecting Additional Layout and Print Options - Windows](#)
[Selecting Basic Print Settings - Mac](#)
[Selecting Printing Preferences - Mac](#)

Related topics

[Loading Paper](#)

Faint Printout or Printout Has Gaps

If your printouts are faint or have gaps, try these solutions:

- Run a nozzle check to see if any of the print head nozzles are clogged. Then clean the print head, if necessary.
- The ink packs may be old or low on ink, and you may need to replace them.
- Make sure the paper type setting matches the type of paper you loaded.
- Make sure your paper is not damp, curled, old, or loaded incorrectly in your product.
- Align the print head.
- Adjust the print quality in the product software.
- Clean the paper path.

Parent topic: [Solving Print Quality Problems](#)

Related concepts

[Print Head Alignment](#)
[Print Head Cleaning](#)
[Print Head Nozzle Check](#)

Related references

[Paper or Media Type Settings - Printing Software](#)

Related tasks

- [Cleaning the Paper Guide](#)
- [Selecting Basic Print Settings - Windows](#)
- [Selecting Basic Print Settings - Mac](#)
- [Removing and Installing Ink Packs](#)

Related topics

- [Loading Paper](#)

Grainy Printout

If your printouts are grainy, try these solutions:

- Make sure you loaded the printable side of the paper correctly for your product.
- Select a higher print quality setting and turn off any high speed settings in your product software.
- Run a nozzle check to see if any of the print head nozzles are clogged. Then clean the print head, if necessary.
- Align the print head.
- Adjust the print quality.
- You may need to increase the image resolution or print a smaller size; see your software documentation.

Note: Images from the Internet may be low resolution and not result in a high quality printout.

- If you enlarged the image size in an image-editing program, you need to increase the image resolution setting to retain a high image quality. Increase the image resolution by the same amount you increase the image size. For example, if the image resolution is 300 dpi (dots per inch) and you will double the image size for printing, change the resolution setting to 600 dpi.

Note: Higher resolution settings result in larger file sizes, which take longer to process and print. Consider the limitations of your computer system when selecting a resolution, and select the lowest possible resolution that produces acceptable quality to keep file sizes manageable.

Parent topic: [Solving Print Quality Problems](#)

Related concepts

- [Print Head Alignment](#)
- [Print Head Cleaning](#)

[Print Head Nozzle Check](#)

Related tasks

[Selecting Basic Print Settings - Windows](#)

[Selecting Additional Layout and Print Options - Windows](#)

[Selecting Basic Print Settings - Mac](#)

[Selecting Printing Preferences - Mac](#)

Incorrect Colors

If your printouts have incorrect colors, try these solutions:

- Make sure the paper type setting matches the paper you loaded.
- Make sure the **Grayscale** setting is not selected in your printer software.
- If you selected **Standard-Vivid** (Windows) or **Normal-Vivid** (Mac) as the quality setting in the printer software, try selecting **Standard** (Windows) or **Normal** (Mac) instead.
- Run a nozzle check to see if any of the print head nozzles are clogged. Then clean the print head, if necessary.
- The ink packs may be old, and you may need to replace them.
- After you print, the colors in your printout need time to set as the ink dries. During this time, the colors may look different than you expect. To speed up drying time, do not stack your printouts on top of each other.
- Your printed colors can never exactly match your on-screen colors. However, you can use a color management system to get as close as possible. Try using the color management options in your printer software.
- Try turning off the **PhotoEnhance** setting in Windows.
- For best results, use genuine Epson paper.
- On the product control panel, change the **Fix Photo** setting from **Auto** to another option, or select **Enhance Off**.
- If you are using the Windows PostScript printer software, try adjusting the **Color Mode** setting on the Advanced tab of the printer software.

Parent topic: [Solving Print Quality Problems](#)

Related concepts

[Print Head Cleaning](#)

[Print Head Nozzle Check](#)

Related references

[Compatible Epson Papers](#)

Related tasks

[Selecting Basic Print Settings - Windows](#)

[Selecting Additional Layout and Print Options - Windows](#)

[Selecting Basic Print Settings - Mac](#)

[Managing Color - Mac](#)

[Removing and Installing Ink Packs](#)

Solving Scanning Problems

Check these solutions if you have problems scanning with your product.

[Scanning Software Does Not Operate Correctly](#)

[Cannot Start Epson Scan 2](#)

Parent topic: [Solving Problems](#)

Scanning Software Does Not Operate Correctly

If your scanning software does not operate correctly, try these solutions:

- Make sure your computer has adequate memory and meets the system requirements for your operating system.
- Make sure your computer is not running in a power-saving mode, such as sleep or standby. If so, wake your system and restart your scanning software.
- If you upgraded your operating system but did not reinstall your scanning software, try reinstalling it.
- In Windows, make sure your product is listed as a valid device in the **Scanners and Cameras** control panel.

Parent topic: [Solving Scanning Problems](#)

Related concepts

[Uninstall Your Product Software](#)

Related references

[Windows System Requirements](#)

[Mac System Requirements](#)

Cannot Start Epson Scan 2

If you cannot start Epson Scan 2, try these solutions:

- Make sure your product is turned on and any interface cables are securely connected at both ends.
- If your product is connected to a USB hub, connect it directly to your computer instead.
- If you scan at a high resolution over a network, a communication error may occur. Lower the resolution.
- If you are scanning with the ADF, check that the document cover and ADF cover are closed.
- Make sure Epson Scan 2 is selected as your scanning program.
- Make sure your computer is not running in a power-saving mode, such as sleep or standby. If so, wake your system and restart Epson Scan 2.
- Check the connection setting and test the connection using Epson Scan 2 Utility:

Windows 10: Click  and select **EPSON > Epson Scan 2 Utility**. Make sure the correct product is selected. If necessary, select the **Other** tab and click **Reset**.

Windows 8.x: Navigate to the **Apps** screen and select **Epson Scan 2 Utility**. Make sure the correct product is selected. If necessary, select the **Other** tab and click **Reset**.

Windows (other versions): Click  or **Start > All Programs** or **Programs > EPSON > Epson Scan 2 > Epson Scan 2 Utility**. Make sure the correct product is selected. If necessary, select the **Other** tab and click **Reset**.

Mac: Open the **Applications** folder, click **Epson Software**, and click **Epson Scan 2 Utility**. Make sure the correct product is selected. If necessary, select the **Other** tab and click **Reset**.

- Make sure you do not have multiple versions of Epson Scan 2 installed. If you do, uninstall both versions and install one version.
- If you upgraded your operating system but did not reinstall Epson Scan 2, try reinstalling it.
- If the user restriction feature (Access Control) is enabled, a user ID and password are required to scan. If you do not know the user ID or password, contact your administrator for assistance.

Parent topic: [Solving Scanning Problems](#)

Related tasks

[Starting a Scan Using the Epson Scan 2 Icon](#)

Solving Scanned Image Quality Problems

Check these sections if a scanned image on your computer screen has a quality problem.

[Image Consists of a Few Dots Only](#)
[Line of Dots Appears in All Scanned Images](#)
[Straight Lines in an Image Appear Crooked](#)
[Image is Distorted or Blurry](#)
[Image Colors are Patchy at the Edges](#)
[Image is Too Dark](#)
[Back of Original Image Appears in Scanned Image](#)
[Ripple Patterns Appear in an Image](#)
[Scanned Image Colors Do Not Match Original Colors](#)
[Scanned Image Edges are Cropped](#)
Parent topic: [Solving Problems](#)

Image Consists of a Few Dots Only

If your scanned image consists only of a few dots, try these solutions:

- Make sure you placed your original for scanning facing the correct way.
- If the **Image Type** setting is **Black & White**, adjust the **Threshold** and scan again.
- Remove any lint or dirt from your original.
- Do not press on the original or the document cover with too much force.

Parent topic: [Solving Scanned Image Quality Problems](#)

Related references

[Additional Scanning Settings - Advanced Settings Tab](#)

Related topics

[Placing Originals on the Product](#)

Line of Dots Appears in All Scanned Images

If a line of dots appears in all your scanned images, clean the scanner glass with a soft, dry, lint-free cloth or use a small amount of glass cleaner on the cloth, if necessary. Paper towels are not recommended.

Caution: Do not spray glass cleaner directly on the scanner glass.

If you are scanning from the ADF, try cleaning the ADF and scan again.

Parent topic: [Solving Scanned Image Quality Problems](#)

Related tasks

[Cleaning Your Product](#)

Straight Lines in an Image Appear Crooked

If straight lines in an original appear crooked in a scanned image, make sure to place your original straight when you scan it.

If you are scanning from the ADF, try cleaning the ADF and scan again.

Parent topic: [Solving Scanned Image Quality Problems](#)

Related tasks

[Cleaning Your Product](#)

Related topics

[Placing Originals on the Product](#)

Image is Distorted or Blurry

If a scanned image appears distorted or blurry, try these solutions:

- Do not move your original or your product during scanning.
- Your product will not operate properly while tilted at an angle. Place your product on a flat, stable surface that extends beyond its base in all directions.
- Adjust these Epson Scan 2 settings (if available) and try scanning again:
 - Increase the **Resolution** setting.
 - If the **Image Type** setting is **Black & White**, adjust the **Threshold** setting.
 - If the **Image Type** setting is **Color** or **Grayscale**, select the **Unsharp Mask** setting.
 - If the **Image Type** setting is **Black & White**, select **Text Enhancement**. If the **Image Type** setting is **Color** or **Grayscale**, change the **Text Enhancement** setting to **High**.

Parent topic: [Solving Scanned Image Quality Problems](#)

Related references

[Additional Scanning Settings - Advanced Settings Tab](#)

Image Colors are Patchy at the Edges

If you are scanning a thick or warped original, cover its edges with paper to block external light as you scan it.

Parent topic: [Solving Scanned Image Quality Problems](#)

Image is Too Dark

If your scanned image is too dark, try these solutions:

- If the **Image Type** is set to **Color** or **Grayscale**, adjust the **Brightness** setting.
- Check the brightness and contrast settings of your computer monitor.

Parent topic: [Solving Scanned Image Quality Problems](#)

Related references

[Additional Scanning Settings - Advanced Settings Tab](#)

Back of Original Image Appears in Scanned Image

If an image from the back of a thin original appears in your scanned image, try these solutions:

- Place a piece of black paper on the back of the original and scan it again.
- Adjust these Epson Scan 2 settings (if available) and try scanning again:
 - Select the **Advanced Settings** tab and adjust the **Brightness** setting.
 - If the **Image Type** is set to **Black & White**, select **Text Enhancement**. If the **Image Type** is set to **Color** or **Grayscale**, change the **Text Enhancement** setting to **High**.

Parent topic: [Solving Scanned Image Quality Problems](#)

Related references

[Additional Scanning Settings - Advanced Settings Tab](#)

Ripple Patterns Appear in an Image

You may see a ripple pattern (called a moiré) in scanned images of printed documents. This is caused by interference from differing pitches in the scanner's screen and your original's halftone screen. To reduce this effect, adjust these Epson Scan 2 settings (if available) and try scanning again:

- Select the **Descreening** setting.
- Select a lower **Resolution** setting.

Parent topic: [Solving Scanned Image Quality Problems](#)

Related references

[Additional Scanning Settings - Advanced Settings Tab](#)

Scanned Image Colors Do Not Match Original Colors

Printed colors can never exactly match the colors on your computer monitor because printers and monitors use different color systems: monitors use RGB (red, green, and blue) and printers typically use CMYK (cyan, magenta, yellow, and black).

Check the color matching and color management capabilities of your computer, display adapter, and the software you are using to see if they are affecting the palette of colors you see on your screen.

To adjust the colors in your scanned image, adjust these Epson Scan 2 settings (if available) and try scanning again:

- If the **Image Type** setting is **Color** or **Grayscale**, adjust the **Contrast** setting.
- If the **Image Type** setting is **Black & White** or **Grayscale**, adjust the **Color Enhance** setting.

Parent topic: [Solving Scanned Image Quality Problems](#)

Related references

[Additional Scanning Settings - Advanced Settings Tab](#)

Scanned Image Edges are Cropped

If the edges of a scanned image are cropped, make sure your original is placed correctly for scanning. If necessary, move your original away from the edges of the scanner glass slightly.

Parent topic: [Solving Scanned Image Quality Problems](#)

Related topics

[Placing Originals on the Product](#)

Solving Faxing Problems

Check these solutions if you have problems faxing with your product.

[Cannot Send or Receive Faxes](#)

[Cannot Receive Faxes with a Telephone Connected to Your Product](#)

[Fax Memory Full Error Appears](#)

[Sent Fax Quality is Poor](#)

[Sent Fax is Received in an Incorrect Size](#)

[Received Fax Quality is Poor](#)

Cannot Send or Receive Faxes

If you cannot send or receive faxes, try these solutions:

- If an error code is displayed on the control panel, try the solutions suggested in the error code list.
- If you are faxing from a computer, use the Epson FAX Utility to send your fax.
- Make sure the recipient's fax machine is turned on and working.
- Make sure paper is loaded correctly in your product.
- Make sure you have set up your header information and have not blocked your caller ID. Otherwise, your faxes might be rejected by the recipient's fax machine.
- If user restriction has been enabled, you may need to enter a user name and password. Contact your administrator for assistance.
- If you did not connect a telephone to your product, set the Receive Mode setting to **Auto** so you can receive faxes automatically.
- Check that the cable connecting your telephone wall jack to your product's **LINE** port is secure.
- Print a fax connection report using your product control panel or fax software to help diagnose the problem.
- Verify that the telephone wall jack works by connecting a phone to it and testing it.
- Check the **Line Type** setting and set it to **PBX**. If your phone system requires an external access code to reach an outside line, register the code to the product and add a # (hash) to the beginning of the phone number when dialing.
- If you connected your product to a DSL phone line, you must connect a DSL filter to the phone jack to enable faxing over the line. Contact your DSL provider for the necessary filter.
- If your telephone line has static, turn off your product's error correction mode fax communication setting and try faxing again.
- Try lowering your product's fax speed setting.
- Make sure the error correction mode (ECM) setting is turned on if you are trying to send or receive a color fax.
- If your telephone line uses call waiting and you have trouble receiving faxes, turn off call waiting to prevent disruption of incoming faxes.

- If you have subscribed to a call forwarding service, the product may not be able to receive faxes. Contact your service provider for assistance.
- Check your inbox and delete faxes after reading or printing them. If the inbox is full, the product cannot receive faxes.
- When sending faxes using the subaddress feature, ask the recipient if their fax machine can receive faxes using this feature. Check that the subaddress and password are correct, and that they match with the recipient subaddress and password. Check this when receiving faxes as well.
- When receiving faxes using the subaddress feature, make sure the fax rejection settings are not rejecting the fax.
- If you cannot send faxes at a specified time, make sure the date and time are set correctly on the product.
- If you are receiving faxes using the FAX Utility, check that your product is registered as a fax product in your operating system:

Windows: Make sure the product appears in **Devices and Printers**, **Printer**, or **Printers and Other Hardware**. If the product does not appear, uninstall and re-install the FAX Utility.

Mac: Select **System Preferences > Printers & Scanners** (or **Print & Scan** or **Print & Fax**) and make sure your product appears. If your product does not appear, click **+** and add your product. If the product does appear, double-click it and make sure it is not paused.

Note: If your product is connected to a VoIP (Voice over Internet Protocol) phone line, keep in mind that fax machines are designed to work over analog phone lines. Epson cannot guarantee that fax transmission will work when using VoIP.

If your phone line includes voice mail answering services, calls or faxes may be inadvertently received by your voice mail service.

Parent topic: [Solving Faxing Problems](#)

Related tasks

[Connecting a Telephone or Answering Machine](#)

[Using the Fax Setting Wizard](#)

[Selecting the Line Type](#)

[Selecting Advanced Fax Settings](#)

[Printing Fax Reports](#)

[Receiving Faxes Automatically](#)

Related topics

[Loading Paper](#)

Cannot Receive Faxes with a Telephone Connected to Your Product

If you cannot receive faxes when a telephone is connected to your product, try these solutions:

- Make sure your telephone is connected to your product's **EXT** port.
- Make sure the Receive Mode is set to **Manual**.

Note: When answering a call that is a fax, wait until the product's LCD screen displays a message that a connection has been made before you hang up.

Parent topic: [Solving Faxing Problems](#)

Related tasks

[Connecting a Telephone or Answering Machine](#)

[Using the Fax Setting Wizard](#)

Fax Memory Full Error Appears

If you see an error message telling you that the product's fax memory is full, try these solutions:

- If you set the product to save received faxes in the product's memory or inbox, delete any faxes you have already read.

Note: Your product can store up to 200 faxes before its inbox is full.

- If you set the product to save received faxes on a computer, turn on the selected computer. Once the faxes are saved on the computer, they are deleted from the product's memory.
- If you set the product to save received faxes on a USB device, connect the selected USB device containing the save fax folder to the product. Once the faxes are saved on the USB device, they are deleted from the product's memory.

Note: Make sure the USB device has enough available memory and is not write protected.

- If the memory is full, try sending a monochrome fax using the **Direct Send** feature, sending your fax by using the **On Hook** feature, sending your faxes by dialing from the external phone device, or sending your faxes in smaller batches.

- If the product cannot print a received fax due to a product error, such as a paper jam, the memory full error may appear. Clear any product errors, then ask the sender to resend the fax.

Parent topic: [Solving Faxing Problems](#)

Related tasks

[Saving and Viewing Received Faxes](#)

Sent Fax Quality is Poor

If the sent fax quality is poor, try these solutions:

- Clean the scanner glass.
- Clean the ADF.
- Try changing the resolution or density setting on the control panel.
- Try changing the original type setting on the control panel.
- If you are sending a monochrome fax to a single recipient, try sending the fax using the **Direct Send** feature.

Note: If you send a high-resolution monochrome fax without using the **Direct Send** feature, the product may automatically lower the resolution.

- Try enabling the error correction mode (ECM) setting.

Parent topic: [Solving Faxing Problems](#)

Related references

[Fax Sending Options](#)

Related tasks

[Cleaning Your Product](#)

Sent Fax is Received in an Incorrect Size

If your recipient receives a fax in an incorrect size, try these solutions:

- If you are sending a fax using the scanner glass, make sure your original is placed correctly and that the correct paper size is selected on the control panel.
- Clean the scanner glass and document cover.

Parent topic: [Solving Faxing Problems](#)

Related tasks

[Cleaning Your Product](#)

Related topics

[Placing Originals on the Product](#)

Received Fax Quality is Poor

If you receive a poor quality fax, try these solutions:

- Try enabling the error correction mode (ECM) setting.
- Contact the fax sender and ask them to send the fax in a higher resolution.
- Try reprinting the received fax.

Parent topic: [Solving Faxing Problems](#)

Related references

[Receive Settings - Fax](#)

Related tasks

[Saving and Viewing Received Faxes](#)

Received Fax is Not Printed

If a received fax is not printed, try these solutions:

- Make sure the product is free of errors. The product cannot print received faxes if an error has occurred with the product, such as a paper jam.
- If the product has been set to save received faxes in the product's memory or inbox, received faxes are not automatically printed. Check the **Receive Settings** options on the product control panel and change them, if necessary.

Parent topic: [Solving Faxing Problems](#)

Related references

[Receive Settings - Fax](#)

Solving USB Device Problems

Check these solutions if you have problems using USB devices with your product.

[Cannot View or Print from a USB Device](#)

[Cannot Save Files on a USB Device](#)

[Cannot Transfer Files To or From a USB Device](#)

Parent topic: [Solving Problems](#)

Cannot View or Print from a USB Device

If you cannot view or print photos or documents from a USB device connected to your product, try these solutions:

- Make sure memory devices are enabled on the product.
- Make sure your device is compatible with the product.
- Make sure the files on your device are in the correct format.

Parent topic: [Solving USB Device Problems](#)

Related references

[USB Device File Specifications](#)

[External USB Device Specifications](#)

Related tasks

[Setting Up File Sharing for File Transfers from Your Computer](#)

Cannot Save Files on a USB Device

If you cannot save files on a USB device connected to your product, try these solutions:

- To save faxes on a USB device, create a folder in the **Fax Output** settings on the product control panel.
- Make sure the device is not write-protected.
- Make sure the device has enough available space.
- Make sure memory devices are enabled on your product.
- Make sure the device is compatible with the product.

Parent topic: [Solving USB Device Problems](#)

Related references

[USB Device File Specifications](#)

[External USB Device Specifications](#)

Related tasks

[Setting Up File Sharing for File Transfers from Your Computer](#)

Cannot Transfer Files To or From a USB Device

If you have problems transferring files to or from a USB device connected to your product, try these solutions:

- Make sure your device is compatible with the product.
- Make sure the device is not write-protected.
- Make sure your product is securely connected to your computer.
- Make sure that the file sharing setting for your product is enabled.

Parent topic: [Solving USB Device Problems](#)

Uninstall Your Product Software

If you have a problem that requires you to uninstall and re-install your software, follow the instructions for your operating system.



[Uninstalling Product Software - Windows](#)

[Uninstalling Product Software - Mac](#)

Parent topic: [Solving Problems](#)

Uninstalling Product Software - Windows

You can uninstall and then re-install your product software to solve certain problems.

1. Turn off the product.
2. Disconnect any interface cables.
3. Do one of the following:
 - **Windows 10:** Click  and select  (Settings) > **Apps > Apps & features**. Then select the program you want to uninstall and select **Uninstall**.
 - **Windows 8.x:** Navigate to the **Apps** screen and select **Control Panel > Programs > Programs and Features**. Select the uninstall option for your Epson product, then select **Uninstall/Change**.

Note: If you see a **User Account Control** window, click **Yes** or **Continue**.

Select your product again, if necessary, then select **OK**, and click **Yes** to confirm the uninstallation.

- **Windows (other versions):** Click  or **Start**, and select **All Programs** or **Programs**. Select **EPSON**, select your product, then click **EPSON Printer Software Uninstall**.

Note: If you see a **User Account Control** window, click **Yes** or **Continue**.

In the next window, select your product and click **OK**. Then follow any on-screen instructions.

4. Do one of the following to uninstall Epson Scan 2, then follow any on-screen instructions:
 - **Windows 10:** Select **Epson Scan 2** and click **Uninstall**.
 - **Windows 8.x/Windows 7/Windows Vista:** Select **Epson Scan** and click **Uninstall/Change**.
5. Restart your computer, then see the *Start Here* sheet to re-install your software.

Note: If you find that re-installing your product software does not solve a problem, contact Epson.

Parent topic: [Uninstall Your Product Software](#)

Uninstalling Product Software - Mac

In most cases, you do not need to uninstall your product software before re-installing it. However, you can download the Uninstaller utility from the Epson support website to uninstall your product software as described here.

Note: If you find that re-installing your product software does not solve a problem, contact Epson.

1. To download the Uninstaller utility, visit epson.com/support (U.S.), epson.ca/support (Canada), or epson.com.jm/support (Caribbean) and select your product.
2. Click **Downloads**.
3. Select your operating system, click **Utilities**, locate the Uninstaller utility, and click **Download**.
4. Run the file you downloaded.
5. Double-click the **Uninstaller** icon.
6. In the Epson Uninstaller screen, select the checkbox for each software program you want to uninstall.
7. Click **Uninstall**.
8. Follow the on-screen instructions to uninstall the software.
9. Reinstall your product software.

Note: If you uninstall the printer driver and your product name remains in the **Print & Fax, Print & Scan,** or **Printers & Scanners** window, select your product name and click the – (remove) icon to remove it.

Parent topic: [Uninstall Your Product Software](#)

Where to Get Help

If you need to contact Epson for technical support services, use the following support options.

Internet Support

Visit Epson's support website at epson.com/support (U.S.), epson.ca/support (Canada), or epson.com.jm/support (Caribbean) and select your product for solutions to common problems. You can download drivers and documentation, get FAQs and troubleshooting advice, or e-mail Epson with your questions.

Speak to a Support Representative

Before you call Epson for support, please have the following information ready:

- Product name
- Product serial number (located on a label on the product)
- Proof of purchase (such as a store receipt) and date of purchase
- Computer configuration
- Description of the problem

Then call:

- U.S.: (562) 276-4382, 6 AM to 8 PM, Pacific Time, Monday through Friday, and 7 AM to 4 PM, Pacific Time, Saturday
- Canada: (905) 709-3839, 6 AM to 8 PM, Pacific Time, Monday through Friday, and 7 AM to 4 PM, Pacific Time, Saturday

Days and hours of support are subject to change without notice. Toll or long distance charges may apply.

Purchase Supplies and Accessories

You can purchase genuine Epson ink and paper at epson.com (U.S. sales), epson.ca (Canadian sales), or epson.com.jm (Caribbean sales). You can also purchase supplies from an Epson authorized reseller. To find the nearest one, call 800-GO-EPSON (800-463-7766) in the U.S. or 800-807-7766 in Canada.

Parent topic: [Solving Problems](#)

Technical Specifications

These sections list the technical specifications for your product.

Note: Epson offers a recycling program for end of life Epson products. Please go to [this site](#) (U.S) or [this site](#) (Canada) for information on how to return your Epson products for proper disposal.

[Windows System Requirements](#)

[Mac System Requirements](#)

[Paper Specifications](#)

[Printable Area Specifications](#)

[Automatic Document Feeder \(ADF\) Specifications](#)

[Scanning Specifications](#)

[Fax Specifications](#)

[Ink Pack Specifications](#)

[Dimension Specifications](#)

[Electrical Specifications](#)

[Environmental Specifications](#)

[Interface Specifications](#)

[External USB Device Specifications](#)

[Network Interface Specifications](#)

[Safety and Approvals Specifications](#)

[PostScript Fonts \(WF-C5790\)](#)

[PCL Fonts \(WF-C5790\)](#)

[PCL Mode 5 Symbol Sets \(WF-C5790\)](#)

Windows System Requirements

To use your product and its software, your computer should use one of these Microsoft operating systems:

- Windows 10
- Windows 8.x
- Windows 7
- Windows Vista

- Windows Server 2016
- Windows Server 2012 R2
- Windows Server 2012
- Windows Server 2008 R2
- Windows Server 2008
- Windows Server 2003 R2
- Windows Server 2003 SP2 or later

Note: For the latest product software available for your operating system, visit the Epson support site at epson.com/support (U.S.), epson.ca/support (Canada), or epson.com.jm/support (Caribbean), select your product, and select **Downloads**.

Parent topic: [Technical Specifications](#)

Mac System Requirements

To use your product and its software, your Mac should use one of these operating systems:

- macOS 10.13.x
- macOS 10.12.x
- OS X 10.11.x
- OS X 10.10.x
- OS X 10.9.x
- OS X 10.8.x
- OS X 10.7.x
- OS X 10.6.8

Note: For the latest product software available for your operating system, visit the Epson support site at epson.com/support (U.S.), epson.ca/support (Canada), or epson.com.jm/support (Caribbean), select your product, and select **Downloads**.

Parent topic: [Technical Specifications](#)

Paper Specifications

Note: Since the quality of any particular brand or type of paper may be changed by the manufacturer at any time, Epson cannot guarantee the quality of any non-Epson brand or type of paper. Always test a sample of paper stock before purchasing large quantities or printing large jobs.

Single-sheets

Size	A4 (8.3 × 11.7 inches [210 × 297 mm]) A6 (4.1 × 5.8 inches [105 × 148 mm]) Letter (8.5 × 11 inches [216 × 279 mm]) Legal (8.5 × 14 inches [216 × 356 mm]) Folio (8.5 × 13 inches [216 × 330 mm]) Executive (7.25 × 10.5 inches [184 × 267 mm]) Mexico-Oficio (8.5 × 13.4 inches [216 × 340 mm]) Oficio 9 (8.46 × 12.4 inches [215 × 315 mm]) 4 × 6 inches (102 × 152 mm) 5 × 7 inches (127 × 178 mm) 8 × 10 inches (203 × 254 mm) 3.5 × 5 inches (89 × 127 mm) Half Letter (5.5 × 8.5 inches [140 × 216 mm])
-------------	--

Paper types

Plain paper

Note: Your product also supports compatible papers distributed by Epson. See the link at the end of this topic for a list of compatible Epson papers.

Weight

Plain paper: 17 lb (64 g/m²) to 24 lb (90 g/m²)
Thick paper: 25 lb (91 g/m²) to 68 lb (256 g/m²)

Envelopes

Size	No. 10 (4.1 × 9.5 inches [105 × 241 mm])
-------------	--

Paper types

Plain bond paper

Weight

20 lb (95 g/m²) to 24 lb (90 g/m²)

Parent topic: [Technical Specifications](#)

Related references

[Compatible Epson Papers](#)

Printable Area Specifications

Single sheets

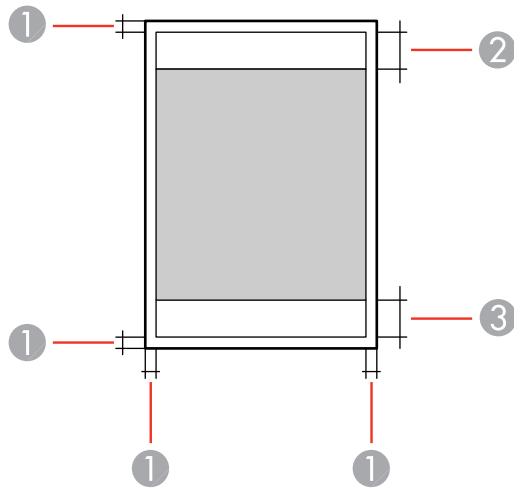

- 1 Top/bottom/right/left: 0.12 inch (3 mm) minimum
- 2 Reduced print quality area/top: 1.85 inches (47 mm) minimum
- 3 Reduced print quality area/bottom: 1.77 inches (45 mm) minimum

Envelopes

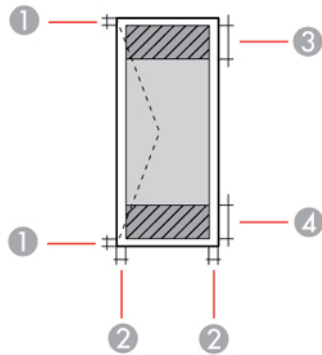

- 1 Left/right: 0.12 inch (3 mm) minimum
- 2 Top/bottom: 0.20 inch (5 mm) minimum
- 3 Reduced print quality area/left: 0.71 inch (18 mm) minimum
- 4 Reduced print quality area/right: 1.85 inches (47 mm) minimum

Parent topic: [Technical Specifications](#)

Automatic Document Feeder (ADF) Specifications

Paper input	Faceup loading
Paper output	Facedown ejection
Paper size	US letter, legal, or A4 size
Paper type	Plain paper, high-quality plain paper, or recycled paper
Paper weight	17 lb (64 g/m ²) to 24 lb (95 g/m ²)
Sheet feeding capacity	Total thickness: 0.22 inch (5.5 mm) Approximately 50 sheets

Parent topic: [Technical Specifications](#)

Scanning Specifications

Scanner type	Flatbed, color
Photoelectric device	CIS
Effective pixels	10200 × 14040 pixels at 1200 dpi
Document size	Maximum: 8.5 × 11.7 inches (216 × 297 mm) Scanner glass: US letter or A4
Scanning resolution	1200 dpi (main scan) 2400 dpi (sub scan)
Output resolution	50 to 9600 dpi in 1 dpi increments
Image data	Color: 48 bits per pixel (16 bits per pixel per color) internal 24 bits per pixel (8 bits per pixel per color) external Grayscale: 16 bits per pixel internal 8 bits per pixel external Black and white: 16 bits per pixel internal 1 bit per pixel external
Light source	LED

Parent topic: [Technical Specifications](#)

Fax Specifications

Fax type	Black-and-white and color fax capability (ITU-T Super Group 3)
Supported lines	Standard analog phone lines PBX (Private Branch Exchange) telephone systems
Speed	Up to 33.6 kbps

Resolution**Monochrome**

Standard: 203 pixels per inch × 98 lines per inch (8 pixels per mm × 3.85 lines per mm)

Fine: 203 pixels per inch × 196 lines per inch (8 pixels per mm × 7.7 lines per mm)

Super Fine: 203 pixels per inch × 392 lines per inch (8 pixels per mm × 15.4 lines per mm)

Ultra Fine: 406 pixels per inch × 392 lines per inch (16 pixels per mm × 15.4 lines per mm)

Color

200 × 200 dpi

Page memory

Up to 550 pages (when an ITU-T No. 1 chart is received in monochrome draft mode)

Redial

2 times (with 1 minute interval); may differ depending on your country or region

Interface

RJ-11 Phone Line

RJ-11 Telephone set connection

Parent topic: [Technical Specifications](#)

Ink Pack Specifications

Note: This printer is designed for use with Epson ink packs only, not third-party ink packs or ink. Other brands of ink supplies are not compatible and, if described as compatible, may not function properly or continuously. Such restrictions can be avoided with some other printers such as Epson EcoTank cartridge-free printers.

The included initial ink packs are designed for reliable printer setup and cannot be used as replacement ink packs or resold. After setup, the remaining ink is available for printing. Yields are based on ISO 24711 in default mode, printing continuously. Yields vary due to print images, settings, and temperatures. Printing infrequently or primarily with one color reduces yields. All ink packs must be installed with ink for printing and printer maintenance. For print quality, some ink remains in replaced ink packs.

Color

Cyan, Magenta, Yellow, Black

Ink pack life	Opened package: 6 months Unopened package: do not use if the date on the package has expired
Temperature	Storage: –22 to 104 °F (–30 to 40 °C) 1 month at 104 °F (40 °C) Ink freezes at 8.6 °F (–13 °C) Ink thaws and is usable after 3 hours at 77 °F (25 °C)

Parent topic: [Technical Specifications](#)

Related references

[Ink Supply Unit \(Ink Pack\) Part Numbers](#)

Dimension Specifications

Height	Stored: 14.1 inches (357 mm) Stored with optional cassette unit installed: 18.0 inches (457 mm) Printing: 17.7 inches (449 mm) Printing with optional cassette unit installed: 21.6 inches (549 mm)
Width	Stored: 16.7 inches (425 mm) Printing: 16.7 inches (425 mm)
Depth	Stored: 21.1 inches (535 mm); with output tray installed Printing: 22.8 inches (578 mm) Printing with optional cassette unit installed: 22.8 inches (578 mm)
Weight	40.6 lb (18.4 kg) (without ink packs or power cord) With optional cassette unit installed: 50.7 lb (23.0 kg)

Parent topic: [Technical Specifications](#)

Electrical Specifications

Power supply rating	100 to 240 V
----------------------------	--------------

Rated frequency range	50 to 60 Hz
Rated current	0.9 to 0.5 A
Power consumption	WF-C5710: Standalone copying: Approximately 23 W (ISO/IEC24712) Ready mode: Approximately 10 W Sleep mode: Approximately 1.5 W Power off mode: Approximately 0.2 W WF-C5790: Standalone copying: Approximately 25 W (ISO/IEC24712) Ready mode: Approximately 12 W Sleep mode: Approximately 1.5 W Power off mode: Approximately 0.2 W

Parent topic: [Technical Specifications](#)

Environmental Specifications

Temperature	Operating: 50 to 95 °F (10 to 35 °C) Storage: -4 to 104 °F (-20 to 40 °C) 1 month at 104 °F (40 °C)
Humidity (without condensation)	Operating: 20 to 80% RH Storage: 5 to 85% RH

Parent topic: [Technical Specifications](#)

Interface Specifications

Interface type	Hi-Speed USB (Device Class for computers) Hi-Speed USB (for Mass storage class for external storage)
-----------------------	---

Note: Epson cannot guarantee the operation of externally connected devices.

Parent topic: [Technical Specifications](#)

External USB Device Specifications

Do not use devices with the following requirements:

- Dedicated driver
- Security settings, such as password or encryption, etc.

USB memory device	2TB
	Formatted in FAT, FAT32, or exFAT

Note: Epson cannot guarantee the operation of externally connected devices.

Parent topic: [Technical Specifications](#)

Network Interface Specifications

Wi-Fi

Standard	IEEE 802.11 b/g/n; complies with either IEEE 802.11 b/g or IEEE 802.11 b/g/n, depending on purchase location
Security	WPA2-PSK (AES); complies with WPA2 standards with support for WPA/WPA2 Personal WEP (64/128 bit)
Frequency band	2.4 GHz
Maximum radio-frequency power transmitted	19.8 dBm (EIRP)
Communication mode	Infrastructure mode Wi-Fi Direct (Simple AP)

Note: Wi-Fi Direct Simple AP mode available even if you connect the product to an Ethernet network.

Ethernet

Standard	IEEE802.3i (10BASE-T)* IEEE802.3u (100BASE-TX) IEEE802.3ab (1000BASE-T)* IEEE802.3az (Energy Efficient Ethernet); the connected device should be IEEE802.3az compliant
Communication mode	Auto, 10Mbps Full duplex, 10Mbps Half duplex, 100Mbps Full duplex, 100Mbps Half duplex
Connector	RJ-45

* Use a category 5e or higher STP (Shielded twisted pair) cable to prevent risk of radio interference.

Security

IEEE802.1X; requires the connected device to comply with IEEE802.1X

IPsec/IP Filtering

SSL/TLS; either HTTPS Server/Client or IPPS

SMTPS (StartTLS, SSL/TLS)

SNMPv3

Parent topic: [Technical Specifications](#)

Safety and Approvals Specifications

United States	Safety: UL60950-1 EMC: FCC part 15 Subpart B Class B
Canada	Safety: CAN/CSA C22.2 No. 60950-1 EMC: CAN/CSA-CEI/IEC CISPR 22 Class B

This equipment contains the following wireless module:

- Manufacturer: Askey Computer Corporation.
- Type: WLU6320-D69 (RoHS)

This product conforms to Part 15 of FCC Rules and RSS-210 of the IC Rules. Epson cannot accept responsibility for any failure to satisfy the protection requirements resulting from a non-recommended modification of the product. Operation is subject to the following two conditions: (1) this device may not cause harmful interference, and (2) this device must accept any interference received, including interference that may cause undesired operation of the device.

To prevent radio interference to the licensed service, this device is intended to be operated indoors and away from windows to provide maximum shielding. Equipment (or its transmit antenna) that is installed outdoors is subject to licensing.

This equipment complies with FCC/IC radiation exposure limits set forth for an uncontrolled environment and meets the FCC radio frequency (RF) Exposure Guidelines in Supplement C to OET65 and RSS-102 of the IC radio frequency (RF) Exposure rules. This equipment should be installed and operated so that the radiator is kept at least 7.9 inches (20 cm) or more away from a person's body (excluding extremities: hands, wrists, feet and ankles).

Parent topic: [Technical Specifications](#)

PostScript Fonts (WF-C5790)

Font name	Family	HP equivalent
Nimbus Mono	Medium, Bold, Italic, Bold Italic	Courier
Letter Gothic	Medium, Bold, Italic,	Letter Gothic
Nimbus Mono PS	Regular, Bold, Oblique, Bold Oblique	Courier PS
Nimbus Roman No4	Medium, Bold, Italic, Bold Italic	CG Times
URW Classico	Medium, Bold, Italic, Bold Italic	CG Omega
URW Coronet	—	Coronet
URW Clarendon Condensed	—	Clarendon Condensed
URW Classic Sans	Medium, Bold, Italic, Bold Italic	Univers
URW Classic Sans Condensed	Medium, Bold, Italic, Bold Italic	Univers Condensed
Antique Olive	Medium, Bold, Italic	Antique Olive
Garamond	Antiqua, Halbfett, Kursiv, Kursiv Halbfett	Garamond
Mauritius	—	Marigold

Font name	Family	HP equivalent
Algiers	Medium, Extra Bold	Albertus
NimbusSansNo2	Medium, Bold, Italic, Bold Italic	Arial
Nimbus Roman No9	Medium, Bold, Italic, Bold Italic	Times New
Nimbus Sans	Medium, Bold, Oblique, Bold Oblique	Helvetica
Nimbus Sans Narrow	Medium, Bold, Oblique, Bold Oblique	Helvetica Narrow
Palladio	Roman, Bold, Italic, Bold Italic	Palatino
URW Gothic	Book, Demi, Book Oblique, Demi Oblique	ITC Avant Garde
URW Bookman	Light, Demi, Light Italic, Demi Italic	ITC Bookman
URW Century Schoolbook	Roman, Bold, Italic, Bold Italic	New Century Schoolbook
Nimbus Roman	Medium, Bold, Italic, Bold Italic	Times
URW Chancery Medium Italic	—	ITC Zapf Chancery Italic
Symbol	—	Symbol
URW Dingbats	—	Wingdings
Dingbats	—	ITC Zapf Dingbats
Standard Symbol	—	SymbolPS

Parent topic: [Technical Specifications](#)

PCL Fonts (WF-C5790)

Scalable Fonts

Font name	Family	HP equivalent	Symbol set
Nimbus Mono	Medium, Bold, Italic, Bold Italic	Courier	1
Letter Gothic	Regular, Bold, Italic,	Letter Gothic	1

Font name	Family	HP equivalent	Symbol set
Nimbus Mono PS	Regular, Bold, Oblique, Bold Oblique	CourierPS	3
Nimbus Roman No4	Medium, Bold, Italic, Bold Italic	CG Times	2
URW Classico	Medium, Bold, Italic, Bold Italic	CG Omega	3
URW Coronet	—	Coronet	3
URW Clarendon Condensed	—	Clarendon Condensed	3
URW Classic Sans	Medium, Bold, Italic, Bold Italic	Univers	2
URW Classic Sans Condensed	Medium, Bold, Italic, Bold Italic	Univers Condensed	3
Antique Olive	Medium, Bold, Italic	Antique Olive	3
Garamond	Antiqua, Halbfett, Kursiv, Kursiv Halbfett	Garamond	3
Mauritius	—	Marigold	3
Algiers	Medium, Extra Bold	Albertus	3
NimbusSansNo2	Medium, Bold, Italic, Bold Italic	Arial	3
Nimbus Roman No9	Medium, Bold, Italic, Bold Italic	Times New	3
Nimbus Sans	Medium, Bold, Oblique, Bold Oblique	Helvetica	3
Nimbus Sans Narrow	Medium, Bold, Oblique, Bold Oblique	Helvetica Narrow	3
Palladio	Roman, Bold, Italic, Bold Italic	Palatino	3
URW Gothic	Book, Demi, Book Oblique, Demi Oblique	ITC Avant Garde	3

Font name	Family	HP equivalent	Symbol set
URW Bookman	Light, Demi, Light Italic, Demi Italic	ITC Bookman	3
URW Century Schoolbook	Roman, Bold, Italic, Bold Italic	New Century Schoolbook	3
Nimbus Roman	Medium, Bold, Italic, Bold Italic	Times	3
URW Chancery Medium Italic	—	ITC Zapf Chancery Italic	3
Symbol	—	Symbol	4
URW DingBats	—	Wingdings	5
Dingbats	—	ITC Zapf Dingbats	6
Standard Symbol	—	SymbolPS	4
URW David	Medium, Bold	HP David	7
URW Narkis	Medium, Bold	HP Narkis Tam	7
URW Miryam	Medium, Bold, Italic	HP Miryam	7
URW Koufi	Medium, Bold	Koufi	8
URW Naskh	Medium, Bold	Naskh	8
URW Ryadh	Medium, Bold	Ryadh	8

Bitmap Font

Line Printer, Symbol set 9

OCR/Barcode Bitmap Font (PCL5 Mode Only)

Font name	Family	Symbol set
OCR A	—	10
OCR B	—	11
Code 39	9.37cpi, 4.68cpi	12
EAN/UPC	Medium, Bold	13

Note: Depending on the print density, or quality and color of the paper, the OCR/Barcode Bitmap fonts may not be readable. Print a sample and check for readability before printing large quantities.

Parent topic: [Technical Specifications](#)

PCL Mode 5 Symbol Sets (WF-C5790)

Your product can access a variety of symbol sets. Many of these symbol sets differ only in the international characters specific to each language.

Note: Since most software handles fonts and symbols automatically, you may never need to adjust your product settings. However, if you write your own product control programs, or if you use older software that cannot control fonts, refer to these tables for details on the symbol sets.

When you consider which font to use, also consider which symbol set to combine with the font.

Symbol set name	Attribute	Font classification
Norweg1	0D	1, 2, 3
Roman Extension	0E	9
Italian	0I	1, 2, 3
EMC94-1	0N	1, 2, 3
Swedis2	0S	1, 2, 3
ANSI ASCII	0U	1, 2, 3, 7, 8
UK	1E	1, 2, 3
French2	1F	1, 2, 3
German	1G	1, 2, 3
Legal	1U	1, 2, 3, 9
8859-2 ISO	2N	1, 2, 3, 9
Spanish	2S	1, 2, 3
ISO 8859/4 Latin 4	4N	1, 2, 3
Roman-9	4U	1, 2, 3
Ps Math	5M	1, 2, 3, 7, 8

Symbol set name	Attribute	Font classification
8859-9 ISO	5N	1, 2, 3, 9
WiTurkish	5T	1, 2, 3
MSPublishin	6J	1, 2, 3
Ve Math	6M	1, 2, 3
8859-10 ISO	6N	1, 2, 3, 9
DeskTop	7J	1, 2, 3
Math-8	8M	1, 2, 3, 7, 8
Roman-8	8U	1, 2, 3, 9
WiE.Europe	9E	1, 2, 3
Pc1004	9J	1, 2, 3
8859-15 ISO	9N	1, 2, 3, 9
PcTk437	9T	1, 2, 3
Windows	9U	1, 2, 3
PsText	10J	1, 2, 3
IBM-US	10U	1, 2, 3, 9
IBM-DN	11U	1, 2, 3, 9
McText	12J	1, 2, 3
PcMultiling	12U	1, 2, 3, 9
VeInternati	13J	1, 2, 3
PcEur858	13U	1, 2, 3
VeUS	14J	1, 2, 3
PiFont	15U	1, 2, 3
PcE.Europe	17U	1, 2, 3
Unicode 3.0	18N	1, 2, 3, 7, 8
WiBALT	19L	1, 2, 3
WiAnsi	19U	1, 2, 3

Symbol set name	Attribute	Font classification
PcBlit775	26U	1, 2, 3
Pc866Cyr	3R	1, 2
Greek8	8G	1, 2
WinGrk	9G	1, 2
WinCyr	9R	1, 2
Pc851Grk	10G	1, 2
ISOCyr	10N	1, 2, 9
Pc8Grk	12G	1, 2
ISOGrk	12N	1, 2
Pc866Ukr	14R	1, 2
Hebrew7	0H	1, 7
8859-8 ISO	7H	1, 7
Hebrew8	8H	1, 7
Pc862Heb	15H	1, 7
PC-862, Hebrew	15Q	1, 7
Arabic8	8V	8
HPWARA	9V	8
Pc864Ara	10V	8
Symbol	19M	4
Wingdings	579L	5
ZapfDingbats	14L	6
OCR A	0O	10
OCR B	1O	11
OCR B Extension	3Q	11
Code3-9	0Y	12
EAN/UPC	8Y	13

Parent topic: [Technical Specifications](#)

Notices

Check these sections for important notices about your product.

Note: Epson offers a recycling program for end of life Epson products. Please go to [this site](#) (U.S) or [this site](#) (Canada) for information on how to return your Epson products for proper disposal.

[Important Safety Instructions](#)

[FCC Compliance Statement](#)

[Binding Arbitration and Class Waiver](#)

[Trademarks](#)

[Copyright Notice](#)

Important Safety Instructions

Before using your Epson product, read and follow these safety instructions.

[General Product Safety Instructions](#)

[Ink Pack Safety Instructions](#)

[Wireless Connection Safety Instructions](#)

[LCD Screen Safety Instructions](#)

[Telephone Equipment Safety Instructions](#)

Parent topic: [Notices](#)

General Product Safety Instructions

- Be sure to follow all warnings and instructions marked on the product.
- Use only the type of power source indicated on the product's label.
- Use only the power cord that comes with the product. Use of another cord may cause fires or shock. Do not use the cord with any other equipment.
- Make sure the AC power cord meets the relevant local safety standard.
- Place the product near a wall outlet where the plug can be easily unplugged.
- Avoid plugging the product into an outlet on the same circuit as a photo copier or air control system that regularly switches on and off, or on an outlet controlled by a wall switch or timer.

- Do not let the power cord become damaged or frayed. Place it to avoid abrasions, cuts, fraying, crimping, and kinking. Do not place objects on top of it and do not allow it to be stepped on or run over. Be careful to keep the cord straight at each end.
- If you use an extension cord with the product, make sure the total ampere rating of the devices plugged into the extension cord does not exceed the cord's ampere rating. Also, make sure the total ampere rating of all devices plugged into the wall outlet does not exceed the wall outlet's ampere rating.
- Always turn off the product using the power button, and wait until the power light stops flashing before unplugging the product or cutting off power to the electrical outlet.
- If you will not be using the product for a long period, unplug the power cord from the electrical outlet.
- Place the product on a flat, stable surface that extends beyond its base in all directions. It will not operate properly if it is tilted or at an angle.
- Make sure the back of the product is at least 4 inches (10 cm) away from the wall.
- Allow space behind the product for the cables, and space above the product so that you can fully raise the document cover.
- Leave enough space in front of the product for the paper to be fully ejected.
- Avoid locations that are subject to rapid changes in heat or humidity, shocks or vibrations, or dust.
- Do not place or store the product outdoors.
- Do not place the product near excessive heat sources or in direct sunlight.
- Leave enough room around the product for sufficient ventilation. Do not block or cover openings in the case or insert objects through the slots.
- Keep the product away from potential sources of electromagnetic interference, such as loudspeakers or the base units of cordless telephones.
- Keep your product at least 8.7 inches (22 cm) away from cardiac pacemakers to prevent your product's radio waves from affecting the operation of the pacemaker.
- When connecting the product to a computer or other device with a cable, ensure the correct orientation of the connectors. Each connector has only one correct orientation. Inserting a connector in the wrong orientation may damage both devices connected by the cable.
- Do not spill liquid on the product or use the product with wet hands.
- Do not use aerosol products that contain flammable gases inside or around the product. Doing so may cause fire.
- Do not press too hard on the document table when placing originals.

- Do not open the scanner section while the product is copying, printing, scanning, or performing any other functions.
- Be careful not to trap your fingers when closing the document cover or scanner.
- Except as specifically explained in your documentation, do not attempt to service or disassemble the product yourself.
- Unplug the product and refer servicing to qualified service personnel under the following conditions: if the power cord or plug is damaged; if liquid has entered the product; if the product has been dropped or the case damaged; if the product does not operate normally or exhibits a distinct change in performance. Adjust only those controls that are covered by the operating instructions.
- Leave the ink packs installed. Removing the ink packs can dehydrate the print head and may prevent the product from printing.
- Before transporting the product, make sure that the print head is in the home (far right) position.
- When storing or transporting the product, do not tilt it, stand it on its side, or turn it upside down; otherwise ink may leak.

Parent topic: [Important Safety Instructions](#)

Ink Pack Safety Instructions

- Keep ink packs and maintenance boxes out of the reach of children and do not drink the ink.
- Be careful when you handle used ink packs; there may be ink remaining around the ink supply port. If ink gets on your skin, wash it off with soap and water. If it gets in your eyes, flush them immediately with water. If discomfort or vision problems continue after a thorough flushing, see a doctor immediately. If ink gets in your mouth, see a doctor right away.
- Do not put your hand inside the product or touch the ink packs during printing.
- Install a new ink pack immediately after removing an expended one. Leaving ink packs uninstalled can dry out the print head and may prevent the product from printing.
- Do not remove or tear the label on the ink pack; this can cause leakage.
- Do not remove the transparent seal from the ink supply area. This may cause the ink pack to become unusable.
- Do not touch the green IC chip on the side of the handle. This may prevent normal operation.
- Do not shake ink packs too vigorously; otherwise ink may leak.
- Use an ink pack before the date printed on its package.
- Do not disassemble an ink pack or a maintenance box. Ink may get in your eyes or on your skin.

- Store ink packs in a cool, dark place.
- After bringing an ink pack inside from a cold storage site, allow it to warm up at room temperature for at least 12 hours before using it.
- Store ink packs with the bottom facing down.

Parent topic: [Important Safety Instructions](#)

Wireless Connection Safety Instructions

Radio waves from this product may adversely affect the operation of medical equipment or automatically controlled devices, such as pacemakers, automatic doors or fire alarms. When using this product near such devices or inside a medical facility, follow the directions from authorized staff members at the facility, and follow all posted warnings and directions on the device to avoid causing an accident.

Parent topic: [Important Safety Instructions](#)

LCD Screen Safety Instructions

- Use only a dry, soft cloth to clean the LCD screen. Do not use liquid or chemical cleansers.
- If the LCD screen is damaged, contact Epson. If the liquid crystal solution gets on your hands, wash them thoroughly with soap and water. If the liquid crystal solution gets into your eyes, flush them immediately with water. If discomfort or vision problems remain after a thorough flushing, see a doctor immediately.
- Do not press too hard on the LCD screen or subject it to heavy impacts.
- Do not use a pointy or sharp object, such as a pen or your fingernail, to operate the LCD screen.
- If the LCD screen chips or cracks, do not touch or attempt to remove the broken pieces; contact Epson for support.

Parent topic: [Important Safety Instructions](#)

Telephone Equipment Safety Instructions

When using telephone equipment, you should always follow basic safety precautions to reduce the risk of fire, electric shock, and personal injury, including the following:

- Do not use the Epson product near water.
- Avoid using a telephone during an electrical storm. There may be a remote risk of electric shock from lightning.
- Do not use a telephone to report a gas leak in the vicinity of the leak.

Caution: To reduce the risk of fire, use only a No. 26 AWG or larger telecommunication line cord.

Parent topic: [Important Safety Instructions](#)

FCC Compliance Statement

For United States Users

This equipment complies with Part 68 of the FCC rules and the requirements adopted by the Administrative Council for Terminal Attachments ("ACTA") . On the surface of this equipment is a label that contains, among other information, a product identifier in the format US:AAAEQ##TXXXX. If requested, this number must be provided to the telephone company.

Applicable certification jack Universal Service Order Codes ("USOC") for the equipment: RJ11C.

A plug and jack used to connect this equipment to the premises wiring and telephone network must comply with the applicable FCC Part 68 rules and requirements adopted by the ACTA. A compliant telephone cord and modular plug is provided with this product. It is designed to be connected to a compatible modular jack that is also compliant. See installation instructions for details.

The REN is used to determine the number of devices that may be connected to a telephone line. Excessive RENs on a telephone line may result in the devices not ringing in response to an incoming call. In most but not all areas, the sum of RENs should not exceed five (5.0). To be certain of the number of devices that may be connected to a line, as determined by the total RENs, contact the local telephone company. For products approved after July 23, 2001 , the REN for this product is part of the product identifier that has the format US:AAAEQ##TXXXX. The digits represented by ## are the REN without a decimal point (e.g., 03 is a REN of 0.3). For earlier products, the REN is separately shown on the label.

If this equipment causes harm to the telephone network, the telephone company will notify you in advance that temporary discontinuance of service may be required. But if advance notice isn't practical, the telephone company will notify the customer as soon as possible. Also, you will be advised of your right to file a complaint with the FCC if you believe it is necessary.

The telephone company may make changes in its facilities, equipment, operations or procedures that could affect the operation of the equipment. If this happens the telephone company will provide advance notice in order for you to make necessary modifications to maintain uninterrupted service.

If you have problems with this product and require technical or customer support, please visit www.epson.com for more information.

This product is not intended to be repaired by the customer. If you experience trouble connecting this equipment to a telephone line, please contact:

Name: Epson America, Inc.

Address: 3840 Kilroy Airport Way, Long Beach, CA 90806 U.S.A.

Telephone: (562) 981-3840

If the equipment is causing harm to the telephone network, the telephone company may request that you disconnect the equipment until the problem is resolved.

This equipment may not be used on coin service provided by the telephone company. Connection to party line service is subject to state tariffs. Contact the state public utility commission, public service commission or corporation commission for information.

If your home has specially wired alarm equipment connected to the telephone line, ensure the installation of this equipment does not disable your alarm equipment. If you have questions about what will disable alarm equipment, consult your telephone company or a qualified installer.

The Telephone Consumer Protection Act of 1991 makes it unlawful for any person to use a computer or other electronic device, including fax machines, to send any message unless such message clearly contains in a margin at the top or bottom of each transmitted page or on the first page of the transmission, the date and time it is sent and an identification of the business or other entity, or other individual sending the message and the telephone number of the sending machine or such business, other entity, or individual. (The telephone number provided may not be a 900 number or any other number for which charges exceed local or long-distance transmission charges.)

In order to program this information into your fax machine, click the link below for instructions on entering fax header information.

According to the FCC's electrical safety advisory, we recommend that you may install an AC surge arrester in the AC outlet to which this equipment is connected. Telephone companies report that electrical surges, typically lightning transients, are very destructive to customer terminal equipment connected to AC power sources and that this is a major nationwide problem.

This equipment has been tested and found to comply with the limits for a Class B digital device, pursuant to Part 15 of the FCC Rules. These limits are designed to provide reasonable protection against harmful interference in a residential installation. This equipment generates, uses, and can radiate radio frequency energy and, if not installed and used in accordance with the instructions, may cause harmful interference to radio or television reception. However, there is no guarantee that interference will not occur in a particular installation. If this equipment does cause interference to radio and television reception, which can be determined by turning the equipment off and on, the user is encouraged to try to correct the interference by one or more of the following measures:

- Reorient or relocate the receiving antenna.
- Increase the separation between the equipment and receiver.
- Connect the equipment into an outlet on a circuit different from that to which the receiver is connected.
- Consult the dealer or an experienced radio/TV technician for help.

WARNING

The connection of a non-shielded equipment interface cable to this equipment will invalidate the FCC Certification or Declaration of this device and may cause interference levels which exceed the limits established by the FCC for this equipment. It is the responsibility of the user to obtain and use a shielded equipment interface cable with this device. If this equipment has more than one interface connector, do not leave cables connected to unused interfaces. Changes or modifications not expressly approved by the manufacturer could void the user's authority to operate the equipment.

For Canadian Users

1. This product meets the applicable Innovation, Science and Economic Development Canada technical specifications.
2. The Ringer Equivalence Number indicates the maximum number of devices allowed to be connected to a telephone interface. The termination of an interface may consist of any combination of devices subject only to the requirement that the sum of the RENs of all the devices does not exceed five.

CAN ICES-3(B)/NMB-3(B)

Le présent produit est conforme aux spécifications techniques applicables d'Innovation, Sciences et Développement économique Canada.

L'indice d'équivalence de la sonnerie (IES) sert à indiquer le nombre maximal de dispositifs qui peuvent être raccordés à une interface téléphonique. La terminaison d'une interface peut consister en une combinaison quelconque de dispositifs, à la seule condition que la somme des IES de tous les dispositifs n'excède pas cinq.

CAN ICES-3(B)/NMB-3(B)

Parent topic: [Notices](#)

Related tasks

[Using the Fax Setting Wizard](#)

Binding Arbitration and Class Waiver

1. DISPUTES, BINDING INDIVIDUAL ARBITRATION, AND WAIVER OF CLASS ACTIONS AND CLASS ARBITRATIONS

1.1 Disputes. The terms of this Section 1 shall apply to all Disputes between you and Epson. The term "Dispute" is meant to have the broadest meaning permissible under law and includes any dispute, claim, controversy or action between you and Epson arising out of or relating to this Agreement, Epson branded products (hardware and including any related software), or other transaction involving you and Epson, whether in contract, warranty, misrepresentation, fraud, tort, intentional tort, statute, regulation, ordinance, or any other legal or equitable basis. "DISPUTE" DOES NOT INCLUDE IP CLAIMS, or more

specifically, a claim or cause of action for (a) trademark infringement or dilution, (b) patent infringement, (c) copyright infringement or misuse, or (d) trade secret misappropriation (an "IP Claim"). You and Epson also agree, notwithstanding Section 1.6, that a court, not an arbitrator, may decide if a claim or cause of action is for an IP Claim.

1.2 Binding Arbitration. You and Epson agree that all Disputes shall be resolved by binding arbitration according to this Agreement. **ARBITRATION MEANS THAT YOU WAIVE YOUR RIGHT TO A JUDGE OR JURY IN A COURT PROCEEDING AND YOUR GROUNDS FOR APPEAL ARE LIMITED.**

Pursuant to this Agreement, binding arbitration shall be administered by JAMS, a nationally recognized arbitration authority, pursuant to its code of procedures then in effect for consumer related disputes, but excluding any rules that permit joinder or class actions in arbitration (for more detail on procedure, see Section 1.6 below). You and Epson understand and agree that (a) the Federal Arbitration Act (9 U.S.C. §1, et seq.) governs the interpretation and enforcement of this Section 1, (b) this Agreement memorializes a transaction in interstate commerce, and (c) this Section 1 shall survive termination of this Agreement.

1.3 Pre-Arbitration Steps and Notice. Before submitting a claim for arbitration, you and Epson agree to try, for sixty (60) days, to resolve any Dispute informally. If Epson and you do not reach an agreement to resolve the Dispute within the sixty (60) days, you or Epson may commence an arbitration. Notice to Epson must be addressed to: Epson America, Inc., ATTN: Legal Department, 3840 Kilroy Airport Way, Long Beach, CA 90806 (the "Epson Address"). The Dispute Notice to you will be sent to the most recent address Epson has in its records for you. For this reason, it is important to notify us if your address changes by emailing us at EAILEgal@ea.epson.com or writing us at the Epson Address above. Notice of the Dispute shall include the sender's name, address and contact information, the facts giving rise to the Dispute, and the relief requested (the "Dispute Notice"). Following receipt of the Dispute Notice, Epson and you agree to act in good faith to resolve the Dispute before commencing arbitration.

1.4 Small Claims Court. Notwithstanding the foregoing, you may bring an individual action in the small claims court of your state or municipality if the action is within that court's jurisdiction and is pending only in that court.

1.5 WAIVER OF CLASS ACTIONS AND CLASS ARBITRATIONS. YOU AND EPSON AGREE THAT EACH PARTY MAY BRING DISPUTES AGAINST THE OTHER PARTY ONLY IN AN INDIVIDUAL CAPACITY, AND NOT AS A PLAINTIFF OR CLASS MEMBER IN ANY CLASS OR REPRESENTATIVE PROCEEDING, INCLUDING WITHOUT LIMITATION FEDERAL OR STATE CLASS ACTIONS, OR CLASS ARBITRATIONS. CLASS ACTION LAWSUITS, CLASS-WIDE ARBITRATIONS, PRIVATE ATTORNEY-GENERAL ACTIONS, AND ANY OTHER PROCEEDING WHERE SOMEONE ACTS IN A REPRESENTATIVE CAPACITY ARE NOT ALLOWED. ACCORDINGLY, UNDER THE ARBITRATION PROCEDURES OUTLINED IN THIS SECTION, AN ARBITRATOR SHALL NOT COMBINE OR CONSOLIDATE MORE THAN ONE PARTY'S CLAIMS WITHOUT THE WRITTEN CONSENT OF ALL AFFECTED PARTIES TO AN ARBITRATION PROCEEDING.

1.6 Arbitration Procedure. If you or Epson commences arbitration, the arbitration shall be governed by the rules of JAMS that are in effect when the arbitration is filed, excluding any rules that permit arbitration on a class or representative basis (the "JAMS Rules"), available at <http://www.jamsadr.com> or by calling 1-800-352-5267, and under the rules set forth in this Agreement. All Disputes shall be resolved by a single neutral arbitrator, and both parties shall have a reasonable opportunity to participate in the selection of the arbitrator. The arbitrator is bound by the terms of this Agreement. The arbitrator, and not any federal, state or local court or agency, shall have exclusive authority to resolve all disputes arising out of or relating to the interpretation, applicability, enforceability or formation of this Agreement, including any claim that all or any part of this Agreement is void or voidable. Notwithstanding this broad delegation of authority to the arbitrator, a court may determine the limited question of whether a claim or cause of action is for an IP Claim, which is excluded from the definition of "Disputes" in Section 1.1 above. The arbitrator shall be empowered to grant whatever relief would be available in a court under law or in equity. The arbitrator may award you the same damages as a court could, and may award declaratory or injunctive relief only in favor of the individual party seeking relief and only to the extent necessary to provide relief warranted by that party's individual claim. In some instances, the costs of arbitration can exceed the costs of litigation and the right to discovery may be more limited in arbitration than in court. The arbitrator's award is binding and may be entered as a judgment in any court of competent jurisdiction.

You may choose to engage in arbitration hearings by telephone. Arbitration hearings not conducted by telephone shall take place in a location reasonably accessible from your primary residence, or in Orange County, California, at your option.

a) Initiation of Arbitration Proceeding. If either you or Epson decides to arbitrate a Dispute, both parties agree to the following procedure:

(i) Write a Demand for Arbitration. The demand must include a description of the Dispute and the amount of damages sought to be recovered. You can find a copy of a Demand for Arbitration at <http://www.jamsadr.com> ("Demand for Arbitration").

(ii) Send three copies of the Demand for Arbitration, plus the appropriate filing fee, to: JAMS, 500 North State College Blvd., Suite 600 Orange, CA 92868, U.S.A.

(iii) Send one copy of the Demand for Arbitration to the other party (same address as the Dispute Notice), or as otherwise agreed by the parties.

b) Hearing Format. During the arbitration, the amount of any settlement offer made shall not be disclosed to the arbitrator until after the arbitrator determines the amount, if any, to which you or Epson is entitled. The discovery or exchange of non-privileged information relevant to the Dispute may be allowed during the arbitration.

c) Arbitration Fees. Epson shall pay, or (if applicable) reimburse you for, all JAMS filings and arbitrator fees for any arbitration commenced (by you or Epson) pursuant to provisions of this Agreement.

d) Award in Your Favor. For Disputes in which you or Epson seeks \$75,000 or less in damages exclusive of attorney's fees and costs, if the arbitrator's decision results in an award to you in an amount greater than Epson's last written offer, if any, to settle the Dispute, Epson will: (i) pay you \$1,000 or the amount of the award, whichever is greater; (ii) pay you twice the amount of your reasonable attorney's fees, if any; and (iii) reimburse you for any expenses (including expert witness fees and costs) that your attorney reasonably accrues for investigating, preparing, and pursuing the Dispute in arbitration. Except as agreed upon by you and Epson in writing, the arbitrator shall determine the amount of fees, costs, and expenses to be paid by Epson pursuant to this Section 1.6d).

e) Attorney's Fees. Epson will not seek its attorney's fees and expenses for any arbitration commenced involving a Dispute under this Agreement. Your right to attorney's fees and expenses under Section 1.6d) above does not limit your rights to attorney's fees and expenses under applicable law; notwithstanding the foregoing, the arbitrator may not award duplicative awards of attorney's fees and expenses.

1.7 Opt-out. You may elect to opt-out (exclude yourself) from the final, binding, individual arbitration procedure and waiver of class and representative proceedings specified in this Agreement by sending a written letter to the Epson Address within thirty (30) days of your assent to this Agreement (including without limitation the purchase, download, installation of the Software or other applicable use of Epson Hardware, products and services) that specifies (i) your name, (ii) your mailing address, and (iii) your request to be excluded from the final, binding individual arbitration procedure and waiver of class and representative proceedings specified in this Section 1. In the event that you opt-out consistent with the procedure set forth above, all other terms shall continue to apply, including the requirement to provide notice prior to litigation.

1.8 Amendments to Section 1. Notwithstanding any provision in this Agreement to the contrary, you and Epson agree that if Epson makes any future amendments to the dispute resolution procedure and class action waiver provisions (other than a change to Epson's address) in this Agreement, Epson will obtain your affirmative assent to the applicable amendment. If you do not affirmatively assent to the applicable amendment, you are agreeing that you will arbitrate any Dispute between the parties in accordance with the language of this Section 1 (or resolve disputes as provided for in Section 1.7, if you timely elected to opt-out when you first assented to this Agreement).

1.9 Severability. If any provision in this Section 1 is found to be unenforceable, that provision shall be severed with the remainder of this Agreement remaining in full force and effect. **The foregoing shall not apply to the prohibition against class or representative actions as provided in Section 1.5. This means that if Section 1.5 is found to be unenforceable, the entire Section 1 (but only Section 1) shall be null and void.**

Parent topic: [Notices](#)

Trademarks

EPSON® is a registered trademark, EPSON Exceed Your Vision is a registered logomark, and Epson Connect™ is a trademark of Seiko Epson Corporation.

Epson StoreSM is a service mark of Epson America, Inc.

Epson iPrint™ and Remote Print™ are trademarks of Seiko Epson Corporation.

Apple, App Store, AirPrint, AirPrint logo, Mac, macOS, and OS X are trademarks of Apple Inc., registered in the U.S. and other countries.

Google® is a registered trademark and Android™, Chromebook™, Gmail™, Google Chrome™, Google Cloud Print™, Google Drive™, and Google Play™ are trademarks of Google LLC.

Wi-Fi Direct® is a registered trademark of Wi-Fi Alliance®.

General Notice: Other product names used herein are for identification purposes only and may be trademarks of their respective owners. Epson disclaims any and all rights in those marks.



Parent topic: [Notices](#)

Copyright Notice

All rights reserved. No part of this publication may be reproduced, stored in a retrieval system, or transmitted in any form or by any means, electronic, mechanical, photocopying, recording, or otherwise, without the prior written permission of Seiko Epson Corporation. The information contained herein is designed only for use with this Epson product. Epson is not responsible for any use of this information as applied to other products.

Neither Seiko Epson Corporation nor its affiliates shall be liable to the purchaser of this product or third parties for damages, losses, costs, or expenses incurred by purchaser or third parties as a result of: accident, misuse, or abuse of this product or unauthorized modifications, repairs, or alterations to this product, or (excluding the U.S.) failure to strictly comply with Seiko Epson Corporation's operating and maintenance instructions.

Seiko Epson Corporation shall not be liable for any damages or problems arising from the use of any options or any consumable products other than those designated as Original Epson Products or Epson Approved Products by Seiko Epson Corporation.

Seiko Epson Corporation shall not be held liable for any damage resulting from electromagnetic interference that occurs from the use of any interface cables other than those designated as Epson approved Products by Seiko Epson Corporation.

This information is subject to change without notice.

[libTIFF Software Acknowledgment](#)

[A Note Concerning Responsible Use of Copyrighted Materials](#)

[Default Delay Times for Power Management for Epson Products](#)

[Copyright Attribution](#)

Parent topic: [Notices](#)

libTIFF Software Acknowledgment

Copyright © 1988-1997 Sam Leffler

Copyright © 1991-1997 Silicon Graphics, Inc.

Permission to use, copy, modify, distribute, and sell this software and its documentation for any purpose is hereby granted without fee, provided that (i) the above copyright notices and this permission notice appear in all copies of the software and related documentation, and (ii) the names of Sam Leffler and Silicon Graphics may not be used in any advertising or publicity relating to the software without the specific, prior written permission of Sam Leffler and Silicon Graphics.

THE SOFTWARE IS PROVIDED "AS-IS" AND WITHOUT WARRANTY OF ANY KIND, EXPRESS, IMPLIED OR OTHERWISE, INCLUDING WITHOUT LIMITATION, ANY WARRANTY OF MERCHANTABILITY OR FITNESS FOR A PARTICULAR PURPOSE.

IN NO EVENT SHALL SAM LEFFLER OR SILICON GRAPHICS BE LIABLE FOR ANY SPECIAL, INCIDENTAL, INDIRECT OR CONSEQUENTIAL DAMAGES OF ANY KIND, OR ANY DAMAGES WHATSOEVER RESULTING FROM LOSS OF USE, DATA OR PROFITS, WHETHER OR NOT ADVISED OF THE POSSIBILITY OF DAMAGE, AND ON ANY THEORY OF LIABILITY, ARISING OUT OF OR IN CONNECTION WITH THE USE OR PERFORMANCE OF THIS SOFTWARE.

Parent topic: [Copyright Notice](#)

A Note Concerning Responsible Use of Copyrighted Materials

Epson encourages each user to be responsible and respectful of the copyright laws when using any Epson product. While some countries' laws permit limited copying or reuse of copyrighted material in certain circumstances, those circumstances may not be as broad as some people assume. Contact your legal advisor for any questions regarding copyright law.

Parent topic: [Copyright Notice](#)

Default Delay Times for Power Management for Epson Products

This product will enter sleep mode after a period of nonuse. This is to ensure that the product meets Energy Star standards of energy efficiency. More energy savings can be achieved by setting the time to sleep to a shorter interval.

Parent topic: [Copyright Notice](#)

Copyright Attribution

© 2018 Epson America, Inc.

9/18

CPD-54686R2

Parent topic: [Copyright Notice](#)