

User manual

SyncMaster S19B150B S24B150BL

The color and the appearance may differ depending on the product, and the specifications are subject to change without prior notice to improve the performance.

Table Of Contents

BEFORE USING THE PRODUCT	7	Copyright
	7	Icons used in this manual
	7	Symbols for safety precautions
	8	Cleaning
	8	Cleaning
	9	Securing the Installation Space
	9	Precautions for storage
	10	Safety Precautions
	10	Electricity and Safety
	11	Installation and Safety
	13	Operation and Safety
	17	Correct posture to use the product
PREPARATIONS	18	Checking the Contents
	18	Removing the Packaging
	19	Checking the Components
	20	Parts
	20	Frontal Buttons
	22	Reverse Side
	23	Installation
	23	Attaching the Stand
	24	Adjusting the Product Tilt
	24	Anti-theft Lock
CONNECTING AND USING A SOURCE DEVICE	25	Before Connecting
	25	Pre-connection Checkpoints
	25	Connecting the Power
	26	Connecting and Using a PC
	26	Connecting to a PC
	27	Driver Installation
	28	Setting Optimum Resolution
	29	Changing the Resolution Using a PC

Table Of Contents

SCREEN SETUP	32	Brightness
	32	Configuring Brightness
	33	Contrast
	33	Configuring Contrast
	34	Sharpness
	34	Configuring Sharpness
	35	SAMSUNG MAGIC Bright
	35	Configuring SAMSUNG MAGIC Bright
	36	Coarse
	36	Adjusting Coarse
	37	Fine
	37	Adjusting Fine
CONFIGURING TINT	38	SAMSUNG MAGIC Color
	38	Configuring SAMSUNG MAGIC Color
	39	Red
	39	Configuring Red
	40	Green
	40	Configuring Green
	41	Blue
	41	Configuring Blue
	42	Color Tone
	42	Configuring the Color Tone Settings
	43	Gamma
	43	Configuring Gamma

Table Of Contents

RESIZING OR RELOCATING THE SCREEN

44

44

45

45

46

46

SETUP AND RESET

47

47

48

48

49

49

50

50

51

51

52

52

53

53

54

54

55

55

56

56

H-Position & V-Position

Configuring H-Position & V-Position

Image Size

Changing the Image Size

Menu H-Position & Menu V-Position

Configuring Menu H-Position & Menu V-Position

Reset

Initializing Settings (Reset)

Language

Changing the Language

Eco Saving

Configuring Eco Saving

Off Timer On/Off

Configuring Off Timer On/Off

Off Timer Setting

Configuring Off Timer Setting

PC/AV Mode

Configuring PC/AV Mode

Key Repeat Time

Configuring Key Repeat Time

Customized Key

Configuring Customized Key

Auto Source

Configuring Auto Source

Display Time

Configuring Display Time

Table Of Contents

	57	Menu Transparency
	57	Changing Menu Transparency
INFORMATION MENU AND OTHERS	58	INFORMATION
	58	Displaying INFORMATION
INSTALLING THE SOFTWARE	59	Magic Tune
	59	What is MagicTune?
	59	Installing the Software
	60	Removing the Software
	61	MultiScreen
	61	Installing the Software
	62	Removing the Software
TROUBLESHOOTING GUIDE	63	Requirements Before Contacting Samsung Customer Service Center
	63	Testing the Product
	63	Checking the Resolution and Frequency
	63	Check the following.
	65	Q & A
SPECIFICATIONS	67	General
	69	PowerSaver
	70	Standard Signal Mode Table
APPENDIX	73	Contact SAMSUNG WORLDWIDE

Table Of Contents

78	Responsibility for the Pay Service (Cost to Customers)
78	Not a product defect
78	A Product damage caused by customer's fault
78	Others
79	Correct Disposal
79	Correct Disposal of This Product (Waste Electrical & Electronic Equipment)
80	Terminology

Before Using the Product

Copyright

The contents of this manual are subject to change without notice to improve quality.

© 2012 Samsung Electronics

Samsung Electronics owns the copyright for this manual.

Use or reproduction of this manual in parts or entirety without the authorization of Samsung Electronics is prohibited.

The SAMSUNG and SyncMaster logos are registered trademarks of Samsung Electronics.

Microsoft, Windows and Windows NT are registered trademarks of Microsoft Corporation.

VESA, DPM and DDC are registered trademarks of the Video Electronics Standards Association.





- An administration fee may be charged if either
 - (a) an engineer is called out at your request and there is no defect in the product (i.e. where you have failed to read this user manual).
 - (b) you bring the unit to a repair center and there is no defect in the product (i.e. where you have failed to read this user manual).
- The amount of such administration charge will be advised to you before any work or home visit is carried out.

Icons used in this manual



The following images are for reference only. Real-life situations may differ from what is shown in the images.

Symbols for safety precautions

 Warning	A serious or fatal injury may result if instructions are not followed.
 Caution	Personal injury or damage to properties may result if instructions are not followed.
	Activities marked by this symbol are prohibited.
	Instructions marked by this symbol must be followed.

Before Using the Product

Cleaning

Cleaning

Exercise care when cleaning as the panel and exterior of advanced LCDs are easily scratched.

Take the following steps when cleaning.

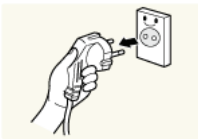

1. Power off the monitor and computer.
2. Disconnect the power cord from the monitor.



Hold the power cable by the plug and do not touch the cable with wet hands. Otherwise, an electric shock may result.

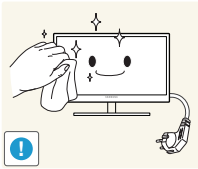

3. Wipe the monitor screen using a clean, soft and dry cloth.



- Do not apply a cleaning agent that contains alcohol, solvent, or surfactant to the monitor.



- Do not spray water or detergent directly on the product.

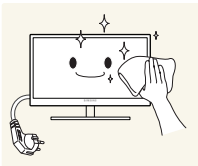

4. Wet a soft and dry cloth in water and wring thoroughly to clean the exterior of the monitor.

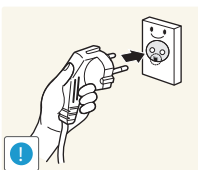

5. Connect the power cord to the product after cleaning the product.
6. Power on the monitor and computer.

Before Using the Product

Securing the Installation Space

- Ensure some space around the product for ventilation. An internal temperature rise may cause fire and damage the product. Be sure to allow the amount of space as shown below or greater when installing the product.



The exterior may differ depending on the product.

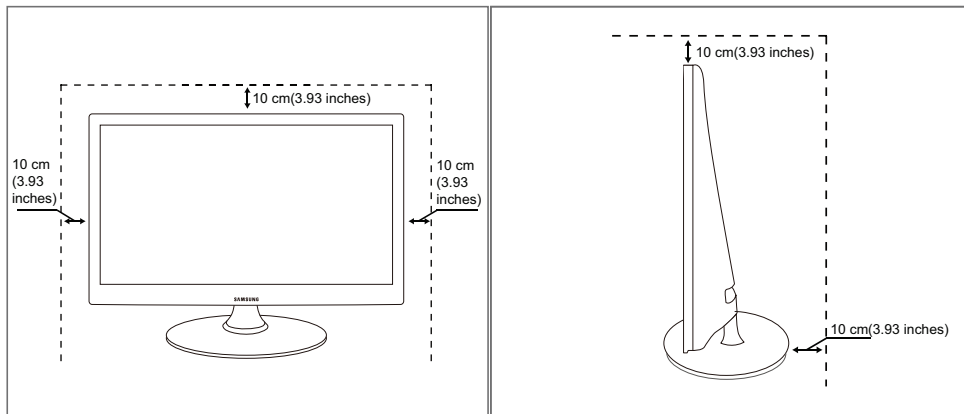

Precautions for storage



Be sure to contact Samsung Customer Service Center (page 73) if the inside of the monitor needs cleaning. (Service fee will be charged.)

Before Using the Product

Safety Precautions

Electricity and Safety



The following images are for reference only. Real-life situations may differ from what is shown in the images.

Warning

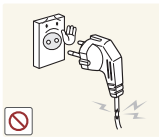

Do not use a damaged power cord or plug, or a loose power socket.

- An electric shock or fire may result.



Do not plug many products into the same power socket.

- Otherwise, the socket may overheat and cause a fire.



Do not touch the power plug with wet hands.

- Otherwise, an electric shock may result.

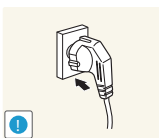

Insert the power plug all the way in so it is not loose.

- An unstable connection may cause a fire.

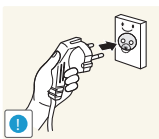

Ensure you connect the power plug to a grounded power socket. (type 1 insulated devices only).

- An electric shock or injury may result.

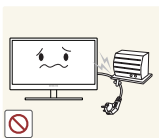

Do not bend or pull the power cord with force. Do not weigh the power cord down with a heavy object.

- A damaged power cord may cause an electric shock or fire.



Do not place the power cord or product near heat sources.

- An electric shock or fire may result.



Remove foreign substances such as dust around the plug pins and power socket with a dry cloth.

- Otherwise, a fire may result.

Before Using the Product

Caution



Do not unplug the power cord when the product is in use.

- The product may become damaged by an electric shock.

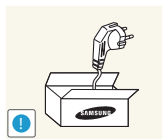

Do not use the power cord for products other than authorized products supplied by Samsung.

- An electric shock or fire may result.

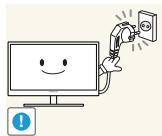

Keep the power socket where the power cord is connected unobstructed.

- If any problem occurs in the product, unplug the power cable to completely cut the power to the product.

Power to the product cannot be completely cut off with the power button.

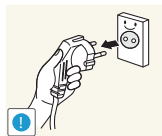

Hold the plug when disconnecting the power cord from the power socket.

- An electric shock or fire may result.

Installation and Safety

Warning



DO NOT PLACE CANDLES, INSECT REPELLANTS OR CIGARETTES ON TOP OF THE PRODUCT. DO NOT INSTALL THE PRODUCT NEAR HEAT SOURCES.

- Otherwise, a fire may result.



Avoid installing the product in a narrow space with bad ventilation, such as a bookshelf or wall closet.

- Otherwise, a fire may result due to an increased internal temperature.

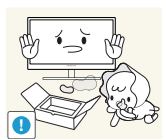

Keep the plastic packaging bag for the product in a place that cannot be reached by children.

- Children may suffocate.

Before Using the Product



Do not install the product on an unstable or vibrating surface (insecure shelf, sloped surface, etc.).

- The product may fall and break or cause a personal injury.
- Using the product in an area with excess vibration may damage the product or cause a fire.



Do not install the product in a vehicle or a place exposed to dust, moisture (water drips, etc.), oil, or smoke.

- An electric shock or fire may result.

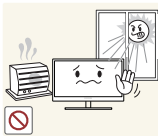

Do not expose the product to direct sunlight, heat, or a hot object such as a stove.

- Otherwise, the product lifespan may be reduced, or a fire may result.



Do not install the product within the reach of young children.

- The product may fall and injure children.



Edible oil, such as soybean oil, can damage or deform the product. Do not install the product in a kitchen or near a kitchen counter.

Caution



Take care not to drop the product when moving it.

- Otherwise, product failure or personal injury may result.



Do not set down the product on its front.

- The screen may become damaged.



When installing the product on a cabinet or shelf, make sure that the bottom edge of the front of the product is not protruding.

- The product may fall and break or cause a personal injury.
- Install the product only on cabinets or shelves of the right size.

Before Using the Product

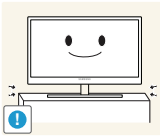

Put down the product carefully.

- The product may fall and break or cause a personal injury.



Installing the product in an unusual place (a place exposed to a lot of fine particles, chemical substances or extreme temperatures, or an airport or train station where the product should operate continuously for an extended period of time) may seriously affect its performance.

- Be sure to consult Samsung Customer Service Center (page 73) before installation if you want to install the product at such a place.

Operation and Safety

Warning



High voltage runs through the product. Do not attempt to disassemble, repair, or modify the product on your own.

- An electric shock or fire may result.
- Contact Samsung Customer Service Center (page 73) for repair.

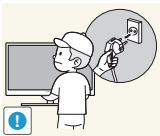

Before you move the product, be sure to turn off the power switch and remove all the cables connected to the product, including the power cord and the antenna cable.

- Otherwise, the power cord may be damaged and a fire or electric shock may result.

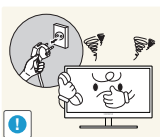

If the product generates a strange noise, a burning smell, or smoke, remove the power cord immediately and contact Samsung Customer Service Center (page 73).

- An electric shock or fire may result.

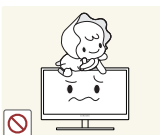

Do not let children hang from the product or climb on top of it.

- The product may fall, and your child may become injured or seriously harmed.



If the product falls or the exterior is damaged, power off the product, remove the power cord, and contact Samsung Customer Service Center (page 73).

- Otherwise, an electric shock or fire may result.

Before Using the Product



Do not put a heavy object, toy, or sweets on top of the product.

- The product or heavy objects may fall as children try to reach for the toy or sweets resulting in a serious injury.

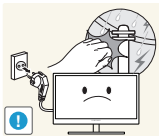

During a lightning or thunderstorm, remove the power cord and do not touch the antenna cable.

- An electric shock or fire may result.

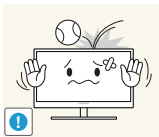

Do not drop objects on the product or apply impact.

- An electric shock or fire may result.

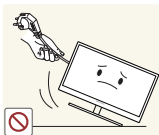

Do not move the product by pulling the power cord or any cable.

- Otherwise, the cable may be damaged and product failure, an electric shock or fire may result.

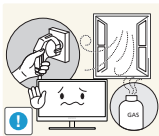

If a gas leakage is found, do not touch the product or power plug. Also, ventilate the area immediately.

- Sparks can cause an explosion or fire.
- During a lightning or thunderstorm, do not touch the power cord or antenna cable.

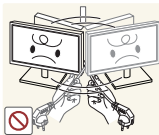

Do not lift or move the product by pulling the power cord or any cable.

- Otherwise, the cable may be damaged and product failure, an electric shock or fire may result.

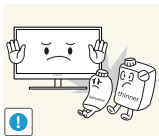

Do not use or keep combustible spray or an inflammable substance near the product.

- An explosion or fire may result.



Ensure the vents are not blocked by tablecloths or curtains.

- Otherwise, a fire may result from an increased internal temperature.

Before Using the Product



Do not insert a metallic object (a chopstick, coin, hair pin, etc.) or inflammable object (paper, match, etc.) into the vent or ports of the product.

- If water or any foreign substance enters the product, be sure to power off the product, remove the power cord, and contact Samsung Customer Service Center (page 73).
- Product failure, an electric shock or fire may result.



Do not place objects containing liquid (vases, pots, bottles, etc) or metallic objects on top of the product.

- If water or any foreign substance enters the product, be sure to power off the product, remove the power cord, and contact Samsung Customer Service Center (page 73).
- Product failure, an electric shock or fire may result.

Caution

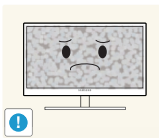

Leaving the screen fixed on a stationary image for an extended period of time may cause afterimage burn-in or defective pixels.

- If you are not going to use the product for an extended period of time, activate power-saving mode or a moving-picture screen saver.

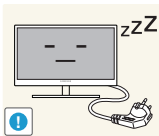

Disconnect the power cord from the power socket if you do not plan on using the product for an extended period of time (vacation, etc.).

- Otherwise, a fire may result from accumulated dust, overheating, an electric shock, or electric leakage.



Use the product at the recommended resolution and frequency.

- Your eyesight may deteriorate.

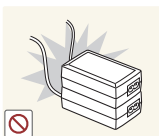

Do not put DC power adapters together.

- Otherwise, a fire may result.



Remove the plastic bag from the DC power adapter before you use it.

- Otherwise, a fire may result.

Before Using the Product



Do not let water enter the DC power adapter or get the adapter wet.

- An electric shock or fire may result.
- Avoid using the product outdoors where it can be exposed to rain or snow.
- Be careful not to get the DC power adapter wet when you wash the floor.



Do not put the DC power adapter near to any heating apparatus.

- Otherwise, a fire may result.

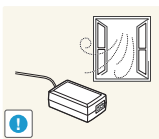

Keep the DC power adapter in a well-ventilated area.

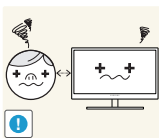

Looking at the screen too close for an extended period of time can deteriorate your eyesight.



Do not hold the monitor upside-down or move it by holding the stand.

- The product may fall and break or cause a personal injury.



Do not use humidifiers or stoves around the product.

- An electric shock or fire may result.

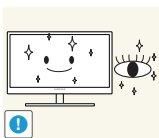

Rest your eyes for more than 5 minutes for every 1 hour of product use.

- Eye fatigue will be relieved.

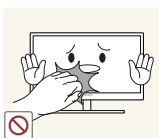

Do not touch the screen when the product has been turned on for an extended period of time as it will become hot.

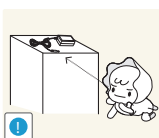

Store the small accessories used with the product out of reach of children.

Before Using the Product



Exercise caution when adjusting the product angle or stand height.

- Otherwise, children's fingers or hands may become stuck and injured.
- Tilting the product excessively may cause it to fall and result in personal injury.

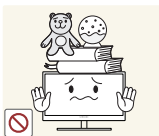

Do not place heavy objects on the product.

- Product failure or personal injury may result.

Correct posture to use the product

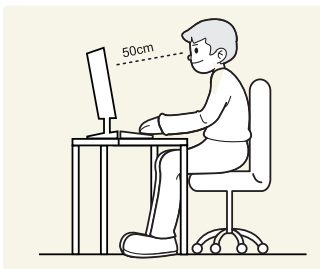

Use the product in the correct posture as follows.

- Straighten your back.
- Allow a distance of 45 to 50cm between your eye and the screen, and look slightly downward at the screen.
Keep your eyes directly in front of the screen.
- Adjust the angle so light does not reflect on the screen.
- Keep your forearms perpendicular to your upper arms and level with the back of your hands.
- Keep your elbows at about a right angle.
- Adjust the height of the product so you can keep your knees bent at 90 degrees or more, your heels attached to the floor, and your arms lower than your heart.

1.1 Checking the Contents

1.1.1 Removing the Packaging

- 1 Open the packaging box. Be careful not to damage the product when you open the packaging with a sharp instrument.

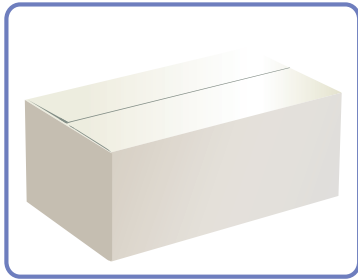

- 2 Remove the styrofoam from the product.

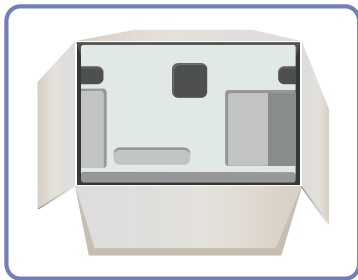

- 3 Check the components and remove the styrofoam and plastic bag.



This image is for reference only.

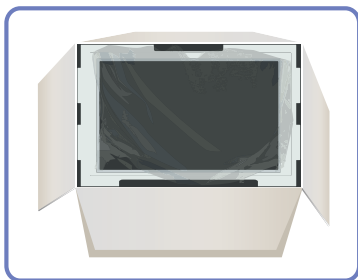

- 4 Store the box in a dry area so that it can be used when moving the product in the future.

1.1.2 Checking the Components



- Contact the dealer from whom you purchased the product if any item is missing.
- The appearance of the components and items sold separately may differ from the image shown.

Components

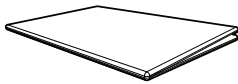

Quick setup guide



Warranty card
(Not available in some locations)

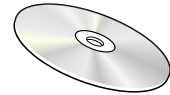

User manual

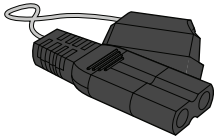

Power cable



DC power adapter

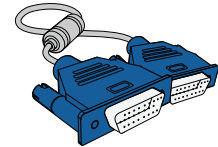

D-SUB cable (optional)

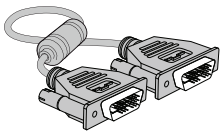

DVI cable (optional)

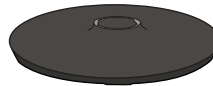

Stand



Stand Connector



Components may vary depending on the country.





1.2 Parts

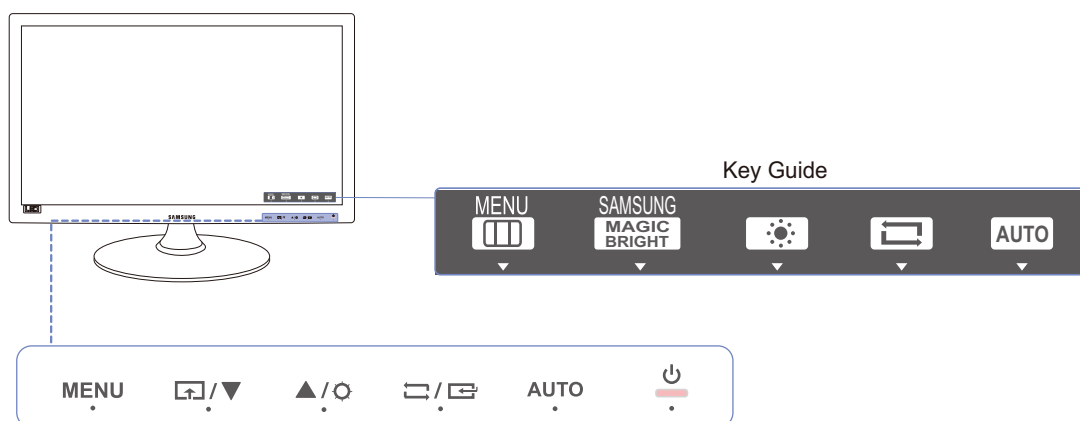

1.2.1 Frontal Buttons

 The color and shape of parts may differ from what is shown. Specifications are subject to change without notice to improve quality.



 This is a touch-type button. Tap the button lightly with a finger.

Icons	Description
<p style="text-align: center;">MENU</p>	<ul style="list-style-type: none"> • Open or close the onscreen display (OSD) menu, or return to the parent menu. • OSD control lock: Maintain the current settings, or lock the OSD control to prevent unintended changes to settings. Enable: To lock the OSD control, press the [MENU] button for 10 seconds. Disable: To unlock the locked OSD control, press the [MENU] button for more than 10 seconds. <p> If the OSD control is locked,</p> <ul style="list-style-type: none"> • Brightness and Contrast, SAMSUNG MAGICBright can be adjusted, and INFORMATION can be viewed. • The Customized Key function can be used by pressing the [] button. (The Customized Key function specified before the OSD control was locked is available even when the OSD control is locked.)
<p style="text-align: center;"></p>	<p>Configure Customized Key and press []. The following options will be enabled.</p> <p>SAMSUNG MAGICBright - Eco Saving - Image Size</p> <p> To configure Customized Key, go to SETUP&RESET → Customized Key and select the mode you want.</p>



Icons	Description
▲/▼	Move to the upper or lower menu or adjust the value for an option on the OSD menu.
☼	Adjust the screen brightness.
□/☞	<p>Confirm a menu selection.</p> <p>Pressing the [□/☞] button when the OSD menu is not displayed will change the input source (Analog/DVI). If you power on the product or change the input source by pressing the [□/☞] button, a message that shows the changed input source will appear at the top left corner of the screen.</p>
AUTO	<p>Press the [AUTO] button to automatically adjust the screen settings.</p> <p> Changing the resolution in Display Properties will activate the Auto Adjustment function.</p>
⏻	Turn the screen on or off.
 (Power lamp)	<p>The power indicator will be lit when the product is operating normally.</p> <p> To reduce power consumption, it is best to remove the power cable when you will not be using the product for an extended period of time.</p>
Key Guide	<p>When a control button on the product is pressed, the Key Guide will be displayed before the onscreen menu opens. (The guide shows the function of the button pressed.)</p> <p>To access the onscreen menu when the guide is displayed, press the corresponding button again.</p> <p>The Key Guide may vary depending on the function or product model. Refer to the actual product.</p>

1.2.2 Reverse Side

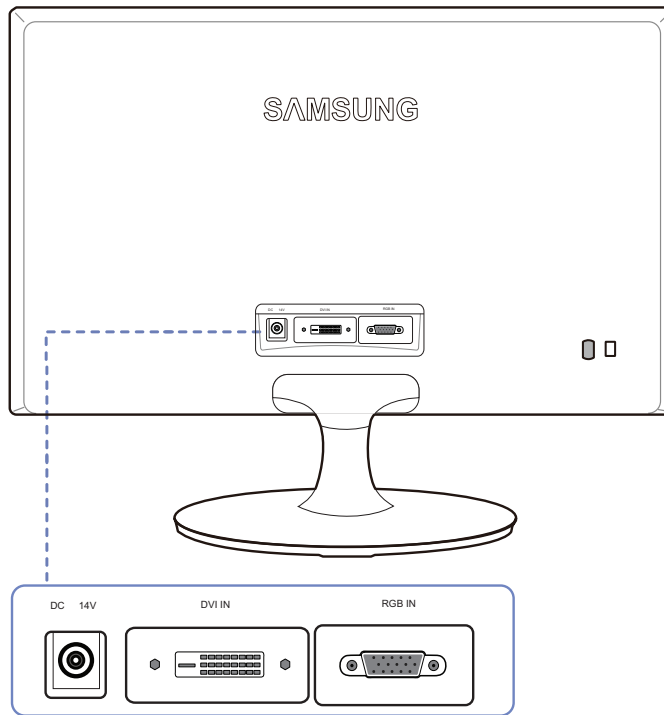

The color and shape of parts may differ from what is shown. Specifications are subject to change without notice to improve quality.

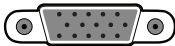

Port	Ports
	Connect to the DC power adapter.
	Connect to a PC using the DVI cable.
	Connect to a PC using the D-SUB cable.

1.3 Installation

1.3.1 Attaching the Stand



Before assembling the product, place the product down on a flat and stable surface so that the screen is facing downwards.

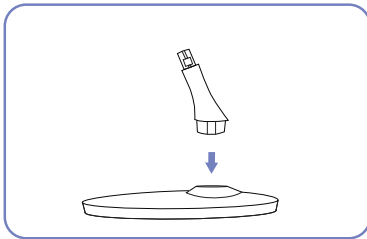

Insert the Stand Connector into the Stand in the direction shown by the figure.

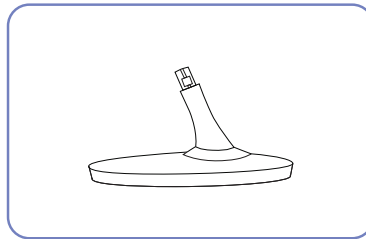

Check if the Stand Connector is firmly connected.

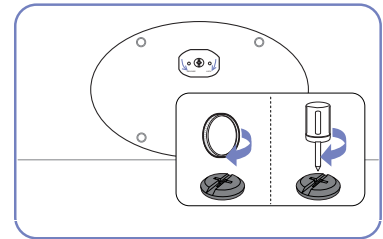

Turn the connecting screw at the bottom of the stand fully so that it is completely fixed.

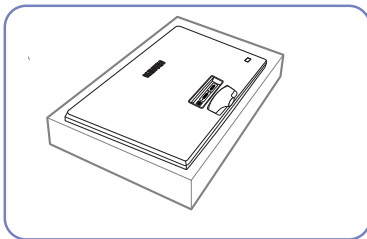

Place a soft cloth over the table to protect the product and place the product onto the cloth so that the front of the product is facing downwards.

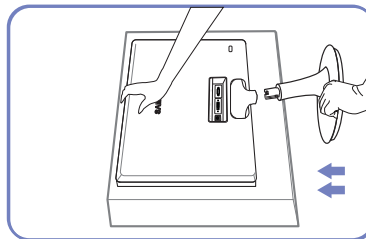

Hold the main body of the product with your hand as shown by the figure.

Push the assembled stand into the main body in the direction of the arrow as shown in the figure.

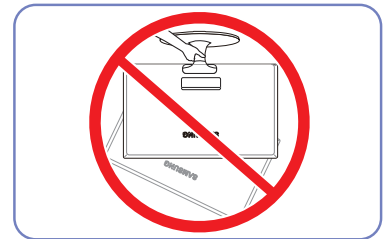

- Caution

Do not hold the product upside down only by the stand.



The color and shape of parts may differ from what is shown. Specifications are subject to change without notice to improve quality.

1.3.2 Adjusting the Product Tilt



The color and shape of parts may differ from what is shown. Specifications are subject to change without notice to improve quality.

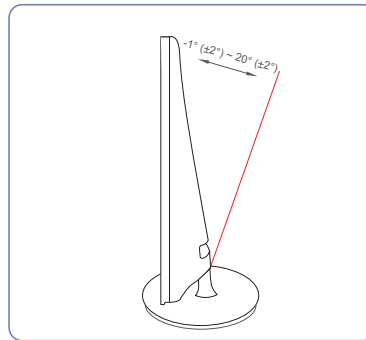

- You can adjust the tilt of your monitor.
- Hold the lower part of the product and adjust the tilt carefully.

1.3.3 Anti-theft Lock

An anti-theft lock allows you to use the product securely even in public places. The locking device shape and locking method depend on the manufacturer. Refer to the user guide provided with your anti-theft locking device for details. The lock device is sold separately.

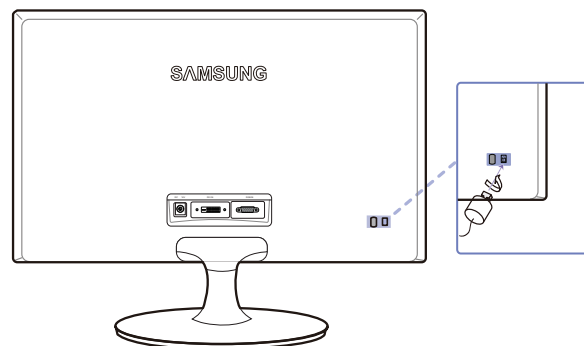

The color and shape of parts may differ from what is shown. Specifications are subject to change without notice to improve quality.

To lock an anti-theft locking device:

- 1 Fix the cable of your anti-theft locking device to a heavy object such as a desk.
- 2 Put one end of the cable through the loop on the other end.
- 3 Insert the locking device into the anti-theft lock slot at the back of the product.
- 4 Lock the locking device.



- An anti-theft locking device can be purchased separately.
- Refer to the user guide provided with your anti-theft locking device for details.
- Anti-theft locking devices can be purchased at electronics retailers or online.

2.1 Before Connecting

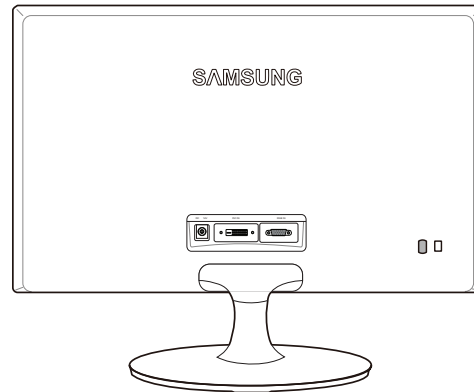

2.1.1 Pre-connection Checkpoints

- Before connecting a source device, read the user manual provided with it. The number and locations of ports on source devices may differ from device to device.
- Do not connect the power cable until all connections are completed. Connecting the power cable during connection may damage the product.
- Check the types of ports at the back of the product you want to connect.

2.2 Connecting the Power

- Connect the power adapter to [DC] jack on the rear of the product. Connect the power cord to the adapter and wall socket. (The input voltage is switched automatically.)

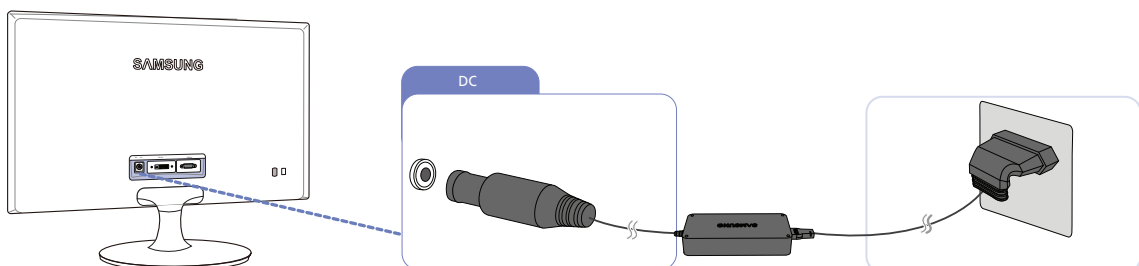

2.3 Connecting and Using a PC

2.3.1 Connecting to a PC

- Select a connection method suitable for your PC.



Connecting parts may differ in different products.

Connection Using the D-SUB Cable (Analogue Type)



Do not connect the power cable before connecting all other cables. Ensure you connect a source device first before connecting the power cable.

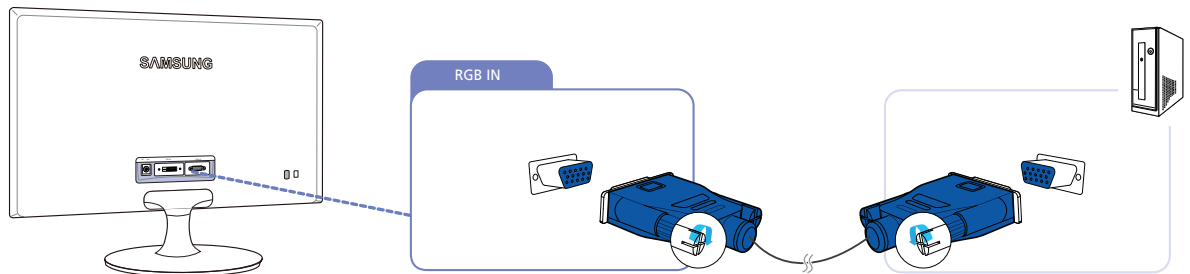

- 1 Connect the D-SUB cable to the [RGB IN] port on the back of the product and the RGB port on the PC.
- 2 Connect the DC power adapter to the product and a power socket. Next, turn on the power switch on the PC.
(For details, refer to "2.2 Connecting the Power".)
- 3 Press [⏏/⏏] to change the input source to **Analog**.

Connection Using the DVI Cable



Do not connect the power cable before connecting all other cables. Ensure you connect a source device first before connecting the power cable.

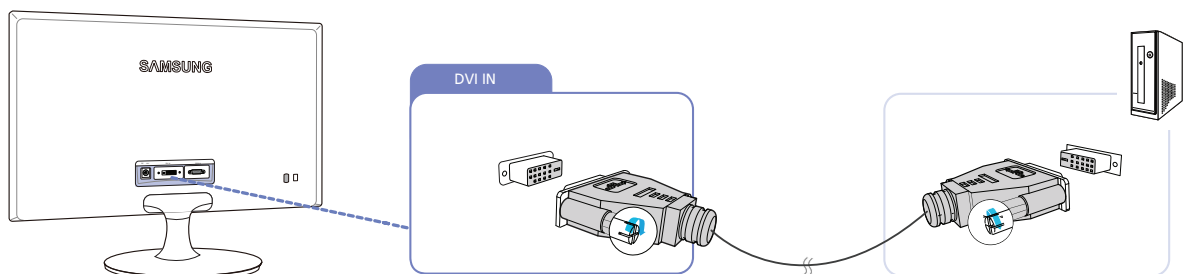

- 1 Connect the DVI cable to the [DVI IN] port on the back of the product and the DVI port on the PC.
- 2 Connect the DC power adapter to the product and a power socket. Next, turn on the power switch on the PC.
(For details, refer to "2.2 Connecting the Power".)
- 3 Press [⏏/⏏] to change the input source to **Digital**.

2.3.2 Driver Installation



- You can set the optimum resolution and frequency for this product by installing the corresponding drivers.
- An installation driver is contained on the CD supplied with the product.
- If the file provided is faulty, visit the Samsung homepage (<http://www.samsung.com>) and download the file.

- 1 Insert the user manual CD provided with the product into the CD-ROM drive.
- 2 Click "Windows Driver".
- 3 Follow the instructions given on the screen to proceed with installation.
- 4 Select your product model from the list of models.

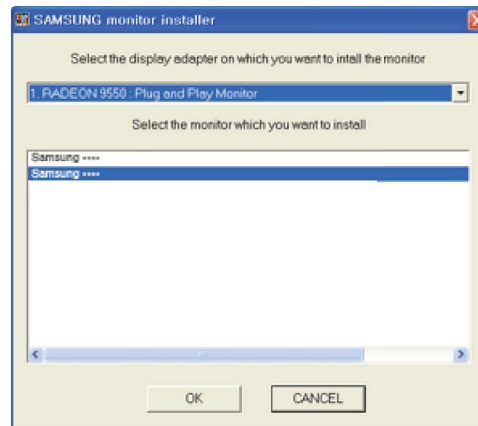

- 5 Go to Display Properties and check that the resolution and refresh rate are appropriate. Refer to your Windows OS manual for further details.

2.3.3 Setting Optimum Resolution

An information message about setting optimum resolution will appear if you power on the product for the first time after purchase.

Select a language and change the resolution to the optimum value.

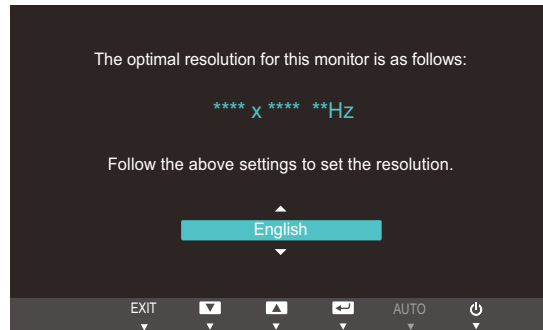

- 1 Press [**▲**/**▼**] to move to the language you want and press [**□**/**↔**].
- 2 To hide the information message, press [**MENU**].



- If the optimum resolution is not selected, the message will appear up to three times for a specified time even when the product is turned off and on again.
- The optimum resolution can also be selected in **Control Panel** on your PC.

2.3.4 Changing the Resolution Using a PC

- Adjust the resolution and refresh rate in Control Panel on your PC to obtain optimum picture quality.
- The picture quality of TFT-LCDs may degrade if the optimum resolution is not selected.

Changing the Resolution on Windows XP

Go to **Control Panel** → **Display** → **Settings** and change the resolution.

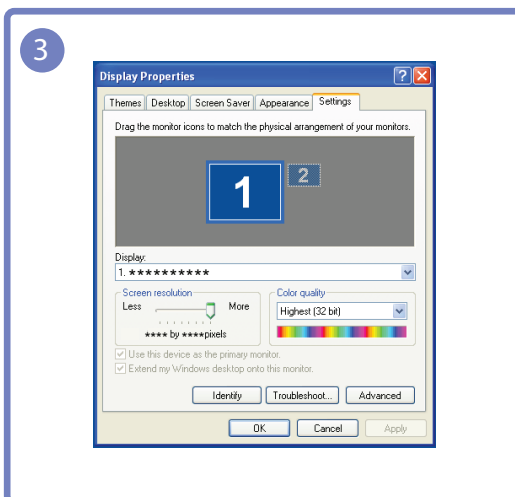
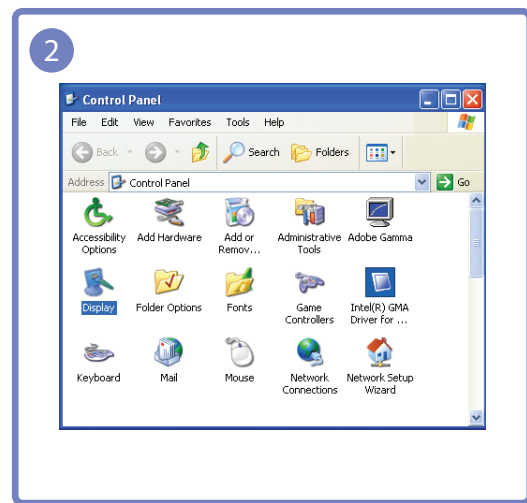
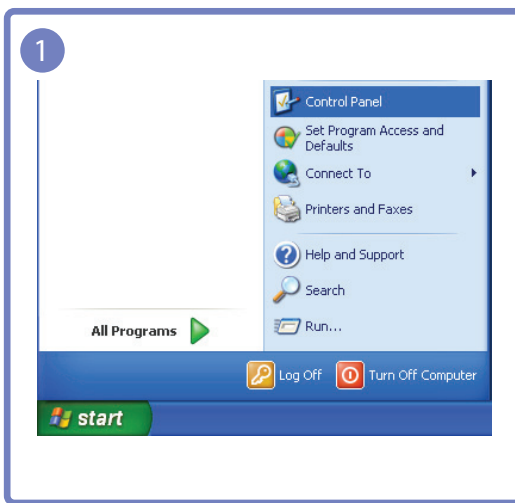

Changing the Resolution on Windows Vista

Go to **Control Panel** → **Personalization** → **Display Settings** and change the resolution.

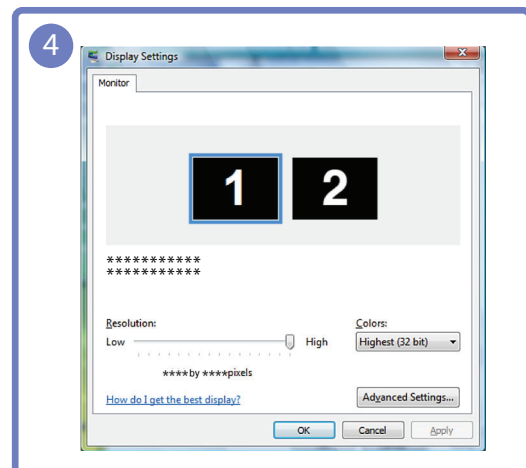
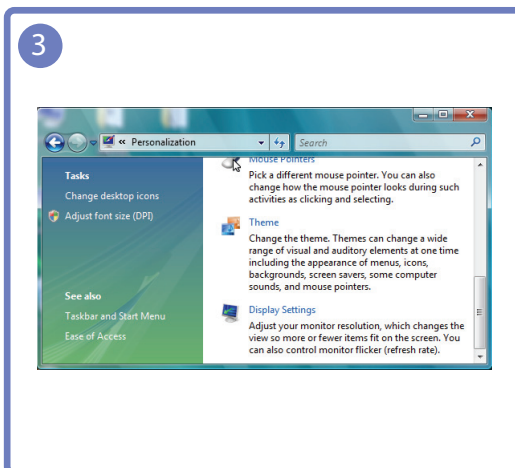
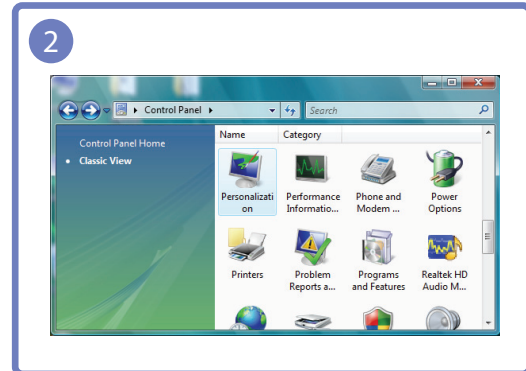
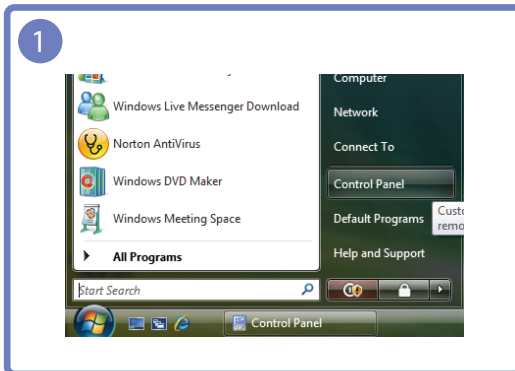

Changing the Resolution on Windows 7

Go to **Control Panel** → **Display** → **Screen Resolution** and change the resolution.

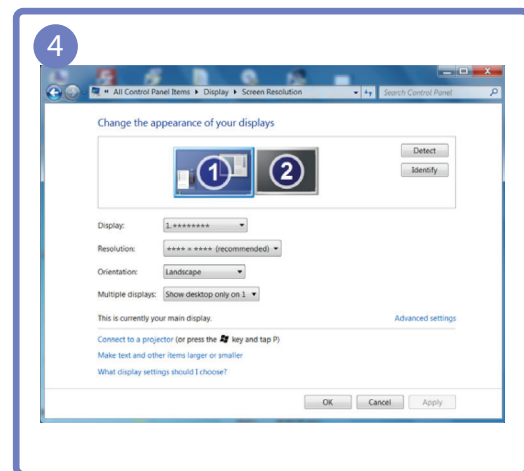
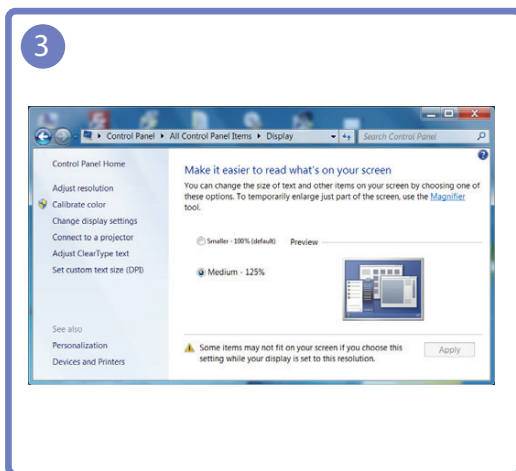
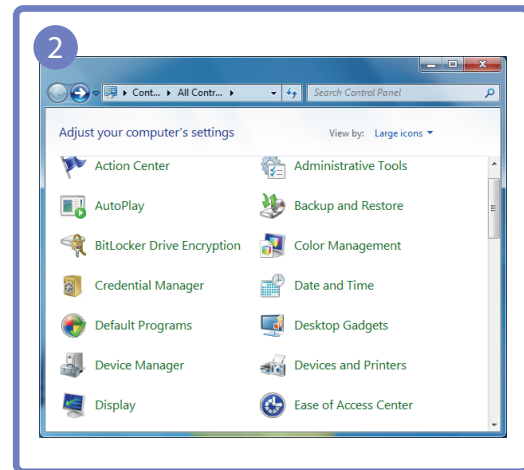
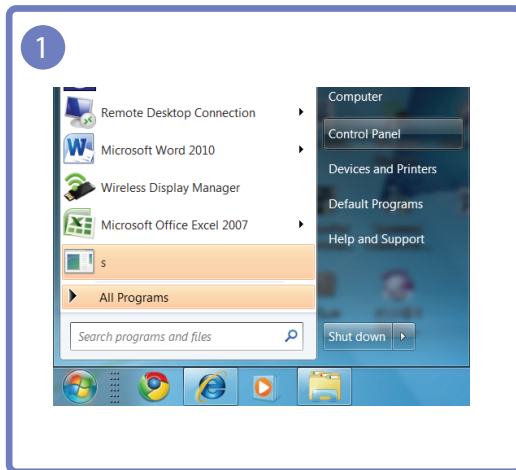

Screen Setup

Configure the screen settings such as brightness and color tone.

3.1 Brightness

You can adjust the general brightness of the picture. (Range: 0~100)

A higher value will make the picture appear brighter.



- This menu is not available when **SAMSUNG MAGIC Bright** is set to **Dynamic Contrast** mode.
- Not available if **Eco Saving** is set to **On**.

3.1.1 Configuring Brightness

- 1 Press any button on the front of the product to display the Key Guide. Next, press [MENU] to display the corresponding menu screen.
- 2 Press [▲/▼] to move to **Picture** and press [□/⊞] on the product.
- 3 Press [▲/▼] to move to **Brightness** and press [□/⊞] on the product. The following screen will appear.

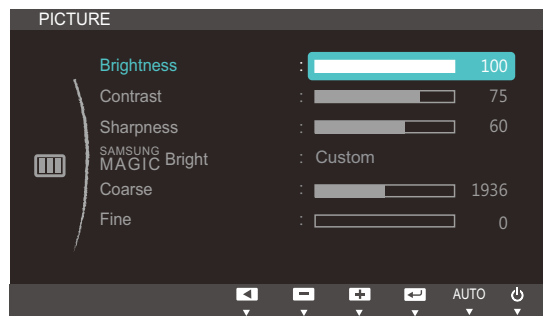

- 4 Adjust the **Brightness** using the [▲/▼] buttons.

3.2 Contrast

Adjust the contrast between the objects and background. (Range: 0~100)

A higher value will increase the contrast to make the object appear clearer.



- This menu is not available when **SAMSUNG MAGIC Bright** is in **Cinema** or **Dynamic Contrast** mode.
- This menu is not available when **SAMSUNG MAGIC Color** is in **Full** or **Intelligent** mode.

3.2.1 Configuring Contrast

- 1 Press any button on the front of the product to display the Key Guide. Next, press [MENU] to display the corresponding menu screen.
- 2 Press [▲/▼] to move to **Picture** and press [□/⏏] on the product.
- 3 Press [▲/▼] to move to **Contrast** and press [□/⏏] on the product. The following screen will appear.

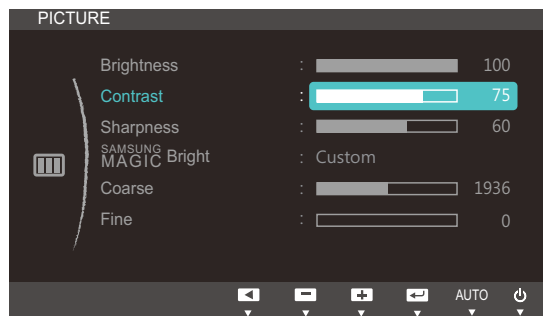

- 4 Adjust the **Contrast** using the [▲/▼] buttons.

3.3 Sharpness

Make the outline of objects more clear or blurry. (Range: 0~100)

A higher value will make the outline of objects clearer.



- This menu is not available when **SAMSUNG MAGIC Bright** is in **Cinema** or **Dynamic Contrast** mode.
- This menu is not available when **SAMSUNG MAGIC Color** is in **Full** or **Intelligent** mode.

3.3.1 Configuring Sharpness

- 1 Press any button on the front of the product to display the Key Guide. Next, press [MENU] to display the corresponding menu screen.
- 2 Press [▲/▼] to move to **Picture** and press [□/⊞] on the product.
- 3 Press [▲/▼] to move to **Sharpness** and press [□/⊞] on the product. The following screen will appear.

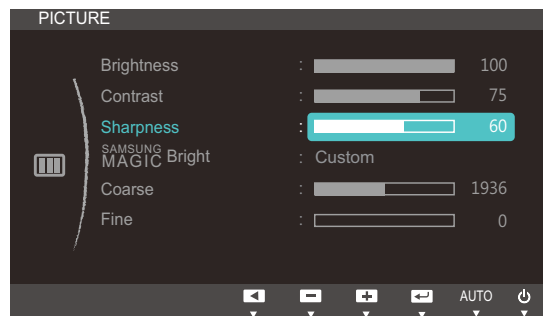

- 4 Adjust the **Sharpness** using the [▲/▼] buttons.

3.4 SAMSUNG MAGIC Bright

This menu provides an optimum picture quality suitable for the environment where the product will be used.

- Not available if **Eco Saving** is set to **On**.

You can customize the brightness to suit your preferences.

3.4.1 Configuring SAMSUNG MAGIC Bright

- 1 Press any button on the front of the product to display the Key Guide. Next, press **[MENU]** to display the corresponding menu screen.
- 2 Press **[▲/▼]** to move to **Picture** and press **[□/⊞]** on the product.
- 3 Press **[▲/▼]** to move to **SAMSUNG MAGIC Bright** and press **[□/⊞]** on the product. The following screen will appear.

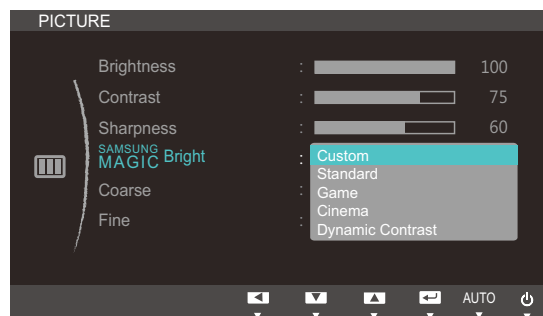

- **Custom:** Customize the contrast and brightness as required.
 - **Standard:** Obtain a picture quality suitable for editing documents or using Internet.
 - **Game:** Obtain a picture quality suitable for playing games that involve many graphic effects and dynamic movements.
 - **Cinema:** Obtain the brightness and sharpness of TVs suitable for enjoying video and DVD content.
 - **Dynamic Contrast:** Obtain balanced brightness through automatic contrast adjustment.
- 4 Press **[▲/▼]** to move to the option you want and press **[□/⊞]**.
 - 5 The selected option will be applied.

3.5 Coarse

Adjust the screen frequency.



This menu is available in **Analog** mode only.

3.5.1 Adjusting Coarse

- 1 Press any button on the front of the product to display the Key Guide. Next, press [MENU] to display the corresponding menu screen.
- 2 Press [▲/▼] to move to **Picture** and press [□/↔] on the product.
- 3 Press [▲/▼] to move to **Coarse** and press [□/↔] on the product. The following screen will appear.

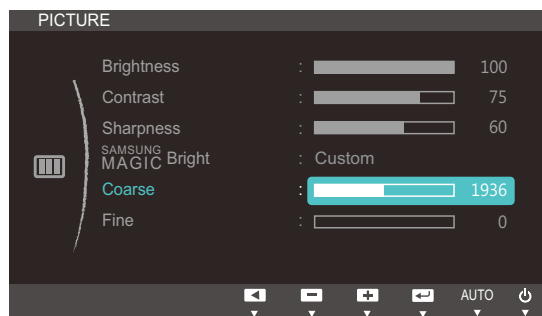

- 4 Adjust the **Coarse** using the [▲/▼] buttons.

3.6 Fine

Fine-adjust the screen to obtain a vivid picture.



This menu is available in **Analog** mode only.

3.6.1 Adjusting Fine

- 1 Press any button on the front of the product to display the Key Guide. Next, press [MENU] to display the corresponding menu screen.
- 2 Press [▲/▼] to move to **Picture** and press [□/⏏] on the product.
- 3 Press [▲/▼] to move to **Fine** and press [□/⏏] on the product. The following screen will appear.

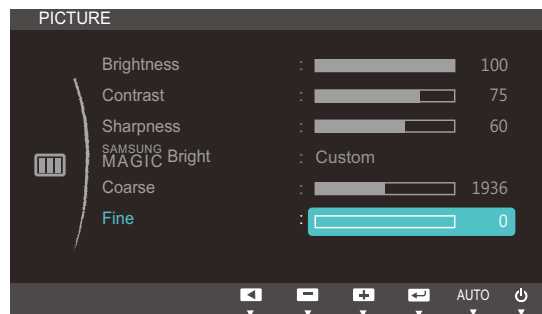

- 4 Adjust the **Fine** using the [▲/▼] buttons.

4

Configuring Tint

Adjust the tint of the screen. This menu is not available when **SAMSUNG MAGICBright** is set to **Cinema** or **Dynamic Contrast** mode.

4.1 SAMSUNG MAGIC Color

SAMSUNG MAGICColor is a new picture-quality improvement technology developed independently by Samsung, which delivers vivid natural colors without picture quality degradation.

4.1.1 Configuring SAMSUNG MAGIC Color

- 1 Press any button on the front of the product to display the Key Guide. Next, press **[MENU]** to display the corresponding menu screen.
- 2 Press **[▲/▼]** to move to **COLOR** and press **[□/⏏]** on the product.
- 3 Press **[▲/▼]** to move to **SAMSUNG MAGICColor** and press **[□/⏏]** on the product. The following screen will appear.

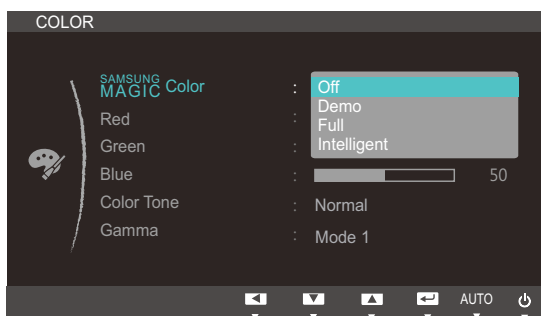

- **Off:** Disable **SAMSUNG MAGICColor**.
 - **Demo:** Compare normal screen mode with **SAMSUNG MAGICColor** mode.
 - **Full:** Obtain a vivid picture quality for all areas including the flesh colors in the picture.
 - **Intelligent:** Improve the chroma for all areas except the flesh colors in the picture.
- 4 Press **[▲/▼]** to move to the option you want and press **[□/⏏]**.
 - 5 The selected option will be applied.

4.2 Red

Adjust the value of the color red in the picture. (Range: 0~100)

A higher value will increase the intensity of the color.



This menu is not available when **SAMSUNG MAGIC Color** is in **Full** or **Intelligent** mode.

4.2.1 Configuring Red

- 1 Press any button on the front of the product to display the Key Guide. Next, press [MENU] to display the corresponding menu screen.
- 2 Press [▲/▼] to move to **COLOR** and press [⏪/⏩] on the product.
- 3 Press [▲/▼] to move to **Red** and press [⏪/⏩] on the product. The following screen will appear.

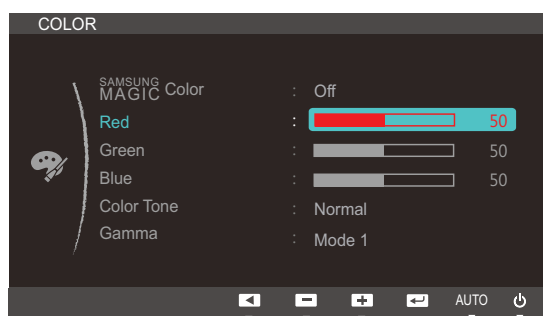

- 4 Adjust the **Red** using the [▲/▼] buttons.

4.3 Green

Adjust the value of the color green in the picture. (Range: 0~100)

A higher value will increase the intensity of the color.



This menu is not available when **SAMSUNG Color** is in **Full** or **Intelligent** mode.

4.3.1 Configuring Green

- 1 Press any button on the front of the product to display the Key Guide. Next, press **[MENU]** to display the corresponding menu screen.
- 2 Press **[▲/▼]** to move to **COLOR** and press **[□/□]** on the product.
- 3 Press **[▲/▼]** to move to **Green** and press **[□/□]** on the product. The following screen will appear.

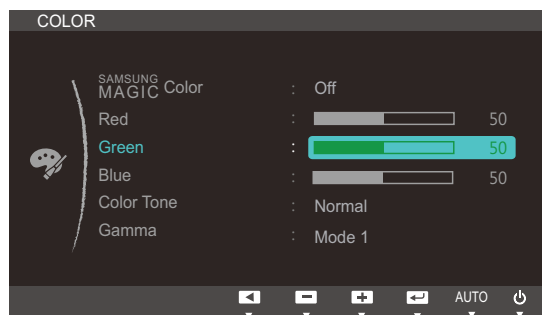

- 4 Adjust the **Green** using the **[▲/▼]** buttons.

4.4 Blue

Adjust the value of the color blue in the picture. (Range: 0~100)

A higher value will increase the intensity of the color.



This menu is not available when **SAMSUNG MAGIC Color** is in **Full** or **Intelligent** mode.

4.4.1 Configuring Blue

- 1 Press any button on the front of the product to display the Key Guide. Next, press **[MENU]** to display the corresponding menu screen.
- 2 Press **[▲/▼]** to move to **COLOR** and press **[□/□]** on the product.
- 3 Press **[▲/▼]** to move to **Blue** and press **[□/□]** on the product. The following screen will appear.

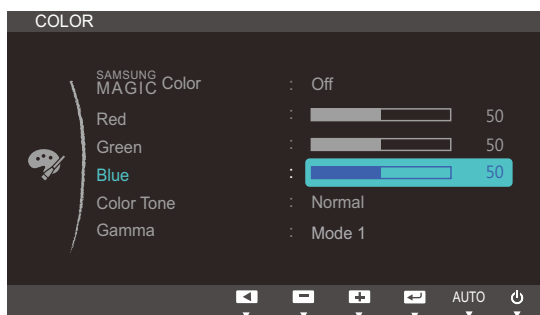

- 4 Adjust the **Blue** using the **[▲/▼]** buttons.

4.5 Color Tone

Adjust the general color tone of the picture.



- This menu is not available when **SAMSUNG MAGIC Color** is in **Full** or **Intelligent** mode.

4.5.1 Configuring the Color Tone Settings

- 1 Press any button on the front of the product to display the Key Guide. Next, press [MENU] to display the corresponding menu screen.
- 2 Press [▲/▼] to move to **COLOR** and press [□/⏏] on the product.
- 3 Press [▲/▼] to move to **Color Tone** and press [□/⏏] on the product. The following screen will appear.

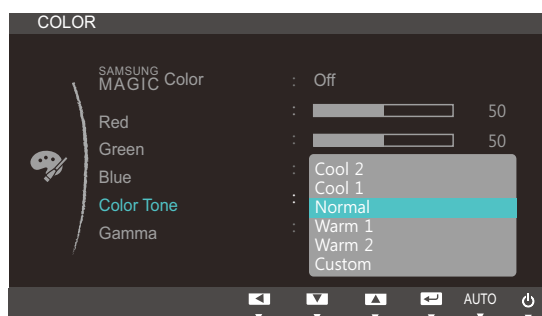

- **Cool 2**: Set the color temperature to be cooler than **Cool 1**.
 - **Cool 1**: Set the color temperature to be cooler than **Normal** mode.
 - **Normal**: Display the standard color tone.
 - **Warm 1**: Set the color temperature to be warmer than **Normal** mode.
 - **Warm 2**: Set the color temperature to be warmer than **Warm 1**.
 - **Custom**: Customize the color tone.
- 4 Press [▲/▼] to move to the option you want and press [□/⏏].
 - 5 The selected option will be applied.

4.6 Gamma

Adjust the mid-range brightness (Gamma) of the picture.

4.6.1 Configuring Gamma

- 1 Press any button on the front of the product to display the Key Guide. Next, press [MENU] to display the corresponding menu screen.
- 2 Press [▲/▼] to move to **COLOR** and press [□/⊞] on the product.
- 3 Press [▲/▼] to move to **Gamma** and press [□/⊞] on the product. The following screen will appear.

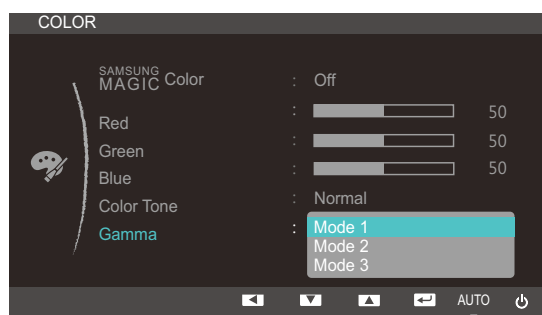

- 4 Press [▲/▼] to move to the option you want and press [□/⊞].
- 5 The selected option will be applied.

5.1 H-Position & V-Position

H-Position: Move the screen to the left or right.

V-Position: Move the screen up or down.



- Available only when **Image Size** is set to **Screen Fit**.
- This menu is available in **Analog** mode only.

5.1.1 Configuring H-Position & V-Position

- 1 Press any button on the front of the product to display the Key Guide. Next, press [MENU] to display the corresponding menu screen.
- 2 Press [▲/▼] to move to **SIZE&POSITION** and press [□/☞] on the product.
- 3 Press [▲/▼] to move to **H-Position** or **V-Position**, and press [□/☞]. The following screen will appear.

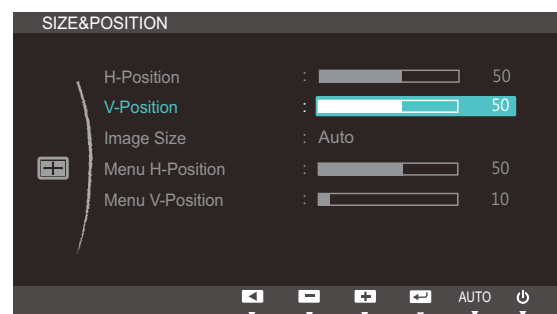
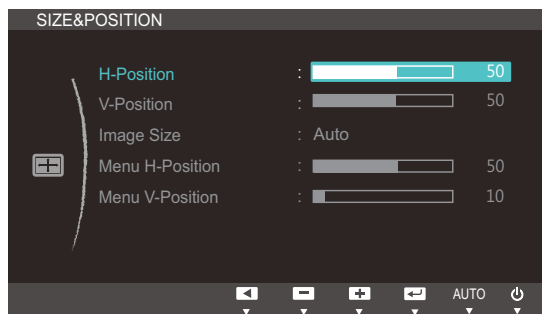

- 4 Press [▲/▼] to configure **H-Position** or **V-Position**.

5.2 Image Size

Change the picture size.

5.2.1 Changing the Image Size

- 1 Press any button on the front of the product to display the Key Guide. Next, press [MENU] to display the corresponding menu screen.
- 2 Press [▲/▼] to move to **SIZE&POSITION** and press [□/↔] on the product.
- 3 Press [▲/▼] to move to **Image Size** and press [□/↔] on the product. The following screen will appear.



- **Auto**: Display the picture according to the aspect ratio of the input source.
- **Wide**: Display the picture in full screen regardless of the aspect ratio of the input source.

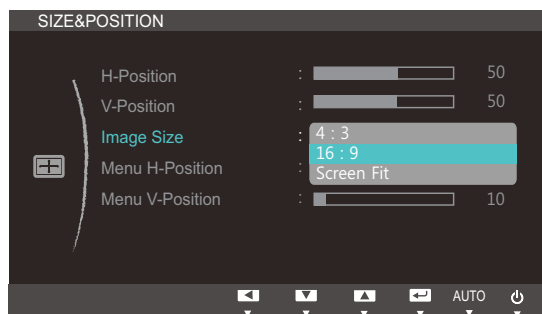

- **4:3**: Display the picture with an aspect ratio of 4:3. Suitable for videos and standard broadcasts.
- **16:9**: Sets the picture to 16:9 wide mode.
- **Screen Fit**: Display the picture with the original aspect ratio without cutting off.

-  Changing the screen size is available when the following conditions are satisfied.
- A digital output device is connected using the DVI cable.
 - The input signal is 480p, 576p, 720p, or 1080p.

- 4 Press [▲/▼] to move to the option you want and press [□/↔].
- 5 The selected option will be applied.

5.3 Menu H-Position & Menu V-Position

Menu H-Position: Move the menu position to the left or right.

Menu V-Position: Move the menu position up or down.

5.3.1 Configuring Menu H-Position & Menu V-Position

- 1 Press any button on the front of the product to display the Key Guide. Next, press [MENU] to display the corresponding menu screen.
- 2 Press [▲/▼] to move to **SIZE&POSITION** and press [□/⇄] on the product.
- 3 Press [▲/▼] to move to **Menu H-Position** or **Menu V-Position**, and press [□/⇄]. The following screen will appear.

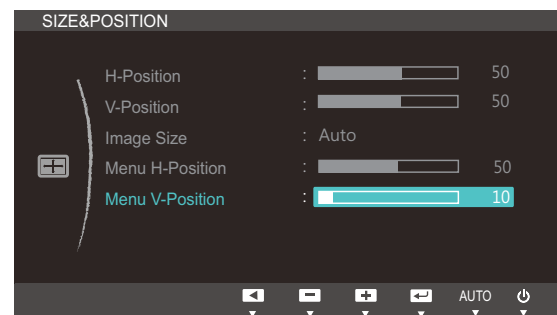
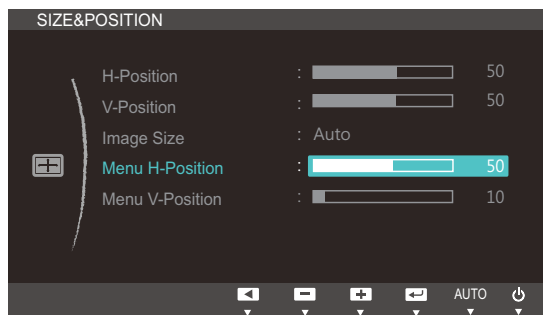

- 4 Press [▲/▼] to configure **Menu H-Position** or **Menu V-Position**.

6.1 Reset

Return all the settings for the product to the default factory settings.

6.1.1 Initializing Settings (Reset)

- 1 Press any button on the front of the product to display the Key Guide. Next, press [MENU] to display the corresponding menu screen.
- 2 Press [▲/▼] to move to **SETUP&RESET** and press [□/⊞] on the product.
- 3 Press [▲/▼] to move to **Reset** and press [□/⊞] on the product. The following screen will appear.

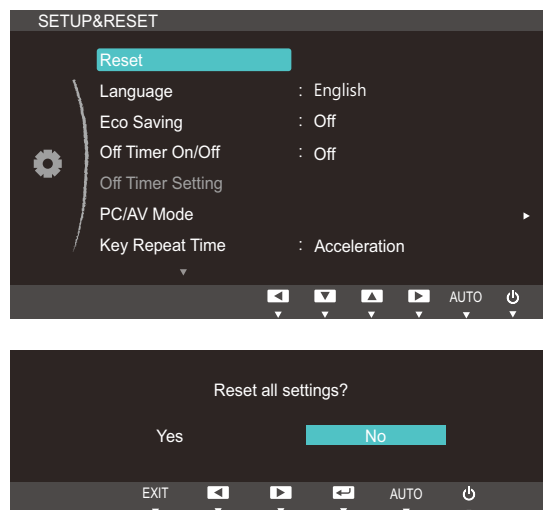

- 4 Press [▲/▼] to move to the option you want and press [□/⊞].
- 5 The selected option will be applied.

6.2 Language

Set the menu language.



- A change to the language setting will only be applied to the onscreen menu display.
- It will not be applied to other functions on your PC.

6.2.1 Changing the Language

- 1 Press any button on the front of the product to display the Key Guide. Next, press **[MENU]** to display the corresponding menu screen.
- 2 Press **[▲/▼]** to move to **SETUP&RESET** and press **[□/☞]** on the product.
- 3 Press **[▲/▼]** to move to **Language** and press **[□/☞]** on the product. The following screen will appear.

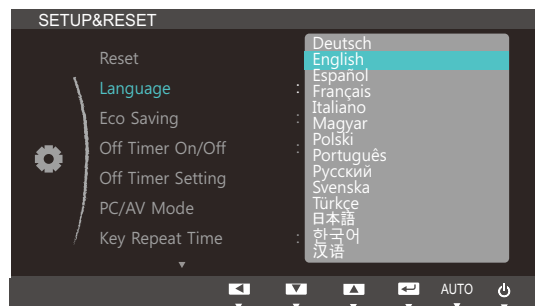

- 4 Press **[▲/▼]** to move to the language you want and press **[□/☞]**.
- 5 The selected option will be applied.

6.3 Eco Saving

The **Eco Saving** function reduces power consumption by controlling the electric current used by the monitor panel.



This menu is not available when **SAMSUNG MAGIC Bright** is in **Dynamic Contrast** mode.

6.3.1 Configuring Eco Saving

- 1 Press any button on the front of the product to display the Key Guide. Next, press **[MENU]** to display the corresponding menu screen.
- 2 Press **[▲/▼]** to move to **SETUP&RESET** and press **[□/⏏]** on the product.
- 3 Press **[▲/▼]** to move to **Eco Saving** and press **[□/⏏]** on the product. The following screen will appear.

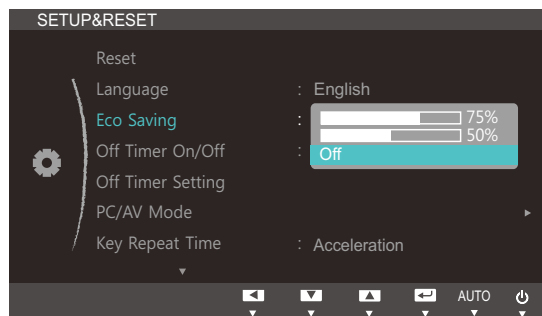

- **75%** : Change the monitor power consumption to 75% of the default level.
 - **50%** : Change the monitor power consumption to 50% of the default level.
 - **Off**: Deactivate the **Eco Saving** function.
- 4 Press **[▲/▼]** to move to the option you want and press **[□/⏏]**.
 - 5 The selected option will be applied.

6.4 Off Timer On/Off

You can set the product to automatically turn off.

6.4.1 Configuring Off Timer On/Off

- 1 Press any button on the front of the product to display the Key Guide. Next, press [MENU] to display the corresponding menu screen.
- 2 Press [▲/▼] to move to **SETUP&RESET** and press [□/⏏] on the product.
- 3 Press [▲/▼] to move to **Off Timer On/Off** and press [□/⏏] on the product. The following screen will appear.

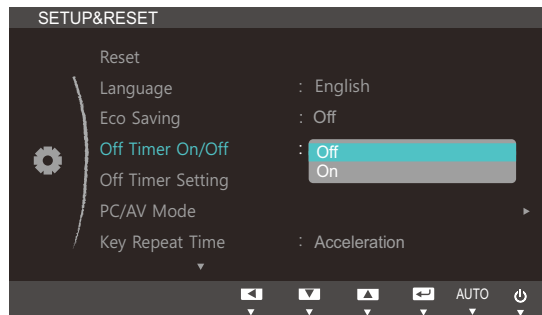

- **Off:** Deactivate the off timer so that the product does not power off automatically.
 - **On:** Activate the off timer so that the product powers off automatically.
- 4 Press [▲/▼] to move to the option you want and press [□/⏏].
 - 5 The selected option will be applied.

6.5 Off Timer Setting

The off timer can be set within a range of 1 to 23 hours. The product will automatically power off after the specified number of hours.



This menu is available only when **Off Timer On/Off** is set to **On**.

6.5.1 Configuring Off Timer Setting

- 1 Press any button on the front of the product to display the Key Guide. Next, press **[MENU]** to display the corresponding menu screen.
- 2 Press **[▲/▼]** to move to **SETUP&RESET** and press **[□/⏏]** on the product.
- 3 Press **[▲/▼]** to move to **Off Timer Setting** and press **[□/⏏]** on the product. The following screen will appear.

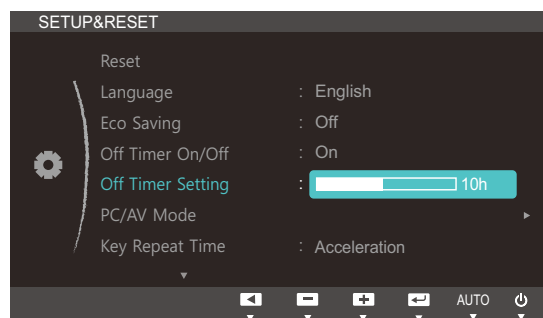

- 4 Press **[▲/▼]** to configure **Off Timer Setting**.

6.6 PC/AV Mode

Set **PC/AV Mode** to **AV**. The picture size will be enlarged. This option is useful when you view a movie.

6.6.1 Configuring PC/AV Mode

- 1 Press any button on the front of the product to display the Key Guide. Next, press [MENU] to display the corresponding menu screen.
- 2 Press [▲/▼] to move to **SETUP&RESET** and press [□/⏏] on the product.
- 3 Press [▲/▼] to move to **PC/AV Mode** and press [□/⏏] on the product. The following screen will appear.

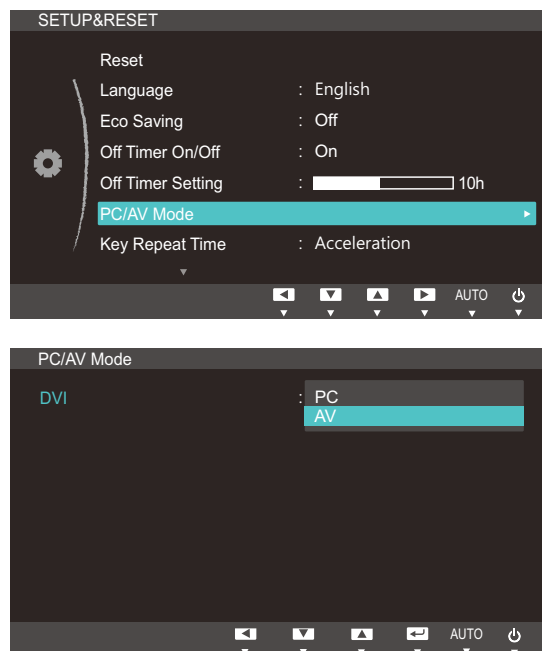

- 4 Press [▲/▼] to move to the option you want and press [□/⏏].
- 5 The selected option will be applied.

6.7 Key Repeat Time

Control the response rate of a button when the button is pressed.

6.7.1 Configuring Key Repeat Time

- 1 Press any button on the front of the product to display the Key Guide. Next, press [MENU] to display the corresponding menu screen.
- 2 Press [▲/▼] to move to **SETUP&RESET** and press [□/☞] on the product.
- 3 Press [▲/▼] to move to **Key Repeat Time** and press [□/☞] on the product. The following screen will appear.

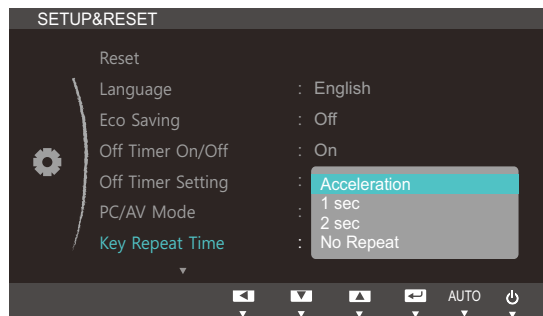

- **Acceleration, 1 sec, or 2 sec** can be selected. If **No Repeat** is selected, a command responds only once when a button is pressed.
- 4 Press [▲/▼] to move to the option you want and press [□/☞].
 - 5 The selected option will be applied.

6.8 Customized Key

You can customize **Customized Key** as follows.

6.8.1 Configuring Customized Key

- 1 Press any button on the front of the product to display the Key Guide. Next, press [MENU] to display the corresponding menu screen.
- 2 Press [▲/▼] to move to **SETUP&RESET** and press [□/⊞] on the product.
- 3 Press [▲/▼] to move to **Customized Key** and press [□/⊞] on the product. The following screen will appear.

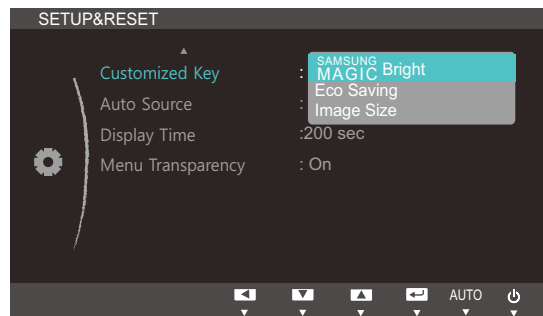

- **SAMSUNG MAGIC Bright - Eco Saving - Image Size**
- 4 Press [▲/▼] to move to the option you want and press [□/⊞].
 - 5 The selected option will be applied.

6.9 Auto Source

You can activate **Auto Source**.

6.9.1 Configuring Auto Source

- 1 Press any button on the front of the product to display the Key Guide. Next, press [MENU] to display the corresponding menu screen.
- 2 Press [▲/▼] to move to **SETUP&RESET** and press [□/⏏] on the product.
- 3 Press [▲/▼] to move to **Auto Source** and press [□/⏏] on the product. The following screen will appear.

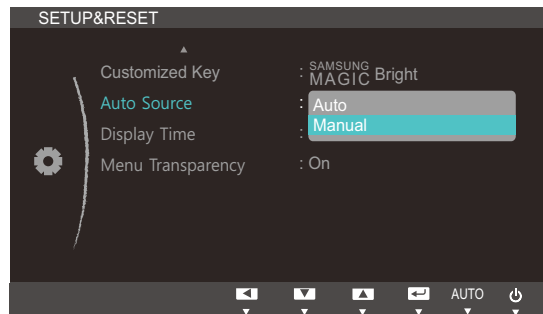

- **Auto:** The input source is automatically recognized.
 - **Manual:** Manually select an input source.
- 4 Press [▲/▼] to move to the option you want and press [□/⏏].
 - 5 The selected option will be applied.

6.10 Display Time

Set the on-screen display (OSD) menu to automatically disappear if the menu is not used for a specified period of time.

Display Time can be used to specify the time after which you want the OSD menu to disappear.

6.10.1 Configuring Display Time

- 1 Press any button on the front of the product to display the Key Guide. Next, press **[MENU]** to display the corresponding menu screen.
- 2 Press **[▲/▼]** to move to **SETUP&RESET** and press **[□/⏏]** on the product.
- 3 Press **[▲/▼]** to move to **Display Time** and press **[□/⏏]** on the product. The following screen will appear.

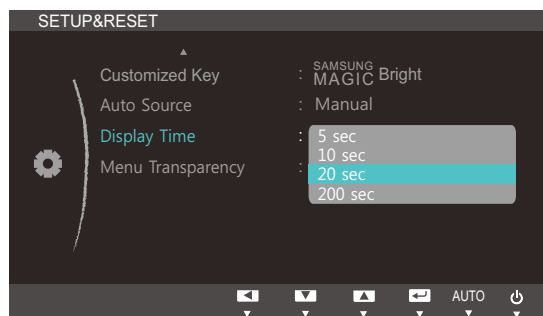

- 4 Press **[▲/▼]** to move to the option you want and press **[□/⏏]**.
- 5 The selected option will be applied.

6.11 Menu Transparency

Set the transparency for the menu windows:

6.11.1 Changing Menu Transparency

- 1 Press any button on the front of the product to display the Key Guide. Next, press [MENU] to display the corresponding menu screen.
- 2 Press [▲/▼] to move to **SETUP&RESET** and press [□/☞] on the product.
- 3 Press [▲/▼] to move to **Menu Transparency** and press [□/☞] on the product. The following screen will appear.

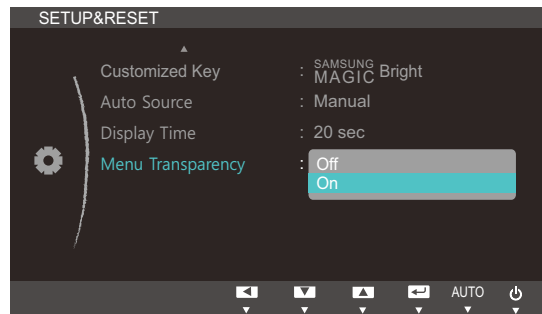

- 4 Press [▲/▼] to move to the option you want and press [□/☞].
- 5 The selected option will be applied.

7.1 INFORMATION

View the current input source, frequency and resolution.

7.1.1 Displaying INFORMATION

- 1 Press any button on the front of the product to display the Key Guide. Next, press [MENU] to display the corresponding menu screen.
- 2 Press [▲/▼] to move to **INFORMATION**. The current input source, frequency and resolution will appear.



The displayed menu items may vary depending on the model.

8.1 Magic Tune



8.1.1 What is MagicTune?



MagicTune is a software program that helps with monitor adjustments by providing comprehensive descriptions of monitor functions and easy-to-understand guidelines.

You can adjust the product with the mouse and the keyboard without using the operating buttons of the product.

8.1.2 Installing the Software

- 1 Insert the installation CD into the CD-ROM drive.
- 2 Select the MagicTune setup program.
 -  If the pop-up screen for the software installation does not appear on the main screen, find and double-click the MagicTune setup file on the CD-ROM.
- 3 Select the installation language and click [Next].
- 4 Complete the remaining software installation steps according to the instructions displayed on the screen.
 - 
 - The software may not work properly if you do not restart the computer after the installation.
 - The MagicTune icon may not appear depending on the computer system and the product specifications.
 - If the shortcut icon does not appear, press the F5 key.

Restrictions and Problems with the Installation (MagicTune™)

The installation of MagicTune™ may be affected by the graphics card, motherboard and the networking environment.

System Requirements

OS

- Windows XP, Windows Vista, Windows 7

8.1.3 Removing the Software

You can only remove MagicTune™ through [Add or Remove Programs] in Windows.

To remove MagicTune™, complete the following steps.

- 1 Click [Start] select [Settings], and select [Control Panel] from the menu.
For Windows XP, click [Start], and select [Control Panel] from the menu.
- 2 Double-click the [Add or Remove Programs] icon in the Control Panel.
- 3 In the [Add/Remove] window, find and select MagicTune™ so that it is highlighted.
- 4 Click [Change or Remove Programs] to remove the software.
- 5 Select [Yes] to start removing MagicTune™.
- 6 Wait until a message box appears informing you that the software has been removed completely.



For technical support, the FAQ (frequently asked questions) or information about the software upgrade for MagicTune™, please visit our website(http://www.samsung.com/us/consumer/learningresources/monitor/magetune/pop_intro.html).

8.2 MultiScreen



MultiScreen enables users to use the monitor by partitioning multiple sections.

8.2.1 Installing the Software

1 Insert the installation CD into the [CD-ROM drive].

2 Select the "MultiScreen" setup program.



If the pop-up screen for the software installation does not appear on the main screen, find and double-click the "MultiScreen" setup file on the [CD-ROM].

3 When the Installation Wizard appears, click [**N**ext].

4 Follow the instructions given on the screen to proceed with installation.



- The software may not work properly if you do not restart the computer after the installation.
- The "MultiScreen" icon may not appear depending on the computer system and the product specifications.
- If the shortcut icon does not appear, press the "F5" key.

Restrictions and Problems with the Installation (MultiScreen)

The "MultiScreen" installation may be affected by the [Graphics card], [Motherboard] and the [Networking environment].

Operating System

"OS"

- "Windows 2000"
- "Windows XP Home Edition"
- "Windows XP Professional"
- "Windows Vista 32bit"
- "Windows 7 32bit"



For "MultiScreen", the operating systems "Windows 2000" or later is recommended.

"Hardware"

- At least 32MB of memory
- At least 60MB of free space on the hard disk drive

8.2.2 Removing the Software

Click **[Start]**, select **[Settings]/[Control Panel]**, and then double-click **[Add or Remove Programs]**.

Select "MultiScreen" from the program list and click the **[Add/Delete]** button.

9.1 Requirements Before Contacting Samsung Customer Service Center

9.1.1 Testing the Product



Before calling Samsung Customer Service Center, test your product as follows. If the problem persists, contact Samsung Customer Service Center.

Check if your product is operating normally by using the product test function.

If the screen is turned off and the power indicator blinks even though the product is properly connected to a PC, perform a self-diagnosis test.

- 1 Power off both the PC and product.
- 2 Disconnect the cables from the product.
- 3 Power on the product.
- 4 If the message "**Check Signal Cable**" appears, the product is working normally.



If the screen remains blank, check the PC system, video controller and cable.

9.1.2 Checking the Resolution and Frequency

For a mode that exceeds the supported resolution (refer to "10.3 Standard Signal Mode Table"), the message "**Not Optimum Mode**" will appear for a short time.

9.1.3 Check the following.

Installation issue (PC mode)	
The screen keeps switching on and off.	Check the cable connection between the product and PC, and ensure the connectors are locked. (Refer to "2.3 Connecting and Using a PC")
Screen issue	
The power LED is off. The screen will not switch on.	Check that the power cable is connected properly. (Refer to "2.3 Connecting and Using a PC")
The message " Check Signal Cable " appears.	Check that the cable is properly connected to the product. (Refer to "2.3 Connecting and Using a PC")
	Check that the device connected to the product is powered on.

Screen issue	
"Not Optimum Mode" is displayed.	This message appears if the signal from the graphics card exceeds the maximum resolution or frequency for the product.
	Change the maximum resolution and frequency to suit the product performance, referring to Standard Signal Mode Table (page 70).
The images on the screen look distorted.	Check the cable connection to the product (Refer to "2.3 Connecting and Using a PC")
The screen is not clear. The screen is blurry.	Adjust Coarse (page 36) and Fine (page 37).
	Remove any accessories (video extension cable, etc.) and try again.
	Set the resolution and frequency to the recommended level. (Refer to "10.1 General")
The screen appears unstable and shaky.	Check that the resolution and frequency for the PC are within the range of resolution and frequency compatible with the product. Next, if required, change the settings, referring to Standard Signal Mode Table (page 70) in this manual and the INFORMATION menu on the product.
There are shadows or ghost images left on the screen.	
The screen is too bright. The screen is too dark.	Adjust Brightness (page 32) and Contrast (page 33).
Screen color is inconsistent.	Change the COLOR settings. (Refer to "Configuring Tint")
The colors on the screen have a shadow and are distorted.	Change the COLOR settings. (Refer to "Configuring Tint")
White does not really look white.	Change the COLOR settings. (Refer to "Configuring Tint")
There is no image on the screen and the power LED blinks every 0.5 to 1 second.	The product is operating in power-saving mode.
	Press any key on the keyboard or move the mouse to return to normal operating mode.
Source device issue	
A beeping sound is heard when my PC is booting.	If a beeping sound is heard when your PC is booting, have your PC serviced.

9.2 Q & A

Question	Answer
How can I change the frequency?	<p>Set the frequency on your graphics card.</p> <ul style="list-style-type: none">• Windows XP: Go to Control Panel → Appearance and Themes → Display → Settings → Advanced → Monitor, and adjust Refresh rate under Monitor settings.• Windows ME/2000: Go to Control Panel → Display → Settings → Advanced → Monitor, and adjust Refresh rate under Monitor settings.• Windows Vista: Go to Control Panel → Appearance and Personalization → Personalization → Display Settings → Advanced Settings → Monitor, and adjust Refresh rate under Monitor settings.• Windows 7: Go to Control Panel → Appearance and Personalization → Display → Screen Resolution → Advanced settings → Monitor, and adjust Refresh rate under Monitor settings.



Question	Answer
<p>How can I change the resolution?</p>	<ul style="list-style-type: none"> • Windows XP: Go to Control Panel → Appearance and Themes → Display → Settings, and adjust the resolution. • Windows ME/2000: Go to Control Panel → Display → Settings, and adjust the resolution. • Windows Vista: Go to Control Panel → Appearance and Personalization → Personalize → Display Settings, and adjust the resolution. • Windows 7: Go to Control Panel → Appearance and Personalization → Display → Adjust Resolution, and adjust the resolution.
<p>How do I set power-saving mode?</p>	<ul style="list-style-type: none"> • Windows XP: Set power-saving mode in Control Panel → Appearance and Themes → Display → Screen Saver Settings or BIOS SETUP on the PC. • Windows ME/2000: Set power-saving mode in Control Panel → Display → Screen Saver Settings or BIOS SETUP on the PC. • Windows Vista: Set power-saving mode in Control Panel → Appearance and Personalization → Personalize → Screen Saver Settings or BIOS SETUP on the PC. • Windows 7: Set power-saving mode in Control Panel → Appearance and Personalization → Personalize → Screen Saver Settings or BIOS SETUP on the PC.



Refer to the user manual for your PC or graphics card for further instructions on adjustment.

10.1 General

Model Name		S19B150B	S24B150BL
Panel	Size	18.5 Inches (47 cm)	23.6 Inches (59 cm)
	Display area	409.8 mm (H) x 230.4 mm (V)	521.28 mm (H) x 293.22 mm (V)
Synchronization	Horizontal Frequency	30 ~ 81 kHz	
	Vertical Frequency	56 ~ 75 kHz	
Display Color		16.7M	
Resolution	Optimum Resolution	1366x768@60Hz	1920x1080@60Hz
	Maximum Resolution	1366x768@60Hz	1920x1080@60Hz
Maximum Pixel Clock		95MHz (Analog,Digital)	89MHz (Analog,Digital)
Power Supply		This product uses 100 to 240V. Refer to the label at the back of the product as the standard voltage can vary in different countries.	
Signal connectors		15pin-to-15pin D-sub cable, Detachable DVI-D to DVI-D connector, Detachable	
Dimensions (W x H x D) / Weight	Without Stand	445 x 273 x 53 mm 17.5 x 10.7 x 2.1 Inches	569 x 342 x 53 mm 22.4 x 13.5 x 2.1 Inches
	With Stand	445 x 348 x 177 mm / 2.1 kg 17.5 x 13.7 x 7.0 Inches / 4.6 lbs	569 x 416 x 197 mm / 3.6 kg 22.4 x 16.4 x 7.8 Inches / 7.9 lbs
Environmental considerations	Operating	Temperature : 50°F – 104°F (10°C – 40°C) Humidity : 10 % – 80 %, non-condensing	
	Storage	Temperature : -4°F – 113°F (-20°C – 45°C) Humidity : 5 % – 95 %, non-condensing	
Plug-and-Play		This monitor can be installed and used with any Plug-and-Play compatible systems. Two-way data exchange between the monitor and PC system optimizes the monitor settings. Monitor installation takes place automatically. However, you can customize the installation settings if desired.	
Panel Dots (Pixels)		Due to the nature of the manufacturing of this product, approximately 1 pixel per million (1ppm) may be brighter or darker on the LCD panel. This does not affect product performance.	

-  The above specifications are subject to change without notice to improve quality.
-  This device is a Class B digital apparatus.

(USA only)

Dispose unwanted electronics through an approved recycler.

To find the nearest recycling location, go to our website:

www.samsung.com/recyclingdirect or call, (877) 278 - 0799

10.2 PowerSaver

The power-saving function of this product reduces power consumption by switching off the screen and changing the color of the power LED if the product is not used for a specified period of time. The power is not turned off in power-saving mode. To switch the screen back on, press any key on the keyboard or move the mouse. Power-saving mode functions only when the product is connected to a PC that has a power-saving function.

PowerSaver	Normal operation mode	Power saving mode	Power off (Power button)
Power Indicator	On	Blinking	Off
Power Consumption (S19B150B)	20 watts	Typical 0.3 watts	Typical 0.3 watts
Power Consumption (S24B150BL)	30 watts	Typical 0.3 watts	Typical 0.3 watts



- The power consumption level can vary in different operating conditions or when settings are changed.
- To reduce the power consumption to 0 watts, turn off the power switch on the back of the product or disconnect the power cable. Be sure to disconnect the power cable when you will not be using the product for an extended period of time. To reduce the power consumption to 0 watts when the power switch is not available, disconnect the power cable.

10.3 Standard Signal Mode Table



- This product can be set to only one resolution for each screen size to obtain the optimum picture quality due to the nature of the panel. Therefore, a resolution other than the specified resolution may degrade the picture quality. To avoid this, it is recommended that you select the optimum resolution specified for the screen size of your product.
- Check the frequency when you exchange a CDT monitor (connected to a PC) for an LCD monitor. If the LCD monitor does not support 85Hz, change the vertical frequency to 60Hz using the CDT monitor before you exchange it with the LCD monitor.

If a signal that belongs to the following standard signal modes is transmitted from your PC, the screen will automatically be adjusted. If the signal transmitted from the PC does not belong to the standard signal modes, the screen may be blank even though the power LED turns on. In such a case, change the settings according to the following table by referring to the graphics card user manual.

S19B150B

Resolution	Horizontal Frequency (kHz)	Vertical Frequency (Hz)	Pixel Clock (MHz)	Sync Polarity (H/V)
IBM, 720 X 400	31.469	70.087	28.322	-/+
MAC, 640 x 480	35.000	66.667	30.240	-/-
MAC, 832 x 624	49.726	74.551	57.284	-/-
VESA, 640 x 480	31.469	59.940	25.175	-/-
VESA, 640 x 480	37.861	72.809	31.500	-/-
VESA, 640 x 480	37.500	75.000	31.500	-/-
VESA, 800 x 600	35.156	56.250	36.000	+/+
VESA, 800 x 600	37.879	60.317	40.000	+/+
VESA, 800 x 600	48.077	72.188	50.000	+/+
VESA, 800 x 600	46.875	75.000	49.500	+/+
VESA, 1024 x 768	48.363	60.004	65.000	-/-
VESA, 1024 x 768	56.476	70.069	75.000	-/-
VESA, 1024 x 768	60.023	75.029	78.750	+/+
VESA, 1366 x 768	47.712	59.790	85.500	+/+
VESA, 1280 x 720	45.000	60.000	74.250	+/+



Specifications

S24B150BL

Resolution	Horizontal Frequency (kHz)	Vertical Frequency (Hz)	Pixel Clock (MHz)	Sync Polarity (H/V)
IBM, 720 x 400	31.469	70.087	28.322	-/+
VESA DMT, 640 x 480	31.469	59.940	25.175	-/-
MAC, 640 x 480	35.000	66.667	30.240	-/-
VESA DMT, 640 x 480	37.861	72.809	31.500	-/-
VESA DMT, 640 x 480	37.500	75.000	31.500	-/-
VESA DMT, 800 x 600	35.156	56.25	36	+/+
VESA DMT, 800 x 600	37.879	60.317	40.000	+/+
VESA DMT, 800 x 600	48.077	72.188	50.000	+/+
VESA DMT, 800 x 600	46.875	75.000	49.500	+/+
MAC, 832 x 624	49.726	74.551	57.284	-/-
VESA DMT, 1024 x 768	48.363	60.004	65.000	-/-
VESA DMT, 1024 x 768	56.476	70.069	75.000	-/-
VESA DMT, 1024 x 768	60.023	75.029	78.750	+/+
VESA DMT, 1152 x 864	67.500	75.000	108.000	+/+
MAC, 1152 x 870	68.681	75.062	100.000	-/-
VESA DMT, 1280 x 720	45.000	60.000	74.250	+/+
VESA DMT, 1280 x 800	49.702	59.810	83.500	-/+
VESA DMT, 1280 x 1024	63.981	60.020	108.000	+/+
VESA DMT, 1280 x 1024	79.976	75.025	135.000	+/+
VESA DMT, 1440 x 900	55.935	59.887	106.500	-/+
VESA DMT, 1600 x 900	60.000	60.000	108.000	+/+
VESA DMT, 1680 x 1050	65.290	59.954	146.250	-/+
VESA DMT, 1920 x 1080	67.500	60.000	148.500	+/+



- Horizontal Frequency

The time required to scan a single line from the left to the right side of the screen is called a horizontal cycle. The reciprocal number of a horizontal cycle is called horizontal frequency. Horizontal frequency is measured in kHz.

- Vertical Frequency

Repeating the same picture dozens of times per second allows you to view natural pictures. The repeat frequency is called "vertical frequency" or "refresh rate" and is indicated in Hz.

Contact SAMSUNG WORLDWIDE



If you have any questions or comments relating to Samsung products, please contact the SAMSUNG customer care center.

NORTH AMERICA		
U.S.A	1-800-SAMSUNG (726-7864)	http://www.samsung.com
CANADA	1-800-SAMSUNG (726-7864)	http://www.samsung.com/ca http://www.samsung.com/ca_fr (French)
MEXICO	01-800-SAMSUNG (726-7864)	http://www.samsung.com

LATIN AMERICA		
ARGENTINA	0800-333-3733	http://www.samsung.com
BRAZIL	0800-124-421 4004-0000	http://www.samsung.com
BOLIVIA	800-10-7260	http://www.samsung.com
CHILE	800-SAMSUNG(726-7864) From mobile 02-482 82 00	http://www.samsung.com
COLOMBIA	01-8000112112	http://www.samsung.com
COSTA RICA	0-800-507-7267	http://www.samsung.com
DOMINICA	1-800-751-2676	http://www.samsung.com
ECUADOR	1-800-10-7267	http://www.samsung.com
EL SALVADOR	800-6225	http://www.samsung.com
GUATEMALA	1-800-299-0013	http://www.samsung.com
HONDURAS	800-27919267	http://www.samsung.com
JAMAICA	1-800-234-7267	http://www.samsung.com
NICARAGUA	00-1800-5077267	http://www.samsung.com
PANAMA	800-7267	http://www.samsung.com
PERU	0-800-777-08	http://www.samsung.com
PUERTO RICO	1-800-682-3180	http://www.samsung.com
TRINIDAD & TOBAGO	1-800-SAMSUNG(726-7864)	http://www.samsung.com
VENEZUELA	0-800-100-5303	http://www.samsung.com

Appendix

EUROPE		
ALBANIA	42 27 5755	http://www.samsung.com
AUSTRIA	0810 - SAMSUNG (7267864, € 0.07/min)	http://www.samsung.com
BELGIUM	02-201-24-18	http://www.samsung.com/be (Dutch) http://www.samsung.com/be_fr (French)
BOSNIA	05 133 1999	http://www.samsung.com
BULGARIA	07001 33 11	http://www.samsung.com
CROATIA	062 SAMSUNG (062 726 7864)	http://www.samsung.com
CZECH	800 - SAMSUNG (800-726786)	http://www.samsung.com
	Samsung Electronics Czech and Slovak, s.r.o., Oasis Florenc, Sokolovská 394/17, 180 00, Praha 8	
DENMARK	70 70 19 70	http://www.samsung.com
FINLAND	030 - 6227 515	http://www.samsung.com
FRANCE	01 48 63 00 00	http://www.samsung.com
GERMANY	01805 - SAMSUNG (726-7864 € 0,14/Min)	http://www.samsung.com
CYPRUS	From landline : 8009 4000	http://www.samsung.com
GREECE	From landline : 80111- SAMSUNG (7267864) From landline & mobile : (+30) 210 6897691	http://www.samsung.com
HUNGARY	06-80-SAMSUNG(726-7864)	http://www.samsung.com
ITALIA	800-SAMSUNG(726-7864)	http://www.samsung.com
KOSOVO	+381 0113216899	http://www.samsung.com
LUXEMBURG	261 03 710	http://www.samsung.com
MACEDONIA	023 207 777	http://www.samsung.com
MONTENEGRO	020 405 888	http://www.samsung.com
NETHERLANDS	0900-SAMSUNG (0900-7267864) (€ 0,10/Min)	http://www.samsung.com
NORWAY	815-56 480	http://www.samsung.com
POLAND	0 801-1SAMSUNG(172-678) +48 22 607-93-33	http://www.samsung.com

Appendix

EUROPE		
PORTUGAL	808 20-SAMSUNG (808 20 7267)	http://www.samsung.com
RUMANIA	From landline : 08010-SAMSUNG (7267864) From landline & mobile : (+40) 21 206 01 10	http://www.samsung.com
SERBIA	0700 Samsung (0700 726 7864)	http://www.samsung.com
SLOVAKIA	0800 - SAMSUNG (0800-726 786)	http://www.samsung.com
SPAIN	902 - 1 - SAMSUNG (902 172 678)	http://www.samsung.com
SWEDEN	0771 726 7864 (SAMSUNG)	http://www.samsung.com
SWITZERLAND	0848 - SAMSUNG (7267864, CHF 0.08/min)	http://www.samsung.com/ch http://www.samsung.com/ch_fr (French)
U.K	0330 SAMSUNG (7267864)	http://www.samsung.com
EIRE	0818 717100	http://www.samsung.com
LITHUANIA	8-800-77777	http://www.samsung.com
LATVIA	8000-7267	http://www.samsung.com
ESTONIA	800-7267	http://www.samsung.com
TURKEY	444 77 11	http://www.samsung.com

CIS		
RUSSIA	8-800-555-55-55	http://www.samsung.com
GEORGIA	8-800-555-555	http://www.samsung.com
ARMENIA	0-800-05-555	http://www.samsung.com
AZERBAIJAN	088-55-55-555	http://www.samsung.com
KAZAKHSTAN	8-10-800-500-55-500 (GSM: 7799)	http://www.samsung.com
UZBEKISTAN	8-10-800-500-55-500	http://www.samsung.com
KYRGYZSTAN	00-800-500-55-500	http://www.samsung.com
TADJIKISTAN	8-10-800-500-55-500	http://www.samsung.com
MONGOLIA		http://www.samsung.com

Appendix

CIS		
UKRAINE	0-800-502-000	http://www.samsung.com/ua http://www.samsung.com/ua_ru
BELARUS	810-800-500-55-500	http://www.samsung.com
MOLDOVA	00-800-500-55-500	http://www.samsung.com

ASIA PACIFIC		
AUSTRALIA	1300 362 603	http://www.samsung.com
NEW ZEALAND	0800 SAMSUNG (0800 726 786)	http://www.samsung.com
CHINA	400-810-5858	http://www.samsung.com
HONG KONG	(852) 3698-4698	http://www.samsung.com/hk http://www.samsung.com/hk_en/
INDIA	1800 1100 11 3030 8282 1800 3000 8282 1800 266 8282	http://www.samsung.com
INDONESIA	0800-112-8888 021-5699-7777	http://www.samsung.com
JAPAN	0120-327-527	http://www.samsung.com
MALAYSIA	1800-88-9999	http://www.samsung.com
PHILIPPINES	1-800-10-SAMSUNG (726-7864) for PLDT 1-800-3-SAMSUNG(726-7864) for Digitel 1-800-8-SAMSUNG(726-7864) for Globe 02-5805777	http://www.samsung.com
SINGAPORE	1800-SAMSUNG (726-7864)	http://www.samsung.com
THAILAND	1800-29-3232 02-689-3232	http://www.samsung.com
TAIWAN	0800-329-999 0266-026-066	http://www.samsung.com
VIETNAM	1 800 588 889	http://www.samsung.com

MIDDLE EAST		
IRAN	021-8255	http://www.samsung.com
OMAN	800-SAMSUNG(726-7864)	http://www.samsung.com
KUWAIT	183-2255	http://www.samsung.com
BAHRAIN	8000-4726	http://www.samsung.com
EGYPT	08000-726786	http://www.samsung.com
JORDAN	800-22273	http://www.samsung.com
MOROCCO	080 100 2255	http://www.samsung.com
SAUDI ARABIA	9200-21230	http://www.samsung.com
U.A.E	800-SAMSUNG (726-7864)	http://www.samsung.com

AFRICA		
CAMEROON	7095- 0077	http://www.samsung.com
COTE D' IVOIRE	8000 0077	http://www.samsung.com
GHANA	0800-10077 0302-200077	http://www.samsung.com
KENYA	0800 724 000	http://www.samsung.com
NIGERIA	0800-726-7864	http://www.samsung.com
SENEGAL	800-00-0077	http://www.samsung.com
SOUTH AFRICA	0860-SAMSUNG (726-7864)	http://www.samsung.com
TANZANIA	0685 88 99 00	http://www.samsung.com
UGANDA	0800 300 300	http://www.samsung.com

Responsibility for the Pay Service (Cost to Customers)



When the service is requested, in spite of in warranty, we may charge you for a visit from a service technician in the following cases.

Not a product defect

Cleaning of the product, Adjustment, Explanation, Re-installation and etc.

- If a service technician gives instructions on how to use TV or simply adjusts options without disassembling product.
- If a defect is caused by external environmental factors (Internet, Antenna, Wired Signal, etc.)
- If a product is reinstalled or devices are connected additionally after installing the purchased product for the first time.
- If a product is reinstalled to move to a different spot or to move to a different house.
- If customer requests instructions on how to use because of another company's product.
- If customer requests instructions on how to use the network or another company's program.
- If customer requests software installation and setup for the product.
- If a service technician removes/cleans dusts or foreign materials inside of the product.
- If customer requests an installation additionally after purchasing a product through home-shopping or online.

A Product damage caused by customer's fault

Product damage caused by customer's mishandling or wrong repair.

If a product damage is caused by;

- external impact or drop .
- use of supplies or separately sold product unspecified by Samsung.
- repair from a person besides an engineer of outsourcing service company or partner of Samsung Electronics Co., Ltd.
- remodeling or repairing the product by customer.
- using it with incorrect voltage or non-authorized electrical connections.
- not following the "cautions" in User Manual.

Others

- If product fails by natural disaster (lightning, fire, earthquake, flood damage, etc) .
- If consumable components are all used up (Battery, Toner, Fluorescent lights, Head, Vibrator, Lamp, Filter, Ribbon, etc.)



If customer requests a service in case the product has no defect, service fee may be charged. So please read User Manual first.

Correct Disposal

Correct Disposal of This Product (Waste Electrical & Electronic Equipment)



(Applicable in the European Union and other European countries with separate collection systems)

This marking on the product, accessories or literature indicates that the product and its electronic accessories (e.g. charger, headset, USB cable) should not be disposed of with other household waste at the end of their working life. To prevent possible harm to the environment or human health from uncontrolled waste disposal, please separate these items from other types of waste and recycle them responsibly to promote the sustainable reuse of material resources.

Household users should contact either the retailer where they purchased this product, or their local government office, for details of where and how they can take these items for environmentally safe recycling.

Business users should contact their supplier and check the terms and conditions of the purchase contract. This product and its electronic accessories should not be mixed with other commercial wastes for disposal.

Terminology

OSD(On Screen Display)

On screen display (OSD) allows you to configure on-screen settings to optimize the picture quality as required. It allows you to change the screen brightness, tint, size and many other settings using menus displayed on the screen.

Gamma

The Gamma menu adjusts the grey scale that represents middle tones on the screen. Adjusting the brightness brightens the whole screen, but adjusting Gamma only brightens the medium brightness.

Grey scale

Scale refers to levels of color intensity that show variations of color change from darker areas to brighter areas on the screen. Changes to the screen brightness are expressed with black and white variation, and grey scale refers to the medium area between black and white. Changing the grey scale through Gamma adjustment will change the medium brightness on the screen.

Scanning rate

Scanning rate, or refresh rate, refers to the frequency of screen refreshes. Screen data is transmitted as it refreshes to display an image, although the refreshing is invisible to the naked eye. The number of screen refreshes is called scanning rate and is measured in Hz. A scanning rate of 60Hz means that the screen refreshes 60 times per second. The screen scanning rate depends on the performance of the graphics cards in your PC and monitor.

Horizontal Frequency

Characters or images displayed on the monitor screen consist of numerous dots (pixels). Pixels are transmitted in horizontal lines, which are then arranged vertically to create an image. The horizontal frequency is measured in kHz and represents how many times horizontal lines per second are transmitted and displayed on the monitor screen. A horizontal frequency of 85 means that the horizontal lines that make up an image are transmitted 85 000 times per second, and the horizontal frequency is indicated in 85kHz.

Vertical Frequency

One image is made of numerous horizontal lines. The vertical frequency is measured in Hz and represents how many images can be created per second by those horizontal lines. A vertical frequency of 60 means that an image is transmitted 60 times per second. The vertical frequency is also called "refresh rate" and affects screen flicker.

Resolution

Resolution is the number of horizontal pixels and vertical pixels that form a screen. It represents the level of display detail.

A higher resolution displays a greater amount of information on the screen and is suitable for performing multiple tasks at the same time.

E.g. A resolution of 1920 x 1080 consists of 1,920 horizontal pixels (horizontal frequency) and 1,080 vertical lines (vertical resolution).

Plug & Play

The Plug & Play feature allows the automatic exchange of information between a monitor and PC to produce an optimum display environment.

The monitor uses VESA DDC (international standard) to execute Plug & Play.

Index

A

Appendix 73
Auto Source 55

B

Before Connecting 25
Blue 41
Brightness 32

C

Checking the Contents 18
Cleaning 8
Coarse 36
Color Tone 42
Connecting and Using a PC 26
Contact SAMSUNG WORLDWIDE 73
Contrast 33
Copyright 7
Correct Disposal 79
Correct posture to use the product 17
Customized Key 54

D

Display Time 56

E

Eco Saving 49

F

Fine 37

G

Gamma 43
General 67

Green 40

I

Image Size 45
INFORMATION 58
Installation 23

K

Key Repeat Time 53

L

Language 48

M

Menu Transparency 57
MultiScreen 61

O

Off Timer OnOff 50
Off Timer Setting 51

P

Parts 20
PC/AV Mode 52

Q

Q & A 65

R

Red 39
Requirements Before Contacting Samsung
Customer Service Center 63
Reset 47

Index

Responsibility for the Pay Service (Cost to Customers) 78

S

Safety Precautions 10

SAMSUNG MAGIC Bright 35

SAMSUNG MAGIC Color 38

Sharpness 34

Standard Signal Mode Table 70