

Quick Installation Guide

For product or function details, please visit www.tendacn.com

Dual Band Gigabit WiFi Router

AC19/AC23

(AC23 is used for illustration in this guide)

Package contents

- Wireless router * 1
- Power adapter * 1
- Ethernet cable * 1
- Quick installation guide * 1



To get the App for management, scan the QR code, or search for Tenda WiFi in App Store/Google Play

I. Connect your router

If you want to copy the PPPoE user name and password from your original router, start from **Step 1**. Otherwise, start from **Step 2**.

Step 1: Import your PPPoE user name and password from your original router.

1. Power on your original and new routers.
2. Connect the WAN port of the original router to a LAN port (port 1, 2, 3, and IPTV/4 for AC19; port 1, 2, IPTV/3 for AC23) of the new router using an Ethernet cable.
3. When the WAN and LAN LED indicators of the new router turn solid on for 3 seconds after blinking fast, the PPPoE user name and password are imported to your new router successfully.
4. Remove the original router.

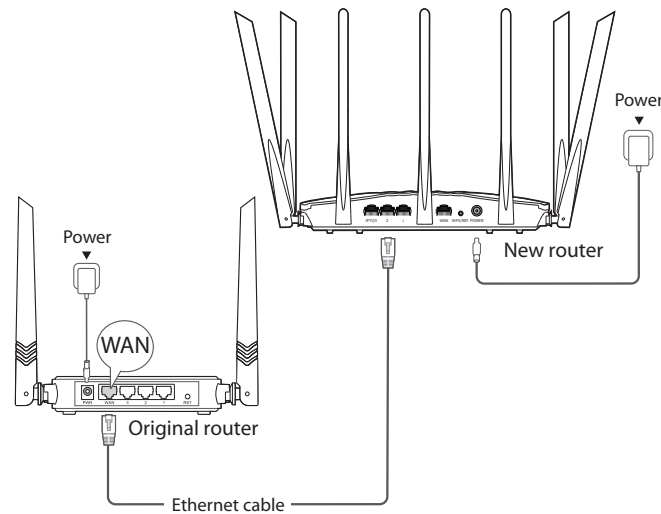

Step 2: Connect your new router to the internet.

1. Power on the new router.
2. Connect the WAN port of the new router to the LAN port of your modem or the Ethernet jack using an Ethernet cable. The WAN LED indicator lights on.

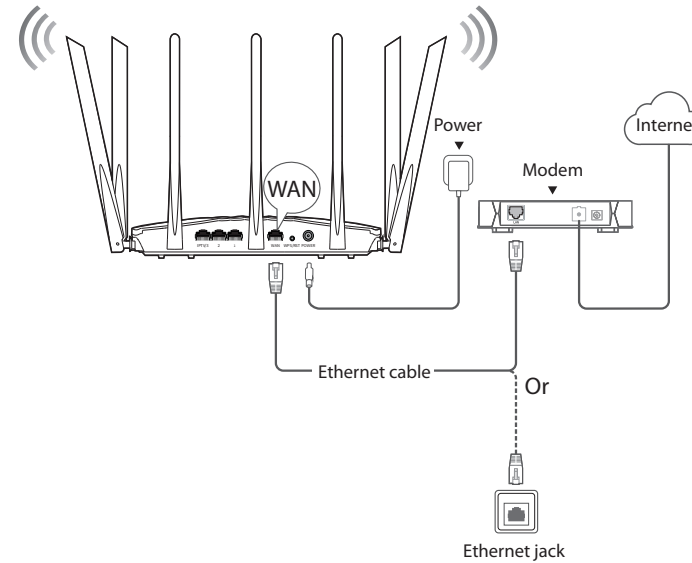

II. Connect your devices to the new router

Method 1: Connect your WiFi-enabled device (such as a smart phone) to the new router's WiFi network using the SSID labeled on the bottom of the router. There is no WiFi password by default.

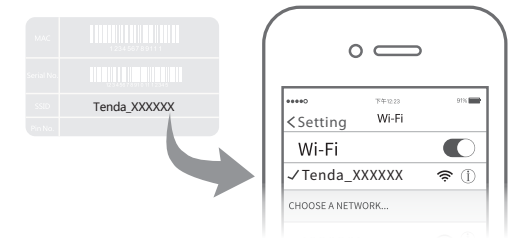

Method 2: Connect your wired device (such as a computer) to a LAN port (port 1, 2, 3, and IPTV/4 for AC19; port 1, 2, PTV/3 for AC23) of the router using an Ethernet cable. The LAN LED indicator lights up.

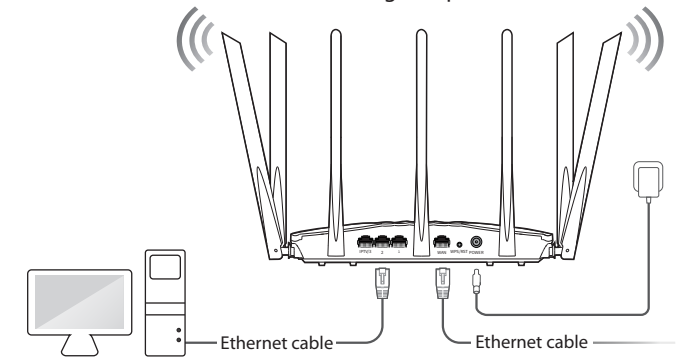

III. Set up the new router for internet access

1. Start a web browser on a device that has connected to the router, and visit **tendawifi.com**.

2. Click **Start**.

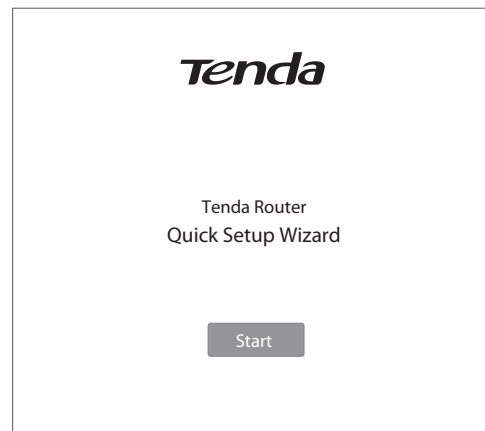

Tip
If you cannot log in to the web UI of the router, refer to **Q1** in **FAQ**.

3. The router detects your internet connection type automatically. Set required parameters and click **Next**.

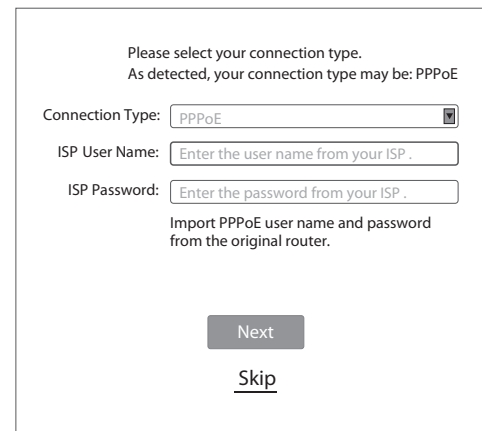

Note
PPPoE is used for illustration here. If you migrated your PPPoE user name and password from your original router, this router auto-fills the **ISP User Name** and **ISP Password**.

4. Customize your WiFi name (SSID), WiFi password and the login password as needed, and click **Next**.



Note
The WiFi password is used to connect to the WiFi network, and the login password is used to log in to the web UI of the router.

Done.

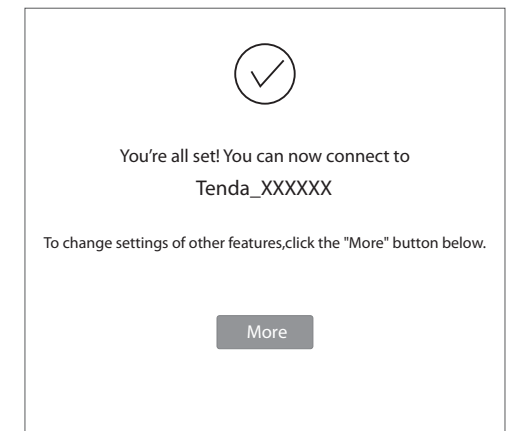

IV. Access the internet

WiFi-enabled devices: Connect your WiFi-enabled devices to the WiFi network of the router using the WiFi name and WiFi password you set.

Tips
The By default, the WiFi name for both 2.4 GHz and 5 GHz are the same, if you need to modify the WiFi name and WiFi password, see **Q4** in **FAQ**.

Wired devices: Your wired devices connected to the router can access the internet directly now.

LED indicators

LED indicator	Status	Description
SYS	Solid on	<ul style="list-style-type: none"> The router is starting. If the indicator still light solid on after the router completes startup, it indicates that the router is connecting to the internet successfully.
	Blinking	The router works properly, but fails to connect to the internet.
	Off	The system is faulty.
WAN	Solid on	The WAN port is connected properly, but no data is being transmitted
	Blinking	Data is being transmitted over the WAN port.
	Off	The WAN port is disconnected or improperly connected.
LAN	Solid on	At least one LAN port is connected properly.
	Fast blinking for twice	A new wired device is connected to the router.
	Off	No device is connected to any LAN port of the router properly.
WiFi	Solid on	At least the 2.4 GHz or 5 GHz WiFi network is enabled.
	Fast blinking	Data is being transmitted wirelessly.
	Slow blinking	The router is performing WPS negotiation.
	Off	Both 2.4 GHz and 5 GHz WiFi networks are disabled.
T		This LED is reserved.



CE Mark Warning

This is a Class B product. In a domestic environment, this product may cause radio interference, in which case the user may be required to take adequate measures.

Operations in the 5.15-5.25GHz band are restricted to indoor use only. This equipment should be installed and operated with minimum distance 20cm between the device and your body.

The mains plug is used as disconnect device, the disconnect device shall remain readily operable.

NOTE: (1) The manufacturer is not responsible for any radio or TV interference caused by unauthorized modifications to this equipment. (2) To avoid unnecessary radiation interference, it is recommended to use a shielded RJ45 cable.

Declaration of Conformity

Hereby, SHENZHEN TENDA TECHNOLOGY CO., LTD. declares that the radio equipment type AC23 is in compliance with Directive 2014/53/EU. The full text of the EU declaration of conformity is available at the following internet address: <http://www.tendacn.com/en/service/download-cata-101.html>
 Hereby, SHENZHEN TENDA TECHNOLOGY CO., LTD. declares that the radio equipment type AC19 is in compliance with Directive 2014/53/EU. The full text of the EU declaration of conformity is available at the following internet address: <http://www.tendacn.com/en/service/download-cata-101.html>

Operating Frequency:
 2.4 GHz: EU/2400-2483.5MHz (CH1-CH13)
 5 GHz: EU/5150-5250MHz (CH36-CH48)
 EIRP Power (Max.):
 2.4 GHz: 19.86 dBm
 5 GHz: 22.96 dBm
 Software Version: V16.03.07.XX

Jack, ports and buttons

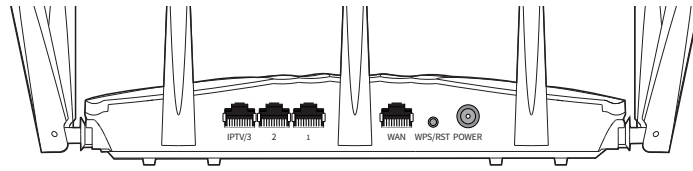

AC23

Jack/Port/Button	Description
POWER	Power jack. Used to connect to the included power adapter.
WPS/RST	Used to start the WPS negotiation process, or to reset the router. <ul style="list-style-type: none"> WPS: Press the button of the router for 1 to 3 seconds. Within 2 minutes, enable the WPS function of the other WPS-supported device to establish a WPS connection. Reset: When the SYS LED indicator blinks, hold the button down for about 8 seconds, release it when all the LED indicators blink once.
WAN	Used to connect this router to the internet.
1/2	They are LAN ports used to connect to the wired devices such as computers or switches.
IPTV/3	By default, it is a LAN port. If the IPTV function of the router is enabled, it serves only as an IPTV port used to connect to a set-top box.



FCC Statement

This equipment has been tested and found to comply with the limits for a Class B digital device, pursuant to Part 15 of the FCC Rules. These limits are designed to provide reasonable protection against harmful interference in a residential installation. This equipment generates, uses and can radiate radio frequency energy and, if not installed and used in accordance with the instructions, may cause harmful interference to radio communications. However, there is no guarantee that interference will not occur in a particular installation. If this equipment does cause harmful interference to radio or television reception, which can be determined by turning the equipment off and on, the user is encouraged to try to correct the interference by one or more of the following measures:

- Reorient or relocate the receiving antenna.
- Increase the separation between the equipment and receiver.
- Connect the equipment into an outlet on a circuit different from that to which the receiver is connected.
- Consult the dealer or an experienced radio/TV technician for help.

The device is for indoor usage only.

Operation is subject to the following two conditions: (1) this device may not cause harmful interference, and (2) this device must accept any interference received, including interference that may cause undesired operation.

Radiation Exposure Statement

This device complies with FCC radiation exposure limits set forth for an uncontrolled environment and it also complies with Part 15 of the FCC RF Rules. This equipment should be installed and operated with minimum distance 20cm between the device and your body.

Caution:

Any changes or modifications not expressly approved by the party responsible for compliance could void the user's authority to operate this equipment. This transmitter must not be co-located or operating in conjunction with any other antenna or transmitter.

Operating frequency: 2412-2462MHz, 5150-5250MHz, 5725-5850MHz

NOTE: (1) The manufacturer is not responsible for any radio or TV interference caused by unauthorized modifications to this equipment. (2) To avoid unnecessary radiation interference, it is recommended to use a shielded RJ45 cable.

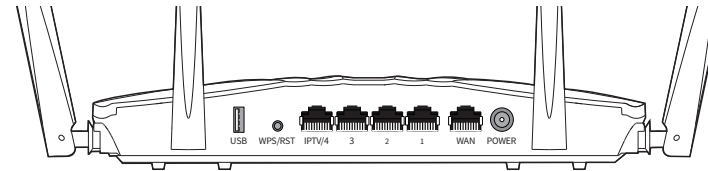

AC19

Jack/Port/Button	Description
USB	Used to connect to a USB 2.0 device.
WPS/RST	Used to start the WPS negotiation process, or to reset the router. <ul style="list-style-type: none"> WPS: Press the button of the router for 1 to 3 seconds. Within 2 minutes, enable the WPS function of the other WPS-supported device to establish a WPS connection. Reset: When the SYS LED indicator blinks, hold the button down for about 8 seconds, and release it when all the LED indicators blink once.
IPTV/4	By default, it is a LAN port. If the IPTV function of the router is enabled, it serves only as an IPTV port used to connect to a set-top box.
1/2/3	They are LAN ports used to connect to the wired devices such as computers or switches.
WAN	Used to connect this router to the internet.
POWER	Power jack. Used to connect to the included power adapter.



Caution: (AC23)

Adapter Model: BN037-A18012E/BN037-A18012B
 Manufacture: SHENZHEN HEWEISHUN NETWORK TECHNOLOGY CO., LTD.
 Input: 100 - 240V AC, 50/60Hz, 0.6A
 Output: 12V ==1.5A
 ---: DC Voltage



Caution: (AC19)

Adapter Model: BN034-A24012E/BN034-A24012B
 Manufacture: SHENZHEN HEWEISHUN NETWORK TECHNOLOGY CO., LTD.
 Input: 100 - 240V AC, 50/60Hz, 0.7A
 Output: 12V ==2A
 ---: DC Voltage



RECYCLING

This product bears the selective sorting symbol for Waste electrical and electronic equipment (WEEE). This means that this product must be handled pursuant to European directive 2012/19/EU in order to be recycled or dismantled to minimize its impact on the environment.

User has the choice to give his product to a competent recycling organization or to the retailer when he buys a new electrical or electronic equipment.

For EU/EFTA, this product can be used in the following countries:

	BE	BG	CZ	DK	DE	EE	IE	EL	ES	FR	HR	IT	CY	LV
	LT	LU	HU	MT	NL	AT	PL	PT	RO	SI	SK	FI	SE	UK

Operating Temperature: 0°C - 40°C
 Operating Humidity: (10% - 90%) RH, non-condensing

Copyright

© 2019 Shenzhen Tenda Technology Co., Ltd. All rights reserved.
 Tenda is a registered trademark legally held by Shenzhen Tenda Technology Co., Ltd. Other brand and product names mentioned herein are trademarks or registered trademarks of their respective holders. Specifications are subject to change without notice.

FAQ

Q1: I cannot log in to the web UI of the router after entering tendawifi.com, what should I do?

A1: Try the following solutions and log in again:

- Ensure that **tendawifi.com** is entered correctly in the address bar of the web browser, or you can try entering **192.168.0.1**.
- If you use a WiFi-enabled device to log in to the web UI of the router, ensure that it is connected to the router's SSID, and mobile data (if any) is disabled.
- If you use a computer to log in to the web UI of the router, ensure that it is connected to a LAN port (port 1, 2, 3, and IPTV/4 for AC19; port 1, 2, IPTV/3 for AC23) of the router properly by an Ethernet cable. And it is set to **Obtain an IP address automatically** and **Obtain DNS server address automatically**.
- Replace the web browser.
- Reset the router.

Q2: I cannot access the internet after the configuration, what should I do?

A2: Try the following methods:

- Check if the WAN port of the router is connected properly, and the WAN LED indicator is solid on or blinking.
- Check if the **SYS** LED indicator blinks, log in to the web UI of the router, and navigate to the **Internet Settings** page, follow the on-screen instructions to solve it.
- If your wired devices cannot access the internet:
 - Check if your computer is connected to port a LAN port (port 1, 2, 3, and IPTV/4 for AC19; port 1, 2, IPTV/3 for AC23) properly.
 - Check if your computer is set to **obtain an IP address automatically** and **Obtain DNS server address automatically**.
- If your WiFi-enabled devices cannot access the internet:
 - Check if your WiFi-enabled devices are connected to the WiFi network of the router with the SSID you set.
 - Change your WiFi name and WiFi password on **Wireless Settings** page. Then try again.

Q3: How to reset the router?

A3: When the **SYS** indicator lights on or blinks, hold down the **WPS/ RST** button for about 8 seconds. Release it when all the LED indicators blink once. The router is reset successfully.

Q4: How to change my WiFi names and passwords?

A4: Log in to the web UI of the router on your wired or WiFi-enabled device, navigate to **Wireless Settings > WiFi Name & Password** Page, and customize your WiFi names and passwords.

Q5: Why cannot my phone find 5 GHz signal?

A5: Only devices supporting 5 GHz signal can find and connect to the 5GHz network.

By default, the WiFi name for 2.4 GHz is the same with 5 GHz. To change it, please follow the instructions in **Q4**.

Technical Support

Shenzhen Tenda Technology Co., Ltd.
 6-8 Floor, Tower E3, NO.1001, Zhongshanyuan Road, Nanshan District, Shenzhen, China. 518052
 USA hotline: 1-800-570-5892
 Toll Free: 7 x 24 hours
 Canada hotline: 1-888-998-8966
 Toll Free: Mon - Fri 9 am - 6 pm PST
 Hong Kong hotline: 00852-81931998
 Global hotline: +86 755-2765 7180 (China Time Zone)
 Website: www.tendacn.com
 E-mail: support@tenda.com.cn