

PB21 & PB31

Mobile Receipt Printer

User's Guide



Intermec Technologies Corporation

Worldwide Headquarters

6001 36th Ave.W.

Everett, WA 98203

U.S.A.

www.intermec.com

The information contained herein is provided solely for the purpose of allowing customers to operate and service Intermec-manufactured equipment and is not to be released, reproduced, or used for any other purpose without written permission of Intermec Technologies Corporation.

Information and specifications contained in this document are subject to change without prior notice and do not represent a commitment on the part of Intermec Technologies Corporation.

© 2009 by Intermec Technologies Corporation. All rights reserved.

The word Intermec, the Intermec logo, Norand, ArciTech, Beverage Routebook, CrossBar, dcBrowser, Duratherm, EasyADC, EasyCoder, EasySet, Fingerprint, i-gistics, INCA (under license), Intellitag, Intellitag Gen2, JANUS, LabelShop, MobileLAN, Picolink, Ready-to-Work, RoutePower, Sabre, ScanPlus, ShopScan, Smart Mobile Computing, SmartSystems, TE 2000, Trakker Antares, and Vista Powered are either trademarks or registered trademarks of Intermec Technologies Corporation.

There are U.S. and foreign patents as well as U.S. and foreign patents pending.

Wi-Fi is a registered certification mark of the Wi-Fi Alliance.

Bluetooth is a trademark of Bluetooth SIG, Inc., U.S.A.

Contents

Before You Begin.....	vi
Safety Information.....	vi
Global Services and Support.....	vi
Warranty Information.....	vi
Web Support.....	vii
Telephone Support.....	vii
Service Location Support.....	vii
Who Should Read This Manual.....	vii
Related Documents.....	viii

1 Using the PB21/PB31 Mobile Receipt Printer..... 1

Learning About the PB21/PB31 Mobile Receipt Printer.....	2
Identifying the Parts of the Printer.....	2
Understanding the Control Panel.....	3
Understanding the Printer Language.....	5
Understanding the Printer Sounds.....	6
Understanding the Backlight.....	6
Using the Batteries.....	7
Installing the Battery.....	7
Charging the Batteries.....	9
Understanding the Battery Icons.....	9
Extending Battery Life.....	10
Loading Media.....	11
Printing a Test Page.....	13

2 Configuring the PB21/PB31..... 17

Configuring the PB21/PB31.....	18
Understanding the Display Modes.....	18
Understanding Ready Mode.....	18
Understanding Information Mode.....	19
Understanding Pause Mode.....	19
Understanding Setup Mode.....	20
Understanding Error Mode.....	21
Understanding Test Mode.....	22
Changing Configuration Settings From the Display.....	24
Changing WiFi Configuration Settings From PrintSet.....	25
Changing Configuration Settings Using the Command Line.....	25

Contents

Changing Configuration Settings From the Printer Home Page	26
Changing Configuration Settings Using SmartSystems Foundation	26
Changing the Printer Language	27
Establishing Communications With a Host	28
Setting Up Bluetooth Communications	28
Setting Up 802.11 Radio Communications	30
Configuring Wireless Printing Using IPL	32
Configuring Wireless Printing Using Fingerprint	35
Setting Up USB Communications	37
Setting Up Serial Communications	37
Downloading Fonts and Graphics	39
3 Troubleshooting and Maintaining the PB21/PB31	41
Troubleshooting the PB21/PB31	42
Contacting Product Support	42
Understanding Error Messages	42
Troubleshooting Printer Problems and Finding Solutions	44
Troubleshooting Communication Problems	46
Using the Line Analyzer in Fingerprint	46
Using Dump Mode in IPL	47
Resetting the PB21/PB31	48
Upgrading the Firmware	48
Cleaning the Printer	50
A Specifications	53
Specifications	54
Accessories for the PB21/PB31	57
B Default Settings	59
Factory Default Settings (Fingerprint Printers)I	60
Factory Default Settings (IPL Printers)	61
Factory Default Settings (ESC/P Printers)	62
C IPL and Fingerprint Setup Menus	65

IPL Setup Menu66

Fingerprint Setup Menu.....67

| Index 69

Before You Begin

This section provides you with safety information, technical support information, and sources for additional product information.

Safety Information

Your safety is extremely important. Read and follow all warnings and cautions in this document before handling and operating Intermec equipment. You can be seriously injured, and equipment and data can be damaged if you do not follow the safety warnings and cautions.

This section explains how to identify and understand warnings, cautions, and notes that are used in this document.



A warning alerts you of an operating procedure, practice, condition, or statement that must be strictly observed to avoid death or serious injury to the persons working on the equipment.



A caution alerts you to an operating procedure, practice, condition, or statement that must be strictly observed to prevent equipment damage or destruction, or corruption or loss of data.



Note: Notes either provide extra information about a topic or contain special instructions for handling a particular condition or set of circumstances.

Global Services and Support

Warranty Information

To understand the warranty for your Intermec product, visit the Intermec web site at www.intermec.com and click **Support > Returns and Repairs > Warranty**.

Web Support

Visit the Intermec web site at www.intermec.com to download our current manuals (in PDF).

Visit the Intermec technical knowledge base (Knowledge Central) at intermec.custhelp.com to review technical information or to request technical support for your Intermec product.

Telephone Support

In the U.S.A. and Canada, call **1-800-755-5505**.

Outside the U.S.A. and Canada, contact your local Intermec representative. To search for your local representative, from the Intermec web site, click **About Us** > **Contact Us**.

Service Location Support

For technical support in South Korea, use the after service locations listed below:

AWOO Systems
102-1304 SK Ventium
522 Dangjung-dong
Gunpo-si, Gyeonggi-do Korea, South 435-776
Contact: Mr. Sinbum Kang
Telephone: +82-31-436-1191
Email: sbkang@awoo.co.kr

Sammi Information Systems Co Ltd
7-9FL, Seo Jo Building
103-15, Galwor-Dong
Seoul, Yong San-ku Korea, South 140-807
Contact: Kyung-Hee Koo
Telephone: +82-2-790-5508
Email: jlovekoo@sammicomputer.co.kr

Who Should Read This Manual

This user's guide is for the person who is responsible for installing, configuring, and maintaining the PB21/PB31 printer.

This guide provides you with information about the features of the PB21/PB31, and how to install, configure, operate, maintain, and troubleshoot it.

Before You Begin

Before you work with the PB21/PB31, you should be familiar with your network and general networking terms, such as IP address.

Related Documents

This table contains a list of related Intermec documents and their part numbers.

Document Title
<i>Intermec Fingerprint Command Reference Manual</i>
<i>Intermec Fingerprint Programmer's Reference Manual</i>
<i>Intermec Printer Language (IPL) Developer's Guide</i>
<i>Intermec Printer Language (IPL) Command Reference Manual</i>
<i>ESC/P Programmer's Reference Manual</i>
<i>ZSIM Programmer's Guide</i>

The Intermec web site at www.intermec.com contains our documents (as PDF files) that you can download for free.

To download documents

- 1 Visit the Intermec web site at www.intermec.com.
- 2 Click **Support** > **Manuals**.
- 3 Use the **Product Category** field, the **Product Family** field, and the **Product** field to help you locate the product whose documentation you want to download.

1

Using the PB21/PB31 Mobile Receipt Printer

Use this chapter to familiarize yourself with the PB21/PB31 mobile receipt printer. In this chapter you will find these sections:

- **Learning About the PB21/PB31 Mobile Receipt Printer**
- **Using the Batteries**
- **Loading Media**
- **Printing a Test Page**

Learning About the PB21/PB31 Mobile Receipt Printer

The PB21/PB31 is a rugged direct thermal receipt printer that is designed for use with Intermec mobile computers, Intermec fixed computers, and Intermec vehicle mount computers as well as the SF51 and SR61 scanners. The PB21 uses 50.8 mm (2 in) media and the PB31 uses 76.2 mm (3 in) media.

The PB21/PB31 provides:

- print resolution of 203 dpi.
- print speeds of up to 100 mm per second (4 ips).
- 802.11 or Bluetooth radio options.

Identifying the Parts of the Printer

Use this illustration to familiarize yourself with some of the features of the PB21/PB31.

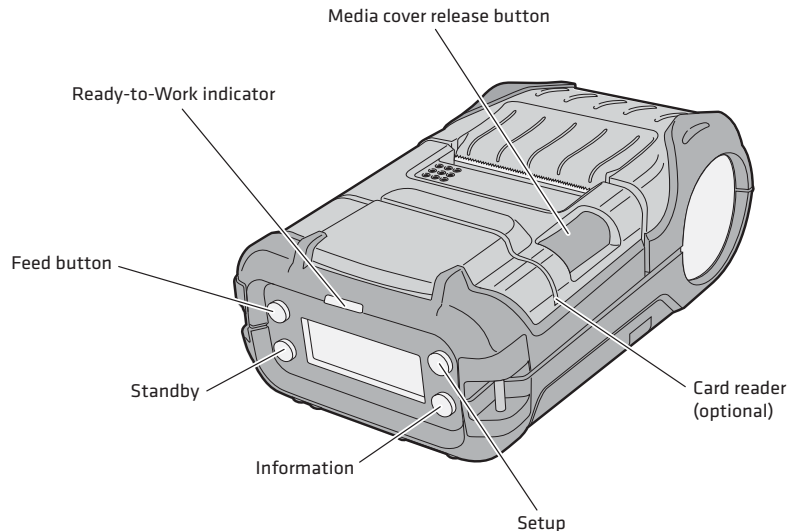

PB21/PB31: This illustration shows the important features of the PB21/PB31. A weather-resistant flap protects the communications ports and the external power connector.

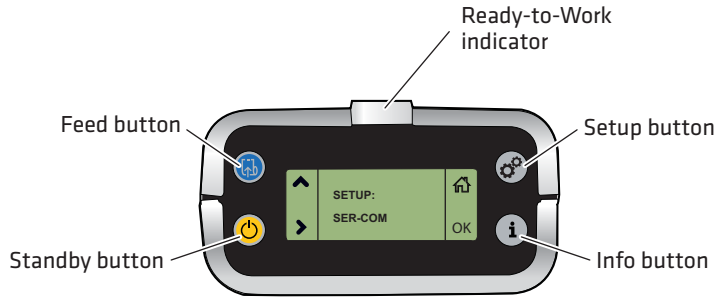

Understanding the Control Panel

The PB21/PB31 control panel contains four buttons, a liquid crystal display (LCD), and one LED indicator. Use the four buttons to navigate the menu system and perform functions on the PB21/PB31 printer. See the following tables to understand the buttons, the menu system, and what the LED means.



Printer Control Panel

Understanding How to Use the PB21/PB31 Buttons











Button Name	Button	Function
Feed		Press to advance the media. The amount of media that feeds is dependent on the type of media you are using. It will advance by 5 mm (0.2 inch), or feed a configured length of media based on your media and settings. If the printer is printing, pressing this button causes the printer to pause. Press the button again to resume printing.
Setup		Press to display the Setup menu. With ESC/P firmware, press and hold to cancel printing.
Standby (Power)		Press to put the printer in Standby mode. In Standby mode, power to the radio, the display, and the backlight are turned off. Press to turn the printer back on and put in Ready mode.

Understanding How to Use the PB21/PB31 Buttons (continued)

Button Name	Button	Function
Info		<p>Press to display a summary of network connection information and error conditions. Each setting in the summary information displays on the screen for five seconds.</p> <p>In Fingerprint and IPL, press this button in Pause mode to cancel the print job.</p>

All of the buttons can act as “soft keys,” which means that the function of each button depends on the state of the printer. A small icon appears in the screen next to the button to indicate the function it performs.

Understanding the Soft Keys

Button	Soft Keys	Description
		<ul style="list-style-type: none"> Moves up one level in the menu system. This soft key appears in Setup mode.
		<ul style="list-style-type: none"> Increases the value of a number when editing settings such as an IP address. This soft key appears in Setup mode.
		<ul style="list-style-type: none"> Pauses the printing job. This icon appears only when you are printing.
		Exit Setup mode and return to Ready mode.
		Moves through the settings at the same level in the menu system.
	OK	<ul style="list-style-type: none"> Moves down one level in the menu system and saves changes to a setting.
		<ul style="list-style-type: none"> Exits a printing job or exits Information mode.

There is only one LED on the PB21/PB31 printer: the Ready-to-Work™ indicator.

Understanding the Ready-to-Work Indicator

Indicator State	Description
Off	One of several conditions: <ul style="list-style-type: none">• The printer is in Standby mode.• The printer is in Info mode.• The printer is in Setup mode.
On	The PB21/PB31 is turned on and operating.
Blinking	One of several conditions: <ul style="list-style-type: none">• The printer is out of paper.• The media cover is open.• There is a printer error that requires you to perform an action. For a list of possible problems, see “Troubleshooting the PB21/PB31” on page 42.

Understanding the Printer Language

Your PB21/PB31 printer comes with Intermec Printer Language (IPL), Fingerprint, ESC/P, and ZSIM. The language you choose affects the functionality of the printer and how you interact with it. This manual contains information for using the different types of printer language.

When the printer is shipped from the factory, the first person to turn on the printer will have the option of choosing which printer language to run on the printer.

- Press the appropriate button to choose a language.

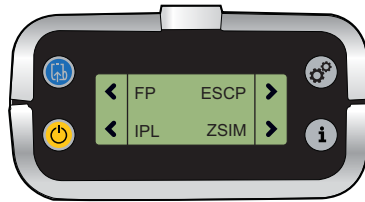

Choosing the Printer Firmware

The current firmware type and version display on the PB21/PB31 screen when the printer is in Ready mode.

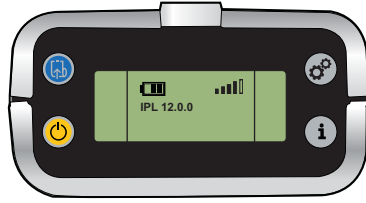

The screen of a PB21/PB31 running IPL firmware

Understanding the Printer Sounds

The PB21/PB31 plays sounds in response to several actions that you can take with the printer. Use the following table to understand when the sounds occur and what they mean.

Understanding the Printer Sounds

Sound	Occurs When:
Power	<ul style="list-style-type: none">• You insert a battery in the printer.• The PB21/PB31 starts charging the battery.• You plug in the AC adaptor.
Hardware	You open the media door, close the media door, or insert a cable.
Button	You press any of the PB21/PB31 buttons.
Error	<ul style="list-style-type: none">• The printer cannot feed paper or print a job because of a hardware issue such as the media door open, a paper jam, or there is no media.• An error occurs such as a paper jam, a print error, or the printer is out of range.

Understanding the Backlight

The screen backlight on the PB21/PB31 behaves the same way as a screen saver on your PC. After a set amount of time elapses without any user interaction, the backlight goes off. The screen backlight turns on when:

- the printer begins printing.

- you press a button.
- you connect the printer to external power.
- you are communicating with or sending data to the printer.

You can change the amount of time to have elapse before the backlight turns off using the Setup menu. Options for backlight are always off, always on, 5 seconds, 10 seconds, 20 seconds, 30 seconds, or 60 seconds.

Using the Batteries

The PB21/PB31 uses a rechargeable 2250 mAh lithium-ion battery (Model AB27) for power. You must fully charge the battery before you can use the PB21/PB31. A fully charged battery can last up to one week without needing to be recharged when the printer is in Standby mode.



Use Intermec Model AB27 battery only. Use of another battery may present a risk of fire or explosion.

The Model AB27 battery may present a fire or chemical burn hazard if mistreated. Do not disassemble, heat above 100°C (212°F), or incinerate.

Dispose of used batteries promptly. Keep away from children.

Installing the Battery

Make sure you fully charge the battery before you use your PB21/PB31. You can charge the battery before or after you install them into the PB21/PB31.

To install the battery

- 1** Lay the PB21/PB31 upside down on a flat surface.

Chapter 1 – Using the PB21/PB31 Mobile Receipt Printer

- 2** Insert the battery with the tab facing away from the front control panel.

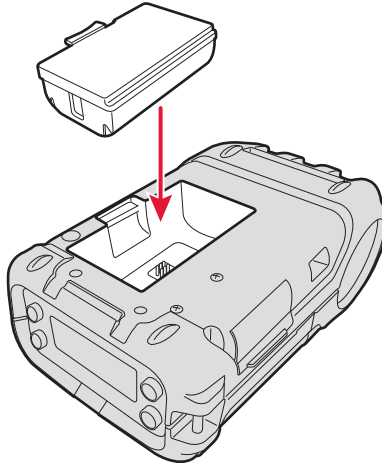

- 3** Insert the edge of the battery under the lip of the PB21/PB31 and then push down until you hear the battery latch click.

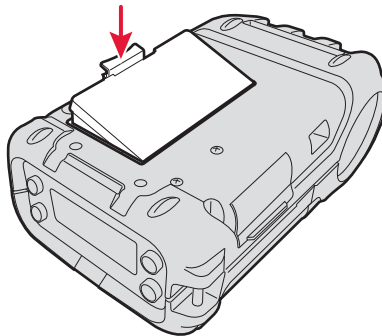

Charging the Batteries

There are two ways to charge the PB21/PB31 battery:

- Connect AC power to the printer using a 12 VDC power supply and charge the battery while it is in the PB21/PB31.
- Charge the battery in the AC18 4-bay battery charger. It takes approximately 4 hours to charge your batteries using the 4-bay battery charger.

For information on charging your battery in the 4-bay battery charger, see the [AC18 4-Bay Battery Charger Instructions](#).

It takes approximately 3 hours to charge the battery while it is installed in the PB21/PB31 printer. To charge the battery inside the PB21/PB31, you need:

- an Intermec 12 VDC power supply (Model AE19).
- an AC power cord.



To charge the battery inside the PB21/PB31

- 1 Install the battery in the PB21/PB31. For help, see the previous section, [“Installing the Battery” on page 7](#).
- 2 Connect the power supply to the DC power connector on the printer.
- 3 Connect one end of the power cord to the power supply and then plug the other end into an AC outlet.



Understanding the Battery Icons

The easiest way to tell the status of your battery is to look at the battery icons on the control panel of the PB21/PB31.

Battery Icon Status

Icon	Status
	Battery is fully charged.
	Battery has a medium charge. You should be able to work for several more hours before charging or replacing the battery.
	Battery is low. Recharge the battery.

Battery Icon Status (continued)

Icon	Status
	Battery is critically low. You need to replace the battery now.
	Battery charging error. You may need to replace the battery.
	External power connected and there is no battery in the printer.

Extending Battery Life

Here are some tips for extending the overall life of your battery:

- Never expose the battery to direct sunlight or temperatures over 50°C (122°F).
- Only charge the battery inside the PB21/PB31 using a power supply or in the 4-bay battery charger (Model AC18).
- Do not set the backlight to always on. The always on setting disabled automatic power saving modes.

Here are some tips for extending the life of your battery between charges:

- Press the **Standby** button to put the printer in Standby mode.
- Remove the battery from the printer if you will not be using it for three days or more.
- Do not operate the printer when the ambient temperature is -20 C (-4 F) or below. Using the PB21/PB31 in temperatures below freezing reduces the overall battery life.

Remember that any rechargeable battery loses its ability to maintain a charge over time. You can only recharge it a finite number of times before you must replace it.

Loading Media

You can use roll or fanfold receipt media with the PB21/PB31 printer. The PB21/PB31 ships with a small amount of media loaded and a test page printed to verify that the printer works. For information on media, see **“Specifications” on page 54.**

To load media

- 1 Press down on the blue media cover release button until the cover releases.

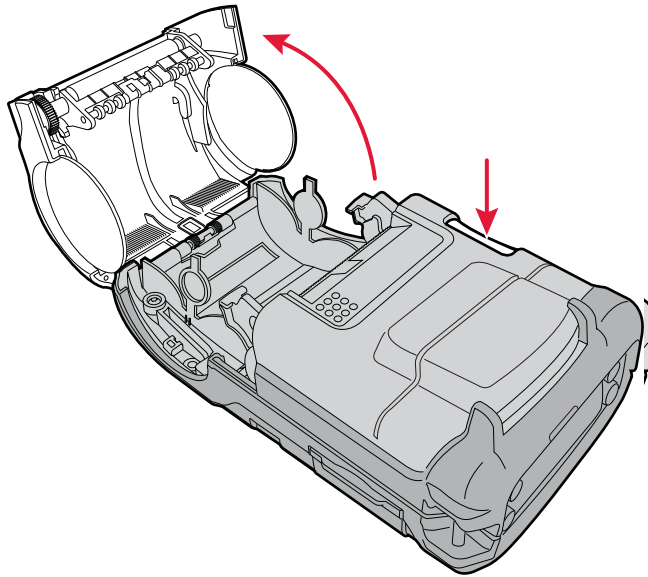

Chapter 1 – Using the PB21/PB31 Mobile Receipt Printer

- 2** Insert a roll of media. Make sure you load the media clockwise so that it pulls off the core from the bottom of the printer.

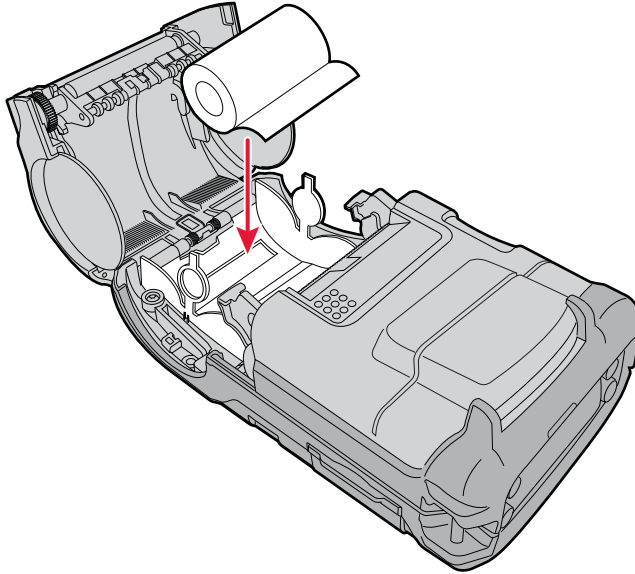

- 3** Pull out approximately 8 cm (3 in) of the media.

- 4 Close the media cover until it latches.

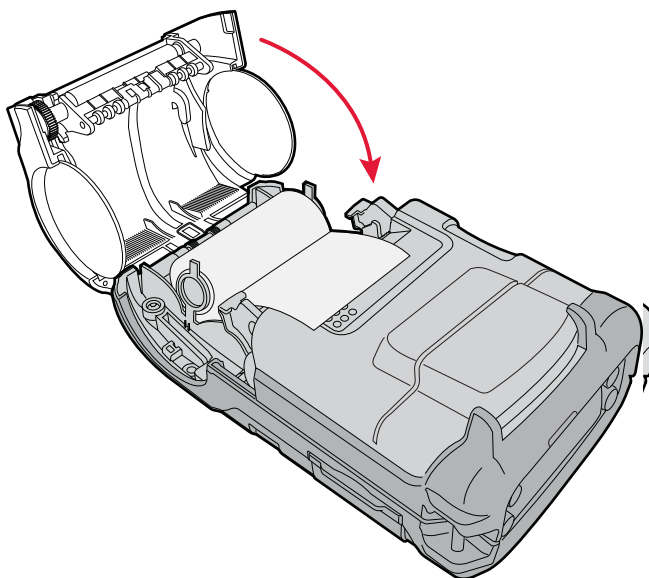

- 5 Press the **Feed** button to advance the media.

Printing a Test Page

After you have loaded media in the printer, you are ready to print a test page. You can choose from several test page options for each of the printer language. If you cannot get the test page information to print, see [“Troubleshooting the PB21/PB31” on page 42](#).

To print a test page with a PB21/PB31 loaded with IPL

- 1 Press the **Setup** button.
- 2 Press **▶** until you reach **Test/Service**.
- 3 Press **OK** to enter the Test/Service menu system.
- 4 Press **OK** to enter the Testprint Config menu.
- 5 Press **OK** to enter the Config menu.
- 6 Press **▶** to choose a testprint.
- 7 Press **OK** to print the Config testprint of your choice.

To print a test page with a PB21/PB31 loaded with Fingerprint

- 1** Press the **Setup** button.
- 2** Press **➤** until you reach **Print Defs.**
- 3** Press **OK** to enter the Print Defs menu system.
- 4** Press **➤** until you reach **Testprint.**
- 5** Press **OK** to enter the Testprint menu.
- 6** Press **➤** to choose a testprint.
- 7** Press **OK** to print the testprint of your choice.

To print a self test with a PB21/PB31 loaded with ESC/P

- Send the ESC EZ{TP} command to the printer.

2

Configuring the PB21/PB31

In this chapter you will find these sections:

- **Configuring the PB21/PB31**
- **Establishing Communications With a Host**
- **Downloading Fonts and Graphics**

Configuring the PB21/PB31

You can change the configuration settings of the PB21/PB31 printer directly from:

- the display.
- the host PC using PrintSet.
- the host PC using the command line.
- the printer home page.
- SmartSystems™ Foundation.

For more information on the IPL and Fingerprint menu systems, see [“IPL and Fingerprint Setup Menus” on page 65](#).

Understanding the Display Modes

The PB21/PB31 has six display modes to help you effectively interact with the printer: Ready, Information, Paused, Setup, Error, and Test. Use the following sections to understand the different printer modes.

Understanding Ready Mode

The printer is in Ready mode when the printer is on and ready to print. The main screen displays the power status, the radio status, and the printer language and version.

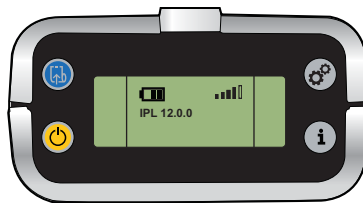

The PB21/PB31 in Ready Mode

Understanding Information Mode

When the printer is in Information mode, it displays a subset of pertinent information about the printer. If the printer experienced an error, the error message displays first followed by the printer information. Each message displays on the screen for five seconds. After five seconds on the last information screen, the printer exits Information mode.

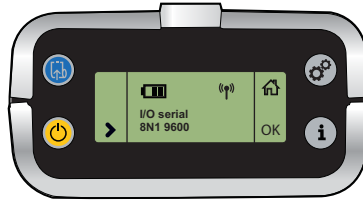

The PB21/PB31 in Information Mode

To enter Information mode

- Press the **Information** button on the control panel.

Understanding Pause Mode

Use Pause mode to momentarily stop printing or to cancel a current print job. Once you pause the printer, the Pause mode screen appears. Use the **Feed** button to both pause and resume printing.

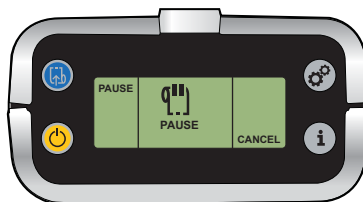

The PB21/PB31 in Pause Mode

To enter Pause mode

- Press the **Feed** button while the printer is printing.

To resume printing

- Press the **Feed** button.

To cancel a print job

- 1 Press the **Feed** button to pause printing (Fingerprint, IPL, or ESC/P).
- 2 Press the **Information** button (or **X** soft key) to cancel the print job (Fingerprint or IPL) or press and hold the **Pause** button in ESC/P.

Understanding Setup Mode

Use Setup mode to change the settings on the printer.

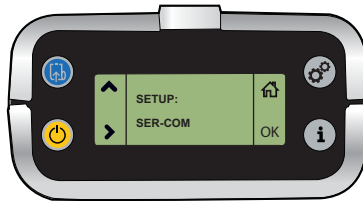

Sample Setup Mode Screen

To enter or exit Setup mode

- Press the **Setup** button.

Once you enter Setup mode, there are two editing modes: normal and enhanced.

Editing Settings in Setup Mode

Editing Mode	To Navigate	To Accept Value
Normal	<ul style="list-style-type: none">• Press > to move among choices.• Press ^ to go up a level in menu system.	Press OK .
Enhanced	<ul style="list-style-type: none">• Press > to move within the editable fields. When the field blinks, you can edit it.• Press + to increase the value of the field.	Press OK .

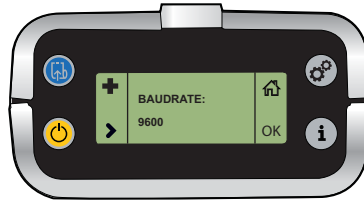

Normal Editing Mode: In normal editing mode, you see an up arrow and a right arrow for making selections.



Enhanced Editing Mode: In enhanced editing mode you have a plus sign and a right arrow to change the value of numeric fields.

Understanding Error Mode

The printer enters Error mode when it detects an error condition such as a low battery or a paper fault. Some error messages appear on the screen immediately when they occur, such as DOOR OPEN. Other error messages do not appear until you press the **Information** button. If there is more than one error at a given time, the errors display in the order that they occurred.



Sample Error Mode Screen

If you encounter an error message, see [“Understanding Error Messages” on page 42](#) for information on how to fix the problem.

Understanding Test Mode

Use Test mode to verify printer settings, test printing, restore factory default settings, or enter Dump mode for troubleshooting purposes. Two test modes are available: Test mode and Extended Test mode.

Using Test Mode

Test mode is a simple sequence of events which requires little user interaction. Extended Test mode requires more user interaction and lets you choose which actions you want the printer to perform.

To enter Test mode

- 1 Make sure the printer is in Ready mode and is loaded with media.
- 2 Press the **Feed** and **Standby** buttons at the same time and hold until Select Media appears on the screen and it displays the type of media you are using.
- 3 Release both buttons. The printer performs a test feed (sensor calibration), prints, and then enters Dump mode.

The printer is now in Dump mode and it scans the communication ports. Any characters received on the communication ports are printed.

- 4 Press **Feed** to exit Dump mode.

After you exit Dump mode, the printer returns to Ready mode. For more information on Dump mode, see [“Troubleshooting Communication Problems” on page 46](#).



Using Extended Test Mode

Use Extended Test mode to run additional diagnostic tests, entering Dump mode, and resetting to factory defaults.



Sample Extended Test Mode Screen

To enter Extended Test mode

- 1 Make sure that the printer is loaded with media.
- 2 Press the media cover release button to open the media cover.
- 3 Press the **Standby** button to turn the printer off.
- 4 Press **Feed** and **Standby** buttons at the same time until CLOSE PRINTER DOOR appears on the screen.
- 5 Close the media cover. You are now in Extended Test mode.
 - Press  to cycle through the options.
 - Press **OK** to select a test option.
 - Press  to exit Extended Test mode.

Options in Extended Test Mode

Function	Description
Select Media	This option is almost the same as the process in Test mode, except that the printer performs a slow test feed in Extended Test mode. The slow test feed enables the printer to perform a slow sensor calibration which can help resolve mark detection problems.
Test Labels	This option allows you to print test labels one at a time. Press OK to print the next label.
Dump Mode	This options enters Dump mode. For more information on Dump mode, see “Troubleshooting Communication Problems” on page 46 .
Factory Default	This option restores the factory default settings. Press OK to select this option and then follow the instructions on the screen.
Exit to Setup	This option exits Extended Test mode and puts the printer in Setup mode.
Exit	This option exits Extended Test mode

Changing Configuration Settings From the Display

You need to enter Setup mode before you can change configuration settings. For more information on entering Setup mode and navigating through the settings, see **“Understanding Setup Mode” on page 20**.

The top levels of the Setup menu are organized in a one-way loop. Each level has several sub-levels.

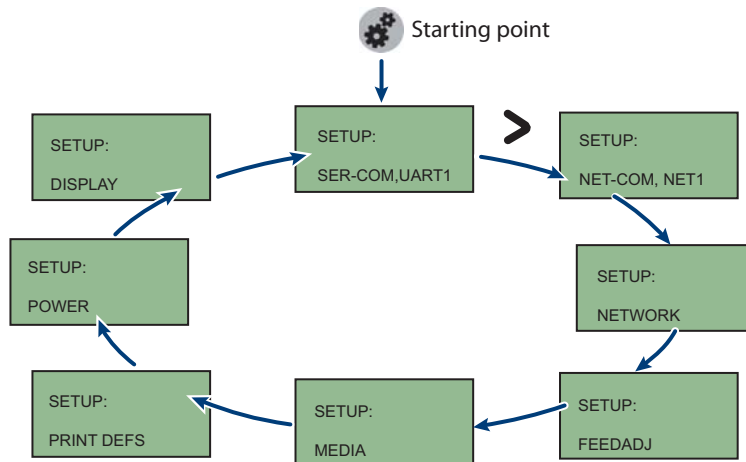

The Main Levels of the Setup Menu in Fingerprint

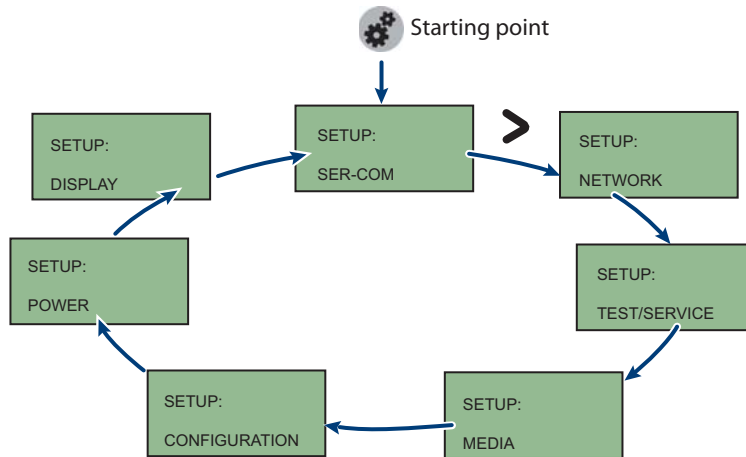

The Main Levels of the Setup Menu in IPL

ESC/P supports six types of setup commands:

- Bluetooth - set Bluetooth parameters
- Download - download fonts and graphics to the printer
- Easy print mode - print receipts, tickets, and reports
- Line printer mode - print receipts, tickets, and reports
- Query - retrieve information about the printer or a print request, cancel printing, or reset the printer
- WiFi - set WiFi parameters

Changing WiFi Configuration Settings From PrintSet

PrintSet is a printer configuration tool that you can download from the Intermec web site. PrintSet can communicate with your printer through a serial cable or a network connection. It works on all PCs running Windows 98 (or later). PrintSet allows you to easily change all of the setup parameters. It also includes setup wizards to guide you through some common configuration tasks.

Changing Configuration Settings Using the Command Line

You can change configuration parameters by sending commands directly to the printer using your terminal program (HyperTerminal) and a serial or network connection.

If your printer uses the Fingerprint language, you use the SETUP command, followed by the node, subnode, and parameters setting. Fingerprint automatically sends feedback to HyperTerminal as you type.

If you want to see what you are typing with IPL, you need to complete the following procedure.

To see IPL commands as you type

- 1 From the HyperTerminal menu, select **File > Properties > the Settings** tab.
- 2 Click the **ASCII Setup** button.
- 3 Select **Echo typed characters locally**.
- 4 Click **OK** twice.

Changing Configuration Settings From the Printer Home Page

If you have an 802.11 radio in your printer and it is connected to the network, you can use your web browser to open the printer home page and make configuration changes. To connect to a wireless network, follow the procedure in “[Setting Up 802.11 Radio Communications](#)” on page 30.

To make changes to the configuration

- From the home page, click **Configuration**.

For more information on how to change configuration settings, see the *Fingerprint Command Reference Manual*, the *IPL Programmer’s Command Reference Manual*, or the *ESC/P Programmer’s Reference Manual*. You can download these documents from the Intermec web site at www.intermec.com.

Changing Configuration Settings Using SmartSystems Foundation

You can use the SmartSystems console to change configuration settings on your printer. The PB21/PB31 ships with the SmartSystems client loaded on it. The console is part of SmartSystems Foundation and is available from the Intermec web site. To download SmartSystems Foundation, go to www.intermec.com/products/smrtsysfoundation/index.aspx.

Changing the Printer Language

The following printer languages are available on the PB21 and PB31 printers:

- Fingerprint
- IPL
- ESC/P
- DSim
- ZSim

The most frequently used methods of changing languages are by using HyperTerminal and through the display settings. These methods are described below.

To change the printer language using the display settings

- Press the **Setup** button to the change command language function. See [Appendix C](#) for the Fingerprint and IPL menu trees.

To change the printer language using Fingerprint and HyperTerminal

1 Select **Start > Accessories > Communications > Hyperterminal** to start HyperTerminal.

2 Send the enable administrator rights command:

```
run "su -p pass admin
```

3 Send the run command to change the printer language to IPL:

```
setlanguage IPL -r
```

To change the printer language using IPL and HyperTerminal

1 Select **Start > Accessories > Communications > Hyperterminal** to start HyperTerminal.

2 Send the enable administrator rights command:

```
<STX><ESC>.y, su -p pass admin <ETX>
```

3 Send the run command to change the printer language:

```
<STX><EXC> .y, setlanguage FP -r<ETX>
```

To change the printer language using ESC/P and HyperTerminal

1 Select **Start > Accessories > Communications > Hyperterminal** to start HyperTerminal.

2 Enter U-shell. Press the ESC key and type:

```
{SYS:USH}
```

3 Send the enable administrator rights command:

```
su -p pass admin
```

4 Send the run command to change the printer language:

```
setlanguage IPL -r
```

Establishing Communications With a Host

The PB21/PB31 must establish communications with a host that will send the data for the printer to print. The PB21/PB31 provides four ways to communicate with a host:

- Bluetooth radio communications
- 802.11 b/g radio communications
- USB communications
- Serial communications

Setting Up Bluetooth Communications

The PB21/PB31 can contain a Bluetooth radio that allows wireless communications with a remote device from distances up to 100 meters (approximately 328 feet) depending on the Bluetooth range capabilities of the remote device, environmental conditions, and obstructions. For the Bluetooth-enabled devices to exchange data, both devices must establish a connection. Bluetooth software is always running in the background.

The PB21/PB31 cannot initiate a Bluetooth connection. One of the devices must request a connection with the printer. The PB21/PB31 then accepts or rejects the connection. Use Intermec Settings on the mobile computer to enable the Bluetooth settings on the PB21/PB31.

The PB21/PB31 can also connect to Bluetooth scanners, such as the SF51 and the SR61. You can create the bar code labels you need to connect the printer to a Bluetooth scanner using EasySet software. You can download a free version of EasySet from the Intermec web site at www.intermec.com.

Each PB21/PB31 equipped with a Bluetooth radio has a unique Bluetooth Device Address (BDA) loaded into its module when manufactured. You can find the BDA on the certification label located on the bottom of the printer.

To set up Bluetooth communications with a mobile computer

- Follow the procedure to discover and connect to Bluetooth devices in your mobile computer user’s manual.





Note: For maximum security, you need to configure a Bluetooth passcode for the PB21/PB31. The default passcode for the PB21/PB31 is “1234.”

To set up Bluetooth communications with a scanner

- 1 Download and install EasySet.
- 2 Create the following bar code labels using EasySet:
 - Administrator reset factory defaults
 - Bluetooth parameters - security - not active
 - Bluetooth parameters - connect/disconnect - compose BT address
 - Bluetooth parameters - security - compose PIN
- 3 Scan the bar code labels with the Bluetooth scanner.

Understanding Bluetooth Radio Icons

Icon	Description
	The Bluetooth radio is on and the printer is not connected to a serial cable.
	The Bluetooth radio is turned off. The Bluetooth radio turns off when you connect a serial cable.

Setting Up 802.11 Radio Communications

The PB21/PB31 can have an internal 802.11 b/g radio to transfer and receive data using wireless communications. This manual assumes that you have already set up your wireless communications network including your access points. The following procedures include information on setting up wireless security for both IPL and Fingerprint versions of the PB21/PB31.

The PB21/PB31 supports these authentication modes: none, WEP, WPA Personal and Enterprise mode (802.1x authentication), WPA2 Personal and Enterprise mode (802.1x authentication).



Note: WPA and WPA2 Enterprise modes currently support PEAP, TTLS, and LEAP. For LEAP authentication, the PB21/PB31 supports Open EAP, but does not support Network EAP.

To set up the PB21/PB31 to work in your wireless network, you will need:

- Serial cable (P/N 075497-xxx)
- Host PC running Windows or Linux
- A communications application such as HyperTerminal



Note: If you are using IPL commands with HyperTerminal, you may want to be able to see the commands as you type them on your screen. For help, see [“Changing Configuration Settings Using the Command Line” on page 25.](#)

To set up the PB21/PB31 for wireless communications

- 1 Connect the 8-pin circular DIN connector to the serial port on the PB21/PB31.
- 2 Connect the other end of the serial cable to a serial port on the back of your PC.
- 3 Open HyperTerminal on your PC and configure the following parameters for the serial port:

Parameter	Default Setting
Baud rate	115200
Data bits	8

Parameter	Default Setting
Parity	None
Stop bits	1

- 4 From the host PC, check the wireless settings.

If you have an IPL version of the printer, send these commands to the PB21/PB31:







```
<STX><SI>wt,SSID<ETX>
<STX><SI>wt,WEP1<ETX>
<STX><SI>wt,WEP2<ETX>
<STX><SI>wt,WEP3<ETX>
<STX><SI>wt,WEP4<ETX>
<STX><SI>wt,AUTH<ETX>
<STX><SI>wt,WPA<ETX>
<STX><SI>wt,WPA2<ETX>
<STX><SI>wt,WPA_PSK<ETX>
<STX><SI>wt,ROAM<ETX>
<STX><SI>wt,PWR_MODE<ETX>
<STX><SI>wt,CHANNEL<ETX>
<STX><SI>wt,AP_MAC<ETX>
<STX><SI>wt,SIGNAL<ETX>
<STX><SI>wt,SPEED<ETX>
<STX><SI>wt,ACTIVE<ETX>
```

If you have a Fingerprint version of the printer, send this command to the PB21/PB31:

```
setup write "wlan","uart1:"
```

- 5 Set up the PB21/PB31 to use the correct SSID and authentication modes. See one of the following procedures to configure wireless printing on your IPL or Fingerprint printer.
- 6 If you are going to use certificates for validation, transfer the certificate to the printer. The printer can accept .pfx, .pem, and .der certificates.
- 7 Verify that the PB21/PB31 is connected to the access point and make sure it has an IP address allocated to it.

Understanding the 802.11 Radio Icons

Icon	Description
	Excellent signal
	Strong signal
	Good signal
	Weak signal
	Poor signal
	No signal

Use the following sections to set most of your wireless communication settings. For help with additional commands and information, see either the *Fingerprint Programmer's Reference Manual* or the *IPL Developer's Guide*. You can download both documents from the Intermec web site at www.intermec.com.

Configuring Wireless Printing Using IPL

Use the following procedures to configure your PB21/PB31 with IPL for wireless printing.

To configure the printer to use WEP authentication

- 1 Send the following commands to login as an admin and set the SSID:

```
<STX><ESC>.x,su -p pass admin<ETX>  
<STX><SI>ws,SSID,xxxxx<ETX>
```

where *xxxxxx* can be from 0 to 32 alphanumeric characters.



Note: The default password for logging in as an admin is “pass.” If you have changed the password, you will need to use your password instead of “pass.”

- 2 Send the following commands to configure the WEP keys. The following example sets WEP key 1 to 1234 and enables WEP key 1.

```
<STX><SI>ws, WEP1, 0x0001020304<ETX>  
<STX><SI>ws, .WEP_KEY, 1<ETX>
```

- 3 Send the following command to activate the settings.

```
<STX><SI>ws, ACTIVE, 1<ETX>
```

To configure the printer to use WPA-PSK or WPA2-PSK mode

- 1 Send the following commands to login as an admin and set the SSID:

```
<STX><ESC>.x,su -p pass admin<ETX>  
<STX><SI>ws, SSID, xxxxxx<ETX>
```

where xxxxxx can be from 0 to 32 alphanumeric characters.

- 2 Send one of the following commands to turn on WPA or WPA2 authentication. Send the WPA-PSK or WPA2-PSK command to set a pre-shared key:

```
<STX><SI>ws, WPA, ON<ETX>  
<STX><SI>ws, WPA2, ON<ETX>  
<STX><SI>ws, WPA_PSK, xxxxxxxxxxxx<ETX>
```

where xxxxxxxxxxxx is a value between 8 and 64 characters.

- 3 Send the following command to activate the settings:

```
<STX><SI>ws, ACTIVE, 1<ETX>
```

To configure the PB21/PB31 to use WPA or WPA2 Enterprise mode

- 1 Send the following commands to login as an admin and set the SSID:

```
<STX><ESC>.x,su -p pass admin<ETX>  
<STX><SI>ws, SSID, xxxxxx<ETX>
```

where xxxxxx can be from 0 to 32 alphanumeric characters.



Note: The default password for logging in as an admin is “pass.” If you have changed the password, you will need to use your password instead of “pass.”

- 2 Send one of the following commands to enable WPA-802.1x or WPA2-802.1x authentication. You should also send the WPA_PSK command that does not contain a value:

```
<STX><SI>ws , WPA , ON<ETX>  
<STX><SI>ws , WPA2 , ON<ETX>  
<STX><SI>ws , WPA_PSK , <ETX>
```

- 3** Send these commands to configure the EAP_TYPE:

```
<STX><SI>ws , EAP_TYPE , xxxx<ETX>
```

where *xxxx* can be OFF, LEAP, PEAP, or TTLS.

```
<STX><SI>ws , . EAP_USER , xxxx<ETX>  
<STX><SI>ws , . EAP_PASS , xxxx<ETX>
```

where *xxxx* is the unique username and the unique password for this protocol.

- 4** If you are using TTLS, you may need to send this command to set the TTLS outer name:

```
<STX><SI>ws , TTLS_USER , xxxx <ETX>
```

where *xxxx* is the outer name.

- 5** If you are using certificates for validation, here are some commands you may need to use.

- Send the following commands to set a certificate and enable validation:

```
<STX><SI>ws , CA_CERT , c:/testCA.pfx@export<ETX>  
<STX><SI>ws , VALIDATE , ON<ETX>
```

where *c:/testCA.pfx* is the location and name of the certificate and *export* is the passphrase.

- Send the following commands to set a common name for server 1 and server 2:

```
<STX><SI>ws , .SERVER_CN1 , xxxxxxxxxxxx <ETX>  
<STX><SI>ws , .SERVER_CN2 , xxxxxxxxxxxx <ETX>
```

where *xxxxxxxxxxx* can be a value from 0 to 64 characters.

- Send the following command to make sure your values match those used by the access point:

```
<STX><SI>wt , [variable name] <ETX>
```

All variables are returned with the exception of EAP_PASS which always returns “*****” if configured and CA_CERT which transmits the name of the last certificate authority successfully installed. An additional read-only variable for the supplicant state, called STATE, is also returned.

- You may need to send the following command several times for the wireless station to connect:

```
<STX><SI>ws,ACTIVE,1<ETX>
```

Configuring Wireless Printing Using Fingerprint

Use the following procedures to configure your PB21/PB31 with Fingerprint for wireless printing.

To configure the printer to use WEP authentication

- 1 Send the following commands to login as an admin and set the SSID:

```
run"su -p pass admin"  
setup write "wlan","uart1:"  
setup "wlan","SSID","xxxxxx"
```

where *xxxxxx* can be from 0 to 32 alphanumeric characters.



Note: The default password for logging in as an admin is “pass.” If you have changed the password, you will need to use your password instead of “pass.”

- 2 Send the following commands to configure the WEP keys. The following example sets WEP key 1 to 1234 and enables WEP key 1.

```
setup "wlan","WEP1","0x0001020304"  
setup "wlan",".WEP_KEY","1"  
setup "wlan","ACTIVE","1"  
setup write "wlan","uart1:"
```

To configure the printer to use WPA-PSK or WPA2-PSK mode

- 1 Send the following commands to login as an admin and set the SSID:

```
run"su-p pass admin"  
setup write "wlan","uart1:"  
setup "wlan","SSID","xxxxxx"
```

where *xxxxxx* can be from 0 to 32 alphanumeric characters.

- 2 Send one of the following WPA/WPA2 ON commands to turn on WPA or WPA2 authentication. Send the WPA-PSK or WPA2-PSK command to set a pre-shared key:

```
setup "wlan","WPA","ON"  
setup "wlan","WPA2","ON"  
setup "wlan","WPA_PSK","xxxxxxxxxxxxx"
```

```
setup "wlan", "ACTIVE", "1"  
setup write "wlan", "uart1:"
```

where *xxxxxxxxxxx* is a value between 8 and 64 characters.

To configure the PB21/PB31 to use WPA or WPA2 Enterprise mode

- 1 Send the following commands to login as an admin and set the SSID:

```
run"su-p pass admin"  
setup write "wlan", "uart1:"  
setup "wlan", "SSID", "xxxxx"
```

where *xxxxx* can be from 0 to 32 alphanumeric characters.

- 2 Send one of the following WPA/WPA2 ON commands to set up WPA-802.1x or WPA2-802.1x authentication. You should also send the WPA_PSK command that does not contain a value:

```
setup "wlan", "WPA", "ON"  
setup "wlan", "WPA2", "ON"  
setup "wlan", "WPA_PSK", ""  
setup write "wlan", "uart1:"
```

- To view the 802.1x values, send this command:

```
setup write "8021x", "uart1:"
```

- 3 Send these commands to configure the EAP_TYPE:

```
setup "8021x", "EAP_TYPE", "xxxx"
```

where *xxxx* can be OFF, LEAP, PEAP, or TTLS.

```
setup "8021x", ".EAP_USER", "xxxx"  
setup "8021x", "EAP_PASS", "xxxx"
```

where *xxxx* is the unique username and the unique password for this protocol.

- 4 If you are using TTLS, you may need to send this command to set the TTLS outer name:

```
setup "8021x", "TTLS_USER", "xxxx"
```

where *xxxx* is the outer name.

- 5 If you are using certificates for validation, here are some commands you may need to use.

- Send the following commands to set a certificate and enable validation:

```
setup "8021x", "CA_CERT", "c:/test.pfx@export"  
setup "8021x", "VALIDATE", "ON"
```

where *c:/test.pfx* is the location and name of the certificate and *export* is the passphrase.

- Send the following commands to set a common name for server 1 and server 2:

```
setup "8021x", ".SERVER_CN1", "xxxxxxxxxxxx"  
setup "8021x", ".SERVER_CN2", "xxxxxxxxxxxx"
```

where *xxxxxxxxxxxx* can be a value from 0 to 64 characters.

- Send the following command to make sure your values match those used by the access point:

```
setup write "8021x", "uart1:"
```

- You may need to send the following command several times for the wireless station to connect:

```
setup "wlan", "ACTIVE", "1"
```

Setting Up USB Communications

To set up USB communications with your PC, you will need:

- USB cable
- Intermec InterDriver® software
- Thesycon CDC/ACM Class Driver (for PB21/PB31 with card reader)

You can download the InterDriver software from the Intermec web site at www.intermec.com.

Setting Up Serial Communications

Use a serial cable (P/N 075497-xxx) to connect the PB21/PB31 to a PC or a mobile computer. For the mobile computer, you may need to purchase a serial adapter. For more information, contact your local Intermec sales representative.

Before you can establish a serial connection, you need to make sure that the settings on the PC or mobile computer match those of the PB21/PB31.

Serial Port Settings on the PB21/PB31

Parameter	Default Setting
Baud rate	115200
Data bits	8
Parity	None
Stop bits	1
Flow control	XON_XOFF (IPL) No default (Fingerprint) RTS/CTS (ESC/P)

To connect the PB21/PB31 to a PC or mobile computer

- 1 Connect the 8-pin circular DIN connector to the serial port on the PB21/PB31.
- 2 Connect the other end of the serial cable to a serial port on the back of your PC or to a serial adapter on your mobile computer.

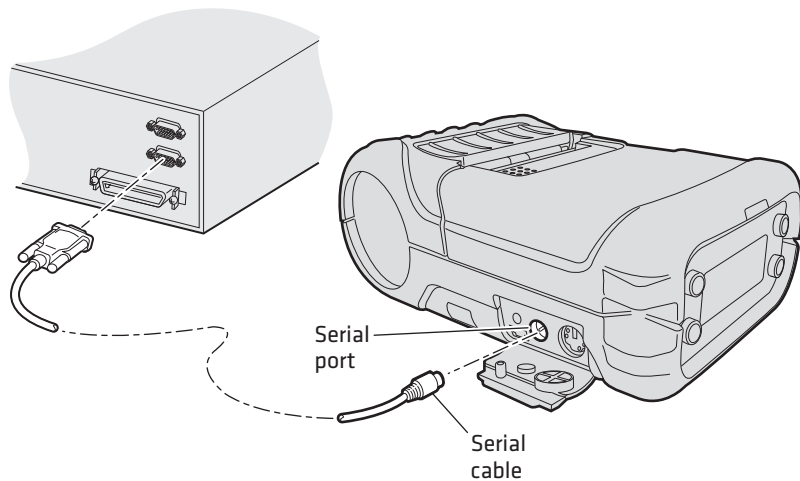

Downloading Fonts and Graphics

The easiest way to download fonts and graphics is to use PrintSet. You can download PrintSet from the downloads page for the PB21/PB31 printer on the Intermec web site at www.intermec.com. Follow the procedures in the PrintSet online help to download fonts and graphics.

You can also use Fingerprint, IPL, or ESC/P commands to send fonts and graphics to the printer. For help with commands and information, see either the *Fingerprint Command Reference Manual*, the *IPL Command Reference Manual*, or *ESC/P Programmer's Reference Manual*. You can download these documents from the Intermec web site at www.intermec.com.

3

Troubleshooting and Maintaining the PB21/PB31

Use this chapter to solve problems you may encounter while using the PB21/PB31. This chapter contains the following sections.

- **Troubleshooting the PB21/PB31**
- **Resetting the PB21/PB31**
- **Upgrading the Firmware**
- **Cleaning the Printer**

Troubleshooting the PB21/PB31

You may have printer operation, print quality, or printer communication problems at some time during the life of the PB21/PB31 printer. It is easy to fix most of the problems and you will find solutions in “**Troubleshooting Printer Problems and Finding Solutions**” on page 44. If you cannot find the answer to your problem, you may need to contact Product Support.

Contacting Product Support

Before you call Intermec Product Support, you may want to visit the Intermec technical knowledge base (Knowledge Central) at intermec.custhelp.com to review technical information or to request technical support. If you still need help after visiting Knowledge Central, you may need to call Product Support.

To talk to an Intermec Product Support representative in the U.S.A. or Canada, call:

1-800-755-5505

Outside the U.S.A. and Canada, go to www.intermec.com and click **Contact** to find your local Intermec representative.

Before you call Intermec Product Support, make sure you have the following information ready:









- Printer serial number
- Firmware type and version
- Bluetooth, wireless, or serial port settings

You can find all of the information listed above in the printer menu system or on a test print page.

Understanding Error Messages

Use the following tables to troubleshoot some common error message you may see display on PB21/PB31 screen. Some of the error messages are specific to the type of firmware you have loaded on your PB21/PB31.

Possible PB21/PB31 Error Icons and Messages

Error Icon	Error Message	Description
	Pause	The print job is paused.
	Paper out (IPL) Out of Paper (Fingerprint)	The printer is out of paper. Load a new roll of media. For help, see “Loading Media” on page 11 .
	Testfeed not done	The printer did not perform a test feed before printing. It is important to perform a test feed because it calibrates the sensor. To perform a testfeed: <ul style="list-style-type: none"> • In Fingerprint and ESC/P, press the Feed button for more than 1 second. • In IPL open and close the media door and then Press the Feed button.
	Printhead hot	The printhead is overheated and needs to cool down. In IPL, wait for printing to resume automatically. In Fingerprint and ESC/P, you need to restart your print job.
	Upgrading	The printer is loading new firmware.
	LSS too high, LSS too low	These errors can occur when you run a test feed without any media installed, or if you have incorrect media settings. Load the printer with media (see “Loading Media” on page 11), run Test mode (see “Understanding Test Mode” on page 22), and select the appropriate media type.
	IP configuration error	The printer is trying to acquire an IP address from the network. Wait for the printer to complete the task before taking any action.
	IP link error	No network connection.
	Field out of label	You are attempting to print in an area that extends beyond the print window. See the programmer’s reference manual for your type of firmware (IPL, Fingerprint, or ESC/P) for information on how to set the media parameters.

Possible PB21/PB31 Error Icons and Messages (continued)

Error Icon	Error Message	Description
	Door open	The printer is not completely closed. Press down on the media cover to make sure it is latched.

Troubleshooting Printer Problems and Finding Solutions

Use the following tables to troubleshoot some common problems you may encounter with the PB21/PB31 printer.

Printer Problems and Solutions

Problem	Possible Solution
The printer does not turn on when you press Standby .	<ul style="list-style-type: none"> • Replace the battery with a charged battery. • Connect external power to make sure the printer works correctly and to charge the battery.
The blue light (Ready-to-Work indicator) is blinking.	<ul style="list-style-type: none"> • Make sure media is loaded and the media cover is closed. For help, see “Loading Media” on page 11. • There is a printing error. The screen displays an error message containing information on the error. • The printer is paused. The printer is cancelling a print job.
Printer keeps printing or feeding when it should stop.	<ul style="list-style-type: none"> • Check media settings.
The printout is not in the desired position.	<ul style="list-style-type: none"> • Check for errors in the software application.
The printer is not printing with an 802.11 wireless connection.	<ul style="list-style-type: none"> • Verify that the wireless settings are correct. For help, see “Setting Up 802.11 Radio Communications” on page 30. • Make sure the printer has an IP address. • Make sure the printer is connected to the network. • Make sure the printer is in Ready mode.

Printer Problems and Solutions (continued)

Problem	Possible Solution
<p>The printer is not printing with a Bluetooth connection.</p>	<ul style="list-style-type: none"> • Re-establish a Bluetooth connection with the mobile computer or scanner. For help, see your mobile computer user’s manual or “Setting Up Bluetooth Communications” on page 28. • Make sure the mobile computer can print to a known good printer. • Print a Bluetooth test print page to make sure that the mobile computer discovered your printer. For help, see “Printing a Test Page” on page 13. • Make sure the printer is in Ready mode.
<p>Printout is faded or weak.</p>	<ul style="list-style-type: none"> • Fingerprint users: adjust the media constant/factor and contrast (-10% to +10%). • IPL users: adjust the media sensitivity setting (-10 to +10). • ESC/P users: adjust the Media Sensitivity command or the Set Dark Adjust command. For help, see the ESC/P Programmer’s Reference Manual. • Check to see if the printhead needs cleaning. For help, see “Upgrading the Firmware” on page 48.
<p>The battery charge is not lasting as long as it should.</p>	<ul style="list-style-type: none"> • Check the battery date. If the battery is a few years old, the shortened life may be due to normal aging. • Replace the battery.
<p>The test pages do not print.</p>	<ul style="list-style-type: none"> • Make sure that the blue light is not blinking. If it is, make sure your printer has media and that the media cover is closed. • Make sure that you can advance media by pressing the Feed button.

Printer Problems and Solutions (continued)

Problem	Possible Solution
Print quality is poor.	<ul style="list-style-type: none">• Clean the printhead. For help, see “Upgrading the Firmware” on page 48.• Check the battery and recharge or replace as necessary. For help, see “Charging the Batteries” on page 9.• Check the quality of the media. Use only Intermec media to ensure superior print quality and product performance.• Check that the printer is set to the appropriate Constant/Factory or sensitivity number for the media you are using.

Troubleshooting Communication Problems

Use Dump mode to verify that the printer is receiving data from the host correctly.

Using the Line Analyzer in Fingerprint

In Dump mode, the printer runs a Fingerprint program called Line Analyzer. The Line Analyzer captures incoming characters on the communication ports and prints them.

The easiest way to enter Dump mode is through Test mode or Extended Test mode. For help, see [“Understanding Test Mode” on page 22](#).

After the printer enters Dump mode, it tells you it has entered Dump mode by printing it on a label. The display shows the Dump mode icon and printer is ready to receive data.

While the printer is receiving data, the Ready-to-Work indicator blinks. After a half of a second, if no more characters have been received, the printer times out. The program considers the transmission terminated and prints out a label.

Printable characters are printed in black-on-white. Control characters and space characters (ASCII 000 to 032 dec) are printed in white-on-black.

As long as a continuous string of characters is being received, the program wraps the lines until the label is full and then starts to print another label. After each character transmission, the following information prints:

- Page number
- Number of characters printed on the label
- Total number of characters received so far

When you exit Dump mode, a final label prints to inform you that it is exiting from Dump mode.

Using Dump Mode in IPL

When you enter Dump mode, the printer captures incoming characters on the communication ports and prints them on one or more labels.

If you have IPL firmware on your printer, you can access Dump mode in two different ways with slightly different results:

- You can access Dump mode through Test mode or Extended Test mode and you will receive printouts that look exactly like those produced with the Line Analyzer program in Fingerprint. For more information, see the previous procedure, [“Using the Line Analyzer in Fingerprint” on page 46](#).
- You can access Dump mode from the Setup menu. If you access Dump mode this way, characters are printed on a continuous line along with corresponding hexadecimal numbers.

To enter Dump mode from the Setup menu

- 1 Press the **Setup** button.
- 2 Press **➤** until you reach **Test/Service**.
- 3 Press **OK** to enter the Test/Service menu.
- 4 Press **➤** until you reach **Data Dump** and then press **OK**.
- 5 Press **➤** to select Yes and then press **OK**.
- 6 Cold boot the printer to exit Dump mode. For help, see the next procedure, “Cold Booting the PB21/PB31.”

Resetting the PB21/PB31

You rarely need to reset the PB21/PB31 printer, unless you are upgrading the firmware. If your printer occasionally locks up, you will want to reset it. A reset reinitializes the 802.11 radio and clears the working memory.



Note: The Setup menu is not affected by a reset. Your printer retains all of your configuration settings after the printer powers back up.

To reset the PB21/PB31

- 1 Disconnect the PB21/PB31 from power if externally powered.
- 2 Remove the battery from the PB21/PB31 for at least one second.
- 3 Insert the battery back into the PB21/PB31.
- 4 Reconnect external power if your PB21/PB31 is externally powered.

Upgrading the Firmware

The latest firmware and software is always available for download from the Intermec web site at www.intermec.com.

To download firmware updates

- 1 Go to the Intermec web site at www.intermec.com.
- 2 Click **Products > Printers and Media > Mobile Printers**.
- 3 Choose a PB21 or PB31 mobile printer.
- 4 Click the **Downloads** tab to download the latest firmware version to your computer.



Note: All of the printer languages are integrated in a single firmware version.

- 5 Extract the .zip file to a folder on your computer.

You have options for upgrading the firmware based on whether your PB21/PB31 has a Bluetooth radio or an 802.11 b/g radio. Use one of the following procedures to upgrade your printer firmware. Your printer should reboot after you finish upgrading the firmware. If it does not reboot, you will need to cold boot the printer. For help, see **“Resetting the PB21/PB31” on page 48.**

To upgrade your printer using PrintSet

- 1 Download the latest version of PrintSet from the Intermec web site at www.intermec.com.
- 2 Select **File > Add Printer** to start the Add Printer Wizard which guides you through the process of adding your printer.
- 3 Select your printer under My Printers and then go to **Printer > Firmware Wizard**.

The Firmware Wizard guides you through the necessary steps to update your firmware.

To upgrade your printer using a serial connection

- 1 Make sure you have established a serial communications between your PC and the PB21/PB31. For help, see **“Setting Up Serial Communications” on page 37.**
- 2 Use Fingerprint, IPL, or ESC/P commands to send the upgrade file to the printer.

For help with Fingerprint, IPL, ESC/P, or SmartSystems Foundation commands and information, see either the *Fingerprint Command Reference Manual*, the *IPL Command Reference Manual*, the *ESC/P Programmer’s Reference Manual*, or SmartSystems Foundation online help. You can download these documents from the Intermec web site at www.intermec.com.

Cleaning the Printer

To properly maintain your PB21/PB31, you should clean it at the recommended intervals.



To avoid possible personal injury or damage to the printer, never insert any pointed or sharp objects into the printer.



Use only the cleaning agents specified in this section. Intermec is not responsible for damage caused by any other cleaning materials used on this printer.

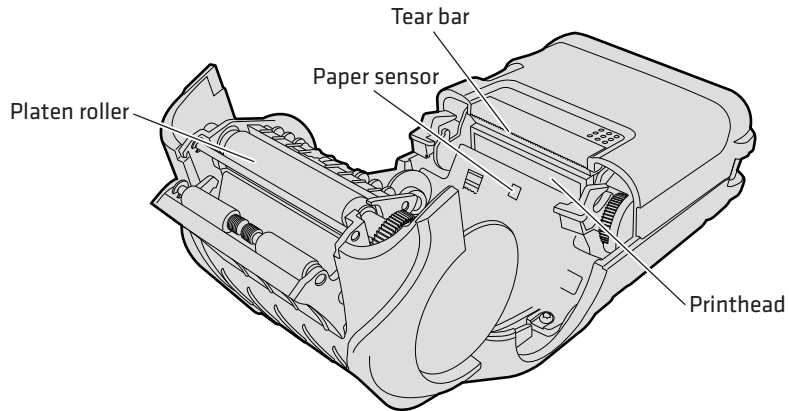

PB21/PB31 Mobile Receipt Printer: Identifying the parts of the PB21/PB31 to clean regularly

Cleaning the PB21/PB31 Printer

Printer Part	Cleaning Method	Cleaning Interval
Platen Roller	Rotate the platen roller and clean it thoroughly with the adhesive removal swab.	After every five rolls of media or more often if necessary.
Paper sensors	Clean thoroughly with the adhesive removal swab.	After every five rolls of media or more often if necessary.

Cleaning the PB21/PB31 Printer (continued)

Printer Part	Cleaning Method	Cleaning Interval
Printhead	Clean thoroughly with the adhesive removal swab.	After every five rolls of media or more often if necessary.
Tear bar	Clean thoroughly with the adhesive removal swab.	As needed.
Exterior	Clean with a water-dampened cloth.	As needed.
Interior	Brush or air blow. Make sure the paper sensors are free of dust.	After every five rolls of media or more often if necessary.

A

Specifications

Specifications

Physical Dimensions

PB21

Depth:	71.1 mm (2.8 in)
Height:	176.4 mm (6.9 in)
Width:	101.6 mm (4.0 in)
Weight:	680 g (1.5 lb) with battery

PB31

Depth:	81.6 mm (3.21 in)
Height:	182.2 mm (7.2 in)
Width:	127.6 mm (5.0 in)
Weight:	830 g (1.8 lb) with battery

Power Specifications

AC power adapter voltage:	100 to 240 V, 47 to 63 Hz
Printer voltage:	12 VDC, 4.15 A
Operating power:	Rechargeable 7.2 V 2250 mAh lithium-ion battery

Temperature and Humidity Specifications

Operating temperature:	-20°C to 50°C (-4°F to 122°F)
Storage temperature:	-40°C to 70°C (-40°F to 158°F)
Charging temperature:	0°C to 45°C (32°F to 113°F)
Relative humidity:	10 to 90% non-condensing
Sealing:	IP54

Memory

RAM:	16 MB
Flash:	64 MB

Print Speed and Resolution

Print speed:	4 ips (100 mm/s)
Resolution:	203 dpi (8 dots/mm)

Print Technology

Printhead:	Direct thermal
Maximum print width:	PB21 48mm (1.8 in) PB31 72mm (2.8 in)

Media Specifications

Minimum black mark length:	3.17 mm (0.125 in)
Minimum black mark, and notch length:	12.7 mm (0.50 in)
Minimum notch length:	6.35 mm (0.25 in)
Minimum notch width:	12.7 mm (0.50 in)
Black mark width:	Full width of media
Core inside diameter:	19.05 mm (0.75 in)
Roll outside diameter:	PB21 57.15 mm (2.25 in) PB31 67.31 mm (2.65 in)
Tracking	Center
Maximum caliper for tags:	0.15 mm (0.006 in)
Minimum media length:	12.7 mm (0.5 in)
Maximum media length:	Continuous

Receipt roll stock media is supplied as a continuous roll. Tag, and fanfold media use repeat indicators for non-continuous media. Gap, notch, and black marks are used as repeat indicators:

- **Notch:** Tag media
- **Black mark:** Tag, and fanfold media

Here are a few things to keep in mind when ordering media for the PB21/PB31 printer:

- Black marks can be sensed on the front side of the media.

Appendix A – Specifications

- You can use higher caliper media in the printer, but print quality will be reduced.
- Receipt roll stock media has an end of roll indicator. The end of roll indicator is a red marking (on last 3 feet of roll) on the thermally sensitive side of the paper.

External Fanfold Media Specifications

Stack height: 70 mm (2.75 in)

Page length: 152 mm (6 in) to 305 mm (12 in)



Note: A 6-inch page length is supplied in 12-inch long stacks (two 6-inch stacks of equal height with the bottom page linked).

Specialty media is required for unique customer environments, including printer operating temperature extremes. Intermec recommends that you test the media in your application.

Supported Media

The PB21/PB31 printer supports tag, and receipt media. Receipt media is supported in both a top coated and an uncoated paper in continuous roll stock only.

The default media sensitivity number is: 180.

Use the following table as a guide when setting sensitivity numbers.

Recommended Media Sensitivity and Constant

Sensitivity	Constant	Description
North America Receipt Media		
401	85	Duratherm TC
102	32	Duratherm NTC - 2
101	30	Duratherm NTC
180	80	Duratherm Receipt - Fanfold
103	100	Duratherm Linerless

Accessories for the PB21/PB31

You can use these accessories with the PB21/PB31 printer. To order accessories, contact your local Intermec sales representative.

AB27 Battery

Use the lithium-ion 2250 mAh battery to provide power to the printer.

AC18 4-Bay Battery Charger

Use the AC18 to charge up to four batteries at a time. The battery charger is designed to sense when a battery is fully charged and not overcharge it, ensuring long and consistent battery life.

AV14 Vehicle Dock

Use the vehicle dock to attach the PB21/PB31 to a truck.

Belt Clip

Use the PB21/PB31 belt clip to attach the printer to your belt.

Handstrap

Use the PB42 and PB21/PB31 handstrap to conveniently carry your PB21/PB31 printer. With the handstrap attached, you can also attach the shoulder strap.

Power Supply (Model AE19)

Provides power to the PB21/PB31 and the 4-bay battery charger (Model AC18).

Serial Cable

The serial adapter is an 8-pin DIN to DB9 connector that connects from the PB21/PB31 printer to your desktop PC.

Shoulder Strap

Use the shoulder strap in combination with the handstrap to easily carry the PB21/PB31 printer. The wide padded strap makes it comfortable to wear the printer for long periods of time.

Cart Mount

Stands the printer vertically when placed on a flat surface. Excellent for cart or desktop use.

Appendix A – Specifications

B

Default Settings

Factory Default Settings (Fingerprint Printers)

Factory Default Settings for Fingerprint Printers

Setting	Default Value
Xstart	0
Display	
Orientation	Normal
Contrast	Medium
Media	
Width	Printhead width
Length	1200
Test feed mode	Fast
Type	Variable length strip
Contrast	0%
Xstart	0
Label constant	85
Label factor	40
Print definitions	
Clip default	Off
Print speed	75 mm/s
Feed adjust	
Start adjust	0
Stop adjust	0
Power	
Low battery indicator	7.4 V
Sleep timer	20 sec
Standby timer	30 min
Bluetooth	
Discoverable	Enable
Connectable	Enable
Encryption	Disable
Authentication	Disable
Reserve printer	Disable
Device name	1-16 characters

Factory Default Settings for Fingerprint Printers (continued)

Setting	Default Value
Passcode	1234

Factory Default Settings (IPL Printers)

Factory Default Settings for IPL Printers

Setting	Default Value
Auto detect printer	Enable
Display	
Orientation	Normal
Contrast	Medium
Print engine emulation mode	None
Media	
Form adjust dots X	0
Form adjust dots Y	0
Test feed mode	Fast
Media type	Continuous
Darkness	0
Sensitivity	180
Print speed	3 ips
Power	
Low battery indicator	7.4 V
Sleep timer	20 sec
Standby timer	30 min
Ser-Com	
Baud rate	115200
Data bits	8
Parity	None
Stop bits	1
Protocol	XON/XOFF
# Network	
IP selection	DHCP and BOOTP

Factory Default Settings for IPL Printers (continued)

Setting	Default Value
IP address	0.0.0.0
Netmask	0.0.0.0
Default router	0.0.0.0
Name server	0.0.0.0
MAC address	Unique
Bluetooth	
Discoverable	Enable
Connectable	Enable
Encryption	Disable
Authentication	Disable
Reserve printer	Disable
Device name	1-16 characters
Passcode	1234

Factory Default Settings (ESC/P Printers)**Factory Default Settings for ESC/P Printers**

Setting	Default Value
Auto detect printer	Enable
Media dark adjust	100
Print speed	75 mm/s
Power	
Low battery indicator	7.4 V
Sleep timer	20 sec
Standby timer	30 min
Bluetooth	
Discoverable	Enable
Connectable	Enable
Encryption	Disable
Authentication	Disable
Reserve printer	Disable

Factory Default Settings for ESC/P Printers (continued)

Setting	Default Value
Device name	1-16 characters
Passcode	1234
Serial-Com	
Baud rate	115200
Data bits	8
Parity	None
Stop bits	1
Protocol	XON/XOFF
# Network	
IP selection	DHCP and BOOTP
IP address	0.0.0.0
Netmask	0.0.0.0
Default router	0.0.0.0
Name server	0.0.0.0
MAC address	Unique

Appendix B – Default Settings



C

IPL and Fingerprint Setup Menus

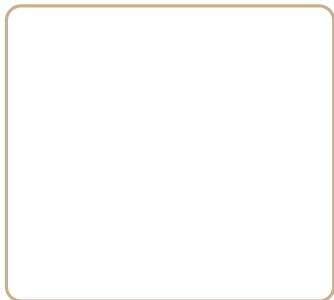

IPL Setup Menu

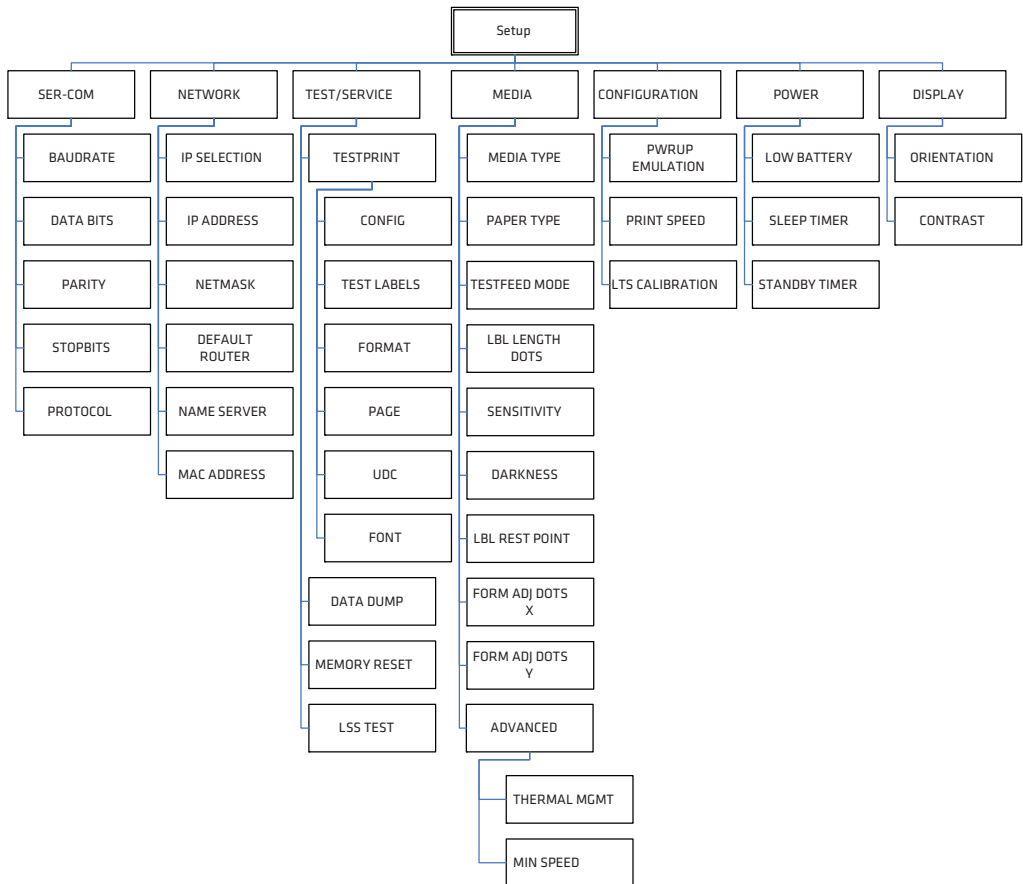

Fingerprint Setup Menu

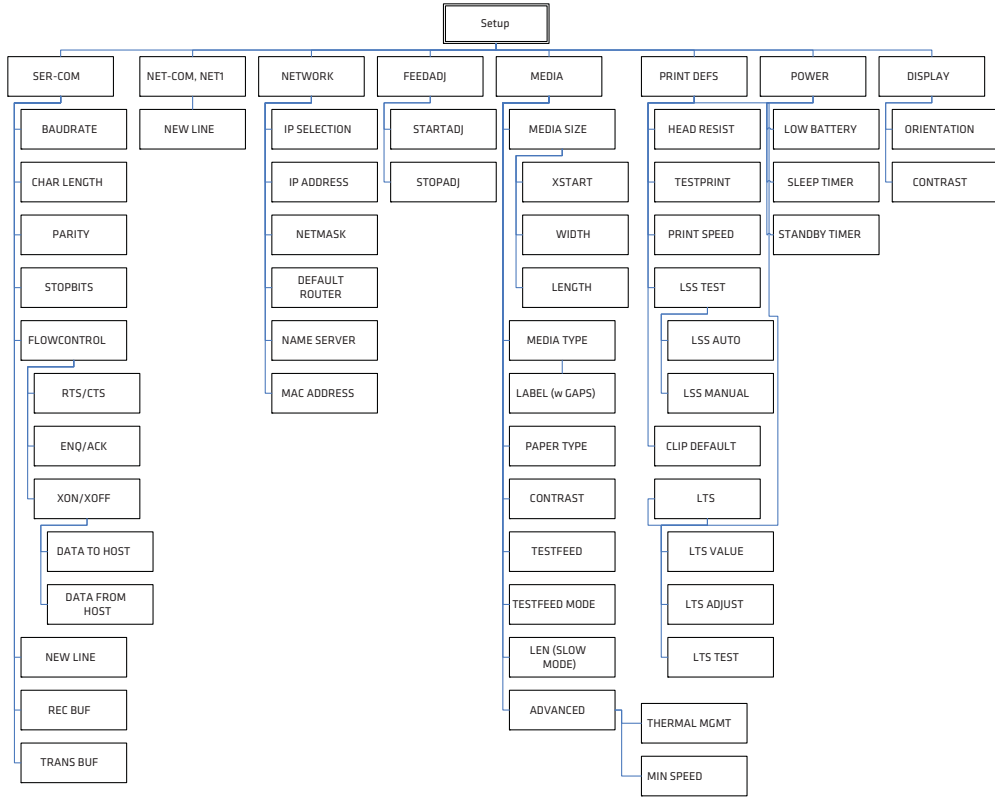

Appendix C – IPL and Fingerprint Setup Menus

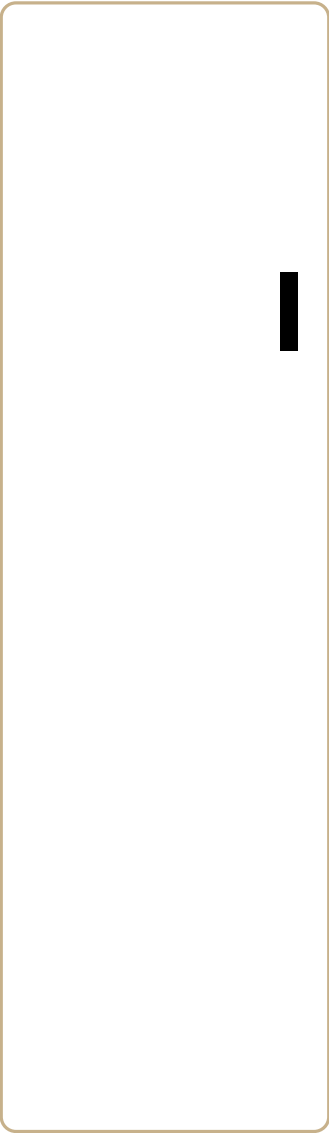

Index



Numerics

- 802.11
 - radio icons, understanding 31
 - setting up communications 30

A

- AB27 battery 57
- AC18 battery charger 9, 57
- accessories
 - AB27 battery 57
 - AC18 battery charger 57
 - AV14 vehicle dock 57
 - belt clip 57
 - cart mount 57
 - handstrap 57
 - power supply 57
 - serial cable 57
 - shoulder strap 57
- AV14 vehicle dock 57

B

- backlight, understanding 6
- batteries
 - AC18 charger 9
 - charging 9
 - charging time 7
 - extending life 10
 - installing 7
 - status icons 9
 - using 7
- Bluetooth communications 28
- button functions 3

C

- cleaning the printer 50
- cold boot 48
- communication problems 46
 - using Dump mode in IPL 47
 - using the line analyzer in
 - Fingerprint 46
- communications
 - establishing with a host 28
 - setting up 802.11 radio
 - communications 30
 - setting up Bluetooth radio
 - communications 28
 - setting up serial 37
 - setting up USB 37
 - wireless printing with
 - Fingerprint 35
 - wireless printing with IPL 32
- configurartion settings

- display modes 18
- configuration
 - settings
 - changing 18
- configuration settings
 - changing from printer home
 - page 26
 - changing using the command
 - line
 - HyperTerminal, sending
 - printer commands 25
 - changing with PrintSet 25
 - changing with SmartSystems 26
- control panel features 3
- copyright information ii

D

- default settings
 - ESC/P printers 62
 - Fingerprint printers 60
 - IPL printers 61
- display modes
 - error 21
 - information 19
 - pause 19
 - ready 18
 - setup 20
 - test 22
- display settings,changing the
 - printer language 27
- documents
 - downloading viii
 - related viii
- downloading fonts and graphics 39

E

- error messages and icons
 - door open 44
 - field out of label 43
 - IP configuration error 43
 - IP link error 43
 - LSS too high/low 43
 - out of paper 43
 - pause 43
 - printead hot 43
 - upgrading 43
- Error mode 21
- ESC/P
 - change printer language 27
 - default settings 62
 - setup commands 25

F

- Fingerprint
 - change printer language 27
 - configuring wireless printing 35
 - default settings 60
 - setup menu 24, 67
 - WEP
 - authentication,configuring to use 35
 - WPA/WPA2
 - authentication,configuring to use 36
 - WPA-PSK/WPA2-PSK
 - authentication,configuring to use 35
- firmware update
 - downloading 48
 - serial connection 49
 - using PrintSet 49
- firmware upgrade
 - cold boot 48

H

- HyperTerminal
 - changing printer language 27
 - view IPL commands 26

I

- Information mode 19
- information, safety vi
- information, warranty vi
- IPL
 - change printer language 27
 - configuring wireless printing 32
 - default settings 61
 - setup commands 25
 - setup menu 66
 - view commands as you type 26
 - WEP
 - authentication,configuring to use 32
 - WPA/WPA2
 - authentication,configuring to use 33
 - WPA-PSK/WPA2-PSK
 - authentication,configuring to use 33

L

- load media 11

M

- media
 - loading 11
 - recommended sensitivity and constant 56
 - supported 56
- media specifications 55

P

- Pause mode 19
- power specifications 54
- print speed and resolution 55
- printer
 - accessories 57
 - available languages 27
 - backlight 6
 - charging batteries 9
 - cleaning 50
 - cold boot 48
 - communication problems 46
 - configuring 18
 - control panel 3
 - default settings 60
 - downloading fonts and graphics 39
 - features 2
 - firmware upgrade 48
 - home page 26
 - languages,choosing 5
 - loading media 11
 - memory 54
 - parts 2
 - printing a test page 13
 - Rey-to-Work indicator 5
 - soft keys 4
 - sounds, understanding 6
 - specifications 54
 - troubleshooting problems 44
 - using the batteries 7
 - using the buttons 3
- printer language
 - change using display settings 27
 - change using ESC/P 27
 - change using Fingerprint 27
 - change using IPL 27
- PrintSet
 - changing configuration settings 25
 - downloading fonts and graphics 39
 - firmware update 49

R

- Ready mode 18
- Ready-to-Work indicator states 5
- returns and repairs vi

S

- safety information vi
- serial communications
 - port settings 38
 - setting up 37
- service location support vii
- service locations, South Korea vii
- setup commands
 - ESC/P 25
 - IPL 25
- setup menu
 - Fingerprint 24, 67
 - IPL 66
- Setup mode 20
- SmartSystems
 - downloading 26
- SmartSystems, changing
 - configuration settings 26
- soft keys, using 4
- sounds, status 6
- specifications
 - external fanfold media 56
 - media 55
 - memory 54
 - physical dimensions 54
 - power 54
 - print speed and resolution 55
 - print technology 55
 - supported media 56
 - temperature and humidity 54
- support, telephone vii

- support, web vii

T

- telephone support vii
- temperature and humidity
 - specifications 54
- Tes mode 22
- test page, printing 13
- troubleshooting
 - communication problems 46
 - contacting product support 42
 - error messages 42
 - printer problems and solutions 44
 - using Dump mode in IPL 47
 - using the line analyzer in Fingerprint 46

U

- USB communications, setting up 37

W

- warranty information vi
- web support vii
- WEP authentication
 - configuring with Fingerprint 35
 - configuring with IPL 32
- WPA/WPA2 authentication
 - configuring with Fingerprint 36
 - configuring with IPL 33
- WPA-PSK/WPA2-PSK authentication
 - configuring with Fingerprint 35
 - configuring with IPL 33



Worldwide Headquarters
6001 36th Avenue West
Everett, Washington 98203
U.S.A.

tel 425.348.2600

fax 425.355.9551

www.intermec.com

© 2009 Intermec Technologies
Corporation. All rights reserved.

PB21/PB31 Mobile Receipt Printer User's Guide



P/N 934-051-001

