

**LevelOne**

**KVM-0891**

**19" Widescreen LCD KVM Rack Console**

*Quick Installation Guide*

## Package Checklist

KVM-8901  
Rail with front and rear bracket x 2  
Long brackets x 2  
Power cord / Power Adapter  
3 M cable (PS/2 mouse, PS/2 keyboard, DB15 VGA) x 1, USB x 1  
Quick Installation Guide  
CD (User Manual, QIG)  
Screws

## Introduction

The LCD drawer, a modularized design, has a 19"-wide screen TFT LCD panel, a 105-key keyboard, and a touchpad.

"KVM-8901" is the 3-in-1 model (LCD, Keyboard, and Touchpad), while "KCM-0832" and "KCM-1632" is the 4-in-1 model (LCD, keyboard, Touchpad and KVM). The power source of all the models is +12V DC-in from an external power adapter.

## Hardware Installation

Below is the steps to install the LCD drawer with the standard 19-inch cabinet.

### Step 1:

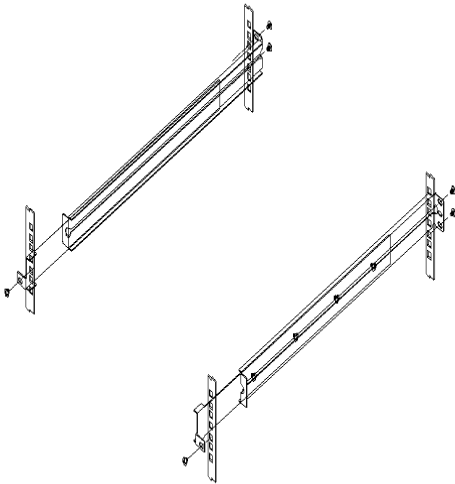

Figure 1: Attach the left and right mounting rails

### Step 2:

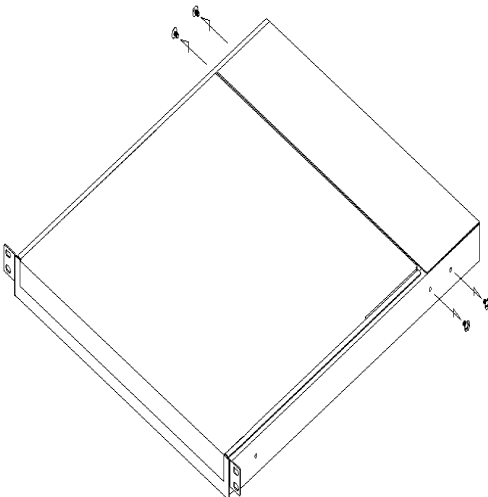

Figure 2: Remove the screws

### Step 3:

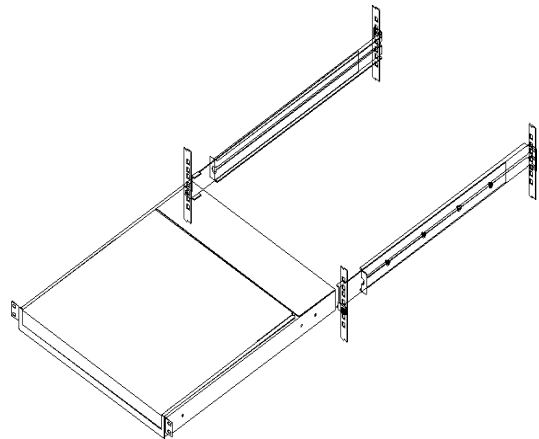

Figure 3: Let the LCD drawer slide-in the rack mount bracket

### Step 4:

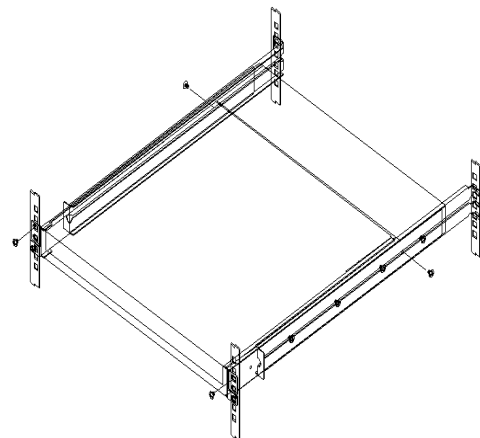

Figure 4: Screw-in the LCD drawer at the left/right position