

# PowerShot SX60 HS

## Camera User Guide

ENGLISH

- Make sure you read this guide, including the “Safety Precautions” (📖 14) section, before using the camera.
- Reading this guide will help you learn to use the camera properly.
- Store this guide safely so that you can use it in the future.

- Click the buttons in the lower right to access other pages.

: Next page

: Previous page

: Page before you clicked a link

- To jump to the beginning of a chapter, click the chapter title at right.

Before Use

Basic Guide

Advanced Guide

**1** Camera Basics

**2** Auto Mode /  
Hybrid Auto Mode

**3** Other Shooting Modes

**4** P Mode

**5** Tv, Av, M, C1, and C2 Mode

**6** Playback Mode

**7** Wi-Fi Functions

**8** Setting Menu

**9** Accessories

**10** Appendix

Index

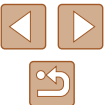

# Before Use

## Initial Information

### Package Contents

Before use, make sure the following items are included in the package. If anything is missing, contact your camera retailer.



Camera

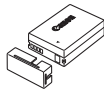

Battery Pack  
NB-10L  
(with terminal cover)



Battery Charger  
CB-2LC/CB-2LCE



Neck Strap



Lens Cap  
(with cord)

- Printed matter is also included.
- A memory card is not included (📖2).

## Compatible Memory Cards

The following memory cards (sold separately) can be used, regardless of capacity.

- SD memory cards\*1
- SDHC memory cards \*1\*2
- SDXC memory cards\*1\*2



\*1 Cards conforming to SD standards. However, not all memory cards have been verified to work with the camera.

\*2 UHS-I memory cards are also supported.

Before Use

Basic Guide

Advanced Guide

**1** Camera Basics

**2** Auto Mode /  
Hybrid Auto Mode

**3** Other Shooting Modes

**4** P Mode

**5** Tv, Av, M, C1, and C2 Mode

**6** Playback Mode

**7** Wi-Fi Functions

**8** Setting Menu

**9** Accessories

**10** Appendix

Index

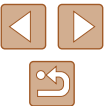

## Preliminary Notes and Legal Information

- Take and review some test shots initially to make sure the images were recorded correctly. Please note that Canon Inc., its subsidiaries and affiliates, and its distributors are not liable for any consequential damages arising from any malfunction of a camera or accessory, including memory cards, that result in the failure of an image to be recorded or to be recorded in a way that is machine readable.
- Images recorded by the camera shall be for personal use. Refrain from unauthorized recording that infringes on copyright law, and note that even for personal use, photography may contravene copyright or other legal rights at some performances or exhibitions, or in some commercial settings.
- The camera warranty is valid only in the area of purchase. In case of camera problems while abroad, return to the area of purchase before contacting a Canon Customer Support Help Desk.
- Although the LCD monitor and viewfinder are produced under extremely high-precision manufacturing conditions and more than 99.99% of the pixels meet design specifications, in rare cases some pixels may be defective or may appear as red or black dots. This does not indicate camera damage or affect recorded images.
- The LCD monitor may be covered with a thin plastic film for protection against scratches during shipment. If covered, remove the film before using the camera.
- When the camera is used over an extended period, it may become warm. This does not indicate damage.

## Part Names and Conventions in This Guide

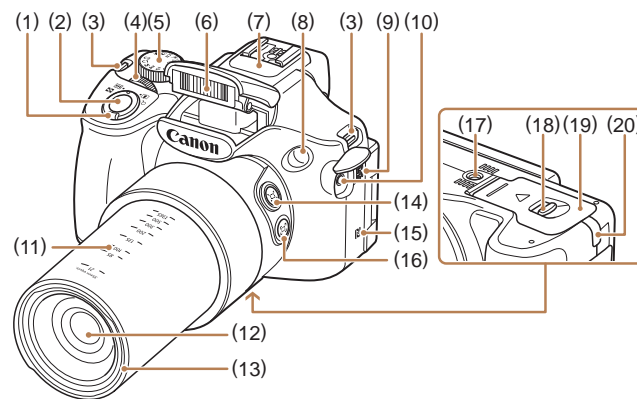

- |   |   |
|---|---|
| (1) Zoom lever<br>Shooting: [▲] (telephoto) / [■] (wide angle)<br>Playback: [Q] (magnify) / [■] (index) | (10) External microphone IN terminal    |
| (2) Shutter button  | (11) Focal length markings (approx.)    |
| (3) Strap mount   | (12) Lens                               |
| (4) Front dial  | (13) Lens hood/filter adapter mount     |
| (5) Mode dial   | (14) [◻] (Framing Assist – Seek) button |
| (6) Flash   | (15) [N] (N-Mark)*                      |
| (7) Microphone  | (16) [◻] (Framing Assist – Lock) button |
| (8) Lamp  | (17) Tripod socket                      |
| (9) Speaker   | (18) Lock release switch                |
|   | (19) Memory card/battery cover          |
|   | (20) DC coupler cable port              |

\* Used with NFC features (123).

Before Use

Basic Guide

Advanced Guide

**1** Camera Basics

**2** Auto Mode / Hybrid Auto Mode

**3** Other Shooting Modes

**4** P Mode

**5** Tv, Av, M, C1, and C2 Mode

**6** Playback Mode

**7** Wi-Fi Functions

**8** Setting Menu

**9** Accessories

**10** Appendix

Index



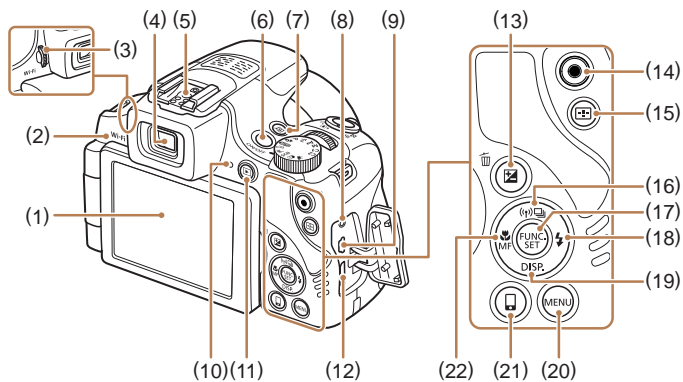

- |  |  |
|--|--|
| (1) Screen (LCD monitor)                                   | (14) Movie button                                |
| (2) Wi-Fi antenna area                                     | (15) [AF frame selector] button                  |
| (3) Diopter adjustment dial                                | (16) [(Wi-Fi)] / [Single shot] / Up button       |
| (4) Viewfinder   | (17) FUNC./SET button                            |
| (5) Hot shoe   | (18) [Flash] / Right button                      |
| (6) Power button   | (19) [DISP. (Display)] / Down button             |
| (7) [S] (Shortcut) button                                  | (20) [MENU] button                               |
| (8) Remote terminal  | (21) [Mobile Device Connection] button           |
| (9) AV OUT (Audio/video output) / DIGITAL terminal         | (22) [Macro] / [MF (Manual focus)] / Left button |
| (10) Indicator   |  |
| (11) [Play] (Playback) button                              |  |
| (12) HDMI™ terminal  |  |
| (13) [Exposure compensation] / [Single-image erase] button |  |

- In this guide, icons are used to represent the corresponding camera buttons and dials on which they appear or which they resemble.
- The following camera buttons and controls are represented by icons.
 

[Sun icon]	Front dial (4) on front	[Right arrow]	Right button (18) on back
[Up arrow]	Up button (16) on back	[Down arrow]	Down button (19) on back
[Left arrow]	Left button (22) on back		
- Shooting modes and on-screen icons and text are indicated in brackets.
- ⓘ: Important information you should know
- 📌: Notes and tips for expert camera use
- 📖xx: Pages with related information (in this example, “xx” represents a page number)
- Instructions in this guide apply to the camera under default settings.
- For convenience, all supported memory cards are simply referred to as the “memory card”.
- The symbols “▶ Still Images” and “▶ Movies” below titles indicate how the function is used—whether for still images or movies.

Before Use
Basic Guide
Advanced Guide
<b>1</b> Camera Basics
<b>2</b> Auto Mode / Hybrid Auto Mode
<b>3</b> Other Shooting Modes
<b>4</b> P Mode
<b>5</b> Tv, Av, M, C1, and C2 Mode
<b>6</b> Playback Mode
<b>7</b> Wi-Fi Functions
<b>8</b> Setting Menu
<b>9</b> Accessories
<b>10</b> Appendix
Index



# Table of Contents

## Before Use

<b>Initial Information</b> .....	<b>2</b>
Package Contents .....	2
Compatible Memory Cards.....	2
Preliminary Notes and Legal Information .....	3
Part Names and Conventions in This Guide .....	3
Common Camera Operations .....	12
Safety Precautions .....	14

## Basic Guide

<b>Basic Operations</b> .....	<b>17</b>
Initial Preparations.....	17
Attaching Accessories .....	17
Holding the Camera.....	18
Charging the Battery Pack.....	18
Inserting the Battery Pack and Memory Card.....	19
Using the Screen .....	20
Adjusting the Screen Angle and Orientation.....	20
Setting the Date and Time .....	20
Changing the Date and Time.....	21
Display Language.....	21
Trying the Camera Out.....	22
Shooting (Smart Auto) .....	22
Viewing .....	24
Erasing Images .....	24

## Advanced Guide

<b>1 Camera Basics</b> .....	<b>25</b>
On/Off .....	25
Power-Saving Features (Auto Power Down).....	26
Power Saving in Shooting Mode .....	26
Power Saving in Playback Mode.....	26
Shutter Button .....	26
Viewfinder.....	27
Shooting Modes .....	27
Shooting Display Options .....	28
Using the FUNC. Menu .....	29
Using the Menu Screen.....	30
On-Screen Keyboard.....	31
Indicator Display.....	32
Clock .....	32
<b>2 Auto Mode / Hybrid Auto Mode</b> .....	<b>33</b>
Shooting with Camera-Determined Settings .....	33
Shooting (Smart Auto) .....	33
Shooting in Hybrid Auto Mode .....	35
Digest Movie Playback .....	36
Still Images/Movies .....	36
Still Images.....	36
Movies .....	37
Scene Icons.....	37
Continuous Shooting Scenes .....	38
Image Stabilization Icons.....	39
On-Screen Frames.....	39
Common, Convenient Features .....	40
Zooming In Closer on Subjects (Digital Zoom).....	40

Before Use
Basic Guide
Advanced Guide
<b>1 Camera Basics</b>
<b>2 Auto Mode / Hybrid Auto Mode</b>
<b>3 Other Shooting Modes</b>
<b>4 P Mode</b>
<b>5 Tv, Av, M, C1, and C2 Mode</b>
<b>6 Playback Mode</b>
<b>7 Wi-Fi Functions</b>
<b>8 Setting Menu</b>
<b>9 Accessories</b>
<b>10 Appendix</b>
Index

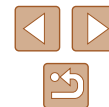

Easily Reacquiring Subjects after Manual Zooming (Framing Assist – Seek) .....	40
Easily Composing Shots after Manual Zooming (Framing Assist – Lock) .....	41
Auto Zooming to Keep Faces at a Constant Size .....	42
Adjusting the Constant Face Display Size .....	42
Easily Reacquiring Subjects with Auto Zooming (Seek Assist) .....	43
Using the Self-Timer .....	44
Using the Self-Timer to Avoid Camera Shake .....	44
Customizing the Self-Timer .....	44
Adding a Date Stamp .....	45
Continuous Shooting .....	46
Image Display during Playback .....	46
Using Face ID .....	47
Personal Information .....	47
Registering Face ID Information .....	47
Shooting .....	48
Checking and Editing Registered Information .....	49
Overwriting and Adding Face Information .....	50
Erasing Registered Information .....	51
Image Customization Features .....	51
Changing the Aspect Ratio .....	51
Changing Image Resolution (Size) .....	52
Guidelines for Choosing Resolution Based on Paper Size (for 4:3 Images) .....	52
Red-Eye Correction .....	52
Correcting Greenish Image Areas from Mercury Lamps .....	53
Changing Movie Image Quality .....	53
Helpful Shooting Features .....	54
Using the Electronic Level .....	54
Magnifying the Area in Focus .....	54

Checking for Closed Eyes .....	55
Customizing Camera Operation .....	55
Deactivating the AF-Assist Beam .....	55
Deactivating the Red-Eye Reduction Lamp .....	55
Changing the Image Display Style after Shots .....	56
Changing the Image Display Period after Shots .....	56
Changing the Screen Displayed after Shots .....	56
<b>3 Other Shooting Modes .....</b>	<b>57</b>
Enjoying a Variety of Images from Each Shot (Creative Shot) .....	57
Choosing Effects .....	58
Moving Subjects (Sports) .....	58
Specific Scenes .....	59
Image Effects (Creative Filters) .....	60
Shooting High-Contrast Scenes (High Dynamic Range) .....	61
Adding Artistic Effects .....	61
Shooting with a Fish-Eye Lens Effect (Fish-Eye Effect) .....	62
Shots Resembling Miniature Models (Miniature Effect) .....	62
Playback Speed and Estimated Playback Time (for One-Minute Clips) .....	63
Shooting with a Toy Camera Effect (Toy Camera Effect) .....	63
Shooting with a Soft Focus Effect .....	64
Shooting in Monochrome .....	64
Special Modes for Other Purposes .....	65
Auto Shooting after Face Detection (Smart Shutter) .....	65
Auto Shooting after Smile Detection .....	65
Using the Wink Self-Timer .....	65
Using the Face Self-Timer .....	66
Shooting Various Movies .....	67
Shooting Movies in Movie Mode .....	67
Locking or Changing Image Brightness before Shooting .....	68

Before Use
Basic Guide
Advanced Guide
<b>1</b> Camera Basics
<b>2</b> Auto Mode / Hybrid Auto Mode
<b>3</b> Other Shooting Modes
<b>4</b> P Mode
<b>5</b> Tv, Av, M, C1, and C2 Mode
<b>6</b> Playback Mode
<b>7</b> Wi-Fi Functions
<b>8</b> Setting Menu
<b>9</b> Accessories
<b>10</b> Appendix
Index



Sound Settings .....	68	Storing the Zoom Position .....	81
Adjusting the Recording Volume .....	68	Storing the Focal Position .....	81
Deactivating the Wind Filter .....	69	Digital Tele-Converter .....	81
Using the Attenuator .....	69	Changing the AF Frame Mode .....	82
Shooting iFrame Movies .....	69	FlexiZone/Center .....	82
Shooting Super Slow Motion Movies .....	70	Moving and Resizing AF Frames (FlexiZone) .....	82
<b>4 P Mode .....</b>	<b>71</b>	Face Detect .....	83
Shooting in Program AE ([P] Mode) .....	71	Choosing Subjects to Focus On (Tracking AF) .....	83
Image Brightness (Exposure) .....	72	Shooting with Servo AF .....	84
Adjusting Image Brightness (Exposure Compensation) .....	72	Changing the Focus Setting .....	84
Locking Image Brightness / Exposure (AE Lock) .....	72	Choosing a Person to Focus On (Face Select) .....	85
Changing the Metering Method .....	72	Shooting with the AF Lock .....	85
Linking the Spot AE Point Frame to the AF Frame .....	73	Shooting Continuously as the Camera Keeps the Subject in Focus .....	86
Changing the ISO Speed .....	73	Flash .....	86
Adjusting ISO Auto Settings .....	74	Changing the Flash Mode .....	86
Changing the Noise Reduction Level (High ISO NR) .....	74	Auto .....	86
Auto Exposure Bracketing (AEB Shooting) .....	74	On .....	86
Correcting Image Brightness (i-Contrast) .....	75	Slow Synchro .....	87
Dynamic Range Correction (DR Correction) .....	75	Off .....	87
Shadow Correct .....	76	Adjusting the Flash Exposure Compensation .....	87
Image Colors .....	76	Shooting with the FE Lock .....	88
Adjusting White Balance .....	76	Changing the Flash Timing .....	88
Custom White Balance .....	77	Shooting RAW Images .....	89
Manually Correcting White Balance .....	77	Other Settings .....	90
Changing Image Color Tones (My Colors) .....	77	Changing the Compression Ratio (Image Quality) .....	90
Custom Color .....	78	Changing the IS Mode Settings .....	90
Shooting Range and Focusing .....	79	Shooting Movies with Subjects at the Same Size Shown before Shooting .....	91
Shooting Close-Ups (Macro) .....	79		
Shooting in Manual Focus Mode .....	79		
Easily Identifying the Focus Area (MF Peaking) .....	80		
Focus Bracketing (Focus-BKT Mode) .....	80		
Storing the Zoom or Focal Position .....	81		

Before Use
Basic Guide
Advanced Guide
<b>1</b> Camera Basics
<b>2</b> Auto Mode / Hybrid Auto Mode
<b>3</b> Other Shooting Modes
<b>4</b> P Mode
<b>5</b> Tv, Av, M, C1, and C2 Mode
<b>6</b> Playback Mode
<b>7</b> Wi-Fi Functions
<b>8</b> Setting Menu
<b>9</b> Accessories
<b>10</b> Appendix
Index

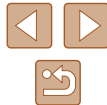

<b>5 Tv, Av, M, C1, and C2 Mode</b> .....	<b>92</b>
Specific Shutter Speeds ([Tv] Mode).....	92
Specific Aperture Values ([Av] Mode).....	93
Specific Shutter Speeds and Aperture Values ([M] Mode) .....	93
Adjusting the Flash Output .....	94
Recording Movies at Specific Shutter Speeds and Aperture Values .....	95
Changing Settings during Recording.....	95
Customization for Shooting Styles .....	96
Customizing Display Information .....	96
Assigning Functions to Buttons .....	96
Customizing the FUNC. Menu (FUNC. Menu Layout) .....	97
Choosing Items to Include in the Menu .....	97
Rearranging Menu Items .....	98
Saving Shooting Settings .....	98
Settings that can be saved .....	98
Saving Commonly Used Shooting Menu Items (My Menu).....	99
<b>6 Playback Mode</b> .....	<b>101</b>
Viewing.....	101
Switching Display Modes.....	102
Overexposure Warning (for Image Highlights) .....	103
Histogram .....	103
RGB Histogram, GPS Information Display .....	103
Viewing Short Movies Created When Shooting Still Images (Digest Movies).....	104
Viewing by Date.....	104
Checking People Detected in Face ID.....	104
Browsing and Filtering Images .....	105
Navigating through Images in an Index.....	105
Finding Images Matching Specified Conditions.....	105
Using the Front Dial to Jump between Images.....	106

Viewing Individual Images in a Group .....	107
Editing Face ID Information.....	107
Changing Names.....	107
Erasing Names .....	108
Image Viewing Options .....	108
Magnifying Images .....	108
Viewing Slideshows.....	109
Changing Slideshow Settings.....	109
Auto Playback of Related Images (Smart Shuffle) .....	110
Protecting Images .....	110
Choosing a Selection Method.....	110
Choosing Images Individually.....	111
Selecting a Range .....	111
Protecting All Images at Once .....	112
Clearing All Protection at Once .....	112
Erasing Images .....	112
Erasing Multiple Images at Once.....	113
Choosing a Selection Method .....	113
Choosing Images Individually.....	113
Selecting a Range .....	113
Specifying All Images at Once.....	114
Rotating Images .....	114
Deactivating Auto Rotation .....	115
Tagging Images as Favorites .....	115
Editing Still Images.....	116
Resizing Images .....	116
Cropping .....	117
Changing Image Color Tones (My Colors) .....	118
Correcting Image Brightness (i-Contrast).....	118
Correcting Red-Eye .....	119

<b>Before Use</b>
<b>Basic Guide</b>
<b>Advanced Guide</b>
<b>1 Camera Basics</b>
<b>2 Auto Mode / Hybrid Auto Mode</b>
<b>3 Other Shooting Modes</b>
<b>4 P Mode</b>
<b>5 Tv, Av, M, C1, and C2 Mode</b>
<b>6 Playback Mode</b>
<b>7 Wi-Fi Functions</b>
<b>8 Setting Menu</b>
<b>9 Accessories</b>
<b>10 Appendix</b>
<b>Index</b>

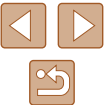



Editing Movies .....	120
Reducing File Sizes .....	121
Editing Digest Movies .....	121
<b>7 Wi-Fi Functions.....</b>	<b>122</b>
Available Wi-Fi Features .....	122
Sending Images to a Smartphone .....	123
Sending to a Smartphone Assigned to the Button .....	123
Adding a Smartphone Using the Wi-Fi Menu .....	125
Using Another Access Point .....	126
Previous Access Points .....	127
Saving Images to a Computer.....	127
Preparing to Register a Computer.....	127
Checking Your Computer Environment .....	127
Installing the Software .....	127
Configuring the Computer for a Wi-Fi Connection (Windows Only) .....	129
Saving Images to a Connected Computer.....	129
Confirming Access Point Compatibility .....	129
Using WPS-Compatible Access Points .....	130
Connecting to Listed Access Points .....	132
Previous Access Points .....	132
Sending Images to a Registered Web Service.....	133
Registering Web Services .....	133
Registering CANON iIMAGE GATEWAY.....	133
Registering Other Web Services .....	135
Uploading Images to Web Services .....	135
Printing Images Wirelessly from a Connected Printer.....	136
Sending Images to Another Camera .....	137
Image Sending Options.....	138
Notes on Sending Images .....	138
Choosing the Image Resolution (Size).....	139

Adding Comments .....	139
Sending Images Automatically (Image Sync).....	139
Initial Preparations .....	139
Preparing the Camera .....	139
Preparing the Computer .....	140
Sending Images.....	140
Using a Smartphone to View Camera Images and Control the Camera.....	141
Geotagging Images on the Camera .....	141
Shooting Remotely .....	142
Editing or Erasing Wi-Fi Settings.....	143
Editing Connection Information .....	143
Changing a Device Nickname .....	143
Erasing Connection Information .....	143
Returning the Wi-Fi Settings to Default .....	144
<b>8 Setting Menu.....</b>	<b>145</b>
Adjusting Basic Camera Functions .....	145
Silencing Camera Operations.....	145
Adjusting the Volume .....	145
Hiding Hints and Tips.....	146
Date and Time .....	146
World Clock .....	146
Lens Retraction Timing.....	147
Using Eco Mode .....	147
Power-Saving Adjustment .....	147
Screen Brightness .....	148
Hiding the Start-Up Screen.....	148
Formatting Memory Cards.....	148
Low-Level Formatting .....	149
File Numbering .....	149
Date-Based Image Storage .....	150
Metric / Non-Metric Display .....	150

<b>Before Use</b>
<b>Basic Guide</b>
<b>Advanced Guide</b>
<b>1 Camera Basics</b>
<b>2 Auto Mode / Hybrid Auto Mode</b>
<b>3 Other Shooting Modes</b>
<b>4 P Mode</b>
<b>5 Tv, Av, M, C1, and C2 Mode</b>
<b>6 Playback Mode</b>
<b>7 Wi-Fi Functions</b>
<b>8 Setting Menu</b>
<b>9 Accessories</b>
<b>10 Appendix</b>
<b>Index</b>

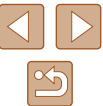

Electronic Level Calibration.....	150
Resetting the Electronic Level.....	150
Setting Copyright Information to Record in Images.....	151
Deleting All Copyright Information.....	151
Checking Certification Logos.....	151
Display Language.....	152
Adjusting Other Settings.....	152
Restoring Defaults.....	152
<b>9 Accessories .....</b>	<b>153</b>
System Map .....	154
Optional Accessories.....	155
Power Supplies.....	155
Flash Units.....	155
Other Accessories .....	155
Printers .....	156
Using Optional Accessories.....	157
Playback on a TV .....	157
Playback on a High-Definition TV.....	157
Playback on a Standard-Definition TV.....	158
Powering the Camera with Household Power .....	158
Using an External Microphone .....	159
Using a Lens Hood (Sold Separately) .....	160
Using Lens Filters (Sold Separately).....	160
Using a Remote Switch (Sold Separately) .....	161
Using an External Flash (Sold Separately).....	161
Speedlite EX Series .....	161
Using Speedlite Bracket SB-E2 (Sold Separately).....	162
Camera Settings Available with an External Flash (Sold Separately).....	163
Using the Software .....	164
Software .....	164
Software Instruction Manual.....	164

Computer Connections via a Cable.....	164
Checking Your Computer Environment .....	164
Installing the Software .....	164
Saving Images to a Computer.....	165
Printing Images .....	166
Easy Print .....	166
Configuring Print Settings.....	167
Cropping Images before Printing.....	168
Choosing Paper Size and Layout before Printing .....	168
Available Layout Options.....	169
Printing ID Photos .....	169
Printing Movie Scenes.....	169
Movie Printing Options .....	169
Adding Images to the Print List (DPOF) .....	170
Configuring Print Settings.....	170
Setting Up Printing for Individual Images .....	171
Setting Up Printing for a Range of Images.....	171
Setting Up Printing for All Images.....	171
Clearing All Images from the Print List .....	171
Printing Images Added to the Print List (DPOF) .....	172
Adding Images to a Photobook .....	172
Choosing a Selection Method .....	172
Adding Images Individually.....	172
Adding All Images to a Photobook .....	173
Removing All Images from a Photobook .....	173
<b>10 Appendix .....</b>	<b>174</b>
Troubleshooting.....	174
On-Screen Messages.....	178
On-Screen Information .....	180
Shooting (Information Display) .....	180
Battery Level .....	180

<b>Before Use</b>
<b>Basic Guide</b>
<b>Advanced Guide</b>
<b>1 Camera Basics</b>
<b>2 Auto Mode / Hybrid Auto Mode</b>
<b>3 Other Shooting Modes</b>
<b>4 P Mode</b>
<b>5 Tv, Av, M, C1, and C2 Mode</b>
<b>6 Playback Mode</b>
<b>7 Wi-Fi Functions</b>
<b>8 Setting Menu</b>
<b>9 Accessories</b>
<b>10 Appendix</b>
<b>Index</b>

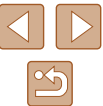

Playback (Detailed Information Display).....	181
Summary of Movie Control Panel.....	182
Functions and Menu Tables .....	182
Functions Available in Each Shooting Mode .....	182
FUNC. Menu.....	184
Shooting Tab.....	187
Set Up Tab.....	194
My Menu Tab .....	194
Playback Tab .....	194
Print Tab .....	195
Handling Precautions .....	195
Specifications .....	196
Camera Specifications.....	196
Wi-Fi .....	196
Digital Zoom Focal Length (35mm equivalent).....	196
Number of Shots/Recording Time, Playback Time.....	197
Number of Shots per Memory Card .....	197
Recording Time per Memory Card .....	198
Flash Range .....	198
Shooting Range.....	198
Continuous Shooting Speed.....	198
Shutter Speed .....	199
Aperture.....	199
Battery Pack NB-10L.....	199
Battery Charger CB-2LC/CB-2LCE .....	199
Lens Hood LH-DC90.....	199
Index.....	200
Wi-Fi (Wireless LAN) Precautions.....	202
Radio Wave Interference Precautions .....	202
Security Precautions.....	202
Trademarks and Licensing .....	203
Disclaimer.....	203

<b>Before Use</b>
<b>Basic Guide</b>
<b>Advanced Guide</b>
<b>1 Camera Basics</b>
<b>2 Auto Mode / Hybrid Auto Mode</b>
<b>3 Other Shooting Modes</b>
<b>4 P Mode</b>
<b>5 Tv, Av, M, C1, and C2 Mode</b>
<b>6 Playback Mode</b>
<b>7 Wi-Fi Functions</b>
<b>8 Setting Menu</b>
<b>9 Accessories</b>
<b>10 Appendix</b>
<b>Index</b>



# Common Camera Operations

## Shoot

- Use camera-determined settings (Auto Mode, Hybrid Auto Mode)
  - 33, 35
- See several effects applied to each shot, using camera-determined settings (Creative Shot Mode)
  - 57

Shooting people well



Portraits  
(59)



Against Snow  
(59)

Matching specific scenes



Sports  
(58)



Night Scenes  
(59)



Low Light  
(59)



Fireworks  
(59)

Applying special effects



Vivid Colors  
(60)



Poster Effect  
(60)



Fish-Eye Effect  
(62)



Miniature Effect  
(62)



Toy Camera Effect  
(63)



Soft Focus  
(64)



Monochrome  
(64)

- Focus on faces
  - 33, 59, 83, 85
- Without using the flash (Flash Off)
  - 33
- Include yourself in the shot (Self-Timer)
  - 44, 66
- Add a date stamp
  - 45
- Use Face ID
  - 47, 104
- Movie clips and photos together (Movie Digest)
  - 35

Before Use

Basic Guide

Advanced Guide

1 Camera Basics

2 Auto Mode / Hybrid Auto Mode

3 Other Shooting Modes

4 P Mode

5 Tv, Av, M, C1, and C2 Mode

6 Playback Mode

7 Wi-Fi Functions

8 Setting Menu







9 Accessories

10 Appendix





Index



## View

- View images (Playback Mode)
  -  101
- Automatic playback (Slideshow)
  -  109
- On a TV
  -  157
- On a computer
  -  164
- Browse through images quickly
  -  105
- Erase images
  -  112



## Shoot/View Movies

- Shoot movies
  -  33,  67
- View movies (Playback Mode)
  -  101
- Fast-moving subjects, slow-motion playback
  -  70



## Print

- Print pictures
  -  166

## Save

- Save images to a computer via a cable
  -  165
- Save images to a computer
  -  165

## Use Wi-Fi Functions

- Send images to a smartphone
  -  123
- Share images online
  -  133
- Send images to a computer
  -  127

## Before Use

### Basic Guide

### Advanced Guide

#### **1** Camera Basics

#### **2** Auto Mode / Hybrid Auto Mode

#### **3** Other Shooting Modes

#### **4** P Mode

#### **5** Tv, Av, M, C1, and C2 Mode

#### **6** Playback Mode

#### **7** Wi-Fi Functions

#### **8** Setting Menu

#### **9** Accessories

#### **10** Appendix

## Index

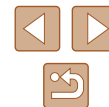

## Safety Precautions

- Before using the product, ensure that you read the safety precautions described below. Always ensure that the product is used correctly.
- The safety precautions noted here are intended to prevent you and other persons from being injured or incurring property damage.
- Be sure to also check the guides included with any separately sold accessories you use.



### Warning

Denotes the possibility of serious injury or death.

- Do not trigger the flash in close proximity to people's eyes. Exposure to the intense light produced by the flash could damage eyesight. In particular, remain at least 1 meter (3.3 feet) away from infants when using the flash.
- Store this equipment out of the reach of children and infants. A strap wound around a child's neck may result in asphyxiation. If your product uses a power cord, mistakenly winding the cord around a child's neck may result in asphyxiation.
- Use only recommended power sources.
- Do not disassemble, alter, or apply heat to the product.
- Do not peel off the label, if the battery pack has one.
- Avoid dropping or subjecting the product to severe impacts.
- Do not touch the interior of the product if it is broken, such as when dropped.
- Stop using the product immediately if it emits smoke or a strange smell, or otherwise behaves abnormally.
- Do not use organic solvents such as alcohol, benzene, or thinner to clean the product.

- Avoid contact with liquid, and do not allow liquid or foreign objects inside.

This could result in electrical shock or fire.

If the product gets wet, or if liquid or foreign objects get inside, remove the battery pack/batteries or unplug immediately.

- Do not look through the viewfinder (if your model has one) at intense light sources, such as the sun on a clear day or an intense artificial light source.

This could damage your eyesight.

- Do not touch the product during thunderstorms if it is plugged in. This could result in electrical shock or fire. Immediately stop using the product and distance yourself from it.

- Use only the recommended battery pack/batteries.

- Do not place the battery pack/batteries near or in direct flame.

This may cause the battery pack/batteries to explode or leak, resulting in electrical shock, fire, or injuries. If leaking battery electrolyte comes into contact with eyes, mouth, skin, or clothing, immediately flush with water.

- If the product uses a battery charger, note the following precautions.
  - Remove the plug periodically and, using a dry cloth, wipe away any dust and dirt that has collected on the plug, the exterior of the power outlet, and the surrounding area.
  - Do not insert or remove the plug with wet hands.
  - Do not use the equipment in a manner that exceeds the rated capacity of the electrical outlet or wiring accessories. Do not use if the plug is damaged or not fully inserted in the outlet.
  - Do not allow dust or metal objects (such as pins or keys) to contact the terminals or plug.
  - Do not cut, damage, alter, or place heavy items on the power cord, if your product uses one.

This could result in electrical shock or fire.

### Before Use

### Basic Guide

### Advanced Guide

#### 1 Camera Basics

#### 2 Auto Mode / Hybrid Auto Mode

#### 3 Other Shooting Modes

#### 4 P Mode

#### 5 Tv, Av, M, C1, and C2 Mode

#### 6 Playback Mode

#### 7 Wi-Fi Functions

#### 8 Setting Menu

#### 9 Accessories

#### 10 Appendix

### Index



- Turn the camera off in places where camera use is prohibited. The electromagnetic waves emitted by the camera may interfere with the operation of electronic instruments and other devices. Exercise adequate caution when using the product in places where use of electronic devices is restricted, such as inside airplanes and medical facilities.

 <b>Caution</b>	Denotes the possibility of injury.
--	------------------------------------

- When carrying the product by the strap, be careful not to bang it, subject it to strong impacts or shocks, or let it get caught on other objects.
- Be careful not to bump or push strongly on the lens. This could lead to injury or damage the camera.
- Be careful not to subject the screen to strong impacts. If the screen cracks, injury may result from the broken fragments.
- When using the flash, be careful not to cover it with your fingers or clothing. This could result in burns or damage to the flash.
- Avoid using, placing, or storing the product in the following places:
  - Places subject to direct sunlight
  - Places subject to temperatures above 40 °C (104 °F)
  - Humid or dusty places
 These could cause leakage, overheating, or an explosion of the battery pack/batteries, resulting in electrical shock, fire, burns, or other injuries. Overheating and damage may result in electrical shock, fire, burns, or other injuries.
- The slideshow transition effects may cause discomfort when viewed for prolonged periods.
- When using optional lenses, lens filters, or filter adapters (if applicable), be sure to attach these accessories firmly. If the lens accessory becomes loose and falls off, it may crack, and the shards of glass may lead to cuts.

- On products that raise and lower the flash automatically, make sure to avoid pinching your fingers with the lowering flash. This could result in injury.

<b>Caution</b>	Denotes the possibility of property damage.
----------------	---

- Do not aim the camera at intense light sources, such as the sun on a clear day or an intense artificial light source. Doing so may damage the image sensor or other internal components.
- When using the camera on a sandy beach or at a windy location, be careful not to allow dust or sand to enter the camera.
- On products that raise and lower the flash automatically, do not push the flash down or pry it open. This may cause the product to malfunction.
- Wipe off any dust, grime, or other foreign matter on the flash with a cotton swab or cloth. The heat emitted from the flash may cause foreign matter to smoke or the product to malfunction.
- Remove and store the battery pack/batteries when you are not using the product. Any battery leakage that occurs may cause product damage.
- Before you discard the battery pack/batteries, cover the terminals with tape or other insulators. Contacting other metal materials may lead to fire or explosions.
- Unplug any battery charger used with the product when not in use. Do not cover with a cloth or other objects when in use. Leaving the unit plugged in for a long period of time may cause it to overheat and distort, resulting in fire.

<b>Before Use</b>
<b>Basic Guide</b>
<b>Advanced Guide</b>
<b>1 Camera Basics</b>
<b>2 Auto Mode / Hybrid Auto Mode</b>
<b>3 Other Shooting Modes</b>
<b>4 P Mode</b>
<b>5 Tv, Av, M, C1, and C2 Mode</b>
<b>6 Playback Mode</b>
<b>7 Wi-Fi Functions</b>
<b>8 Setting Menu</b>
<b>9 Accessories</b>
<b>10 Appendix</b>
<b>Index</b>



- Do not leave any dedicated battery packs near pets.

Pets biting the battery pack could cause leakage, overheating, or explosion, resulting in product damage or fire.

- If your product uses multiple batteries, do not use batteries that have different levels of charge together, and do not use old and new batteries together. Do not insert the batteries with the + and – terminals reversed.

This may cause the product to malfunction.

- Do not sit down with the camera in your pant pocket. Doing so may cause malfunctions or damage the screen.

- When putting the camera in your bag, ensure that hard objects do not come into contact with the screen. Also close the screen (so that it faces the body), if your product's screen closes.

- Do not attach any hard objects to the product. Doing so may cause malfunctions or damage the screen.



Before Use

Basic Guide

Advanced Guide

**1** Camera Basics

**2** Auto Mode /  
Hybrid Auto Mode

**3** Other Shooting Modes

**4** P Mode

**5** Tv, Av, M, C1, and C2 Mode

**6** Playback Mode

**7** Wi-Fi Functions

**8** Setting Menu

**9** Accessories

**10** Appendix

Index

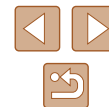



## Basic Operations

Basic information and instructions, from initial preparations to shooting and playback

### Initial Preparations

Prepare for shooting as follows.

#### Attaching Accessories

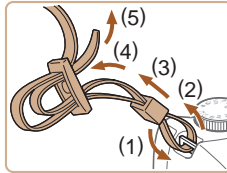

#### 1 Attach the strap.

- Attach the included strap to the camera as shown.
- On the other side of the camera, attach the strap the same way.

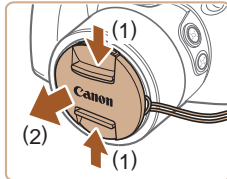

#### 2 Attach the lens cap.

- Remove the lens cap from the lens and attach the lens cap cord to the strap.

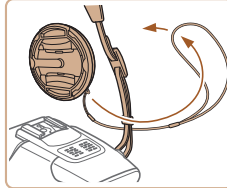

Before Use

Basic Guide

Advanced Guide

1 Camera Basics

2 Auto Mode / Hybrid Auto Mode

3 Other Shooting Modes

4 P Mode

5 Tv, Av, M, C1, and C2 Mode

6 Playback Mode

7 Wi-Fi Functions

8 Setting Menu

9 Accessories

10 Appendix

Index

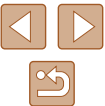

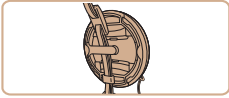

- Always remove the lens cap before turning the camera on. Try clipping the lens cap to the neck strap when the cap is not in use.
- Keep the lens cap on the lens when the camera is not in use.

## Holding the Camera



- Place the strap around your neck.
- When shooting, keep your arms close to your body and hold the camera securely to prevent it from moving. If you have raised the flash, do not rest your fingers on it.

## Charging the Battery Pack

Before use, charge the battery pack with the included charger. Be sure to charge the battery pack initially, because the camera is not sold with the battery pack charged.

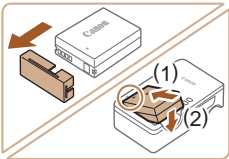

### 1 Insert the battery pack.

- Remove the cover from the battery pack, align the ▲ marks on the battery pack and charger, and insert the battery pack by pushing it in (1) and down (2).

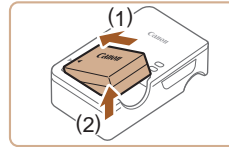
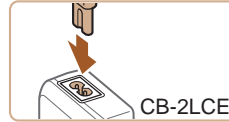
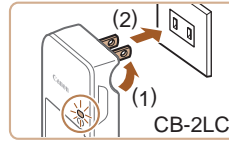

### 2 Charge the battery pack.

- CB-2LC: Flip out the plug (1) and plug the charger into a power outlet (2).
- CB-2LCE: Plug the power cord into the charger, then plug the other end into a power outlet.
- The charging lamp turns orange, and charging begins.
- When charging is finished, the lamp turns green.

### 3 Remove the battery pack.

- After unplugging the battery charger, remove the battery pack by pushing it in (1) and up (2).



- To protect the battery pack and keep it in optimal condition, do not charge it continuously for more than 24 hours.
- For battery chargers that use a power cord, do not attach the charger or cord to other objects. Doing so could result in malfunction or damage to the product.

Before Use

Basic Guide

Advanced Guide

1 Camera Basics

2 Auto Mode / Hybrid Auto Mode

3 Other Shooting Modes

4 P Mode

5 Tv, Av, M, C1, and C2 Mode

6 Playback Mode

7 Wi-Fi Functions

8 Setting Menu

9 Accessories

10 Appendix

Index





- For details on charging time and the number of shots and recording time possible with a fully charged battery pack, see “Number of Shots/Recording Time, Playback Time” (197).
- Charged battery packs gradually lose their charge, even when they are not used. Charge the battery pack on (or immediately before) the day of use.
- As a visual reminder of the charge status, attach the battery cover with ▲ visible on a charged battery pack and concealed on an uncharged one.
- The charger can be used in areas with 100 – 240 V AC power (50/60 Hz). For power outlets in a different format, use a commercially available adapter for the plug. Never use an electrical transformer designed for traveling, which may damage the battery pack.

## Inserting the Battery Pack and Memory Card

Insert the included battery pack and a memory card (sold separately). Note that before using a new memory card (or a memory card formatted in another device), you should format the memory card with this camera (148).

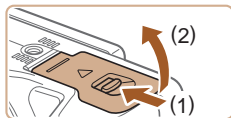

### 1 Open the cover.

- Slide the switch (1) and open the cover (2).

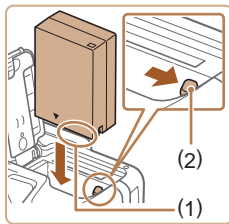

### 2 Insert the battery pack.

- Holding the battery pack with the terminals (1) facing as shown, press the battery lock (2) in the direction of the arrow and insert the battery pack until the lock clicks shut.
- If you insert the battery pack facing the wrong way, it cannot be locked into the correct position. Always confirm that the battery pack is facing the right way and locks when inserted.

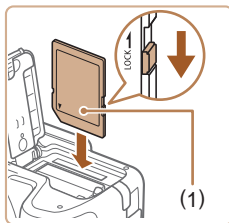

### 3 Check the card's write-protect tab and insert the memory card.

- Recording is not possible on memory cards with a write-protect tab when the tab is in the locked position. Slide the tab to the unlocked position.
- Insert the memory card with the label (1) facing as shown until it clicks into place.
- Make sure the memory card is facing the right way when you insert it. Inserting memory cards facing the wrong way may damage the camera.

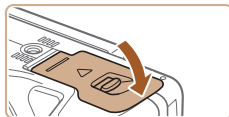

### 4 Close the cover.

- Lower the cover in the direction of the arrow and press it until it clicks into the closed position.



- For guidelines on how many shots or hours of recording can be saved on one memory card, see “Number of Shots per Memory Card” (197).

Before Use

Basic Guide

Advanced Guide

1 Camera Basics

2 Auto Mode / Hybrid Auto Mode

3 Other Shooting Modes

4 P Mode

5 Tv, Av, M, C1, and C2 Mode

6 Playback Mode

7 Wi-Fi Functions

8 Setting Menu

9 Accessories

10 Appendix

Index



## Using the Screen

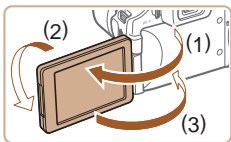

- Open the screen (1) and rotate it toward the lens 180° (2).
- Close the screen in this orientation (3).



- The screen can only open to approximately 175° in direction (1). Be careful not to open the screen any further than this, as it will damage the camera.

## Adjusting the Screen Angle and Orientation

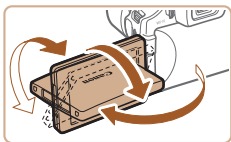

- You can adjust the angle and orientation of the screen as needed, to suit shooting conditions.
- To protect the screen when the camera is not in use, always keep it closed and facing the camera body.



- Open the screen to activate it when the camera is on. This will deactivate the viewfinder. Similarly, close the screen (facing the camera body) to deactivate it and activate the viewfinder.
- When including yourself in shots, you can view a mirror image of yourself by rotating the screen around toward the front of the camera. To cancel reverse display, press the [MENU] button, choose [Reverse Disp.] on the [CAMERA] tab, and press the [LEFT][RIGHT] buttons to choose [Off].

## Setting the Date and Time

Set the current date and time correctly as follows if the [Date/Time] screen is displayed when you turn the camera on. Information you specify this way is recorded in image properties when you shoot, and it is used when you manage images by shooting date or print images showing the date. You can also add a date stamp to shots, if you wish (p.45).



### 1 Turn the camera on.

- Press the power button.
- The [Date/Time] screen is displayed.



### 2 Set the date and time.

- Press the [LEFT][RIGHT] buttons to choose an option.
- Press the [UP][DOWN] buttons to specify the date and time.
- When finished, press the [OK] button.

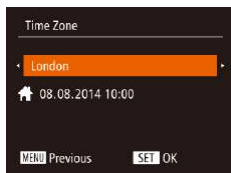

### 3 Specify your home time zone.

- Press the [LEFT][RIGHT] buttons to choose your home time zone.

### 4 Finish the setup process.

- Press the [OK] button when finished. After a confirmation message, the setting screen is no longer displayed.
- To turn off the camera, press the power button.

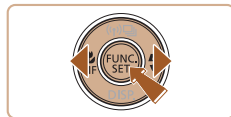

Before Use

Basic Guide

Advanced Guide

1 Camera Basics

2 Auto Mode / Hybrid Auto Mode

3 Other Shooting Modes

4 P Mode

5 Tv, Av, M, C1, and C2 Mode

6 Playback Mode

7 Wi-Fi Functions

8 Setting Menu

9 Accessories

10 Appendix

Index

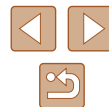



- Unless you set the date, time, and home time zone, the [Date/Time] screen will be displayed each time you turn the camera on. Specify the correct information.



- To set daylight saving time (1 hour ahead), choose [☀] in step 2 and then choose [☀] by pressing the [▲][▼] buttons.

## Changing the Date and Time

Adjust the date and time as follows.

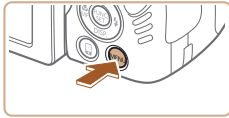

### 1 Access the menu screen.

- Press the [MENU] button.

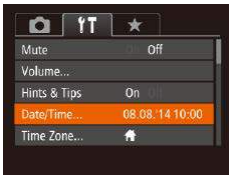

### 2 Choose [Date/Time].

- Move the zoom lever to choose the [↑↓] tab.
- Press the [▲][▼] buttons to choose [Date/Time], and then press the [OK] button.

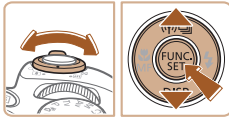

### 3 Change the date and time.

- Follow step 2 in “Setting the Date and Time” (p.20) to adjust the settings.
- Press the [MENU] button to close the menu screen.



- Date/time settings can be retained for about 3 weeks by the camera's built-in date/time battery (backup battery) after the battery pack is removed.
- The date/time battery will be charged in about 4 hours once you insert a charged battery pack or connect the camera to an AC adapter kit (sold separately, p.155), even if the camera is left off.
- Once the date/time battery is depleted, the [Date/Time] screen will be displayed when you turn the camera on. Set the correct date and time as described in “Setting the Date and Time” (p.20).

## Display Language

Change the display language as needed.

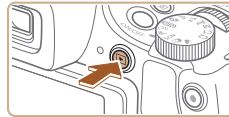

### 1 Enter Playback mode.

- Press the [▶] button.

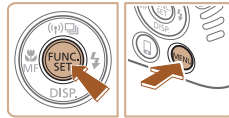

### 2 Access the setting screen.

- Press and hold the [FUNC SET] button, and then immediately press the [MENU] button.

Before Use

Basic Guide

Advanced Guide

1 Camera Basics

2 Auto Mode / Hybrid Auto Mode

3 Other Shooting Modes

4 P Mode

5 Tv, Av, M, C1, and C2 Mode

6 Playback Mode

7 Wi-Fi Functions

8 Setting Menu

9 Accessories

10 Appendix

Index

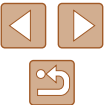

English	Noorsk	România
Deutsch	Svenska	Türkçe
Français	Español	العربية
Nederlands	Ελληνικό	Ελληνικά
Dansk	Русский	简体中文
Português	Polski	繁體中文
Suomi	Čeština	한국어

### 3 Set the display language.

- Press the [▲][▼][◀][▶] buttons to choose a language, and then press the [MENU] button.
- Once the display language has been set, the setting screen is no longer displayed.



- The current time is displayed if you wait too long in step 2 after pressing the [MENU] button before you press the [MENU] button. In this case, press the [MENU] button to dismiss the time display and repeat step 2.
- You can also change the display language by pressing the [MENU] button and choosing [Language] on the [FUNC.] tab.

## Trying the Camera Out

► Still Images ► Movies

Follow these instructions to turn the camera on, shoot still images or movies, and then view them.

### Shooting (Smart Auto)

For fully automatic selection of the optimal settings for specific scenes, simply let the camera determine the subject and shooting conditions.



#### 1 Turn the camera on.

- Press the power button.
- The startup screen is displayed.



#### 2 Enter [AUTO] mode.

- Set the mode dial to [AUTO].
- Aim the camera at the subject. The camera will make a slight clicking noise as it determines the scene.
- Icons representing the scene and image stabilization mode are displayed in the upper left of the screen.
- Frames displayed around any detected subjects indicate that they are in focus.

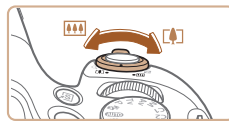

#### 3 Compose the shot.

- To zoom in and enlarge the subject, move the zoom lever toward [T] (telephoto), and to zoom away from the subject, move it toward [W] (wide angle).

Before Use

Basic Guide

Advanced Guide

1 Camera Basics

2 Auto Mode / Hybrid Auto Mode

3 Other Shooting Modes

4 P Mode

5 Tv, Av, M, C1, and C2 Mode

6 Playback Mode

7 Wi-Fi Functions

8 Setting Menu

9 Accessories

10 Appendix

Index

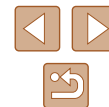

## 4 Shoot.

### Shooting Still Images



#### 1) Focus.

- Press the shutter button lightly, halfway down. The camera beeps twice after focusing, and AF frames are displayed to indicate image areas in focus.
- If [Raise the flash] is displayed, lift the flash with your finger to prepare it for use. If you prefer not to use the flash, push it down with your finger, into the camera.

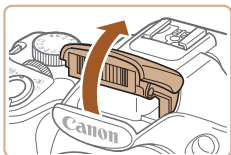

#### 2) Shoot.

- Press the shutter button all the way down.
- As the camera shoots, a shutter sound is played, and in low-light conditions when you have raised the flash, it fires automatically.
- Keep the camera still until the shutter sound ends.
- After displaying your shot, the camera will revert to the shooting screen.

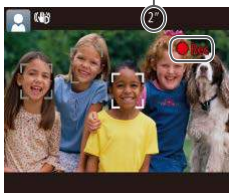

### Shooting Movies

#### 1) Start shooting.

- Press the movie button. The camera beeps once as recording begins, and [●Rec] is displayed with the elapsed time (1).
- Black bars are displayed on the top and bottom edges of the screen, and the subject is slightly enlarged. The black bars indicate image areas not recorded.
- Frames displayed around any detected faces indicate that they are in focus.
- Once recording begins, take your finger off the movie button.

#### 2) Finish shooting.

- Press the movie button again to stop shooting. The camera beeps twice as recording stops.

Before Use

Basic Guide

Advanced Guide

1 Camera Basics

2 Auto Mode / Hybrid Auto Mode

3 Other Shooting Modes

4 P Mode

5 Tv, Av, M, C1, and C2 Mode

6 Playback Mode

7 Wi-Fi Functions

8 Setting Menu

9 Accessories

10 Appendix

Index

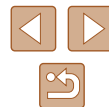

## Viewing

After shooting images or movies, you can view them on the screen as follows.

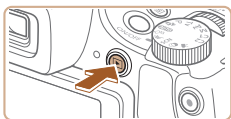

### 1 Enter Playback mode.

- Press the [▶] button.
- Your last shot is displayed.



### 2 Browse through your images.

- To view the previous image, press the [◀] button. To view the next image, press the [▶] button.



- To access this screen (Scroll Display mode), press and hold the [◀][▶] buttons for at least one second. In this mode, press the [◀][▶] buttons to browse through images.
- To return to single-image display, press the [FUNC./SET] button.
- Movies are identified by a [SET ▶] icon. To play movies, go to step 3.

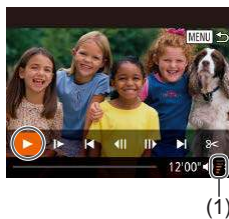

### 3 Play movies.

- Press the [FUNC./SET] button to access the movie control panel, press the [◀][▶] buttons to choose [▶], and then press the [FUNC./SET] button again.
- Playback now begins, and after the movie is finished, [SET ▶] is displayed.
- To adjust the volume (1), press the [▲][▼] buttons.



- To switch to Shooting mode from Playback mode, press the shutter button halfway.

## Erasing Images

You can choose and erase unneeded images one by one. Be careful when erasing images, because they cannot be recovered.

### 1 Choose an image to erase.

- Press the [◀][▶] buttons to choose an image.



### 2 Erase the image.

- Press the [FUNC./SET] button.
- After [Erase?] is displayed, press the [◀][▶] buttons to choose [Erase], and then press the [FUNC./SET] button.
- The current image is now erased.
- To cancel erasure, press the [◀][▶] buttons to choose [Cancel], and then press the [FUNC./SET] button.



- You can choose multiple images to erase at once (113).

Before Use

Basic Guide

Advanced Guide

1 Camera Basics

2 Auto Mode / Hybrid Auto Mode

3 Other Shooting Modes

4 P Mode

5 Tv, Av, M, C1, and C2 Mode

6 Playback Mode

7 Wi-Fi Functions

8 Setting Menu

9 Accessories

10 Appendix

Index





## Camera Basics

Other basic operations and more ways to enjoy your camera, including shooting and playback options

### On/Off



#### Shooting Mode

- Press the power button to turn the camera on and prepare for shooting.
- To turn the camera off, press the power button again.

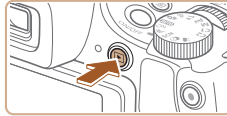

#### Playback Mode

- Press the [▶] button to turn the camera on and view your shots.
- To turn the camera off, press the [▶] button again.



- To switch to Playback mode from Shooting mode, press the [▶] button.
- To switch to Shooting mode from Playback mode, press the shutter button halfway (p. 26).
- The lens will be retracted after about one minute once the camera is in Playback mode. You can turn the camera off when the lens is retracted by pressing the [▶] button.

Before Use

Basic Guide

Advanced Guide

**1** Camera Basics

**2** Auto Mode / Hybrid Auto Mode

**3** Other Shooting Modes

**4** P Mode

**5** Tv, Av, M, C1, and C2 Mode

**6** Playback Mode

**7** Wi-Fi Functions

**8** Setting Menu

**9** Accessories

**10** Appendix

Index

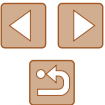

## Power-Saving Features (Auto Power Down)

As a way to conserve battery power, the camera automatically deactivates the screen (Display Off) and then turns itself off after a specific period of inactivity.

### Power Saving in Shooting Mode

The screen is automatically deactivated after about one minute of inactivity. In about two more minutes, the lens is retracted and the camera turns itself off. To activate the screen and prepare for shooting when the screen is off but the lens is still out, press the shutter button halfway (📖26).

### Power Saving in Playback Mode

The camera turns itself off automatically after about five minutes of inactivity.



- You can deactivate Auto Power Down and adjust the timing of Display Off, if you prefer (📖147).
- Power saving is not active while the camera is connected to other devices via Wi-Fi (📖122), or when connected to a computer (📖165).

## Shutter Button

To ensure your shots are in focus, always begin by holding the shutter button halfway down, and once the subject is in focus, press the button all the way down to shoot.

In this manual, shutter button operations are described as pressing the button *halfway* or *all the way down*.



### 1 Press halfway. (Press lightly to focus.)

- Press the shutter button halfway. The camera beeps twice, and AF frames are displayed around image areas in focus.

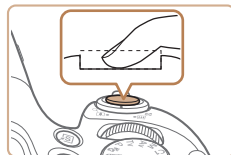

### 2 Press all the way down. (From the halfway position, press fully to shoot.)

- The camera shoots, as a shutter sound is played.
- Keep the camera still until the shutter sound ends.



- Images may be out of focus if you shoot without initially pressing the shutter button halfway.
- Length of shutter sound playback varies depending on the time required for the shot. It may take longer in some shooting scenes, and images will be blurry if you move the camera (or the subject moves) before the shutter sound ends.

Before Use

Basic Guide

Advanced Guide

1 Camera Basics

2 Auto Mode / Hybrid Auto Mode

3 Other Shooting Modes

4 P Mode

5 Tv, Av, M, C1, and C2 Mode

6 Playback Mode

7 Wi-Fi Functions

8 Setting Menu

9 Accessories

10 Appendix

Index



## Viewfinder

Adjust the viewfinder display for sharper images by adjusting the diopter, as follows.



### 1 Activate the viewfinder.

- Press the [▼] button several times until the viewfinder goes on (📖28).



### 2 Adjust the diopter.

- As you look through the viewfinder, turn the dial one way or the other so that images look sharp.

## Shooting Modes

Use the mode dial to access each shooting mode.

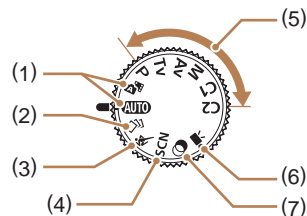

- |  |  |
|--|--|
| (1) Auto Mode / Hybrid Auto Mode<br>Fully automatic shooting, with camera-determined settings (📖22, 📖33, 📖35). | (5) P, Tv, Av, M, C1, and C2 Modes<br>Take a variety of shots using your preferred settings (📖71, 📖92).  |
| (2) Creative Shot Mode<br>See several effects applied to each shot automatically (📖57).                        | (6) Movie Mode<br>For shooting movies (📖67). You can also shoot movies when the mode dial is not set to Movie mode, simply by pressing the movie button. |
| (3) Sports Mode<br>Shoot continuously as the camera focuses on moving subjects (📖58).                          | (7) Creative Filters Mode<br>Add a variety of effects to images when shooting (📖60).   |
| (4) Scene Mode<br>Shoot with optimal settings for specific scenes (📖59).                                       |  |

Before Use

Basic Guide

Advanced Guide

1 Camera Basics

2 Auto Mode / Hybrid Auto Mode

3 Other Shooting Modes

4 P Mode

5 Tv, Av, M, C1, and C2 Mode

6 Playback Mode

7 Wi-Fi Functions

8 Setting Menu

9 Accessories

10 Appendix





Index



## Shooting Display Options

Press the [▼] button to view other information on the screen, or to hide the information. For details on the information displayed, see “On-Screen Information” (180).

Open the screen to activate it when the camera is on. This will deactivate the viewfinder. Similarly, close the screen (facing the camera body) to deactivate it and activate the viewfinder (20).

LCD Monitor (Screen)	
	No information is displayed
	Information is displayed
Viewfinder	
	No information is displayed
	Information is displayed



- Screen brightness is automatically increased by the night view function when you are shooting under low light, making it easier to check how shots are composed. However, on-screen image brightness may not match the brightness of your shots. Note that any on-screen image distortion or jerky subject motion will not affect recorded images.
- For playback display options, see “Switching Display Modes” (102).

### Before Use

### Basic Guide

### Advanced Guide

#### 1 Camera Basics

#### 2 Auto Mode / Hybrid Auto Mode

#### 3 Other Shooting Modes

#### 4 P Mode

#### 5 Tv, Av, M, C1, and C2 Mode

#### 6 Playback Mode

#### 7 Wi-Fi Functions

#### 8 Setting Menu

#### 9 Accessories

#### 10 Appendix

### Index

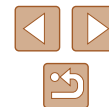

## Using the FUNC. Menu

Configure commonly used shooting functions through the FUNC. menu as follows.

Note that menu items and options vary depending on the shooting mode (📖184).



### 1 Access the FUNC. menu.

- Press the [FUNC.] button.



(1) (2)

### 2 Choose a menu item.

- Press the [▲][▼] buttons to choose a menu item (1).
- Available options (2) are shown at the bottom of the screen.



### 3 Choose an option.

- Press the [◀][▶] buttons to choose an option.
- Options labeled with a [DISP.] icon can be configured by pressing the [▼] button.
- To return to the menu items, press the [▼] button.



### 4 Finish the setup process.

- Press the [FUNC.] button.
- The screen before you pressed the [FUNC.] button in step 1 is displayed again, showing the option you configured.



- To undo any accidental setting changes, you can restore the camera's default settings (📖152).

Before Use

Basic Guide

Advanced Guide

1 Camera Basics

2 Auto Mode / Hybrid Auto Mode

3 Other Shooting Modes

4 P Mode

5 Tv, Av, M, C1, and C2 Mode

6 Playback Mode

7 Wi-Fi Functions

8 Setting Menu

9 Accessories

10 Appendix

Index

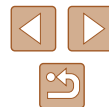

## Using the Menu Screen

Configure a variety of camera functions through the menu screen as follows. Menu items are grouped by purpose on tabs, such as shooting [📷], playback [▶], and so on. Note that available menu items vary depending on the selected shooting or playback mode (📖 187 – 194).

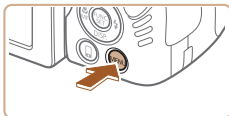

### 1 Access the menu screen.

- Press the [MENU] button.

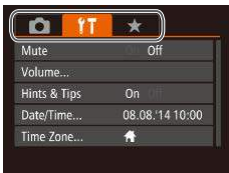

### 2 Choose a tab.

- Move the zoom lever to choose a tab.
- After you have pressed the [▲][▼] buttons to choose a tab initially, you can switch between tabs by pressing the [◀][▶] buttons.

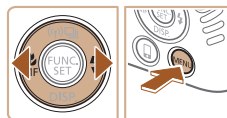
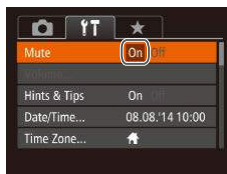
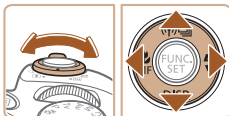

### 3 Choose a menu item.

- Press the [▲][▼] buttons to choose a menu item.
- For menu items with options not shown, first press the [⊕] or [▶] button to switch screens, and then press the [▲][▼] buttons to select the menu item.
- To return to the previous screen, press the [MENU] button.

### 4 Choose an option.

- Press the [◀][▶] buttons to choose an option.

### 5 Finish the setup process.

- Press the [MENU] button to return to the screen displayed before you pressed the [MENU] button in step 1.



- To undo any accidental setting changes, you can restore the camera's default settings (📖 152).

Before Use

Basic Guide

Advanced Guide

1 Camera Basics

2 Auto Mode / Hybrid Auto Mode

3 Other Shooting Modes

4 P Mode

5 Tv, Av, M, C1, and C2 Mode

6 Playback Mode

7 Wi-Fi Functions

8 Setting Menu

9 Accessories

10 Appendix

Index



# On-Screen Keyboard

Use the on-screen keyboard to enter information for Wi-Fi connections (📖122). Note that the length and type of information you can enter varies depending on the function you are using.



## (1) Entering Characters

- Press the [▲][▼][◀][▶] buttons to choose a character, and then press the [⏏] button to enter it.
- The amount of information you can enter (1) varies depending on the function you are using.

## Moving the Cursor

- Choose [◀] or [▶] and press the [⏏] button.

## Entering Line Breaks

- Choose [↵] and press the [⏏] button.

## Switching Input Modes

- To switch to numbers or symbols, choose [123] and press the [⏏] button.
- To switch between uppercase and lowercase letters, choose [↕] and press the [⏏] button.
- Available input modes vary depending on the function you are using.



## Deleting Characters

- To delete the previous character, choose [✕] and press the [⏏] button. Alternatively, press the [⏏] button.

## Confirming Input and Returning to the Previous Screen

- Press the [MENU] button.



- The on-screen keyboard is not available while the viewfinder (📖28) is in use.



- You can confirm input and return to the previous screen while the on-screen keyboard is displayed by closing the screen.

Before Use

Basic Guide

Advanced Guide

**1** Camera Basics

**2** Auto Mode / Hybrid Auto Mode

**3** Other Shooting Modes

**4** P Mode

**5** Tv, Av, M, C1, and C2 Mode

**6** Playback Mode

**7** Wi-Fi Functions

**8** Setting Menu

**9** Accessories

**10** Appendix

Index

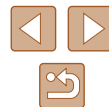

## Indicator Display

The indicator on the back of the camera (📖3) lights up or blinks depending on the camera status.

Color	Indicator Status	Camera Status
Green	On	Camera on
	Blinking	Recording/reading/transmitting images, distance warning (📖174), or cannot focus (when the flash is deactivated) (📖174)



- When the indicator blinks green, never turn the camera off, open the memory card/battery cover, or shake or jolt the camera, which may corrupt images or damage the camera or memory card.

## Clock

You can check the current time.

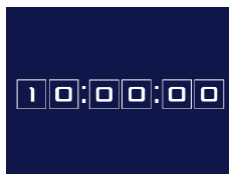

- When the camera is off, press and hold the [FUNC. SET.] button, then press the power button to display the clock.

- Press and hold the [FUNC. SET.] button.
- The current time appears.
- If you hold the camera vertically while using the clock function, it will switch to vertical display. Press the [◀][▶] buttons to change the display color.
- Press the [FUNC. SET.] button again to cancel the clock display.

Before Use

Basic Guide

Advanced Guide

**1** Camera Basics

**2** Auto Mode / Hybrid Auto Mode

**3** Other Shooting Modes

**4** P Mode

**5** Tv, Av, M, C1, and C2 Mode

**6** Playback Mode

**7** Wi-Fi Functions

**8** Setting Menu

**9** Accessories

**10** Appendix

Index





# 2

## Auto Mode / Hybrid Auto Mode

Convenient mode for easy shots with greater control over shooting

### Shooting with Camera-Determined Settings

For fully automatic selection of the optimal settings for specific scenes, simply let the camera determine the subject and shooting conditions.

#### Shooting (Smart Auto)

► Still Images ► Movies



#### 1 Turn the camera on.

- Press the power button.
- The startup screen is displayed.



#### 2 Enter [AUTO] mode.

- Set the mode dial to [AUTO].
- Aim the camera at the subject. The camera will make a slight clicking noise as it determines the scene.
- Icons representing the scene and image stabilization mode are displayed in the upper left of the screen (📖37, 📖39).
- Frames displayed around any detected subjects indicate that they are in focus.



Before Use

Basic Guide

Advanced Guide

1 Camera Basics

2 Auto Mode / Hybrid Auto Mode

3 Other Shooting Modes

4 P Mode

5 Tv, Av, M, C1, and C2 Mode

6 Playback Mode

7 Wi-Fi Functions

8 Setting Menu

9 Accessories

10 Appendix

Index

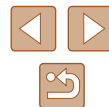

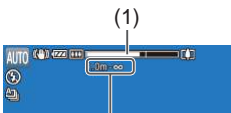

(1)  
(2)

### 3 Compose the shot.

- To zoom in and enlarge the subject, move the zoom lever toward [T] (telephoto), and to zoom away from the subject, move it toward [W] (wide angle). (A zoom bar (1) showing the zoom position is displayed, along with the area in focus (2).)
- To zoom in or out quickly, move the zoom lever all the way toward [T] (telephoto) or [W] (wide angle), and to zoom in or out slowly, move it just a little in the desired direction.

### 4 Shoot.

#### Shooting Still Images

##### 1) Focus.

- Press the shutter button halfway. The camera beeps twice after focusing, and AF frames are displayed to indicate image areas in focus.
- Several AF frames are displayed when multiple areas are in focus.



- If [Raise the flash] is displayed, lift the flash with your finger to prepare it for use. If you prefer not to use the flash, push it down with your finger, into the camera.

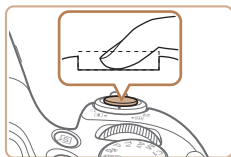
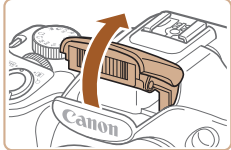

##### 2) Shoot.

- Press the shutter button all the way down.
- As the camera shoots, a shutter sound is played, and in low-light conditions when you have raised the flash, it fires automatically.
- Keep the camera still until the shutter sound ends.
- After displaying your shot, the camera will revert to the shooting screen.



#### Shooting Movies

##### 1) Start shooting.

- Press the movie button. The camera beeps once as recording begins, and [●Rec] is displayed with the elapsed time (1).
- Black bars are displayed on the top and bottom edges of the screen, and the subject is slightly enlarged. The black bars indicate image areas not recorded.
- Frames displayed around any detected faces indicate that they are in focus.
- Once recording begins, take your finger off the movie button.

Before Use
Basic Guide
Advanced Guide
<b>1</b> Camera Basics
<b>2</b> Auto Mode / Hybrid Auto Mode
<b>3</b> Other Shooting Modes
<b>4</b> P Mode
<b>5</b> Tv, Av, M, C1, and C2 Mode
<b>6</b> Playback Mode
<b>7</b> Wi-Fi Functions
<b>8</b> Setting Menu
<b>9</b> Accessories
<b>10</b> Appendix
Index





## 2) Resize the subject and recompose the shot as needed.

- To resize the subject, repeat the operations in step 3. However, note that the sound of camera operations will be recorded. Note that movies shot at zoom factors shown in blue will look grainy.
- When you recompose shots, the focus, brightness, and colors will be automatically adjusted.



## 3) Finish shooting.

- Press the movie button again to stop shooting. The camera beeps twice as recording stops.
- Recording will stop automatically when the memory card becomes full.



- The flash firing during shots indicates that the camera has automatically attempted to ensure optimal colors in the main subject and background (Multi-area White Balance).

## Shooting in Hybrid Auto Mode

► Still Images ► Movies

You can make a short movie of the day just by shooting still images. The camera records 2 – 4-second clips of scenes before each shot, which are later combined in a digest movie.



### 1 Enter [AUTO] mode.

- Follow step 2 in “Shooting (Smart Auto)” (📖33) and choose [AUTO].

### 2 Compose the shot.

- Follow steps 3 – 4 in “Shooting (Smart Auto)” (📖33) to compose the shot and focus.
- For more impressive digest movies, aim the camera at subjects about four seconds before shooting still images.



### 3 Shoot.

- Follow step 4 in “Shooting (Smart Auto)” (📖33) to shoot a still image.
- The camera records both a still image and movie clip. The clip, which ends with the still image and a shutter sound, forms a single chapter in the digest movie.



- Battery life is shorter in this mode than in [AUTO] mode, because digest movies are recorded for each shot.
- A digest movie may not be recorded if you shoot a still image immediately after turning the camera on, choosing [AUTO] mode, or operating the camera in other ways.
- Camera operating sounds will be recorded in digest movies.

Before Use

Basic Guide

Advanced Guide

1 Camera Basics

2 Auto Mode / Hybrid Auto Mode

3 Other Shooting Modes

4 P Mode

5 Tv, Av, M, C1, and C2 Mode

6 Playback Mode

7 Wi-Fi Functions

8 Setting Menu

9 Accessories

10 Appendix

Index





- Digest movie quality is [HD 800] and cannot be changed.
- Sounds are not played when you press the shutter button halfway or trigger the self-timer (145).
- Digest movies are saved as separate movie files in the following cases even if they were recorded on the same day in [A] mode.
  - The digest movie file size reaches approximately 4 GB, or the total recording time reaches approximately 13 minutes and 20 seconds.
  - The digest movie is protected (110).
  - Daylight saving time (20) or time zone (146) settings are changed.
  - A new folder is created (150).
- Recorded shutter sounds cannot be modified or erased.
- If you prefer to record digest movies without still images, adjust the setting in advance. Choose MENU (30) ► [Camera] tab ► [Digest Type] ► [No Stills].
- Individual chapters can be edited (121).

## Digest Movie Playback

Display a still image shot in [A] mode to play a digest movie, or specify the date of the digest movie to play (104).

## Still Images/Movies



- To activate the screen when the camera is on but the screen is blank (when display is set to the viewfinder), press the [▼] button several times.
- If the camera is turned on while the [▼] button is held down, the camera will no longer sound. To activate sounds again, press the [MENU] button and choose [Mute] on the [f] tab, and then press the [◀][▶] buttons to choose [Off].

## Still Images



- A blinking [Camera] icon warns that images are more likely to be blurred by camera shake. In this case, mount the camera on a tripod or take other measures to keep it still.
- If your shots are dark despite the flash firing, move closer to the subject. For details on the flash range, see "Flash Range" (198).
- The subject may be too close if the camera only beeps once when you press the shutter button halfway. For details on the focusing range (shooting range), see "Shooting Range" (198).
- To reduce red-eye and to assist in focusing, the lamp may be activated when shooting in low-light conditions.
- A blinking [Battery] icon displayed when you attempt to shoot indicates that shooting is not possible until the flash has finished recharging. Shooting can resume as soon as the flash is ready, so either press the shutter button all the way down and wait, or release it and press it again.
- The shutter sound will not be played when the Sleeping and Babies (Sleeping) icons (37) are displayed.
- Although you can shoot again before the shooting screen is displayed, your previous shot may determine the focus, brightness, and colors used.



- You can change how long images are displayed after shots (56).

Before Use

Basic Guide

Advanced Guide

1 Camera Basics

2 Auto Mode / Hybrid Auto Mode

3 Other Shooting Modes

4 P Mode

5 Tv, Av, M, C1, and C2 Mode

6 Playback Mode

7 Wi-Fi Functions

8 Setting Menu

9 Accessories

10 Appendix

Index

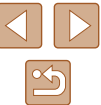

## Movies



- The camera may become warm when shooting movies repeatedly over an extended period. This does not indicate damage.
- Before shooting a movie, lower the flash with your finger. Be careful not to touch the microphone (1) when shooting a movie. Leaving the flash raised, or blocking the microphone may prevent audio from being recorded or may cause the recording to sound muffled.

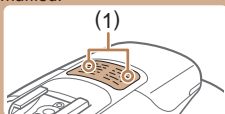

- Avoid touching camera controls other than the movie button when shooting movies, because sounds made by the camera will be recorded.
- Once movie recording begins, the image display area changes and subjects are enlarged to allow for correction of significant camera shake. To shoot subjects at the same size shown before shooting, adjust the image stabilization setting (p.90).



- Audio is recorded in stereo.
- If you prefer not to record sound, choose MENU (p.30) ► [CAMERA] tab ► [Sound rec.] ► [Disable].

## Scene Icons

► Still Images ► Movies

In [CAMERA] and [AUTO] modes, shooting scenes determined by the camera are indicated by the icon displayed, and corresponding settings are automatically selected for optimal focusing, subject brightness, and color. Depending on the scene, continuous images may be shot (p.38).

Subject	Background				
	Normal	Backlit	Dark*1	Sunsets	Spotlights
People	*2	*3		—	
Moving People	*3	*3	—	—	—
Shadows on Face	*2	—	—	—	—
Smiling	*3	*3	—	—	—
Sleeping	*2	*3	—	—	—
Babies	*3	*3	—	—	—
Smiling Babies	*3	*3	—	—	—
Sleeping Babies	*2	*3	—	—	—
Moving Children	*3	*3	—	—	—
Other Subjects	*2	*3			
Other Moving Subjects	*3	*3	—	—	—
Other Close-Range Subjects	*2	*3	—	—	

\*1 Tripod Used

\*2 The background color of icons is light blue when the background is a blue sky, dark blue when the background is dark, and gray for all other backgrounds.

\*3 The background color of icons is light blue when the background is a blue sky, and gray for all other backgrounds.

Before Use

Basic Guide

Advanced Guide

1 Camera Basics

2 Auto Mode / Hybrid Auto Mode

3 Other Shooting Modes

4 P Mode

5 Tv, Av, M, C1, and C2 Mode

6 Playback Mode

7 Wi-Fi Functions

8 Setting Menu

9 Accessories

10 Appendix

Index



- The background color of , , , , and is dark blue, and the background color of is orange.
- For movies, only People, Other Subjects, and Other Close-Range Subjects icons are displayed.
- In mode, icons are only displayed for People, Shadows on Face, Other Subjects, and Other Close-Range Subjects.
- For self-timer shots, icons are not displayed for the following subjects: moving, smiling, or sleeping people; smiling or sleeping babies; moving children; and other moving subjects.
- Icons are not displayed for smiling or sleeping subjects and moving children in drive mode other than (📖38, 📖46) and when [Hg Lamp Corr.] is set to [On] and scenes are automatically corrected (📖53).
- Backlit icons are not displayed for moving children and smiling people when the flash is set to .
- Icons for babies (including smiling and sleeping babies) and moving children are displayed when [Face ID] is set to [On] and faces of registered babies (less than two years old) or children (2 – 12 years old) are detected (📖47). Confirm beforehand that the date and time are correct (📖20).



- Try shooting in mode (📖71) if the scene icon does not match actual shooting conditions, or if it is not possible to shoot with your expected effect, color, or brightness.

## Continuous Shooting Scenes

If you shoot a still image when the following scene icons are displayed, the camera will shoot continuously. If you press the shutter button halfway when one of the icons in the table below is displayed, one of the following icons will be displayed to inform you that the camera will shoot continuous images: , , or .

Smiling (including Babies)	Consecutive images are captured, and the camera analyzes details such as facial expressions to save the image determined to be the best.
Sleeping (including Babies)	Beautiful shots of sleeping faces, created by combining consecutive shots to reduce camera shake and image noise. The AF-assist beam will not light up, the flash will not fire, and the shutter sound will not be played.
Children	So you don't miss a photo opportunity of children who move around, the camera will capture three consecutive images for each shot.



- In some scenes, expected images may not be saved, and images may not look as expected.
- Focus, image brightness, and color are determined by the first shot.



- When you want to shoot single images only, press the button, and then select .

Before Use

Basic Guide

Advanced Guide

**1** Camera Basics

**2** Auto Mode / Hybrid Auto Mode

**3** Other Shooting Modes

**4** P Mode

**5** Tv, Av, M, C1, and C2 Mode

**6** Playback Mode

**7** Wi-Fi Functions

**8** Setting Menu

**9** Accessories

**10** Appendix









Index



## Image Stabilization Icons

► Still Images ► Movies

Optimal image stabilization for the shooting conditions is automatically applied (Intelligent IS). Additionally, the following icons are displayed in [AI] and [AUTO] modes.

	Image stabilization for still images (Normal)
	Image stabilization for still images when panning (Panning)*
	Image stabilization for macro shots. During movie recording,  is displayed, and image stabilization for macro movie recording is used (Hybrid IS).
	Image stabilization for movies, reducing strong camera shake, as when shooting while walking (Dynamic)
	Image stabilization for slow camera shake, such as when shooting movies at telephoto (Powered)
	No image stabilization, because the camera is mounted on a tripod or held still by other means. However, during movie recording,  is displayed, and image stabilization to counteract wind or other sources of vibration is used (Tripod IS).

\* Displayed when you pan, following moving subjects with the camera. When you follow subjects moving horizontally, image stabilization only counteracts vertical camera shake, and horizontal stabilization stops. Similarly, when you follow subjects moving vertically, image stabilization only counteracts horizontal camera shake.



- To cancel image stabilization, set [IS Mode] to [Off] (📖90). In this case, an IS icon is not displayed.
- In [AI] mode, no  icon is displayed.

## On-Screen Frames

► Still Images ► Movies

In [AUTO] mode, a variety of frames are displayed once the camera detects subjects you are aiming the camera at.

- A white frame is displayed around the subject (or person's face) determined by the camera to be the main subject, and gray frames are displayed around other detected faces. Frames follow moving subjects within a certain range to keep them in focus. However, if the camera detects subject movement, only the white frame will remain on the screen.
- When you are pressing the shutter button halfway and the camera detects subject movement, a blue frame is displayed, and the focus and image brightness are constantly adjusted (Servo AF).



- Try shooting in [P] mode (📖71) if no frames are displayed, if frames are not displayed around desired subjects, or if frames are displayed on the background or similar areas.

Before Use

Basic Guide

Advanced Guide

1 Camera Basics

2 Auto Mode / Hybrid Auto Mode

3 Other Shooting Modes

4 P Mode

5 Tv, Av, M, C1, and C2 Mode

6 Playback Mode

7 Wi-Fi Functions

8 Setting Menu

9 Accessories

10 Appendix

Index



## Common, Convenient Features

### Zooming In Closer on Subjects (Digital Zoom)

► Still Images ► Movies

When distant subjects are too far away to enlarge using the optical zoom, use digital zoom for up to about 260x enlargement.



#### 1 Move the zoom lever toward [Z].

- Hold the lever until zooming stops.
- Zooming stops at the largest possible zoom factor (before the image becomes noticeably grainy), which is then indicated on the screen.

#### 2 Move the zoom lever toward [Z] again.

- The camera zooms in even closer on the subject.
- (1) is the current zoom factor.

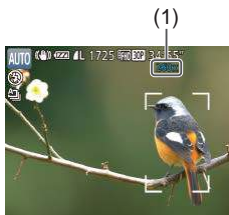

- Moving the zoom lever will display the zoom bar (which indicates the zoom position). The color of the zoom bar will change depending on the zoom range.
  - White range: optical zoom range where the image will not appear grainy.
  - Yellow range: digital zoom range where the image is not noticeably grainy (ZoomPlus).
  - Blue range: digital zoom range where the image will appear grainy.
- Because the blue range will not be available at some resolution settings (p.52), the maximum zoom factor can be achieved by following step 1.



- To deactivate digital zoom, choose MENU (p.30) ► [CAMERA] tab ► [Digital Zoom] ► [Off].

### Easily Reacquiring Subjects after Manual Zooming (Framing Assist – Seek)

► Still Images ► Movies

If you lose track of a subject while zoomed in, you can find it more easily by temporarily zooming out.

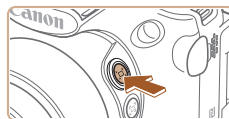

#### 1 Look for the lost subject.

- Press and hold the [Z] button.
- The camera zooms out and displays a white frame around the area shown before you pressed the [Z] button.

Before Use

Basic Guide

Advanced Guide

1 Camera Basics

2 Auto Mode / Hybrid Auto Mode

3 Other Shooting Modes

4 P Mode

5 Tv, Av, M, C1, and C2 Mode

6 Playback Mode

7 Wi-Fi Functions

8 Setting Menu

9 Accessories

10 Appendix

Index

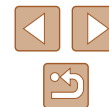





## 2 Reacquire the subject.

- Aim the camera so that the subject enters the white frame, and then release the [ ] button.
- The previous magnification is now restored, so that the area within the white frame fills the screen again.



- Some shooting information is not displayed while the camera is zoomed out.
- During movie shooting, the white frame is not displayed if you press the [ ] button. Also note that a changed zoom factor and camera operating sounds are recorded.



- If you prefer to shoot at the zoom factor of the screen in step 1, press the shutter button all the way down.
- You can adjust the zoom factor that the camera reverts to when you release the [ ] button by moving the zoom lever to resize the white frame while you hold the [ ] button.
- To adjust the area displayed when the [ ] button is pressed, access MENU ( ) ▶ [ ] tab ▶ [ ] [Display Area], and choose one of the three options.
- The zoom factor cannot be changed with the [ ] button after you press the shutter button all the way down in self-timer mode ( ).

## Easily Composing Shots after Manual Zooming (Framing Assist – Lock)

▶ Still Images ▶ Movies

You can reduce camera shake at the telephoto end, which makes it easier to compose shots.

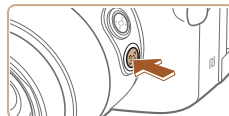

### 1 Compensate camera shake at the telephoto end.

- Press and hold the [ ] button. [ ] is displayed, and image stabilization optimal for shooting at the telephoto end is applied.



### 2 Shoot.

- While holding the [ ] button, press the shutter button halfway to focus on the subject, and then press it all the way down.



- The zoom factor cannot be adjusted by pressing the [ ] button ( ) while you are holding down the [ ] button.
- Recomposing the shot while holding down the [ ] button may make image stabilization less effective. In this case, [ ] is displayed in gray. If this occurs, release the [ ] button, compose the shot, and then press it again.
- If you start recording a movie while holding down the [ ] button, image stabilization may cause the shot to be recomposed.

Before Use
Basic Guide
Advanced Guide
<b>1</b> Camera Basics
<b>2</b> Auto Mode / Hybrid Auto Mode
<b>3</b> Other Shooting Modes
<b>4</b> P Mode
<b>5</b> Tv, Av, M, C1, and C2 Mode
<b>6</b> Playback Mode
<b>7</b> Wi-Fi Functions
<b>8</b> Setting Menu
<b>9</b> Accessories
<b>10</b> Appendix
Index





- Although no image stabilization icon is shown while you hold down the button, image stabilization optimal for shooting at the telephoto end is applied.
- To fine-tune the size of subjects gradually, move the zoom lever while holding down the button.

## Auto Zooming to Keep Faces at a Constant Size

▶ Still Images ▶ Movies

The camera automatically zooms in and out to keep a detected face (83) at a constant size on the screen. If the person moves closer, the camera automatically zooms out, and vice versa. This size can also be adjusted, as needed.



### 1 Enter Auto mode.

- Press and release the button quickly.
- Auto: On] is displayed.



### 2 Choose the face.

- is displayed once a face has been detected.
- If multiple faces are detected, press the button to switch to the face to keep at a constant size.
- The camera zooms in and out to keep the face framed by at a constant size on the screen.

## 3 Shoot.

- Even after you shoot, remains around the face displayed at a constant size.
- To cancel constant face display size, press the button again. Auto: Off] is displayed.

## Adjusting the Constant Face Display Size



- When Auto is on, press the buttons or turn the dial to choose the desired option.
- The camera zooms automatically to keep faces at the specified size.

Face	Keep faces large enough to show facial expressions clearly.
Upper Body	Keep faces small enough to show the person's upper body.
Whole Body	Keep faces small enough to show the person's entire body.
Manual	Keep faces at the size specified by moving the zoom lever. Release the zoom lever once the desired size has been obtained.



- A face may not be displayed at a constant size relative to the screen at some zoom factors, or if the person's head is tilted or facing the camera indirectly.
- During movie recording, a changed zoom factor and camera operating sounds are recorded.
- When Auto is on, some shooting information is not displayed, and some shooting settings cannot be configured.

Before Use

Basic Guide

Advanced Guide

1 Camera Basics

2 Auto Mode / Hybrid Auto Mode

3 Other Shooting Modes

4 P Mode

5 Tv, Av, M, C1, and C2 Mode

6 Playback Mode

7 Wi-Fi Functions

8 Setting Menu

9 Accessories

10 Appendix

Index





- If the person whose face is framed with moves toward the edge of the screen, the camera zooms out to keep the person in view.
- In step 3, switching to another face with the button is not possible during movie recording.
- The zoom factor remains the same after you press the shutter button all the way down in self-timer mode (p.44), even if the person's size relative to the screen changes.
- The face size can also be adjusted in MENU (p.30) ▶ tab ▶ Auto Settings] ▶ Auto Zoom]. You can choose [Off] to deactivate this feature and use only the feature described in "Easily Reacquiring Subjects with Auto Zooming (Seek Assist)" (p.43).
- You can zoom in or out with the zoom lever when [Face], [Upper Body], or [Whole Body] is selected, but the original zoom factor will be restored in a few seconds after you release the lever.
- Smile detection can be paused in mode (p.65) by pressing the button. To resume detection, press the button again.
- You can clear your specified face size during movie recording by pressing the button.
- Face sizes cannot be changed during movie recording.

## Easily Reacquiring Subjects with Auto Zooming (Seek Assist)

▶ Still Images ▶ Movies

If you lose track of a subject while zoomed in and move the camera to look for it, the camera detects this movement and automatically zooms out, which makes it easier to find the subject.



### 1 Enter Auto mode (p.42).

### 2 Look for the lost subject.

- When you move the camera to look for the subject, the camera zooms out to help you find it.



### 3 Reacquire the subject.

- Once you find the subject and stop moving the camera, the camera zooms in again.

### 4 Shoot.

- To cancel this mode, press the button again. Auto: Off] is displayed.



- The camera does not zoom out automatically while is displayed around a detected face, even if you move the camera.
- When the feature described in "Auto Zooming to Keep Faces at a Constant Size" is deactivated, is displayed around a detected face, and the camera automatically zooms out when moved.
- Zooming is not possible while the shutter button is pressed halfway.
- To deactivate this feature and use only the feature described in "Auto Zooming to Keep Faces at a Constant Size" (p.42), choose MENU (p.30) ▶ tab ▶ Auto Settings] ▶ [Seek Assist] ▶ [Off].

Before Use
Basic Guide
Advanced Guide
<b>1</b> Camera Basics
<b>2</b> Auto Mode / Hybrid Auto Mode
<b>3</b> Other Shooting Modes
<b>4</b> P Mode
<b>5</b> Tv, Av, M, C1, and C2 Mode
<b>6</b> Playback Mode
<b>7</b> Wi-Fi Functions
<b>8</b> Setting Menu
<b>9</b> Accessories
<b>10</b> Appendix
Index



## Using the Self-Timer

► Still Images ► Movies

With the self-timer, you can include yourself in group photos or other timed shots. The camera will shoot about 10 seconds after you press the shutter button.

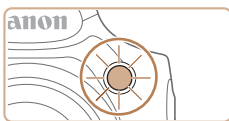

### 1 Configure the setting.

- Press the button, choose in the menu, and then choose (p.29).
- Once the setting is complete, is displayed.

### 2 Shoot.

- For Still Images: Press the shutter button halfway to focus on the subject, and then press it all the way down.
- For Movies: Press the movie button.
- Once you start the self-timer, the lamp will blink and the camera will play a self-timer sound.
- Two seconds before the shot, the blinking and sound will speed up. (The lamp will remain lit in case the flash fires.)
- To cancel shooting after you have triggered the self-timer, press the **[MENU]** button.
- To restore the original setting, choose in step 1.

## Using the Self-Timer to Avoid Camera Shake

► Still Images ► Movies

This option delays shutter release until about two seconds after you have pressed the shutter button. If the camera is unsteady while you are pressing the shutter button, it will not affect your shot.



- Follow step 1 in “Using the Self-Timer” (p.44) and choose .
- Once the setting is complete, is displayed.
- Follow step 2 in “Using the Self-Timer” (p.44) to shoot.

## Customizing the Self-Timer

► Still Images ► Movies

You can specify the delay (0 – 30 seconds) and number of shots (1 – 10).

### 1 Choose .

- Following step 1 in “Using the Self-Timer” (p.44), choose and press the **[MENU]** button immediately.

### 2 Configure the setting.

- Turn the dial to choose the [Delay] time, press the **[◀]****[▶]** buttons to choose the number of [Shots], and then press the .
- Once the setting is complete, is displayed.
- Follow step 2 in “Using the Self-Timer” (p.44) to shoot.



Before Use

Basic Guide

Advanced Guide

**1** Camera Basics

**2** Auto Mode / Hybrid Auto Mode

**3** Other Shooting Modes

**4** P Mode

**5** Tv, Av, M, C1, and C2 Mode

**6** Playback Mode

**7** Wi-Fi Functions

**8** Setting Menu

**9** Accessories

**10** Appendix

Index





- For movies shot using the self-timer, [Delay] represents the delay before recording begins, but the [Shots] setting has no effect.



- When you specify multiple shots, image brightness and white balance are determined by the first shot. More time is required between shots when the flash fires or when you have specified to take many shots. Shooting will stop automatically when the memory card becomes full.
- When a delay longer than two seconds is specified, two seconds before the shot, the lamp blinking and self-timer sound will speed up. (The lamp will remain lit in case the flash fires.)

## Adding a Date Stamp

► Still Images ► Movies

The camera can add the shooting date to images, in the lower-right corner.

However, note that date stamps cannot be edited or removed, so confirm beforehand that the date and time are correct (1620).

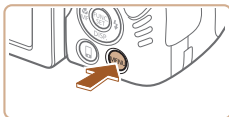

### 1 Configure the setting.

- Press the [MENU] button, choose [Date Stamp] on the [CAMERA] tab, and then choose the desired option (1630).
- Once the setting is complete, [CAMERA] is displayed.

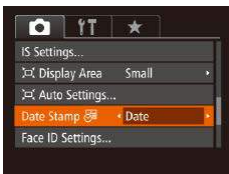

### 2 Shoot.

- As you take shots, the camera adds the shooting date or time to the lower-right corner of images.
- To restore the original setting, choose [Off] in step 1.



- Date stamps cannot be edited or removed.



- Shots taken without adding a date stamp can be printed with one as follows. However, adding a date stamp this way to images that already have one may cause it to be printed twice.
  - Print using printer functions (166)
  - Use camera DPOF print settings (170) to print
  - Use the software downloaded from the Canon website (164) to print

Before Use

Basic Guide

Advanced Guide

1 Camera Basics

2 Auto Mode / Hybrid Auto Mode

3 Other Shooting Modes

4 P Mode

5 Tv, Av, M, C1, and C2 Mode

6 Playback Mode

7 Wi-Fi Functions

8 Setting Menu

9 Accessories

10 Appendix

Index

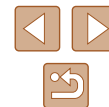

## Continuous Shooting

► Still Images ► Movies

In [AUTO] mode, hold the shutter button all the way down to shoot continuously.

For details on the continuous shooting speed, see “Continuous Shooting Speed” (📖198).

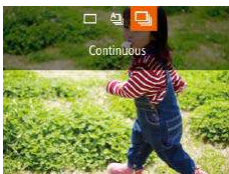

### 1 Configure the setting.

- Press the [▲] button, and then choose [CONT.] (📖29).
- Once the setting is complete, [CONT.] is displayed.

### 2 Shoot.

- Hold the shutter button all the way down to shoot continuously.



- Cannot be used with the self-timer (📖44).
- Shooting may stop momentarily or continuous shooting may slow down depending on shooting conditions, camera settings, and the zoom position.
- As more shots are taken, shooting may slow down.
- Shooting may slow down if the flash fires.
- Multi-area White Balance (📖33) is not available. Similarly, [Hg Lamp Corr.] (📖53) is set to [Off] and cannot be changed.

## Image Display during Playback

Each set of images shot continuously is managed as a single group, and only the first image in that group will be displayed. To indicate that the image is part of a group, [SET] is displayed in the upper left of the screen.



- If you erase a grouped image (📖112), all images in the group are also erased. Be careful when erasing images.



- Grouped images can be played back individually (📖107) and ungrouped (📖107).
- Protecting (📖110) a grouped image will protect all images in the group.
- Grouped images can be viewed individually when played back using Image Search (📖105) or Smart Shuffle (📖110). In this case, images are temporarily ungrouped.
- The following actions are not available for grouped images: editing Face ID information (📖107), magnifying (📖108), tagging as favorites (📖115), editing (📖116), printing (📖166), setting up individual image printing (📖171), or adding to a photobook (📖172). To do these things, either view grouped images individually (📖107) or cancel grouping (📖107) first.

Before Use

Basic Guide

Advanced Guide

1 Camera Basics

2 Auto Mode / Hybrid Auto Mode

3 Other Shooting Modes

4 P Mode

5 Tv, Av, M, C1, and C2 Mode

6 Playback Mode

7 Wi-Fi Functions

8 Setting Menu

9 Accessories

10 Appendix

Index



## Using Face ID

If you register a person ahead of time, the camera will detect that person's face, and prioritize focus, brightness, and color for that person when shooting. In [AUTO] mode, the camera can detect babies and children based on registered birthdays and optimize settings for them when shooting.

This function is also useful when searching for a specific registered person among a large number of images (📖105).

## Personal Information

- Information such as images of a face (face info) registered with Face ID, and personal information (name, birthday) will be saved on the camera. Additionally, when registered people are detected, their names will be recorded in still images. When using the Face ID function, be careful when sharing the camera or images with others, and when posting images online where many others can view them.
- When disposing of a camera or transferring it to another person after using Face ID, be sure to erase all information (registered faces, names, and birthdays) from the camera (📖51).

## Registering Face ID Information

You can register information (face info, names, birthdays) for up to 12 people to use with Face ID.

### 1 Display the screen on the LCD monitor.

- Open the LCD monitor to display the screen (📖20, 📖28).

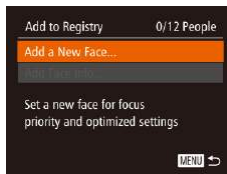
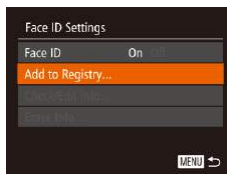
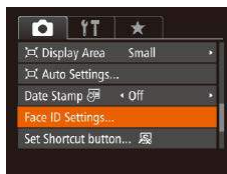

### 2 Access the setting screen.

- Press the [MENU] button, choose [Face ID Settings] on the [📷] tab, and then press the [📖] button (📖30).

- Press the [▲][▼] buttons to choose [Add to Registry], and then press the [📖] button.

- Press the [▲][▼] buttons to choose [Add a New Face], and then press the [📖] button.

### 3 Register face information.

- Aim the camera so that the face of the person you want to register is inside the gray frame at the center of the screen.
- A white frame on the person's face indicates that the face is recognized. Make sure a white frame is displayed on the face, and then shoot.
- If the face is not recognized, you cannot register face information.

Before Use

Basic Guide

Advanced Guide

1 Camera Basics

2 Auto Mode / Hybrid Auto Mode

3 Other Shooting Modes

4 P Mode

5 Tv, Av, M, C1, and C2 Mode

6 Playback Mode

7 Wi-Fi Functions

8 Setting Menu

9 Accessories

10 Appendix

Index

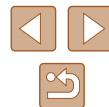

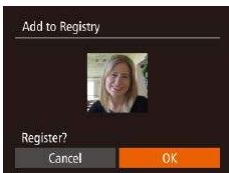

- After [Register?] is displayed, press the [◀][▶] buttons to choose [OK], and then press the [☑] button.
- The [Edit Profile] screen is displayed.

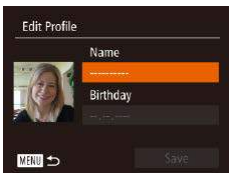

#### 4 Register the person's name and birthday.

- Press the [☑] button to access the keyboard, and then enter the name (📖31).



- To register a birthday, on the [Edit Profile] screen, press the [▲][▼] buttons to choose [Birthday], and then press the [☑] button.
- Press the [◀][▶] buttons to choose an option.
- Press the [▲][▼] buttons to specify the date.
- When finished, press the [☑] button.

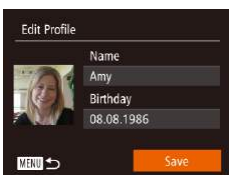

#### 5 Save the settings.

- Press the [▲][▼] buttons to choose [Save], and then press the [☑] button.
- After a message is displayed, press the [◀][▶] buttons to choose [Yes], and then press the [☑] button.

#### 6 Continue registering face information.

- To register up to 4 more points of face information (expressions or angles), repeat step 3.
- Registered faces are more easily recognized if you add a variety of face information. In addition to a head-on angle, add a slight side angle, a shot when smiling, and shots inside and outside.



- The flash will not fire when following step 3.
- If you do not register a birthday in step 4, Babies or Children icons (📖37) will not be displayed in [AUTO] mode.



- You can overwrite registered face info, and add face info later if you have not filled all 5 face info slots (📖47).

### Shooting

If you register a person ahead of time, the camera will prioritize that person as the main subject, and optimize focus, brightness, and color for that person when shooting.



- When you point the camera toward a subject, the names of up to 3 registered people will be displayed when they are detected.
- Shoot.
- Displayed names will be recorded in still images. Even if people are detected, but their names are not displayed, the names (up to 5 people) will be recorded in the image.

Before Use
Basic Guide
Advanced Guide
<b>1</b> Camera Basics
<b>2</b> Auto Mode / Hybrid Auto Mode
<b>3</b> Other Shooting Modes
<b>4</b> P Mode
<b>5</b> Tv, Av, M, C1, and C2 Mode
<b>6</b> Playback Mode
<b>7</b> Wi-Fi Functions
<b>8</b> Setting Menu
<b>9</b> Accessories
<b>10</b> Appendix
Index







- People other than those registered may be mistakenly detected as the registered person if they share similar facial features.



- Registered people may not be correctly detected if the captured image or scene differs drastically from the registered face information.
- If a registered face is not detected, or not easily detected, overwrite registered information with new face info. Registering face info right before shooting will allow for easier detection of registered faces.
- If a person is mistakenly detected as another person and you continue shooting, you can edit or erase the name recorded in the image during playback (📖107).
- Because faces of babies and children change quickly as they grow, you should update their face info regularly (📖47).
- When information display is set to off (📖28), names will not display, but will be recorded in the image.
- Names will still be recorded in images even if you clear the [Shooting Info] check box in [Custom Display] (📖96) on the [📷] tab so that the names are not displayed.
- If you don't want names to be recorded in still images, choose [Face ID Settings] on the [📷] tab, choose [Face ID], and then choose [Off].
- You can check names recorded in images in the playback screen (simple information display) (📖102).
- In [📷] mode, names are not displayed on the shooting screen, but they will be recorded in still images.
- Names recorded in continuous shooting (📖46, 📖86) will continue to be recorded in the same position as for the first shot, even if subjects move.

## Checking and Editing Registered Information

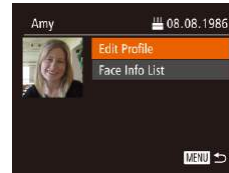
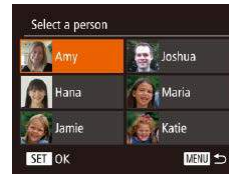

### 1 Access the [Check/Edit Info] screen.

- Following step 2 in “Registering Face ID Information” (📖47), choose [Check/Edit Info] and press the [📷] button.

### 2 Choose a person to check or edit.

- Press the [▲][▼][◀][▶] buttons to choose the person to check or edit, and then press the [📷] button.

### 3 Check or edit the information as needed.

- To check a name or birthday, choose [Edit Profile] by pressing the [▲][▼] buttons, and then press the [📷] button. On the screen displayed, you can edit names or birthdays as described in step 4 of “Registering Face ID Information” (📖47).
- To check face information, press the [▲][▼] buttons to choose [Face Info List], and then press the [📷] button. To erase face information, press the [📷] button on the screen displayed, press the [▲][▼][◀][▶] buttons to choose the face information to erase, and then press the [📷] button. After [Erase?] is displayed, press the [◀][▶] buttons to choose [OK], and then press the [📷] button.

Before Use

Basic Guide

Advanced Guide

1 Camera Basics

2 Auto Mode / Hybrid Auto Mode

3 Other Shooting Modes

4 P Mode

5 Tv, Av, M, C1, and C2 Mode

6 Playback Mode

7 Wi-Fi Functions

8 Setting Menu

9 Accessories

10 Appendix

Index

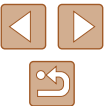



- Even if you change names in [Edit Profile], the names recorded in previously shot images will remain the same.



- You can use the software (164) to edit registered names. Some characters entered with the software may not display on the camera, but will be correctly recorded in images.

## Overwriting and Adding Face Information

You can overwrite existing face information with new face info. You should update face information regularly, especially with babies and children, as their faces change quickly as they grow. You can also add face information when all 5 face info slots have not been filled.

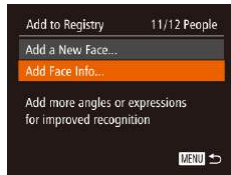

### 1 Access the [Add Face Info] screen.

- Following step 2 in “Registering Face ID Information” (47), choose [Add Face Info] and press the [OK] button.

### 2 Choose the name of the person to overwrite.

- Press the [▲][▼][◀][▶] buttons to choose the name of a person whose face info you want to overwrite, and then press the [OK] button.
- If five items of face info have already been registered, a message will be displayed. Choose [OK] by pressing the [◀][▶] buttons, and then press the [OK] button.
- If less than five items of face info are registered, go to step 4 to add face information.



### 3 Choose the face info to overwrite.

- Press the [▲][▼][◀][▶] buttons to choose the face info to overwrite, and then press the [OK] button.

### 4 Register face information.

- Follow step 3 in “Registering Face ID Information” (47) to shoot, and then register the new face information.
- Registered faces are more easily recognized if you add a variety of face information. In addition to a head-on angle, add a slight side angle, a shot when smiling, and shots inside and outside.



- You cannot add face information if all 5 information slots are filled. Follow the steps above to overwrite face information.
- You can follow the above steps to register new face info when there is at least one slot open; however, you cannot overwrite any face information. Instead of overwriting face info, first erase unwanted existing info (49), and then register new face information (47) as needed.

Before Use

Basic Guide

Advanced Guide

1 Camera Basics

2 Auto Mode / Hybrid Auto Mode

3 Other Shooting Modes

4 P Mode

5 Tv, Av, M, C1, and C2 Mode

6 Playback Mode

7 Wi-Fi Functions

8 Setting Menu

9 Accessories

10 Appendix

Index



## Erasing Registered Information

You can erase information (face info, names, birthdays) registered to Face ID. However, names recorded in previously shot images will not be erased.

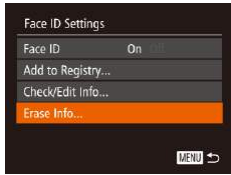

### 1 Access the [Erase Info] screen.

- Follow step 2 in “Registering Face ID Information” (📖47) and choose [Erase Info].

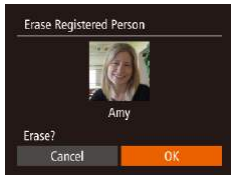

### 2 Choose the name of the person whose info you want to erase.

- Press the [▲][▼][◀][▶] buttons to choose the name of a person to erase, and then press the [⊗] button.
- After [Erase?] is displayed, press the [◀][▶] buttons to choose [OK], and then press the [⊗] button.



- If you erase a registered person's info, you will not be able to display their name (📖104), overwrite their info (📖107), or search images for them (📖105).



- You can also erase names in image information (📖108).

## Image Customization Features

### Changing the Aspect Ratio

► Still Images ► Movies

Change the image aspect ratio (ratio of width to height) as follows.



- Press the [⊗] button, choose [4:3] in the menu, and choose the desired option (📖29).
- Once the setting is complete, the screen aspect ratio will be updated.
- To restore the original setting, repeat this process but choose [4:3].

16:9	Used for display on widescreen HDTVs or similar display devices.
3:2	Same aspect ratio as 35mm film, used for printing images at 5 x 7-inch or postcard sizes.
4:3	Native aspect ratio of the camera screen, also used for display on standard-definition televisions or similar display devices, or for printing images at 3.5 x 5-inch or A-series sizes.
1:1	Square aspect ratio.
4:5	Aspect ratio commonly used for portraits.



- Not available in [📷] mode.

Before Use

Basic Guide

Advanced Guide

1 Camera Basics

2 Auto Mode / Hybrid Auto Mode

3 Other Shooting Modes

4 P Mode

5 Tv, Av, M, C1, and C2 Mode

6 Playback Mode

7 Wi-Fi Functions

8 Setting Menu

9 Accessories

10 Appendix

Index



## Changing Image Resolution (Size)

► Still Images ► Movies

Choose from 4 levels of image resolution, as follows. For guidelines on how many shots at each resolution setting can fit on a memory card, see “Number of Shots per Memory Card” (197).



- Press the [MENU] button, choose [L] in the menu, and choose the desired option (129).
- The option you configured is now displayed.
- To restore the original setting, repeat this process but choose [L].

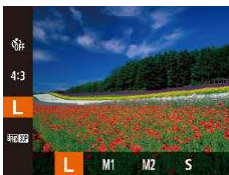

### Guidelines for Choosing Resolution Based on Paper Size (for 4:3 Images)

<b>L</b>	A2 (16.5 x 23.4 in.)
<b>M1</b>	A3 – A5 (11.7 x 16.5 – 5.8 x 8.3 in.)
<b>M2</b>	3.5 x 5 in., 5 x 7 in., Postcard
<b>S</b>	For e-mailing and similar purposes



- Not available in [A] mode.

## Red-Eye Correction

► Still Images ► Movies

Red-eye that occurs in flash photography can be automatically corrected as follows.

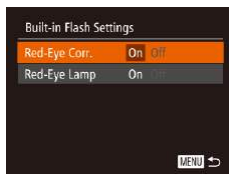
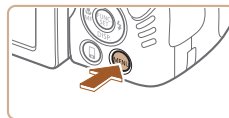

### 1 Access the [Built-in Flash Settings] screen.

- Press the [MENU] button, choose [Flash Control] on the [MENU] tab, and then press the [MENU] button (130).

### 2 Configure the setting.

- Choose [Red-Eye Corr.], and then choose [On] (130).
- Once the setting is complete, [OK] is displayed.
- To restore the original setting, repeat this process but choose [Off].



- Red-eye correction may be applied to image areas other than eyes (if the camera misinterprets red eye makeup as red pupils, for example).



- You can also correct existing images (119).
- You can also access the screen in step 2 when the flash is up by pressing the [▶] button and immediately pressing the [MENU] button.

Before Use

Basic Guide

Advanced Guide

1 Camera Basics

2 Auto Mode / Hybrid Auto Mode

3 Other Shooting Modes

4 P Mode

5 Tv, Av, M, C1, and C2 Mode

6 Playback Mode

7 Wi-Fi Functions

8 Setting Menu

9 Accessories

10 Appendix

Index



## Correcting Greenish Image Areas from Mercury Lamps

► Still Images ► Movies

In [AUTO] mode, subjects or background in shots of evening scenes illuminated by mercury lamps may appear to have a greenish tinge. This greenish tinge can be corrected automatically when shooting, using Multi-area White Balance.

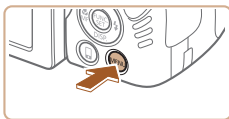

- Press the [MENU] button, choose [Hg Lamp Corr.] on the [CAMERA] tab, and then choose [On] (📖30).
- Once the setting is complete, [WB] is displayed.
- To restore the original setting, repeat this process but choose [Off].

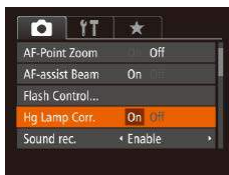

- After you are finished shooting under mercury lamps, you should set [Hg Lamp Corr.] back to [Off]. Otherwise, green hues not caused by mercury lamps may be corrected by mistake.



- Try taking some test shots first to make sure you obtain the desired results.
- In continuous shooting (📖46), this setting is set to [Off] and cannot be changed.

## Changing Movie Image Quality

► Still Images ► Movies

4 image quality settings are available. For guidelines on the maximum movie length at each level of image quality that will fit on a memory card, see "Recording Time per Memory Card" (📖198).



- Press the [Q] button, choose [FHD 60P] in the menu, and choose the desired option (📖29).
- The option you configured is now displayed.
- To restore the original setting, repeat this process but choose [FHD 60P].

Image Quality	Resolution	Frame Rate	Details
FHD 60P	1920 x 1080	60 fps	For shooting in Full HD. [FHD 60P] enables movies with smoother motion
FHD 30P	1920 x 1080	30 fps	
HD 30P	1280 x 720	30 fps	For shooting in HD
VGA 30P	640 x 480	30 fps	For shooting in standard definition



- In [FHD 60P], [FHD 30P], and [HD 30P] modes, black bars displayed on the top and bottom edges of the screen indicate image areas not recorded.

Before Use

Basic Guide

Advanced Guide

1 Camera Basics

2 Auto Mode / Hybrid Auto Mode

3 Other Shooting Modes

4 P Mode

5 Tv, Av, M, C1, and C2 Mode

6 Playback Mode

7 Wi-Fi Functions

8 Setting Menu

9 Accessories

10 Appendix

Index



# Helpful Shooting Features

## Using the Electronic Level

► Still Images ► Movies

An electronic level can be displayed on the screen when shooting as a guideline to determine if the camera is level.



### 1 Display the electronic level.

- Press the [▼] button several times to display the electronic level.

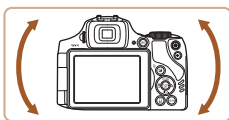

### 2 Level the camera as needed.

- Level the camera so that the center of the electronic level is green.



- If the electronic level is not displayed in step 1, press the [MENU] button, and on the [CAMERA] tab, choose [Custom Display]. Add a [✓] to [LVL] or [2VL] to choose the electronic level.
- Tilting the camera too far forward or backward will prevent you from using the electronic level, which will turn gray.
- The electronic level is not displayed during movie recording.
- If you hold the camera vertically, the orientation of the electronic level will be updated automatically to match the camera orientation.
- If your shots are not level even if you use the electronic level, try calibrating the electronic level (150).

## Magnifying the Area in Focus

► Still Images ► Movies

You can check the focus by pressing the shutter button halfway, which will enlarge the portion of the image in focus in the AF frame.

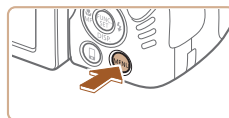

### 1 Configure the setting.

- Press the [MENU] button, choose [AF-Point Zoom] on the [CAMERA] tab, and then choose [On] (30).

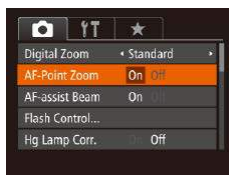

### 2 Check the focus.

- Press the shutter button halfway. The face detected as the main subject is now magnified.
- To restore the original setting, choose [Off] in step 1.



- The area in focus is not magnified in the following cases when the shutter button is pressed halfway.
  - If a face was not detected, if the person is too close to the camera and their face is too large for the screen, or if the camera detects subject movement
  - When digital zoom is used (40)
  - When Tracking AF is used (83)
  - When a TV is used as a display (157)
- Not available in [S&M] mode.

Before Use

Basic Guide

Advanced Guide

1 Camera Basics

2 Auto Mode / Hybrid Auto Mode

3 Other Shooting Modes

4 P Mode

5 Tv, Av, M, C1, and C2 Mode

6 Playback Mode

7 Wi-Fi Functions

8 Setting Menu

9 Accessories

10 Appendix

Index



## Checking for Closed Eyes

► Still Images ► Movies

 is displayed when the camera detects that people may have closed their eyes.

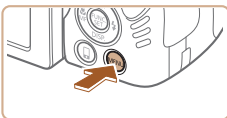

### 1 Configure the setting.



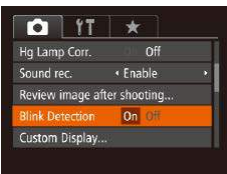



- Press the [MENU] button, choose [Blink Detection] on the  tab, and then choose [On] (30).



### 2 Shoot.

-  flashes when the camera detects a person whose eyes are closed.
- To restore the original setting, choose [Off] in step 1.



- When you have specified multiple shots in  mode, this function is only available for the final shot.
- A frame is displayed around people whose eyes are closed when you have selected [2 sec.], [4 sec.], [8 sec.], or [Hold] in [Display Time] (56).
- This feature is not available during continuous shooting in  mode (38).
- This feature is not available in continuous shooting mode (46, 86).

## Customizing Camera Operation



Customize shooting functions on the  tab of the menu screen as follows. For instructions on menu functions, see “Using the Menu Screen” (30).

### Deactivating the AF-Assist Beam

► Still Images ► Movies

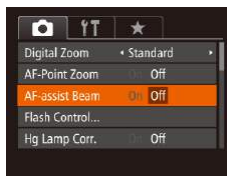
You can deactivate the lamp that normally lights up to help you focus when you press the shutter button halfway in low-light conditions.



- Press the [MENU] button, choose [AF-assist Beam] on the  tab, and then choose [Off] (30).
- To restore the original setting, repeat this process but choose [On].

### Deactivating the Red-Eye Reduction Lamp

► Still Images ► Movies

You can deactivate the red-eye reduction lamp that lights up to reduce red-eye when the flash is used in low-light shots.

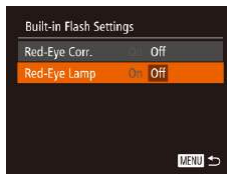

### 1 Access the [Built-in Flash Settings] screen.

- Press the [MENU] button, choose [Flash Control] on the  tab, and then press the  button (30).

### 2 Configure the setting.

- Choose [Red-Eye Lamp], and then choose [Off] (30).
- To restore the original setting, repeat this process but choose [On].

Before Use

Basic Guide

Advanced Guide

1 Camera Basics

2 Auto Mode / Hybrid Auto Mode

3 Other Shooting Modes

4 P Mode

5 Tv, Av, M, C1, and C2 Mode

6 Playback Mode

7 Wi-Fi Functions

8 Setting Menu

9 Accessories

10 Appendix

Index



## Changing the Image Display Style after Shots

▶ Still Images ▶ Movies

You can change how long images are displayed and what information is displayed immediately after shooting.

### Changing the Image Display Period after Shots

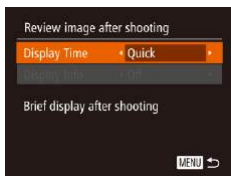

#### 1 Access the [Review image after shooting] screen.

- Press the [MENU] button, choose [Review image after shooting] on the [📷] tab, and then press the [Ⓜ] button (📖30).

#### 2 Configure the setting.

- Press the [▲][▼] buttons to choose [Display Time]. Press the [◀][▶] buttons to choose the desired option.
- To restore the original setting, repeat this process but choose [Quick].

Quick	Displays images only until you can shoot again.
2 sec., 4 sec., 8 sec.	Displays images for the specified time. Even while the shot is displayed, you can take another shot by pressing the shutter button halfway again.
Hold	Displays images until you press the shutter button halfway.
Off	No image display after shots.

### Changing the Screen Displayed after Shots

Change the way images are displayed after shots as follows.

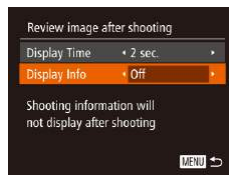

#### 1 Set [Display Time] to [2 sec.], [4 sec.], [8 sec.], or [Hold] (📖56).

#### 2 Configure the setting.

- Press the [▲][▼] buttons to choose [Display Info]. Press the [◀][▶] buttons to choose the desired option.
- To restore the original setting, repeat this process but choose [Off].

Off	Displays only the image.
Detailed	Displays shooting details (📖181).



- By pressing the [▼] button while an image is displayed after shooting, you can switch the display information. Note that the settings of [Display Info] are not changed. You can also erase images, by pressing the [🗑] button.

Before Use

Basic Guide

Advanced Guide

1 Camera Basics

2 Auto Mode / Hybrid Auto Mode

3 Other Shooting Modes

4 P Mode

5 Tv, Av, M, C1, and C2 Mode

6 Playback Mode

7 Wi-Fi Functions

8 Setting Menu

9 Accessories

10 Appendix

Index

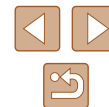



# 3

## Other Shooting Modes

Shoot more effectively in various scenes, and take shots enhanced with unique image effects or captured using special functions



## Enjoying a Variety of Images from Each Shot (Creative Shot)

► Still Images ► Movies

The camera determines the subject and shooting conditions, automatically applying special effects and recomposing the shot to emphasize the subject. Six still images are recorded for each shot. You can capture multiple still images with effects using camera-determined settings.



### 1 Enter [CAM] mode.

- Set the mode dial to [CAM].

### 2 Shoot.

- Press the shutter button all the way down. As you shoot, the shutter sound is played three times.
- After the six images are displayed in succession, they are displayed simultaneously for about two seconds.
- To keep the images displayed until you press the shutter button halfway, press the [DISP] button. For full-screen display in this state, choose an image by pressing the [▲][▼][◀][▶] buttons, and then press the [DISP] button.
- To return to the original display, press the [MENU] button.



- Shooting will take some time when the flash fires, but hold the camera steady until the shutter sound is played three times.
- The six images are managed together as a group (107).
- Simultaneous display of the six images as shown in step 2 is only available immediately after you shoot.

Before Use

Basic Guide

Advanced Guide

1 Camera Basics

2 Auto Mode / Hybrid Auto Mode

3 Other Shooting Modes

4 P Mode

5 Tv, Av, M, C1, and C2 Mode

6 Playback Mode

7 Wi-Fi Functions

8 Setting Menu

9 Accessories

10 Appendix

Index



## Choosing Effects

► Still Images ► Movies

You can choose effects for images captured in [ ] mode.



- After choosing [ ] mode, turn the [ ] dial to choose the effect.

Auto	All effects
Retro	Images resemble old photos
Monochrome	Images are generated in one color
Special	Bold, distinctive-looking images
Natural	Subdued, natural-looking images

## Moving Subjects (Sports)

► Still Images ► Movies

Shoot continuously as the camera focuses on moving subjects.



### 1 Enter [S] mode.

- Set the mode dial to [S].

### 2 Focus.

- While you are pressing the shutter button halfway, the camera will continue to adjust focus and image brightness where the blue frame is displayed.

### 3 Shoot.

- Hold the shutter button all the way down to shoot continuously.



- In [S] mode, shots may look grainy because the ISO speed (73) is increased to suit the shooting conditions.
- For details on the shooting range in [S] mode, see “Shooting Range” (198).
- There may be a delay after continuous shooting before you can shoot again. Note that some types of memory cards may delay your next shot even longer. SD Speed Class 6 or higher memory cards are recommended.
- Shooting may slow down depending on shooting conditions, camera settings, and the zoom position.

Before Use

Basic Guide

Advanced Guide

1 Camera Basics

2 Auto Mode / Hybrid Auto Mode

3 Other Shooting Modes

4 P Mode

5 Tv, Av, M, C1, and C2 Mode

6 Playback Mode

7 Wi-Fi Functions

8 Setting Menu

9 Accessories

10 Appendix

Index



## Specific Scenes

Choose a mode matching the shooting scene, and the camera will automatically configure the settings for optimal shots.



### 1 Enter [SCN] mode.

- Set the mode dial to [SCN].



### 2 Choose a shooting mode.

- Press the [M/AF] button, choose [S] in the menu, and then choose a shooting mode (p.29).

### 3 Shoot.



### Shooting Portraits (Portrait)

▶ Still Images ▶ Movies

- Take shots of people with a softening effect.



### Shooting Evening Scenes without Using a Tripod (Handheld NightScene)

▶ Still Images ▶ Movies

- Beautiful shots of evening scenes or portraits with evening scenery in the background, without the need to hold the camera very still (as with a tripod).
- A single image is created by combining consecutive shots, reducing camera shake and image noise.



### Shooting under Low Light (Low Light)

▶ Still Images ▶ Movies

- Shoot with minimal camera and subject shake even in low-light conditions.



### Shooting with Snowy Backgrounds (Snow)

▶ Still Images ▶ Movies

- Bright, natural-colored shots of people against snowy backgrounds.



### Shooting Fireworks (Fireworks)

▶ Still Images ▶ Movies

- Vivid shots of fireworks.



- Subjects appear larger in [P] mode compared to other modes.
- In [P] mode, shots may look grainy because the ISO speed (p.73) is increased to suit the shooting conditions.
- Because the camera will shoot continuously in [P] mode, hold it steady while shooting.
- In [P] mode, excessive motion blur or certain shooting conditions may prevent you from obtaining the desired results.
- In [P] mode, mount the camera on a tripod or take other measures to keep it still and prevent camera shake. Additionally, you should set [IS Mode] to [Off] when using a tripod or other means to secure the camera (p.90).

Before Use

Basic Guide

Advanced Guide

1 Camera Basics

2 Auto Mode / Hybrid Auto Mode

3 Other Shooting Modes

4 P Mode

5 Tv, Av, M, C1, and C2 Mode

6 Playback Mode

7 Wi-Fi Functions

8 Setting Menu

9 Accessories

10 Appendix

Index





- When you use a tripod for evening scenes, shooting in [AUTO] mode instead of [P] mode will give better results (p.33).
- [P] mode resolution is [M] (2304 x 1728) and cannot be changed.
- In [P] mode, although no frames are displayed when you press the shutter button halfway, optimal focus is still determined.

## Image Effects (Creative Filters)

Add a variety of effects to images when shooting.



### 1 Enter [Q] mode.

- Set the mode dial to [Q].



### 2 Choose a shooting mode.

- Press the [Q] button, choose [HDR] in the menu, and then choose a shooting mode (p.29).

### 3 Shoot.



### Shooting in Vivid Colors (Super Vivid)

► Still Images ► Movies

- Shots in rich, vivid colors.



### Posterized Shots (Poster Effect)

► Still Images ► Movies

- Shots that resemble an old poster or illustration.



- In [Q] and [P] modes, try taking some test shots first, to make sure you obtain the desired results.

Before Use

Basic Guide

Advanced Guide

1 Camera Basics

2 Auto Mode / Hybrid Auto Mode

3 Other Shooting Modes

4 P Mode

5 Tv, Av, M, C1, and C2 Mode

6 Playback Mode

7 Wi-Fi Functions

8 Setting Menu

9 Accessories

10 Appendix

Index



## Shooting High-Contrast Scenes (High Dynamic Range)

► Still Images ► Movies

Three consecutive images are captured at different brightness levels each time you shoot, and the camera combines image areas with optimal brightness to create a single image. This mode can reduce the washed-out highlights and loss of detail in shadows that tend to occur in high-contrast shots.

### 1 Choose [HDR].

- Follow steps 1 – 2 in “Image Effects (Creative Filters)” (📖60) and choose [HDR].



### 2 Shoot.

- Hold the camera steady as you shoot. When you press the shutter button all the way down, the camera will take three shots and combine them.



- Excessive motion blur or certain shooting conditions may prevent you from obtaining the desired results.



- If excessive camera shake interferes with shooting, mount the camera on a tripod or take other measures to keep it still. Additionally, you should set [IS Mode] to [Off] when using a tripod or other means to secure the camera (📖90).
- Any subject movement will cause images to look blurry.
- There will be a delay before you can shoot again, as the camera processes and combines the images.

## Adding Artistic Effects



- Follow steps 1 – 2 in “Image Effects (Creative Filters)” (📖60) and choose [HDR].
- Turn the [🌞] dial to choose a color effect.

Natural	Images are natural and organic.
Art Standard	Images resemble paintings, with subdued contrast.
Art Vivid	Images resemble vivid illustrations.
Art Bold	Images resemble oil paintings, with bold edges.
Art Embossed	Images resemble old photos, with bold edges and dark ambiance.

Before Use

Basic Guide

Advanced Guide

1 Camera Basics

2 Auto Mode /  
Hybrid Auto Mode

3 Other Shooting Modes

4 P Mode

5 Tv, Av, M, C1, and C2 Mode

6 Playback Mode

7 Wi-Fi Functions

8 Setting Menu

9 Accessories

10 Appendix

Index



## Shooting with a Fish-Eye Lens Effect (Fish-Eye Effect)

► Still Images ► Movies

Shoot with the distorting effect of a fish-eye lens.

### 1 Choose [📷].

- Follow steps 1 – 2 in “Image Effects (Creative Filters)” (📖60) and choose [📷].



### 2 Choose an effect level.

- Turn the [🌞] dial to choose an effect level.
- A preview is shown of how your shot will look with the effect applied.

### 3 Shoot.



- Try taking some test shots first, to make sure you obtain the desired results.

## Shots Resembling Miniature Models (Miniature Effect)

► Still Images ► Movies

Creates the effect of a miniature model, by blurring image areas above and below your selected area.

You can also make movies that look like scenes in miniature models by choosing the playback speed before the movie is recorded. People and objects in the scene will move quickly during playback. Note that sound is not recorded.

### 1 Choose [📷].

- Follow steps 1 – 2 in “Image Effects (Creative Filters)” (📖60) and choose [📷].
- A white frame is displayed, indicating the image area that will not be blurred.

### 2 Choose the area to keep in focus.

- Press the [▼] button.
- Move the zoom lever to resize the frame, and press the [▲][▼] buttons to move it.



### 3 For movies, choose the movie playback speed.

- Turn the [🌞] dial to choose the speed.

### 4 Return to the shooting screen and shoot.

- Press the [📷] button to return to the shooting screen, and then shoot.



Before Use

Basic Guide

Advanced Guide

1 Camera Basics

2 Auto Mode /  
Hybrid Auto Mode

3 Other Shooting Modes

4 P Mode

5 Tv, Av, M, C1, and C2 Mode

6 Playback Mode

7 Wi-Fi Functions

8 Setting Menu

9 Accessories

10 Appendix

Index



## Playback Speed and Estimated Playback Time (for One-Minute Clips)

Speed	Playback Time
5x	Approx. 12 sec.
10x	Approx. 6 sec.
20x	Approx. 3 sec.



- The zoom is not available when shooting movies. Be sure to set the zoom before shooting.
- Try taking some test shots first, to make sure you obtain the desired results.



- To switch the orientation of the frame to vertical, press the [◀][▶] buttons in step 2. To move the frame, press the [◀][▶] buttons again. To return the frame to horizontal orientation, press the [▲][▼] buttons.
- Holding the camera vertically will change the orientation of the frame.
- Movie image quality is [E-VGA] at an aspect ratio of [4:3] and [E-HD] at an aspect ratio of [16:9] (p. 51). These quality settings cannot be changed.
- The zoom factor cannot be changed with the [ZOOM] button on the screens in steps 2 and 3, or while shooting movies.

## Shooting with a Toy Camera Effect (Toy Camera Effect)

▶ Still Images ▶ Movies

This effect makes images resemble shots from a toy camera by vignetting (darker, blurred image corners) and changing the overall color.

### 1 Choose [CAM].

- Follow steps 1 – 2 in “Image Effects (Creative Filters)” (p. 60) and choose [CAM].

### 2 Choose a color tone.

- Turn the [WHEEL] dial to choose a color tone.
- A preview is shown of how your shot will look with the effect applied.



### 3 Shoot.

Standard	Shots resemble toy camera images.
Warm	Images have a warmer tone than with [Standard].
Cool	Images have a cooler tone than with [Standard].



- Try taking some test shots first, to make sure you obtain the desired results.

Before Use

Basic Guide

Advanced Guide

1 Camera Basics

2 Auto Mode / Hybrid Auto Mode

3 Other Shooting Modes

4 P Mode

5 Tv, Av, M, C1, and C2 Mode

6 Playback Mode

7 Wi-Fi Functions

8 Setting Menu

9 Accessories

10 Appendix

Index



## Shooting with a Soft Focus Effect

► Still Images ► Movies

This function allows you to shoot images as if a soft focus filter were attached to the camera. You can adjust the effect level as desired.

### 1 Choose [👤].

- Follow steps 1 – 2 in “Image Effects (Creative Filters)” (📖60) and choose [👤].



### 2 Choose an effect level.

- Turn the [🌞] dial to choose an effect level.
- A preview is shown of how your shot will look with the effect applied.

### 3 Shoot.



- Try taking some test shots first, to make sure you obtain the desired results.

## Shooting in Monochrome

► Still Images ► Movies

Shoot images in black and white, sepia, or blue and white.

### 1 Choose [🖼️].

- Follow steps 1 – 2 in “Image Effects (Creative Filters)” (📖60) and choose [🖼️].



### 2 Choose a color tone.

- Turn the [🌞] dial to choose a color tone.
- A preview is shown of how your shot will look with the effect applied.

### 3 Shoot.

B/W	Black and white shots.
Sepia	Sepia tone shots.
Blue	Blue and white shots.

Before Use

Basic Guide

Advanced Guide

1 Camera Basics

2 Auto Mode / Hybrid Auto Mode

3 Other Shooting Modes

4 P Mode

5 Tv, Av, M, C1, and C2 Mode

6 Playback Mode

7 Wi-Fi Functions

8 Setting Menu

9 Accessories

10 Appendix

Index





## Special Modes for Other Purposes

### Auto Shooting after Face Detection (Smart Shutter)

▶ Still Images ▶ Movies

### Auto Shooting after Smile Detection

▶ Still Images ▶ Movies

The camera shoots automatically after detecting a smile, even without you pressing the shutter button.

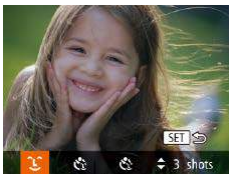

#### 1 Choose [📷].

- Follow steps 1 – 2 in “Specific Scenes” (📖59) and choose [📷], and then press the [▼] button.
- Press the [◀][▶] buttons to choose [📷], and then press the [🔘] button.
- The camera now enters shooting standby mode, and [Smile Detection on] is displayed.



#### 2 Aim the camera at a person.

- Each time the camera detects a smile, it will shoot after the lamp lights up.
- To pause smile detection, press the [▲] button. Press the [▲] button again to resume detection.



- Switch to another mode when you finish shooting, or the camera will continue shooting each time a smile is detected.



- You can also shoot as usual by pressing the shutter button.
- The camera can detect smiles more easily when subjects face the camera and open their mouth wide enough so that teeth are visible.
- To change the number of shots, press the [▲][▼] buttons after choosing [📷] in step 1. [Blink Detection] (📖55) is only available for the final shot.
- Automatic shooting is not available while you are holding down the [🔘] button.

### Using the Wink Self-Timer

▶ Still Images ▶ Movies

Aim the camera at a person and press the shutter button all the way down. The camera will shoot about two seconds after a wink is detected.



#### 1 Choose [📷].

- Follow steps 1 – 2 in “Specific Scenes” (📖59) and choose [📷], and then press the [▼] button.
- Press the [◀][▶] buttons to choose [📷], and then press the [🔘] button.

#### 2 Compose the shot and press the shutter button halfway.

- Make sure a green frame is displayed around the face of the person who will wink.

#### 3 Press the shutter button all the way down.

- The camera now enters shooting standby mode, and [Wink to take picture] is displayed.
- The lamp blinks and the self-timer sound is played.

Before Use

Basic Guide

Advanced Guide

1 Camera Basics

2 Auto Mode / Hybrid Auto Mode

3 Other Shooting Modes

4 P Mode

5 Tv, Av, M, C1, and C2 Mode

6 Playback Mode

7 Wi-Fi Functions

8 Setting Menu

9 Accessories

10 Appendix

Index

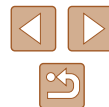



#### 4 Face the camera and wink.

- The camera will shoot about two seconds after detecting a wink by the person whose face is inside the frame.
- To cancel shooting after you have triggered the self-timer, press the [MENU] button.



- If the wink is not detected, wink again slowly and deliberately.
- Winking may not be detected if eyes are obscured by hair, a hat, or glasses.
- Closing and opening both eyes at once will also be detected as a wink.
- If winking is not detected, the camera will shoot about 15 seconds later.
- To change the number of shots, press the [▲][▼] buttons after choosing [👁️] in step 1. [Blink Detection] (📖55) is only available for the final shot.
- If no one is in the shooting area when the shutter button is pressed all the way down, the camera will shoot after a person enters the shooting area and winks.
- The zoom factor cannot be changed with the [🔍] button after you press the shutter button all the way down.

#### Using the Face Self-Timer

▶ Still Images ▶ Movies

The camera will shoot about two seconds after detecting that the face of another person (such as the photographer) has entered the shooting area (📖83). This is useful when including yourself in group photos or similar shots.



#### 1 Choose [👁️].

- Follow steps 1 – 2 in “Specific Scenes” (📖59) and choose [👁️], and then press the [▼] button.
- Press the [◀][▶] buttons to choose [👁️], and then press the [📷] button.

#### 2 Compose the shot and press the shutter button halfway.

- Make sure a green frame is displayed around the face you focus on and white frames around other faces.

#### 3 Press the shutter button all the way down.

- The camera now enters shooting standby mode, and [Look straight at camera to start count down] is displayed.
- The lamp blinks and the self-timer sound is played.

#### 4 Join the subjects in the shooting area and look at the camera.

- After the camera detects a new face, the lamp blinking and self-timer sound will speed up. (When the flash fires, the lamp will remain lit.) About two seconds later, the camera will shoot.
- To cancel shooting after you have triggered the self-timer, press the [MENU] button.



Before Use
Basic Guide
Advanced Guide
<b>1</b> Camera Basics
<b>2</b> Auto Mode / Hybrid Auto Mode
<b>3</b> Other Shooting Modes
<b>4</b> P Mode
<b>5</b> Tv, Av, M, C1, and C2 Mode
<b>6</b> Playback Mode
<b>7</b> Wi-Fi Functions
<b>8</b> Setting Menu
<b>9</b> Accessories
<b>10</b> Appendix
Index





- Even if your face is not detected after you join the others in the shooting area, the camera will shoot about 15 seconds later.
- To change the number of shots, press the [▲][▼] buttons after choosing [📷] in step 1. [Blink Detection] (📖55) is only available for the final shot.
- The zoom factor cannot be changed with the [📷] button after you press the shutter button all the way down.

## Shooting Various Movies

▶ Still Images ▶ Movies

### Shooting Movies in Movie Mode

▶ Still Images ▶ Movies



#### 1 Enter [🎬] mode.

- Set the mode dial to [🎬].
- Black bars are displayed on the top and bottom edges of the screen, and the subject is slightly enlarged. The black bars indicate image areas not recorded.

#### 2 Configure the settings to suit the movie (📖182).

#### 3 Shoot.

- Press the movie button.
- To stop movie recording, press the movie button again.

Before Use

Basic Guide

Advanced Guide

1 Camera Basics

2 Auto Mode / Hybrid Auto Mode

3 Other Shooting Modes

4 P Mode

5 Tv, Av, M, C1, and C2 Mode

6 Playback Mode

7 Wi-Fi Functions

8 Setting Menu

9 Accessories

10 Appendix

Index



## Locking or Changing Image Brightness before Shooting

▶ Still Images ▶ Movies

You can lock the exposure before or during recording or adjust it in 1/3-stop increments within a range of -2 to +2 stops.

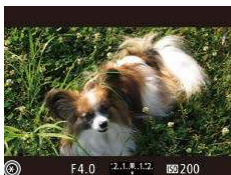

### 1 Lock the exposure.

- While holding the shutter button halfway down, press the [L] button to lock the exposure. [L] is displayed.
- To unlock the exposure, press the [L] button again.

### 2 Adjust the exposure.

- Turn the [EV] dial to adjust the exposure, as you watch the screen.

### 3 Shoot.



- To make the sound of the [EV] dial quieter while you are recording a movie, press the [▲][▼] buttons and adjust the setting.
- You can switch between adjusting the exposure compensation and focal position during MF (p.79) movie recording each time you press the [L] button. Press the [▲][▼] buttons to configure these settings.

## Sound Settings

▶ Still Images ▶ Movies

### Adjusting the Recording Volume

Although the recording level (volume) is automatically adjusted to reduce distortion, you can set the level manually to suit the shooting scene.

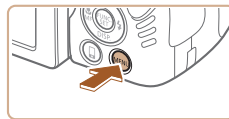

### 1 Access the [Sound rec.] screen.

- Press the [MENU] button, choose [Sound rec.] on the [CAM] tab, and then press the [L] button (p.30).

### 2 Configure the setting.

- Choose [Sound rec.], and then choose [Manual] (p.30).
- Press the [▼] button, and then press the [L][R] buttons to configure the [Level] setting.
- To restore the original setting, repeat this process but choose [Auto].

Before Use

Basic Guide

Advanced Guide

1 Camera Basics

2 Auto Mode / Hybrid Auto Mode

3 Other Shooting Modes

4 P Mode

5 Tv, Av, M, C1, and C2 Mode

6 Playback Mode

7 Wi-Fi Functions

8 Setting Menu

9 Accessories

10 Appendix

Index



## Deactivating the Wind Filter

Reduce audio distortion from strong wind. (To ensure natural sound, do not use unless there is wind.) In this case, you can deactivate the wind filter.



- Access the [Sound rec.] screen as described in step 1 of “Adjusting the Recording Volume”.
- Choose [Wind filter/Attenuator], and then press the [⊕] button.
- Choose [Wind Filter], and then choose [Off] (📖30).

## Using the Attenuator

The attenuator can reduce audio distortion in noisy environments. However, in quiet environments, it lowers the sound-recording level.

- Access the [Sound rec.] screen as described in step 1 of “Adjusting the Recording Volume”.
- Choose [Wind filter/Attenuator], and then press the [⊕] button.
- Choose [Attenuator], and then choose [On] (📖30).

## Shooting iFrame Movies

▶ Still Images ▶ Movies

Shoot movies that can be edited with iFrame-compatible software or devices. You can quickly edit, save, and manage your iFrame movies using the software (📖164).



### 1 Choose [📹].

- Set the mode dial to [P].
- Press the [⊕] button, choose [📹] in the menu, and then choose [📹] (📖29).
- Black bars displayed on the top and bottom edges of the screen indicate image areas not recorded.

### 2 Shoot (📖67).

- Press the movie button.
- To stop movie recording, press the movie button again.



- The resolution is [FHD 30P] (📖53) and cannot be changed.
- iFrame is a video format developed by Apple Inc.

Before Use

Basic Guide

Advanced Guide

1 Camera Basics

2 Auto Mode / Hybrid Auto Mode

3 Other Shooting Modes

4 P Mode

5 Tv, Av, M, C1, and C2 Mode

6 Playback Mode

7 Wi-Fi Functions

8 Setting Menu

9 Accessories

10 Appendix

Index

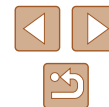

## Shooting Super Slow Motion Movies

► Still Images ► Movies

You can shoot fast-moving subjects for playback later in slow motion. Note that sound is not recorded.

### 1 Choose [M].

- Set the mode dial to [M].
- Press the [MENU] button, choose [M] in the menu, and then choose [M] (1629).



### 2 Choose a frame rate.

- Press the [MENU] button, choose [QVGA 240P] in the menu, and choose the desired frame rate (1629).
- The option you configured is now displayed.



### 3 Shoot (1667).

- Press the movie button.
- A bar showing the elapsed time is displayed. Maximum clip length is approx. 30 sec.
- To stop movie recording, press the movie button again.

Frame Rate	Image Quality	Playback Time (For a 30-sec. Clip)
240P 240 fps	QVGA (320 x 240)	Approx. 4 min.
120P 120 fps	HVGA (640 x 480)	Approx. 2 min.



- Zooming is not available during recording, even if you move the zoom lever.
- Focus, exposure, and color are determined when you press the movie button.



- When you play the movie (16101), it will be played back in slow motion.
- You can change the playback speed of movies by using the software (16164).

Before Use

Basic Guide

Advanced Guide

1 Camera Basics

2 Auto Mode / Hybrid Auto Mode

3 Other Shooting Modes

4 P Mode

5 Tv, Av, M, C1, and C2 Mode

6 Playback Mode

7 Wi-Fi Functions

8 Setting Menu

9 Accessories

10 Appendix

Index

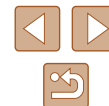

# 4

## P Mode

More discerning shots, in your preferred shooting style



- Instructions in this chapter apply to the camera with the mode dial set to **[P]** mode.
- **[P]**: Program AE; AE: Auto Exposure
- Before using a function introduced in this chapter in modes other than **[P]**, make sure the function is available in that mode (📖182).

## Shooting in Program AE ([P] Mode)

▶ Still Images ▶ Movies

You can customize many function settings to suit your preferred shooting style.



### 1 Enter [P] mode.

- Set the mode dial to **[P]**.

### 2 Customize the settings as desired (📖72 – 📖90), and then shoot.



- If adequate exposure cannot be obtained when you press the shutter button halfway, shutter speeds and aperture values are displayed in orange. In this case, try adjusting the ISO speed (📖73) or activating the flash (if subjects are dark, 📖86), which may enable adequate exposure.
- Movies can be recorded in **[P]** mode as well, by pressing the movie button. However, some FUNC. (📖29) and MENU (📖30) settings may be automatically adjusted for movie recording.

Before Use

Basic Guide

Advanced Guide

1 Camera Basics

2 Auto Mode / Hybrid Auto Mode

3 Other Shooting Modes

4 P Mode

5 Tv, Av, M, C1, and C2 Mode

6 Playback Mode

7 Wi-Fi Functions

8 Setting Menu

9 Accessories

10 Appendix

Index

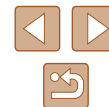

## Image Brightness (Exposure)

### Adjusting Image Brightness (Exposure Compensation)

▶ Still Images ▶ Movies

The standard exposure set by the camera can be adjusted in 1/3-stop increments, in a range of -3 to +3.



- Press the button. As you watch the screen, turn the dial to adjust brightness, and then press the button again when finished.
- The correction level you specified is now displayed.

### Locking Image Brightness / Exposure (AE Lock)

▶ Still Images ▶ Movies

Before shooting, you can lock the exposure, or you can specify focus and exposure separately.

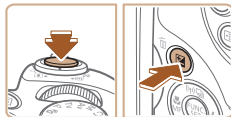

#### 1 Lock the exposure.

- Aim the camera at the subject to shoot with the exposure locked. With the shutter button pressed halfway, press the button.
- is displayed, and the exposure is locked.
- To unlock AE, release the shutter button and press the button again. In this case, is no longer displayed.

#### 2 Compose the shot and shoot.

- After one shot, AE is unlocked and is no longer displayed.



- AE: Auto Exposure
- After the exposure is locked, you can adjust the combination of shutter speed and aperture value by turning the dial (Program Shift).

### Changing the Metering Method

▶ Still Images ▶ Movies

Adjust the metering method (how brightness is measured) to suit shooting conditions as follows.



- Press the button, choose in the menu, and choose the desired option ( 29).
- The option you configured is now displayed.

Evaluative	For typical shooting conditions, including backlit shots. Automatically adjusts exposure to match the shooting conditions.
Center Weighted Avg.	Determines the average brightness of light across the entire image area, calculated by treating brightness in the central area as more important.
Spot	Metering restricted to within the  (Spot AE Point frame). You can also link the Spot AE Point frame to the AF frame ( 73).

Before Use

Basic Guide

Advanced Guide

1 Camera Basics

2 Auto Mode / Hybrid Auto Mode

3 Other Shooting Modes

4 P Mode

5 Tv, Av, M, C1, and C2 Mode

6 Playback Mode

7 Wi-Fi Functions

8 Setting Menu

9 Accessories

10 Appendix

Index

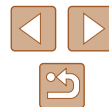



## Linking the Spot AE Point Frame to the AF Frame

► Still Images ► Movies

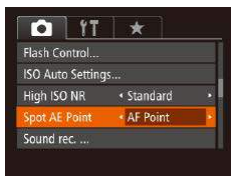

### 1 Set the metering method to [••].

- Follow the steps in "Changing the Metering Method" (872) to choose [••].

### 2 Configure the setting.

- Press the [MENU] button, choose [Spot AE Point] on the [•] tab, and then choose [AF Point] (830).
- The Spot AE Point frame will now be linked to the movement of the AF frame (882).



- Not available when [AF Frame] is set to [Face Detect] (883) or [Tracking AF] (883).

## Changing the ISO Speed

► Still Images ► Movies



- Press the [•] button, and then choose [ISO] in the menu (829).
- Press the [◀▶] buttons or turn the [•] dial to choose an ISO speed.
- The option you configured is now displayed.

AUTO	Automatically adjusts the ISO speed to suit the shooting mode and conditions.	
100, 125, 160, 200	Low	For shooting outdoors in fair weather.
250, 320, 400, 500, 640, 800	Slightly Low	For shooting in cloudy conditions, or at twilight.
1000, 1250, 1600, 2000, 2500, 3200	Slightly High	For shooting night scenes, or in dark rooms.



- If motion blur is not reduced enough at an ISO speed of [3200], you can specify [•] mode (859) and choose [4000], [5000], or [6400].

Before Use

Basic Guide

Advanced Guide

1 Camera Basics

2 Auto Mode / Hybrid Auto Mode

3 Other Shooting Modes

4 P Mode

5 Tv, Av, M, C1, and C2 Mode

6 Playback Mode

7 Wi-Fi Functions

8 Setting Menu

9 Accessories

10 Appendix

Index

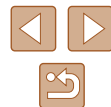



- To view the automatically determined ISO speed when you have set the ISO speed to [AUTO], press the shutter button halfway.
- Although choosing a lower ISO speed may reduce image graininess, there may be a greater risk of subject and camera shake in some shooting conditions.
- Choosing a higher ISO speed will increase shutter speed, which may reduce subject and camera shake and increase the flash range. However, shots may look grainy.

## Adjusting ISO Auto Settings

▶ Still Images ▶ Movies

When the camera is set to [AUTO], maximum ISO speed can be specified in a range of [400] – [3200], and sensitivity can be specified in a range of three levels.

### 1 Access the setting screen.

- Press the [MENU] button, choose [ISO Auto Settings] on the [CAMERA] tab, and then press the [OK] button (p.30).

### 2 Configure the setting.

- Choose a menu item to configure, and then choose the desired option (p.30).

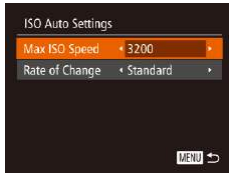

- You can also access the [ISO Auto Settings] screen when the [ISO speed setting screen] (p.73) is displayed, by pressing the [MENU] button.

## Changing the Noise Reduction Level (High ISO NR)

You can choose from 3 levels of noise reduction: [Standard], [High], [Low]. This function is especially effective when shooting at high ISO speeds.



- Press the [MENU] button, choose [High ISO NR] on the [CAMERA] tab, and then choose the desired option (p.30).



- Not available with [RAW] or [RAW] (p.89).

## Auto Exposure Bracketting (AEB Shooting)

▶ Still Images ▶ Movies

Three consecutive images are captured at different exposure levels (standard exposure, underexposure, and then overexposure) each time you shoot. You can adjust the amount of underexposure and overexposure (relative to standard exposure) from –2 to +2 stops in 1/3-stop increments.



### 1 Choose [AEB].

- Press the [OK] button, choose [AEB] in the menu, and then choose [AEB] (p.29).

Before Use

Basic Guide

Advanced Guide

1 Camera Basics

2 Auto Mode / Hybrid Auto Mode

3 Other Shooting Modes

4 P Mode

5 Tv, Av, M, C1, and C2 Mode

6 Playback Mode

7 Wi-Fi Functions

8 Setting Menu

9 Accessories

10 Appendix

Index





## 2 Configure the setting.

- Press the **[MENU]** button, and then adjust the setting by pressing the **[←/→]** buttons or turning the **[Sun]** dial.



- AEB shooting is only available in **[P]** mode (186).
- Continuous shooting (86) is not available in this mode.



- If exposure compensation is already in use (72), the value specified for that function is treated as the standard exposure level for this function.
- You can also access the setting screen of step 2 by pressing the **[MENU]** button when the exposure compensation screen (72) is displayed.
- Three shots are taken, regardless of any quantity specified in **[C]** (44).
- In **[Blink Detection]** mode (55), this function is only available for the final shot.

## Correcting Image Brightness (i-Contrast)

► Still Images ► Movies

Before shooting, excessively bright or dark image areas (such as faces or backgrounds) can be detected and automatically adjusted to the optimal brightness.

To avoid washed-out highlights, specify Dynamic Range Correction. To preserve image detail in shadows, specify Shadow Correct.



- Under some shooting conditions, correction may be inaccurate or may cause images to appear grainy.



- You can also correct existing images (118).

## Dynamic Range Correction (DR Correction)

► Still Images ► Movies

Tone down bright image areas, which might otherwise look washed out, as follows.



- Press the **[MENU]** button, choose **[OFF]** in the menu, and choose the desired option (29).
- Once the setting is complete, **[Auto]** is displayed.

Options	Details	Available ISO Speed (73)
<b>[OFF]</b>	—	
<b>[AUTO]</b>	Automatic adjustment to prevent washed-out highlights	[AUTO], [100] – [3200]
<b>[200%]</b>	Tone down highlights by about 200% relative to the brightness level of <b>[OFF]</b> .	[AUTO], [200] – [3200]
<b>[400%]</b>	Tone down highlights by about 400% relative to the brightness level of <b>[OFF]</b> .	[AUTO], [400] – [3200]



- ISO speed (73) will be adjusted to a speed within the supported range if you have specified a value outside the supported range indicated here.

Before Use

Basic Guide

Advanced Guide

1 Camera Basics

2 Auto Mode / Hybrid Auto Mode

3 Other Shooting Modes

4 P Mode

5 Tv, Av, M, C1, and C2 Mode

6 Playback Mode

7 Wi-Fi Functions

8 Setting Menu

9 Accessories

10 Appendix

Index



## Shadow Correct

► Still Images ► Movies

Automatically preserve image detail in shadows as follows.



- Press the **[]** button, choose **[]** in the menu, and then choose **[]** (**29**).
- Once the setting is complete, **[]** is displayed.

## Image Colors

### Adjusting White Balance

► Still Images ► Movies

By adjusting white balance (WB), you can make image colors look more natural for the scene you are shooting.



- Press the **[]** button, choose **[]** in the menu, and choose the desired option (**29**).
- The option you configured is now displayed.

Auto	Automatically sets the optimal white balance for the shooting conditions.
Day Light	For shooting outdoors in fair weather.
Shade	For shooting in the shade.
Cloudy	For shooting in cloudy weather or at twilight.
Tungsten	For shooting under ordinary incandescent lighting.
Fluorescent	For shooting under white fluorescent lighting.
Fluorescent H	For shooting under daylight fluorescent lighting.
Flash	For shooting with the flash.
Custom	For manually setting a custom white balance ( <b>77</b> ).

Before Use

Basic Guide

Advanced Guide

**1** Camera Basics

**2** Auto Mode / Hybrid Auto Mode

**3** Other Shooting Modes

**4** P Mode

**5** Tv, Av, M, C1, and C2 Mode

**6** Playback Mode

**7** Wi-Fi Functions

**8** Setting Menu

**9** Accessories

**10** Appendix

Index



## Custom White Balance

► Still Images ► Movies

For image colors that look natural under the light in your shot, adjust white balance to suit the light source where you are shooting. Set the white balance under the same light source that will illuminate your shot.

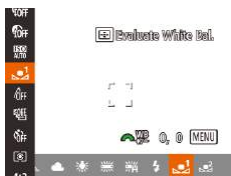

- Follow the steps in "Adjusting White Balance" (📖76) to choose [☑️] or [📷].
- Aim the camera at a plain white subject, so that the entire screen is white. Press the [📷] button.
- The tint of the screen changes once the white balance data has been recorded.



- Colors may look unnatural if you change camera settings after recording white balance data.

## Manually Correcting White Balance

► Still Images ► Movies

You can correct white balance. This adjustment can match the effect of using a commercially available color temperature conversion filter or color-compensating filter.



### 1 Configure the setting.

- Follow the steps in "Adjusting White Balance" (📖76) to choose [MANU].
- Turn the [🌞] dial to adjust the correction level for B and A.
- Once the setting is complete, [WB] is displayed.

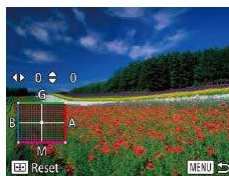

- The camera will retain white balance correction levels even if you switch to another white balance option (by following steps in "Adjusting White Balance" (📖76)), but correction levels will be reset if you record custom white balance data.



- B: blue; A: amber; M: magenta; G: green
- One level of blue/amber correction is equivalent to about 7 mireds on a color temperature conversion filter. (Mired: Color temperature unit representing color temperature conversion filter density)

## 2 Configure advanced settings.

- To configure more advanced settings, press the [MENU] button and adjust the correction level by turning the [🌞] dial or pressing the [▲][▼][◀][▶] buttons.
- To reset the correction level, press the [📷] button.
- Press the [MENU] button to complete the setting.

## Changing Image Color Tones (My Colors)

► Still Images ► Movies

Change image color tones as desired, such as converting images to sepia or black and white.



- Press the [📷] button, choose [🌞] in the menu, and choose the desired option (📖29).
- The option you configured is now displayed.

Before Use
Basic Guide
Advanced Guide
1 Camera Basics
2 Auto Mode / Hybrid Auto Mode
3 Other Shooting Modes
4 P Mode
5 Tv, Av, M, C1, and C2 Mode
6 Playback Mode
7 Wi-Fi Functions
8 Setting Menu
9 Accessories
10 Appendix

Index



☞ My Colors Off	–
Av Vivid	Emphasizes contrast and color saturation, making images sharper.
AN Neutral	Tones down contrast and color saturation for subdued images.
Se Sepia	Creates sepia tone images.
B/W B/W	Creates black and white images.
P Positive Film	Combines the effects of Vivid Blue, Vivid Green, and Vivid Red to produce intense yet natural-looking colors resembling images on positive film.
L Lighter Skin Tone	Lightens skin tones.
D Darker Skin Tone	Darkens skin tones.
B Vivid Blue	Emphasizes blues in images. Makes the sky, ocean, and other blue subjects more vivid.
G Vivid Green	Emphasizes greens in images. Makes mountains, foliage, and other green subjects more vivid.
R Vivid Red	Emphasizes reds in images. Makes red subjects more vivid.
C Custom Color	Adjust contrast, sharpness, color saturation, and other qualities as desired (78).



- White balance (76) cannot be set in [Se] or [B/W] modes.
- With [L] and [D] modes, colors other than people's skin tone may change. These settings may not produce the expected results with some skin tones.

## Custom Color

► Still Images ► Movies

Choose the desired level of image contrast, sharpness, color saturation, red, green, blue, and skin tones in a range of 1 – 5.

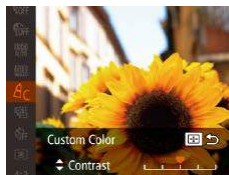

### 1 Access the setting screen.

- Follow the steps in “Changing Image Color Tones (My Colors)” (77) to choose [C], and then press the [ ] button.

### 2 Configure the setting.

- Press the [▲][▼] buttons to choose an option, and then specify the value by pressing the [◀][▶] buttons.
- For stronger/more intense effects (or darker skin tones), adjust the value to the right, and for weaker/lighter effects (or lighter skin tones), adjust the value to the left.
- Press the [ ] button to complete the setting.

Before Use

Basic Guide

Advanced Guide

1 Camera Basics

2 Auto Mode / Hybrid Auto Mode

3 Other Shooting Modes

4 P Mode

5 Tv, Av, M, C1, and C2 Mode

6 Playback Mode

7 Wi-Fi Functions

8 Setting Menu

9 Accessories

10 Appendix

Index



## Shooting Range and Focusing

### Shooting Close-Ups (Macro)

► Still Images ► Movies

To restrict the focus to subjects at close range, set the camera to [M]. For details on the focusing range, see “Shooting Range” (📖198).

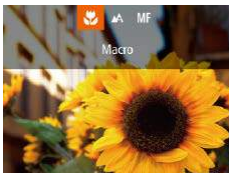

- Press the [◀] button, press the [◀|▶] buttons to choose [M], and then press the [⊕] button.
- Once the setting is complete, [M] is displayed.



- If the flash fires, vignetting may occur.
- Be careful to avoid damaging the lens.
- In the yellow bar display area below the zoom bar, [M] will turn gray and the camera will not focus.



- To prevent camera shake, try mounting the camera on a tripod and shooting with the camera set to [M] (📖44).

## Shooting in Manual Focus Mode

► Still Images ► Movies

When focusing is not possible in AF mode, use manual focus. You can specify the general focal position and then press the shutter button halfway to have the camera determine the optimal focal position near the position you specified. For details on the focusing range, see “Shooting Range” (📖198).

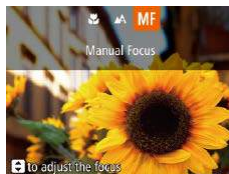

(1)

### 1 Choose [MF].

- Press the [◀] button, press the [◀|▶] buttons to choose [MF], and then press the [⊕] button.
- [MF] and the MF indicator are displayed.

### 2 Specify the general focal position.

- Referring to the on-screen MF indicator bar (1, which shows the distance and focal position) and the magnified display area, press the [▲][▼] buttons to specify the general focal position.
- To adjust the magnification, press the [▶] button.
- To move the magnified display area, press the [⊕] button and then the [▲][▼][◀|▶] buttons.
- Press the [⊕] button to return to the shooting screen.

### 3 Fine-tune the focus.

- Press the shutter button halfway to have the camera fine-tune the focal position (Safety MF).

Before Use

Basic Guide

Advanced Guide

1 Camera Basics

2 Auto Mode / Hybrid Auto Mode

3 Other Shooting Modes

4 P Mode

5 Tv, Av, M, C1, and C2 Mode

6 Playback Mode

7 Wi-Fi Functions

8 Setting Menu

9 Accessories

10 Appendix

Index





- When you focus manually, the AF frame mode (📖82) is [FlexiZone] and AF frame size (📖82) is [Normal], and these settings cannot be changed.
- Focusing is possible when using the digital zoom (📖40) or digital tele-converter (📖81), or when using a TV as a display (📖157), but the magnified display will not appear.



- To focus more accurately, try attaching the camera to a tripod to stabilize it.
- You can enlarge or hide the magnified display area by adjusting MENU (📖30) ► [📷] tab ► [MF-Point Zoom] settings.
- To deactivate automatic focus fine-tuning when the shutter button is pressed halfway, choose MENU (📖30) ► [📷] tab ► [Safety MF] ► [Off].

## Easily Identifying the Focus Area (MF Peaking)

► Still Images ► Movies

Edges of subjects in focus are displayed in color to make manual focusing easier. You can adjust the colors and the sensitivity (level) of edge detection as needed.



### 1 Access the setting screen.

- Press the [MENU] button, choose [MF Peaking Settings] on the [📷] tab, press the [ⓘ] button, choose [Peaking], and then choose [On] (📖30).

### 2 Configure the setting.

- Choose a menu item to configure, and then choose the desired option (📖30).



- Colors displayed for MF peaking are not recorded in your shots.

## Focus Bracketing (Focus-BKT Mode)

► Still Images ► Movies

Three consecutive images are captured each time you shoot, with the first one at the focal distance you set manually and the others at farther and nearer focal positions determined by presets. The distance from your specified focus can be set in three levels.

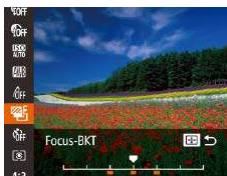

### 1 Choose [Focus-BKT].

- Press the [ⓘ] button, choose [Focus-BKT] in the menu, and then choose [Focus-BKT] (📖29).

### 2 Configure the setting.

- Press the [ⓘ] button, and then adjust the setting by pressing the [◀] [▶] buttons or turning the [🔘] dial.



- Focus bracketing is only available in [📷] mode (📖86).
- Continuous shooting (📖86) is not available in this mode.



- You can also access the setting screen in step 2 by pressing the [MENU] button in step 2 of "Shooting in Manual Focus Mode" (📖79).
- Three shots are taken, regardless of any quantity specified in [📷] (📖44).
- In [Blink Detection] mode (📖55), this function is only available for the final shot.

Before Use
Basic Guide
Advanced Guide
<b>1</b> Camera Basics
<b>2</b> Auto Mode / Hybrid Auto Mode
<b>3</b> Other Shooting Modes
<b>4</b> P Mode
<b>5</b> Tv, Av, M, C1, and C2 Mode
<b>6</b> Playback Mode
<b>7</b> Wi-Fi Functions
<b>8</b> Setting Menu
<b>9</b> Accessories
<b>10</b> Appendix
Index





## Storing the Zoom or Focal Position

► Still Images ► Movies

Zoom positions set with the zoom lever or focal positions set manually are normally reset once you turn the camera off, but they can also be stored on the camera.

### Storing the Zoom Position

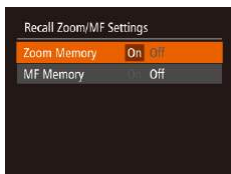

- Press the [MENU] button, choose [Recall Zoom/MF Settings] on the [CAMERA] tab, press the [OK] button, and then choose [On] (p.30).

### Storing the Focal Position

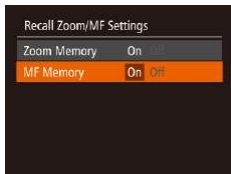

- Follow the steps in “Storing the Zoom Position” (p.81).
- Choose [MF Memory], and then choose [On] (p.30).



- Zoom positions set in [Auto] mode (p.42) cannot be stored.

## Digital Tele-Converter

► Still Images ► Movies

The focal length of the lens can be increased by approximately 1.6x or 2.0x. This can reduce camera shake because the shutter speed is faster than it would be if you zoomed (including using digital zoom) in to the same zoom factor.



- Press the [MENU] button, choose [Digital Zoom] on the [CAMERA] tab, and then choose the desired option (p.30).
- The view is enlarged and the zoom factor is displayed on the screen.



- The digital tele-converter cannot be used with digital zoom (p.40) or AF-point zoom (p.54).



- The shutter speed may be equivalent when you move the zoom lever all the way toward [TELE] for maximum telephoto, and when you zoom in to enlarge the subject to the same size following step 2 in “Zooming In Closer on Subjects (Digital Zoom)” (p.40).

Before Use

Basic Guide

Advanced Guide

1 Camera Basics

2 Auto Mode / Hybrid Auto Mode

3 Other Shooting Modes

4 P Mode

5 Tv, Av, M, C1, and C2 Mode

6 Playback Mode

7 Wi-Fi Functions

8 Setting Menu

9 Accessories

10 Appendix

Index

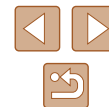

## Changing the AF Frame Mode

▶ Still Images ▶ Movies

Change the AF (auto focus) frame mode to suit the shooting conditions as follows.



- Press the [MENU] button, choose [AF Frame] on the [CAMERA] tab, and then choose the desired option (📖30).

## FlexiZone/Center

▶ Still Images ▶ Movies

One AF frame is displayed. Effective for reliable focusing. With [FlexiZone], you can move and resize the AF frame (📖82).



- A yellow AF frame is displayed with [L] if the camera cannot focus when you press the shutter button halfway.



- To compose shots so that subjects are positioned at the edge or in a corner, first aim the camera to capture the subject in an AF frame, and then hold the shutter button halfway down. As you continue to hold the shutter button halfway, recompose the shot as desired, and then press the shutter button all the way down (Focus Lock).
- The AF frame position is enlarged when you press the shutter button halfway and [AF-Point Zoom] (📖54) is set to [On].

## Moving and Resizing AF Frames (FlexiZone)

▶ Still Images ▶ Movies

When you want to change the position or size of the AF frame, set the AF frame mode to [FlexiZone] (📖82).



### 1 Prepare to move the AF frame.

- Press the [AF-Frame] button. The AF frame turns orange.

### 2 Move and resize the AF frame.

- Turn the [AF-Frame] dial to move the AF frame, or press the [▲][▼][◀][▶] buttons to move it by a smaller amount.
- To return the AF frame to the original position in the center, keep the [AF-Frame] button held down.
- To reduce the AF frame size, press the [MENU] button. Press it again to restore it to the original size.

### 3 Finish the setup process.

- Press the [AF-Frame] button.



- AF frames are displayed at normal size when you use the digital zoom (📖40) or digital tele-converter (📖81).



- You can also link the Spot AE Point frame to the AF frame (📖73).

Before Use

Basic Guide

Advanced Guide

1 Camera Basics

2 Auto Mode / Hybrid Auto Mode

3 Other Shooting Modes

4 P Mode

5 Tv, Av, M, C1, and C2 Mode

6 Playback Mode

7 Wi-Fi Functions

8 Setting Menu

9 Accessories

10 Appendix

Index



## Face Detect

▶ Still Images ▶ Movies

- Detects people's faces, and then sets the focus, exposure (evaluative metering only), and white balance ([WB] only).
- After you aim the camera at the subject, a white frame is displayed around the person's face determined by the camera to be the main subject, and up to two gray frames are displayed around other detected faces.
- When the camera detects movement, frames will follow moving subjects, within a certain range.
- After you press the shutter button halfway, up to nine green frames are displayed around faces in focus.



- If faces are not detected, or when only gray frames are displayed (without a white frame), an AF frame is displayed in the center of the screen when you press the shutter button halfway.
- Examples of faces that cannot be detected:
  - Subjects that are distant or extremely close
  - Subjects that are dark or light
  - Faces in profile, at an angle, or partly hidden
- The camera may misinterpret non-human subjects as faces.
- No AF frames are displayed if the camera cannot focus when you press the shutter button halfway.

## Choosing Subjects to Focus On (Tracking AF)

▶ Still Images ▶ Movies

Shoot after choosing a subject to focus on as follows.

### 1 Choose [Tracking AF].

- Follow the steps in "Changing the AF Frame Mode" ([82]) to choose [Tracking AF].
- [⊕] is displayed in the center of the screen.



### 2 Choose a subject to focus on.

- Aim the camera so that [⊕] is on the desired subject, and then press the [⊕] button.

- When the subject is detected, the camera beeps and [⊕] is displayed. Even if the subject moves, the camera will continue to track the subject within a certain range.
- If no subject is detected, [⊕] is displayed.
- To cancel tracking, press the [⊕] button again.

### 3 Shoot.

- Press the shutter button halfway. [⊕] changes to a blue [⊕], which follows the subject as the camera continues to adjust the focus and exposure (Servo AF) ([84]).
- Press the shutter button all the way down to shoot.
- Even after your shot, [⊕] is still displayed and the camera continues to track the subject.



- [Servo AF] ([84]) is set to [On] and cannot be changed.
- Tracking may not be possible when subjects are too small or move too rapidly, or when subject color or brightness matches that of the background too closely.
- [AF-Point Zoom] on the [📷] tab ([30]) is not available.

Before Use

Basic Guide

Advanced Guide

1 Camera Basics

2 Auto Mode / Hybrid Auto Mode

3 Other Shooting Modes

4 P Mode

5 Tv, Av, M, C1, and C2 Mode

6 Playback Mode

7 Wi-Fi Functions

8 Setting Menu

9 Accessories

10 Appendix

Index





- The camera can detect subjects even if you press the shutter button halfway without pressing the [AF-ON] button. After your shot, [AF] is displayed in the center of the screen.
- If [Face ID] is set to [On], names will not display when registered people are detected, but the names will be recorded in the still images (47). However, a name will display if the subject chosen to focus on is the same as a person detected with Face ID.

## Shooting with Servo AF

▶ Still Images ▶ Movies

This mode helps avoid missing shots of subjects in motion, because the camera continues to focus on the subject and adjust the exposure as long as you press the shutter button halfway.



### 1 Configure the setting.

- Press the [MENU] button, choose [Servo AF] on the [CAMERA] tab, and then choose [On] (30).

### 2 Focus.

- The focus and exposure are maintained where the blue AF frame is displayed while you are pressing the shutter button halfway.



- Focusing may not be possible in some shooting conditions.
- In low-light conditions, Servo AF may not be activated (AF frames may not turn blue) when you press the shutter button halfway. In this case, the focus and exposure are set according to the specified AF frame mode.
- If adequate exposure cannot be obtained, shutter speeds and aperture values are displayed in orange. Release the shutter button, and then press it halfway again.
- AF lock shooting is not available.
- [AF-Point Zoom] on the [CAMERA] tab (30) is not available.
- Not available when using the self-timer (44).

## Changing the Focus Setting

▶ Still Images ▶ Movies

You can change default camera operation of constantly focusing on subjects it is aimed at, even when the shutter button is not pressed. Instead, you can limit camera focusing to the moment you press the shutter button halfway.



- Press the [MENU] button, choose [Continuous AF] on the [CAMERA] tab, and then choose [Off] (30).

On	Helps avoid missing sudden photo opportunities, because the camera constantly focuses on subjects until you press the shutter button halfway.
Off	Conserves battery power, because the camera does not focus constantly.

Before Use

Basic Guide

Advanced Guide

1 Camera Basics

2 Auto Mode / Hybrid Auto Mode

3 Other Shooting Modes

4 P Mode

5 Tv, Av, M, C1, and C2 Mode

6 Playback Mode

7 Wi-Fi Functions

8 Setting Menu

9 Accessories

10 Appendix

Index

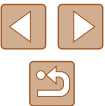

## Choosing a Person to Focus On (Face Select)

► Still Images ► Movies

You can shoot after choosing a specific person's face to focus on.

### 1 Prepare the camera for Face Select.

- Set the AF frame to [Face Detect] (83).



### 2 Enter Face Select mode.

- Aim the camera at the person's face and press the [ ] button.
- After [Face Select : On] is displayed, a face frame [ ] is displayed around the face detected as the main subject.
- Even if the subject moves, the face frame [ ] follows the subject within a certain range.
- If a face is not detected, [ ] is not displayed.

### 3 Choose the face to focus on.

- To switch the face frame [ ] to another detected face, press the [ ] button.
- After you have switched the face frame to all detected faces, [Face Select : Off] is displayed, and the specified AF frame mode screen is displayed again.



### 4 Shoot.

- Press the shutter button halfway. After the camera focuses, [ ] changes to [ ].
- Press the shutter button all the way down to shoot.



- When [Face ID] is set to [On], names of any registered people detected are not displayed when you have selected another, unregistered face to focus on. However, their names will be recorded in the still images (47).

## Shooting with the AF Lock

► Still Images ► Movies

The focus can be locked. After you lock the focus, the focal position will not change even when you release your finger from the shutter button.

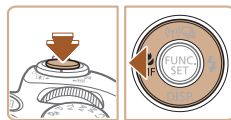

### 1 Lock the focus.

- With the shutter button pressed halfway, press the [ ] button.
- The focus is now locked, and [MF] and the MF indicator are displayed.
- To unlock the focus, after you release the shutter button, press the [ ] button again, and then press the [ ] buttons to choose [A].

### 2 Compose the shot and shoot.

Before Use

Basic Guide

Advanced Guide

1 Camera Basics

2 Auto Mode / Hybrid Auto Mode

3 Other Shooting Modes

4 P Mode

5 Tv, Av, M, C1, and C2 Mode

6 Playback Mode

7 Wi-Fi Functions

8 Setting Menu

9 Accessories

10 Appendix

Index



## Shooting Continuously as the Camera Keeps the Subject in Focus

► Still Images ► Movies

Shoot continuously as the camera keeps the subject in focus. For details on the continuous shooting speed, see “Continuous Shooting Speed” (198).

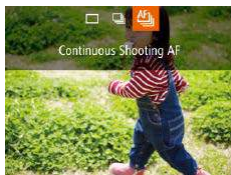

### 1 Configure the setting.

- Press the [▲] button, choose [ ] in the menu, and then choose [AF] (29).
- Once the setting is complete, [AF] is displayed.

### 2 Shoot.

- Hold the shutter button all the way down to shoot continuously.
- The images are managed together as a group (107).



- In [ ] mode (59), manual focus mode (79), or when AF is locked (85), [AF] is changed to [MF].
- Cannot be used with the self-timer (44).
- Shooting may stop momentarily or continuous shooting may slow down depending on shooting conditions, camera settings, and the zoom position.
- As more shots are taken, shooting may slow down.
- Shooting may slow down if the flash fires.

## Flash

### Changing the Flash Mode

► Still Images ► Movies

You can change the flash mode to match the shooting scene. For details on the flash range, see “Flash Range” (198).

#### 1 Lift the flash.

#### 2 Configure the setting.

- Press the [▶] button, press the [◀][▶] buttons to choose a flash mode, and then press the [OK] button.
- The option you configured is now displayed.



- The setting screen cannot be accessed by pressing the [▶] button when the flash is lowered. Lift the flash with your finger in advance.
- If the flash fires, vignetting may occur.

#### Auto

Fires automatically in low-light conditions.

#### On

Fires for each shot.

Before Use

Basic Guide

Advanced Guide

1 Camera Basics

2 Auto Mode / Hybrid Auto Mode

3 Other Shooting Modes

4 P Mode

5 Tv, Av, M, C1, and C2 Mode

6 Playback Mode

7 Wi-Fi Functions

8 Setting Menu

9 Accessories

10 Appendix

Index

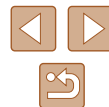

## Slow Synchro

Fires to illuminate the main subject (such as people) while shooting at a slower shutter speed to illuminate backgrounds out of flash range.



- In [A] mode, mount the camera on a tripod or take other measures to keep it still and prevent camera shake. Additionally, you should set [IS Mode] to [Off] when using a tripod or other means to secure the camera (p.90).
- In [A] mode, even after the flash fires, ensure that the main subject does not move until the shutter sound is finished playing.

## Off

For shooting without the flash.



- If a blinking [ ] icon is displayed when you press the shutter button halfway in camera-shake inducing, low-light conditions, mount the camera on a tripod or take other measures to keep it still.

## Adjusting the Flash Exposure Compensation

► Still Images ► Movies

Just as with regular exposure compensation (p.72), you can adjust the flash exposure from -2 to +2 stops, in 1/3-stop increments.



- Raise the flash, press the [ ] button and immediately turn the [ ] dial to choose the compensation level, and then press the [ ] button.
- The correction level you specified is now displayed.



- When there is a risk of overexposure, the camera automatically adjusts the shutter speed or aperture value during the flash shots to reduce washed-out highlights and shoot at optimal exposure. However, you can deactivate automatic adjustment of the shutter speed and aperture value by accessing MENU (p.30) and choosing [ ] tab ► [Flash Control] ► [Safety FE] ► [Off].
- You can also configure the flash exposure compensation by accessing MENU (p.30) and choosing [ ] tab ► [Flash Control] ► [Flash Exp. Comp].
- You can also access the [Built-in Flash Settings] MENU screen (p.30) as follows (except when an optional external flash is mounted).
  - When the flash is up, press the [ ] button and immediately press the [MENU] button.

Before Use

Basic Guide

Advanced Guide

1 Camera Basics

2 Auto Mode / Hybrid Auto Mode

3 Other Shooting Modes

4 P Mode

5 Tv, Av, M, C1, and C2 Mode

6 Playback Mode

7 Wi-Fi Functions

8 Setting Menu

9 Accessories

10 Appendix

Index

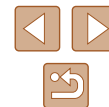

## Shooting with the FE Lock

► Still Images ► Movies

Just as with the AE lock (📖72), you can lock the exposure for the flash shots.

### 1 Lift the flash and set the flash to [📷] (📖86).

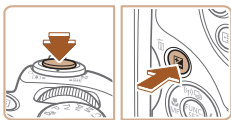

### 2 Lock the flash exposure.

- Aim the camera at the subject to shoot with the exposure locked. With the shutter button pressed halfway, press the [📷] button.
- The flash fires, and when [📷] is displayed, the flash output level is retained.
- To unlock FE, release the shutter button and press the [📷] button again. In this case, [📷] is no longer displayed.



### 3 Compose the shot and shoot.

- After one shot, FE is unlocked and [📷] is no longer displayed.



- FE: Flash Exposure

## Changing the Flash Timing

► Still Images ► Movies

Change the timing of the flash and shutter release as follows.

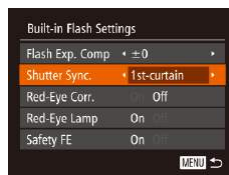

### 1 Access the setting screen.

- Press the [MENU] button, choose [Flash Control] on the [📷] tab, and then press the [📷] button (📖30).

### 2 Configure the setting.

- Choose [Shutter Sync.], and then choose the desired option (📖30).

1st-curtain	The flash fires immediately after the shutter opens.
2nd-curtain	The flash fires immediately before the shutter closes.

Before Use

Basic Guide

Advanced Guide

1 Camera Basics

2 Auto Mode / Hybrid Auto Mode

3 Other Shooting Modes

4 P Mode

5 Tv, Av, M, C1, and C2 Mode

6 Playback Mode

7 Wi-Fi Functions

8 Setting Menu

9 Accessories

10 Appendix

Index

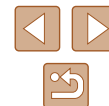



# Shooting RAW Images

► Still Images ► Movies

RAW images are “raw” (unprocessed) data, recorded with essentially no loss of image quality from the camera’s internal image processing. Use Digital Photo Professional (164) to adjust RAW images as desired with minimal loss of image quality.



- Press the button, choose [JPEG] in the menu, and choose the desired option (29).

JPEG	Records JPEG images. JPEG images are processed in the camera for optimal image quality and compressed to reduce file size. However, the compression process is irreversible, and images cannot be restored to their original, unprocessed state. Image processing may also cause some loss of image quality.
RAW	Records RAW images. RAW images are “raw” (unprocessed) data, recorded with essentially no loss of image quality from the camera’s image processing. The data cannot be used in this state for viewing on a computer or printing. You must first use the software (Digital Photo Professional) to convert images to ordinary JPEG or TIFF files. Images can be adjusted with minimal loss of image quality. For details on resolution and the number of shots that will fit on a card, see “Number of Shots per Memory Card” (197).
RAW+JPEG	Records two images, both a RAW image and a JPEG image, for each shot. The JPEG image can be viewed on a computer or printed without using the software.



- When transferring RAW images (or RAW and JPEG images recorded together) to a computer, always use the dedicated software (164).
- Digital zoom (40), date stamps (45), and red-eye reduction (52) are set to [Off] in [RAW] and [JPEG] modes. Additionally, noise reduction level (74), i-Contrast (75) and My Colors (77) cannot be configured.



- The file extension for JPEG images is .JPG, and the extension for RAW images is .CR2.

Before Use
Basic Guide
Advanced Guide
<b>1</b> Camera Basics
<b>2</b> Auto Mode / Hybrid Auto Mode
<b>3</b> Other Shooting Modes
<b>4</b> P Mode
<b>5</b> Tv, Av, M, C1, and C2 Mode
<b>6</b> Playback Mode
<b>7</b> Wi-Fi Functions
<b>8</b> Setting Menu
<b>9</b> Accessories
<b>10</b> Appendix
Index

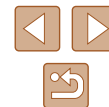

## Other Settings

### Changing the Compression Ratio (Image Quality)

► Still Images ► Movies

Choose from two compression ratios, [S] (Super Fine) and [L] (Fine), as follows. For guidelines on how many shots at each compression ratio can fit on a memory card, see “Number of Shots per Memory Card” (197).



- Press the [MENU] button, choose [L] in the menu, and choose the desired option (29).

### Changing the IS Mode Settings

► Still Images ► Movies

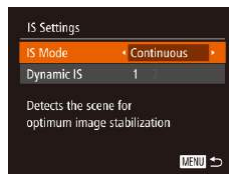

#### 1 Access the setting screen.

- Press the [MENU] button, choose [IS Settings] on the [CAMERA] tab, and then press the [MENU] button (30).

#### 2 Configure the setting.

- Choose [IS Mode], and then choose the desired option (30).

Continuous	Optimal image stabilization for the shooting conditions is automatically applied (Intelligent IS) (39).
Shoot Only*	Image stabilization is active only at the moment of shooting.
Off	Deactivates image stabilization.

\* The setting is changed to [Continuous] for movie recording.



- If image stabilization cannot prevent camera shake, mount the camera on a tripod or take other measures to hold it still. In this case, set [IS Mode] to [Off].

Before Use

Basic Guide

Advanced Guide

1 Camera Basics

2 Auto Mode / Hybrid Auto Mode

3 Other Shooting Modes

4 P Mode

5 Tv, Av, M, C1, and C2 Mode

6 Playback Mode

7 Wi-Fi Functions

8 Setting Menu

9 Accessories

10 Appendix

Index



## Shooting Movies with Subjects at the Same Size Shown before Shooting

▶ Still Images ▶ Movies

Normally, once movie recording begins, the image display area changes and subjects are enlarged to allow for correction of significant camera shake. To shoot subjects at the same size shown before shooting, you can choose not to reduce significant camera shake.

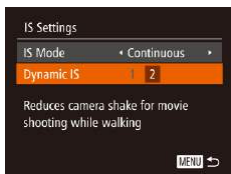

- Follow the steps in “Changing the IS Mode Settings” (📖90) to access the [IS Settings] screen.
- Choose [Dynamic IS], and then choose [2] (📖30).



- You can also set [IS Mode] to [Off], so that subjects are recorded at the same size shown before shooting.

Before Use

Basic Guide

Advanced Guide

**1** Camera Basics

**2** Auto Mode / Hybrid Auto Mode

**3** Other Shooting Modes

**4** P Mode

**5** Tv, Av, M, C1, and C2 Mode

**6** Playback Mode

**7** Wi-Fi Functions

**8** Setting Menu

**9** Accessories

**10** Appendix

Index



# 5

## Tv, Av, M, C1, and C2 Mode

Take smarter, more sophisticated shots, and customize the camera for your shooting style



- Instructions in this chapter apply to the camera as set to the respective mode.

## Specific Shutter Speeds ([Tv] Mode)

► Still Images ► Movies

Set your preferred shutter speed before shooting as follows. The camera automatically adjusts the aperture value to suit your shutter speed. For details on available shutter speeds, see “Shutter Speed” (199).



### 1 Enter [Tv] mode.

- Set the mode dial to [Tv].

### 2 Set the shutter speed.

- Turn the [Shutter Speed] dial to set the shutter speed.



- In conditions requiring slower shutter speeds, there may be a delay before you can shoot again, as the camera processes images to reduce noise.
- When shooting at low shutter speeds on a tripod, you should set [IS Mode] to [Off] (90).
- With shutter speeds of 1.3 seconds or slower, ISO speed is  $\frac{160}{100}$  and cannot be changed.
- Orange display of aperture values when you press the shutter button halfway indicates that the settings deviate from standard exposure. Adjust the shutter speed until the aperture value is displayed in white, or use safety shift (93).



- [Tv]: Time value

Before Use

Basic Guide

Advanced Guide

1 Camera Basics

2 Auto Mode / Hybrid Auto Mode

3 Other Shooting Modes

4 P Mode

5 Tv, Av, M, C1, and C2 Mode

6 Playback Mode

7 Wi-Fi Functions

8 Setting Menu

9 Accessories

10 Appendix

Index



## Specific Aperture Values ([Av] Mode)

► Still Images ► Movies

Set your preferred aperture value before shooting as follows. The camera automatically adjusts the shutter speed to suit your aperture value. For details on available aperture values, see “Aperture” (📖199).



### 1 Enter [Av] mode.

- Set the mode dial to [Av].

### 2 Set the aperture value.

- Turn the [🔆] dial to set the aperture value.



- Orange display of shutter speeds when you press the shutter button halfway indicates that the settings deviate from standard exposure. Adjust the aperture value until the shutter speed is displayed in white, or use safety shift (see below).



- [Av]: Aperture value (size of the opening made by the iris in the lens)
- To avoid exposure problems in [Tv] and [Av] modes, you can have the camera automatically adjust the shutter speed or aperture value, even when standard exposure cannot otherwise be obtained. Press the [MENU] button and set [Safety Shift] on the [📷] tab to [On] (📖30). However, safety shift is disabled when the flash fires.

## Specific Shutter Speeds and Aperture Values ([M] Mode)

► Still Images ► Movies

Follow these steps before shooting to set your preferred shutter speed and aperture value to obtain the desired exposure. For details on available shutter speeds and aperture values, see “Shutter Speed” (📖199) and “Aperture” (📖199).

### 1 Enter [M] mode.

- Set the mode dial to [M].

### 2 Configure the setting.

- Press the [🔆] button, choose adjustment of shutter speed (1) or aperture value (2), and turn the [🔆] dial to specify a value.
- An exposure level mark (4) based on your specified value is shown on the exposure level indicator for comparison to the standard exposure level (3).
- [◀] or [▶] is displayed when the difference from standard exposure exceeds 2 stops.

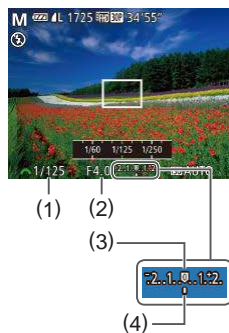

Before Use

Basic Guide

Advanced Guide

1 Camera Basics

2 Auto Mode / Hybrid Auto Mode

3 Other Shooting Modes

4 P Mode

5 Tv, Av, M, C1, and C2 Mode

6 Playback Mode

7 Wi-Fi Functions

8 Setting Menu

9 Accessories

10 Appendix

Index





- After you set the shutter speed or aperture value, the exposure level may change if you adjust the zoom or recompose the shot.
- Screen brightness may change depending on your specified shutter speed or aperture value. However, screen brightness remains the same when the flash is up and the mode is set to [⚡].
- With shutter speeds of 1.3 seconds or slower, ISO speed is  $\frac{150}{100}$  and cannot be changed.



- [M]: Manual
- Calculation of standard exposure is based on the specified metering method (📖72).

## Adjusting the Flash Output

▶ Still Images ▶ Movies

Choose from the three flash levels in [M] mode.

### 1 Enter [M] mode.

- Set the mode dial to [M].

### 2 Specify the flash mode.

- Press the [MENU] button, choose [Flash Control] on the [📷] tab, and then press the [⊕] button.
- In [Flash Mode], choose [Manual] (📖30).

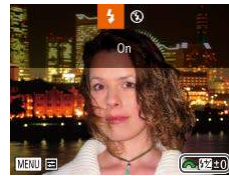

### 3 Configure the setting.

- Raise the flash, press the [▶] button and immediately turn the [🔆] dial to choose the flash level, and then press the [⊕] button.
- Once the setting is complete, the flash output level is displayed.  
[⚡]: Minimum, [⚡.]: Medium, [⚡.]: Maximum



- You can also set the flash level by accessing MENU (📖30) and choosing [📷] tab ▶ [Flash Control] ▶ [Flash Output].
- You can also access the [Built-in Flash Settings] MENU screen (📖30) as follows (except when an optional external flash is mounted).
  - When the flash is up, press the [▶] button and immediately press the [MENU] button.

Before Use

Basic Guide

Advanced Guide

1 Camera Basics

2 Auto Mode / Hybrid Auto Mode

3 Other Shooting Modes

4 P Mode

5 Tv, Av, M, C1, and C2 Mode

6 Playback Mode

7 Wi-Fi Functions

8 Setting Menu

9 Accessories

10 Appendix

Index



## Recording Movies at Specific Shutter Speeds and Aperture Values

► Still Images ► Movies

Set your preferred shutter speed, aperture value, and ISO speed. For details on available shutter speeds, aperture values, and ISO speeds, see “Specific Shutter Speeds” (92), “Specific Aperture Values” (93), and “Changing the ISO Speed” (73).



### 1 Enter [M] mode.

- Set the mode dial to [M].
- Press the [MENU] button, choose [M] in the menu, and then choose [M] (29).



### 2 Configure the setting.

- Press the [Z] button to choose shutter speed, aperture value, or ISO speed, and then turn the [DIAL] dial to choose a value.



- Some shutter speeds may cause flickering on the screen when recording under fluorescent or LED lighting, which may be recorded.



- With [1/500], the exposure level mark moves when the shutter button is pressed halfway, showing the difference from the standard exposure level.
- With settings other than [1/500], an exposure level mark based on your specified shutter speed and aperture value is shown for comparison to the standard exposure level.

## Changing Settings during Recording

Settings can also be adjusted while you are recording a movie, by following step 2 in “Recording Movies at Specific Shutter Speeds and Aperture Values” (95). However, any changes in brightness are recorded in the movie.



- To make the sound of the [DIAL] dial quieter, press the [▲][▼] buttons and adjust the setting.
- You can switch between adjusting the shutter speed, aperture value, ISO speed, and focal position during MF (79) movie recording each time you press the [Z] button. Press the [▲][▼] buttons to configure these settings.

Before Use

Basic Guide

Advanced Guide

1 Camera Basics

2 Auto Mode / Hybrid Auto Mode

3 Other Shooting Modes

4 P Mode

5 Tv, Av, M, C1, and C2 Mode

6 Playback Mode

7 Wi-Fi Functions

8 Setting Menu

9 Accessories

10 Appendix

Index



# Customization for Shooting Styles

## Customizing Display Information

► Still Images ► Movies

Set the number of custom displays (📖28) and what information is displayed in each display when the [▼] button is pressed in shooting screen.



### 1 Access the setting screen.

- Press the [MENU] button, choose [Custom Display] on the [📷] tab, and then press the [ⓘ] button (📖30).

### 2 Configure the setting.

- Press the [▲][▼][◀][▶] buttons to choose an item, and then press the [ⓘ] button. Items you choose for display are labeled with [✓].
- Selected items (labeled with a [✓]) will be included in display.

Shooting Info	Displays shooting information (📖180).
Grid Lines	Displays a reference grid.
Electronic Level	Displays the electronic level (📖54).
Histogram	Displays a histogram (📖103) in [P], [Tv], [Av], [M], [A], [S], and [B] modes.



- Settings will not be saved if you press the shutter button halfway and return to the shooting screen from the custom display settings screen.
- Grayed-out items can also be specified, but they may not be displayed in some shooting modes.



- Grid lines are not recorded in your shots.

## Assigning Functions to Buttons

► Still Images ► Movies

You can quickly and easily activate functions that you assign to the [F/S] button, movie button (🎬 button), or [L] button.



### 1 Access the setting screen.

- Press the [MENU] button, choose [Set Shortcut button], [Set 🎬 button] or [Set [L] button] on the [📷] tab, and then press the [ⓘ] button (📖30).

### 2 Configure the setting.

- Press the [▲][▼][◀][▶] buttons to choose a function to assign, and then press the [ⓘ] button.

### 3 Use the assigned function as needed.

- To activate an assigned function, press the button you assigned it to.

Before Use

Basic Guide

Advanced Guide

1 Camera Basics

2 Auto Mode / Hybrid Auto Mode

3 Other Shooting Modes

4 P Mode

5 Tv, Av, M, C1, and C2 Mode

6 Playback Mode

7 Wi-Fi Functions

8 Setting Menu

9 Accessories

10 Appendix

Index







- To restore default settings, choose [S] in [Set Shortcut button], [P] in [Set button], and [L] in [Set button].
- Icons labeled with [N] indicate that the function is not available in the current shooting mode or under current function conditions.
- With [W] or [M], each press of the assigned button records white balance data (177), and the white balance setting changes to [W] or [M].
- With [AF-L], each press of the assigned button adjusts and locks the focus. [AF-L] is then displayed.
- With [DISP], pressing the assigned button deactivates screen display. To restore the display, do any of the following.
  - Press any button other than the power button
  - Hold the camera in another orientation
  - Raise or lower the flash
- You can still record movies in [P], [S], [M], or [L] mode even if you assign a function to the movie button.

## Customizing the FUNC. Menu (FUNC. Menu Layout)

The display of FUNC. menu items can be customized. Functions not shown on this menu will be available on the [CAM] tab of the menu screen.

### Choosing Items to Include in the Menu

► Still Images ► Movies



#### 1 Access the setting screen.

- Press the [MENU] button, choose [FUNC. Menu Layout] on the [CAM] tab, and then press the [OK] button (130).

#### 2 Choose icons to include in the menu.

- Press the [▲][▼][◀][▶] buttons and press the [OK] button to choose icons to include in the FUNC. menu. Selected icons are marked with a [✓].
- Selected items (labeled with a [✓]) will be included in display.
- Items without a [✓] will be available on the [CAM] tab of the menu screen.

#### 3 Configure the setting.

- Press the [MENU] button, press the [◀][▶] buttons to choose [OK], and then press the [OK] button.

Before Use

Basic Guide

Advanced Guide

1 Camera Basics

2 Auto Mode / Hybrid Auto Mode

3 Other Shooting Modes

4 P Mode

5 Tv, Av, M, C1, and C2 Mode

6 Playback Mode

7 Wi-Fi Functions

8 Setting Menu

9 Accessories

10 Appendix

Index





- The screen in step 2 can also be accessed by holding down the [MENU] button when the FUNC. menu is displayed.
- Items that you remove from the FUNC. menu, add to My Menu ([M]99), and then add to the FUNC. menu again will be removed from My Menu.

## Rearranging Menu Items



### 1 Access the setting screen.

- On the screen in step 2 of “Choosing Items to Include in the Menu” ([M]97), press the [F.F.] button.
- Press the [MENU] or [▶] button to choose an icon to move. Press the [▲][▼] buttons to choose the new position, and then press the [MENU] or [◀] button.

### 2 Configure the setting.

- Press the [MENU] button, press the [◀][▶] buttons to choose [OK], and then press the [MENU] button.

## Saving Shooting Settings

▶ Still Images ▶ Movies

Save commonly used shooting modes and your configured function settings for reuse. To access saved settings later, simply turn the mode dial to [C1] or [C2]. Even settings that are usually cleared when you switch shooting modes or turn the camera off (such as self-timer settings) can be retained this way.

### Settings that can be saved

- Shooting mode ([P], [Tv], [Av], or [M])
- Items set in [P], [Tv], [Av], or [M] modes ([M]72 – [M]93)
- Shooting menu settings
- Zoom positions
- Manual focus positions ([M]79)
- My Menu settings ([M]99)

### 1 Enter a shooting mode with settings you want to save, and change the settings as desired.

### 2 Configure the setting.

- Press the [MENU] button, choose [Save Settings] on the [CAMERA] tab, and then press the [MENU] button.

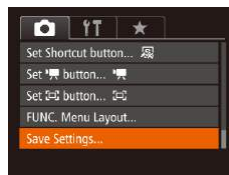

### 3 Save the settings.

- Press the [◀][▶] buttons to choose the destination, and then press the [MENU] button.

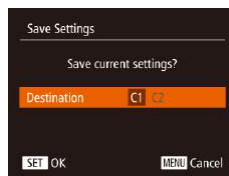

Before Use
Basic Guide
Advanced Guide
1 Camera Basics
2 Auto Mode / Hybrid Auto Mode
3 Other Shooting Modes
4 P Mode
5 Tv, Av, M, C1, and C2 Mode
6 Playback Mode
7 Wi-Fi Functions
8 Setting Menu
9 Accessories
10 Appendix
Index

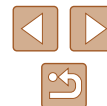



- To edit saved settings (except their shooting mode), choose [C1] or [C2], change the settings, and then repeat steps 2 – 3. These setting details are not applied in other shooting modes.



- To clear information you have saved to [C1] or [C2] and restore default values, turn the mode dial to [C1] or [C2] and choose [Reset All] (152).

## Saving Commonly Used Shooting Menu Items (My Menu)

► Still Images ► Movies

You can save up to five commonly used shooting menu items on the [★] tab. By customizing the [★] tab, you can access to these items quickly from a single screen.

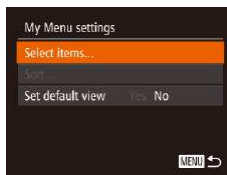
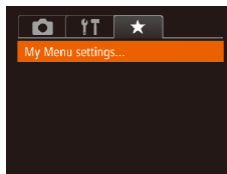

### 1 Access the setting screen.

- Press the [MENU] button, choose [My Menu settings] on the [★] tab, and then press the [OK] button (30).

### 2 Configure the setting.

- Press the [▲][▼] buttons to choose [Select items], and then press the [OK] button.
- Choose up to five menu items to save by pressing the [▲][▼] buttons, and then press the [OK] button.
- [✓] is displayed.
- To cancel saving, press the [OK] button. [✓] is no longer displayed.
- Press the [MENU] button.

Before Use

Basic Guide

Advanced Guide

1 Camera Basics

2 Auto Mode / Hybrid Auto Mode

3 Other Shooting Modes

4 P Mode

5 Tv, Av, M, C1, and C2 Mode

6 Playback Mode

7 Wi-Fi Functions

8 Setting Menu

9 Accessories

10 Appendix

Index



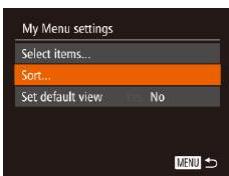

### 3 Rearrange menu items, as needed.

- Press the [**▲**][**▼**] buttons to choose [Sort], and then press the [**OK**] button.
- Choose a menu item to move by pressing the [**▲**][**▼**] buttons, and then press the [**OK**] button.
- Press the [**▲**][**▼**] buttons to change the order, and then press the [**OK**] button.
- Press the [**MENU**] button.



- Grayed-out items in step 2 can also be specified, but they may not be available in some shooting modes.



- To make My Menu immediately accessible by pressing the [**MENU**] button in Shooting mode, choose [Set default view] and press the [**◀**][**▶**] buttons to choose [Yes].

Before Use

Basic Guide

Advanced Guide

**1** Camera Basics

**2** Auto Mode /  
Hybrid Auto Mode

**3** Other Shooting Modes

**4** P Mode

**5** Tv, Av, M, C1, and C2 Mode

**6** Playback Mode

**7** Wi-Fi Functions

**8** Setting Menu

**9** Accessories

**10** Appendix

Index



# 6

## Playback Mode

Have fun reviewing your shots, and browse or edit them in many ways

- To prepare the camera for these operations, press the [▶] button to enter Playback mode.



- It may not be possible to play back or edit images that were renamed or already edited on a computer, or images from other cameras.

## Viewing

▶ Still Images ▶ Movies

After shooting images or movies, you can view them on the screen as follows.



### 1 Enter Playback mode.

- Press the [▶] button.
- Your last shot is displayed.

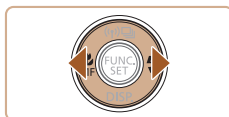

### 2 Browse through your images.

- To view the previous image, press the [◀] button. To view the next image, press the [▶] button.

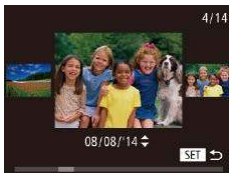

- To access this screen (Scroll Display mode), press and hold the [◀][▶] buttons for at least one second. In this mode, press the [◀][▶] buttons to browse through images.
- To return to single-image display, press the [FUNC/SET] button.
- To browse images grouped by shooting date, press the [▲][▼] buttons in Scroll Display mode.

Before Use

Basic Guide

Advanced Guide

1 Camera Basics

2 Auto Mode / Hybrid Auto Mode

3 Other Shooting Modes

4 P Mode

5 Tv, Av, M, C1, and C2 Mode

6 Playback Mode

7 Wi-Fi Functions

8 Setting Menu

9 Accessories

10 Appendix

Index

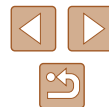



- Movies are identified by a [SET] icon. To play movies, go to step 3.

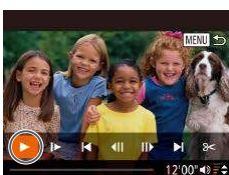

### 3 Play movies.

- To start playback, press the [ ] button to access the movie control panel, press the [ ] buttons to choose [ ], and then press the [ ] button again.

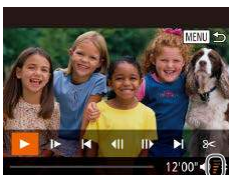

### 4 Adjust the volume.

- Press the [ ][ ] buttons to adjust the volume.
- To adjust the volume when the volume indicator (1) is no longer displayed, press the [ ][ ] buttons.

### 5 Pause playback.

- To pause or resume playback, press the [ ] button.
- After the movie is finished, [SET] is displayed.



- To switch to Shooting mode from Playback mode, press the shutter button halfway.
- To deactivate Scroll Display, choose MENU [ ] ► [ ] tab ► [Scroll Display] ► [Off].
- To have the most recent shot displayed when you enter Playback mode, choose MENU [ ] ► [ ] tab ► [Resume] ► [Last shot].
- To change the transition shown between images, access MENU [ ] and choose your desired effect on the [ ] tab ► [Transition Effect].

## Switching Display Modes

► Still Images ► Movies

Press the [ ] button to view other information on the screen, or to hide the information. For details on the information displayed, see “Playback (Detailed Information Display)” (181).

Open the screen to activate it when the camera is on. This will deactivate the viewfinder. Similarly, close the screen (facing the camera body) to deactivate it and activate the viewfinder (20).

	No Information Display
	Simple Information Display
	Detailed Information Display
	RGB Histogram, GPS Information Display



- Switching display modes is not possible while the camera is connected via Wi-Fi to devices other than printers.

Before Use

Basic Guide

Advanced Guide

1 Camera Basics

2 Auto Mode / Hybrid Auto Mode

3 Other Shooting Modes

4 P Mode

5 Tv, Av, M, C1, and C2 Mode

6 Playback Mode

7 Wi-Fi Functions

8 Setting Menu

9 Accessories

10 Appendix

Index



## Overexposure Warning (for Image Highlights)

▶ Still Images ▶ Movies

Washed-out highlights in the image flash on the screen in detailed information display (📖102).

## Histogram

▶ Still Images ▶ Movies

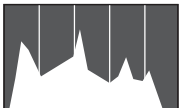

- The graph in detailed information display (📖102) is a histogram showing the distribution of brightness in the image. The horizontal axis represents the degree of brightness, and the vertical axis, how much of the image is at each level of brightness. Viewing the histogram is a way to check exposure.
- The histogram can also be accessed while shooting (📖96, 📖180).

## RGB Histogram, GPS Information Display

▶ Still Images ▶ Movies

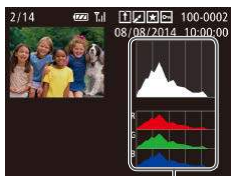

(1)

- The RGB histogram (1) shows the distribution of shades of red, green, and blue in an image. The horizontal axis represents R, G, or B brightness, and the vertical axis, how much of the image is at that level of brightness. Viewing this histogram enables you to check image color characteristics.

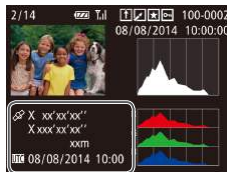

- Using a smartphone connected to the camera via Wi-Fi, you can geotag images on the camera, adding information such as latitude, longitude, and elevation (📖141). You can review this information in the GPS information display.
- Latitude, longitude, elevation, and UTC (shooting date and time) are listed from top to bottom.



- [---] is shown instead of numerical values for items not available on your smartphone or items not recorded correctly.



- UTC: Coordinated Universal Time, essentially the same as Greenwich Mean Time
- GPS information display is not available for images that lack this information.

Before Use
Basic Guide
Advanced Guide
<b>1</b> Camera Basics
<b>2</b> Auto Mode / Hybrid Auto Mode
<b>3</b> Other Shooting Modes
<b>4</b> P Mode
<b>5</b> Tv, Av, M, C1, and C2 Mode
<b>6</b> Playback Mode
<b>7</b> Wi-Fi Functions
<b>8</b> Setting Menu
<b>9</b> Accessories
<b>10</b> Appendix
Index

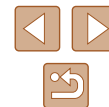

## Viewing Short Movies Created When Shooting Still Images (Digest Movies)

► Still Images ► Movies

View digest movies recorded automatically in [A] mode (135) on a day of still image shooting as follows.



### 1 Choose an image.

- Still images shot in [A] mode are labeled with an [SET] icon.
- Choose a still image labeled with [SET] and press the [OK] button.

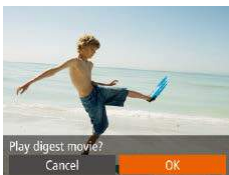

### 2 Play the movie.

- Press the [Left][Right] buttons to choose [OK] (29).
- The movie recorded automatically on the day of still image shooting is played back, from the beginning.



- After a moment, [SET] will no longer be displayed when you are using the camera with information display deactivated (102).

## Viewing by Date

Digest movies can be viewed by date.

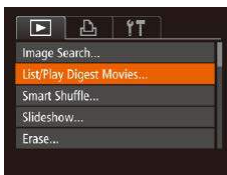

### 1 Choose a movie.

- Press the [MENU] button, choose [List/Play Digest Movies] on the [Play] tab, and then choose a date (30).

### 2 Play the movie.

- Press the [OK] button to start playback.

## Checking People Detected in Face ID

► Still Images ► Movies

If you switch the camera to simple information display mode (102), the names of up to five detected people registered in Face ID (47) will be displayed.



- Press the [Down] button several times until simple information display is activated, and then press the [Left][Right] buttons to choose an image.
- Names will be displayed on detected people.



- If you prefer not to have names displayed on images shot using Face ID, choose MENU (30) ► [Play] tab ► [Face ID Info] ► [Name Display] ► [Off].

Before Use

Basic Guide

Advanced Guide

1 Camera Basics

2 Auto Mode / Hybrid Auto Mode

3 Other Shooting Modes

4 P Mode

5 Tv, Av, M, C1, and C2 Mode

6 Playback Mode

7 Wi-Fi Functions

8 Setting Menu

9 Accessories

10 Appendix

Index





## Browsing and Filtering Images

### Navigating through Images in an Index

► Still Images ► Movies

By displaying multiple images in an index, you can quickly find the images you are looking for.



#### 1 Display images in an index.

- Move the zoom lever toward to display images in an index. Moving the lever again will increase the number of images shown.
- To display fewer images, move the zoom lever toward [Q]. Fewer images are shown each time you move the lever.



#### 2 Choose an image.

- Press the [][][][] buttons to choose an image.
- An orange frame is displayed around the selected image.
- Press the [] button to view the selected image in single-image display.



- To deactivate the 3D display effect (shown if you hold down the [][] buttons), choose MENU (📖30) ► [] tab ► [Index Effect] ► [Off].

## Finding Images Matching Specified Conditions

► Still Images ► Movies

Find desired images quickly on a memory card full of images by filtering image display according to your specified conditions. You can also protect (📖110) or delete (📖112) these images all at once.

Name	Displays images of a registered person (📖47).
People	Displays images with detected faces.
Date	Displays the images shot on a specific date.
Favorites	Displays images tagged as favorites (📖115).
Still image/ Movie	Displays only still images or movies. Displays still images, movies, or movies shot in [] mode (📖35).

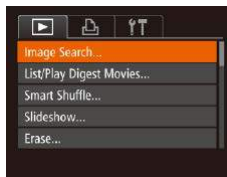

#### 1 Choose [Image Search].

- Press the [MENU] button, and then choose [Image Search] on the [] tab (📖30).



#### 2 Choose the first condition for image display or navigation.

- When [] or [] is selected, you can view only images matching this condition by pressing the [][] buttons. To perform an action for all of these images together, press the [] button and go to step 3.

Before Use

Basic Guide

Advanced Guide

1 Camera Basics

2 Auto Mode /  
Hybrid Auto Mode

3 Other Shooting Modes

4 P Mode

5 Tv, Av, M, C1, and C2 Mode

6 Playback Mode

7 Wi-Fi Functions

8 Setting Menu

9 Accessories

10 Appendix

Index



### 3 Choose the second condition and check the images found.

- To switch to filtered image display, press the button and go to step 4.
- When you have selected as the first condition, press the button, and press the buttons on the next screen to choose a person.

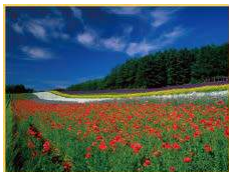

### 4 View the filtered images.

- Images matching your conditions are displayed in yellow frames. To view only these images, press the buttons.
- To cancel filtered display, press the button.



- When the camera has found no corresponding images for some conditions, those conditions will not be available. Note that is not available unless people are registered 47).



- To show or hide information, press the button in step 3.
- Options for viewing the images found (in step 3) include "Navigating through Images in an Index" 105), "Magnifying Images" 108), and "Viewing Slideshows" 109). You can also apply image operations to all images found, by choosing [Protect All Images in Search] in "Protecting Images" 110) or [Select All Images in Search] in "Erasing Multiple Images at Once" 113), "Adding Images to the Print List (DPOF)" 170), or "Adding Images to a Photobook" 172).
- If you edit images and save them as new images 116 – 120), a message is displayed, and the images that were found are no longer shown.

## Using the Front Dial to Jump between Images

Jump to Favorites	Displays images tagged as favorites 115).
Jump Shot Date	Jumps to the first image in each group of images that were shot on the same date.
Jump 10 Images	Jumps by 10 images at a time.
Jump 100 Images	Jumps by 100 images at a time.



### 1 Choose a condition.

- Choose a condition (or jump method) in single-image display by turning the dial and then pressing the buttons.

### 2 View images matching your specified condition, or jump by the specified amount.

- Turn the dial to view only images matching the condition or jump by the specified number of images forward or back.



- Turning the dial when browsing images in index display will jump to the previous or next image according to the jump method chosen in single-image display. However, if you have chosen or , the jump method will be switched to .

Before Use

Basic Guide

Advanced Guide

1 Camera Basics

2 Auto Mode / Hybrid Auto Mode

3 Other Shooting Modes

4 P Mode

5 Tv, Av, M, C1, and C2 Mode

6 Playback Mode

7 Wi-Fi Functions

8 Setting Menu

9 Accessories

10 Appendix

Index



## Viewing Individual Images in a Group

► Still Images ► Movies

Images shot consecutively (📖46, 📖58, 📖86) or in [📺] or [📷] mode (📖57, 📖58) are displayed as a group but can also be viewed individually.



### 1 Choose a grouped image.

- Press the [◀][▶] buttons to choose an image labeled with [SET], and then press the [⊞] button.



### 2 View images in the group individually.

- Pressing the [◀][▶] buttons will display only images in the group.
- Pressing the [▲] button will display [Display all images]. Press [⊞] to cancel group playback.



- During group playback (step 2), you can browse through images quickly “Navigating through Images in an Index” (📖105) and magnify them “Magnifying Images” (📖108). By choosing [All Images in Group] for “Protecting Images” (📖110), “Erasing Multiple Images at Once” (📖113), “Adding Images to the Print List (DPOF)” (📖170), or “Adding Images to a Photobook” (📖172), all images in the group can be manipulated at once.
- To ungroup images so that they are displayed only as single still images, choose MENU (📖30) ► [📺] tab ► [Group Images] ► [Off]. However, grouped images cannot be ungrouped during individual playback.
- In [📺] mode, the simultaneous display after step 2 in “Enjoying a Variety of Images from Each Shot (Creative Shot)” (📖57) is only shown immediately after you shoot.

## Editing Face ID Information

If you notice that a name is incorrect during playback, you can change it or erase it.

However, you cannot add names for people who are not detected by Face ID (names are not displayed), and for people whose names have been erased.

## Changing Names

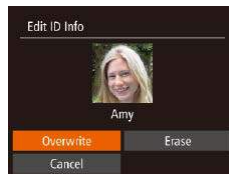
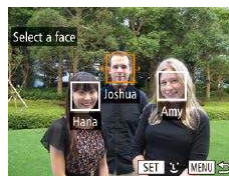

### 1 Access the setting screen.

- Press the [MENU] button and choose [Face ID Info] on the [📺] tab (📖30).
- Press the [▲][▼] buttons to choose [Edit ID Info], and then press the [⊞] button.

### 2 Choose an image.

- Following the procedure in “Checking People Detected in Face ID” (📖104), choose an image and press the [⊞] button.
- An orange frame is displayed around the selected face. When multiple names are displayed in an image, press the [◀][▶] buttons to choose the name to change, and press the [⊞] button.

### 3 Choose the editing option.

- Press the [▲][▼][◀][▶] buttons to choose [Overwrite], and then press the [⊞] button.

Before Use

Basic Guide

Advanced Guide

1 Camera Basics

2 Auto Mode / Hybrid Auto Mode

3 Other Shooting Modes

4 P Mode

5 Tv, Av, M, C1, and C2 Mode

6 Playback Mode

7 Wi-Fi Functions

8 Setting Menu

9 Accessories

10 Appendix

Index



#### 4 Choose the name of the person to overwrite with.

- Follow step 2 in “Overwriting and Adding Face Information” (p.50) to choose the name of the person you want to overwrite with.

## Erasing Names

- Following step 3 in “Changing Names” (p.107), choose [Erase] and press the button.
- After [Erase?] is displayed, press the buttons to choose [OK], and then press the button.

## Image Viewing Options

### Magnifying Images

► Still Images ► Movies



(1)

#### 1 Magnify an image.

- Moving the zoom lever toward [Q] will zoom in and magnify the image, and is displayed. You can magnify images up to about 10x by continuing to hold the zoom lever.
- The approximate position of the displayed area (1) is shown for reference.
- To zoom out, move the zoom lever toward . You can return to single-image display by continuing to hold it.

#### 2 Move the display position and switch images as needed.

- To move the display position, press the buttons.
- While is displayed, you can switch to by pressing the button. To switch to other images while zoomed, press the buttons. Press the button again to restore the original setting.



- You can return to single-image display from magnified display by pressing the **MENU** button.

Before Use

Basic Guide

Advanced Guide

1 Camera Basics

2 Auto Mode / Hybrid Auto Mode

3 Other Shooting Modes

4 P Mode

5 Tv, Av, M, C1, and C2 Mode

6 Playback Mode

7 Wi-Fi Functions

8 Setting Menu

9 Accessories

10 Appendix

Index



## Viewing Slideshows

► Still Images ► Movies

Automatically play back images from a memory card as follows.

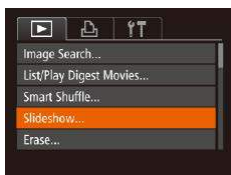

### 1 Access the setting screen.

- Press the [MENU] button, and then choose [Slideshow] on the [▶] tab (📖30).

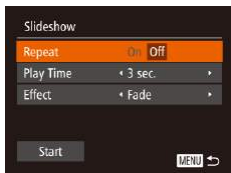

### 2 Configure the setting.

- Choose a menu item to configure, and then choose the desired option (📖30).

### 3 Start automatic playback.

- Press the [▲][▼] buttons to choose [Start], and then press the [⏸] button.
- The slideshow will start after [Loading image] is displayed for a few seconds.
- Press the [MENU] button to stop the slideshow.



- The camera's power-saving functions (📖26) are deactivated during slideshows.



- To pause or resume slideshows, press the [⏸] button.
- You can switch to other images during playback by pressing the [◀][▶] buttons. For fast-forward or fast-rewind, hold the [◀][▶] buttons down.

## Changing Slideshow Settings

You can set up slideshows to repeat, and you can change the transitions between images and the display duration of each image.

### 1 Access the setting screen.

- Press the [MENU] button, and then choose [Slideshow] on the [▶] tab (📖30).

### 2 Configure the settings.

- Choose a menu item to configure, and then choose the desired option (📖30).
- To start the slideshow with your settings, choose [Start] and press the [⏸] button.
- To return to the menu screen, press the [MENU] button.



Before Use

Basic Guide

Advanced Guide

1 Camera Basics

2 Auto Mode / Hybrid Auto Mode

3 Other Shooting Modes

4 P Mode

5 Tv, Av, M, C1, and C2 Mode

6 Playback Mode

7 Wi-Fi Functions

8 Setting Menu

9 Accessories

10 Appendix

Index



## Auto Playback of Related Images (Smart Shuffle)

► Still Images ► Movies

Based on the current image, the camera offers four images that you may wish to view. After you choose to view one of those images, the camera offers four more images. This is an enjoyable way to play back images in an unexpected order. Try this feature after you have taken many shots, in many kinds of scenes.

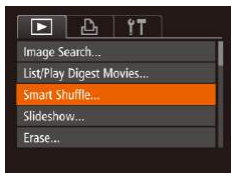

### 1 Choose Smart Shuffle.

- Press the [MENU] button, choose [Smart Shuffle] on the [▶] tab, and then press the [OK] button (📖30).
- Four candidate images are displayed.

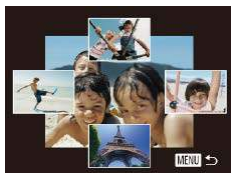

### 2 Choose an image.

- Press the [▲][▼][◀][▶] buttons to choose the image you want to view next.
- Your chosen image is displayed in the center, surrounded by the next four candidate images.
- For full-screen display of the center image, press the [OK] button. To restore the original display, press the [MENU] button again.
- Press the [MENU] button to restore single-image display.



- Smart Shuffle is not available in the following cases:
  - There are less than 50 shots taken with this camera
  - An unsupported image is currently displayed
  - Images are shown in filtered display (📖105)
  - During group playback (📖107)

## Protecting Images

► Still Images ► Movies

Protect important images to prevent accidental erasure by the camera (📖112).

## Choosing a Selection Method

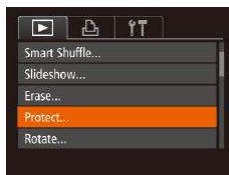

### 1 Access the setting screen.

- Press the [MENU] button and choose [Protect] on the [▶] tab (📖30).

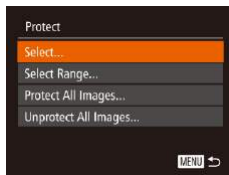

### 2 Choose a selection method.

- Choose a menu item and an option as desired (📖30).
- To return to the menu screen, press the [MENU] button.



- Protected images on a memory card will be erased if you format the card (📖148, 📖149).



- Protected images cannot be erased using the camera's erasure function. To erase them this way, first cancel protection.

Before Use

Basic Guide

Advanced Guide

1 Camera Basics

2 Auto Mode / Hybrid Auto Mode

3 Other Shooting Modes

4 P Mode

5 Tv, Av, M, C1, and C2 Mode

6 Playback Mode

7 Wi-Fi Functions

8 Setting Menu

9 Accessories

10 Appendix

Index









## Choosing Images Individually

### 1 Choose [Select].





- Following step 2 in “Choosing a Selection Method” (p. 110), choose [Select] and press the  button.



### 2 Choose an image.

- Press the   buttons to choose an image, and then press the  button.  is displayed.
- To cancel selection, press the  button again.  is no longer displayed.
- Repeat this process to specify other images.

### 3 Protect the image.

- Press the  button. A confirmation message is displayed.
- Press the   buttons to choose [OK], and then press the  button.

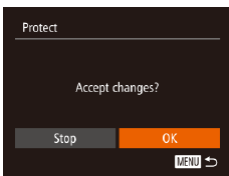

- Images will not be protected if you switch to Shooting mode or turn the camera off before finishing the setup process in step 3.

## Selecting a Range

### 1 Choose [Select Range].

- Following step 2 in “Choosing a Selection Method” (p. 110), choose [Select Range] and press the  button.

### 2 Choose a starting image.

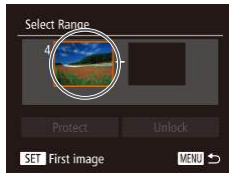

- Press the  button.



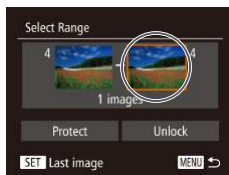

- Press the   buttons to choose an image, and then press the  button.



### 3 Choose an ending image.

- Press the  button to choose [Last image], and then press the  button.



- Press the   buttons to choose an image, and then press the  button.
- Images before the first image cannot be selected as the last image.

Before Use

Basic Guide

Advanced Guide

1 Camera Basics

2 Auto Mode / Hybrid Auto Mode

3 Other Shooting Modes

4 P Mode

5 Tv, Av, M, C1, and C2 Mode

6 Playback Mode

7 Wi-Fi Functions

8 Setting Menu

9 Accessories

10 Appendix

Index

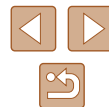



#### 4 Protect the images.

- Press the [▼] button to choose [Protect], and then press the [Ⓜ] button.



- To cancel protection for groups of images, choose [Unlock] in step 4.

## Protecting All Images at Once

### 1 Choose [Protect All Images].

- Following step 2 in “Choosing a Selection Method” (110), choose [Protect All Images] and press the [Ⓜ] button.

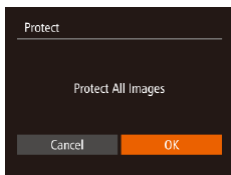

### 2 Protect the images.

- Press the [◀][▶] buttons to choose [OK], and then press the [Ⓜ] button.

## Clearing All Protection at Once

You can clear protection from all images at once. To clear protection, choose [Unprotect All Images] in step 1 of “Protecting All Images at Once”, and then complete step 2.

## Erasing Images

► Still Images ► Movies

You can choose and erase unneeded images one by one. Be careful when erasing images, because they cannot be recovered. However, protected images (110) cannot be erased.

### 1 Choose an image to erase.

- Press the [◀][▶] buttons to choose an image.

### 2 Erase the image.

- Press the [Ⓜ] button.
- After [Erase?] is displayed, press the [◀][▶] buttons to choose [Erase], and then press the [Ⓜ] button.
- The current image is now erased.
- To cancel erasure, press the [◀][▶] buttons to choose [Cancel], and then press the [Ⓜ] button.



- Pressing the [Ⓜ] button while [RAW] images are displayed will give you the option of choosing [Erase RAW], [Erase JPEG], or [Erase RAW+JPEG] for deletion.

Before Use

Basic Guide

Advanced Guide

1 Camera Basics

2 Auto Mode / Hybrid Auto Mode

3 Other Shooting Modes

4 P Mode

5 Tv, Av, M, C1, and C2 Mode

6 Playback Mode

7 Wi-Fi Functions

8 Setting Menu

9 Accessories

10 Appendix

Index





## Erasing Multiple Images at Once

You can choose multiple images to erase at once. Be careful when erasing images, because they cannot be recovered. However, protected images (🔒110) cannot be erased.

### Choosing a Selection Method

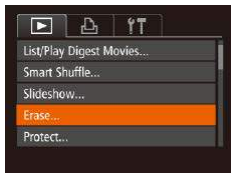

#### 1 Access the setting screen.

- Press the [MENU] button, and then choose [Erase] on the [▶] tab (🔑30).

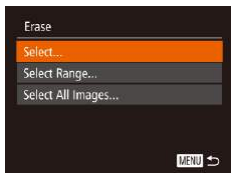

#### 2 Choose a selection method.

- Choose a menu item and an option as desired (🔑30).
- Press the [▲][▼] buttons to choose a selection method, and then press the [⊕] button.
- To return to the menu screen, press the [MENU] button.

### Choosing Images Individually

#### 1 Choose [Select].

- Following step 2 in “Choosing a Selection Method” (🔑113), choose [Select] and press the [⊕] button.



#### 2 Choose an image.

- Once you choose an image following step 2 in “Choosing Images Individually” (🔑111), [✓] is displayed.
- To cancel selection, press the [⊕] button again. [✓] is no longer displayed.
- Repeat this process to specify other images.

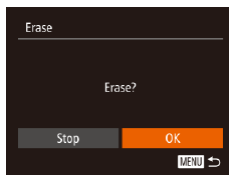

#### 3 Erase the image.

- Press the [MENU] button. A confirmation message is displayed.
- Press the [◀][▶] buttons to choose [OK], and then press the [⊕] button.

### Selecting a Range

#### 1 Choose [Select Range].

- Following step 2 in “Choosing a Selection Method” (🔑113), choose [Select Range] and press the [⊕] button.

#### 2 Choose images.

- Follow steps 2 – 3 in “Selecting a Range” (🔑111) to specify images.



#### 3 Erase the images.

- Press the [▼] button to choose [Erase], and then press the [⊕] button.

Before Use
Basic Guide
Advanced Guide
1 Camera Basics
2 Auto Mode / Hybrid Auto Mode
3 Other Shooting Modes
4 P Mode
5 Tv, Av, M, C1, and C2 Mode
6 Playback Mode
7 Wi-Fi Functions
8 Setting Menu
9 Accessories
10 Appendix

Index



## Specifying All Images at Once

### 1 Choose [Select All Images].

- Following step 2 in "Choosing a Selection Method" (📖113), choose [Select All Images] and press the [⊕] button.

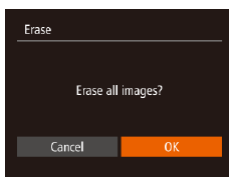

### 2 Erase the images.

- Press the [◀][▶] buttons to choose [OK], and then press the [⊕] button.

## Rotating Images

▶ Still Images ▶ Movies

Change the orientation of images and save them as follows.

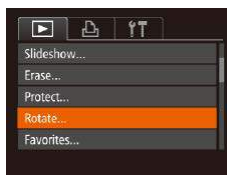

### 1 Choose [Rotate].

- Press the [MENU] button and choose [Rotate] on the [▶] tab (📖30).



### 2 Rotate the image.

- Press the [◀][▶] buttons to choose an image.
- The image is rotated 90° each time you press the [⊕] button.
- To return to the menu screen, press the [MENU] button.



- Rotation is not possible when [Auto Rotate] is set to [Off] (📖115).

Before Use

Basic Guide

Advanced Guide

1 Camera Basics

2 Auto Mode / Hybrid Auto Mode

3 Other Shooting Modes

4 P Mode

5 Tv, Av, M, C1, and C2 Mode

6 Playback Mode

7 Wi-Fi Functions

8 Setting Menu

9 Accessories

10 Appendix

Index



## Deactivating Auto Rotation

Follow these steps to deactivate automatic image rotation, which rotates images based on the current camera orientation.

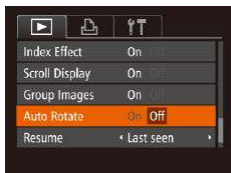

- Press the [MENU] button, choose [Auto Rotate] on the [▶] tab, and then choose [Off] (📖30).



- Images cannot be rotated (📖114) when you set [Auto Rotate] to [Off]. Additionally, images already rotated will be displayed in the original orientation.
- In Smart Shuffle (📖110) mode, even if [Auto Rotate] is set to [Off], images shot vertically will be displayed vertically, and rotated images will be displayed in the rotated orientation.

## Tagging Images as Favorites

▶ Still Images ▶ Movies

You can organize images by tagging them as favorites. By choosing a category in filtered playback, you can restrict the following operations to all of those images.

- “Viewing” (📖101), “Viewing Slideshows” (📖109), “Protecting Images” (📖110), “Erasing Images” (📖112), “Adding Images to the Print List (DPOF)” (📖170), “Adding Images to a Photobook” (📖172)

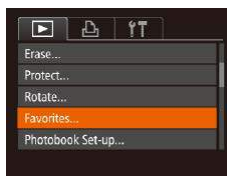

### 1 Choose [Favorites].

- Press the [MENU] button and choose [Favorites] on the [▶] tab (📖30).



### 2 Choose an image.

- Press the [◀][▶] buttons to choose an image, and then press the [Ⓢ] button. [★] is displayed.
- To untag the image, press the [Ⓢ] button again. [★] is no longer displayed.
- Repeat this process to choose additional images.

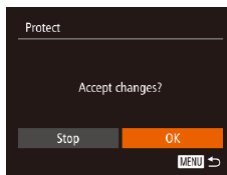

### 3 Finish the setup process.

- Press the [MENU] button. A confirmation message is displayed.
- Press the [◀][▶] buttons to choose [OK], and then press the [Ⓢ] button.

Before Use

Basic Guide

Advanced Guide

1 Camera Basics

2 Auto Mode / Hybrid Auto Mode

3 Other Shooting Modes

4 P Mode

5 Tv, Av, M, C1, and C2 Mode

6 Playback Mode

7 Wi-Fi Functions

8 Setting Menu

9 Accessories

10 Appendix

Index

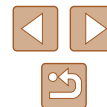



- Images will not be tagged as favorites if you switch to Shooting mode or turn the camera off before finishing the setup process in step 3.



- Favorite images will have a three-star rating (★★★☆☆) when transferred to computers running Windows 8 or Windows 7. (Does not apply to movies or RAW images.)

## Editing Still Images



- Image editing (📖116 – 📖119) is only available when the memory card has sufficient free space.

## Resizing Images

► Still Images ► Movies

Save a copy of images at a lower resolution.



### 1 Choose [Resize].

- Press the [MENU] button and choose [Resize] on the [▶] tab (📖30).

### 2 Choose an image.

- Press the [◀][▶] buttons to choose an image, and then press the [OK] button.

### 3 Choose an image size.

- Press the [◀][▶] buttons to choose the size, and then press the [OK] button.
- [Save new image?] is displayed.

### 4 Save the new image.

- Press the [◀][▶] buttons to choose [OK], and then press the [OK] button.
- The image is now saved as a new file.

Before Use

Basic Guide

Advanced Guide

1 Camera Basics

2 Auto Mode / Hybrid Auto Mode

3 Other Shooting Modes

4 P Mode

5 Tv, Av, M, C1, and C2 Mode

6 Playback Mode

7 Wi-Fi Functions

8 Setting Menu

9 Accessories

10 Appendix

Index

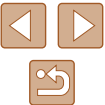

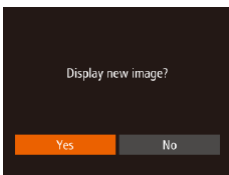

## 5 Review the new image.

- Press the [MENU] button. [Display new image?] is displayed.
- Press the [◀][▶] buttons to choose [Yes], and then press the [Ⓜ] button.
- The saved image is now displayed.



- Editing is not possible for images shot at a resolution of [S] (📖52).
- RAW images cannot be edited.



- Images cannot be resized to a higher resolution.

## Cropping

▶ Still Images ▶ Movies

You can specify a portion of an image to save as a separate image file.

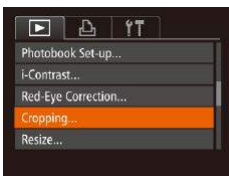

## 1 Choose [Cropping].

- Press the [MENU] button, and then choose [Cropping] on the [📷] tab (📖30).

## 2 Choose an image.

- Press the [◀][▶] buttons to choose an image, and then press the [Ⓜ] button.



## 3 Adjust the cropping area.

- A frame is displayed around the portion of the image to be cropped (1).
- The original image is shown in the upper left, and a preview of the image as cropped (2) is shown in the lower right. You can also see the resolution after cropping (3).
- To resize the frame, move the zoom lever.
- To move the frame, press the [▲][▼][◀][▶] buttons.
- To change the frame orientation, press the [Ⓜ] button.
- Faces detected in the image are enclosed in gray frames in the upper-left image. To crop the image based on this frame, turn the [🔍] dial to switch to the other frame.
- Press the [MENU] button.

## 4 Save as a new image and review.

- Follow steps 4 – 5 in “Resizing Images” (📖116).



- Editing is not possible for images shot at a resolution of [S] (📖52) or resized to [S] (📖116).
- RAW images cannot be edited.



- Images supported for cropping will have the same aspect ratio after cropping.
- Cropped images will have a lower resolution than uncropped images.
- If you crop still images shot using Face ID (📖47), only the names of the people left in the cropped image will remain.

Before Use
Basic Guide
Advanced Guide
1 Camera Basics
2 Auto Mode / Hybrid Auto Mode
3 Other Shooting Modes
4 P Mode
5 Tv, Av, M, C1, and C2 Mode
6 Playback Mode
7 Wi-Fi Functions
8 Setting Menu
9 Accessories
10 Appendix

Index



## Changing Image Color Tones (My Colors)

► Still Images ► Movies

You can adjust image colors and then save the edited image as a separate file. For details on each option, see “Changing Image Color Tones (My Colors)” (📖77).

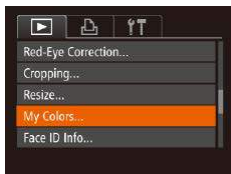

### 1 Choose [My Colors].

- Press the [MENU] button, and then choose [My Colors] on the [▶] tab (📖30).

### 2 Choose an image.

- Press the [◀][▶] buttons to choose an image, and then press the [📷] button.

### 3 Choose an option.

- Press the [◀][▶] buttons to choose an option, and then press the [📷] button.

### 4 Save as a new image and review.

- Follow steps 4 – 5 in “Resizing Images” (📖116).



- Image quality of pictures you repeatedly edit this way will be a little lower each time, and you may not be able to obtain the desired color.
- Colors of RAW images cannot be edited.



- The color of images edited using this function may vary slightly from the color of images shot using My Colors (📖77).

## Correcting Image Brightness (i-Contrast)

► Still Images ► Movies

Excessively dark image areas (such as faces or backgrounds) can be detected and automatically adjusted to the optimal brightness. Insufficient overall image contrast is also automatically corrected, to make subjects stand out better. Choose from four correction levels, and then save the image as a separate file.

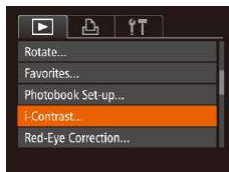

### 1 Choose [i-Contrast].

- Press the [MENU] button, and then choose [i-Contrast] on the [▶] tab (📖30).

### 2 Choose an image.

- Press the [◀][▶] buttons to choose an image, and then press the [📷] button.

### 3 Choose an option.

- Press the [◀][▶] buttons to choose an option, and then press the [📷] button.

### 4 Save as a new image and review.

- Follow steps 4 – 5 in “Resizing Images” (📖116).



- For some images, correction may be inaccurate or may cause images to appear grainy.
- Images may look grainy after repeated editing using this function.
- RAW images cannot be edited this way.



- If [Auto] does not produce the expected results, try correcting images using [Low], [Medium], or [High].

Before Use

Basic Guide

Advanced Guide

1 Camera Basics

2 Auto Mode / Hybrid Auto Mode

3 Other Shooting Modes

4 P Mode

5 Tv, Av, M, C1, and C2 Mode

6 Playback Mode

7 Wi-Fi Functions

8 Setting Menu

9 Accessories

10 Appendix

Index



## Correcting Red-Eye

► Still Images ► Movies

Automatically corrects images affected by red-eye. You can save the corrected image as a separate file.

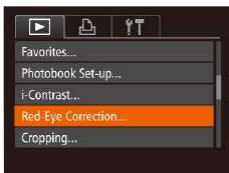

### 1 Choose [Red-Eye Correction].

- Press the [MENU] button, and then choose [Red-Eye Correction] on the [REDA] tab (📖30).

### 2 Choose an image.

- Press the [◀][▶] buttons to choose an image.

### 3 Correct the image.

- Press the [⊕] button.
- Red-eye detected by the camera is now corrected, and frames are displayed around corrected image areas.
- Enlarge or reduce images as needed. Follow the steps in “Magnifying Images” (📖108).

### 4 Save as a new image and review.

- Press the [▲][▼][◀][▶] buttons to choose [New File], and then press the [⊕] button.
- The image is now saved as a new file.
- Follow step 5 in “Resizing Images” (📖116).



- Some images may not be corrected accurately.
- To overwrite the original image with the corrected image, choose [Overwrite] in step 4. In this case, the original image will be erased.
- Protected images cannot be overwritten.
- RAW images cannot be edited this way.
- Red-eye correction can be applied to JPEG images shot in [RAW+JPEG], but the original image cannot be overwritten.

Before Use

Basic Guide

Advanced Guide

1 Camera Basics

2 Auto Mode / Hybrid Auto Mode

3 Other Shooting Modes

4 P Mode

5 Tv, Av, M, C1, and C2 Mode

6 Playback Mode

7 Wi-Fi Functions

8 Setting Menu

9 Accessories

10 Appendix

Index



# Editing Movies

► Still Images ► Movies

You can cut movies to remove unneeded portions at the beginning or end (excluding digest movies (135)).

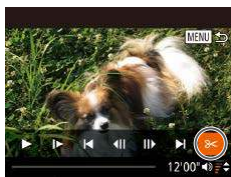

## 1 Choose [OK].

- Following steps 1 – 5 in “Viewing” (101), choose [OK] and press the [OK] button.
- The movie editing panel and editing bar are now displayed.



## 2 Specify portions to cut.

- (1) is the movie editing panel, and (2) is the editing bar.
- Press the [▲][▼] buttons to choose [L] or [R].
- To view the portions you can cut (identified by [L] on the screen), press the [◀][▶] buttons to move [L]. Cut the beginning of the movie (from [L]) by choosing [L], and cut the end of the movie by choosing [R].
- If you move [L] to a position other than a [L] mark, in [L] the portion before the nearest [L] mark on the left will be cut, while in [R] the portion after the nearest [L] mark on the right will be cut.

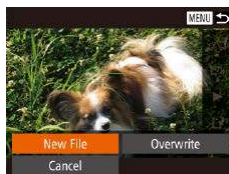

## 3 Review the edited movie.

- Press the [▲][▼] buttons to choose [▶], and then press the [OK] button. The edited movie is now played.
- To edit the movie again, repeat step 2.
- To cancel editing, press the [MENU] button, press the [◀][▶] buttons to choose [OK], and then press the [OK] button.

## 4 Save the edited movie.

- Press the [▲][▼] buttons to choose [L], and then press the [OK] button.
- Press the [▲][▼][◀][▶] buttons to choose [New File], and then press the [OK] button.
- Choose [Save w/o Comp.], and then press the [OK] button.
- The movie is now saved as a new file.



- To overwrite the original movie with the cut one, choose [Overwrite] in step 4. In this case, the original movie will be erased.
- If the memory card lacks sufficient space, only [Overwrite] will be available.
- Movies may not be saved if the battery pack runs out while saving is in progress.
- When editing movies, you should use a fully charged battery pack or an AC adapter kit (sold separately, 155).

Before Use

Basic Guide

Advanced Guide

1 Camera Basics

2 Auto Mode / Hybrid Auto Mode

3 Other Shooting Modes

4 P Mode

5 Tv, Av, M, C1, and C2 Mode

6 Playback Mode

7 Wi-Fi Functions

8 Setting Menu

9 Accessories

10 Appendix

Index





## Reducing File Sizes

Movie file sizes can be reduced by compressing movies as follows.



- On the screen in step 2 of “Editing Movies”, choose [L]. Choose [New File], and then press the [MENU] button.
- Choose [Compress & Sav.], and then press the [MENU] button.



- Compressed movies are saved in [HD 30P] format.
- [VGA 30P] movies cannot be compressed.
- Edited movies cannot be saved in compressed format when you choose [Overwrite].

## Editing Digest Movies

▶ Still Images ▶ Movies

Individual chapters (clips) (135) recorded in [L] mode can be erased, as needed. Be careful when erasing clips, because they cannot be recovered.



### 1 Select the clip to erase.

- Follow steps 1 – 2 in “Viewing Short Movies Created When Shooting Still Images (Digest Movies)” (104) to play a movie created in [L] mode, and then press the [MENU] button to access the movie control panel.
- Press the [L][R] buttons to choose [L] or [R], and then press the [MENU] button.

### 2 Choose [L].

- Press the [L][R] buttons to choose [L], and then press the [MENU] button.
- The selected clip is played back repeatedly.

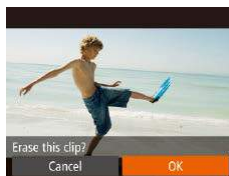

### 3 Confirm erasure.

- Press the [L][R] buttons to choose [OK], and then press the [MENU] button.
- The clip is erased, and the short movie is overwritten.



- [L] is not displayed if you select a clip when the camera is connected to a printer.

Before Use

Basic Guide

Advanced Guide

1 Camera Basics

2 Auto Mode / Hybrid Auto Mode

3 Other Shooting Modes

4 P Mode

5 Tv, Av, M, C1, and C2 Mode

6 Playback Mode

7 Wi-Fi Functions

8 Setting Menu

9 Accessories

10 Appendix

Index

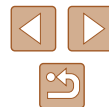

# 7

## Wi-Fi Functions

Send images wirelessly from the camera to a variety of compatible devices, and use the camera with Web services

### Available Wi-Fi Features

You can send and receive images and control the camera remotely by connecting it to these devices and services via Wi-Fi.

- **Smartphones and Tablets**  
Send images to smartphones and tablet computers that have Wi-Fi functions. You can also shoot remotely and geotag your shots from a smartphone or tablet.  
For convenience in this manual, smartphones, tablets, and other compatible devices are collectively referred to as “smartphones”.
- **Computer**  
Use software to save camera images to a computer connected via Wi-Fi.
- **Web Services**  
Add your account information to the camera for CANON iMAGE GATEWAY online photography service or other Web services to send camera images to the services. Unsent images on the camera can also be sent automatically to a computer or Web service via CANON iMAGE GATEWAY.
- **Printers**  
Send images wirelessly to a PictBridge-compatible printer (supporting DPS over IP) to print them.
- **Another Camera**  
Send images wirelessly between Wi-Fi compatible Canon cameras.

Before Use

Basic Guide

Advanced Guide

**1** Camera Basics

**2** Auto Mode /  
Hybrid Auto Mode

**3** Other Shooting Modes

**4** P Mode

**5** Tv, Av, M, C1, and C2 Mode

**6** Playback Mode

**7** Wi-Fi Functions

**8** Setting Menu

**9** Accessories





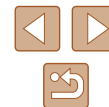

**10** Appendix

Index





## Sending Images to a Smartphone

Connect the camera to a smartphone and send images in either of these ways.



- Connect to a device assigned to the  button ( 123)  
Simply press the  button to connect the devices. This simplifies importing images from a smartphone ( 123). Note that only one smartphone can be assigned to the  button.
- Connect via the Wi-Fi menu ( 125)  
You can connect the camera to a smartphone as you would connect it to a computer or other device. Multiple smartphones can be added.

Before connecting to the camera, you must install the free dedicated CameraWindow app on the smartphone. For details on this application (supported smartphones and included functions), refer to the Canon website.



- No matter how you connect the devices, you can also use the smartphone to geotag ( 141) camera images and shoot remotely ( 142).

## Sending to a Smartphone Assigned to the Button

Once you have connected to a smartphone initially by pressing the  button, you can simply press the  button after that to connect again for viewing and saving camera images on connected devices.



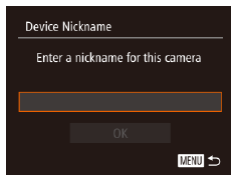
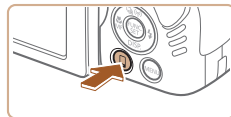
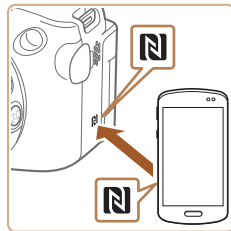



These steps show how to use the camera as an access point, but you can also use an existing access point ( 126).



### 1 Install CameraWindow.

- For an NFC-compatible Android smartphone (OS version 4.0 or later), activating NFC and touching the smartphone against the camera's N-Mark ( N) will start Google Play on the smartphone. Once the CameraWindow download page is displayed, download and install the app.
- For other Android smartphones, find CameraWindow in Google Play and download and install the app.
- For an iPhone, iPad, or iPod touch, find CameraWindow in the App Store and download and install the app.

### 2 Press the button.

- Press the  button.
- When the [Device Nickname] screen is displayed, press the  button. Use the keyboard displayed to enter a nickname ( 31). On the [Device Nickname] screen, press the [][] buttons to choose [OK], and then press the  button.

Before Use

Basic Guide

Advanced Guide

**1** Camera Basics

**2** Auto Mode / Hybrid Auto Mode

**3** Other Shooting Modes

**4** P Mode

**5** Tv, Av, M, C1, and C2 Mode

**6** Playback Mode

**7** Wi-Fi Functions

**8** Setting Menu

**9** Accessories

**10** Appendix

Index



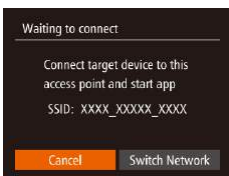

### 3 Choose [📱].

- Press the [◀][▶] buttons to choose [📱], and then press the [📶] button.

- The camera's SSID is displayed.

### 4 Connect the smartphone to the network.

- In the smartphone's Wi-Fi setting menu, choose the SSID (network name) displayed on the camera to establish a connection.

### 5 Start CameraWindow.

- For an NFC-compatible Android smartphone (OS version 4.0 or later), activating NFC and touching the smartphone against the camera's N-Mark (N) will start CameraWindow on the smartphone.
- For other smartphones, start CameraWindow on the smartphone.
- After the camera recognizes the smartphone, a device selection screen is displayed.

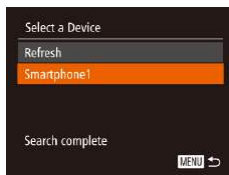

### 6 Choose a smartphone to connect to.

- Press the [▲][▼] buttons to choose the smartphone, and then press the [📶] button.
- After a connection is established with the smartphone, the smartphone name is displayed on the camera. (This screen will close in about one minute.)

### 7 Import images.

- Use the smartphone to import images from the camera to the smartphone.
- Use the smartphone to end the connection; the camera will automatically turn off.



- When using NFC, keep the following points in mind.
  - Avoid strong impact between the camera and smartphone. This may damage the devices.
  - Depending on the smartphone, the devices may not recognize each other immediately. In this case, try holding the devices together in slightly different positions.
  - Do not place other objects between the camera and smartphone. Also, note that camera or smartphone covers or similar accessories may block communication.

Before Use

Basic Guide

Advanced Guide

1 Camera Basics

2 Auto Mode / Hybrid Auto Mode

3 Other Shooting Modes

4 P Mode

5 Tv, Av, M, C1, and C2 Mode

6 Playback Mode

7 Wi-Fi Functions

8 Setting Menu

9 Accessories

10 Appendix

Index





- Connections require that a memory card be in the camera.
- A message is displayed if the nickname you enter begins with a symbol or space. Press the [OK] button and enter a different nickname.
- For better security, you can require password input on the screen in step 3 by accessing MENU (130) and choosing [Up] tab ▶ [Wi-Fi Settings] ▶ [Password] ▶ [On]. In this case, in the password field on the smartphone in step 4, enter the password displayed on the camera.
- One smartphone can be registered to the [Add] button. To assign a different one, first clear the current one in MENU (130) ▶ [Up] tab ▶ [Mobile Device Connect Button].
- Not all NFC-compatible smartphones have an N-Mark (N). For details, refer to the smartphone user manual.

## Adding a Smartphone Using the Wi-Fi Menu

These steps show how to use the camera as an access point, but you can also use an existing access point (126).



### 1 Install CameraWindow.

- Follow step 1 in “Sending to a Smartphone Assigned to the Button” (123) to install CameraWindow on a smartphone.

### 2 Access the Wi-Fi menu.

- Press the [Play] button to turn the camera on.
- Press the [Up] button.
- If a screen requesting the device nickname is displayed, enter the nickname (123).

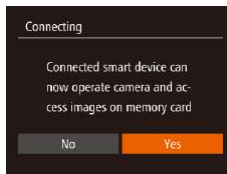
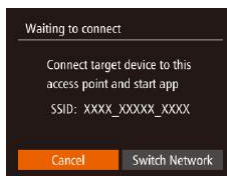
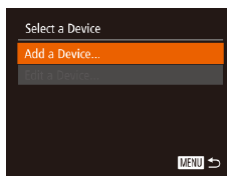
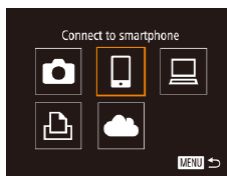
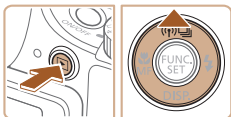

### 3 Choose [Add].

- Press the [Left][Right] buttons to choose [Add], and then press the [OK] button.

### 4 Choose [Add a Device].

- Press the [Up][Down] buttons to choose [Add a Device], and then press the [OK] button.

- The camera's SSID is displayed.
- Choose a smartphone to connect to, as described in steps 4 – 6 of “Sending to a Smartphone Assigned to the Button” (123).

### 5 Adjust the privacy setting.

- Press the [Left][Right] buttons to choose [Yes], and then press the [OK] button.
- You can now use the smartphone to browse, import, or geotag images on the camera or shoot remotely.

Before Use

Basic Guide

Advanced Guide

1 Camera Basics

2 Auto Mode / Hybrid Auto Mode

3 Other Shooting Modes

4 P Mode

5 Tv, Av, M, C1, and C2 Mode

6 Playback Mode

7 Wi-Fi Functions

8 Setting Menu

9 Accessories

10 Appendix

Index

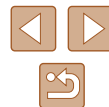



## 6 Send images.

- Press the [▲][▼][◀][▶] buttons to choose [Select and send], and then press the [MENU] button.
- Press the [▲][▼][◀][▶] buttons to choose an image to send, press the [OK] button to mark it as selected ([✓]), and then press the [MENU] button.
- Press the [▲][▼][◀][▶] buttons to choose [Send], and then press the [MENU] button.
- Image transfer will begin. The screen darkens during image transfer.
- [Transfer completed] is displayed after the image is sent, and the image transfer screen is displayed again.
- To cancel the connection, press the [MENU] button, press the [◀][▶] buttons on the confirmation screen to choose [OK], and then press the [MENU] button. You can also use the smartphone to end the connection.
- To add multiple smartphones, repeat the above procedures starting from step 1.



- All images in the camera can be viewed from the connected smartphone when you choose [Yes] in step 5. To keep camera images private, so that they cannot be viewed from the smartphone, choose [No] in step 5.
- Once you have registered a smartphone, you can change privacy settings for it on the camera (143).



- Connections require that a memory card be in the camera.
- Once you have connected to devices via the Wi-Fi menu, recent destinations will be listed first when you access the Wi-Fi menu. You can easily connect again by pressing the [▲][▼] buttons to choose the device and then pressing the [MENU] button. To add a new device, display the device selection screen by pressing the [◀][▶] buttons, and then configure the setting.
- If you prefer not to display recent target devices, choose MENU (30) ▶ [Wi-Fi Settings] ▶ [Target History] ▶ [Off].
- You can also send multiple images at once and change the image size before sending (138).
- You can send the current image by choosing [Send this image] on the screen in step 6.

## Using Another Access Point

When connecting the camera to a smartphone with the [Wi-Fi] button or through the Wi-Fi menu, you can also use an existing access point.

### 1 Prepare for the connection.

- Access the [Waiting to connect] screen. Either follow steps 1 – 3 in “Sending to a Smartphone Assigned to the Button” (123) or steps 1 – 4 in “Adding a Smartphone Using the Wi-Fi Menu” (125).

### 2 Connect the smartphone to the access point.



Before Use
Basic Guide
Advanced Guide
<b>1</b> Camera Basics
<b>2</b> Auto Mode / Hybrid Auto Mode
<b>3</b> Other Shooting Modes
<b>4</b> P Mode
<b>5</b> Tv, Av, M, C1, and C2 Mode
<b>6</b> Playback Mode
<b>7</b> Wi-Fi Functions
<b>8</b> Setting Menu
<b>9</b> Accessories
<b>10</b> Appendix
Index

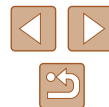

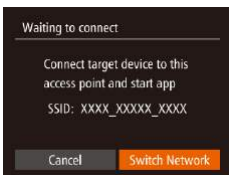

### 3 Choose [Switch Network].

- Press the [◀][▶] buttons to choose [Switch Network], and then press the [OK] button.
- A list of detected access points will be displayed.

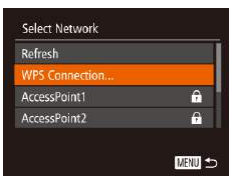

### 4 Connect to the access point and choose the smartphone.

- For WPS-compatible access points, connect to the access point and choose the smartphone as described in steps 5 – 8 in “Using WPS-Compatible Access Points” (📖130).
- For non-WPS access points, follow steps 2 – 4 in “Connecting to Listed Access Points” (📖132) to connect to the access point and choose the smartphone.

### 5 Configure the privacy settings and send images.

- Follow steps 5 – 6 in “Adding a Smartphone Using the Wi-Fi Menu” (📖125) to configure the privacy settings and send images.

## Previous Access Points

To reconnect to a previous access point automatically, follow step 3 in “Sending to a Smartphone Assigned to the Button” (📖123) or step 4 in “Adding a Smartphone Using the Wi-Fi Menu” (📖125).

- To use the camera as an access point, choose [Switch Network] on the screen displayed when you establish a connection, and then choose [Camera Access Point Mode].
- To reconnect to a previous access point, follow the procedure from step 5 in “Using Another Access Point” (📖126).
- To switch access points, choose [Switch Network] on the screen displayed when you establish a connection, and then follow the procedure in “Using Another Access Point” (📖126) from step 4.

## Saving Images to a Computer

### Preparing to Register a Computer

#### Checking Your Computer Environment

The camera can connect via Wi-Fi to computers running the following operating systems. For detailed system requirements and compatibility information, including support in new operating systems, visit the Canon website.

- Windows 8/8.1
- Windows 7 SP1
- Mac OS X 10.9
- Mac OS X 10.8.2 or later



- Windows 7 Starter and Home Basic editions are not supported.
- Windows 7 N (European version) and KN (South Korean version) require a separate download and installation of Windows Media Feature Pack.

For details, check the following website.

<http://go.microsoft.com/fwlink/?LinkId=159730>

#### Installing the Software

Windows 7 and Mac OS X 10.8 are used here for the sake of illustration.

#### What you will need:

- Computer
- USB cable (camera end: Mini-B)\*

\* A USB cable is not included. Although you can install the software without using a cable, some features will not be added.

Before Use

Basic Guide

Advanced Guide

1 Camera Basics

2 Auto Mode / Hybrid Auto Mode

3 Other Shooting Modes

4 P Mode

5 Tv, Av, M, C1, and C2 Mode

6 Playback Mode

7 Wi-Fi Functions

8 Setting Menu

9 Accessories

10 Appendix

Index



## 1 Download the software.

- With a computer connected to the Internet, access <http://www.canon.com/icpd/>.
- Access the site for your country or region.
- Download the software.



## 2 Begin the installation.

- Click [Easy Installation] and follow the on-screen instructions to complete the installation process.



## 3 When a message is displayed prompting you to connect the camera, choose whether to connect or not.

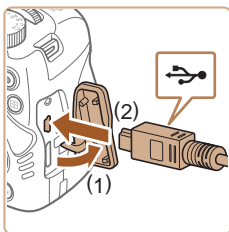

### When Connecting the Camera to the Computer

- With the camera turned off, open the cover (1). With the smaller plug of the USB cable in the orientation shown, insert the plug fully into the camera terminal (2).
- Insert the larger plug of the USB cable in the computer's USB port. For details about USB connections on the computer, refer to the computer user manual.
- Turn the camera on, and follow the on-screen instructions to complete the installation process.

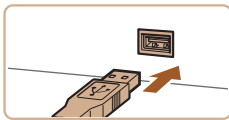

### Without Connecting the Camera

- Select [Install without connecting the device] and follow the on-screen instructions to complete the installation process.



## 4 Install the files.

- Installation may take some time, depending on computer performance and the Internet connection.
- Click [Finish] or [Restart] on the screen after installation.
- After installation when the camera is connected to the computer, turn the camera off before disconnecting the cable.



- Because the content and functions of software vary according to the camera model, if you have several cameras, you must use each camera to update to its latest version of the software.

Before Use

Basic Guide

Advanced Guide

1 Camera Basics

2 Auto Mode / Hybrid Auto Mode

3 Other Shooting Modes

4 P Mode

5 Tv, Av, M, C1, and C2 Mode

6 Playback Mode

7 Wi-Fi Functions

8 Setting Menu

9 Accessories

10 Appendix

Index





## ■ Configuring the Computer for a Wi-Fi Connection (Windows Only)

On a computer running Windows, configure the following settings before connecting the camera to the computer wirelessly.



### 1 Confirm that the computer is connected to an access point.

- For instructions on checking your network connection, refer to the computer user manual.

### 2 Configure the setting.

- Click in the following order: [Start] menu ► [All Programs] ► [Canon Utilities] ► [CameraWindow] ► [Wi-Fi connection setup].
- In the application that opens, follow the on-screen instructions and configure the setting.



- The following Windows settings are configured when you run the utility in step 2.
  - Turn on media streaming.  
This will enable the camera to see (find) the computer to access via Wi-Fi.
  - Turn on network discovery.  
This will enable the computer to see (find) the camera.
  - Turn on ICMP (Internet Control Message Protocol).  
This allows you to check the network connection status.
  - Enable Universal Plug & Play (UPnP).  
This will enable network devices to detect each other automatically.
- Some security software may prevent you from completing the settings as described here. Check the settings of your security software.

## Saving Images to a Connected Computer

Connect to your access point via Wi-Fi as follows.  
Also refer to the access point user manual.

### ■ Confirming Access Point Compatibility

Confirm that the Wi-Fi router or base station conforms to the Wi-Fi standards in “Wi-Fi” (📖196).  
Connection methods vary depending on whether the access point supports Wi-Fi Protected Setup (WPS, 📖130) or not (📖132). For non-WPS access points, check the following information.

- Network name (SSID/ESSID)  
The SSID or ESSID for the access point you use. Also called the “access point name” or “network name”.
- Network authentication / data encryption (encryption method / encryption mode)  
The method for encrypting data during wireless transmission. Check which security setting is used: WPA2-PSK (AES), WPA2-PSK (TKIP), WPA-PSK (AES), WPA-PSK (TKIP), WEP (open system authentication), or no security.
- Password (encryption key / network key)  
The key used when encrypting data during wireless transmission. Also called the “encryption key” or “network key”.
- Key index (transmit key)  
The key set when WEP is used for network authentication / data encryption. Use “1” as the setting.



- If system administrator status is needed to adjust network settings, contact the system administrator for details.
- These settings are very important for network security. Exercise adequate caution when changing these settings.

Before Use

Basic Guide

Advanced Guide

1 Camera Basics

2 Auto Mode / Hybrid Auto Mode

3 Other Shooting Modes

4 P Mode

5 Tv, Av, M, C1, and C2 Mode

6 Playback Mode

7 Wi-Fi Functions

8 Setting Menu

9 Accessories

10 Appendix

Index





- For information on WPS compatibility and for instructions on checking settings, refer to the access point user manual.
- A router is a device that creates a network (LAN) structure for connecting multiple computers. A router that contains an internal Wi-Fi function is called a “Wi-Fi router”.
- This guide refers to all Wi-Fi routers and base stations as “access points”.
- If you use MAC address filtering on your Wi-Fi network, be sure to add the camera’s MAC address to your access point. You can check your camera’s MAC address by choosing MENU (30) ► [↑] tab ► [Wi-Fi Settings] ► [Check MAC Address].

## Using WPS-Compatible Access Points

WPS makes it easy to complete settings when connecting devices over Wi-Fi. You can use either Push Button Configuration Method or PIN Method for settings on a WPS supported device.

### 1 Confirm that the computer is connected to an access point.

- For instructions on checking the connection, refer to the device and access point user manuals.

### 2 Access the Wi-Fi menu.

- Press the [▶] button to turn the camera on.
- Press the [▲] button.
- When the [Device Nickname] screen is displayed, press the [⊞] button. Use the keyboard displayed to enter a nickname (31). On the [Device Nickname] screen, press the [▲][▼] buttons to choose [OK], and then press the [⊞] button.

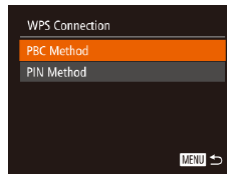
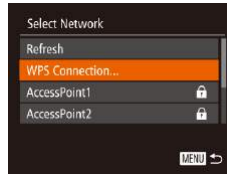
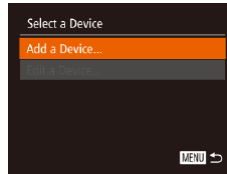
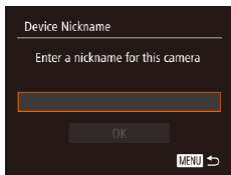
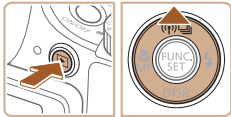

### 3 Choose [Laptop].

- Press the [▲][▼][◀][▶] buttons to choose [Laptop], and then press the [⊞] button.

### 4 Choose [Add a Device].

- Press the [▲][▼] buttons to choose [Add a Device], and then press the [⊞] button.

### 5 Choose [WPS Connection].

- Press the [▲][▼] buttons to choose [WPS Connection], and then press the [⊞] button.

### 6 Choose [PBC Method].

- Press the [▲][▼] buttons to choose [PBC Method], and then press the [⊞] button.

Before Use

Basic Guide

Advanced Guide

1 Camera Basics

2 Auto Mode / Hybrid Auto Mode

3 Other Shooting Modes

4 P Mode

5 Tv, Av, M, C1, and C2 Mode

6 Playback Mode

7 Wi-Fi Functions

8 Setting Menu

9 Accessories

10 Appendix

Index

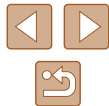

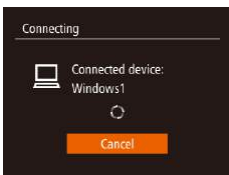
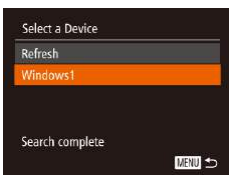
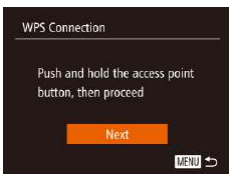

## 7 Establish the connection.

- On the access point, hold the WPS connection button for a few seconds.
- On the camera, press the button to go to the next step.
- The camera connects to the access point and lists devices connected to it on the [Select a Device] screen.

## 8 Choose the target device.

- Press the buttons to choose the target device name, and then press the button.

## 9 Install a driver (first Windows connection only).

- When this screen is displayed on the camera, click the Start menu on the computer, click [Control Panel], and then click [Add a device].
- Double-click the connected camera icon.
- Driver installation will begin.
- After driver installation is complete, and the camera and computer connection is enabled, the AutoPlay screen will be displayed. Nothing will be displayed on the camera screen.

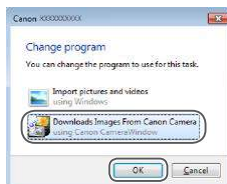

## 10 Display CameraWindow.

- Windows: Access CameraWindow by clicking [Downloads Images From Canon Camera].
- Mac OS: CameraWindow is automatically displayed when a Wi-Fi connection is established between the camera and computer.

## 11 Import images.

- Click [Import Images from Camera], and then click [Import Untransferred Images].
- Images are now saved to the Pictures folder on the computer, in separate folders named by date.
- Click [OK] in the screen that is displayed after image import is complete. For instructions on viewing images on a computer, refer to “Software Instruction Manual” (p.164).

Before Use
Basic Guide
Advanced Guide
<b>1</b> Camera Basics
<b>2</b> Auto Mode / Hybrid Auto Mode
<b>3</b> Other Shooting Modes
<b>4</b> P Mode
<b>5</b> Tv, Av, M, C1, and C2 Mode
<b>6</b> Playback Mode
<b>7</b> Wi-Fi Functions
<b>8</b> Setting Menu
<b>9</b> Accessories
<b>10</b> Appendix
Index





- Once you have connected to devices via the Wi-Fi menu, recent destinations will be listed first when you access the Wi-Fi menu. You can easily connect again by pressing the [▲][▼] buttons to choose the device and then pressing the [⊞] button. To add a new device, display the device selection screen by pressing the [◀][▶] buttons, and then configure the setting.
- If you prefer not to display recent target devices, choose MENU (📖130) ▶ [Wi-Fi Settings] ▶ [Target History] ▶ [Off].
- A message is displayed if the nickname you enter begins with a symbol or space. Press the [⊞] button and enter a different nickname.
- When the camera is connected to a computer, the camera screen is blank.
- Mac OS: If CameraWindow is not displayed, click the [CameraWindow] icon in the Dock.
- To disconnect from the camera, turn off the camera.
- If you chose [PIN Method] in step 6, a PIN code will be displayed on the screen. Be sure to set this code in the access point. Choose a device in the [Select a Device] screen. For further details, refer to the user manual included with your access point.

## Connecting to Listed Access Points

### 1 View the listed access points.

- View the listed networks (access points) as described in steps 1 – 4 of “Using WPS-Compatible Access Points” (📖130).

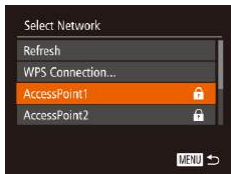

### 2 Choose an access point.

- Press the [▲][▼] buttons to choose a network (access point), and then press the [⊞] button.

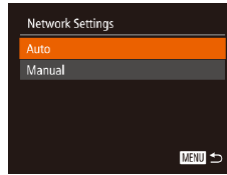

- To determine the access point password, check on the access point itself or refer to the user manual.
- Up to 16 access points will be displayed. If no access points are detected even after you choose [Refresh] in step 2 to update the list, choose [Manual Settings] in step 2 to complete access point settings manually. Follow on-screen instructions and enter an SSID, security settings, and a password.
- When you use an access point that you have already connected to for connecting to another device, [\*] is displayed for the password in step 3. To use the same password, press the [▲][▼] buttons to choose [Next], and then press the [⊞] button.

## Previous Access Points

You can reconnect to any previous access points automatically by following step 4 in “Using WPS-Compatible Access Points” (📖130).

- To reconnect to the access point, confirm that the target device is already connected to it, and then follow the procedure from step 8 in “Using WPS-Compatible Access Points” (📖130).
- To switch access points, choose [Switch Network] on the screen displayed after connection, and then either follow the procedure in “Using WPS-Compatible Access Points” (📖130) from step 5 or the procedure in “Connecting to Listed Access Points” (📖132) from step 2.

### 3 Enter the access point password.

- Press the [⊞] button to access the keyboard, and then enter the password (📖31).
- Press the [▲][▼] buttons to choose [Next], and then press the [⊞] button.

### 4 Choose [Auto].

- Press the [▲][▼] buttons to choose [Auto], and then press the [⊞] button.
- To save images to a connected computer, follow the procedure from step 8 in “Using WPS-Compatible Access Points” (📖130).

Before Use

Basic Guide

Advanced Guide

1 Camera Basics

2 Auto Mode / Hybrid Auto Mode

3 Other Shooting Modes

4 P Mode

5 Tv, Av, M, C1, and C2 Mode

6 Playback Mode

7 Wi-Fi Functions

8 Setting Menu

9 Accessories

10 Appendix

Index

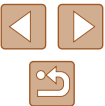

## Sending Images to a Registered Web Service

### Registering Web Services

Use a smartphone or computer to add to the camera Web services that you want to use.

- A smartphone or computer with a browser and Internet connection is required to complete camera settings for CANON iMAGE GATEWAY and other Web services.
- Check the CANON iMAGE GATEWAY website for details on browser (Microsoft Internet Explorer, etc.) requirements, including settings and version information.
- For information on countries and regions where CANON iMAGE GATEWAY is available, visit the Canon website (<http://www.canon.com/cig/>).
- You must have an account with Web services other than CANON iMAGE GATEWAY if you desire to use them. For further details, check the websites for each Web service you want to register.
- Separate ISP connection and access point fees may be applicable.

### Registering CANON iMAGE GATEWAY

After linking the camera and CANON iMAGE GATEWAY, add CANON iMAGE GATEWAY as a destination Web service on the camera.

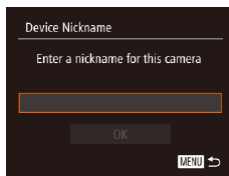
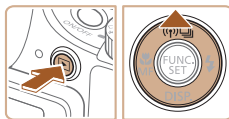

#### 1 Log in to CANON iMAGE GATEWAY and access the camera web link settings page.

- From a computer or smartphone, access <http://www.canon.com/cig/> to visit CANON iMAGE GATEWAY.
- Once the login screen is displayed, enter your user name and password to log in. If you do not have a CANON iMAGE GATEWAY account, follow the instructions to complete member registration (free of charge).

#### 2 Choose the type of camera.

- On this camera model, [📶] is displayed in the Wi-Fi menu.
- Once you choose [📶], a page is displayed for entering the authentication code. On this page in step 7, you will enter the authentication code displayed on the camera after steps 3 – 6.

#### 3 Access the Wi-Fi menu.

- Press the [▶] button to turn the camera on.
- Press the [▲] button.
- When the [Device Nickname] screen is displayed, press the [📶] button. Use the keyboard displayed to enter a nickname (31). On the [Device Nickname] screen, press the [▲][▼] buttons to choose [OK], and then press the [📶] button.

Before Use

Basic Guide

Advanced Guide

1 Camera Basics

2 Auto Mode / Hybrid Auto Mode

3 Other Shooting Modes

4 P Mode

5 Tv, Av, M, C1, and C2 Mode

6 Playback Mode

7 Wi-Fi Functions

8 Setting Menu

9 Accessories

10 Appendix

Index

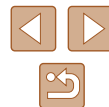

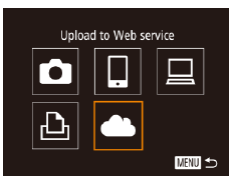

#### 4 Choose [Cloud].

- Press the [Left][Right][Up][Down][Left][Right] buttons to choose [Cloud], and then press the [OK] button.

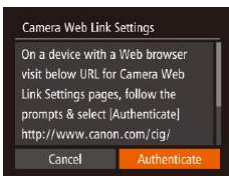

#### 5 Choose [Authenticate].

- Press the [Left][Right] buttons to choose [Authenticate], and then press the [OK] button.



#### 6 Establish a connection with an access point.

- Connect to the access point as described in steps 5 – 7 in “Using WPS-Compatible Access Points” (130) or in steps 2 – 4 in “Connecting to Listed Access Points” (132).
- Once the camera is connected to CANON iMAGE GATEWAY via the access point, an authentication code is displayed.

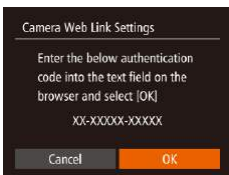

#### 7 Enter the authentication code.

- On the smartphone or computer, enter the authentication code displayed on the camera and go to the next step.
- A six-digit confirmation number is displayed.

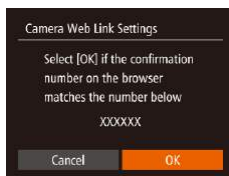

#### 8 Check the confirmation numbers and complete the setup process.

- Make sure the confirmation number on the camera matches the number on the smartphone or computer.
- Press the [Left][Right] buttons to choose [OK], and then press the [OK] button.
- Complete the setup process on the smartphone or computer.
- [Camera] (139) and CANON iMAGE GATEWAY are now added as destinations, and the [Cloud] icon changes to [Camera].
- A message is displayed on the smartphone or computer to indicate that this process is finished. To add other Web services, follow the procedure in “Registering Other Web Services” (135) from step 2.



- Connections require that a memory card with saved images be in the camera.
- Once you have connected to devices via the Wi-Fi menu, recent destinations will be listed first when you access the menu. Press the [Left][Right] buttons to access the device selection screen and choose a device.

Before Use
Basic Guide
Advanced Guide
1 Camera Basics
2 Auto Mode / Hybrid Auto Mode
3 Other Shooting Modes
4 P Mode
5 Tv, Av, M, C1, and C2 Mode
6 Playback Mode
7 Wi-Fi Functions
8 Setting Menu
9 Accessories
10 Appendix
Index

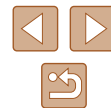

## Registering Other Web Services

You can also add Web services besides CANON iMAGE GATEWAY to the camera. Note that CANON iMAGE GATEWAY must be registered on the camera first (133).



### 1 Access the Web service settings screen.

- Follow step 1 in “Registering CANON iMAGE GATEWAY” (133) to log in to CANON iMAGE GATEWAY, and then access the Web service settings screen.



### 2 Configure the Web service you want to use.

- Follow the instructions displayed on the smartphone or computer to set up the Web service.

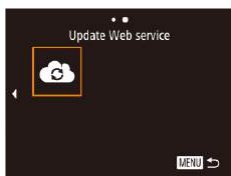

### 3 Choose [Cloud].

- In Playback mode, press the [▲] button to access the Wi-Fi menu.
- Press the [▲][▼][◀][▶] buttons to choose [Cloud], and then press the [OK] button.
- The Web service settings are now updated.



- If any configured settings change, follow these steps again to update the camera settings.

## Uploading Images to Web Services

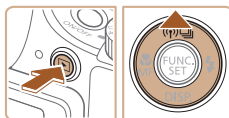

### 1 Access the Wi-Fi menu.

- Press the [▶] button to turn the camera on.
- Press the [▲] button.

### 2 Choose the destination.

- Press the [▲][▼] buttons to choose the icon of the Web service for sharing, and then press the [OK] button.
- If multiple recipients or sharing options are used with a Web service, choose the desired item on the [Select Recipient] screen by pressing the [▲][▼] buttons, and then press the [OK] button.

### 3 Send images.

- Press the [▲][▼][◀][▶] buttons to choose [Select and send], and then press the [OK] button.
- Press the [▲][▼][◀][▶] buttons to choose an image to send, press the [OK] button to mark it as selected ([✓]), and then press the [MENU] button.
- Press the [▲][▼][◀][▶] buttons to choose [Send], and then press the [OK] button.
- When uploading to YouTube, read the terms of service, choose [I Agree], and press the [OK] button.
- Image transfer will begin. The screen darkens during image transfer.
- After the images are sent, [OK] is displayed. Press the [OK] button to return to the playback screen.

Before Use

Basic Guide

Advanced Guide

1 Camera Basics

2 Auto Mode / Hybrid Auto Mode

3 Other Shooting Modes

4 P Mode

5 Tv, Av, M, C1, and C2 Mode

6 Playback Mode

7 Wi-Fi Functions

8 Setting Menu

9 Accessories

10 Appendix

Index

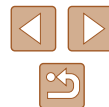



- Connections require that a memory card with saved images be in the camera.
- You can also send multiple images at once and resize images or add comments before sending (📖138).
- You can send the current image by choosing [Send this image] on the screen in step 3.

## Printing Images Wirelessly from a Connected Printer

Connect the camera to a printer via Wi-Fi to print as follows. These steps show how to use the camera as an access point, but you can also use an existing access point (📖136).

### 1 Access the Wi-Fi menu.

- Access the Wi-Fi menu as described in step 2 in “Adding a Smartphone Using the Wi-Fi Menu” (📖125).

### 2 Choose [🖨️].

- Press the [▲][▼][◀][▶] buttons to choose [🖨️], and then press the [⊕] button.



### 3 Choose [Add a Device].

- Press the [▲][▼] buttons to choose [Add a Device], and then press the [⊕] button.

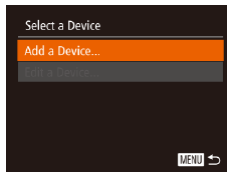

- The camera's SSID is displayed.

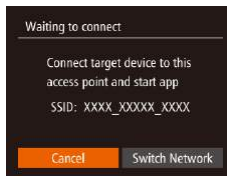

Before Use

Basic Guide

Advanced Guide

1 Camera Basics

2 Auto Mode / Hybrid Auto Mode

3 Other Shooting Modes

4 P Mode

5 Tv, Av, M, C1, and C2 Mode

6 Playback Mode

7 Wi-Fi Functions

8 Setting Menu

9 Accessories

10 Appendix

Index







#### 4 Connect the printer to the network.

- In the printer's Wi-Fi setting menu, choose the SSID (network name) displayed on the camera to establish a connection.

#### 5 Choose the printer.

- Press the [▲][▼] buttons to choose the printer name, and then press the [OK] button.

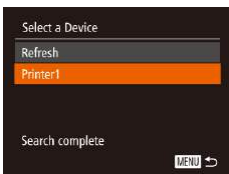

#### 6 Choose an image to print.

- Press the [◀][▶] buttons to choose an image.
- Press the [▲][▼] buttons to choose [Print], and then press the [OK] button.
- For detailed printing instructions, see "Printing Images" (166).
- To cancel the connection, press the [▲] button, press the [◀][▶] buttons on the confirmation screen to choose [OK], and then press the [OK] button.

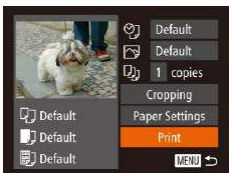

- Connections require that a memory card with saved images be in the camera.
- Once you have connected to devices via the Wi-Fi menu, recent destinations will be listed first when you access the Wi-Fi menu. You can easily connect again by pressing the [▲][▼] buttons to choose the device and then pressing the [OK] button. To add a new device, display the device selection screen by pressing the [◀][▶] buttons, and then configure the setting.
- If you prefer not to display recent target devices, choose MENU (130) ▶ [↑] tab ▶ [Wi-Fi Settings] ▶ [Target History] ▶ [Off].
- To use another access point, follow steps 3 – 4 in "Using Another Access Point" (126).

## Sending Images to Another Camera

Connect two cameras via Wi-Fi and send images between them as follows.

- Only Canon-brand cameras equipped with a Wi-Fi function can be connected to wirelessly. Even Canon-brand cameras that support Eye-Fi cards cannot be connected to if they do not have a Wi-Fi function. You cannot connect to PowerShot SD430 DIGITAL ELPH WIRELESS/DIGITAL IXUS WIRELESS cameras with this camera.

### 1 Access the Wi-Fi menu.

- Access the Wi-Fi menu as described in step 2 in "Adding a Smartphone Using the Wi-Fi Menu" (125).

### 2 Choose [Camera].

- Press the [▲][▼][◀][▶] buttons to choose [Camera], and then press the [OK] button.

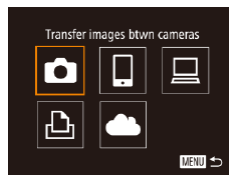

### 3 Choose [Add a Device].

- Press the [▲][▼] buttons to choose [Add a Device], and then press the [OK] button.
- Follow steps 1 – 3 on the target camera too.
- Camera connection information will be added when [Start connection on target camera] is displayed on both camera screens.

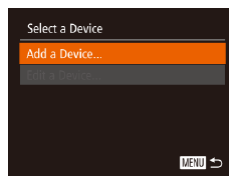

Before Use

Basic Guide

Advanced Guide

1 Camera Basics

2 Auto Mode / Hybrid Auto Mode

3 Other Shooting Modes

4 P Mode

5 Tv, Av, M, C1, and C2 Mode

6 Playback Mode

7 Wi-Fi Functions

8 Setting Menu

9 Accessories

10 Appendix

Index





#### 4 Send images.

- Press the [▲][▼][◀][▶] buttons to choose [Select and send], and then press the [OK] button.
- Press the [▲][▼][◀][▶] buttons to choose an image to send, press the [OK] button to mark it as selected ([✓]), and then press the [MENU] button.
- Press the [▲][▼][◀][▶] buttons to choose [Send], and then press the [OK] button.
- Image transfer will begin. The screen darkens during image transfer.
- [Transfer completed] is displayed after the image is sent, and the image transfer screen is displayed again.
- To cancel the connection, press the [MENU] button, press the [◀][▶] buttons on the confirmation screen to choose [OK], and then press the [OK] button.



- Connections require that a memory card be in the camera.
- Once you have connected to devices via the Wi-Fi menu, recent destinations will be listed first when you access the Wi-Fi menu. You can easily connect again by pressing the [▲][▼] buttons to choose the device and then pressing the [OK] button. To add a new device, display the device selection screen by pressing the [◀][▶] buttons, and then configure the setting.
- If you prefer not to display recent target devices, choose MENU (130) ▶ [Wi-Fi] tab ▶ [Wi-Fi Settings] ▶ [Target History] ▶ [Off].
- You can also send multiple images at once and change the image size before sending (138).
- You can send the current image by choosing [Send this image] on the screen in step 4.

## Image Sending Options

You can choose multiple images to send at once and change the image resolution (size) before sending. Some Web services also enable you to annotate the images you send.

### Notes on Sending Images

- Keep your fingers or other objects off the Wi-Fi antenna area (13). Covering this may decrease the speed of your image transfers.
- Depending on the condition of the network you are using, it may take a long time to send movies. Be sure to keep an eye on the camera battery level.
- Up to 50 images can be sent together at once. One movie up to five minutes (or one digest movie up to 13 minutes) can be sent. However, Web services may limit the number of images or length of movies you can send. For details, refer to the Web service you are using.
- For movies that you do not compress (121), a separate, compressed file is sent instead of the original file. Note that this may delay transmission, and the file cannot be sent unless there is enough space for it on the memory card.
- When sending movies to smartphones, note that the supported image quality varies depending on the smartphone. For details, refer to the smartphone user manual.
- On the screen, wireless signal strength is indicated by the following icons:  
[Full bars] high, [3 bars] medium, [2 bars] low, [1 bar] weak
- Sending images to Web services will take less time when resending images you have already sent that are still on the CANON iMAGE GATEWAY server.

Before Use

Basic Guide

Advanced Guide

1 Camera Basics

2 Auto Mode / Hybrid Auto Mode

3 Other Shooting Modes

4 P Mode

5 Tv, Av, M, C1, and C2 Mode

6 Playback Mode

7 Wi-Fi Functions

8 Setting Menu

9 Accessories

10 Appendix

Index



## Choosing the Image Resolution (Size)

On the image transfer screen, choose [F] by pressing the [▲][▼] buttons, and then press the [Ⓜ] button. On the screen displayed, choose the resolution by pressing the [▲][▼] buttons, and then press the [Ⓜ] button.

- To send images at original size, select [No] as the resizing option.
- Choosing [M2] or [S] will resize images that are larger than the selected size before sending.
- Movies cannot be resized.



- Image size can also be configured in MENU (📖30) ▶ [📡] tab ▶ [Wi-Fi Settings] ▶ [Resize for Sending].

## Adding Comments

Using the camera, you can add comments to images that you send to e-mail addresses, social networking services, etc. The number of characters and symbols that can be entered may differ depending on the Web service.

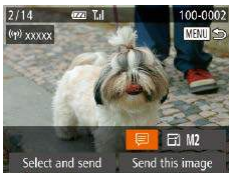

### 1 Access the screen for adding comments.

- On the image transfer screen, choose [F] by pressing the [▲][▼][◀][▶] buttons, and then press the [Ⓜ] button.

### 2 Add a comment (📖31).

### 3 Send the image.



- When a comment is not entered, the comment set in CANON iMAGE GATEWAY is automatically sent.
- You can also annotate multiple images before sending them. The same comment is added to all images sent together.

## Sending Images Automatically (Image Sync)

Images on the memory card that have not been transferred already can be sent to a computer or Web services via CANON iMAGE GATEWAY. Note that images cannot be sent only to Web services.

## Initial Preparations

### ■ Preparing the Camera

Register [📡] as the destination. You can also assign [📡] to the [📡] button, so that you can simply press the [📡] button to send any unsent images on the memory card to a computer via CANON iMAGE GATEWAY.



### 1 Add [📡] as a destination.

- Add [📡] as a destination, as described in “Registering CANON iMAGE GATEWAY” (📖133).
- To choose a Web service as the destination, follow the steps in “Registering Other Web Services” (📖135) to update the camera settings.

### 2 Choose the type of images to send (only when sending movies with images).

- Press the [MENU] button and choose [Wi-Fi Settings] on the [📡] tab (📖30).
- Press the [▲][▼] buttons to choose [Image Sync], and then press the [◀][▶] buttons to choose [Stills/Movies].

Before Use

Basic Guide

Advanced Guide

1 Camera Basics

2 Auto Mode / Hybrid Auto Mode

3 Other Shooting Modes

4 P Mode

5 Tv, Av, M, C1, and C2 Mode

6 Playback Mode

7 Wi-Fi Functions

8 Setting Menu





9 Accessories

10 Appendix

Index



### 3 Assign to the button (only when sending images by pressing the button).

- Clear the  button setting if a smartphone is already assigned to the button ([123](#)).
- Access the mobile connection screen as described in step 2 in “Sending to a Smartphone Assigned to the Button” ([123](#)), press the  buttons to choose , and then press the  button.

## ■ Preparing the Computer



Install and configure the software on the destination computer.



### 1 Install the software.

- Install the software on a computer connected to the Internet ([127](#)).





### 2 Register the camera.

- Windows: In the taskbar, right-click , and then click [Add new camera].
- Mac OS: In the menu bar, click , and then click [Add new camera].
- A list of cameras linked to CANON iMAGE GATEWAY is displayed. Choose the camera from which images are to be sent.
- Once the camera is registered and the computer is ready to receive images, the icon changes to .

## Sending Images

Images sent from the camera are automatically saved to the computer. If the computer that you intend to send images to is turned off, the images will be stored temporarily on the CANON iMAGE GATEWAY server. Stored images are regularly erased, so make sure to turn on the computer and save the images.

### 1 Send images.

- If you have already assigned  to the  button, press the  button.
- If you have not assigned the button this way, choose  as described in steps 1 – 2 in “Uploading Images to Web Services” ([135](#)).
- Once the connection is established, the images are sent. When the images have been sent successfully to the CANON iMAGE GATEWAY server,  is displayed on the screen.

### 2 Save the images to the computer.

- Images are automatically saved to the computer when you turn it on.
- Images are automatically sent to Web services from the CANON iMAGE GATEWAY server, even if the computer is off.



- When sending images, you should use a fully charged battery pack or an AC adapter kit (sold separately, [155](#)).

Before Use

Basic Guide

Advanced Guide

1 Camera Basics

2 Auto Mode / Hybrid Auto Mode

3 Other Shooting Modes

4 P Mode

5 Tv, Av, M, C1, and C2 Mode

6 Playback Mode

7 Wi-Fi Functions

8 Setting Menu

9 Accessories

10 Appendix

Index

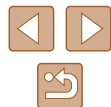



- Even if images were imported to the computer through a different method, any images not sent to the computer via CANON iMAGE GATEWAY will be sent to the computer.
- Sending is faster when the destination is a computer on the same network as the camera, because images are sent via the access point instead of CANON iMAGE GATEWAY. Note that images stored on the computer are sent to CANON iMAGE GATEWAY, so the computer must be connected to the Internet.

## Using a Smartphone to View Camera Images and Control the Camera

You can do the following with the dedicated smartphone app CameraWindow.

- Browse images on the camera and save them to the smartphone
- Geotag images on the camera (📖141)
- Shoot remotely (📖142)



- In camera settings, the smartphone must be allowed to view camera images (📖123, 📖125, 📖143).

## Geotagging Images on the Camera

GPS data recorded on a smartphone using the dedicated CameraWindow application can be added to images on the camera. Images are tagged with information including the latitude, longitude, and elevation.



- Before shooting, make sure the date and time and your home time zone are set correctly, as described in “Setting the Date and Time” (📖20). Also follow the steps in “World Clock” (📖146) to specify any shooting destinations in other time zones.
- Others may be able to locate or identify you by using location data in your geotagged still images or movies. Be careful when sharing these images with others, as when posting images online where many others can view them.

Before Use

Basic Guide

Advanced Guide

**1** Camera Basics

**2** Auto Mode / Hybrid Auto Mode

**3** Other Shooting Modes

**4** P Mode

**5** Tv, Av, M, C1, and C2 Mode

**6** Playback Mode

**7** Wi-Fi Functions

**8** Setting Menu

**9** Accessories

**10** Appendix

Index



## Shooting Remotely

As you check a shooting screen on your smartphone, you can use it to shoot remotely.

### 1 Secure the camera.

- Once remote shooting begins, the camera lens will come out. Lens motion from zooming may also move the camera out of position. Keep the camera still by mounting it on a tripod or taking other measures.

### 2 Connect the camera and smartphone (📖123, 📖125).

- In the privacy settings, choose [Yes].

### 3 Choose remote shooting.

- In CameraWindow on the smartphone, choose remote shooting.
- The camera lens will come out. Do not press near the lens, and make sure no objects will obstruct it.
- Once the camera is ready for remote shooting, a live image from the camera will be displayed on the smartphone.
- At this time, a message is displayed on the camera, and all operations except pressing the power button are disabled.

### 4 Shoot.

- Use the smartphone to shoot.



- The camera works in [P] mode during remote shooting. However, some FUNC. and MENU settings you have configured in advance may be changed automatically.
- Movie shooting is not available.



- Any jerky subject motion shown on the smartphone due to the connection environment will not affect recorded images.
- No AF frames are displayed. Capture a test image to check the focus.
- Captured images are not transferred to the smartphone. Use the smartphone to browse and import images from the camera.

Before Use

Basic Guide

Advanced Guide

1 Camera Basics

2 Auto Mode / Hybrid Auto Mode

3 Other Shooting Modes

4 P Mode

5 Tv, Av, M, C1, and C2 Mode

6 Playback Mode

7 Wi-Fi Functions

8 Setting Menu

9 Accessories

10 Appendix

Index

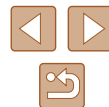

# Editing or Erasing Wi-Fi Settings

Edit or erase Wi-Fi settings as follows.

## Editing Connection Information

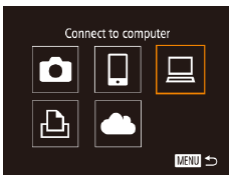

### 1 Access the Wi-Fi menu and choose the device to edit.

- Press the [MENU] button to turn the camera on.
- Press the [OK] button.
- Press the [LEFT][RIGHT] buttons to access the device selection screen, press the [UP][DOWN][LEFT][RIGHT] buttons to choose the icon of a device to edit, and then press the [MENU] button.



### 2 Choose [Edit a Device].

- Press the [UP][DOWN] buttons to choose [Edit a Device], and then press the [MENU] button.

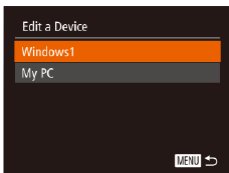

### 3 Choose a device to edit.

- Press the [UP][DOWN] buttons to choose the device to edit, and then press the [MENU] button.

### 4 Choose an item to edit.

- Press the [UP][DOWN] buttons to choose an item to edit, and then press the [MENU] button.
- The items you can change depend on what device or service the camera will access.

Configurable Items	Connection				
	Camera	Phone	Laptop	Printer	Web Services
[Change Device Nickname] (📖143)	○	○	○	○	–
[View Settings] (📖125)	–	○	–	–	–
[Erase Connection Info] (📖143)	○	○	○	○	–

○ : Configurable    – : Not configurable

## Changing a Device Nickname

You can change the device nickname (display name) that is displayed on the camera.

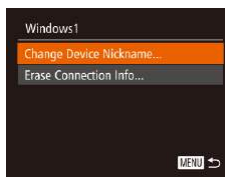

- Following step 4 in “Editing Connection Information” (📖143), choose [Change Device Nickname] and press the [MENU] button.
- Select the input field and press the [MENU] button. Use the keyboard displayed to enter a new nickname (📖31).

## Erasing Connection Information

Erase connection information (information about devices that you have connected to) as follows.

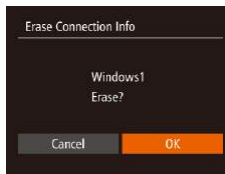

- Following step 4 in “Editing Connection Information” (📖143), choose [Erase Connection Info] and press the [MENU] button.
- After [Erase?] is displayed, press the [LEFT][RIGHT] buttons to choose [OK], and then press the [MENU] button.
- The connection information will be erased.

Before Use
Basic Guide
Advanced Guide
<b>1</b> Camera Basics
<b>2</b> Auto Mode / Hybrid Auto Mode
<b>3</b> Other Shooting Modes
<b>4</b> P Mode
<b>5</b> Tv, Av, M, C1, and C2 Mode
<b>6</b> Playback Mode
<b>7</b> Wi-Fi Functions
<b>8</b> Setting Menu
<b>9</b> Accessories
<b>10</b> Appendix

Index

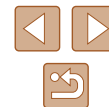

## Returning the Wi-Fi Settings to Default

Return the Wi-Fi settings to default if you transfer ownership of the camera to another person, or dispose of it.

Resetting the Wi-Fi settings will also clear all Web service settings. Be sure that you want to reset all Wi-Fi settings before using this option.



### 1 Choose [Wi-Fi Settings].

- Press the [MENU] button and choose [Wi-Fi Settings] on the [↑↓] tab (📖30).

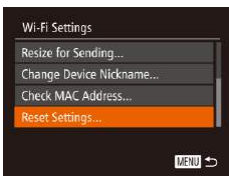

### 2 Choose [Reset Settings].

- Press the [▲][▼] buttons to choose [Reset Settings], and then press the [OK] button.

### 3 Restore the default settings.

- Press the [◀][▶] buttons to choose [OK], and then press the [OK] button.
- The Wi-Fi settings are now reset.



- To reset other settings (aside from Wi-Fi) to defaults, choose [Reset All] on the [↑↓] tab (📖152).

Before Use

Basic Guide

Advanced Guide

1 Camera Basics

2 Auto Mode / Hybrid Auto Mode

3 Other Shooting Modes

4 P Mode

5 Tv, Av, M, C1, and C2 Mode

6 Playback Mode

7 Wi-Fi Functions

8 Setting Menu

9 Accessories

10 Appendix

Index

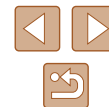



# 8

## Setting Menu

Customize or adjust basic camera functions for greater convenience

### Adjusting Basic Camera Functions

MENU (📖30) functions on the (📷) tab can be configured. Customize commonly used functions as desired, for greater convenience.

#### Silencing Camera Operations

Silence camera sounds and movies as follows.

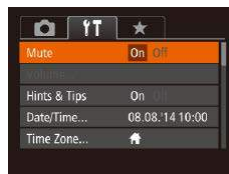

- Choose [Mute], and then choose [On].



- Operation can also be silenced by holding down the [▼] button as you turn the camera on.
- Sound is not played during movies (📖101) if you mute camera sounds. To restore sound during movies, press the [▲] button. Adjust volume with the [▲][▼] buttons, as needed.

#### Adjusting the Volume

Adjust the volume of individual camera sounds as follows.



- Choose [Volume], and then press the (🔊) button.
- Choose an item, and then press the [◀][▶] buttons to adjust the volume.

Before Use
Basic Guide
Advanced Guide
<b>1</b> Camera Basics
<b>2</b> Auto Mode / Hybrid Auto Mode
<b>3</b> Other Shooting Modes
<b>4</b> P Mode
<b>5</b> Tv, Av, M, C1, and C2 Mode
<b>6</b> Playback Mode
<b>7</b> Wi-Fi Functions
<b>8</b> Setting Menu
<b>9</b> Accessories
<b>10</b> Appendix
Index

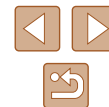

## Hiding Hints and Tips

Hints and tips are normally shown when you choose FUNC. (📖29) or MENU (📖30) items. If you prefer, you can deactivate this information.



- Choose [Hints & Tips], and then choose [Off].

## Date and Time

Adjust the date and time as follows.

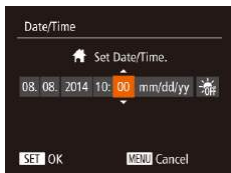

- Choose [Date/Time], and then press the [⊕] button.
- Press the [◀][▶] buttons to choose an option, and then press the [▲][▼] buttons to adjust the setting.

## World Clock

To ensure that your shots will have the correct local date and time when you travel abroad, simply register the destination in advance and switch to that time zone. This convenient feature eliminates the need to change the Date/Time setting manually.

Before using the world clock, be sure to set the date and time and your home time zone, as described in "Setting the Date and Time" (📖20).

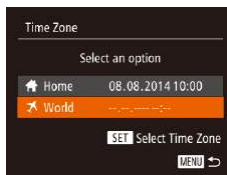

### 1 Specify your destination.

- Choose [Time Zone], and then press the [⊕] button.
- Press the [▲][▼] buttons to choose [✈ World], and then press the [⊕] button.
- Press the [◀][▶] buttons to choose the destination.
- To set daylight saving time (1 hour ahead), choose [☀] by pressing the [▲][▼] buttons, and then choose [☀] by pressing the [◀][▶] buttons.
- Press the [⊕] button.

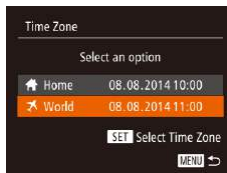

### 2 Switch to the destination time zone.

- Press the [▲][▼] buttons to choose [✈ World], and then press the [MENU] button.
- [✈] is now shown on the shooting screen (📖180).



- Adjusting the date or time while in [✈] mode (📖21) will automatically update your [🏠 Home] time and date.

Before Use

Basic Guide

Advanced Guide

1 Camera Basics

2 Auto Mode / Hybrid Auto Mode

3 Other Shooting Modes

4 P Mode

5 Tv, Av, M, C1, and C2 Mode

6 Playback Mode

7 Wi-Fi Functions

8 Setting Menu

9 Accessories

10 Appendix

Index



## Lens Retraction Timing

The lens is normally retracted for safety about one minute after you press the [MENU] button in Shooting mode (125). To have the lens retracted immediately after you press the [MENU] button, set the retraction timing to [0 sec.].

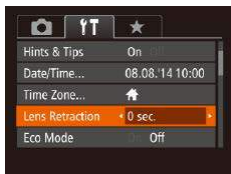

- Choose [Lens Retraction], and then choose [0 sec.].

## Using Eco Mode

This function allows you to conserve battery power in Shooting mode. When the camera is not in use, the screen quickly darkens to reduce battery consumption.

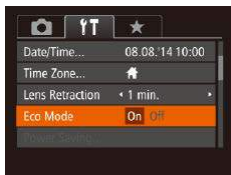

### 1 Configure the setting.

- Choose [Eco Mode], and then choose [On].
- [ECO] is now shown on the shooting screen (180).
- The screen darkens when the camera is not used for approximately two seconds; approximately ten seconds after darkening, the screen turns off. The camera turns off after approximately three minutes of inactivity.

### 2 Shoot.

- To activate the screen and prepare for shooting when the screen is off but the lens is still out, press the shutter button halfway.

## Power-Saving Adjustment

Adjust the timing of automatic camera and screen deactivation (Auto Power Down and Display Off, respectively) as needed (126).

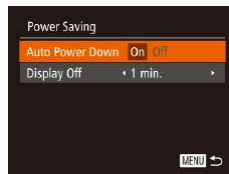

- Choose [Power Saving], and then press the [MENU] button.
- After choosing an item, press the [LEFT][RIGHT] buttons to adjust it as needed.



- To conserve battery power, you should normally choose [On] for [Auto Power Down] and [1 min.] or less for [Display Off].



- The [Display Off] setting is applied even if you set [Auto Power Down] to [Off].
- These power-saving functions are not available when you have set Eco mode (147) to [On].

Before Use

Basic Guide

Advanced Guide

1 Camera Basics

2 Auto Mode / Hybrid Auto Mode

3 Other Shooting Modes

4 P Mode

5 Tv, Av, M, C1, and C2 Mode

6 Playback Mode

7 Wi-Fi Functions

8 Setting Menu

9 Accessories

10 Appendix

Index

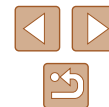

## Screen Brightness

Adjust screen brightness as follows.

Screen and viewfinder brightness can be set separately. Activate the desired display in advance by pressing the [DISP.] button.

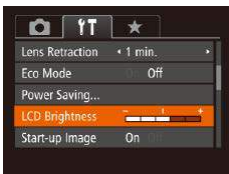

- Choose [LCD Brightness], and then press the [◀][▶] buttons to adjust the brightness.



- For maximum brightness, press and hold the [▼] button for at least one second when the shooting screen is displayed or when in single-image display. (This will override the [LCD Brightness] setting on the [DISP.] tab.) To restore the original brightness, press and hold the [▼] button again for at least one second or restart the camera.

## Hiding the Start-Up Screen

If you prefer, you can deactivate display of the start-up screen normally shown when you turn the camera on.

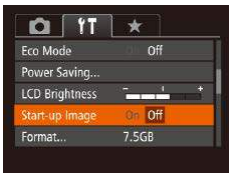

- Choose [Start-up Image], and then choose [Off].

## Formatting Memory Cards

Before using a new memory card or a card formatted in another device, you should format the card with this camera.

Formatting erases all data on a memory card. Before formatting, copy images on the memory card to a computer, or take other steps to back them up.

### 1 Access the [Format] screen.

- Choose [Format], and then press the [ⓘ] button.

### 2 Choose [OK].

- Press the [▲][▼] buttons to choose [Cancel], press the [◀][▶] buttons to choose [OK], and then press the [ⓘ] button.

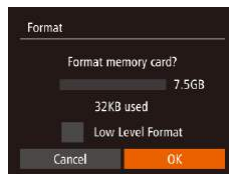

### 3 Format the memory card.

- To begin the formatting process, press the [▲][▼] buttons to choose [OK], and then press the [ⓘ] button.
- When formatting is finished, [Memory card formatting complete] is displayed. Press the [ⓘ] button.

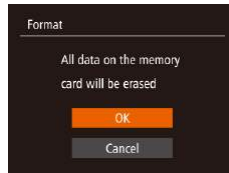

- Formatting or erasing data on a memory card only changes file management information on the card and does not erase the data completely. When transferring or disposing of memory cards, take steps to protect personal information if necessary, as by physically destroying cards.



- The total card capacity indicated on the formatting screen may be less than the advertised capacity.

Before Use

Basic Guide

Advanced Guide

1 Camera Basics

2 Auto Mode / Hybrid Auto Mode

3 Other Shooting Modes

4 P Mode

5 Tv, Av, M, C1, and C2 Mode

6 Playback Mode

7 Wi-Fi Functions

8 Setting Menu

9 Accessories

10 Appendix

Index



## Low-Level Formatting

Perform low-level formatting in the following cases: [Memory card error] is displayed, the camera is not working correctly, card image reading/writing is slower, continuous shooting is slower, or movie recording suddenly stops. Low-level formatting erases all data on a memory card. Before low-level formatting, copy images on the memory card to a computer, or take other steps to back them up.

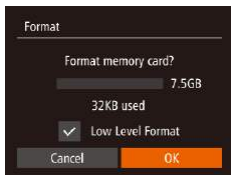

- On the screen in step 2 of “Formatting Memory Cards” (📖148), press the [▲][▼] buttons to choose [Low Level Format], and then press the [◀][▶] buttons to select this option. A [✓] icon is displayed.
- Follow steps 2 – 3 in “Formatting Memory Cards” (📖148) to continue with the formatting process.



- Low-level formatting takes longer than “Formatting Memory Cards” (📖148), because data is erased from all storage regions of the memory card.
- You can cancel low-level formatting in progress by choosing [Stop]. In this case, all data will be erased, but the memory card can be used normally.

## File Numbering

Your shots are automatically numbered in sequential order (0001 – 9999) and saved in folders that store up to 2,000 images each. You can change how the camera assigns file numbers.

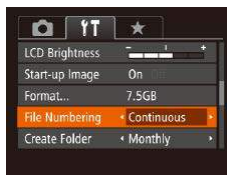

- Choose [File Numbering], and then choose an option.

Continuous	Images are numbered consecutively (until the 9999th shot is taken/saved) even if you switch memory cards.
Auto Reset	Image numbering is reset to 0001 if you switch memory cards, or when a new folder is created.



- Regardless of the option selected in this setting, shots may be numbered consecutively after the last number of existing images on newly inserted memory cards. To start saving shots from 0001, use an empty (or formatted (📖148)) memory card.
- Refer to “Software Instruction Manual” (📖164) for information on the card folder structure and image formats.

Before Use

Basic Guide

Advanced Guide

**1** Camera Basics

**2** Auto Mode / Hybrid Auto Mode

**3** Other Shooting Modes

**4** P Mode

**5** Tv, Av, M, C1, and C2 Mode

**6** Playback Mode

**7** Wi-Fi Functions

**8** Setting Menu

**9** Accessories

**10** Appendix

Index

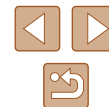

## Date-Based Image Storage

Instead of saving images in folders created each month, you can have the camera create folders each day you shoot to store shots taken that day.



- Choose [Create Folder], and then choose [Daily].
- Images will now be saved in folders created on the shooting date.

## Metric / Non-Metric Display

Change the unit of measurement shown in GPS elevation information (📖103, 📖141), the zoom bar (📖33), the MF indicator (📖79), and elsewhere from m/cm to ft/in as needed.



- Choose [Units], and then choose [ft/in].

## Electronic Level Calibration

Calibrate the electronic level if it seems ineffective in helping you level the camera.

For greater calibration accuracy, display grid lines (📖96) to help you level the camera in advance.

### 1 Make sure the camera is level.

- Place the camera on a flat surface, such as a table.

### 2 Calibrate the electronic level.

- Choose [Electronic Level], and then press the [⏏] button.
- Choose [Calibrate] and press the [⏏] button. A confirmation message is displayed.
- Choose [OK], and then press the [⏏] button.

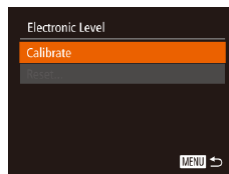

### Resetting the Electronic Level

Restore the electronic level to its original state as follows. Note that this is not possible unless you have calibrated the electronic level.



- Choose [Electronic Level], and then press the [⏏] button.
- Choose [Reset], and then press the [⏏] button.
- Choose [OK], and then press the [⏏] button.

Before Use

Basic Guide

Advanced Guide

1 Camera Basics

2 Auto Mode / Hybrid Auto Mode

3 Other Shooting Modes

4 P Mode

5 Tv, Av, M, C1, and C2 Mode

6 Playback Mode

7 Wi-Fi Functions

8 Setting Menu

9 Accessories

10 Appendix

Index

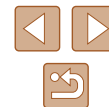

## Setting Copyright Information to Record in Images

To record the author's name and copyright details in images, set this information beforehand as follows.

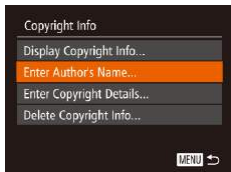

- Choose [Copyright Info], and then press the [MENU] button.
- Press the [▲][▼] buttons to choose [Enter Author's Name] or [Enter Copyright Details]. Press the [F1] button to access the keyboard, and enter the name (164).
- Press the [MENU] button. When [Accept changes?] is displayed, press the [Left][Right] buttons to choose [Yes], and then press the [F1] button.
- The information set here will now be recorded in images.



- To check the information entered, choose [Display Copyright Info] on the screen above, and then press the [F1] button.
- You can also use the software (164) to enter, change, and delete copyright information. Some characters entered with the software may not display on the camera, but will be correctly recorded in images.
- You can check copyright information recorded in images by using the software, once you save the images to a computer.

## Deleting All Copyright Information

You can delete both the author's name and copyright details at the same time as follows.

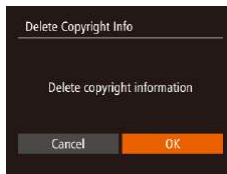

- Follow the steps in "Setting Copyright Information to Record in Images" (151) and choose [Delete Copyright Info].
- Press the [Left][Right] buttons to choose [OK], and then press the [F1] button.



- The copyright info already recorded in images will not be deleted.

## Checking Certification Logos

Some logos for certification requirements met by the camera can be viewed on the screen. Other certification logos are printed in this guide, on the camera packaging, or on the camera body.

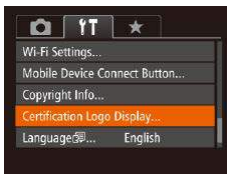

- Choose [Certification Logo Display], and then press the [F1] button.

Before Use

Basic Guide

Advanced Guide

1 Camera Basics

2 Auto Mode / Hybrid Auto Mode

3 Other Shooting Modes

4 P Mode

5 Tv, Av, M, C1, and C2 Mode

6 Playback Mode

7 Wi-Fi Functions

8 Setting Menu

9 Accessories

10 Appendix

Index

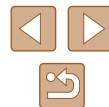

## Display Language

Change the display language as needed.

English	Norsk	Română
Deutsch	Svenska	Türkçe
Français	Español	العربية
Nederlands	Ελληνικά	հայերեն
Dansk	Русский	简体中文
Português	Polski	繁體中文
Suomi	Čeština	한국어

- Choose [Language] (🗨️), and then press the (⏸️) button.
- Press the [▲][▼][◀][▶] buttons to choose a language, and then press the (⏸️) button.



- You can also access the [Language] screen in Playback mode by pressing and holding the (⏸️) button and immediately pressing the [MENU] button.

## Adjusting Other Settings

The following settings can also be adjusted on the (🔧) tab.

- [Video System] (📖157)
- [Wi-Fi Settings] (📖122)
- [Mobile Device Connect Button] (📖123)

## Restoring Defaults

If you accidentally change a setting, you can restore default camera settings.

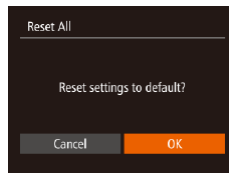

### 1 Access the [Reset All] screen.

- Choose [Reset All], and then press the (⏸️) button.

### 2 Restore default settings.

- Press the [◀][▶] buttons to choose [OK], and then press the (⏸️) button.
- Default settings are now restored.



- The following functions are not restored to default settings.
  - Information registered using Face ID (📖47)
  - (🔧) tab settings [Date/Time] (📖146), [Time Zone] (📖146), [Language] (🗨️) (📖152), and [Video System] (📖157)
  - Custom white balance data you have recorded (📖77)
  - Shooting mode (📖59)
  - Wi-Fi settings (📖122)
  - Calibrated value for the electronic level (📖150)

Before Use

Basic Guide

Advanced Guide

1 Camera Basics

2 Auto Mode / Hybrid Auto Mode

3 Other Shooting Modes

4 P Mode

5 Tv, Av, M, C1, and C2 Mode

6 Playback Mode

7 Wi-Fi Functions

8 Setting Menu

9 Accessories

10 Appendix

Index

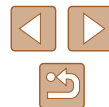



# 9

## Accessories

Enjoy the camera in more ways with optional Canon accessories and other compatible accessories sold separately

Before Use

Basic Guide

Advanced Guide

**1** Camera Basics

**2** Auto Mode /  
Hybrid Auto Mode

**3** Other Shooting Modes

**4** P Mode

**5** Tv, Av, M, C1, and C2 Mode

**6** Playback Mode

**7** Wi-Fi Functions

**8** Setting Menu

**9** Accessories

**10** Appendix

Index

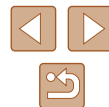

# System Map

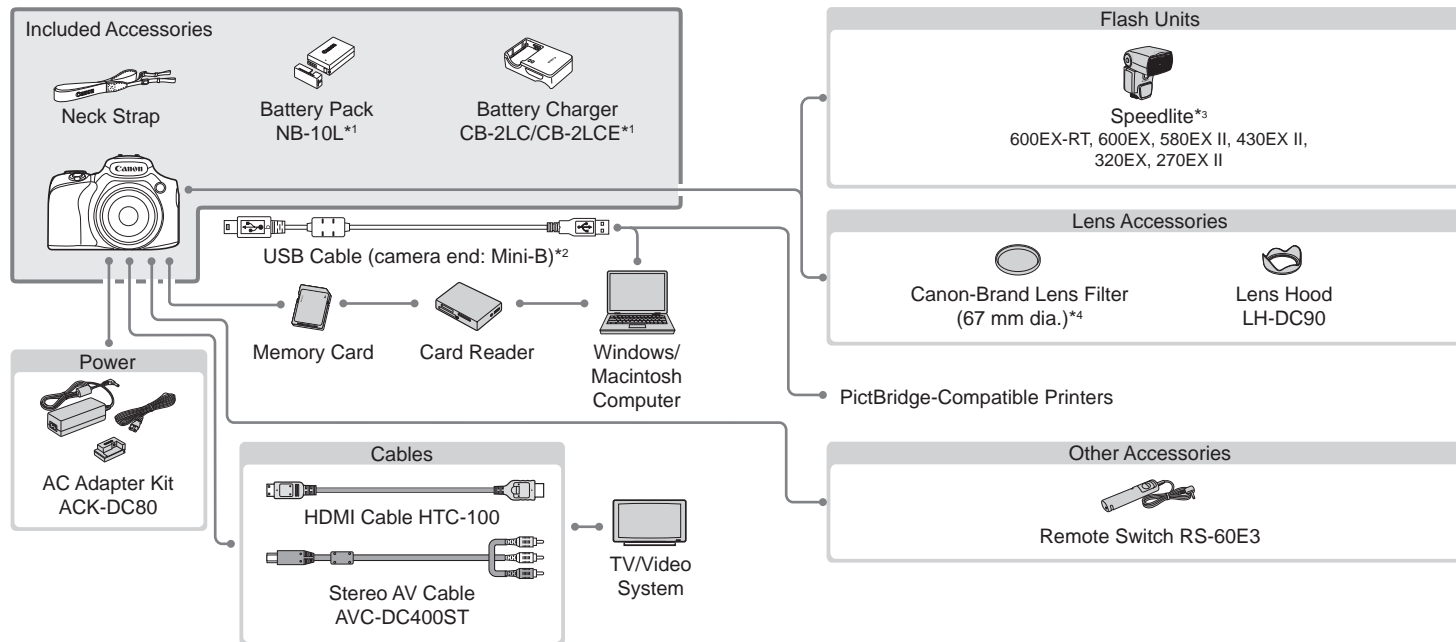

\*1 Also available for purchase separately.

\*2 A genuine Canon accessory is also available (Interface Cable IFC-400PCU).

\*3 The following accessories are also supported: Speedlite 580EX, 430EX, 270EX, and 220EX, Speedlite Transmitter ST-E2, and Speedlite Bracket SB-E2.

\*4 Requires Filter Adapter FA-DC67A.

## Use of genuine Canon accessories is recommended.

This product is designed to achieve excellent performance when used with genuine Canon accessories.

Canon shall not be liable for any damage to this product and/or accidents such as fire, etc., caused by the malfunction of non-genuine Canon accessories (e.g., a leakage and/or explosion of a battery pack). Please note that this warranty does not apply to repairs arising out of the malfunction of non-genuine Canon accessories, although you may request such repairs on a chargeable basis.

- Before Use
- Basic Guide
- Advanced Guide
  - 1 Camera Basics
  - 2 Auto Mode / Hybrid Auto Mode
  - 3 Other Shooting Modes
  - 4 P Mode
  - 5 Tv, Av, M, C1, and C2 Mode
  - 6 Playback Mode
  - 7 Wi-Fi Functions
  - 8 Setting Menu
  - 9 Accessories
  - 10 Appendix
- Index



## Optional Accessories

The following camera accessories are sold separately. Note that availability varies by area, and some accessories may no longer be available.

### Power Supplies

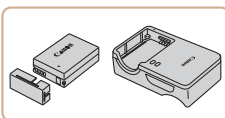

#### Battery Pack NB-10L

- Rechargeable lithium-ion battery

#### Battery Charger CB-2LC/CB-2LCE

- Charger for Battery Pack NB-10L

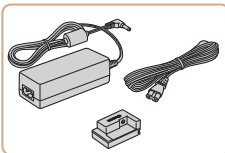

#### AC Adapter Kit ACK-DC80

- For powering the camera using household power. Recommended when using the camera over extended periods, or when connecting the camera to a printer or computer. Cannot be used to charge the battery pack in the camera.



- The battery charger and AC adapter kit can be used in areas with 100 – 240 V AC power (50/60 Hz).
- For power outlets in a different format, use a commercially available adapter for the plug. Never use an electrical transformer designed for traveling, which may damage the battery pack.

## Flash Units

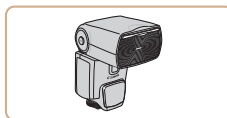

#### Speedlite 600EX-RT/600EX/580EX II/430EX II/320EX/270EX II

- Shoe-mounted flash unit that enables many styles of flash photography. Speedlite 580EX, 430EX, 270EX, and 220EX are also supported.

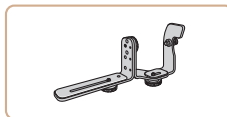

#### Speedlite Bracket SB-E2

- Prevents unnatural shadows next to subjects during vertical shooting. Includes Off-Camera Shoe Cord OC-E3.

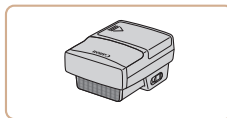

#### Speedlite Transmitter ST-E2

- Enables wireless control of slave Speedlite flash units (except Speedlite 220EX/270EX).

## Other Accessories

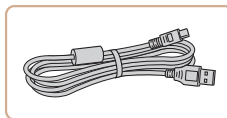

#### Interface Cable IFC-400PCU

- For connecting the camera to a computer or printer.

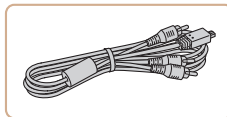

#### Stereo AV Cable AVC-DC400ST

- Connect the camera to a TV to enjoy playback on the larger TV screen.

Before Use

Basic Guide

Advanced Guide

**1** Camera Basics

**2** Auto Mode / Hybrid Auto Mode

**3** Other Shooting Modes

**4** P Mode

**5** Tv, Av, M, C1, and C2 Mode

**6** Playback Mode

**7** Wi-Fi Functions

**8** Setting Menu

**9** Accessories

**10** Appendix

Index

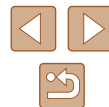

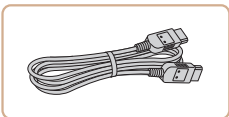

### HDMI Cable HTC-100

- For connecting the camera to an HDMI input of a high-definition TV.

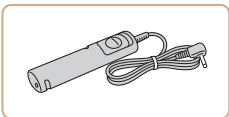

### Remote Switch RS-60E3

- Enables remote shutter button operation (pressing the button halfway or all the way down).

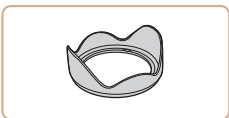

### Lens Hood LH-DC90

- Prevents extraneous light outside the angle of view from entering the lens and causing flares or ghosting, which reduce image quality.



### Filter Adapter FA-DC67A

- Adapter required when mounting a 67 mm filter.

### Canon Lens Filter (67 mm dia.)

- Protects the lens and enables a variety of shooting effects.



- A lens filter and lens cap cannot be attached to the camera at the same time.

## Printers

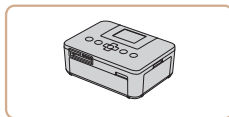

### Canon-Brand PictBridge-Compatible Printers

- Even without using a computer, you can print images by connecting the camera directly to a printer. For details, visit your nearest Canon retailer.

Before Use

Basic Guide

Advanced Guide

**1** Camera Basics

**2** Auto Mode / Hybrid Auto Mode

**3** Other Shooting Modes

**4** P Mode

**5** Tv, Av, M, C1, and C2 Mode

**6** Playback Mode

**7** Wi-Fi Functions

**8** Setting Menu

**9** Accessories

**10** Appendix

Index

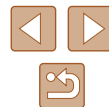

## Using Optional Accessories

▶ Still Images ▶ Movies

## Playback on a TV

▶ Still Images ▶ Movies

By connecting the camera to a TV, you can view your shots on the larger screen of the TV.

For details on connection or how to switch inputs, refer to the TV manual.



- Some information may not be displayed when viewing images on a TV (181).

## Playback on a High-Definition TV

▶ Still Images ▶ Movies

Connecting the camera to an HDTV with the HDMI Cable HTC-100 (sold separately) enables you to view your shots on the larger screen of the TV. Movies shot at a resolution of [FHD 60P], [FHD 30P], or [FHD 30P] can be viewed in high definition.

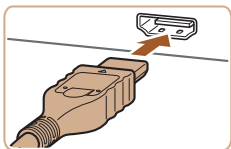

**1** Make sure the camera and TV are off.

**2** Connect the camera to the TV.

- On the TV, insert the cable plug fully into the HDMI input as shown.

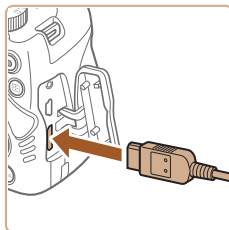

- On the camera, open the terminal cover and insert the cable plug fully into the camera terminal.



**3** Turn the TV on and switch to video input.

- Switch the TV input to the video input you connected the cable to in step 2.

**4** Turn the camera on.

- Press the [▶] button to turn the camera on.
- Images from the camera are now displayed on the TV. (Nothing is displayed on the camera screen.)
- When finished, turn off the camera and TV before disconnecting the cable.



- Camera operating sounds are not played while the camera is connected to an HDTV.

Before Use

Basic Guide

Advanced Guide

**1** Camera Basics

**2** Auto Mode / Hybrid Auto Mode

**3** Other Shooting Modes

**4** P Mode

**5** Tv, Av, M, C1, and C2 Mode

**6** Playback Mode

**7** Wi-Fi Functions

**8** Setting Menu

**9** Accessories

**10** Appendix

Index

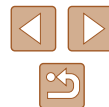

## Playback on a Standard-Definition TV

▶ Still Images ▶ Movies

Connecting the camera to a TV with the Stereo AV Cable AVC-DC400ST (sold separately) enables you to view your shots on the larger screen of the TV as you control the camera.

### 1 Make sure the camera and TV are off.

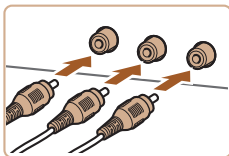

### 2 Connect the camera to the TV.

- On the TV, insert the cable plugs fully into the video inputs as shown.
- Make sure the cable plugs are in video inputs of the same color.
- On the camera, open the terminal cover and insert the cable plug fully into the camera terminal.

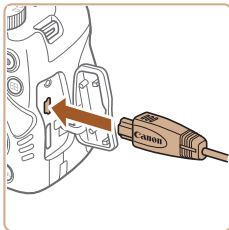

### 3 Display images.

- Follow steps 3 – 4 in “Playback on a High-Definition TV” (157) to display images.



- Correct display is not possible unless the camera video output format (NTSC or PAL) matches the TV format. To change the video output format, press the **[MENU]** button and choose [Video System] on the **[↑]** tab.



- When the camera and TV are connected, you can also shoot while previewing shots on the larger screen of the TV. To shoot, follow the same steps as when using the camera screen. However, AF-Point Zoom (154), MF-Point Zoom (179) and MF Peaking (180) are not available.

## Powering the Camera with Household Power

▶ Still Images ▶ Movies

Powering the camera with AC Adapter Kit ACK-DC80 (sold separately) eliminates the need to monitor the remaining battery level.

### 1 Make sure the camera is off.

### 2 Open the cover.

- Follow step 1 in “Inserting the Battery Pack and Memory Card” (19) to open the memory card/battery cover, and then open the coupler cable port cover as shown.

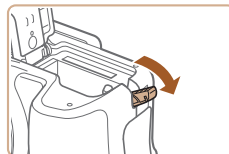

### 3 Connect the adapter to the coupler.

- Insert the adapter plug fully into the coupler.

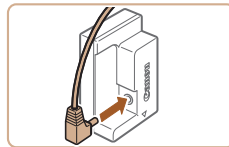

Before Use

Basic Guide

Advanced Guide

1 Camera Basics

2 Auto Mode / Hybrid Auto Mode

3 Other Shooting Modes

4 P Mode

5 Tv, Av, M, C1, and C2 Mode

6 Playback Mode

7 Wi-Fi Functions

8 Setting Menu

9 Accessories

10 Appendix

Index



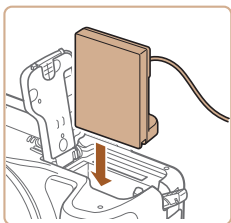

#### 4 Insert the coupler.

- Insert the coupler as shown until it locks into place.

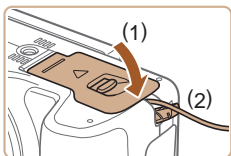

- Lower the cover (1), keeping the coupler cable in the coupler cable port (2).

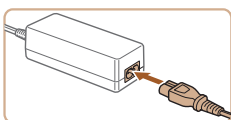

#### 5 Connect the power cord.

- Insert one end of the power cord into the compact power adapter, and then plug the other end into a power outlet.
- Turn the camera on and use it as desired.
- When finished, turn the camera off and unplug the power cord from the outlet.



- Do not disconnect the adapter or unplug the power cord while the camera is still on. This may erase your shots or damage the camera.
- Do not attach the adapter or adapter cord to other objects. Doing so could result in malfunction or damage to the product.

## Using an External Microphone

An external microphone with a mini plug (3.5 mm diameter) can be connected to the external microphone IN terminal (📖3) for use in recording. Note that the built-in microphone is not used for recording when an external microphone is connected.

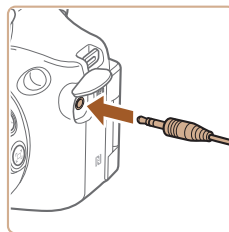

**Open the cover and connect the external microphone.**



- Any attenuator settings you have configured are also applied to recording with the external microphone (📖69).
- Connecting an external microphone will deactivate [Wind Filter] (📖69).

Before Use

Basic Guide

Advanced Guide

**1** Camera Basics

**2** Auto Mode / Hybrid Auto Mode

**3** Other Shooting Modes

**4** P Mode

**5** Tv, Av, M, C1, and C2 Mode

**6** Playback Mode

**7** Wi-Fi Functions

**8** Setting Menu

**9** Accessories

**10** Appendix

Index

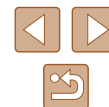

## Using a Lens Hood (Sold Separately)

► Still Images ► Movies

For wide-angle shots of backlit subjects without using the flash, attach optional Lens Hood LH-DC90 to prevent light outside the angle of view from entering the lens.

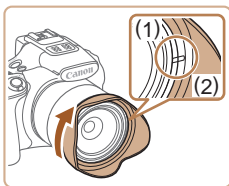

- Make sure the camera is off.
- Align the lens hood mark (2) with the camera mark (1), and turn the lens hood in the direction of the arrow until it locks in place.
- To remove the lens hood, turn it in the opposite direction.

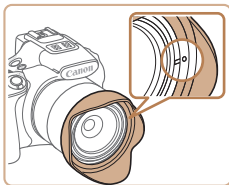

- To attach the lens hood inverted (as shown) when the hood is not used, align the lens hood mark (2) with the camera mark (1), and turn the lens hood in the direction of the arrow until it locks in place.

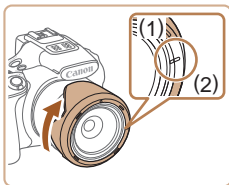

- Vignetting may occur if you use the built-in flash when the lens hood is attached.



- The filter adapter and a lens hood cannot be attached to the camera at the same time.

## Using Lens Filters (Sold Separately)

► Still Images ► Movies

Attaching a lens filter to the camera protects the lens and allows you to shoot with various effects. To attach a lens filter, you will need Filter Adapter FA-DC67A (sold separately).

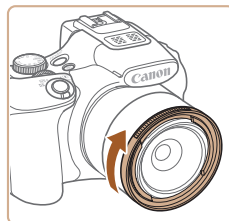

### 1 Attach the filter adapter.

- Make sure the camera is off.
- Align the notches on the camera and the filter adapter and turn the adapter in the direction of the arrow until locked.
- To remove the filter adapter, turn it in the opposite direction.

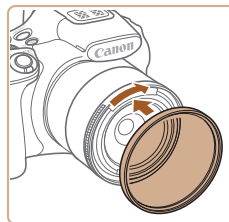

### 2 Attach a filter.

- Turn the filter in the direction of the arrow to attach it to the camera.
- Make sure not to attach the filter too tightly. Doing so could prevent removal of the filter and damage the camera.



- We recommend the use of genuine Canon filters (67 mm dia.).
- When not using auto focus to shoot, set the manual focus option [Safety MF] to [On].
- If you use the built-in flash with the filter adapter attached, portions of the image may appear darker.
- When using the filter adapter, be sure to use only one filter at a time. Attaching multiple filters, or accessories such as a heavy lens, may cause the attachments to fall off and become damaged.
- Do not grip the filter adapter tightly.
- Remove the filter adapter when not using a filter.

Before Use

Basic Guide

Advanced Guide

1 Camera Basics

2 Auto Mode / Hybrid Auto Mode

3 Other Shooting Modes

4 P Mode

5 Tv, Av, M, C1, and C2 Mode

6 Playback Mode

7 Wi-Fi Functions

8 Setting Menu

9 Accessories

10 Appendix

Index







- The filter adapter and a lens hood cannot be attached to the camera at the same time.

## Using a Remote Switch (Sold Separately)

► Still Images ► Movies

An optional Remote Switch RS-60E3 can be used to avoid camera shake that may otherwise occur when pressing the shutter button directly. This optional accessory is convenient when shooting at slow shutter speeds.

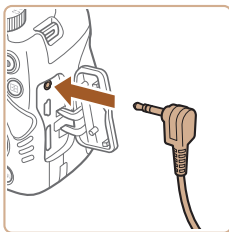

### 1 Connect the remote switch.

- Make sure the camera is off.
- Open the terminal cover and insert the remote switch plug.

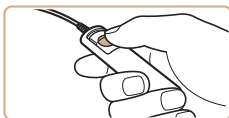

### 2 Shoot.

- To shoot, press the release button on the remote switch.



- Bulb photography (long exposures) is not supported.

## Using an External Flash (Sold Separately)

► Still Images ► Movies

More sophisticated flash photography is possible with an optional Speedlite EX series flash. For movie shooting using an LED light, the optional Speedlite 320EX flash is available.



- This camera does not support some Speedlite EX series functions.
- Wireless operation of the Speedlite 600EX-RT is not supported.
- Non-EX series Canon flash units may not fire correctly or may not fire at all, in some cases.
- Use of non-Canon flash units (especially high-voltage flash units) or flash accessories may prevent normal camera operation and may damage the camera.



- Also refer to the Speedlite EX series manual for additional information.

## Speedlite EX Series

► Still Images ► Movies

These optional flash units can provide bright lighting and meet a variety of flash photography needs.

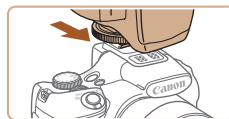

### 1 Attach the flash.

- Make sure the camera is off, and then attach the flash unit to the hot shoe.

Before Use

Basic Guide

Advanced Guide

1 Camera Basics

2 Auto Mode / Hybrid Auto Mode

3 Other Shooting Modes

4 P Mode

5 Tv, Av, M, C1, and C2 Mode

6 Playback Mode

7 Wi-Fi Functions

8 Setting Menu

9 Accessories

10 Appendix

Index



## 2 Turn the flash on, and then turn the camera on.







- A red  icon is now displayed.
- The flash pilot lamp will light up when the flash is ready.

## 3 Choose shooting mode [P], [Tv], [Av], or [M].



- Flash settings can only be configured in these modes. In other modes, the flash is adjusted and fired automatically, as needed.

## 4 Set the white balance to (76).

## 5 Configure the external flash.

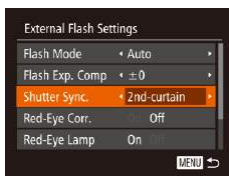
- Press the [MENU] button, choose [Flash Control] on the  tab, and then press the  button.
- Options already set on the flash itself are displayed.
- Press the [][] buttons to choose an item, and then press the [][] buttons to adjust the setting.
- Available items vary depending on the shooting mode and the flash attached ( 163).



- Settings for the built-in flash cannot be configured while a Speedlite EX series flash is attached, because that setting screen is no longer accessible.
- You can also access the setting screen by pressing the [] button for at least one second.
- Flash settings in  shooting mode can be configured just as they are in [P] mode.
- 600EX-RT/580EX II only: [Flash Control] is not available if the external flash has been set up for stroboscopic flash.
- 320EX only: Auto LED lighting is only available in low-light movie recording or in Movie mode. In this case, the  icon is shown.

## ■ Using Speedlite Bracket SB-E2 (Sold Separately)

▶ Still Images ▶ Movies

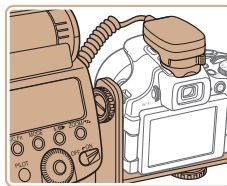

- Using the optional Speedlite Bracket SB-E2 can help prevent unnatural shadows next to subjects during vertical shooting.
- To keep the LCD screen out of the way of the bracket, use the screen closed and facing outward.

Before Use

Basic Guide

Advanced Guide

1 Camera Basics

2 Auto Mode / Hybrid Auto Mode

3 Other Shooting Modes

4 P Mode

5 Tv, Av, M, C1, and C2 Mode

6 Playback Mode

7 Wi-Fi Functions

8 Setting Menu

9 Accessories

10 Appendix

Index

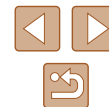

## Camera Settings Available with an External Flash (Sold Separately)

► Still Images ► Movies

The following items are available in **[P]**, **[Tv]**, **[Av]**, or **[M]** mode. In other shooting modes, only [Red-Eye Corr.] and [Red-Eye Lamp] can be configured. (With autoflash control, the flash always fires.) However, external flash units do not fire in modes that the built-in flash does not fire (182).

Item	Options	Shooting Mode			
		P	Tv	Av	M
Flash Mode	Auto*1	○	○	○	–
	Manual*2	○	○	○	○
Flash Exp. Comp*3	–3 to +3	○	○	○	–
Flash Output*4	1/128*5 to 1/1 (in 1/3-stop increments)	○	○	○	○
Shutter Sync.	1st-curtain/2nd-curtain/Hi-speed	○	○	○	○
	On	○	○	○	○
Slow Synchro	Off	○	–	○	–
	On/Off	○	○	○	○
Wireless Func.*6	On/Off	○	○	○	○
Red-Eye Corr.	On/Off	○	○	○	○
Red-Eye Lamp	On/Off	○	○	○	○
Safety FE*7	On	○	○	○	–
	Off	○	○	○	○
Clear Flash Settings*8		○	○	○	○

\*1 E-TTL mode is used for the flash.

\*2 M mode is used for the flash.

In **[M]** shooting mode, E-TTL mode is also available for the flash. In this case, when the flash fires, flash exposure compensation set on the flash is applied to the flash output level set on the camera.

- \*3 Can be configured only when [Flash Mode] is [Auto] and flash exposure compensation set on the flash is [+0]. When you adjust flash exposure compensation on 600EX-RT, 600EX, 580EX II, or 430EX II Speedlites, the camera display will be updated accordingly.
- \*4 Can be configured when [Flash Mode] is [Manual]. Linked to settings on the flash unit.
- \*5 1/64 for Speedlite 430EX II/430EX/320EX/270EX II/270EX.
- \*6 For options other than On/Off, configure the setting on the flash unit itself. Not available with Speedlite 430EX II/320EX/270EX II/270EX. When this item is set to [On], [Shutter Sync.] cannot be set to [2nd-curtain]. (If [Shutter Sync.] is set to [2nd-curtain], it will be changed to [1st-curtain].)
- \*7 Can only be configured when [Flash Mode] is [Auto].
- \*8 Restores all default settings. You can also restore defaults for [Slow Synchro], [Safety FE], [Red-Eye Corr.], and [Red-Eye Lamp] by using [Reset All] on the **[↑]** tab on the camera (152).



- Flash settings in **[S]** shooting mode can be configured just as they are in **[P]** mode.
- In **[AUTO]** shooting mode, icons representing Smiling, Sleeping, Babies (Smiling), Babies (Sleeping), and Children shooting scenes determined by the camera are not displayed, and the camera does not shoot continuously (38).

Before Use
Basic Guide
Advanced Guide
<b>1</b> Camera Basics
<b>2</b> Auto Mode / Hybrid Auto Mode
<b>3</b> Other Shooting Modes
<b>4</b> P Mode
<b>5</b> Tv, Av, M, C1, and C2 Mode
<b>6</b> Playback Mode
<b>7</b> Wi-Fi Functions
<b>8</b> Setting Menu
<b>9</b> Accessories
<b>10</b> Appendix
Index



## Using the Software

The software available for download from the Canon website is introduced below, with instructions for installation and saving images to a computer.

### Software

After downloading the software from the Canon website and installing it, you can do the following things on your computer.

- CameraWindow
  - Import images and change camera settings
- ImageBrowser EX
  - Manage images: view, search, and organize
  - Print and edit images
- Digital Photo Professional
  - Browse, process and edit RAW images



- Internet access is required, and any ISP account charges and access fees must be paid separately.

### Software Instruction Manual

Refer to the instruction manual when using the software. The manual can be accessed from the help system of software (some software excluded).

## Computer Connections via a Cable

### Checking Your Computer Environment

The software can be used on the following computers. For detailed system requirements and compatibility information, including support in new operating systems, visit the Canon website.

Operating System*	Windows	Mac OS
	Windows 8/8.1 Windows 7 SP1	Mac OS X 10.9 Mac OS X 10.8

\* When sending images to a computer via Wi-Fi, check the system requirements in “Checking Your Computer Environment” (127).



- Check the Canon website for the latest system requirements, including supported OS versions.

### Installing the Software

For software installation instructions, see “Installing the Software” (127).

Before Use

Basic Guide

Advanced Guide

**1** Camera Basics

**2** Auto Mode / Hybrid Auto Mode

**3** Other Shooting Modes

**4** P Mode

**5** Tv, Av, M, C1, and C2 Mode

**6** Playback Mode

**7** Wi-Fi Functions

**8** Setting Menu

**9** Accessories

**10** Appendix

Index



## Saving Images to a Computer

Windows 7 and Mac OS X 10.8 are used here for the sake of illustration. For other functions, refer to the help system of the relevant software (some software excluded).

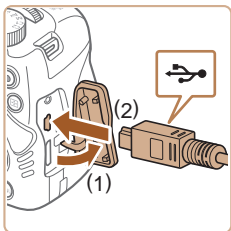

### 1 Connect the camera to the computer.

- With the camera turned off, open the cover (1). With the smaller plug of the USB cable in the orientation shown, insert the plug fully into the camera terminal (2).

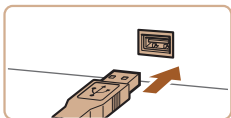

- Insert the larger plug of the USB cable in the computer's USB port. For details about USB connections on the computer, refer to the computer user manual.

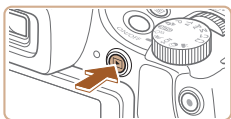

### 2 Turn the camera on to access CameraWindow.

- Press the [▶] button to turn the camera on.
- Mac OS: CameraWindow is displayed when a connection is established between the camera and computer.
- Windows: Follow the steps introduced below.
- In the screen that displays, click the  link to modify the program.

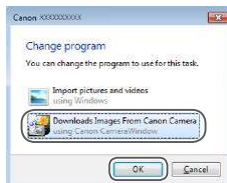

- Choose [Downloads Images From Canon Camera] and then click [OK].

- Double-click .

### 3 Save the images to the computer.

- Click [Import Images from Camera], and then click [Import Untransferred Images].
- Images are now saved to the Pictures folder on the computer, in separate folders named by date.
- After images are saved, close CameraWindow, press the [▶] button to turn the camera off, and unplug the cable.
- For instructions on viewing images on a computer, refer to "Software Instruction Manual" (164).

Before Use

Basic Guide

Advanced Guide

1 Camera Basics

2 Auto Mode / Hybrid Auto Mode

3 Other Shooting Modes

4 P Mode

5 Tv, Av, M, C1, and C2 Mode

6 Playback Mode

7 Wi-Fi Functions

8 Setting Menu

9 Accessories

10 Appendix

Index

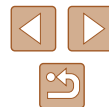



- Windows 7: If the screen in step 2 is not displayed, click the  icon in the taskbar.
- Mac OS: If CameraWindow is not displayed after step 2, click the [CameraWindow] icon in the Dock.
- Although you can save images to a computer simply by connecting your camera to the computer without using the software, the following limitations apply.
  - It may take a few minutes after you connect the camera to the computer until camera images are accessible.
  - Images shot in vertical orientation may be saved in horizontal orientation.
  - RAW images (or JPEG images recorded with RAW images) may not be saved.
  - Image protection settings may be cleared from images saved to a computer.
  - Some problems may occur when saving images or image information, depending on the operating system version, the software in use, or image file sizes.
  - Some functions provided by the software may not be available, such as movie editing.

## Printing Images

► Still Images ► Movies

Your shots can easily be printed by connecting the camera to a printer. On the camera, you can specify images to set up batch printing, prepare orders for photo development services, and prepare orders or print images for photobooks.

A Canon SELPHY CP series compact photo printer is used here for the sake of illustration. Screens displayed and available functions vary by printer. Also refer to the printer manual for additional information.

## Easy Print

► Still Images ► Movies

Easily print your shots by connecting the camera to a PictBridge-compatible printer (sold separately) with the USB cable.

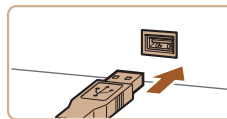
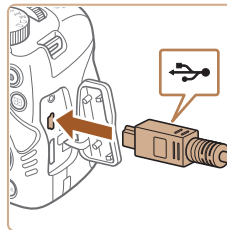

**1** Make sure the camera and printer are off.

**2** Connect the camera to the printer.

- Open the terminal cover. Holding the smaller cable plug in the orientation shown, insert the plug fully into the camera terminal.
- Connect the larger cable plug to the printer. For other connection details, refer to the printer manual.

Before Use

Basic Guide

Advanced Guide

**1** Camera Basics

**2** Auto Mode / Hybrid Auto Mode

**3** Other Shooting Modes

**4** P Mode

**5** Tv, Av, M, C1, and C2 Mode

**6** Playback Mode

**7** Wi-Fi Functions

**8** Setting Menu

**9** Accessories

**10** Appendix

Index





### 3 Turn the printer on.

### 4 Turn the camera on.

- Press the [ ] button to turn the camera on.

### 5 Choose an image.

- Press the [ ][ ] buttons to choose an image.

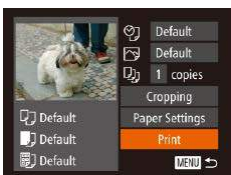

### 6 Print the image.

- Press the [ ] button.
- Press the [ ][ ] buttons to choose [Print], and then press the [ ] button.
- Printing now begins.
- To print other images, repeat the above procedures starting from step 5 after printing is finished.
- When you are finished printing, turn the camera and printer off and disconnect the cable.



- For Canon-brand PictBridge-compatible printers (sold separately), see "Printers" (156).
- RAW images cannot be printed.

## Configuring Print Settings

► Still Images ► Movies

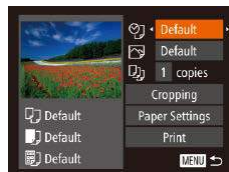

### 1 Access the printing screen.

- After following steps 1 – 5 in "Easy Print" (166) to choose an image, press the [ ] button to access this screen.

### 2 Configure the settings.

- Press the [ ][ ] buttons to choose an item, and then press the [ ][ ] buttons to choose an option.

🗨️	Default	Matches current printer settings.
	Date	Prints images with the date added.
	File No.	Prints images with the file number added.
	Both	Prints images with both the date and file number added.
🖨️	Off	–
	Default	Matches current printer settings.
	Off	–
	On	Uses information from the time of shooting to print under optimal settings.
	Red-Eye 1	Corrects red-eye.
📄	No. of Copies	Choose the number of copies to print.
Cropping	–	Specify a desired image area to print (168).
Paper Settings	–	Specify the paper size, layout, and other details (168).

Before Use

Basic Guide

Advanced Guide

1 Camera Basics

2 Auto Mode / Hybrid Auto Mode

3 Other Shooting Modes

4 P Mode

5 Tv, Av, M, C1, and C2 Mode

6 Playback Mode

7 Wi-Fi Functions

8 Setting Menu

9 Accessories

10 Appendix

Index



## Cropping Images before Printing

► Still Images ► Movies

By cropping images before printing, you can print a desired image area instead of the entire image.



### 1 Choose [Cropping].

- After following step 1 in “Configuring Print Settings” (167) to access the printing screen, choose [Cropping] and press the [MENU] button.
- A cropping frame is now displayed, indicating the image area to print.

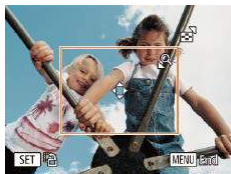

### 2 Adjust the cropping frame as needed.

- To resize the frame, move the zoom lever.
- To move the frame, press the [▲][▼][◀][▶] buttons.
- To rotate the frame, press the [⊞] button.
- Press the [MENU] button, press the [▲][▼] buttons to choose [OK], and then press the [⊞] button.

### 3 Print the image.

- Follow step 6 in “Easy Print” (166) to print.



- Cropping may not be possible at small image sizes, or at some aspect ratios.
- Dates may not be printed correctly if you crop images shot with [Date Stamp] selected.

## Choosing Paper Size and Layout before Printing

► Still Images ► Movies

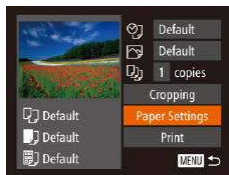

### 1 Choose [Paper Settings].

- After following step 1 in “Configuring Print Settings” (167) to access the printing screen, choose [Paper Settings] and press the [MENU] button.

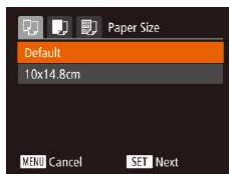

### 2 Choose a paper size.

- Press the [▲][▼] buttons to choose an option, and then press the [MENU] button.

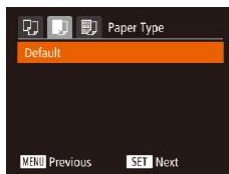

### 3 Choose a type of paper.

- Press the [▲][▼] buttons to choose an option, and then press the [MENU] button.

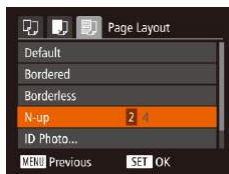

### 4 Choose a layout.

- Press the [▲][▼] buttons to choose an option.
- When choosing [N-up], press the [◀][▶] buttons to specify the number of images per sheet.
- Press the [MENU] button.

### 5 Print the image.

Before Use

Basic Guide

Advanced Guide

1 Camera Basics

2 Auto Mode / Hybrid Auto Mode

3 Other Shooting Modes

4 P Mode

5 Tv, Av, M, C1, and C2 Mode

6 Playback Mode

7 Wi-Fi Functions

8 Setting Menu

9 Accessories

10 Appendix

Index





## Available Layout Options

Default	Matches current printer settings.
Bordered	Prints with blank space around the image.
Borderless	Borderless, edge-to-edge printing.
N-up	Choose how many images to print per sheet.
ID Photo	Prints images for identification purposes. Only available for images with a resolution of L and an aspect ratio of 4:3.
Fixed Size	Choose the print size. Choose from 3.5 x 5 in., postcard, or wide-format prints.

## Printing ID Photos

▶ Still Images ▶ Movies

### 1 Choose [ID Photo].

- Following steps 1 – 4 in “Choosing Paper Size and Layout before Printing” (168), choose [ID Photo] and press the [MENU] button.



### 2 Choose the long and short side length.

- Press the [▲][▼] buttons to choose an item. Choose the length by pressing the [◀][▶] buttons, and then press the [MENU] button.

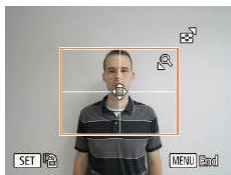

### 3 Choose the printing area.

- Follow step 2 in “Cropping Images before Printing” (168) to choose the printing area.

### 4 Print the image.

## Printing Movie Scenes

▶ Still Images ▶ Movies

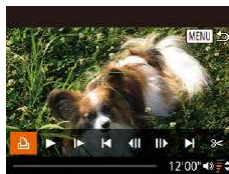

### 1 Access the printing screen.

- Follow steps 1 – 5 in “Easy Print” (166) to choose a movie, and then press the [MENU] button.
- Press the [◀][▶] buttons to choose [Print], and then press the [MENU] button. This screen is displayed.

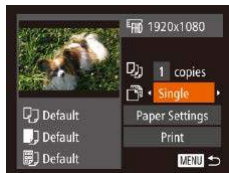

### 2 Choose a printing method.

- Press the [▲][▼] buttons to choose [Print], and then press the [◀][▶] buttons to choose the printing method.

### 3 Print the image.

## Movie Printing Options

Single	Prints the current scene as a still image.
Sequence	Prints a series of scenes, a certain interval apart, on a single sheet of paper. You can also print the folder number, file number, and elapsed time for the frame by setting [Caption] to [On].



- To cancel printing in progress, press the [MENU] button, choose [OK], and then press the [MENU] button again.
- [ID Photo] and [Sequence] cannot be chosen on Canon-brand PictBridge-compatible printers from CP720/CP730 and earlier models.

Before Use

Basic Guide

Advanced Guide

1 Camera Basics

2 Auto Mode / Hybrid Auto Mode

3 Other Shooting Modes

4 P Mode

5 Tv, Av, M, C1, and C2 Mode

6 Playback Mode

7 Wi-Fi Functions

8 Setting Menu

9 Accessories

10 Appendix

Index



## Adding Images to the Print List (DPOF)

► Still Images ► Movies

Batch printing (📖172) and ordering prints from a photo development service can be set up on the camera. Choose up to 998 images on a memory card and configure relevant settings, such as the number of copies, as follows. The printing information you prepare this way will conform to DPOF (Digital Print Order Format) standards.



- RAW images cannot be included in print list.

## Configuring Print Settings

► Still Images ► Movies

Specify the printing format, whether to add the date or file number, and other settings as follows. These settings apply to all images in the print list.



- Press the [MENU] button, and then choose [Print Settings] on the [D] tab. Choose and configure items as desired (📖30).

Print Type	Standard	One image is printed per sheet.
	Index	Smaller versions of multiple images are printed per sheet.
	Both	Both standard and index formats are printed.
Date	On	Images are printed with the shooting date.
	Off	–
File No.	On	Images are printed with the file number.
	Off	–
Clear DPOF data	On	All image print list settings are cleared after printing.
	Off	–



- Not all of your DPOF settings may be applied in printing by the printer or photo development service, in some cases.
- [!] may be displayed on the camera to warn you that the memory card has print settings that were configured on another camera. Changing the print settings using this camera may overwrite all previous settings.
- Setting [Date] to [On] may cause some printers to print the date twice.



- Specifying [Index] will prevent you from choosing [On] for both [Date] and [File No.] at the same time.
- Index printing is not available on some Canon-brand PictBridge-compatible printers (sold separately).
- The date is printed in a format matching setting details in [Date/Time] on the [T] tab (📖20).

Before Use

Basic Guide

Advanced Guide

**1** Camera Basics

**2** Auto Mode / Hybrid Auto Mode

**3** Other Shooting Modes

**4** P Mode

**5** Tv, Av, M, C1, and C2 Mode

**6** Playback Mode

**7** Wi-Fi Functions

**8** Setting Menu

**9** Accessories

**10** Appendix

Index



## Setting Up Printing for Individual Images

▶ Still Images ▶ Movies

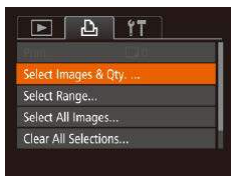

### 1 Choose [Select Images & Qty.].

- Press the [MENU] button, choose [Select Images & Qty.] on the [DISP] tab, and then press the [OK] button.

### 2 Choose an image.

- Press the [◀][▶] buttons to choose an image, and then press the [OK] button.
- You can now specify the number of copies.
- If you specify index printing for the image, it is labeled with a [✓] icon. To cancel index printing for the image, press the [OK] button again. [✓] is no longer displayed.

### 3 Specify the number of prints.

- Press the [▲][▼] buttons to specify the number of prints (up to 99).
- To set up printing for other images and specify the number of prints, repeat steps 2 – 3.
- Printing quantity cannot be specified for index prints. You can only choose which images to print, by following step 2.
- When finished, press the [MENU] button to return to the menu screen.



## Setting Up Printing for a Range of Images

▶ Still Images ▶ Movies



- Following step 1 in “Setting Up Printing for Individual Images” (📖171), choose [Select Range] and press the [OK] button.
- Follow steps 2 – 3 in “Selecting a Range” (📖111) to specify images.
- Press the [▲][▼] buttons to choose [Order], and then press the [OK] button.

## Setting Up Printing for All Images

▶ Still Images ▶ Movies

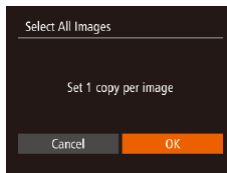

- Following step 1 in “Setting Up Printing for Individual Images” (📖171), choose [Select All Images] and press the [OK] button.
- Press the [◀][▶] buttons to choose [OK], and then press the [OK] button.

## Clearing All Images from the Print List

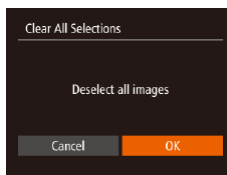

- Following step 1 in “Setting Up Printing for Individual Images” (📖171), choose [Clear All Selections] and press the [OK] button.
- Press the [◀][▶] buttons to choose [OK], and then press the [OK] button.

Before Use

Basic Guide

Advanced Guide

1 Camera Basics

2 Auto Mode / Hybrid Auto Mode

3 Other Shooting Modes

4 P Mode

5 Tv, Av, M, C1, and C2 Mode

6 Playback Mode

7 Wi-Fi Functions

8 Setting Menu

9 Accessories

10 Appendix

Index



## Printing Images Added to the Print List (DPOF)

► Still Images ► Movies



- When images have been added to the print list (170 – 171), this screen is displayed after you connect the camera to a PictBridge-compatible printer. Press the [▲][▼] buttons to choose [Print now], and then simply press the [OK] button to print the images in the print list.
- Any DPOF print job that you temporarily stop will be resumed from the next image.

## Adding Images to a Photobook

► Still Images ► Movies

Photobooks can be set up on the camera by choosing up to 998 images on a memory card and importing them into the software on your computer, where they are stored in their own folder. This is convenient when ordering printed photobooks online or printing photobooks with your own printer.

### Choosing a Selection Method

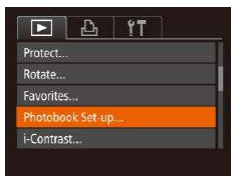

- Press the [MENU] button, choose [Photobook Set-up] on the [▶] tab, and then choose how you will select images.



- [!] may be displayed on the camera to warn you that the memory card has print settings that were configured on another camera. Changing the print settings using this camera may overwrite all previous settings.



- After importing images to your computer, also refer to “Software Instruction Manual” (164) and the printer manual for further information.

## Adding Images Individually

► Still Images ► Movies

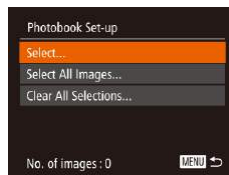

### 1 Choose [Select].

- Following the procedure in “Choosing a Selection Method” (172), choose [Select] and press the [OK] button.

### 2 Choose an image.

- Press the [◀][▶] buttons to choose an image, and then press the [OK] button.
- [✓] is displayed.
- To remove the image from the photobook, press the [OK] button again. [✓] is no longer displayed.
- Repeat this process to specify other images.
- When finished, press the [MENU] button to return to the menu screen.

Before Use
Basic Guide
Advanced Guide
1 Camera Basics
2 Auto Mode / Hybrid Auto Mode
3 Other Shooting Modes
4 P Mode
5 Tv, Av, M, C1, and C2 Mode
6 Playback Mode
7 Wi-Fi Functions
8 Setting Menu
9 Accessories
10 Appendix
Index



## Adding All Images to a Photobook

► Still Images ► Movies

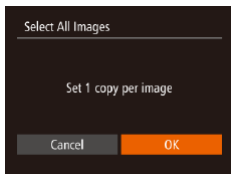

- Following the procedure in “Choosing a Selection Method” (172), choose [Select All Images] and press the [OK] button.
- Press the [◀][▶] buttons to choose [OK], and then press the [OK] button.

## Removing All Images from a Photobook

► Still Images ► Movies

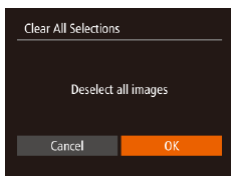

- Following the procedure in “Choosing a Selection Method” (172), choose [Clear All Selections] and press the [OK] button.
- Press the [◀][▶] buttons to choose [OK], and then press the [OK] button.

Before Use

Basic Guide

Advanced Guide

**1** Camera Basics

**2** Auto Mode / Hybrid Auto Mode

**3** Other Shooting Modes

**4** P Mode

**5** Tv, Av, M, C1, and C2 Mode

**6** Playback Mode

**7** Wi-Fi Functions

**8** Setting Menu

**9** Accessories

**10** Appendix

Index



# 10

## Appendix

Helpful information when using the camera

### Troubleshooting

If you think there is a problem with the camera, first check the following. If the items below do not solve your problem, contact a Canon Customer Support Help Desk.

#### Power

Nothing happens when the power button is pressed.

- Confirm that the battery pack is charged (18).
- Confirm that the battery pack is inserted facing the correct way (19).
- Confirm that the memory card/battery cover is fully closed (19).
- Dirty battery terminals reduce battery performance. Try cleaning the terminals with a cotton swab and reinserting the battery pack a few times.

The battery pack runs out of power quickly.

- Battery performance decreases at low temperatures. Try warming the battery pack a little by putting it in your pocket, for example, ensuring that the terminals do not touch any metal objects.
- Dirty battery terminals reduce battery performance. Try cleaning the terminals with a cotton swab and reinserting the battery pack a few times.
- If these measures do not help and the battery pack still runs out of power soon after charging, it has reached the end of its life. Purchase a new battery pack.

The lens is not retracted.

- Do not open the memory card/battery cover while the camera is on. Close the cover, turn the camera on, and then turn it off again (19).

The battery pack is swollen.

- Battery swelling is normal and does not pose any safety concerns. However, if battery swelling prevents the battery pack from fitting in the camera, contact a Canon Customer Support Help Desk.

#### Display on a TV

Camera images look distorted or not displayed on a TV (157).

Before Use

Basic Guide

Advanced Guide

1 Camera Basics

2 Auto Mode /  
Hybrid Auto Mode

3 Other Shooting Modes

4 P Mode

5 Tv, Av, M, C1, and C2 Mode

6 Playback Mode

7 Wi-Fi Functions

8 Setting Menu

9 Accessories

10 Appendix

Index

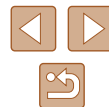

## Shooting

Cannot shoot.

- In Playback mode (📖101), press the shutter button halfway (📖26).

Nothing is displayed (📖36).

Strange display on the screen under low light (📖28).

Strange display on the screen when shooting.

- Note that the following display problems are not recorded in still images but are recorded in movies.
  - The screen may flicker and horizontal banding may appear under fluorescent or LED lighting.

No date stamp is added to images.

- Configure the [Date Stamp] (📖20) setting (📖20). Note that date stamps are not added to images automatically, merely because you have configured the [Date/Time] setting (📖45).
- Date stamps are not added in shooting modes (📖187) in which this setting cannot be configured (📖45).

⚡ flashes on the screen when the shutter button is pressed, and shooting is not possible (📖36).

📷 is displayed when the shutter button is pressed halfway (📖36).

- Set [IS Mode] to [Continuous] (📖90).
- Raise the flash and set the flash mode to ⚡ (📖86).
- Increase the ISO speed (📖73).
- Mount the camera on a tripod or take other measures to keep it still. Additionally, you should set [IS Mode] to [Off] when using a tripod or other means to secure the camera (📖90).

Shots are out of focus.

- Press the shutter button halfway to focus on subjects before pressing it all the way down to shoot (📖26).
- Make sure subjects are within focusing range (📖198).
- Set [AF-assist Beam] to [On] (📖55).
- Confirm that unneeded functions such as macro are deactivated.
- Try shooting with focus lock or AF lock (📖82, 📖85).

No AF frames are displayed and the camera does not focus when the shutter button is pressed halfway.

- To have AF frames displayed and the camera focus correctly, try composing the shot with higher-contrast subject areas centered before you press the shutter button halfway. Otherwise, try pressing the shutter button halfway repeatedly.

Subjects in shots look too dark.

- Raise the flash and set the flash mode to ⚡ (📖86).
- Adjust brightness by using exposure compensation (📖72).
- Adjust contrast by using i-Contrast (📖75, 📖118).
- Use AE lock or spot metering (📖72).

Subjects look too bright, highlights are washed-out.

- Lower the flash and set the flash mode to ☀️ (📖33).
- Adjust brightness by using exposure compensation (📖72).
- Use AE lock or spot metering (📖72).
- Reduce the lighting on subjects.

Shots look too dark despite the flash firing (📖36).

- Shoot within flash range (📖198).
- Adjust brightness by using flash exposure compensation or changing the flash output level (📖87, 📖94).
- Increase the ISO speed (📖73).

Subjects in flash shots look too bright, highlights are washed-out.

- Shoot within flash range (📖198).
- Lower the flash and set the flash mode to ☀️ (📖33).
- Adjust brightness by using flash exposure compensation or changing the flash output level (📖87, 📖94).

White spots appear in flash shots.

- This is caused by light from the flash reflecting off dust or airborne particles.

Shots look grainy.

- Lower the ISO speed (📖73).
- High ISO speeds in some shooting modes may cause grainy images (📖59).

Subjects are affected by red-eye (📖52).

- Set [Red-Eye Lamp] to [On] (📖55). The red-eye reduction lamp (📖3) will be activated in flash shots. For best results, have subjects look at the red-eye reduction lamp. Also try increasing the lighting in indoor scenes and shooting at closer range.
- Edit images using red-eye correction (📖119).

Recording to the memory card takes too long, or continuous shooting is slower.

- Use the camera to perform low-level formatting of the memory card (📖149).

Shooting settings or FUNC. menu settings are not available.

- Available setting items vary by shooting mode. Refer to "Functions Available in Each Shooting Mode", "FUNC. Menu", and "Shooting Tab" (📖182 – 📖187).

Before Use

Basic Guide

Advanced Guide

1 Camera Basics

2 Auto Mode / Hybrid Auto Mode

3 Other Shooting Modes

4 P Mode

5 Tv, Av, M, C1, and C2 Mode

6 Playback Mode

7 Wi-Fi Functions

8 Setting Menu

9 Accessories

10 Appendix

Index



The Babies or Children icon does not display.

- The Babies and Children icons will not display if the birthday is not set in face information (147). If the icons still do not display even when you set the birthday, re-register face information (147), or make sure that the date/time are set correctly (146).

## Shooting Movies

The elapsed time shown is incorrect, or recording is interrupted.

- Use the camera to format the memory card, or switch to a card that supports high-speed recording. Note that even if the elapsed time display is incorrect, the length of movies on the memory card corresponds to the actual recording time (148, 198).

**[!]** is displayed and shooting stops automatically.

- The camera's internal memory buffer filled up as the camera could not record to the memory card quickly enough. Try one of the following measures.
  - Use the camera to perform low-level formatting of the memory card (149).
  - Lower the image quality (53).
  - Switch to a memory card that supports high-speed recording (198).

Zooming is not possible.

- Zooming is not possible when shooting movies in [62] (62) and [70] (70) modes.

Subjects look distorted.

- Subjects that pass in front of the camera quickly may look distorted. This is not a malfunction.

## Playback

Playback is not possible.

- Image or movie playback may not be possible if a computer is used to rename files or alter the folder structure. Refer to "Software Instruction Manual" (164) for details on folder structure and file names.

Playback stops, or audio skips.

- Switch to a memory card that you have performed low-level formatting on with the camera (149).
- There may be brief interruptions when playing movies copied to memory cards that have slow read speeds.
- When movies are played on a computer, frames may be dropped and audio may skip if computer performance is inadequate.

Sound is not played during movies.

- Adjust the volume (145) if you have activated [Mute] (145) or the sound in the movie is faint.
- No sound is played for movies shot in [62] (62) or [70] (70) mode, or when [Sound rec.] is set to [Disable] (37), because audio is not recorded.

## Memory Card

The memory card is not recognized.

- Restart the camera, with the memory card in it (25).

## Computer

Cannot transfer images to a computer.

- When attempting to transfer images to the computer via a cable, try reducing the transfer speed as follows.
  - Press the [ ] button to enter Playback mode. Hold the [MENU] button down as you press the [▲] and [ ] buttons at the same time. On the next screen, press the [◀][▶] buttons to choose [B], and then press the [ ] button.

## Wi-Fi

Cannot access the Wi-Fi menu by pressing the [▲] button.

- The Wi-Fi menu is not available in Shooting mode. Switch to Playback mode and try again.
- In Playback mode, the Wi-Fi menu cannot be accessed during detailed information display, magnified display, or index display. Switch to single-image display and a viewing mode other than detailed information display. Similarly, the Wi-Fi menu cannot be accessed during group playback or filtered image display according to specified conditions. Cancel group or filtered image playback.
- The Wi-Fi menu cannot be accessed while the camera is connected to a printer, computer, or TV via a cable. Disconnect the cable.
- [Ⓜ] will not be displayed even in playback mode, when using magnified display or index display. Switch to single-image display and try again. [Ⓜ] will also not be displayed when an image is displayed by specifying search conditions. Cancel filtered image playback.
- [Ⓜ] will not be displayed when the camera is connected to a printer or computer with a cable. Disconnect the cable.

Before Use

Basic Guide

Advanced Guide

1 Camera Basics

2 Auto Mode / Hybrid Auto Mode

3 Other Shooting Modes

4 P Mode

5 Tv, Av, M, C1, and C2 Mode

6 Playback Mode

7 Wi-Fi Functions

8 Setting Menu

9 Accessories

10 Appendix

Index





#### Cannot add a device/destination.

- A total of 20 items of connection information can be added to the camera. Erase unneeded connection information from the camera first, and then add new devices/destinations (📖143).
- Use a computer or smartphone to register Web services (📖133).
- To add a smartphone, first install the dedicated application CameraWindow on your smartphone (📖123).
- To add a computer, first install the software CameraWindow on your computer. Also check your computer and Wi-Fi environment and settings (📖127, 📖129).
- Do not use the camera near sources of Wi-Fi signal interference, such as microwave ovens, Bluetooth devices, or other equipment operating on the 2.4 GHz band.
- Bring the camera closer to the other device you are trying to connect to (such as the access point), and make sure there are no objects between the devices.

#### Cannot connect to the access point.

- Confirm that the access point channel is set to a channel supported by the camera (📖196). Note that instead of auto channel assignment, it is advisable to specify a supported channel manually.

#### Cannot send images.

- The destination device has insufficient storage space. Increase the storage space on the destination device and resend the images.
- The write-protect tab of the memory card in the destination camera is set to the locked position. Slide the write-protect tab to the unlocked position.
- RAW images cannot be sent. In [RAW] mode, only the JPEG images are sent. However, RAW images can be sent using Image Sync.
- Images are not sent to CANON iMAGE GATEWAY or other Web services if you move or rename image files or folders on the computer that received images sent using Image Sync via an access point (📖139). Before moving or renaming these image files or folders on the computer, make sure the images have already been sent to CANON iMAGE GATEWAY or other Web services.

#### Cannot resize images for sending.

- Images cannot be resized to be bigger than the resolution setting of their original size.
- Movies cannot be resized.

#### Images take a long time to send./The wireless connection is disrupted.

- Multiple images may take a long time to send. Try resizing the image to [M2] or [S1] to reduce sending time (📖139).
- Movies may take a long time to send.
- Do not use the camera near sources of Wi-Fi signal interference, such as microwave ovens, Bluetooth devices, or other equipment operating on the 2.4 GHz band. Note that images may take a long time to send even when [T.II] is displayed.
- Bring the camera closer to the other device you are trying to connect to (such as the access point), and make sure there are no objects between the devices.

#### Want to erase Wi-Fi connection information before disposing of the camera or giving it to someone else.

- Reset the Wi-Fi settings (📖144).

Before Use
Basic Guide
Advanced Guide
<b>1</b> Camera Basics
<b>2</b> Auto Mode / Hybrid Auto Mode
<b>3</b> Other Shooting Modes
<b>4</b> P Mode
<b>5</b> Tv, Av, M, C1, and C2 Mode
<b>6</b> Playback Mode
<b>7</b> Wi-Fi Functions
<b>8</b> Setting Menu
<b>9</b> Accessories
<b>10</b> Appendix
Index



## On-Screen Messages

If an error message is displayed, respond as follows.

### Capture or Playback

#### No memory card

- The memory card may be inserted facing the wrong way. Reinsert the memory card facing the correct way (119).

#### Memory card locked

- The write-protect tab of the memory card is set to the locked position. Switch the write-protect tab to the unlocked position (119).

#### Cannot record!

- Shooting was attempted without a memory card in the camera. To shoot, insert a memory card facing the correct way (119).

#### Memory card error (119)

- If the same error message is displayed even after you have formatted a supported memory card (112) and have inserted it facing the correct way (119), contact a Canon Customer Support Help Desk.

#### Insufficient space on card

- There is not enough free space on the memory card to shoot (133, 157, 171, 192) or edit images (116). Either erase unneeded images (112) or insert a memory card with enough free space (119).

#### Charge the battery (118)

#### No Image.

- The memory card does not contain any images that can be displayed.

#### Protected! (110)

#### Unidentified Image/Incompatible JPEG/Image too large./Cannot play back MOV

- Unsupported or corrupt images cannot be displayed.
- It may not be possible to display images that were edited or renamed on a computer, or images shot with another camera.

#### Cannot magnify!/Cannot play back this content in Smart Shuffle/Cannot rotate/Cannot modify image/Cannot modify/Cannot assign to category/Unselectable image./No identification information

- The following functions may be unavailable for images that were renamed or already edited on a computer, or images shot with another camera. Note that starred (\*) functions are not available for movies. Edit ID Info\* (107), Magnify\* (108), Smart Shuffle\* (110), Rotate\* (114), Favorites (115), Edit\* (116), Print List\* (170), and Photobook Set-up\* (172).

#### Invalid selection range

- When specifying a range for image selection (111, 113, 171), you attempted to choose an initial image that was after the final image, or vice-versa.

#### Exceeded selection limit

- More than 998 images were selected for Print List (170) or Photobook Set-up (172). Choose 998 images or less.
- Print List (170) or Photobook Set-up (172) settings could not be saved correctly. Reduce the number of selected images and try again.
- You attempted to choose more than 500 images in Protect (110), Erase (112), Favorites (115), Print List (170), or Photobook Set-up (172).

#### Naming error!

- The folder could not be created or images could not be recorded, because the highest supported folder number (999) for storing images on the card has been reached and the highest supported image number (9999) for images in folders has been reached. On the [11] tab, change [File Numbering] to [Auto Reset] (149), or format the memory card (148).

#### Lens Error

- This error may occur if the lens is held while it is moving, or when the camera is used in dusty or sandy locations.
- Frequent display of this error message may indicate camera damage. In this case, contact a Canon Customer Support Help Desk.

#### A camera error was detected (*error number*)

- If this error message is displayed immediately after a shot, the image may not have been saved. Switch to Playback mode to check for the image.
- Frequent display of this error message may indicate camera damage. In this case, write down the error number (*Exx*) and contact a Canon Customer Support Help Desk.

Before Use

Basic Guide

Advanced Guide

1 Camera Basics

2 Auto Mode / Hybrid Auto Mode

3 Other Shooting Modes

4 P Mode

5 Tv, Av, M, C1, and C2 Mode

6 Playback Mode

7 Wi-Fi Functions

8 Setting Menu

9 Accessories

10 Appendix

Index



## File Error

- Correct printing (📖166) may not be possible for photos from other cameras or images that have been altered using computer software, even if the camera is connected to the printer.

## Print error

- Check the paper size setting (📖168). If this error message is displayed when the setting is correct, restart the printer and complete the setting on the camera again.

## Ink absorber full

- Contact a Canon Customer Support Help Desk to request assistance with ink absorber replacement.

## Wi-Fi

### Connection failed

- No access points were recognized. Check the access point settings (📖129).
- A device could not be found. Turn the camera off and on again, and retry the connection.
- Check the device you want to connect to and make sure it is ready for connection.

### Cannot determine access point

- The WPS buttons on numerous access points were pressed simultaneously. Try reconnecting again.

### No access points found

- Check to make sure that the access point is turned on.
- When connecting to an access point manually, make sure that you entered the correct SSID.

### Incorrect password/Incorrect Wi-Fi security settings

- Check the access point security settings (📖129).

### IP address conflict

- Reset the IP address so that it does not conflict with another.

### Disconnected/Receiving failed/Sending failed

- You may be in an environment where Wi-Fi signals are obstructed.
- Avoid using the camera's Wi-Fi function around microwave ovens, Bluetooth devices, and other devices that operate on the 2.4 GHz band.
- Bring the camera closer to the other device you are trying to connect to (such as the access point), and make sure there are no objects between the devices.
- Check the connected device to make sure it is not experiencing errors.

### Sending failed

#### Memory card error

- If the same error message is displayed even when you have inserted a formatted memory card facing the correct way, contact a Canon Customer Support Help Desk.

### Receiving failed

#### Insufficient space on card

- There is not enough free space on the memory card in the target camera to receive images. Erase images to create space on the memory card, or insert a memory card with sufficient space.

### Receiving failed

#### Memory card locked

- The write-protect tab of the memory card in the camera to receive the images is set to the locked position. Slide the write-protect tab to the unlocked position.

### Receiving failed

#### Naming error!

- When the highest folder number (999), and the highest image number (9999) have been reached on the receiving camera, images cannot be received.

### Insufficient space on server

- Delete unnecessary images uploaded to CANON iMAGE GATEWAY to create space.
- Save the images sent via Image Sync (📖139) to your computer.

### Check network settings

- Check to make sure your computer can connect to the Internet with the current network settings.

## Before Use

## Basic Guide

## Advanced Guide

### 1 Camera Basics

### 2 Auto Mode / Hybrid Auto Mode

### 3 Other Shooting Modes

### 4 P Mode

### 5 Tv, Av, M, C1, and C2 Mode

### 6 Playback Mode

### 7 Wi-Fi Functions

### 8 Setting Menu

### 9 Accessories

### 10 Appendix

## Index

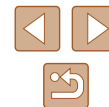

# On-Screen Information

## Shooting (Information Display)

The same information is shown on the viewfinder.

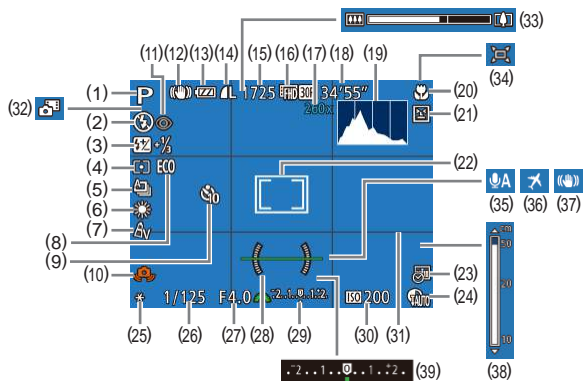

- (1) Shooting mode (182), Scene icon (37)
- (2) Flash mode (86), LED light (161)
- (3) Flash exposure compensation / Flash output level (87, 94)
- (4) Metering method (72), Shadow correction (76)
- (5) Drive mode (86), AEB shooting (74), Focus bracketing (80)
- (6) White balance (76), Mercury lamp correction (53)
- (7) My Colors (77)
- (8) Eco mode (147)
- (9) Self-timer (44)
- (10) Camera shake warning (36)
- (11) Red-eye correction (52)
- (12) IS mode icon (39)
- (13) Battery level (180)
- (14) Still image compression (90), Resolution (52)
- (15) Recordable shots (197)\*
- (16) Movie quality (53)

- (17) Digital zoom magnification (40), Digital tele-converter (81)
- (18) Remaining time (198)
- (19) Histogram (103)
- (20) Focusing range (79), AF lock (85)
- (21) Blink detection (55)
- (22) AF frame (82), Spot AE point frame (72)
- (23) Date stamp (45)
- (24) DR correction (75)
- (25) AE lock (72), FE lock (88)
- (26) Shutter speed (92, 93)
- (27) Aperture value (93)
- (28) Electronic level (54)
- (29) Exposure level (93)
- (30) ISO speed (73)
- (31) Grid lines (96)
- (32) Hybrid Auto mode (35)
- (33) Zoom bar (33)
- (34) Auto (42)
- (35) Wind filter (69)
- (36) Time zone (146)
- (37) Image stabilization (90)
- (38) MF indicator (79)
- (39) Exposure compensation level (72)

\* In [ ] mode, indicates the number of shots available.

## Battery Level

An on-screen icon or message indicates the battery charge level.

Display	Details
	Sufficient charge
	Slightly depleted, but sufficient
	Nearly depleted—charge the battery pack soon
[Charge the battery]	Depleted—charge the battery pack immediately

- Before Use
- Basic Guide
- Advanced Guide
  - 1 Camera Basics
  - 2 Auto Mode / Hybrid Auto Mode
  - 3 Other Shooting Modes
  - 4 P Mode
  - 5 Tv, Av, M, C1, and C2 Mode
  - 6 Playback Mode
  - 7 Wi-Fi Functions
  - 8 Setting Menu
  - 9 Accessories
  - 10 Appendix
- Index

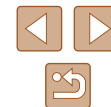

## Playback (Detailed Information Display)

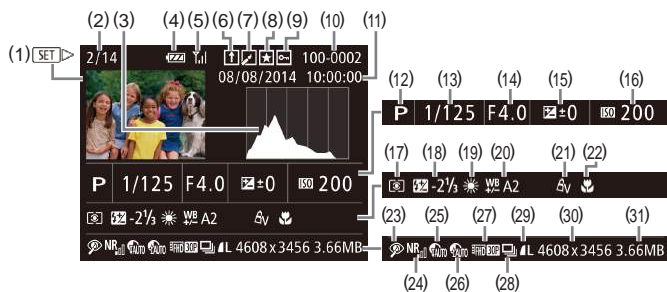

- |   |  |
|---|--|
| (1) Movies (📖33, 📖101)  | (15) Exposure compensation level (📖72), Exposure shift level (📖68)                             |
| (2) Current image no. / Total no. of images                       | (16) ISO speed (📖73), Playback speed (📖63)   |
| (3) Histogram (📖103)  | (17) Metering method (📖72)   |
| (4) Battery level (📖180)  | (18) Flash (📖86), Flash exposure compensation (📖87)  |
| (5) Wi-Fi signal strength (📖138)                                  | (19) White balance (📖76)   |
| (6) Image Sync (📖139)   | (20) White balance correction (📖77), Mercury lamp correction (📖53), Creative Shot effect (📖58) |
| (7) Image editing (📖116), Movie compression (📖121)                | (21) My Colors (📖77, 📖118)   |
| (8) Favorites (📖115)  | (22) Focusing range (📖79)  |
| (9) Protection (📖110)   | (23) Red-eye correction (📖52, 📖119)  |
| (10) Folder number - File number (📖149)                           | (24) High ISO NR (📖74)   |
| (11) Shooting date/time (📖20)                                     | (25) DR correction (📖75)   |
| (12) Shooting mode (📖182)   | (26) Shadow correction (📖76), i-Contrast (📖118)  |
| (13) Shutter speed (📖92, 📖93)                                     |  |
| (14) Aperture value (📖93), Image quality (movies) (📖52, 📖53, 📖70) |  |

- |   |   |
|---|---|
| (27) Image quality / Frame rate (movies) (📖52, 📖53, 📖70), Image editing (📖116)                                    | (30) Still images: Resolution (📖197) Movies: Playback time (📖198) |
| (28) Group playback (📖107)  | (31) File size  |
| (29) Compression (image quality) (📖90) / Resolution (📖52, 📖53, 📖70), Digest movies (📖35), RAW (📖89), MP4 (movies) |   |







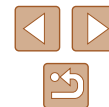





- Some information may not be displayed when viewing images on a TV (📖157).

Before Use
Basic Guide
Advanced Guide
<b>1</b> Camera Basics
<b>2</b> Auto Mode / Hybrid Auto Mode
<b>3</b> Other Shooting Modes
<b>4</b> P Mode
<b>5</b> Tv, Av, M, C1, and C2 Mode
<b>6</b> Playback Mode
<b>7</b> Wi-Fi Functions
<b>8</b> Setting Menu
<b>9</b> Accessories
<b>10</b> Appendix
Index



## Summary of Movie Control Panel

The following operations are available on the movie control panel accessed as described in "Viewing" (101).

	Exit
	Play
	Slow Motion (Press the [◀▶] buttons to adjust the playback speed. No sound is played.)
	Skip Backward* or Previous Clip (121) (To continue skipping backward, keep holding down the [◀] button.)
	Previous Frame (For fast-rewind, keep holding down the [⏪] button.)
	Next Frame (For fast-forward, keep holding down the [⏩] button.)
	Skip Forward* or Next Clip (121) (To continue skipping forward, keep holding down the [▶] button.)
	Edit (120)
	Erase Clip (displayed when a digest movie is selected (121))
	Shown when the camera is connected to a PictBridge-compatible printer (166).

\* Displays the frame approx. 4 sec. before or after the current frame.



- During movie playback, you can skip back or forward (or to the previous or next clip) by pressing the [◀▶] buttons.

## Functions and Menu Tables

### Functions Available in Each Shooting Mode

#### Av/Tv Settings (92, 93)

Aperture Value

C2\*1 / C1\*1 / M / Av / Tv / P /  / AUTO /  /  /  /  /  /  /  /  /  /  /  /  /  /  /  /  /

### Tracking AF (📖83)



### Resize AF Frame (📖82)



### Exposure Compensation (📖72)



### AE Lock (during recording)/Exposure Compensation (📖96)\*2



### AE Lock/FE Lock (📖68, 📖72, 📖88)\*3



### Drive Mode (📖86)



### Focusing Range (📖79, 📖85)



### Flash (📖86)



### Before Use

### Basic Guide

### Advanced Guide

- 1 Camera Basics
- 2 Auto Mode / Hybrid Auto Mode
- 3 Other Shooting Modes
- 4 P Mode
- 5 Tv, Av, M, C1, and C2 Mode
- 6 Playback Mode
- 7 Wi-Fi Functions
- 8 Setting Menu
- 9 Accessories
- 10 Appendix

### Index





C2\*/C1\*/M/Av/Tv/P//AUTO///////////

### Flash Exposure Compensation (87)

C2\*/C1\*/M/Av/Tv/P//AUTO///////////

### Change Display (28)

C2\*/C1\*/M/Av/Tv/P//AUTO///////////

- \*1 Options vary depending on the assigned shooting mode.
- \*2 When assigned to the [S] button (96).
- \*3 FE lock not available in [C] flash mode.
- \*4 [Fn] is set with [MF], AF lock, or [Fn].
- \*5 Not available, but switches to [Fn] in some cases.

## FUNC. Menu

### DR Correction (75)



C2\*/C1\*/M/Av/Tv/P//AUTO///////////



C2\*/C1\*/M/Av/Tv/P//AUTO///////////



C2\*/C1\*/M/Av/Tv/P//AUTO///////////

### Shadow Correction (76)



C2\*/C1\*/M/Av/Tv/P//AUTO///////////



C2\*/C1\*/M/Av/Tv/P//AUTO///////////

### ISO Speed (73)



C2\*/C1\*/M/Av/Tv/P//AUTO///////////

ISO 100 / 200 / 400 / 800 / 1600 / 3200

C2\*/C1\*/M/Av/Tv/P//AUTO///////////

### White Balance (76)



C2\*/C1\*/M/Av/Tv/P//AUTO///////////

C2\*/C1\*/M/Av/Tv/P//AUTO///////////



C2\*/C1\*/M/Av/Tv/P//AUTO///////////

Before Use

Basic Guide

Advanced Guide

1 Camera Basics

2 Auto Mode / Hybrid Auto Mode

3 Other Shooting Modes

4 P Mode

5 Tv, Av, M, C1, and C2 Mode

6 Playback Mode

7 Wi-Fi Functions

8 Setting Menu

9 Accessories

10 Appendix

Index





White Balance Correction (📖77)

C2\*1/C1\*1/M/Av/Tv/P/AUTO/📷/🔍/📶/🔄/🎞️/📷/🔍/📶/🔄/🎞️/  
📷/🔍/📶/🔄/🎞️/HDR/📷/🔍/📶/🔄/🎞️/📷/🔍/📶/🔄/🎞️/📷/🔍/📶/🔄/🎞️/  
📷/🔍/📶/🔄/🎞️/📷/🔍/📶/🔄/🎞️

My Colors (📖77)

📷

C2\*1/C1\*1/M/Av/Tv/P/AUTO/📷/🔍/📶/🔄/🎞️/📷/🔍/📶/🔄/🎞️/  
📷/🔍/📶/🔄/🎞️/HDR/📷/🔍/📶/🔄/🎞️/📷/🔍/📶/🔄/🎞️/📷/🔍/📶/🔄/🎞️/  
📷/🔍/📶/🔄/🎞️/📷/🔍/📶/🔄/🎞️

Av/AN/Se\*2/BW\*2/SP/SL/SD/SB/SG/SR/Sc\*3

C2\*1/C1\*1/M/Av/Tv/P/AUTO/📷/🔍/📶/🔄/🎞️/📷/🔍/📶/🔄/🎞️/  
📷/🔍/📶/🔄/🎞️/HDR/📷/🔍/📶/🔄/🎞️/📷/🔍/📶/🔄/🎞️/📷/🔍/📶/🔄/🎞️/  
📷/🔍/📶/🔄/🎞️/📷/🔍/📶/🔄/🎞️

Bracketing (📖74, 📖80)

📷

C2\*1/C1\*1/M/Av/Tv/P/AUTO/📷/🔍/📶/🔄/🎞️/📷/🔍/📶/🔄/🎞️/  
📷/🔍/📶/🔄/🎞️/HDR/📷/🔍/📶/🔄/🎞️/📷/🔍/📶/🔄/🎞️/📷/🔍/📶/🔄/🎞️/  
📷/🔍/📶/🔄/🎞️/📷/🔍/📶/🔄/🎞️

📷

C2\*1/C1\*1/M/Av/Tv/P/AUTO/📷/🔍/📶/🔄/🎞️/📷/🔍/📶/🔄/🎞️/  
📷/🔍/📶/🔄/🎞️/HDR/📷/🔍/📶/🔄/🎞️/📷/🔍/📶/🔄/🎞️/📷/🔍/📶/🔄/🎞️/  
📷/🔍/📶/🔄/🎞️/📷/🔍/📶/🔄/🎞️

📷

C2\*1/C1\*1/M/Av/Tv/P/AUTO/📷/🔍/📶/🔄/🎞️/📷/🔍/📶/🔄/🎞️/  
📷/🔍/📶/🔄/🎞️/HDR/📷/🔍/📶/🔄/🎞️/📷/🔍/📶/🔄/🎞️/📷/🔍/📶/🔄/🎞️/  
📷/🔍/📶/🔄/🎞️/📷/🔍/📶/🔄/🎞️

Self-Timer (📖44)

📷

C2\*1/C1\*1/M/Av/Tv/P/AUTO/📷/🔍/📶/🔄/🎞️/📷/🔍/📶/🔄/🎞️/  
📷/🔍/📶/🔄/🎞️/HDR/📷/🔍/📶/🔄/🎞️/📷/🔍/📶/🔄/🎞️/📷/🔍/📶/🔄/🎞️/  
📷/🔍/📶/🔄/🎞️/📷/🔍/📶/🔄/🎞️

📷/🔍/📶/🔄/🎞️

C2\*1/C1\*1/M/Av/Tv/P/AUTO/📷/🔍/📶/🔄/🎞️/📷/🔍/📶/🔄/🎞️/  
📷/🔍/📶/🔄/🎞️/HDR/📷/🔍/📶/🔄/🎞️/📷/🔍/📶/🔄/🎞️/📷/🔍/📶/🔄/🎞️/  
📷/🔍/📶/🔄/🎞️/📷/🔍/📶/🔄/🎞️

Self-Timer Settings (📖44)

Delay\*4

C2\*1/C1\*1/M/Av/Tv/P/AUTO/📷/🔍/📶/🔄/🎞️/📷/🔍/📶/🔄/🎞️/  
📷/🔍/📶/🔄/🎞️/HDR/📷/🔍/📶/🔄/🎞️/📷/🔍/📶/🔄/🎞️/📷/🔍/📶/🔄/🎞️/  
📷/🔍/📶/🔄/🎞️/📷/🔍/📶/🔄/🎞️

Shots\*5

C2\*1/C1\*1/M/Av/Tv/P/AUTO/📷/🔍/📶/🔄/🎞️/📷/🔍/📶/🔄/🎞️/  
📷/🔍/📶/🔄/🎞️/HDR/📷/🔍/📶/🔄/🎞️/📷/🔍/📶/🔄/🎞️/📷/🔍/📶/🔄/🎞️/  
📷/🔍/📶/🔄/🎞️/📷/🔍/📶/🔄/🎞️

Metering Method (📖72)

📷

C2\*1/C1\*1/M/Av/Tv/P/AUTO/📷/🔍/📶/🔄/🎞️/📷/🔍/📶/🔄/🎞️/  
📷/🔍/📶/🔄/🎞️/HDR/📷/🔍/📶/🔄/🎞️/📷/🔍/📶/🔄/🎞️/📷/🔍/📶/🔄/🎞️/  
📷/🔍/📶/🔄/🎞️/📷/🔍/📶/🔄/🎞️

📷/🔍/📶/🔄/🎞️

C2\*1/C1\*1/M/Av/Tv/P/AUTO/📷/🔍/📶/🔄/🎞️/📷/🔍/📶/🔄/🎞️/  
📷/🔍/📶/🔄/🎞️/HDR/📷/🔍/📶/🔄/🎞️/📷/🔍/📶/🔄/🎞️/📷/🔍/📶/🔄/🎞️/  
📷/🔍/📶/🔄/🎞️/📷/🔍/📶/🔄/🎞️

Still Image Aspect Ratio (📖51)

16:9

C2\*1/C1\*1/M/Av/Tv/P/AUTO/📷/🔍/📶/🔄/🎞️/📷/🔍/📶/🔄/🎞️/  
📷/🔍/📶/🔄/🎞️/HDR/📷/🔍/📶/🔄/🎞️/📷/🔍/📶/🔄/🎞️/📷/🔍/📶/🔄/🎞️/  
📷/🔍/📶/🔄/🎞️/📷/🔍/📶/🔄/🎞️

3:2 / 1:1 / 4:5

C2\*1/C1\*1/M/Av/Tv/P/AUTO/📷/🔍/📶/🔄/🎞️/📷/🔍/📶/🔄/🎞️/  
📷/🔍/📶/🔄/🎞️/HDR/📷/🔍/📶/🔄/🎞️/📷/🔍/📶/🔄/🎞️/📷/🔍/📶/🔄/🎞️/  
📷/🔍/📶/🔄/🎞️/📷/🔍/📶/🔄/🎞️

Before Use

Basic Guide

Advanced Guide

1 Camera Basics

2 Auto Mode / Hybrid Auto Mode

3 Other Shooting Modes

4 P Mode

5 Tv, Av, M, C1, and C2 Mode

6 Playback Mode

7 Wi-Fi Functions

8 Setting Menu

9 Accessories

10 Appendix

Index



4:3

C2\*/C1\*/M/Av/Tv/P//AUTO/  

Resolution (52)

L

C2\*/C1\*/M/Av/Tv/P//AUTO/  

M1/M2/S

C2\*/C1\*/M/Av/Tv/P//AUTO/  

M

C2/C1/M/Av/Tv/P//AUTO/  

Compression (90)

S

C2\*/C1\*/M/Av/Tv/P//AUTO/  

A

C2\*/C1\*/M/Av/Tv/P//AUTO/  

Image Type (89)

JPEG / RAW / 

C2\*/C1\*/M/Av/Tv/P//AUTO/  

Movie Quality (53, 70)

FHD 60P

C2\*/C1\*/M/Av/Tv/P//AUTO/  

FHD 30P

C2\*/C1\*/M/Av/Tv/P//AUTO/  

HD 30P

C2\*/C1\*/M/Av/Tv/P//AUTO/  

EVGA 30P

C2\*/C1\*/M/Av/Tv/P//AUTO/  

EVGA 120P

C2/C1/M/Av/Tv/P//AUTO/  

EVGA 240P

C2/C1/M/Av/Tv/P//AUTO/  

\*1 Options vary depending on the assigned shooting mode.

\*2 White balance is not available.

\*3 Set in a range of 1 – 5: contrast, sharpness, color saturation, red, green, blue, and skin tone. Default: 3. These setting are applied in all modes.

\*4 Cannot be set to 0 seconds in modes without selection of the number of shots.

\*5 One shot (cannot be modified) in modes without selection of the number of shots.

\*6 Synchronizes with the aspect ratio setting and is automatically set (63).

Before Use

Basic Guide

Advanced Guide

1 Camera Basics

2 Auto Mode / Hybrid Auto Mode

3 Other Shooting Modes

4 P Mode

5 Tv, Av, M, C1, and C2 Mode

6 Playback Mode

7 Wi-Fi Functions

8 Setting Menu

9 Accessories

10 Appendix

Index

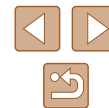



## AF-assist Beam (📖55)

On



Off



## MF-Point Zoom (📖79)

Off



2x/4x



## Safety MF (📖79)

On



Off



## Recall Zoom/MF Settings (📖81)

Zoom Memory

On



Off



MF Memory

On



Off



## MF Peaking Settings (📖80)

Peaking

On/Off



Level

High/Low



Before Use

Basic Guide

Advanced Guide

1 Camera Basics

2 Auto Mode / Hybrid Auto Mode

3 Other Shooting Modes

4 P Mode

5 Tv, Av, M, C1, and C2 Mode

6 Playback Mode

7 Wi-Fi Functions

8 Setting Menu

9 Accessories

10 Appendix

Index



## Color

Red/Yellow/Blue



## Flash Control (52, 55, 87, 88, 94)

### Flash Mode

Auto



Manual



### Flash Exp. Comp



### Flash Output

Minimum/Medium/Maximum



### Shutter Sync.

1st-curtain



## 2nd-curtain



### Red-Eye Corr.

On



Off



### Red-Eye Lamp

On/Off



### Safety FE

On



Off



## Before Use

### Basic Guide

### Advanced Guide

#### 1 Camera Basics

#### 2 Auto Mode / Hybrid Auto Mode

#### 3 Other Shooting Modes

#### 4 P Mode

#### 5 Tv, Av, M, C1, and C2 Mode

#### 6 Playback Mode

#### 7 Wi-Fi Functions

#### 8 Setting Menu

#### 9 Accessories

#### 10 Appendix

## Index



### ISO Auto Settings (📖74)

Max ISO Speed



Rate of Change



### High ISO NR (📖74)

Low/Standard\*/High



### Hg Lamp Corr. (📖53)

On/Off\*



### Spot AE Point (📖72)

Center



AF Point



### Safety Shift (📖93)

On



Off



### Sound rec. (📖68)

Sound rec.

Auto



Manual



Disable



Level

0 – 47\* – 63



### Before Use

### Basic Guide

### Advanced Guide

**1** Camera Basics

**2** Auto Mode / Hybrid Auto Mode

**3** Other Shooting Modes

**4** P Mode

**5** Tv, Av, M, C1, and C2 Mode

**6** Playback Mode

**7** Wi-Fi Functions

**8** Setting Menu

**9** Accessories

**10** Appendix

### Index



## Wind filter/Attenuator

Wind Filter: Auto



Wind Filter: Off



Attenuator: Off



Attenuator: On



## Review image after shooting (56)

Display Time

Off



Quick



2 sec./4 sec./8 sec./Hold



## Display Info

Off



Detailed



## Blink Detection (55)

On



Off



## Custom Display (96)

Shooting Info



Grid Lines



Electronic Level



## Before Use

### Basic Guide

### Advanced Guide

#### 1 Camera Basics

#### 2 Auto Mode / Hybrid Auto Mode

#### 3 Other Shooting Modes

#### 4 P Mode

#### 5 Tv, Av, M, C1, and C2 Mode

#### 6 Playback Mode

#### 7 Wi-Fi Functions

#### 8 Setting Menu

#### 9 Accessories

#### 10 Appendix

## Index



Histogram



**FUNC. Menu Layout (p97)**



**Reverse Disp. (p20)**

On/Off



**IS Settings (p90)**

IS Mode

Off



Continuous



Shoot Only



Dynamic IS

1



2



**Display Area (p40)**

Large/Medium/Small\*



**Auto Settings (p42, p43)**

Seek Assist

On



Off



**Auto Zoom**

Face/Upper Body/Whole Body/Manual



Off



Before Use

Basic Guide

Advanced Guide

**1** Camera Basics

**2** Auto Mode / Hybrid Auto Mode

**3** Other Shooting Modes

**4** P Mode

**5** Tv, Av, M, C1, and C2 Mode

**6** Playback Mode

**7** Wi-Fi Functions

**8** Setting Menu

**9** Accessories

**10** Appendix

Index





## Date Stamp (📖45)

Off

C2\*/C1\*/M/Av/Tv/P//AUTO/////  
/////////

Date

C2\*/C1\*/M/Av/Tv/P//AUTO/////  
/////////

Date & Time

C2\*/C1\*/M/Av/Tv/P//AUTO/////  
/////////

## Digest Type (📖35)

Include Stills\*/No Stills

C2/C1/M/Av/Tv/P//AUTO/////  
///////

## Face ID Settings (📖47)

On\*/Off

C2\*/C1\*/M/Av/Tv/P//AUTO/////  
///////

## Set Shortcut button (📖96)

C2\*/C1\*/M/Av/Tv/P//AUTO/////  
///////

## Set button (📖96)

C2\*/C1\*/M/Av/Tv/P//AUTO/////  
///////

## Set button (📖96)

C2\*/C1\*/M/Av/Tv/P//AUTO/////  
///////

## Save Settings (📖98)

C2\*/C1\*/M/Av/Tv/P//AUTO/////  
///////

- \*1 Operation when no faces are detected varies by shooting mode.
- \*2 Options vary depending on the assigned shooting mode.
- \*3 Only available by pressing the button (📖72).
- \*4 [FlexiZone] in [P], [Tv], [Av], and [M] modes, otherwise [Center].
- \*5 [On] when subject movement is detected in [AUTO] mode.

Before Use

Basic Guide

Advanced Guide

**1** Camera Basics

**2** Auto Mode /  
Hybrid Auto Mode

**3** Other Shooting Modes

**4** P Mode

**5** Tv, Av, M, C1, and C2 Mode

**6** Playback Mode

**7** Wi-Fi Functions

**8** Setting Menu

**9** Accessories

**10** Appendix

Index



## Set Up Tab

Item	Ref. Page
Mute	145
Volume	145
Hints & Tips	146
Date/Time	146
Time Zone	146
Lens Retraction	147
Eco Mode	147
Power Saving	26,  147
LCD Brightness	148
Start-up Image	148
Format	148,  149
File Numbering	149
Create Folder	150
Units	150
Electronic Level	150
Video System	157
Wi-Fi Settings	122
Mobile Device Connect Button	123
Copyright Info	151
Certification Logo Display	151
Language	152
Reset All	152

## My Menu Tab

Item	Ref. Page
My Menu settings	99

## Playback Tab

Item	Ref. Page
Image Search	105
List/Play Digest Movies	104
Smart Shuffle	110
Slideshow	109
Erase	112
Protect	110
Rotate	114
Favorites	115
Photobook Set-up	172
i-Contrast	118
Red-Eye Correction	119
Cropping	117
Resize	116
My Colors	118
Face ID Info	104
Transition Effect	101
Index Effect	105
Scroll Display	101
Group Images	107
Auto Rotate	115

Before Use

Basic Guide

Advanced Guide

**1** Camera Basics

**2** Auto Mode / Hybrid Auto Mode

**3** Other Shooting Modes

**4** P Mode

**5** Tv, Av, M, C1, and C2 Mode

**6** Playback Mode

**7** Wi-Fi Functions

**8** Setting Menu

**9** Accessories

**10** Appendix

Index



Item	Ref. Page
Resume	101
Set Shortcut button	96

## Print Tab

Item	Ref. Page
Print	–
Select Images & Qty.	171
Select Range	171
Select All Images	171
Clear All Selections	171
Print Settings	170

## Handling Precautions

- The camera is a high-precision electronic device. Avoid dropping it or subjecting it to strong impact.
- Never bring the camera near magnets, motors, or other devices that generate strong electromagnetic fields, which may cause malfunction or erase image data.
- If water droplets or dirt adheres to the camera or screen, wipe with a dry soft cloth, such as an eyeglass cloth. Do not rub hard or apply force.
- Never use cleaners containing organic solvents to clean the camera or screen.
- Use a blower brush to remove dust from the lens. If cleaning is difficult, contact a Canon Customer Support Help Desk.
- To prevent condensation from forming on the camera after sudden temperature changes (when the camera is transferred from cold to warm environments), put the camera in an airtight, resealable plastic bag and let it gradually adjust to the temperature before removing it from the bag.
- If condensation does form on the camera, stop using it immediately. Continuing to use the camera in this state may damage it. Remove the battery pack and memory card, and wait until the moisture has evaporated before resuming use.
- Before long-term battery storage, use up the battery pack's remaining charge, remove it from the camera, and store it in a plastic bag or similar container. Storing a partially charged battery pack over extended periods (about a year) may shorten its life or affect performance.

Before Use

Basic Guide

Advanced Guide

**1** Camera Basics

**2** Auto Mode / Hybrid Auto Mode

**3** Other Shooting Modes

**4** P Mode

**5** Tv, Av, M, C1, and C2 Mode

**6** Playback Mode

**7** Wi-Fi Functions

**8** Setting Menu

**9** Accessories

**10** Appendix

Index



## Specifications

### Camera Specifications

Camera Effective Pixels (Max.)	Approx. 16.1 million pixels
Lens Focal Length	65x zoom: 3.8 (W) – 247.0 (T) mm (35mm film equivalent: 21 (W) – 1365 (T) mm)
Viewfinder	LCD Viewfinder Effective Pixels: Approx. 922,000 dots Dioptic Adjustment Range: –4.0 to +1.0 m <sup>-1</sup> (dpt)
LCD Monitor	3.0-type color TFT LCD Effective Pixels: Approx. 922,000 dots
File Format	Design rule for Camera File system, DPOF (version 1.1) compliant
Data Type	Still Images: Exif 2.3 (JPEG), RAW (CR2 (Canon Original)) Movies: MP4 (Video: MPEG-4 AVC/H.264; Audio: MPEG-4 AAC-LC (stereo))
Interface	Hi-speed USB HDMI output Analog audio output (stereo) Analog video output (NTSC/PAL)
Power Source	Battery Pack NB-10L AC Adapter Kit ACK-DC80
Dimensions (Based on CIPA Guidelines)	127.6 x 92.6 x 114.3 mm (5.02 x 3.65 x 4.50 in.)
Weight (Based on CIPA Guidelines)	Approx. 650 g (approx. 22.93 oz.; including the battery pack and memory card) Approx. 607 g (approx. 21.41 oz.; camera body only)

### Wi-Fi

Standards	IEEE 802.11b/g/n* * 2.4 GHz band only
Transmission Methods	OFDM modulation (IEEE 802.11g/n) DSSS modulation (IEEE 802.11b)
Communication Modes	Infrastructure mode* <sup>1</sup> , Ad hoc mode* <sup>2</sup> * <sup>1</sup> Supports Wi-Fi Protected Setup * <sup>2</sup> Wi-Fi CERTIFIED IBSS
Supported Channels	1 – 11 (PC2188) or 1 – 13 (PC2154) Model numbers indicated in parentheses
Security	WEP, WPA-PSK (AES/TKIP), WPA2-PSK (AES/TKIP)

### Digital Zoom Focal Length (35mm equivalent)

Digital Zoom [Standard]	21 – 5460 mm (Represents the combined focal length of optical and digital zoom.)
Digital Tele-Converter 1.6x	33.6 – 2184.0 mm
Digital Tele-Converter 2.0x	42.0 – 2730.0 mm

Before Use

Basic Guide

Advanced Guide

**1** Camera Basics

**2** Auto Mode / Hybrid Auto Mode

**3** Other Shooting Modes

**4** P Mode

**5** Tv, Av, M, C1, and C2 Mode

**6** Playback Mode

**7** Wi-Fi Functions

**8** Setting Menu

**9** Accessories

**10** Appendix

Index



## Number of Shots/Recording Time, Playback Time

Number of Shots	Screen On	Approx. 340
	Screen Off Viewfinder On	Approx. 340
	Eco Mode On	Approx. 450
Movie Recording Time* <sup>1</sup>	Screen On	Approx. 1 hour
	Screen Off Viewfinder On	Approx. 1 hour
Movie Recording Time (Continuous Shooting* <sup>2</sup> )	Screen On	Approx. 2 hours
	Screen Off Viewfinder On	Approx. 2 hours
Playback Time		Approx. 6 hours









\*1 Time under default camera settings, when normal operations are performed, such as shooting, pausing, turning the camera on and off, and zooming.

\*2 Time available when shooting the maximum movie length (until recording stops automatically) repeatedly.

- The number of shots that can be taken is based on measurement guidelines of the Camera & Imaging Products Association (CIPA).
- Under some shooting conditions, the number of shots and recording time may be less than mentioned above.
- Number of shots/time with a fully charged battery pack.

## Number of Shots per Memory Card

The number of shots at an aspect ratio (📖51) of 4:3 per memory card is as follows. Note that the number of shots available varies by aspect ratio.

Recording Pixels	Compression Ratio	Number of Shots per Memory Card (Approx. shots)	
		8 GB	32 GB
<b>L</b> (Large) 16M/ 4608x3456		1058	4272
		1705	6883
<b>M1</b> (Medium 1) 8M/ 3264x2448		1996	8059
		3069	12391
<b>M2</b> (Medium 2) 3M/2048x1536		4723	19064
		8469	34184
<b>S</b> (Small) 0.3M/640x480		27291	110150
		40937	165225
RAW Images 4608x3456	—	317	1284

- The values in the table are based on Canon measurement conditions and may change depending on the subject, memory card and camera settings.

Before Use

Basic Guide

Advanced Guide

**1** Camera Basics

**2** Auto Mode /  
Hybrid Auto Mode

**3** Other Shooting Modes

**4** P Mode

**5** Tv, Av, M, C1, and C2 Mode

**6** Playback Mode

**7** Wi-Fi Functions

**8** Setting Menu

**9** Accessories

**10** Appendix

Index

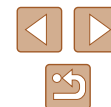

## Recording Time per Memory Card

Image Quality	Recording Time per Memory Card	
	8 GB	32 GB
FHD 60P	30 min. 3 sec. * <sup>1</sup>	2 hr. 1 min. 27 sec. * <sup>2</sup>
FHD 30P	43 min. 29 sec.	2 hr. 55 min. 43 sec.
HD 60P	2 hr. 3 min. 55 sec.	8 hr. 20 min. 32 sec.
VGA 30P	5 hr. 14 min. 34 sec.	21 hr. 10 min. 38 sec.

\*<sup>1</sup> 26 min. 22 sec. for iFrame movies (69).

\*<sup>2</sup> 1 hr. 46 min. 33 sec. for iFrame movies (69).

- The values in the table are based on Canon measurement conditions and may change depending on the subject, memory card and camera settings.
- Recording will automatically stop when the clip file size reaches 4 GB, or when the recording time reaches approximately 29 minutes and 59 seconds when shooting in FHD 60P, FHD 30P or HD 60P, or approximately 1 hour when shooting in VGA 30P.
- Recording may stop even if the maximum clip length has not been reached on some memory cards. SD Speed Class 6 or higher memory cards are recommended.

## Flash Range

Maximum wide angle ()	50 cm – 5.5 m (1.6 – 18 ft.)
Maximum telephoto ()	1.8 m – 3.0 m (5.9 – 9.8 ft.)

## Shooting Range

Shooting Mode	Focusing Range	Maximum Wide Angle ()	Maximum Telephoto ()
<b>AUTO</b>	–	0 cm (0.0 in.) – infinity	1.8 m (5.9 ft.) – infinity
	–	1 m (3.3 ft.) – infinity	15 m (49 ft.) – infinity
Other modes		5 cm (2.0 in.) – infinity	1.8 m (5.9 ft.) – infinity
		0 – 50 cm (0.0 in. – 1.6 ft.)	–
	<b>MF*</b>	0 cm (0.0 in.) – infinity	1.8 m (5.9 ft.) – infinity

\* Not available in some shooting modes.

## Continuous Shooting Speed

Continuous Shooting Mode	Speed
	Approx. 6.4 shots/sec.
	Approx. 3.8 shots/sec.
	Approx. 4.6 shots/sec.

- Using an 8 GB UHS-I memory card specified in Canon testing standards. Note that the number of shots varies depending on subjects, the brand of memory card, and other factors.

Before Use

Basic Guide

Advanced Guide

**1** Camera Basics

**2** Auto Mode / Hybrid Auto Mode

**3** Other Shooting Modes

**4** P Mode

**5** Tv, Av, M, C1, and C2 Mode

**6** Playback Mode

**7** Wi-Fi Functions

**8** Setting Menu

**9** Accessories

**10** Appendix

Index



## Shutter Speed

[AUTO] mode, automatically set range	1 – 1/2000 sec.
Available values in [Tv], [M], or [P] mode (sec.)*	15, 13, 10, 8, 6, 5, 4, 3.2, 2.5, 2, 1.6, 1.3, 1, 0.8, 0.6, 0.5, 0.4, 0.3, 1/4, 1/5, 1/6, 1/8, 1/10, 1/13, 1/15, 1/20, 1/25, 1/30, 1/40, 1/50, 1/60, 1/80, 1/100, 1/125, 1/160, 1/200, 1/250, 1/320, 1/400, 1/500, 1/640, 1/800, 1/1000, 1/1250, 1/1600, 1/2000

\* In [P] mode, shutter speeds of 1/25 seconds or slower are not available.

## Aperture

f/number	f/3.4 / f/8.0 (W) – f/6.5 / f/8.0 (T)
Available values in [Av], [M], or [P] mode*	f/3.5, f/4.0, f/4.3, f/4.5, f/5.0, f/5.6, f/6.3, f/6.5, f/7.1, f/8.0

\* Depending on the zoom position, some aperture values may not be available.

## Battery Pack NB-10L

Type:	Rechargeable lithium-ion battery
Nominal Voltage:	7.4 V DC
Nominal Capacity:	920 mAh
Charging Cycles:	Approx. 300 times
Operating Temperatures:	0 – 40 °C (32 – 104 °F)
Dimensions:	32.5 x 45.4 x 15.1 mm (1.28 x 1.79 x 0.59 in.)
Weight:	Approx. 41 g (approx. 1.45 oz.)

## Battery Charger CB-2LC/CB-2LCE

Rated Input:	100 – 240 V AC (50/60 Hz) 16 VA (100 V) – 22 VA (240 V), 0.18 A (100 V) – 0.12 A (240 V)
Rated Output:	8.4 V DC, 0.7 A
Charging Time:	Approx. 1 hr. 50 min. (when using NB-10L)
Charge Indicator:	Charging: orange / Fully charged: green (two-indicator system)
Operating Temperatures:	5 – 40 °C (41 – 104 °F)

## Lens Hood LH-DC90

Camera Mount:	Bayonet
Max. Diameter x Length:	φ70.0 x 27.7 mm (φ2.76 x 1.09 in.)
Weight:	Approx. 9 g (approx. 0.32 oz.)

Before Use
Basic Guide
Advanced Guide
<b>1</b> Camera Basics
<b>2</b> Auto Mode / Hybrid Auto Mode
<b>3</b> Other Shooting Modes
<b>4</b> P Mode
<b>5</b> Tv, Av, M, C1, and C2 Mode
<b>6</b> Playback Mode
<b>7</b> Wi-Fi Functions
<b>8</b> Setting Menu
<b>9</b> Accessories
<b>10</b> Appendix
Index

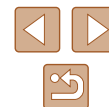

# Index

## A

AC adapter kit 155, 158  
Accessories 155  
AEB shooting 74  
AE lock 72  
AF frames 82  
AF lock 85  
Aspect ratio 51  
Attenuator 69  
AUTO mode (shooting mode) 22, 33  
Av (shooting mode) 93  
AV cable 158

## B

Batteries  
→ Date/time (date/time battery)  
Power saving 26  
Battery charger 2, 155  
Battery pack  
Charging 18  
Eco mode 147  
Level 180  
Power saving 166  
Black and white images 77  
Blink detection 55

## C

C1/C2 (shooting mode) 98  
Camera  
Reset all 152  
Camera access point mode 132  
CameraWindow (computer) 164  
CameraWindow (smartphone) 123

CANON IMAGE GATEWAY 133  
Center (AF frame mode) 82  
Clock 32  
Color (white balance) 76  
Compression ratio (image quality) 90  
Connecting via an access point 129  
Creative filters (shooting mode) 60  
Creative Shot 57  
Cropping 117, 168  
Custom white balance 77

## D

Date/time  
Adding date stamps 45  
Changing 21  
Date/time battery 21  
Settings 20  
World clock 146  
DC coupler 158  
Defaults → Reset all  
Digital tele-converter 81  
Digital zoom 40  
Display language 21  
DPOF 170  
Dynamic Range Correction 75

## E

Eco mode 147  
Editing  
Cropping 117  
i-Contrast 118  
My Colors 118  
Red-eye correction 119  
Resizing images 116

Editing or erasing connection  
information 143  
Electronic level 54  
Erasing 112  
Erasing all 114  
Error messages 178  
Exposure  
AE lock 72  
Compensation 72  
FE lock 88  
External microphone 159

## F

Face detect (AF frame mode) 83  
Face ID 47  
Face select 85  
Face self-timer (shooting mode) 66  
Favorites 115  
FE lock 88  
File numbering 149  
Fireworks (shooting mode) 59  
Fish-eye effect (shooting mode) 62  
Flash  
Deactivating flash 87  
Flash exposure compensation 87  
On 86  
Slow synchro 87  
FlexiZone (AF frame mode) 82  
Focus bracketing 80  
Focusing  
AF frames 82  
AF lock 85  
AF-point zoom 54  
Face select 85  
Focus memory 81  
MF peaking 80  
Servo AF 84

Focusing range  
Macro 79  
Manual focus 79  
Focus lock 82  
Framing Assist  
Lock 41  
Seek 40  
Front dial 106  
FUNC. menu  
Basic operations 29  
Table 184  
FUNC. menu layout 97

## G

Geotagging images 141  
GPS information display 103  
Grid lines 96

## H

Handheld nightscene  
(shooting mode) 59  
HDMI cable 156, 157  
High dynamic range  
(shooting mode) 61  
Household power 158  
Hybrid Auto (shooting mode) 35

## I

i-Contrast 75, 118  
iFrame movies (movie mode) 69  
Image quality  
→ Compression ratio (image quality)  
Images  
Display period 56  
Erasing 112  
Playback → Viewing  
Protecting 110

Before Use

Basic Guide

Advanced Guide

**1** Camera Basics

**2** Auto Mode /  
Hybrid Auto Mode

**3** Other Shooting Modes

**4** P Mode

**5** Tv, Av, M, C1, and C2 Mode

**6** Playback Mode

**7** Wi-Fi Functions

**8** Setting Menu

**9** Accessories

**10** Appendix

Index





Image stabilization 90  
Image Sync 139  
Indicator 32, 55  
ISO speed 73

**J**  
Jump display 106

**L**  
Low light (shooting mode) 59

**M**  
M (shooting mode) 93  
Macro (focusing range) 79  
Magnified display 108  
Manual focus (focusing range) 79  
Manual (movie mode) 95  
Memory cards 2  
    Recording time 198  
Menu  
    Basic operations 30  
    Table 182  
Mercury lamp correction 53  
Metering method 72  
Miniature effect (shooting mode) 62  
Mobile device connection button 123  
Monochrome (shooting mode) 64  
Movies  
    Editing 120  
    Image quality (resolution/  
    frame rate) 53, 70  
    Recording time 198  
Multi-area White Balance 53  
My Colors 77, 118

**N**  
Neck strap → Strap

**P**  
P (shooting mode) 71  
Package contents 2  
Photobook set-up 172  
PictBridge 156, 166  
Playback → Viewing  
Portrait (shooting mode) 59  
Poster effect (shooting mode) 60  
Power 155  
    → Batteries  
    → Battery charger  
Power saving 26  
Printing 166  
Program AE 71  
Protecting 110

**R**  
RAW 89  
Red-eye correction 52, 119  
Remote shooting 142  
Reset all 152  
Resizing images 116  
Resolution (image size) 52  
Rotating 114

**S**  
Saving images to a computer 165  
Screen  
    Display language 21  
    Icons 180, 181  
    Menu → FUNC. menu, Menu  
SD/SDHC/SDXC memory cards  
    → Memory cards  
Searching 105  
Seek Assist 43

Self-timer 44  
    2-second self-timer 44  
    Customizing the self-timer 44  
    Face self-timer  
        (shooting mode) 66  
    Wink self-timer  
        (shooting mode) 65  
Sending images 140  
Sending images to another  
    camera 137  
Sending images to a smartphone 123  
Sending images to Web services 133  
Sepia tone images 77  
Servo AF 84  
Shadow Correct 76  
Shooting  
    Shooting date/time → Date/time  
    Shooting information 96, 180  
Shortcut 96  
Slideshow 109  
Smart Shuffle 110  
Smart Shutter (shooting mode) 65  
Smile (shooting mode) 65  
Snow (shooting mode) 59  
Soft focus (shooting mode) 64  
Software  
    Installation 127, 164  
    Saving images to  
    a computer 165  
Sounds 145  
Sports (shooting mode) 58  
Stereo AV cable 155, 158  
Strap 2  
Super slow motion movie  
    (movie mode) 70  
Super vivid (shooting mode) 60

**T**  
Terminal 157, 158, 166  
Toy camera effect  
    (shooting mode) 63  
Tracking AF (AF frame mode) 83  
Traveling with the camera 146  
Troubleshooting 174  
TV display 157  
Tv (shooting mode) 92

**V**  
Viewfinder 27  
Viewing 24  
    Image search 105  
    Index display 105  
    Jump display 106  
    Magnified display 108  
    Single-image display 24  
    Slideshow 109  
    Smart Shuffle 110  
    TV display 157

**W**  
White balance (color) 76  
Wi-Fi functions 122  
Wi-Fi menu 125  
Wind filter 69  
Wink self-timer (shooting mode) 65  
World clock 146  
Wrist strap → Strap

**Z**  
Zoom 22, 33, 40, 81  
Zoom framing assist 40

Before Use

Basic Guide

Advanced Guide

**1** Camera Basics

**2** Auto Mode /  
Hybrid Auto Mode

**3** Other Shooting Modes

**4** P Mode

**5** Tv, Av, M, C1, and C2 Mode

**6** Playback Mode

**7** Wi-Fi Functions

**8** Setting Menu

**9** Accessories

**10** Appendix

Index



## Wi-Fi (Wireless LAN) Precautions

- Countries and Regions Permitting WLAN Use
  - Use of WLAN is restricted in some countries and regions, and illegal use may be punishable under national or local regulations. To avoid violating WLAN regulations, visit the Canon website to check where use is allowed.  
Note that Canon cannot be held liable for any problems arising from use in other countries and regions.
- Doing any of the following may incur legal penalties:
  - Altering or modifying the product
  - Removing the certification labels from the product
- According to foreign exchange and foreign trade law regulations, export permission (or service transaction permission) from the Japanese government is necessary to export strategic resources or services (including this product) outside Japan.
- Because this product includes American encryption software, it falls under U.S. Export Administration Regulations, and cannot be exported to or brought into a country under U.S. trade embargo.
- Be sure to make notes of the wireless LAN settings you use. The wireless LAN settings saved to this product may change or be erased due to incorrect operation of the product, the effects of radio waves or static electricity, or accident or malfunction. Be sure to make notes of wireless LAN settings as a precaution. Please note that Canon accepts no responsibility for direct or indirect damages or loss of earnings resulting from a degradation or disappearance of content.
- When transferring this product to another person, disposing of it, or sending it for repair, be sure to note the wireless LAN settings and reset the product to its default settings (erase settings) if necessary.
- Canon will not make compensation for damages resulting from loss or theft of the product.  
Canon accepts no responsibility for damages or loss resulting from unauthorized access or use of target devices registered on this product due to loss or theft of the product.

- Be sure to use the product as directed in this guide.  
Be sure to use the wireless LAN function of this product within the guidelines noted in this guide. Canon accepts no responsibility for damages or loss if the function and product are used in ways other than as described in this guide.
- Do not use the wireless LAN function of this product near medical equipment or other electronic equipment.  
Use of the wireless LAN function near medical equipment or other electronic equipment may affect operation of those devices.

## Radio Wave Interference Precautions

- This product may receive interference from other devices that emit radio waves. To avoid interference, be sure to use this product as far away as possible from such devices, or avoid using the devices at the same time as this product.

## Security Precautions

Because Wi-Fi uses radio waves to transmit signals, security precautions more stringent than when using a LAN cable are required. Keep the following points in mind when using Wi-Fi.

- Only use networks you are authorized to use.  
This product searches for Wi-Fi networks in the vicinity and displays the results on the screen. Networks you are not authorized to use (unknown networks) may also be displayed. However, attempting to connect to or using such networks could be regarded as unauthorized access. Be sure to use only networks you are authorized to use, and do not attempt to connect to other unknown networks.

If security settings have not been properly set, the following problems may occur.

- Transmission monitoring  
Third parties with malicious intent may monitor Wi-Fi transmissions and attempt to acquire the data you are sending.

Before Use

Basic Guide

Advanced Guide

1 Camera Basics

2 Auto Mode / Hybrid Auto Mode

3 Other Shooting Modes

4 P Mode

5 Tv, Av, M, C1, and C2 Mode

6 Playback Mode

7 Wi-Fi Functions

8 Setting Menu

9 Accessories

10 Appendix

Index



- **Unauthorized network access**  
Third parties with malicious intent may gain unauthorized access to the network you are using to steal, modify, or destroy information. Additionally, you could fall victim to other types of unauthorized access such as impersonation (where someone assumes an identity to gain access to unauthorized information) or springboard attacks (where someone gains unauthorized access to your network as a springboard to cover their tracks when infiltrating other systems).

To prevent these types of problems from occurring, be sure to thoroughly secure your Wi-Fi network.

Only use this camera's Wi-Fi function with a proper understanding of Wi-Fi security, and balance risk and convenience when adjusting security settings.



The camera can print to PictBridge-compatible printers via Wi-Fi. PictBridge technical standards make it easy to connect digital cameras, printers, and other devices directly. Additionally, a new standard called DPS over IP enables PictBridge connections in network environments, and the camera is also compatible with this standard.

## Trademarks and Licensing

- Microsoft and Windows are trademarks or registered trademarks of Microsoft Corporation in the United States and/or other countries.
- Macintosh and Mac OS are trademarks of Apple Inc., registered in the U.S. and other countries.
- App Store, iPhone, and iPad are trademarks of Apple Inc.
- The SDXC logo is a trademark of SD-3C, LLC.
- HDMI, the HDMI logo and High-Definition Multimedia Interface are trademarks or registered trademarks of HDMI Licensing, LLC.
- The iFrame logo and the iFrame symbol are trademarks of Apple Inc.
- Wi-Fi®, Wi-Fi Alliance®, WPA™, WPA2™ and Wi-Fi Protected Setup™ are trademarks or registered trademarks of the Wi-Fi Alliance.
- The N-Mark is a trademark or registered trademark of NFC Forum, Inc. in the United States and in other countries.
- All other trademarks are the property of their respective owners.
- This device incorporates exFAT technology licensed from Microsoft.
- This product is licensed under AT&T patents for the MPEG-4 standard and may be used for encoding MPEG-4 compliant video and/or decoding MPEG-4 compliant video that was encoded only (1) for a personal and non-commercial purpose or (2) by a video provider licensed under the AT&T patents to provide MPEG-4 compliant video. No license is granted or implied for any other use for MPEG-4 standard.

## Disclaimer

- Unauthorized reproduction of this guide is prohibited.
- All measurements based on Canon testing standards.
- Information subject to change without notice, as are product specifications and appearance.
- Illustrations and screenshots in this guide may differ slightly from the actual equipment.
- The above items notwithstanding, Canon cannot be held liable for any loss arising from the use of this product.

Before Use
Basic Guide
Advanced Guide
<b>1</b> Camera Basics
<b>2</b> Auto Mode / Hybrid Auto Mode
<b>3</b> Other Shooting Modes
<b>4</b> P Mode
<b>5</b> Tv, Av, M, C1, and C2 Mode
<b>6</b> Playback Mode
<b>7</b> Wi-Fi Functions
<b>8</b> Setting Menu
<b>9</b> Accessories
<b>10</b> Appendix
Index

