

GIGABYTE™

E162-220

Edge Server – 1U UP system with GPU supported

User Manual

Rev. 1.0

Copyright

© 2021 GIGA-BYTE TECHNOLOGY CO., LTD. All rights reserved.

The trademarks mentioned in this manual are legally registered to their respective owners.

Disclaimer

Information in this manual is protected by copyright laws and is the property of GIGABYTE. Changes to the specifications and features in this manual may be made by GIGABYTE without prior notice. No part of this manual may be reproduced, copied, translated, transmitted, or published in any form or by any means without GIGABYTE's prior written permission.

Documentation Classifications

In order to assist in the use of this product, GIGABYTE provides the following types of documentation:

- User Manual: detailed information & steps about the installation, configuration and use of this product (e.g. motherboard, server barebones), covering hardware and BIOS.
- User Guide: detailed information about the installation & use of an add-on hardware or software component (e.g. BMC firmware, rail-kit) compatible with this product.
- Quick Installation Guide: a short guide with visual diagrams that you can reference easily for installation purposes of this product (e.g. motherboard, server barebones).

Please see the support section of the online product page to check the current availability of these documents.

For More Information

For related product specifications, the latest firmware and software, and other information please visit our website at <http://www.gigabyte.com>



For GIGABYTE distributors and resellers, additional sales & marketing materials are available from our reseller portal: <http://reseller.b2b.gigabyte.com>

For further technical assistance, please contact your GIGABYTE representative or visit <https://esupport.gigabyte.com/> to create a new support ticket

For any general sales or marketing enquiries, you may also message GIGABYTE server directly by email: server.grp@gigabyte.com

Conventions

The following conventions are used in this user's guide:

	NOTE! Gives bits and pieces of additional information related to the current topic.
	CAUTION! Gives precautionary measures to avoid possible hardware or software problems.
	WARNING! Alerts you to any damage that might result from doing or not doing specific actions.

Server Warnings and Cautions

Before installing a server, be sure that you understand the following warnings and cautions.



WARNING!

To reduce the risk of electric shock or damage to the equipment:

- Do not disable the power cord grounding plug. The grounding plug is an important safety feature.
- Plug the power cord into a grounded (earthed) electrical outlet that is easily accessible at all times.
- Unplug all the power cords from the power supplies to disconnect power to the equipment.

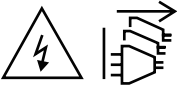

- Shock Hazard! Disconnect all power supply cords before servicing.
- Do not route the power cord where it can be walked on or pinched by items placed against it. Pay particular attention to the plug, electrical outlet, and the point where the cord extends from the server.



WARNING!

To reduce the risk of personal injury from hot surfaces, allow the drives and the internal system components to cool before touching them.



WARNING!

This server is equipped with high speed fans. Keep away from hazardous moving fan blades during servicing.



WARNING!

This equipment is not suitable for use in locations where children are likely to be present.



WARNING!

This equipment is intended to be used in Restrict Access Location. The access can only be gained by Skilled person.

Only authorized by well trained professional person can access the restrict access location.



CAUTION!

- Do not operate the server for long periods with the access panel open or removed. Operating the server in this manner results in improper airflow and improper cooling that can lead to thermal damage.
- Danger of explosion if battery is incorrectly replaced.
- Replace only with the same or equivalent type recommended by the manufacturer.
- Dispose of used batteries according to the manufacturer's instructions.

Electrostatic Discharge (ESD)



CAUTION!

ESD CAN DAMAGE DRIVES, BOARDS, AND OTHER PARTS. WE RECOMMEND THAT YOU PERFORM ALL PROCEDURES AT AN ESD WORKSTATION. IF ONE IS NOT AVAILABLE, PROVIDE SOME ESD PROTECTION BY WEARING AN ANTI-STATIC WRIST STRAP ATTACHED TO CHASSIS GROUND -- ANY UNPAINTED METAL SURFACE -- ON YOUR SERVER WHEN HANDLING PARTS.

Always handle boards carefully. They can be extremely sensitive to ESD. Hold boards only by their edges without any component and pin touching. After removing a board from its protective wrapper or from the system, place the board component side up on a grounded, static free surface. Use a conductive foam pad if available but not the board wrapper. Do not slide board over any surface.

System power on/off: To remove power from system, you must remove the system from rack. Make sure the system is removed from the rack before opening the chassis, adding, or removing any non hot-plug components.

Hazardous conditions, devices and cables: Hazardous electrical conditions may be present on power, telephone, and communication cables. Turn off the system and disconnect the cables attached to the system before servicing it. Otherwise, personal injury or equipment damage can result.

Electrostatic discharge (ESD) and ESD protection: ESD can damage drives, boards, and other parts. We recommend that you perform all procedures in this chapter only at an ESD workstation. If one is not available, provide some ESD protection by wearing an antistatic wrist strap attached to chassis ground (any unpainted metal surface on the server) when handling parts.

ESD and handling boards: Always handle boards carefully. They can be extremely sensitive to electrostatic discharge (ESD). Hold boards only by their edges. After removing a board from its protective wrapper or from the system, place the board component side up on a grounded, static free surface. Use a conductive foam pad if available but not the board wrapper. Do not slide board over any surface.

Installing or removing jumpers: A jumper is a small plastic encased conductor that slips over two jumper pins. Some jumpers have a small tab on top that can be gripped with fin-gertips or with a pair of fine needle nosed pliers. If the jumpers do not have such a tab, take care when using needle nosed pliers to remove or install a jumper; grip the narrow sides of the jumper with the pliers, never the wide sides. Gripping the wide sides can damage the contacts inside the jumper, causing intermittent problems with the function controlled by that jumper. Take care to grip with, but not squeeze, the pliers or other tool used to remove a jumper, or the pins on the board may bend or break.

**CAUTION!**

Risk of explosion if battery is replaced incorrectly or with an incorrect type. Replace the battery only with the same or equivalent type recommended by the manufacturer. Dispose of used batteries according to the manufacturer's instructions.

Table of Contents

Chapter 1 Hardware Installation	11
1-1 Installation Precautions	11
1-2 Product Specifications	12
1-3 System Block Diagram	15
Chapter 2 System Appearance	17
2-1 Front View	17
2-2 Rear View	17
2-3 Front Panel LED and Buttons	18
2-4 System LAN LEDs	19
2-5 Power Supply Unit LED	20
2-6 Hard Disk Drive LEDs	21
Chapter 3 System Hardware Installation	23
3-1 Removing Chassis Cover	24
3-2 Removing and Installing the Fan Duct	25
3-3 Installing the CPU and Heat Sink	26
3-4 Installing the Memory	28
3-4-1 Eight Channel Memory Configuration	28
3-4-2 Installing a Memory	29
3-4-3 Memory Population Table	29
3-5 Installing the PCI Expansion Card	30
3-6 Installing the GPU Card	31
3-7 Installing the Hard Disk Drive	32
3-8 Installing the Mezzanine Card	33
3-9 Installing and Removing an M.2 Solid State Drive	34
3-10 Replacing the Power Supply	35
3-11 Cable Routing	36
Chapter 4 Motherboard Components	39
4-1 Motherboard Components	39
4-2 Jumper Settings	41
Chapter 5 BIOS Setup	43
5-1 The Main Menu	45
5-2 Advanced Menu	48
5-2-1 Trusted Computing	49
5-2-2 Serial Port Console Redirection	50

5-2-3	SIO Configuration	54
5-2-4	PCI Subsystem Settings	55
5-2-5	USB Configuration	56
5-2-6	Network Stack Configuration	57
5-2-7	Post Report Configuration	58
5-2-8	NVMe Configuration	59
5-2-9	Chipset Configuration	60
5-2-10	Tls Auth Configuration	61
5-2-11	iSCSI Configuration	62
5-3	Chipset Setup Menu	63
5-3-1	Processor Configuration	64
5-3-2	Common RefCode Configuration	67
5-3-3	UPI Configuration	68
5-3-4	Memory Configuration	69
5-3-5	IIO Configuration	73
5-3-6	Advanced Power Management Configuration	75
5-3-7	PCH Configuration.....	78
5-3-8	Miscellaneous Configuration	80
5-3-9	Server ME Configuration	81
5-3-10	Runtime Error Logging	82
5-3-11	Power Policy.....	84
5-4	Server Management Menu.....	86
5-4-1	System Event Log	88
5-4-2	View FRU Information	89
5-4-3	BMC VLAN Configuration.....	90
5-4-4	BMC Network Configuration	91
5-4-5	IPv6 BMC Network Configuration	92
5-5	Security Menu	93
5-5-1	Secure Boot	94
5-6	Boot Menu.....	96
5-6-1	UEFI NETWORK Drive BBS Priorities	98
5-7	Save & Exit Menu.....	99
5-8	BIOS POST Codes	101
5-8-1	AMI Standard - PEI.....	101
5-8-2	AMI Standard - DXE	101
5-8-3	AMI Standard - ERROR	103
5-8-4	Intel UPI POST Codes	104
5-8-5	Intel UPI Error Codes	104
5-8-6	Intel MRC POST Codes	105
5-8-7	Intel MRC Error Codes	105
5-8-8	Intel PM POST Codes	106

5-8-9	Intel PM POST Codes	106
5-9	BIOS POST Beep code (AMI standard)	107
5-9-1	PEI Beep Codes	107
5-9-2	DXE Beep Codes	107

This page intentionally left blank

Chapter 1 Hardware Installation

1-1 Installation Precautions

The motherboard/system contain numerous delicate electronic circuits and components which can become damaged as a result of electrostatic discharge (ESD). Prior to installation, carefully read the service guide and follow these procedures:

- Prior to installation, do not remove or break motherboard S/N (Serial Number) sticker or warranty sticker provided by your dealer. These stickers are required for warranty validation.
- Always remove the AC power by unplugging the power cord from the power outlet before installing or removing the motherboard or other hardware components.
- When connecting hardware components to the internal connectors on the motherboard, make sure they are connected tightly and securely.
- When handling the motherboard, avoid touching any metal leads or connectors.
- It is best to wear an electrostatic discharge (ESD) wrist strap when handling electronic components such as a motherboard, CPU or memory. If you do not have an ESD wrist strap, keep your hands dry and first touch a metal object to eliminate static electricity.
- Prior to installing the motherboard, please have it on top of an antistatic pad or within an electrostatic shielding container.
- Before unplugging the power supply cable from the motherboard, make sure the power supply has been turned off.
- Before turning on the power, make sure the power supply voltage has been set according to the local voltage standard.
- Before using the product, please verify that all cables and power connectors of your hardware components are connected.
- To prevent damage to the motherboard, do not allow screws to come in contact with the motherboard circuit or its components.
- Make sure there are no leftover screws or metal components placed on the motherboard or within the computer casing.
- Do not place the computer system on an uneven surface.
- Do not place the computer system in a high-temperature environment.
- Turning on the computer power during the installation process can lead to damage to system components as well as physical harm to the user.
- If you are uncertain about any installation steps or have a problem related to the use of the product, please consult a certified computer technician.







1-2 Product Specifications



NOTE:

We reserve the right to make any changes to the product specifications and product-related information without prior notice.

	CPU	<ul style="list-style-type: none"> ◆ 3rd Generation Intel® Xeon® Scalable Processors ◆ Intel® Xeon® Platinum Processor, Intel® Xeon® Gold Processor, Intel® Xeon® Silver Processor ◆ 10nm technology, CPU TDP up to 270W
	Socket	<ul style="list-style-type: none"> ◆ 1 x LGA 4189 ◆ Socket P+
	Chipset	<ul style="list-style-type: none"> ◆ Intel® C621A Express Chipset
	Memory	<ul style="list-style-type: none"> ◆ 16 x DIMM slots ◆ DDR4 memory supported only ◆ 8-channel memory architecture per processor ◆ RDIMM modules up to 64GB supported ◆ LRDIMM modules up to 128GB supported ◆ 3DS RDIMM/LRDIMM modules up to 256GB supported ◆ 1.2V modules: 3200/2933/2666 MHz
	LAN	<ul style="list-style-type: none"> ◆ 1 x 10/100/1000 management LAN
	Video	<ul style="list-style-type: none"> ◆ Integrated in Aspeed® AST2600 ◆ 2D Video Graphic Adapter with PCIe bus interface ◆ 1920x1200@60Hz 32bpp, DDR4 SDRAM
	Storage	<ul style="list-style-type: none"> ◆ 2 x 2.5" SATA/SAS/Gen4 NVMe hot-swappable HDD/SSD bays
SAS card is required for SAS devices support		
	RAID	<ul style="list-style-type: none"> ◆ Intel® SATA RAID 0/1/10/5
	Expansion Slot	<ul style="list-style-type: none"> ◆ 1 x Full-height Full-length PCIe Gen4 x16 expansion slot ◆ 2 x Low-Profile PCIe Gen4 x16 expansion slots ◆ 1 x OCP 3.0 Gen4 x16 mezzanine slot
2 x M.2 slots:		
<ul style="list-style-type: none"> ◆ M-key ◆ PCIe Gen4 x4 from CPU ◆ Supports NGFF-2280/22110 cards 		
1 x M.2 slot:		
<ul style="list-style-type: none"> ◆ M-key ◆ PCIe Gen3 x4 from C621A ◆ Supports NGFF-2280/22110 card 		

	Internal I/O	<ul style="list-style-type: none"> ◆ 3 x M.2 slot ◆ 2 x SATA ports ◆ 1 x TPM header
	Front I/O	<ul style="list-style-type: none"> ◆ 2 x USB 3.0 ◆ 1 x miniDP ◆ 1 x MLAN ◆ 1 x Power button with LED ◆ 1 x ID button with LED ◆ 1 x System status LED
	Backplane I/O	<ul style="list-style-type: none"> ◆ Bandwidth: SATA 6Gb/s or SAS 12Gb/s per port or PCIe Gen4 x4
	TPM	<ul style="list-style-type: none"> ◆ 1 x TPM header with SPI interface ◆ Optional TPM2.0 kit: CTM010
	Power Supply	<ul style="list-style-type: none"> ◆ Redundant 800W 80 PLUS Platinum hot-swap power supply
	System Management	<ul style="list-style-type: none"> ◆ Aspeed® AST2600 management controller ◆ GIGABYTE Management Console (AMI MegaRAC SP-X) web interface ◆ Dashboard ◆ JAVA Based Serial Over LAN ◆ HTML5 KVM ◆ Sensor Monitor (Voltage, RPM, Temperature, CPU Status ...etc.) ◆ Sensor Reading History Data ◆ FRU Information ◆ SEL Log in Linear Storage / Circular Storage Policy ◆ Hardware Inventory ◆ Fan Profile ◆ System Firewall ◆ Power Consumption ◆ Power Control ◆ LDAP / AD / RADIUS Support ◆ Backup & Restore Configuration ◆ Remote BIOS/BMC/CPLD Update ◆ Event Log Filter ◆ User Management ◆ Media Redirection Settings ◆ PAM Order Settings ◆ SSL Settings ◆ SMTP Settings



Environment

Ambient
Temperature

- ◆ Operating temperature: 10°C to 35°C
- ◆ Non-operating temperature: -40°C to 60°C
- ◆

Relative
Humidity

- ◆ Operating humidity: 8-80% (non-condensing)
- ◆ Non-operating humidity: 20%-95% (non-condensing)

NOTE! Ambient temperature limited to 30°C if using 280W CPU



System

Dimension

- ◆ 1U
- ◆ 438mm (W) x 43.5mm (H) x 500mm (D)

1-3 System Block Diagram

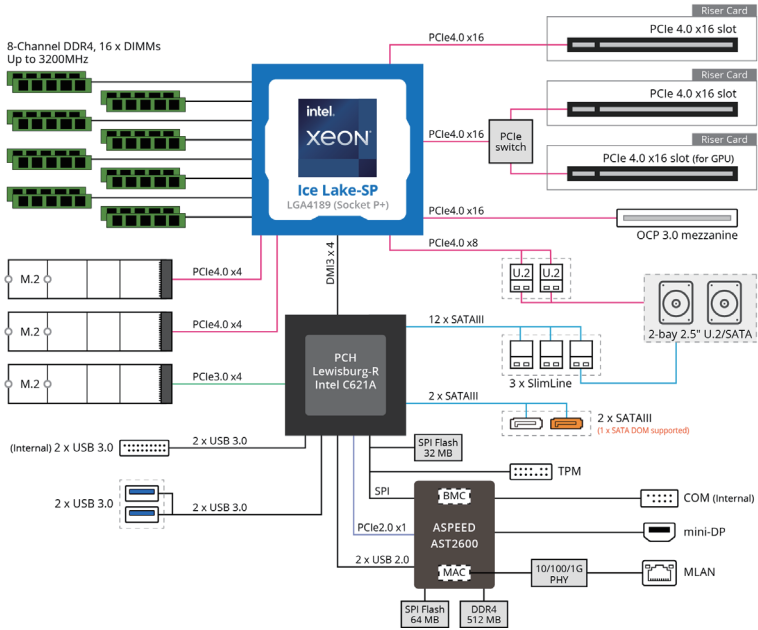

This page intentionally left blank

Chapter 2 System Appearance

2-1 Front View

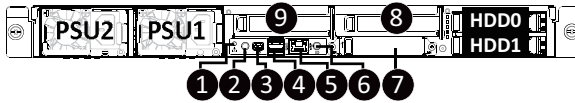

No.	Description
1.	System Status LED
2.	Power Button with LED
3.	Mini DP Port
4.	USB 3.0 Port x 2
5.	10/100/1000 Server Management LAN Port
6.	ID Button with LED
7.	Mezzanine Card Slot (Option/OCP 3)
8.	PCIe Card Slot
9.	PCIe Card Slot

NOTE! The Green HDD Latch Supports NVMe



- Please Go to Chapter **2-3 Front Panel LED** and Buttons for detail description of function LEDs.

2-2 Rear View

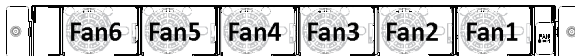

2-3 Front Panel LED and Buttons

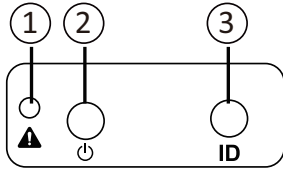

No.	Name	Color	Status	Description
1.	System Status LED	Green	On	System is operating normally.
		Amber	On	Critical condition, may indicate: System fan failure System temperature
			Blink	Non-critical condition, may indicate: Redundant power module failure Temperature and voltage issue Chassis intrusion
		N/A	Off	System is not ready, may indicate: POST error Processor or terminator missing
2.	Power button with LED	Green	On	System is powered on
		Green	Blink	System is in ACPI S1 state (sleep mode)
		N/A	Off	<ul style="list-style-type: none"> System is not powered on or in ACPI S5 state (power off) System is in ACPI S4 state (hibernate mode)
3.	ID Button			This LED represents the RoT function LED behavior. Please see the following section for detail LED behavior.

2-4 System LAN LEDs

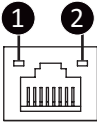

No.	Name	Color	Status	Description
1.	1GbE Speed LED	Yellow	On	1Gbps data rate
		Green	On	100 Mbps data rate
		N/A	Off	10 Mbps data rate
2.	1GbE Link/ Activity LED	Green	On	Link between system and network or no access
			Blink	Data transmission or receiving is occurring
		N/A	Off	No data transmission or receiving is occurring

2-5 Power Supply Unit LED

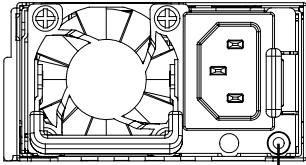

PSU LED

State	Description
OFF	No AC power to all power supplies
1Hz Green Blinking	AC present / only standby on / Cold redundant mode
2Hz Green Blinking	Power supply firmware updating mode
Amber	AC cord unplugged or AC power lost; with a second power supply in parallel still with AC input power
	Power supply critical event causing shut down: failure, OCP, OVP, fan failure and UVP
1 Hz Amber Blinking	Power supply warning events where the power supply continues to operate: high temp, high power, high current and slow fan

2-6 Hard Disk Drive LEDs



RAID SKU		LED1	Locate	HDD Fault	Rebuilding	HDD Access	HDD Present (No Access)
No RAID configuration (via HBA)	Disk LED (LED on Back Panel)	Green	ON(*1)	OFF		BLINK (*2)	OFF
		Amber	OFF	OFF		OFF	OFF
	Removed HDD Slot (LED on Back Panel)	Green	ON(*1)	OFF		--	--
		Amber	OFF	OFF		--	--
RAID configuration (via HW RAID Card or SW RAID Card)	Disk LED	Green	ON	OFF		BLINK (*2)	OFF
		Amber	OFF	ON	(Low Speed: 2 Hz)	OFF	OFF
	Removed HDD Slot	Green	ON(*1)	OFF	(*3)	--	--
		Amber	OFF	ON	(*3)	--	--

LED 2	HDD Present	No HDD
Green	ON	OFF

NOTE:

- *1: Depends on HBA/Utility Spec.
- *2: Blink cycle depends on HDD's activity signal.
- *3: If HDD is pulled out during rebuilding, the disk status of this HDD is regarded as faulty.

This page intentionally left blank

Chapter 3 System Hardware Installation



Pre-installation Instructions

Computer components and electronic circuit boards can be damaged electrostatic discharge. Working on computers that are still connected to a power supply can be extremely dangerous. Follow the simple guidelines below to avoid damage to your computer or injury to yourself.

- Always disconnect the computer from the power outlet whenever you are working inside the computer case.
- If possible, wear a grounded wrist strap when you are working inside the computer case. Alternatively, discharge any static electricity by touching the bare metal system of the computer case, or the bare metal body of any other grounded appliance.
- Hold electronic circuit boards by the edges only. Do not touch the components on the board unless it is necessary to do so. Do not flex or stress the circuit board.
- Leave all components inside the static-proof packaging until you are ready to use the component for the installation.

3-1 Removing Chassis Cover



Before you remove or install the system cover

- Make sure the system is not turned on or connected to AC power.

Follow these instructions to remove the rear system cover:

1. Push the plastic handle.
2. Pull the grip handle to open the panel cover.
3. Slide the cover to the front of the system and then remove the cover in the direction indicated by the arrow.
4. To reinstall the chassis cover reverse steps 1-3.

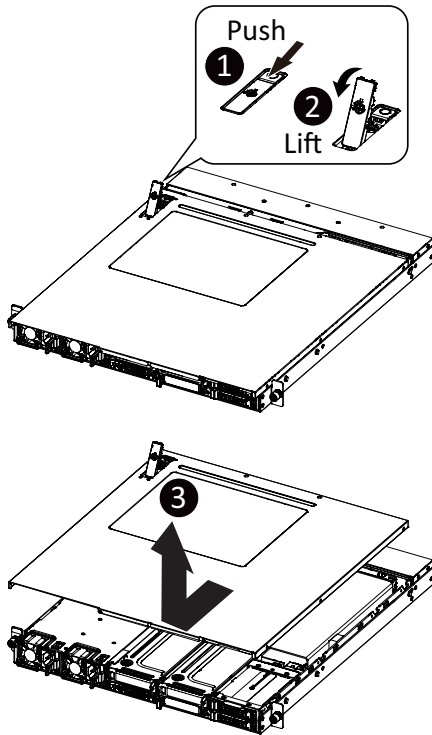

3-2 Removing and Installing the Fan Duct

Follow these instructions to remove/install the fan duct:

1. Remove the two screws securing the fan duct.
2. Lift up to remove the fan duct
3. To install the fan duct, align the fan duct with the guiding groove. Push down the fan duct into chassis until its firmly seats.

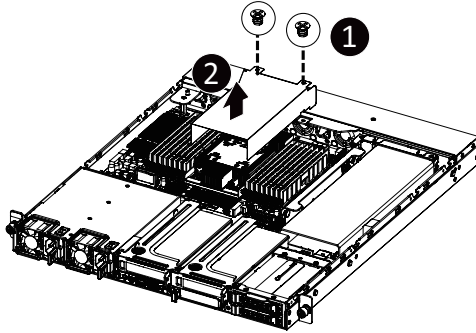

3-3 Installing the CPU and Heat Sink



Read the following guidelines before you begin to install the CPU:

- Make sure that the motherboard supports the CPU.
- Always turn off the computer and unplug the power cord from the power outlet before installing the CPU to prevent hardware damage.
- Unplug all cables from the power outlets.
- Disconnect all telecommunication cables from their ports.
- Place the system unit on a flat and stable surface.
- Open the system according to the instructions.



WARNING!

Failure to properly turn off the server before you start installing components may cause serious damage. Do not attempt the procedures described in the following sections unless you are a qualified service technician.

Follow these instructions to install the CPU:

1. Align the processor to the carrier so that the gold triangle on the processor aligns with the triangle on the carrier, and then install the processor into the carrier.

NOTE: Apply thermal compound evenly on the top of the CPU.

2. Carefully flip the heatsink over. Align the carrier assembly so that the triangle on the carrier aligns with the triangle on the heatsink, and then install the carrier assembly onto the bottom of the heatsink.
3. Remove the CPU socket cover.

NOTE: Save and replace the CPU socket cover if the processor is removed from its socket.

4. Align the heatsink to the CPU socket using the guide pins and make sure the gold triangle is in the correct orientation. Then place the heatsink onto the top of the CPU socket.
5. Secure the heatsink by tightening the screws in sequential order (1→2→3→4).

NOTE: When removing the heatsink, loosen the screws in reverse order (4→3→2→1).

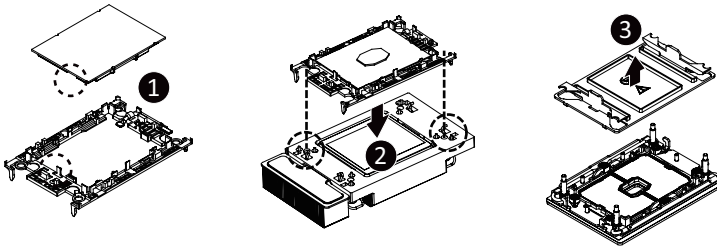

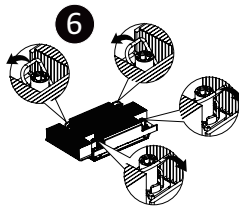
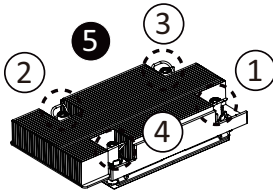
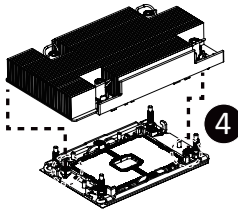

• To install/remove the Intel heatsink use a T30-Lobe screwdriver or drill bit with a screw torque of 8.0 +/- 0.5kgf*cm (8lb*in).

3-4 Installing the Memory



Read the following guidelines before you begin to install the memory:

- Make sure that the motherboard supports the memory. It is recommended that memory of the same capacity, brand, speed, and chips be used.
- Always turn off the computer and unplug the power cord from the power outlet before installing the memory to prevent hardware damage.
- Memory modules have a foolproof design. A memory module can be installed in only one direction. If you are unable to insert the memory, switch the direction.

3-4-1 Eight Channel Memory Configuration

This motherboard provides 16 DDR4 memory sockets and supports Eight Channel Technology. After the memory is installed, the BIOS will automatically detect the specifications and capacity of the memory. Enabling Four Channel memory mode will be four times of the original memory bandwidth.

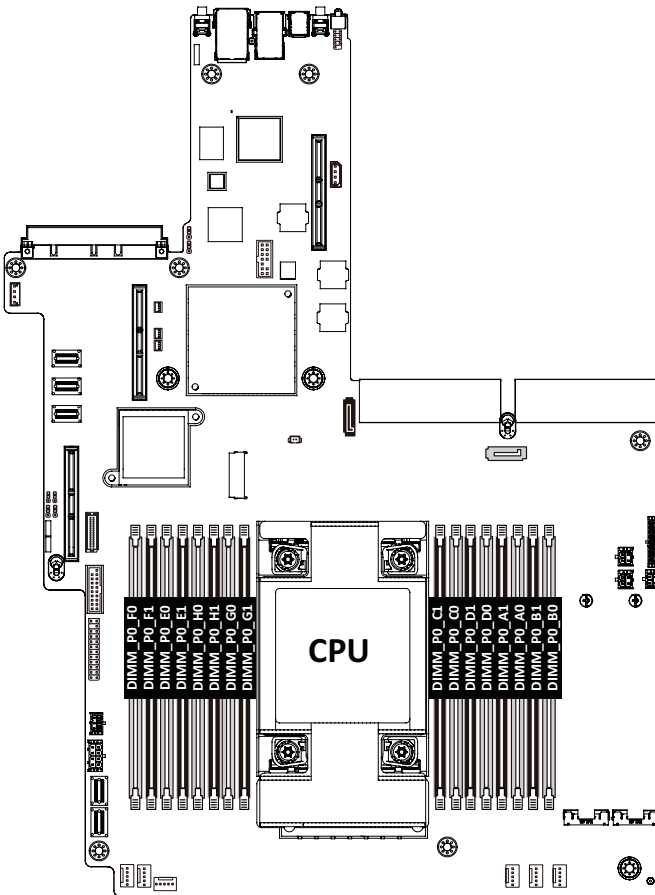

3-4-2 Installing a Memory



- Before installing a memory module, make sure to turn off the computer and unplug the power cord from the power outlet to prevent damage to the memory module.
- Be sure to install DDR4 DIMMs on this motherboard.
- Be sure all populated DIMMs have same capacity.

Follow these instructions to install the Memory:

1. Insert the DIMM memory module vertically into the DIMM slot, and push it down.
2. Close the plastic clip at both edges of the DIMM slots to lock the DIMM module.
3. Reverse the installation steps when you want to remove the DIMM module.

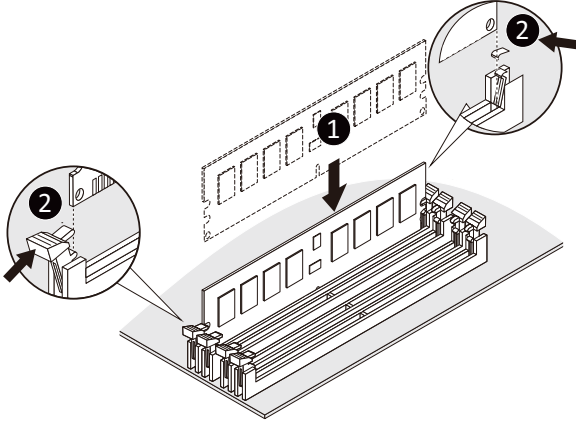

3-4-3 Memory Population Table



- When only one DIMM is used, it must be populated in memory slot DIMM0.

Type	Ranks Per DIMM and Data Width	DIMM Capacity (GB)		Speed (MT/s); Voltage (V); Slots per Channel(SPC) and DIMM per Channel (DPC)	
		8Gb	16Gb	DIMM per Channel (DPC)	
				1DPC	2DPC
		8Gb	16Gb	1.2V	1.2V
RDIMM	SRx8	8GB	16GB	3200	3200
RDIMM	SRx4	16GB	32GB		
RDIMM	DRx8	16GB	32GB		
RDIMM	DRx4	32GB	64GB		
RDIMM 3DS	(4R/8R)x4	2H-64GB 4H-128GB	2H-128GB 4H-256GB		
LRDIMM	QRx4	64GB	128GB	3200	3200
LRDIMM 3DS	(4R/8R)x4	4H-128GB	2H-128GB 4H-256GB	3200	3200

3-5 Installing the PCI Expansion Card



- Voltages can be present within the server whenever an AC power source is connected. This voltage is present even when the main power switch is in the off position. Ensure that the system is powered-down and all power sources have been disconnected from the server prior to installing a PCI card.

Failure to observe these warnings could result in personal injury or damage to equipment.



- The PCI riser assembly does not include a riser card or any cabling as standard. To install a PCI card, a riser card must be installed.

Follow these instructions to PCI Expansion card:

1. Remove the screws on the riser bracket
2. Lift up the riser bracket out of system.
3. Remove the slot covers from the riser bracket.
4. Orient the PCIe card with the riser guide slot and push in the direction of the arrow until the PCIe card sits in the PCI card connector.
5. Secure the PCIe card with the screw.
6. Reverse the steps 3 - 1 to install the riser bracket.

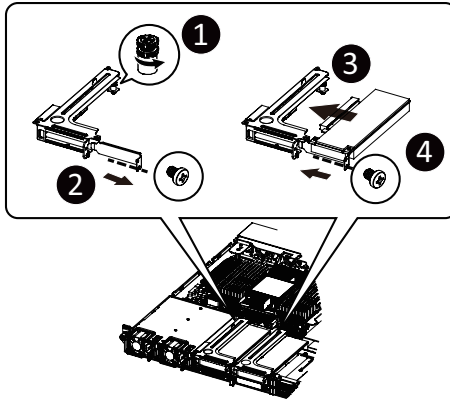

3-6 Installing the GPU Card



Before you install the GPU card:

- Voltages can be present within the server whenever an AC power source is connected. This voltage is present even when the main power switch is in the off position. Ensure that the system is powered down and all power sources have been disconnected from the server prior to installing a GPU card. Make sure the system is not turned on or connected to AC power.
- Failure to observe these warnings could result in personal injury or damage to the equipment.

Follow these instructions to install the GPU card:

1. Loosen the two thumbscrews securing on the riser bracket.
2. Remove the two screws securing the GPU card slot covers in place and remove the GPU card slot covers.
3. Insert the GPU card into the selected slot. Make sure the GPU card is properly seated.
4. Install the two screws to secure the GPU card in place.

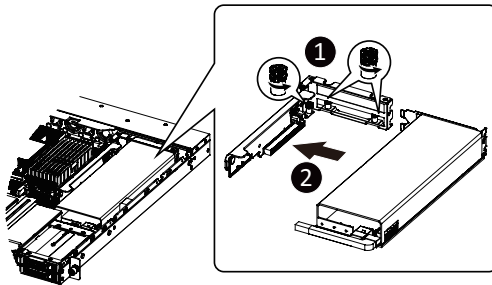

3-7 Installing the Hard Disk Drive



Read the following guidelines before you begin to install the Hard disk drive:

- Take note of the drive tray orientation before sliding it out.
- The tray will not fit back into the bay if inserted incorrectly.
- Make sure that the HDD is connected to the HDD connector on the backplane.

Follow these instructions to install a 2.5" hard disk drive:

1. Press the release button.
2. Extend the locking lever.
3. Pull the locking lever to remove the HDD tray.
4. Align the hard disk drive with the positioning stub on the HDD tray.
5. Slide hard disk drive into the blank HDD tray.
6. Reinsert the HDD tray into the slot and close the locking lever.

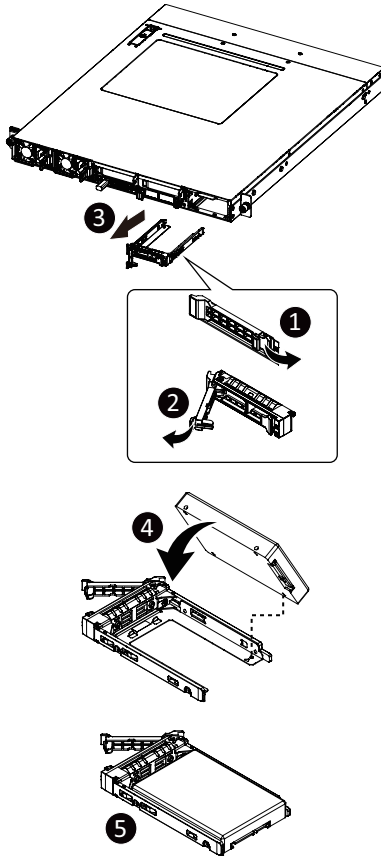

3-8 Installing the Mezzanine Card



Use of the following type of OCP 3.0 NIC is recommended:

- OCP 3.0 SFF with Pull Tab
- OCP 3.0 SFF with Ejector Latch

Follow these instructions to install an OCP 3.0 mezzanine card:

1. Remove the two screws securing the mezzanine card slot cover.
2. Remove the slot cover from the system.
3. Insert the OCP 3.0 mezzanine card into the card slot ensuring that the card is firmly connected to the connector on the motherboard.
4. Tighten the thumbnail screw to secure the OCP 3.0 mezzanine card in place.
5. Reverse steps 3-4 to replace the OCP 3.0 mezzanine card.

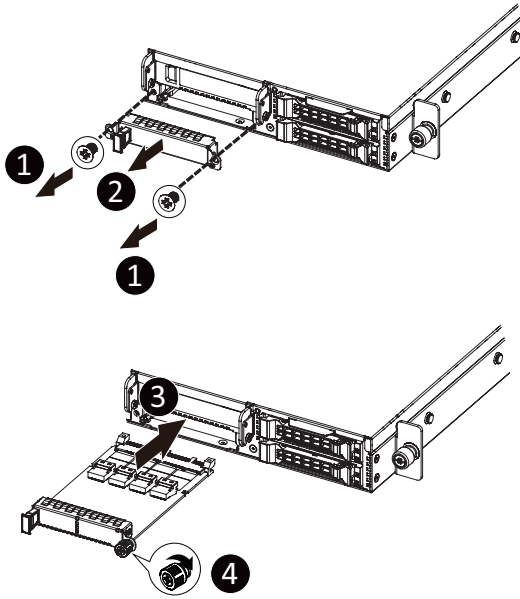

3-9 Installing and Removing an M.2 Solid State Drive



WARNING:

Installation of the thermal pad over the M.2 device is required when installing an M.2 device. Lack of the thermal pad may result in system overheating and throttle the system performance.



CAUTION:

The position of the stand-off screw will depend on the size of the M.2 device. The stand-off screw is pre-installed for 22110 cards as standard. Refer to the size of the M.2 device and change the position of the stand-off screw accordingly.



NOTE:

To install/remove the M.2 heatsink use a No. 1 Phillips-head screwdriver with a screw torque of $1.5 \pm 0.2 \text{ kgf}\cdot\text{cm}$

Follow these instructions to install an optional M.2 solid state drive (SSD):

1. Insert the M.2 device into the M.2 connector.
2. Install the thermal pad of the M.2 device to the M.2 device.
3. Press down on the thermal pad.
4. Secure the M.2 device and its thermal pad to the motherboard with a single screw.
5. Reverse steps 1-4 to remove the M.2 device and the heatsink.

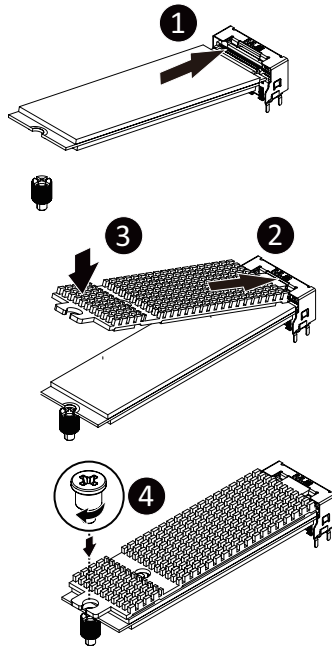

3-10 Replacing the Power Supply

Follow these instructions to replace the power supply:

1. Press the retaining clip on the left side of the power supply unit along the direction of the arrow.
2. Pull the power supply handle at the same time and pull out the power supply unit.
3. Insert the replacement power supply unit firmly into the chassis. Connect the AC power cord to the replacement power supply.
4. Repeat steps 1-3 for replacement of the second power supply.

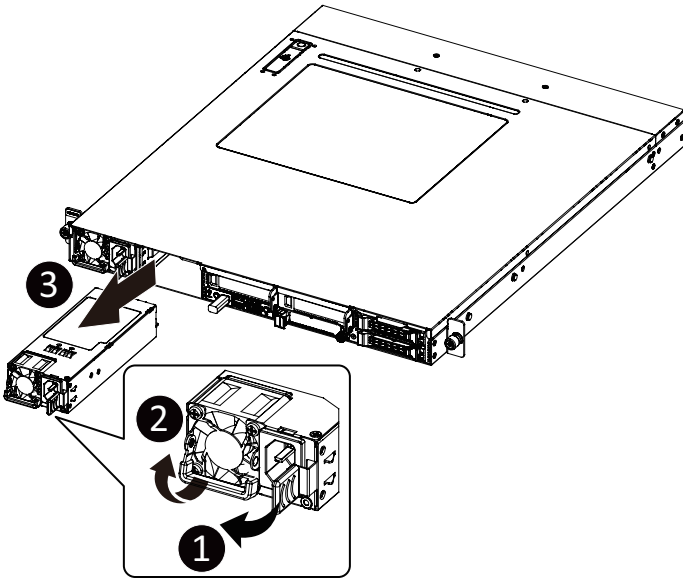

3-11 Cable Routing

HDD Back Plane Board Power Cable

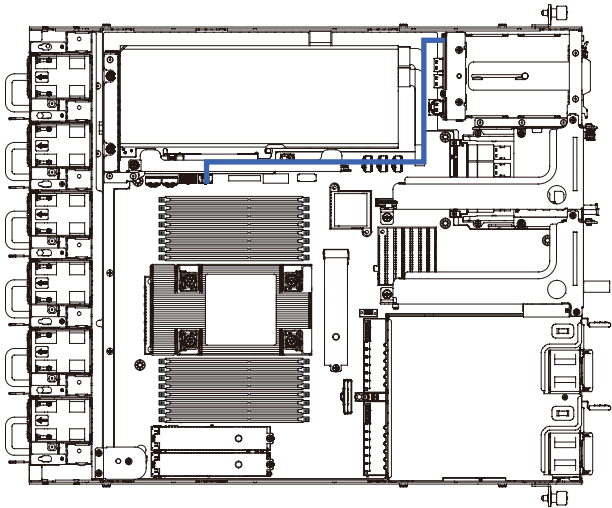

HDD Back Plane Board Signal Cable

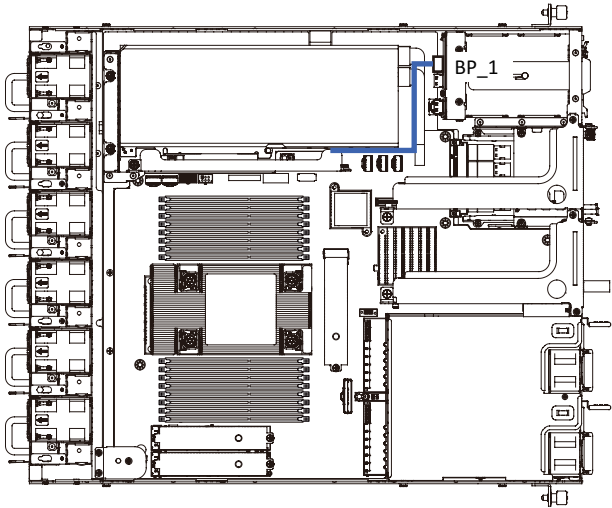

U.2 NMVe to HDD Back Plane Board Cable (NMVe0)

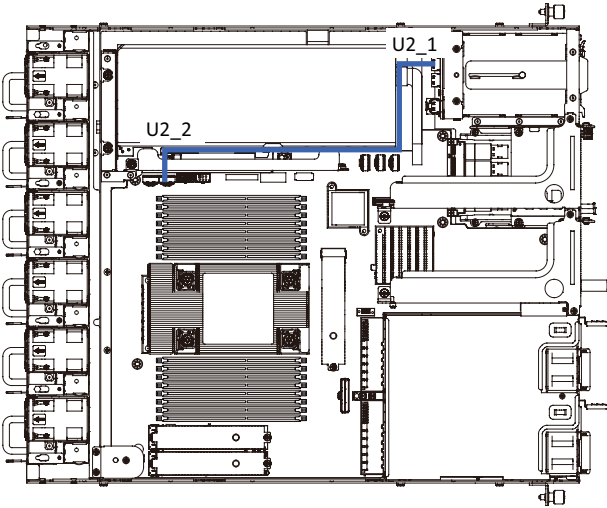

U.2 NMVe to HDD Back Plane Board Cable (NMVe1)

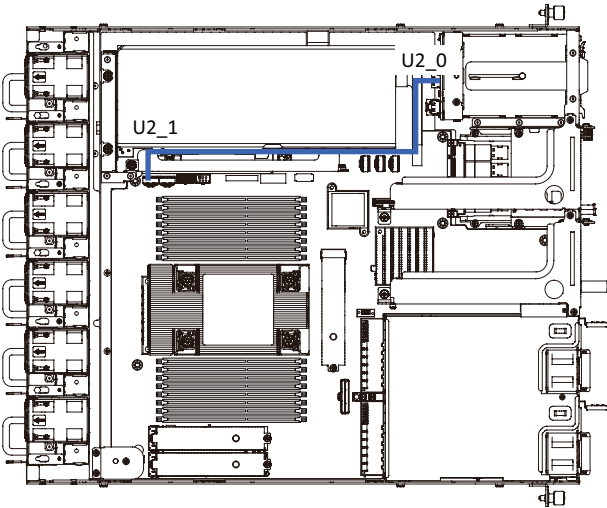

On-Board SATA to HDD Back Plane Board Cable

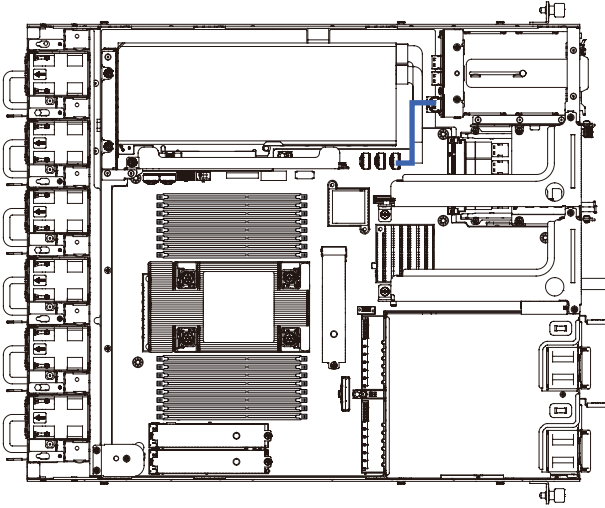

GPU Card Power Cable (Recommend)

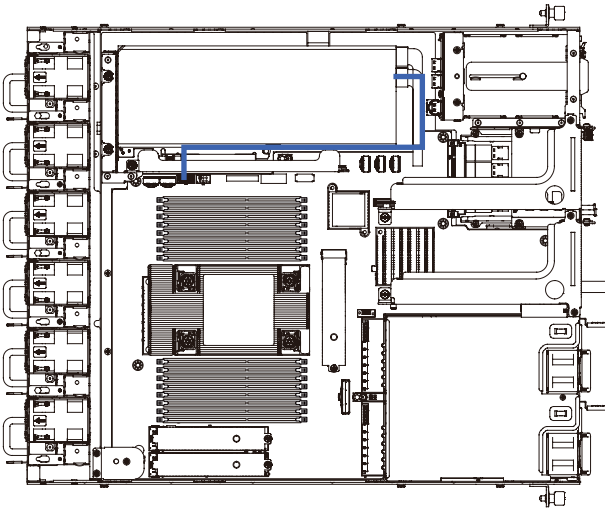

Chapter 4 Motherboard Components

4-1 Motherboard Components

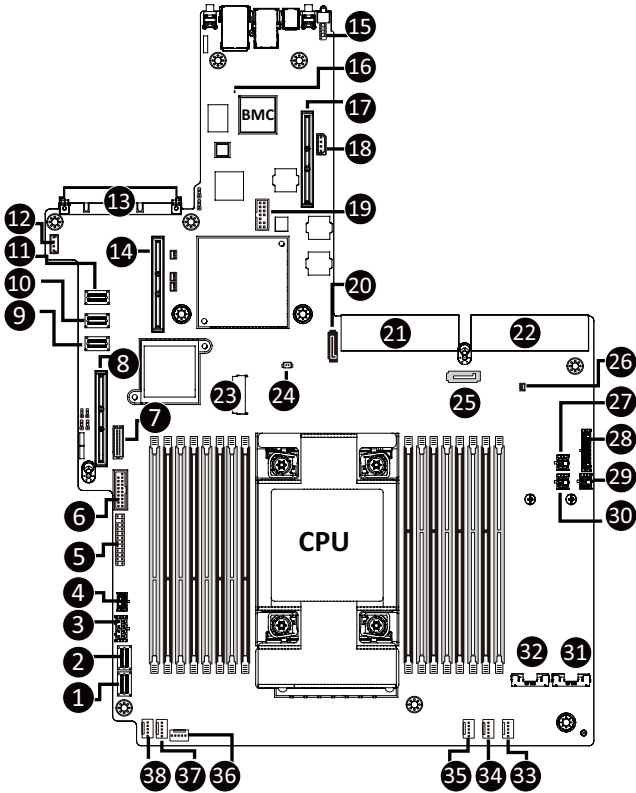

Item	Description
1	SlimLine SAS Connector (U2_1/PCIe Gen4)
2	SlimLine SAS Connector (U2_2/PCIe Gen4)
3	2 x 4 GPU Card Power Connector (P12V_GPU)
4	2 x 3 Front HDD Back Plane Board Connector
5	Front Panel Connector
6	Front Panel USB 3.0 Connector
7	HDD Back Plane Board Connector
8	PCIe x16 Connector (GEN3/Gen4 Signal)
9	SlimLine SAS Connector (SL_CN2/SATA Signal)

10	SlimLine SAS Connector (SL_CN1/SATA Signal)
11	SlimLine SAS Connector (SL_CN3/SATA Signal)
12	VROC Upgrade Module Connector
13	OCP Mezzanine Connector (OCP 3.0/SFF/Gen4 x16)
14	PCIe x16 Connector (GENZ_2/Gen4 Signal)
15	Serial Port Cable Connector
16	BMC Firmware Readiness LED
17	PCIe x16 Connector (GENZ1/Gen4 Signal)
18	IPMB Connector
19	TPM Module Connector (SPI Interface)
20	SATA Connector (SSATA4)
21	Power Supply Connector#1 (Primary)
22	Power Supply Connector#2 (Secondary)
23	M.2 Connector (PCIe Gen4 x 4/NGFF-22110)
24	System Battery Cable Connector
25	SATA Connector (SSATA5)
26	SATA DOM Support Power Connector (for SSATA5)
27	2 x 2 Rear HDD Back Plane Board Connector*
28	2 x 2 Rear HDD Back Plane Board Connector*
29	2 x 2 Rear HDD Back Plane Board Connector*
30	2 x 2 Rear HDD Back Plane Board Connector*
31	M.2 Connector (PCIe Gen4 x 4/NGFF-22110)
32	M.2 Connector (PCIe Gen4 x 4/NGFF-22110)
33	System Fan Connector (SYS_FAN1)
34	System Fan Connector (SYS_FAN2)
35	System Fan Connector (SYS_FAN3)
36	System Fan Connector (SYS_FAN4)
37	System Fan Connector (SYS_FAN5)
38	System Fan Connector (SYS_FAN6)



NOTE! Function available on selected models

4-2 Jumper Settings

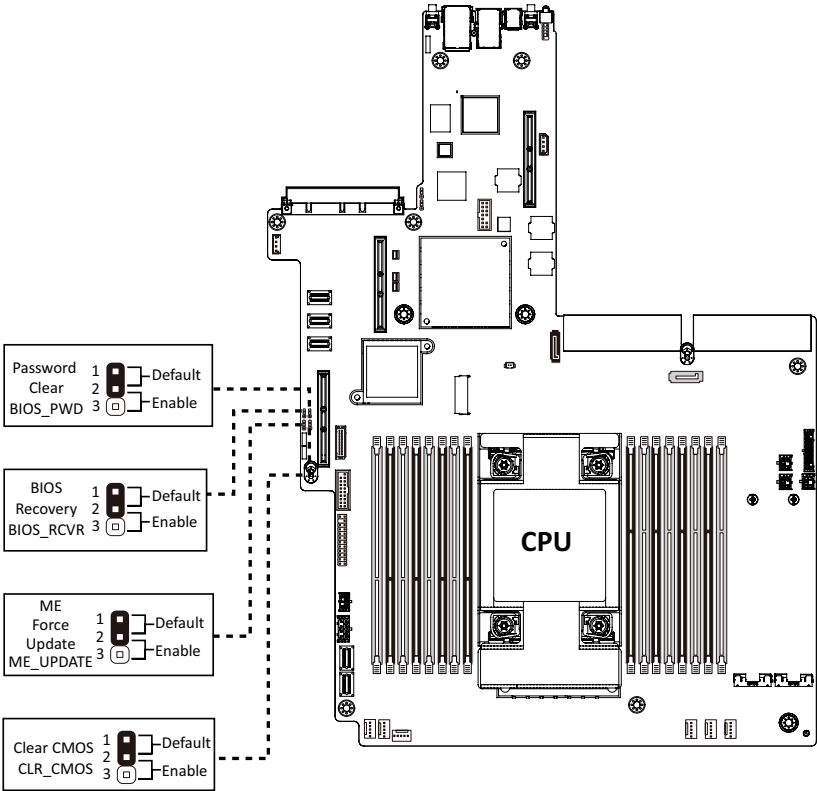

This page intentionally left blank

Chapter 5 BIOS Setup

BIOS (Basic Input and Output System) records hardware parameters of the system in the EFI on the motherboard. Its major functions include conducting the Power-On Self-Test (POST) during system startup, saving system parameters, loading the operating system etc. The BIOS includes a BIOS Setup program that allows the user to modify basic system configuration settings or to activate certain system features. When the power is turned off, the battery on the motherboard supplies the necessary power to the CMOS to keep the configuration values in the CMOS.

To access the BIOS Setup program, press the key during the POST when the power is turned on.



- BIOS flashing is potentially risky, if you do not encounter any problems when using the current BIOS version, it is recommended that you don't flash the BIOS. To flash the BIOS, do it with caution. Inadequate BIOS flashing may result in system malfunction.
- It is recommended that you not alter the default settings (unless you need to) to prevent system instability or other unexpected results. Inadequately altering the settings may result in system's failure to boot. If this occurs, try to clear the CMOS values and reset the board to default values. (Refer to the **Exit** section in this chapter or introductions of the battery/clearing CMOS jumper in Chapter 4 for how to clear the CMOS values.)

BIOS Setup Program Function Keys

<<-><->>	Move the selection bar to select the screen
<↑><↓>	Move the selection bar to select an item
<+>	Increase the numeric value or make changes
<->	Decrease the numeric value or make changes
<Enter>	Execute command or enter the submenu
<Esc>	Main Menu: Exit the BIOS Setup program Submenus: Exit current submenu
<F1>	Show descriptions of general help
<F3>	Restore the previous BIOS settings for the current submenus
<F9>	Load the Optimized BIOS default settings for the current submenus
<F10>	Save all the changes and exit the BIOS Setup program

■ **Main**

This setup page includes all the items of the standard compatible BIOS.

■ **Advanced**

This setup page includes all the items of AMI BIOS special enhanced features.

(ex: Auto detect fan and temperature status, automatically configure hard disk parameters.)

■ **Chipset**

This setup page includes all the submenu options for configuring the functions of the Platform Controller Hub.

■ **Server Management**

Server additional features enabled/disabled setup menus.

■ **Security**

Change, set, or disable supervisor and user password. Configuration supervisor password allows you to restrict access to the system and BIOS Setup.

A supervisor password allows you to make changes in BIOS Setup.

A user password only allows you to view the BIOS settings but not to make changes.

■ **Boot**

This setup page provides items for configuration of the boot sequence.

■ **Save & Exit**

Save all the changes made in the BIOS Setup program to the CMOS and exit BIOS Setup. (Pressing <F10> can also carry out this task.)

Abandon all changes and the previous settings remain in effect. Pressing <Y> to the confirmation message will exit BIOS Setup. (Pressing <Esc> can also carry out this task.)

5-1 The Main Menu

Once you enter the BIOS Setup program, the Main Menu (as shown below) appears on the screen. Use arrow keys to move among the items and press <Enter> to accept or enter other sub-menu.

Main Menu Help

The on-screen description of a highlighted setup option is displayed on the bottom line of the Main Menu.

Submenu Help

While in a submenu, press <F1> to display a help screen (General Help) of function keys available for the menu. Press <Esc> to exit the help screen. Help for each item is in the Item Help block on the right side of the submenu.



- When the system is not stable as usual, select the **Restore Defaults** item to set your system to its defaults.
- The BIOS Setup menus described in this chapter are for reference only and may differ by BIOS version.

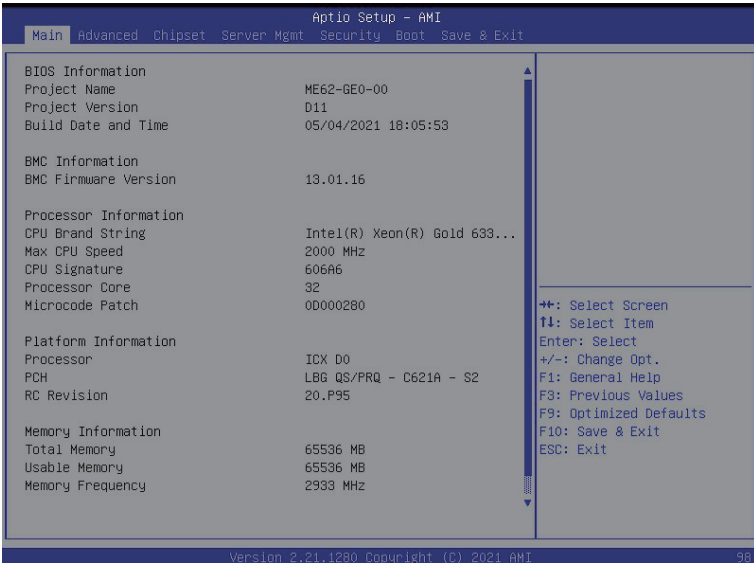

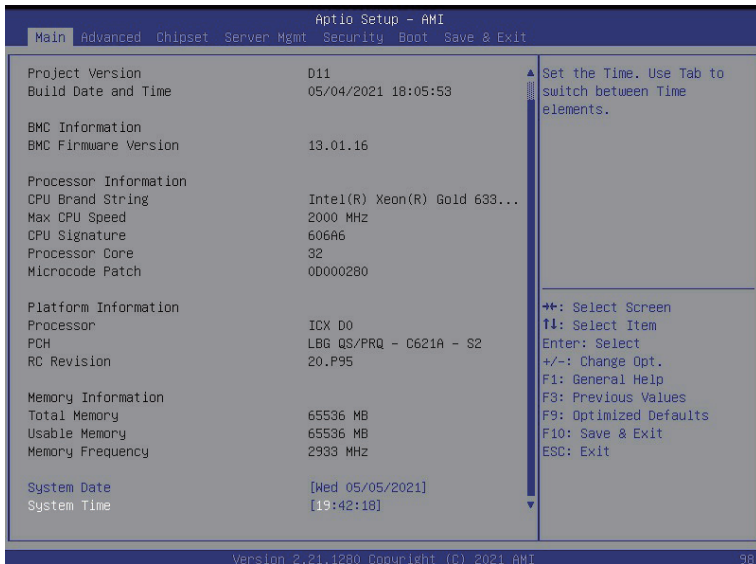

Parameter	Description
BIOS Information	
Project Name	Displays the project name information.
Project Version	Displays version number of the BIOS setup utility.
Build Date and Time	Displays the date and time when the BIOS setup utility was created.
BMC Information	
BMC Firmware Version	Displays BMC firmware version information.
Processor Information	
CPU Brand String/ Max CPU Speed / CPU Signature / Processor Core / Microcode Patch	Displays the technical specifications for the installed processor(s).
Platform Information	
Processor/ PCH/ RC Revision	Displays the platform information of the installed processor(s) and PCH.
Memory Information	
Total Memory ^(Note1)	Displays the total memory size of the installed memory.
Usable Memory ^(Note1)	Displays the usable memory size of the installed memory.
Memory Frequency ^(Note1)	Displays the frequency information of the installed memory.

(Note1) This section will display capacity and frequency information of the memory that the customer has installed.

Parameter	Description
System Date	Sets the date following the weekday-month-day-year format.
System Time	Sets the system time following the hour-minute-second format.

5-2 Advanced Menu

The Advanced Menu displays submenu options for configuring the function of various hardware components. Select a submenu item, then press <Enter> to access the related submenu screen.

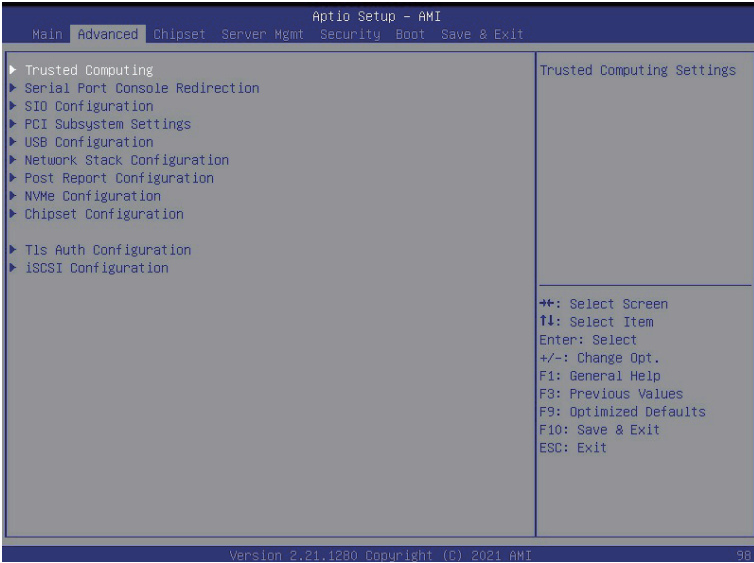

5-2-1 Trusted Computing



Parameter	Description
Configuration	
Security Device Support	Enable/Disable the TPM support feature. Options available: Enable/Disable. Default setting is Enable .
Current Status Information	Displays current TPM status information.

5-2-2 Serial Port Console Redirection



Parameter	Description
COM1 Console Redirection ^(Note)	<p>Console redirection enables the users to manage the system from a remote location.</p> <p>Options available: Enabled/Disabled. Default setting is Disabled.</p>
COM1 Console Redirection Settings	<p>Press [Enter] to configure advanced items.</p> <p>Please note that this item is configurable when COM1 Console Redirection is set to Enabled.</p> <ul style="list-style-type: none"> ◆ Terminal Type <ul style="list-style-type: none"> – Selects a terminal type to be used for console redirection. – Options available: VT100, VT100+, ANSI, VT-UTF8. Default setting is VT100+. ◆ Bits per second <ul style="list-style-type: none"> – Selects the transfer rate for console redirection. – Options available: 9600, 19200, 38400, 57600, 115200. Default setting is 115200. ◆ Data Bits <ul style="list-style-type: none"> – Selects the number of data bits used for console redirection. – Options available: 7/8. Default setting is 8.

(Note) Advanced items prompt when this item is defined.

Parameter	Description
COM1 Console Redirection Settings (continued)	<ul style="list-style-type: none"> ◆ Parity <ul style="list-style-type: none"> – A parity bit can be sent with the data bits to detect some transmission errors. – Even: parity bit is 0 if the num of 1's in the data bits is even. – Odd: parity bit is 0 if num of 1's in the data bits is odd. – Mark: parity bit is always 1. Space: Parity bit is always 0. – Mark and Space Parity do not allow for error detection. – Options available: None, Even, Odd, Mark, Space. Default setting is None. ◆ Stop Bits <ul style="list-style-type: none"> – Stop bits indicate the end of a serial data packet. (A start bit indicates the beginning). The standard setting is 1 stop bit. Communication with slow devices may require more than 1 stop bit. – Options available: 1/2. Default setting is 1. ◆ Flow Control <ul style="list-style-type: none"> – Flow control can prevent data loss from buffer overflow. When sending data, if the receiving buffers are full, a 'stop' signal can be sent to stop the data flow. Once the buffers are empty, a 'start' signal can be sent to re-start the flow. Hardware flow control uses two wires to send start/stop signals. – Options available: None, Hardware RTS/CTS. Default setting is None. ◆ VT-UTF8 Combo Key Support <ul style="list-style-type: none"> – Enable/Disable the VT-UTF8 Combo Key Support. – Options available: Enabled/Disabled. Default setting is Enabled. ◆ Recorder Mode^(Note) <ul style="list-style-type: none"> – When this mode enabled, only texts will be send. This is to capture Terminal data. – Options available: Enabled/Disabled. Default setting is Disabled. ◆ Resolution 100x31^(Note) <ul style="list-style-type: none"> – Enable/Disable extended terminal resolution. – Options available: Enabled/Disabled. Default setting is Enabled. ◆ Putty KeyPad^(Note) <ul style="list-style-type: none"> – Selects FunctionKey and LeyPad on Putty. – Options available: VT100, LINUX, XTERMR6, SC0, ESCN, VT400. Default setting is VT100.

(Note) Advanced items prompt when this item is defined.

Parameter	Description
Legacy Console Redirection	
Legacy Console Redirection Settings	<p>Press [Enter] to configure advanced items.</p> <ul style="list-style-type: none"> ◆ Redirection COM Port <ul style="list-style-type: none"> – Selects a COM port for Legacy serial redirection. – Default setting is COM1. ◆ Resolution <ul style="list-style-type: none"> – Selects the number of rows and columns used in Console Redirection for legacy OS support. – Options available: 80x24, 80x25. Default setting is 80x24. ◆ Redirect After POST <ul style="list-style-type: none"> – When Bootloader is selected, then Legacy Console Redirection is disabled before booting to legacy OS. When Always Enable is selected, then Legacy Console Redirection is enabled for legacy OS. – Options available: Always Enable, BootLoader. Default setting is Always Enable.
Serial Port for Out-of-Band Management / Windows Emergency Management Services (EMS) Console Redirection ^(Note)	<p>EMS console redirection allows the user to configure Console Redirection Settings to support Out-of-Band Serial Port management.</p> <p>Options available: Enabled/Disabled. Default setting is Disabled.</p>
Serial Port for Out-of-Band EMS Console Redirection Settings	<p>Press [Enter] to configure advanced items.</p> <p>Please note that this item is configurable when Serial Port for Out-of-Band Management EMS Console Redirection is set to Enabled.</p> <ul style="list-style-type: none"> ◆ Out-of-Band Mgmt Port <ul style="list-style-type: none"> – Microsoft Windows Emergency Management Service (EMS) allows for remote management of a Windows Server OS through a serial port. – Default setting is COM1. ◆ Terminal Type <ul style="list-style-type: none"> – Selects a terminal type to be used for console redirection. – Options available: VT100, VT100+, ANSI, VT-UTF8. Default setting is VT100+. ◆ Bits per second <ul style="list-style-type: none"> – Selects the transfer rate for console redirection. – Options available: 9600, 19200, 38400, 57600, 115200. Default setting is 115200.

(Note) Advanced items prompt when this item is defined.

Parameter	Description
Serial Port for Out-of-Band EMS Console Redirection Settings(continued)	<ul style="list-style-type: none">◆ Flow Control<ul style="list-style-type: none">– Flow control can prevent data loss from buffer overflow. When sending data, if the receiving buffers are full, a 'stop' signal can be sent to stop the data flow. Once the buffers are empty, a 'start' signal can be sent to re-start the flow. Hardware flow control uses two wires to send start/stop signals.– Options available: None, Hardware RTS/CTS, Software Xon/Xoff. Default setting is None.

5-2-3 SIO Configuration



Parameter	Description
AMI SIO Driver Version	Displays the AMI SIO driver version information.
Super IO Chip Logical Device(s) Configuration	<p>Press [Enter] to configure advanced items.</p> <ul style="list-style-type: none"> ◆ Use This Device <ul style="list-style-type: none"> – When set to Enabled allows you to configure the serial port settings. When set to Disabled, displays no configuration for the serial port. – Options available: Enabled/Disabled. Default setting is Enabled. ◆ Current: <ul style="list-style-type: none"> – Displays the serial port base I/O address and IRQ. ◆ Possible: <ul style="list-style-type: none"> – Configures the serial port base I/O address and IRQ. <p>Use Automatic Settings IO=3F8h; IRQ=4; DMA; IO=3F8h; IRQ=3, 4, 5, 7, 9, 10, 11, 12; DMA; IO=2F8h; IRQ=3, 4, 5, 7, 9, 10, 11, 12; DMA; IO=3E8h; IRQ=3, 4, 5, 7, 9, 10, 11, 12; DMA; IO=2E8h; IRQ=3, 4, 5, 7, 9, 10, 11, 12; DMA; Default setting is Use Automatic Settings.</p>
[*Active*] Serial Port	

5-2-4 PCI Subsystem Settings



Parameter	Description
PCI Bus Driver Version	Displays the PCI Bus Driver version information.
PCI Express Slot # I/O ROM ^(Note1)	When enabled, this setting will initialize the device expansion ROM for the related PCI-E slot. Options available: Enabled/Disabled. Default setting is Enabled .
PCI Devices Common Settings	
Above 4G Decoding	Enable/Disable memory mapped I/O to 4GB or greater address space (Above 4G Decoding). Options available: Enabled/Disabled. Default setting is Enabled .
SR-IOV Support	If the system has SR-IOV capable PCIe devices, this item Enable/Disable Single Root IO Virtualization Support. Options available: Enabled/Disabled. Default setting is Enabled .

(Note1) This section is dependent on the available PCIe Slot.

5-2-5 USB Configuration

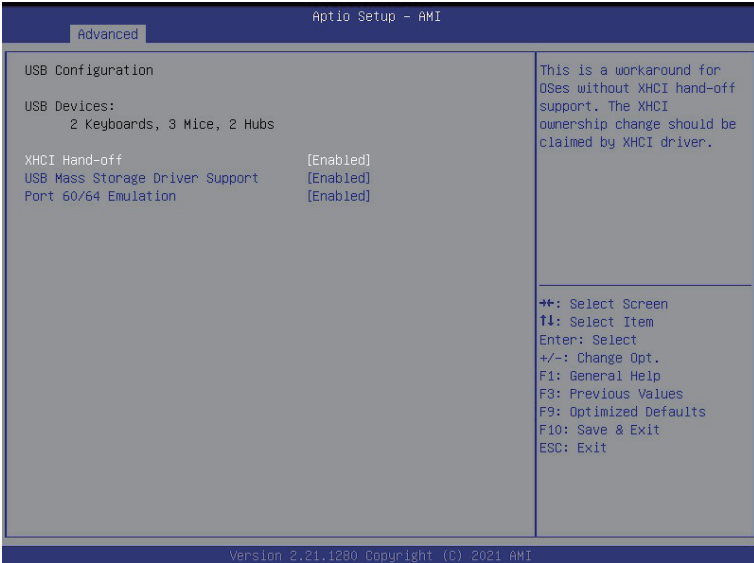

Parameter	Description
USB Configuration	
USB Devices:	Displays the USB devices connected to the system.
XHCI Hand-off	Enable/Disable the XHCI (USB 3.0) Hand-off support. Options available: Enabled/Disabled. Default setting is Enabled .
USB Mass Storage Driver Support ^(Note)	Enable/Disable the USB Mass Storage Driver Support. Options available: Enabled/Disabled. Default setting is Enabled .
Port 60/64 Emulation	Enables the I/O port 60h/64h emulation support. This should be enabled for the complete USB Keyboard Legacy support for non-USB aware OS. Options available: Enabled/Disabled. Default setting is Enabled .

(Note) This item is present only if you attach USB devices.

5-2-6 Network Stack Configuration

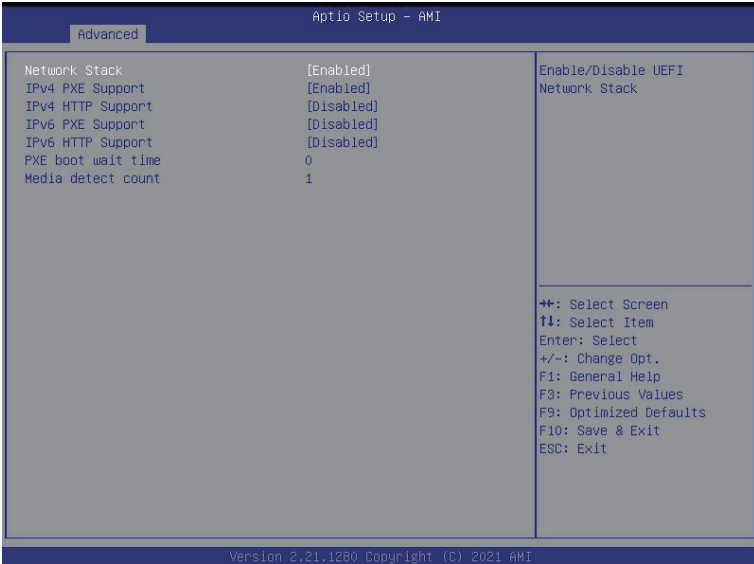

Parameter	Description
Network Stack	Enable/Disable the UEFI network stack. Options available: Enabled/Disabled. Default setting is Enabled .
IPv4 PXE Support	Enable/Disable the Ipv4 PXE feature. Options available: Enabled/Disabled. Default setting is Enabled .
IPv4 HTTP Support	Enable/Disable the Ipv4 HTTP feature. Options available: Enabled/Disabled. Default setting is Disabled .
IPv6 PXE Support	Enable/Disable the Ipv6 PXE feature. Options available: Enabled/Disabled. Default setting is Disabled .
IPv6 HTTP Support	Enable/Disable the Ipv6 HTTP feature. Options available: Enabled/Disabled. Default setting is Disabled .
PXE boot wait time	Wait time in seconds to press ESC key to abort the PXE boot. Use <+> / <-> or numeric keys to set the value.
Media detect count	Press the <+> / <-> keys to increase or decrease the desired values.

5-2-7 Post Report Configuration



Parameter	Description
Post Report Configuration	
Error Message Report	
Post Error Message	Enable/Disable the POST Error Message support. Options available: Enabled/Disabled. Default setting is Enabled .

5-2-8 NVMe Configuration

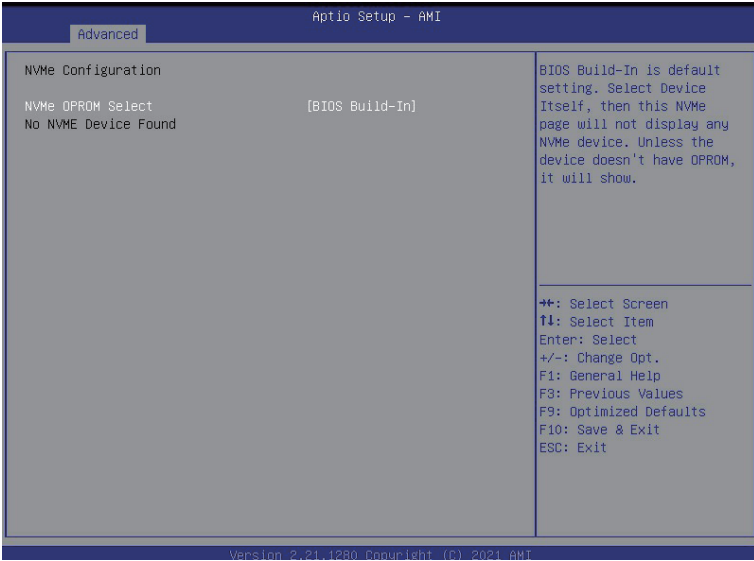

Parameter	Description
NVMe Configuration	Displays the NVMe devices connected to the system
NVMe OPROM Select	Options available: BIOS Build-In/NVMe Device. Default setting is BIOS Build-In .
NVMe #	Press [Enter] for advanced configuration.

5-2-9 Chipset Configuration

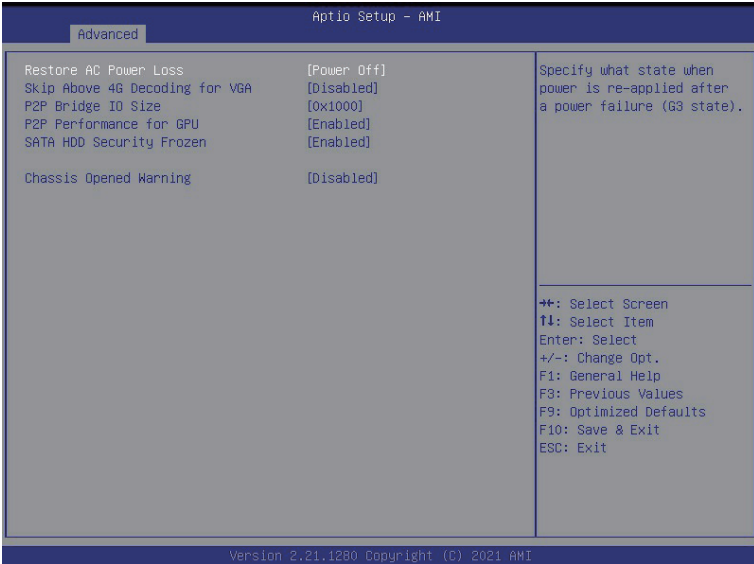

Parameter	Description
Restore on AC Power Loss ^(Note)	Defines the power state to resume to after a system shutdown that is due to an interruption in AC power. When set to Last State, the system will return to the active power state prior to shutdown. When set to Power Off, the system remains off after power shutdown. Options available: Last State, Power Off, Power On, Unspecified. The default setting depends on the BMC setting.
Skip Above 4G Decoding for VGA	Enable/Disable 64bit capable devices to be decoded in Skip Above 4G Address VGA Space. Options available: Enabled/Disabled. Default setting is Disabled .
P2P Bridge IO Size	Setting PSP Bridge IO aligned to the size (currently this mode only support UEFI) Options available: 0x100, 0x150, 0x1000. Default setting is 0x1000 .
PSP Performance for GPU	Enable/Disable PSP Performance function for GPU. Options available: Enabled/Disabled. Default setting is Enabled .
SATA HDD Security Frozen	Enable/Disable to send freeze lock command to SATA HDD. Options available: Enabled/Disabled. Default setting is Enabled .
Chassis Opened Warning	Enable/Disable the chassis intrusion alert function. Options available: Enabled, Disabled, Clear. Default setting is Disabled .

(Note) When the power policy is controlled by BMC, please wait for 15-20 seconds for BMC to save the last power state.

5-2-10 Tls Auth Configuration

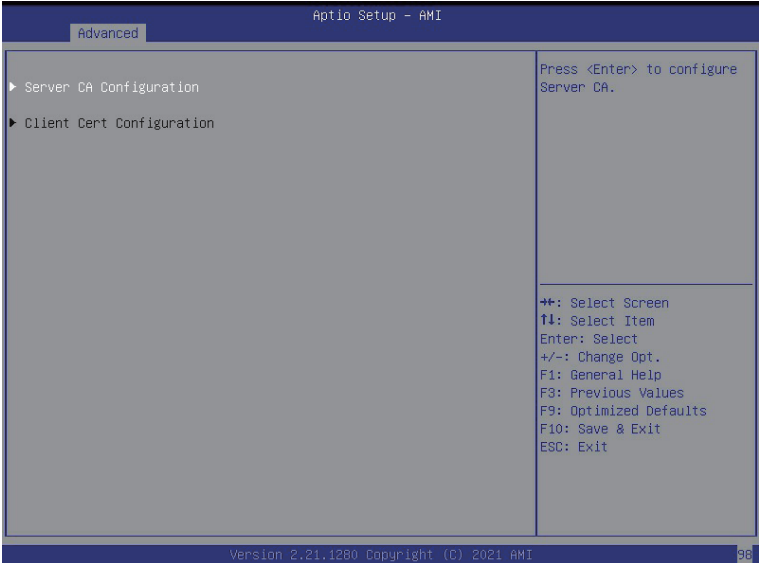

Parameter	Description
Save CA Configuration	Press [Enter] for configuration of advanced items.
Client Cert Configuration	Press [Enter] for configuration of advanced items.

5-2-11 iSCSI Configuration

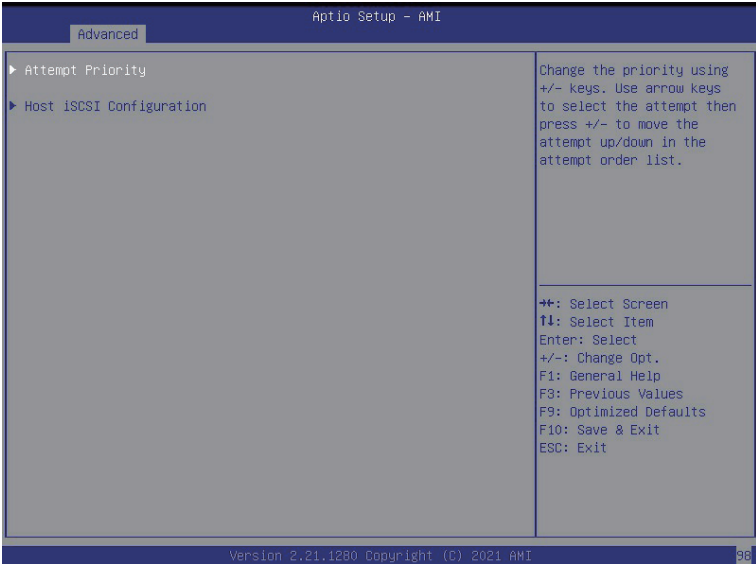

Parameter	Description
Attempt Priority	Press [Enter] for configuration of advanced items.
Host iSCSI Configuration	Press [Enter] for configuration of advanced items.

5-3 Chipset Setup Menu

Chipset Setup menu displays submenu options for configuring the function of Platform Controller Hub(PCH). Select a submenu item, then press <Enter> to access the related submenu screen.

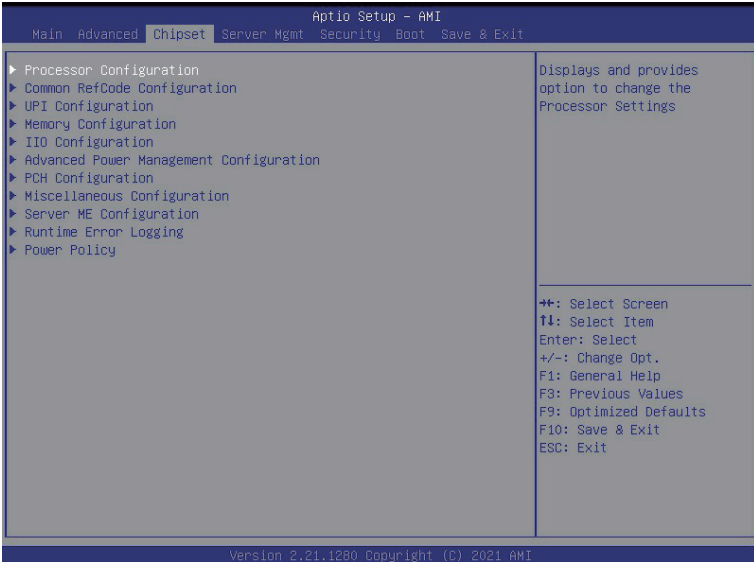

5-3-1 Processor Configuration



Parameter	Description
Processor Configuration	
Pre-Socket Configuration	<p>Press [Enter] to configure advanced items.</p> <ul style="list-style-type: none"> ◆ CPU Socket 0 Configuration <ul style="list-style-type: none"> – Press [Enter] to configure advanced items. ◆ Core Disable Bitmap(Hex) <ul style="list-style-type: none"> – Number of Cores to enable. 0 means all cores. FFFFFFFF means to disable all cores. The maximum value depends on the number of CPUs available. Press the numeric keys to adjust desired values.
Processor Socket / Processor ID / Processor Frequency / Processor Max Ratio / Processor Min Ratio / Microcode Revision / L1 Cache RAM / L2 Cache RAM / L3 Cache RAM / Processor Version	Displays the technical specifications for the installed processor(s).
Hyper-Threading [All]	<p>The Hyper Threading Technology allows a single processor to execute two or more separate threads concurrently. When hyper-threading is enabled, multi-threaded software applications can execute their threads, thereby improving performance.</p> <p>Options available: Enable/Disable. Default setting is Enable.</p>
Hardware Prefetcher	<p>Select whether to enable the speculative prefetch unit of the processor.</p> <p>Options available: Enable/Disable. Default setting is Disable.</p>
L2 RF0 Prefetch Disable	Options available: Enable/Disable. Default setting is Disable .
Adjacent Cache Prefetch	<p>When enabled, cache lines are fetched in pairs. When disabled, only the required cache line is fetched.</p> <p>Options available: Enable/Disable. Default setting is Enable.</p>
DCU Streamer Prefetcher	<p>Prefetches the next L1 data line based upon multiple loads in same cache line.</p> <p>Options available: Enable/Disable. Default setting is Enable.</p>
DCU IP Prefetcher	<p>Prefetches the next L1 Data line based upon sequential load history.</p> <p>Options available: Enable/Disable. Default setting is Enable.</p>
Extended APIC	<p>Enable/Disable extended APIC support. Note: This will enabled VT-d automatically if x2APIC is enabled.</p> <p>Options available: Enable/Disable. Default setting is Disable.</p>
Enable Intel(R) TXT	<p>Enable/Disable the Intel Trusted Execution Technology support function.</p> <p>Options available: Enable/Disable. Default setting is Disable.</p>

Parameter	Description
VMX (Vanderpool Technology)	Enable/Disable the Vanderpool Technology. This will take effect after rebooting the system. Options available: Enable/Disable. Default setting is Enable .
Enable SMX	Enable/Disable the Safer Mode Extensions Options available: Enable/Disable. Default setting is Enable .
AES-NI	Enable/Disable the AES-NI (Intel Advanced Encryption Standard New Instructions) support function. Options available: Enable/Disable. Default setting is Enable .
Debug Coosent	ASD support. Options available: Enable/Disable. Default setting is Disable .
Total Memory Encryption	Enable/Disable Total Memory Encryption. Options available: Enable/Disable. Default setting is Disabled .

5-3-2 Common RefCode Configuration



Parameter	Description
Common RefCode Configuration	
MMIO High Base	Selects the MMIO High Base setting. Options available: 56T, 40T, 32T, 24T, 16T, 4T, 1T/512G/3584T. Default setting is 4T .
MMIO High Granularity Size	Selects the allocation size used to assign mmioh resources. Total mmioh space can be up to 32xgranularity. Per stack mmioh resource assignments are multiples of the granularity where 1 unit per stack is the default allocation. Options available: 1G, 4G, 16G, 64G, 256G, 1024G. Default setting is 1024G .
Isoc Mode	Enable/Disable the Isochronous support in order to meet the QoS requirements (Quality of Service). Options available: Auto, Enable, Disable. Default setting is Disable .
Numa (Non-Uniform Memory Access)	Enable/Disable Non-uniform Memory Access (NUMA) support to improve the system performance. Options available: Enable/Disable. Default setting is Enable .
Virtual Numa	Divide physical NUMA nodes into evenly sized virtual NUMA nodes in ACPI table. This may improve Windows performance on CPUs with more than 64 logical processors. Options available: Enable/Disable. Default setting is Enable .

5-3-3 UPI Configuration

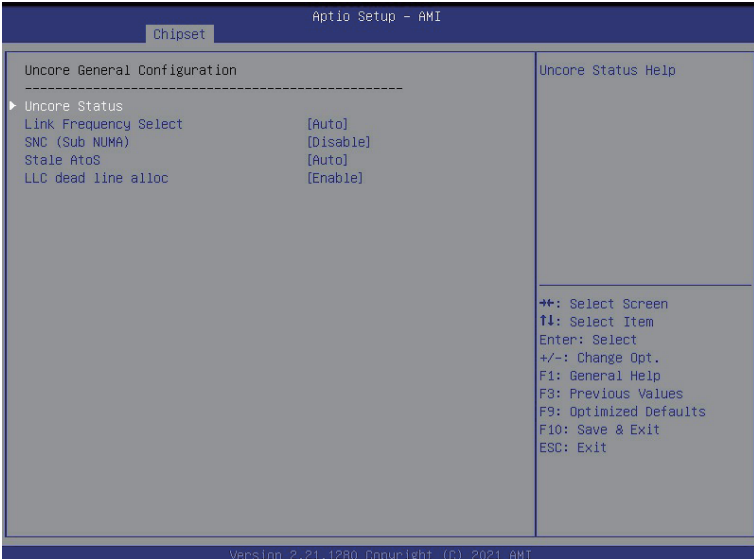

Parameter	Description
UPI Configuration	
	<p>Press [Enter] to configure advanced items.</p> <ul style="list-style-type: none"> ◆ Uncore Status <ul style="list-style-type: none"> – Press [Enter] to view the UPI status. ◆ Link Frequency Select <ul style="list-style-type: none"> – Selects the UPI link frequency. – Options available: 9.6GB/s, 10.4GB/s, Auto. Default setting is Auto. ◆ SNC (Sub NUMA) <ul style="list-style-type: none"> – Enable/Disable Sub NUMA Cluster function. – Options available: Disable, Enable SNC2 (2-clusters). Default setting is Disable. ◆ Stale AtoS <ul style="list-style-type: none"> – Enable/Disable Stale A to S directory optimization. – Options available: Disable, Enable, Auto. Default setting is Auto. ◆ LLC dead line alloc <ul style="list-style-type: none"> – Enable/Disable fill dead lines in LLC. – Options available: Disable, Enable, Auto. Default setting is Enable.
Uncore General Configuration	

5-3-4 Memory Configuration

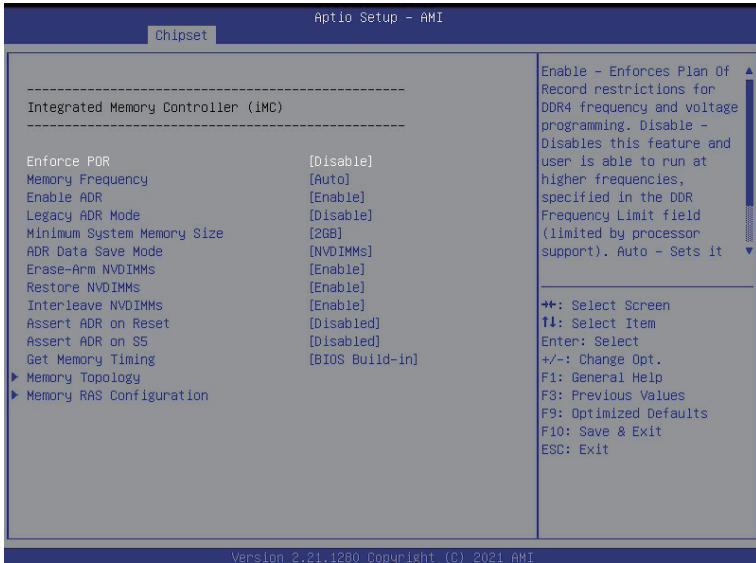

Parameter	Description
Integrated Memory Controller (iMC)	
Enforce POR	When set to Enable, the system enforces Plan Of Record restrictions for DDR4 frequency and voltage programming. When set to Auto, the system sets it to the MRC default settings. Options available: POR, Disable. Default setting is Disable .
Memory Frequency	Configures the maximum memory frequency. Options available: Auto, 1200, 1333, 1400, 1600, 1800, 1866, 2000, 2133, 2200, 2400, 2600, 2666, 2800, 2933, 3000, 3200, 3400-OvrClk, 3466-OvrClk, 3600-OvrClk, 3733-OvrClk, 3800-OvrClk, 4000-OvrClk, 4200-OvrClk, 4266-OvrClk, 4400-OvrClk, 4800-OvrClk. Default setting is Auto .
Enable ADR	Enables the detecting and enabling of ADR (Asynchronous DRAM Refresh) function. Options available: Enable/Disable. Default setting is Enable .

Parameter	Description
Legacy ADR Mode	Enable/Disable the Legacy ADR Mode. Options available: Enable/Disable. Default setting is Disable .
Minimum System Memory Size	Minimum system memory size assigned as system memory when only JEDEC NVDIMMs are present. Options available: 2GB, 4GB, 6GB, 8GB. Default setting is 8GB .
ADR Data Save Mode	Specifies the Data Save Mode for ADR. Batterybacked or Type 01 NVDIMM. Options available: Disable, Batterybacked DIMMs, NVDIMMs. Default setting is NVDIMMs .
Erase-ARM NVDIMMs	Enable/Disable Erasing and Arming NVDIMMs. Options available: Enable/Disable. Default setting is Enable .
Restore NVDIMMs	Enable/Disable Automatic restoring of NVDIMMs. Options available: Enable/Disable. Default setting is Enable .
Interleave NVDIMMs	Controls if NVDIMMs are interleaved together or not. Options available: Enable/Disable. Default setting is Enable .
Assert ADR on Reset	Enable/Disable Assert ADR on Reset. Options available: Enable/Disable. Default setting is Disable .
Assert ADR on S5	Enable/Disable Assert ADR on S5. Options available: Enable/Disable. Default setting is Disable .
Get Memory Timing	Options available: Enabled/Disabled. Default setting is Disabled .

Parameter	Description
Memory Topology	Press [Enter] to view memory topology with DIMM population information.
Memory RAS Configuration	<p>Press [Enter] to configure advanced items.</p> <ul style="list-style-type: none"> ◆ RAS Type <ul style="list-style-type: none"> – Displays the RAS type. ◆ New SDDC Mode <ul style="list-style-type: none"> – Enable 48B SDDC ECC from ICX C0 Onwards. – Options available: Disabled/Enabled. Default setting is Enabled. ◆ Mirror Mode <ul style="list-style-type: none"> – Full Mirror Mode will set entire 1LM memory in system to be mirrored, consequently reducing the memory capacity by half. Partial Mirror Mode will enable the required size of memory to be mirrored. If rank sparing is enabled partial mirroring will not take effect. – Options available: Disabled/ Full Mirror Mode/Partial Mirror Mode. Default setting is Disabled. ◆ Correctable Error Threshold <ul style="list-style-type: none"> – Correctable Error Threshold (1-32767) used for sparing, tagging, and leaky bucket. – Press the <+> / <-> keys to increase or decrease the desired values. ◆ Trigger SW Error Threshold <ul style="list-style-type: none"> – Enable/Disable Sparing trigger SW Error Match Threshold.. – Options available: Disabled/ Full Mirror Mode/Partial Mirror Mode. Default setting is Disabled. ◆ Sparing SW Error Match Threshold <ul style="list-style-type: none"> – Press the <+> / <-> keys to increase or decrease the desired values. ◆ Correctable Error Time Window. <ul style="list-style-type: none"> – Press the <+> / <-> keys to increase or decrease the desired values. ◆ Leaky bucket time window based ini. <ul style="list-style-type: none"> – Press the <+> / <-> keys to increase or decrease the desired values. ◆ Leaky bucket low bit <ul style="list-style-type: none"> – Press the <+> / <-> keys to increase or decrease the desired values. ◆ Leaky bucket high bit <ul style="list-style-type: none"> – Press the <+> / <-> keys to increase or decrease the desired values. ◆ ADDDC Sparing <ul style="list-style-type: none"> – Default setting is Disabled. ◆ Column Correction Disable <ul style="list-style-type: none"> – Default setting is Disable.

Parameter	Description
Memory RAS Configuration	<ul style="list-style-type: none">◆ ADDDC Sparing<ul style="list-style-type: none">– Default setting is Disabled.◆ Column Correction Disable<ul style="list-style-type: none">– Default setting is Disable.◆ Set PMem Die Sparing<ul style="list-style-type: none">– Default setting is Enabled.◆ Patrol Scrub<ul style="list-style-type: none">– Default setting is Disabled.

5-3-5 IIO Configuration



Parameter	Description
IIO Configuration	<p>Press [Enter] to configure advanced items.</p> <ul style="list-style-type: none"> ◆ Intel® VT for Directed I/O (VT-d) <ul style="list-style-type: none"> – Enable/Disable the Intel VT for Directed I/O (VT-d) support function by reporting the I/O device assignment to VMM through DMAR ACPI Tables. – Options available: Enable/Disable. Default setting is Enable. ◆ ACS Control <ul style="list-style-type: none"> – Enable: Programs ACS only to Chipset PCIe Root Ports Bridges. – Disable: Programs ACS to all PCIe bridges. – Default setting is Enable. ◆ DMA Control Opt-In Flag <ul style="list-style-type: none"> – Enable/Disable DMA_CTRL_PLATFORM_OPT_IN_FLAG AG in DRMA table in ACPI. Not compatible with Direct Device Assignment (DDA). – Default setting is Disable. ◆ Interrupt Remapping <ul style="list-style-type: none"> – Enable/Disable the interrupt remapping support function. – Options available: Enable/Disable/Auto. Default setting is Auto.
Intel® VT for Directed I/O (VT-d)	

Parameter	Description
Intel® VT for Directed I/O (VT-d) (continued)	<ul style="list-style-type: none"> ◆ X2APIC Opt Out <ul style="list-style-type: none"> – Enable/Disable X2APIC Opt Out bit. – Options available: Enable/Disable. Default setting is Disable. ◆ Pre-boot DMA Protection <ul style="list-style-type: none"> – Enable DMA Protection in Pre-boot environment (If DMAR table is installed in DXE and if VTD_INFO_PPI is installed in PEI.) – Options available: Enable/Disable. Default setting is Disable.
Intel® VMD technology	<p>Press [Enter] to configure advanced items.</p> <ul style="list-style-type: none"> ◆ Intel® VMD technology^(Note1) ◆ Intel® VMD Configuration <ul style="list-style-type: none"> – Enable/Disable the Intel VMD support function. – Options available: Enable/Disable. Default setting is Disable.

(Note) Advanced items prompt when this item is defined.

5-3-6 Advanced Power Management Configuration

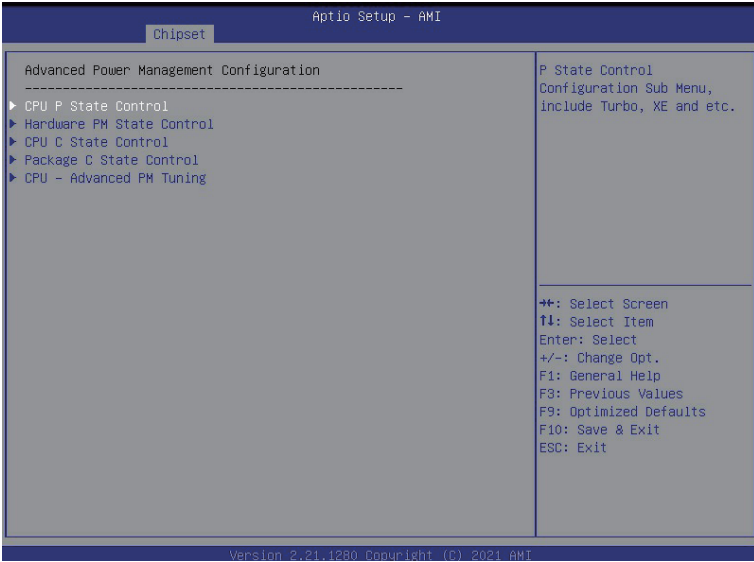

Parameter	Description
Advanced Power Management Configuration	

Parameter	Description
CPU P State Control	<p data-bbox="380 150 710 174">Press [Enter] to configure advanced items.</p> <ul style="list-style-type: none"> <li data-bbox="380 181 954 318">◆ SpeedStep (Pstates) <ul style="list-style-type: none"> <li data-bbox="418 208 954 291">– Conventional Intel SpeedStep Technology switches both voltage and frequency in tandem between high and low levels in response to processor load. <li data-bbox="418 299 910 318">– Options available: Enable/Disable. Default setting is Enable. <li data-bbox="380 326 954 409">◆ Activate SST-BF^(Note) <ul style="list-style-type: none"> <li data-bbox="418 357 763 376">– This option allows SST-BT to be enabled. <li data-bbox="418 384 916 402">– Options available: Enable/Disable. Default setting is Disable. <li data-bbox="380 417 954 523">◆ Configure SST-BF <ul style="list-style-type: none"> <li data-bbox="418 443 954 493">– This option allows BIOS to configure SST-BF High Priority Cores so that SW does not have to configure. <li data-bbox="418 501 910 520">– Options available: Enable/Disable. Default setting is Enable. <li data-bbox="380 531 954 694">◆ Turbo Mode <ul style="list-style-type: none"> <li data-bbox="418 558 954 671">– When this item is enabled, the processor will automatically ramp up the clock speed of 1-2 of its processing cores to improve its performance. When this item is disabled, the processor will not overclock any of its core. <li data-bbox="418 678 910 697">– Options available: Enable/Disable. Default setting is Enable.

(Note) Advanced items prompt when this item is defined.

Parameter	Description
Hardware PM State Control	<p>Press [Enter] to configure advanced items.</p> <ul style="list-style-type: none"> ◆ Hardware P-States <ul style="list-style-type: none"> – When this item is disabled, the processor hardware chooses a P-state based on OS Request (Legacy P-States). – In Native mode, the processor hardware chooses a P-state based on OS guidance. – In Out of Band mode, the processor hardware autonomously chooses a P-state (with no OS guidance). – Options available: Disable, Native Mode, Out of Band Mode, Native Mode with No Legacy Support. Default setting is Native Mode.
CPU C State Control	<p>Press [Enter] to configure advanced items.</p> <ul style="list-style-type: none"> ◆ Enable Monitor MWAIT <ul style="list-style-type: none"> – Allows Monitor and MWAIT instructions. – Options available: Enable/Disable. Default setting is Disable. ◆ CPU C6 Report <ul style="list-style-type: none"> – Allows you to determine whether to let the CPU enter C6 mode in system halt state. When enabled, the CPU core frequency and voltage will be reduced during system halt state to decrease power consumption. The C6 state is a more enhanced power-saving state than C1. – Options available: Disable/Enable/Auto. Default setting is Auto. ◆ Enhanced Halt State (C1E) <ul style="list-style-type: none"> – Core C1E auto promotion control. Takes effect after reboot. – Options available: Enable/Disable. Default setting is Enable.
Package C State Control	<p>Press [Enter] to configure advanced items.</p> <ul style="list-style-type: none"> ◆ Package C State <ul style="list-style-type: none"> – Configures the state for the C-State package limit. – Options available: C0/C1 state, C2 state, C6(non Retention) state, , Auto. Default setting is C0/C1 state.
CPU-Advanced PM Tuning	<p>Press [Enter] to configure advanced items.</p> <ul style="list-style-type: none"> ◆ Energy Perf BIAS <ul style="list-style-type: none"> – Press [Enter] to configure advanced items. ◆ Power Performance Tuning <ul style="list-style-type: none"> – Option available: OS Controls EPB/BIOS Controls EPB/PECI Controls EPB. Default setting is BIOS Controls EPB. ◆ ENERGY_PERF_BIAS_CFG mode^(Note) <ul style="list-style-type: none"> – Option available: Performance/Balanced Performance/Balanced Power/Power. – Default setting is Performance.

5-3-7 PCH Configuration

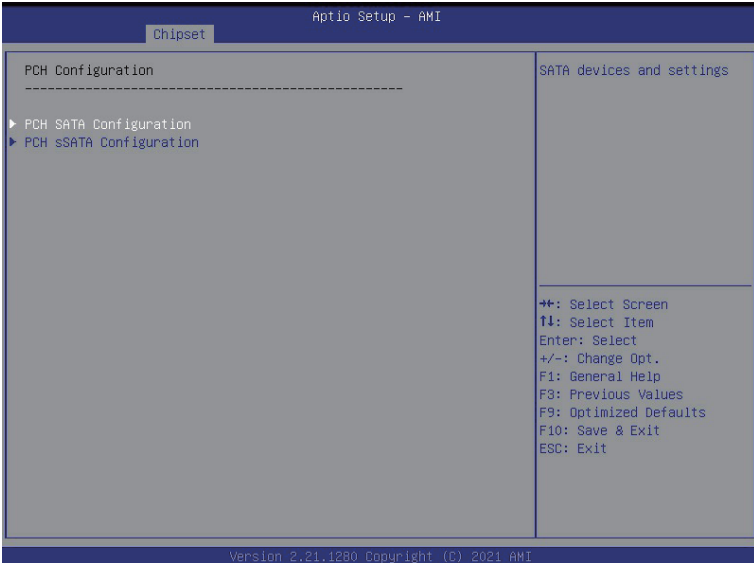

Parameter	Description
PCH Configuration	<p>Press [Enter] to configure advanced items.</p> <ul style="list-style-type: none"> ◆ SATA Controller <ul style="list-style-type: none"> – Enable/Disable SATA controller. – Options available: Enable/Disable. Default setting is Enable. ◆ Configure SATA as <ul style="list-style-type: none"> – Configures on chip SATA type. – AHCI Mode: When set to AHCI, the SATA controller enables its AHCI functionality. Then the RAID function is disabled and cannot be access the RAID setup utility at boot time.
PCH SATA Configuration	<ul style="list-style-type: none"> – RAID Mode: When set to RAID, the SATA controller enables both its RAID and AHCI functions. You will be allowed to access the RAID setup utility at boot time. – Options available: AHCI/RAID. Default setting is AHCI. ◆ Alternate Device ID on RAID^(Note 1) <ul style="list-style-type: none"> – Enable/Disable Alternate Device ID on RAID mode. – Options available: Enable/Disable. Default setting is Disabled ◆ SATA Port 0/1/2/3/4/5/6/7 <ul style="list-style-type: none"> – The category identifies SATA hard drives that are installed in the computer. System will automatically detect HDD type.

(Note 1) Only appears when HDD sets to **RAID Mode**.

Parameter	Description
PCH SATA Configuration (continued)	<ul style="list-style-type: none"> ◆ Port 0/1/2/3/4/5/6/7 <ul style="list-style-type: none"> – Enable/Disable Port 0/1/2/3/4/5/6/7 device. – Options available: Enable/Disable. Default setting is Enable. ◆ Hot Plug (for Port 0/1/2/3/4/5/6/7)^(Note 2) <ul style="list-style-type: none"> – Enable/Disable HDD Hot-Plug function. – Options available: Enable/Disable. Default setting is Disable. ◆ Spin Up Device (for Port 0/1/2/3/4/5/6/7)^(Note 2) <ul style="list-style-type: none"> – On an edge detect from 0 to 1, the PCH starts a COM reset initialization to the device. – Options available: Enable/Disable. Default setting is Disable.
PCH sSATA Configuration	<ul style="list-style-type: none"> ◆ sSATA Controller <ul style="list-style-type: none"> – Enable/Disable sSATA controller. – Options available: Enable/Disable. Default setting is Enable. ◆ Configure sSATA as <ul style="list-style-type: none"> – Configures on chip SATA type. – AHCI Mode: When set to AHCI, the SATA controller enables its AHCI functionality. Then the RAID function is disabled and cannot be access the RAID setup utility at boot time. – RAID Mode: When set to RAID, the SATA controller enables both its RAID and AHCI functions. You will be allowed to access the RAID setup utility at boot time. – Options available: AHCI/RAID. Default setting is AHCI. ◆ Alternate Device ID on RAID^(Note 1) <ul style="list-style-type: none"> – Enable/Disable Alternate Device ID on RAID mode. – Options available: Enable/Disable. Default setting is Disabled. ◆ sSATA Port 0/1/2/3 <ul style="list-style-type: none"> – The category identifies sSATA hard drives that are installed in the computer. System will automatically detect HDD type. ◆ Port 0/1/2/3 <ul style="list-style-type: none"> – Enable/Disable Port 0/1/2/3/4/5 device. – Options available: Enable/Disable. Default setting is Enable. ◆ Hot Plug (for Port 0/1/2/3/4/5)^(Note 2) <ul style="list-style-type: none"> – Enable/Disable HDD Hot-Plug function. – Options available: Enable/Disable. Default setting is Disable. ◆ Spin Up Device (for Port 0/1/2/3)^(Note 2) <ul style="list-style-type: none"> – On an edge detect from 0 to 1, the PCH starts a COM reset initialization to the device. – Options available: Enable/Disable. Default setting is Disabled.

(Note 1) Only appears when HDD sets to **RAID** Mode.

(Note 2) Only Supported when HDD is in **AHCI** or **RAID** Mode.

5-3-8 Miscellaneous Configuration



Parameter	Description
Miscellaneous Configuration	
Active Video	Selects the active video type. Options available: Auto, Onboard Device, PCIE Device, Specified PCIE Device. Default setting is Auto .

5-3-9 Server ME Configuration

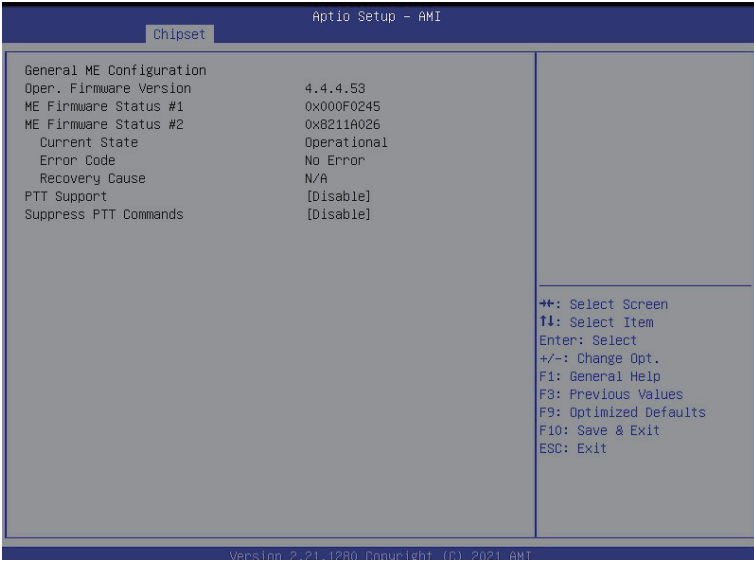

Parameter	Description
General ME Configuration	
Oper. Firmware Version	Displays the operational firmware version.
ME Firmware Status #1/#2	Displays ME Firmware status information.
Current State (for ME Firmware)	Displays ME Firmware current status information.
Error Code (for ME Firmware)	Displays ME Firmware status error code.
Recovery Cause (for ME Firmware)	Displays ME Firmware recovery cause.
PTT Support	Displays if the system supports the Intel® Platform Trust Technology.
Suppress PTT Commands	Displays if the system supports to Bypass TPM2 commands submitting to PTT Firmware.

5-3-10 Runtime Error Logging



Parameter	Description
Runtime Error Logging	
System Errors	Enable/Disable system error logging function. Options available: Enable/Disable. Default setting is Enable .
S/W Error Injection Support	Enable/Disable software injection error logging function. Options available: Enable/Disable. Default setting is Disable .
Whea Settings	Press [Enter] to configure advanced items. <ul style="list-style-type: none"> ◆ WHEA (Windows Hardware Error Architecture) Support <ul style="list-style-type: none"> - Enable/Disable WHEA Support. - Options available: Enable/Disable. Default setting is Enable.
Memory Error Enabling	Press [Enter] to configure advanced items. <ul style="list-style-type: none"> ◆ Memory Error <ul style="list-style-type: none"> - Enable/Disable Memory Error. - Options available: Enable/Disable. Default setting is Enable. ◆ Memory Corrected Error <ul style="list-style-type: none"> - Enable/Disable Memory Corrected Error. - Options available: Enable/Disable. Default setting is Enable. ◆ Uncorrected Error disable Memory <ul style="list-style-type: none"> - Enable/Disable the Memory that triggers Uncorrected Error. - Options available: Enable/Disable. Default setting is Disable.

Parameter	Description
PCIe Error Enabling	<p data-bbox="309 142 642 166">Press [Enter] to configure advanced items.</p> <ul style="list-style-type: none"> <li data-bbox="309 170 923 225">◆ PCIe Error <ul style="list-style-type: none"> <li data-bbox="341 202 841 225">– Options available: Enable/Disable. Default setting is Enable. <li data-bbox="309 230 923 312">◆ Uncorrected Error <ul style="list-style-type: none"> <li data-bbox="341 261 923 285">– Enables and escalates Uncorrectable/Recoverable Errors to error pins. <li data-bbox="341 290 841 313">– Options available: Enable/Disable. Default setting is Enable. <li data-bbox="309 318 923 399">◆ Fatal Error Enable <ul style="list-style-type: none"> <li data-bbox="341 349 749 373">– Enables and escalates Fatal Errors to error pins. <li data-bbox="341 377 841 401">– Options available: Enable/Disable. Default setting is Enable. <li data-bbox="309 406 923 487">◆ Assert NMI on SERR <ul style="list-style-type: none"> <li data-bbox="341 437 645 460">– Enable/Disable SERR propagation. <li data-bbox="341 465 841 489">– Options available: Enable/Disable. Default setting is Enable. <li data-bbox="309 493 923 575">◆ Assert NMI on PERR <ul style="list-style-type: none"> <li data-bbox="341 525 645 548">– Enable/Disable PERR propagation. <li data-bbox="341 553 841 577">– Options available: Enable/Disable. Default setting is Enable.

5-3-11 Power Policy

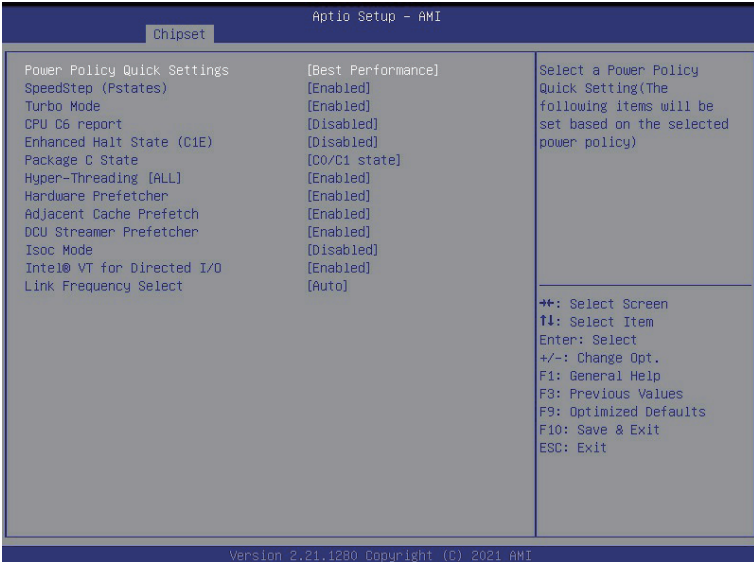

Parameter	Description
Power Policy Quick Settings	Selects a Power Policy Quick Setting. Options available: Standard, Best Performance, Energy Efficient, Turbo Lock. Default setting is Best Performance .
SpeedStep (Pstates)	Conventional Intel SpeedStep Technology switches both voltage and frequency in tandem between high and low levels in response to processor load. Options available: Enabled/Disabled. Default setting is Enabled .
Turbo Mode	When this item is enabled, the processor will automatically ramp up the clock speed of 1-2 of its processing cores to improve its performance. When this item is disabled, the processor will not overclock any of its core. Options available: Enabled/Disabled. Default setting is Enabled .
CPU C6 report	Allows you to determine whether to let the CPU enter C6 mode in system halt state. When enabled, the CPU core frequency and voltage will be reduced during system halt state to decrease power consumption. The C6 state is a more enhanced powersaving state than C1. Options available: Disabled, Enabled, Auto. Default setting is Disabled .
Enhanced Halt State (C1E)	Core C1E auto promotion control. Takes effect after reboot. Options available: Enabled/Disabled. Default setting is Disabled .

Parameter	Description
Package C State	Configures the state for the C-State package limit. Options available: C0/C1 state, C2 state, C6(non Retention) state, C6(Retention) state, No Limit, Auto. Default setting is C0/C1 state .
Hyper-Threading [ALL]	The Hyper Threading Technology allows a single processor to execute two or more separate threads concurrently. When hyper-threading is enabled, multi-threaded software applications can execute their threads, thereby improving performance. Options available: Enabled/Disabled. Default setting is Enabled .
Hardware Prefetcher	Select whether to enable the speculative prefetch unit of the processor. Options available: Enabled/Disabled. Default setting is Disabled .
Adjacent Cache Prefetch	When enabled, cache lines are fetched in pairs. When disabled, only the required cache line is fetched. Options available: Enabled/Disabled. Default setting is Enabled .
DCU Streamer Prefetcher	Prefetches the next L1 data line based upon multiple loads in same cache line. Options available: Enabled/Disabled. Default setting is Enabled .
Isoc Mode	Enable/Disable the Isochronous support in order to meet the QoS requirements (Quality of Service). Options available: Auto, Enabled, Disabled. Default setting is Disabled .
Intel® VT for Directed I/O (VT-d)	Enable/Disable the Intel VT for Directed I/O (VT-d) support function by reporting the I/O device assignment to VMM through DMAR ACPI Tables. Options available: Enabled/Disabled. Default setting is Enabled .
Link Frequency Select	Selects the UPI link frequency. Options available: 9.6GB/s, 10.4GB/s, 11.2GB/s, Auto. Default setting is Auto .

5-4 Server Management Menu

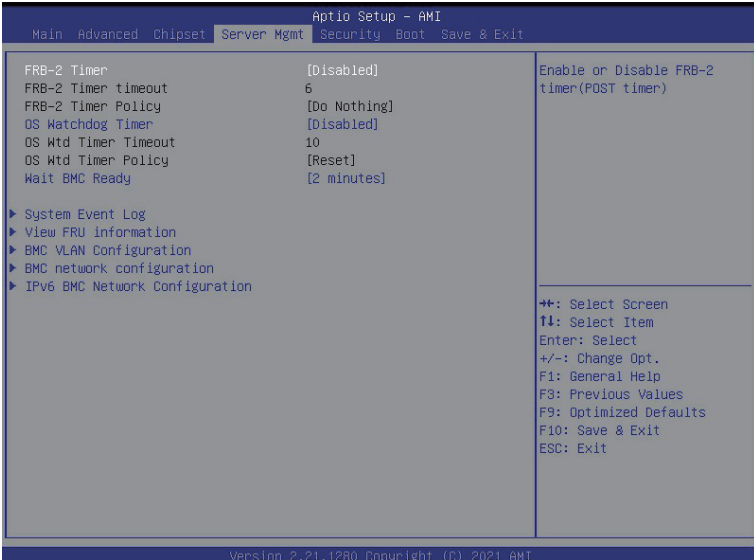

Parameter	Description
FRB-2 Timer	Enable/Disable FRB-2 timer (POST timer). Options available: Enabled/Disabled. Default setting is Disabled .
FRB-2 Timer timeout	Configure the FRB2 Timer timeout. Options available: 3 minutes, 4 minutes, 5 minutes, 6 minutes. Default setting is 6 minutes . Please note that this item is configurable when FRB-2 Timer is set to Enabled.
FRB-2 Timer Policy	Configure the FRB2 Timer policy. Options available: Do Nothing, Reset, Power Down, Power Cycle. Default setting is Do Nothing . Please note that this item is configurable when FRB-2 Timer is set to Enabled.
OS Watchdog Timer	Enable/Disable OS Watchdog Timer function. Options available: Enabled/Disabled. Default setting is Disabled .
OS Wtd Timer Timeout	Configure OS Watchdog Timer. Options available: 5 minutes, 10 minutes, 15 minutes, 20 minutes. Default setting is 5 minutes . Please note that this item is configurable when OS Watchdog Timer is set to Enabled.

Parameter	Description
OS Wtd Timer Policy	Configure OS Watchdog Timer Policy. Options available: Reset, Do Nothing, Power Down, Power Cycle. Default setting is Reset . Please note that this item is configurable when OS Watchdog Timer is set to Enabled.
Wait BMC Ready	POST wait BMC ready and reboot system. Options available: Disabled, 2 minutes, 4 minutes, 6 minutes. Default setting is 2 minutes .
System Event Log	Press [Enter] to configure advanced items.
View FRU Information	Press [Enter] to view the advanced items.
BMC VLAN Configuration	Press [Enter] to configure advanced items.
BMC network configuration	Press [Enter] to configure advanced items.
IPv6 BMC Network Configuration	Press [Enter] to configure advanced items.

5-4-1 System Event Log



Parameter	Description
Enabling / Disabling Options	
SEL Components	Change this item to enable or disable all features of System Event Logging during boot. Options available: Enabled/Disabled. Default setting is Enabled .
Erasing Settings	
Erase SEL	Choose options for erasing SEL. Options available: No/Yes, On next reset/Yes, On every reset. Default setting is No .
When SEL is Full	Choose options for reactions to a full SEL. Options available: Do Nothing, Erase Immediately, Delete Oldest Record. Default setting is Do Nothing .
Custom EFI Logging Options	
Log EFI Status Codes	Enable/Disable the logging of EFI Status Codes (if not already converted to legacy). Options available: Disabled, Both, Error code, Progress code. Default setting is Error code .

5-4-2 View FRU Information

The FRU page is a simple display page for basic system ID information, as well as System product information. Items on this window are non-configurable.

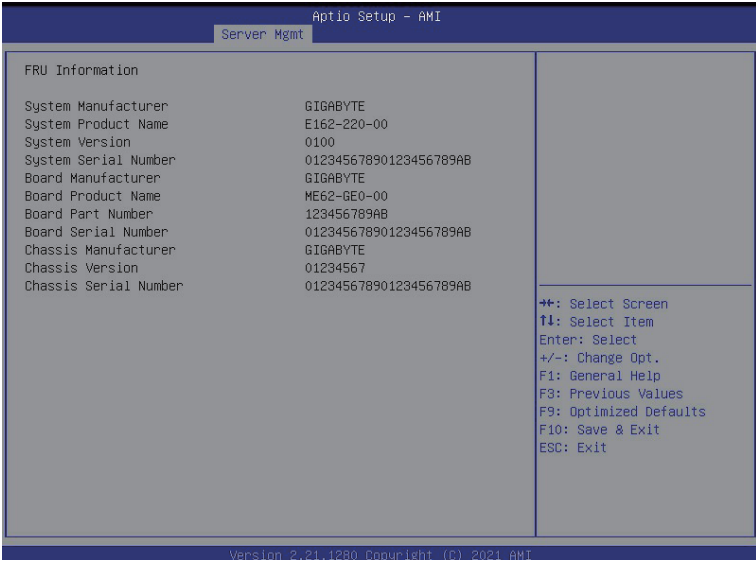

(Note) The model name will vary depends on the product you purchased

5-4-3 BMC VLAN Configuration

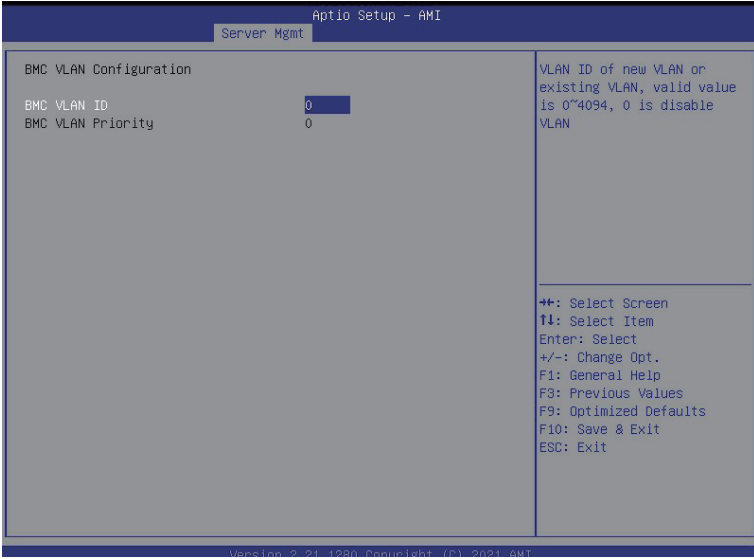

Parameter	Description
BMC VLAN Configuration	
BMC VLAN ID	Select to configure BMC VLAN ID. The valid range is from 0 to 4094. When set to 0, BMC VLAN ID will be disabled.
BMC VLAN Priority	Select to configure BMC VLAN Priority. The valid range is from 0 to 7. When BMC VLAN ID is set to 0, BMC VLAN Priority will not be selected.

5-4-4 BMC Network Configuration

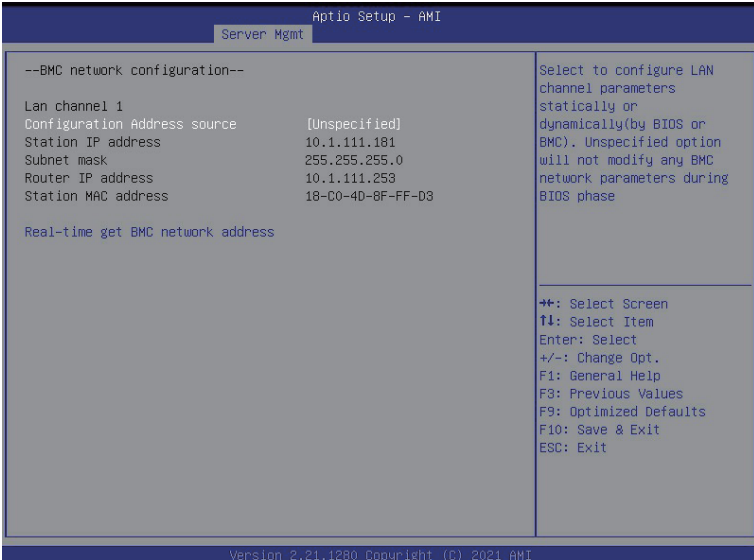

Parameter	Description
BMC network configuration	
Lan Channel 1	
Configuration Address source	Select to configure LAN channel parameters statically or dynamically (DHCP). Do nothing option will not modify any BMC network parameters during BIOS phase. Options available: Unspecified, Static, DynamicBmcDhcp. Default setting is Unspecified .
Station IP address	Displays IP Address information.
Subnet mask	Displays Subnet Mask information. Please note that the IP address must be in three digitals, for example, 192.168.000.001.
Router IP address	Displays the Router IP Address information.
Station MAC address	Displays the MAC Address information.
Real-time get BMC network address	Press [Enter] to synchronize the BMC network parameter values.

5-4-5 IPv6 BMC Network Configuration

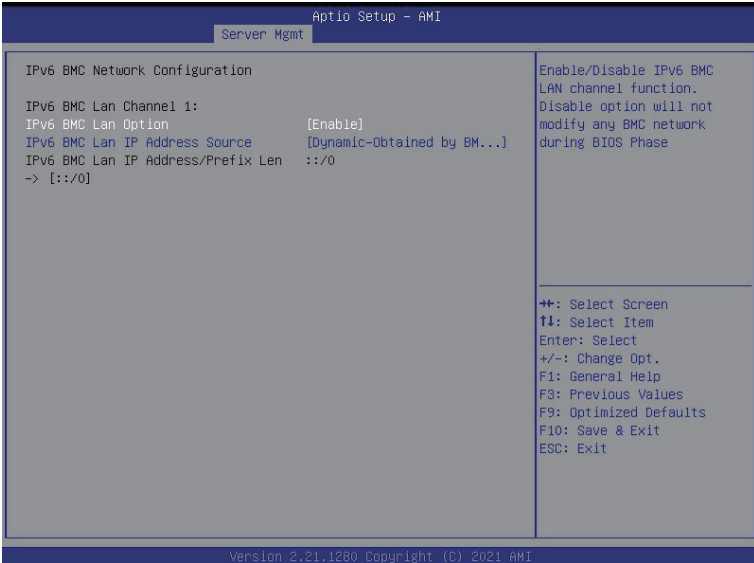

Parameter	Description
IPv6 BMC Network Configuration	
IPv6 BMC Lan Channel 1	
IPv6 BMC Lan Option	Enable/Disable IPv6 BMC LAN channel function. When this item is disabled, the system will not modify any BMC network during BIOS phase. Options available: Unspecified, Enable, Disable. Default setting is Enable .
IPv6 BMC Lan IP Address Source	Select to configure LAN channel parameters statically or dynamically (by BIOS or BMC). Options available: Unspecified, Static, Dynamic-Obtained by BMC running DHCP. Default setting is Dynamic-Obtained by BMC running DHCP .
IPv6 BMC Lan IP Address/Prefix Length	Check if the IPv6 BMC LAN IP address matches those displayed on the screen.

5-5 Security Menu

The Security menu allows you to safeguard and protect the system from unauthorized use by setting up access passwords.

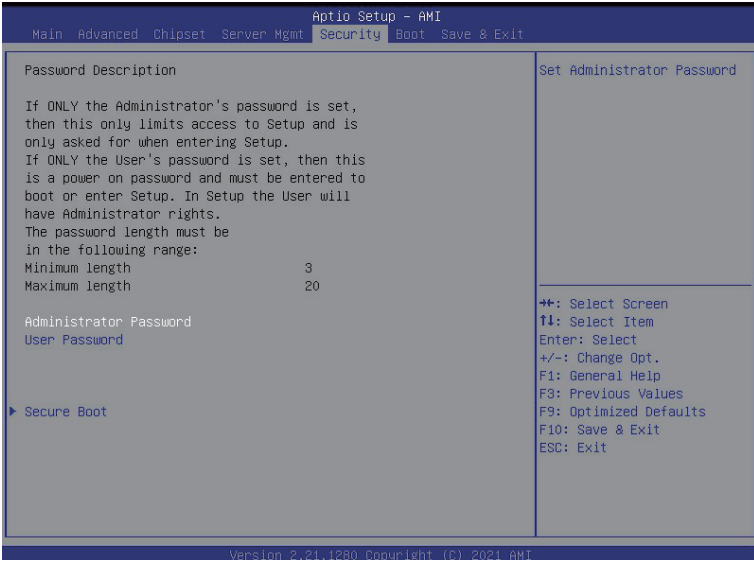

There are two types of passwords that you can set:

- Administrator Password
Entering this password will allow the user to access and change all settings in the Setup Utility.
- User Password
Entering this password will restrict a user's access to the Setup menus. To enable or disable this field, a Administrator Password must first be set. A user can only access and modify the System Time, System Date, and Set User Password fields.

Parameter	Description
Administrator Password	Press [Enter] to configure the administrator password.
User Password	Press [Enter] to configure the user password.
Secure Boot	Press [Enter] to configure advanced items.

5-5-1 Secure Boot

The Secure Boot submenu is applicable when your device is installed the Windows® 8 (or above) operating system.



Parameter	Description
System Mode	Displays if the system is in User mode or Setup mode.
Secure Boot	Enable/ Disable the Secure Boot function. Options available:Enabled/Disabled. Default setting is Disabled .
Secure Boot Mode ^(Note)	Secure Boot requires all the applications that are running during the booting process to be pre-signed with valid digital certificates. This way, the system knows all files being loaded before Windows loads to the login screen have not been tampered with. When set to Standard, it will automatically load the Secure Boot keys form the BIOS databases. When set to Custom, you can customize the Secure Boot settings and manually load its keys from the BIOS database. Options available: Standard/Custom. Default setting is Custom .
Restore Factory Keys	Installs all factory default keys. It will force the system in User Mode..
Reset To Setup Mode	Installs the default keys when system is in setup mode.

(Note) Advanced items prompt when this item is set to **Custom**.

Parameter	Description
Key Management	<p data-bbox="335 156 665 180">Press [Enter] to configure advanced items.</p> <p data-bbox="335 185 936 235">Please note that this item is configurable when Secure Boot Mode is set to Custom.</p> <ul style="list-style-type: none"> <li data-bbox="335 243 941 352">◆ Factory Key Provision <ul style="list-style-type: none"> <li data-bbox="367 266 941 321">– Allows to provision factory default Secure Boot keys when system is in Setup Mode. <li data-bbox="367 326 899 352">– Options available: Enabled/Disabled. Default setting is Disabled. <li data-bbox="335 357 925 431">◆ Restore Factory Keys <ul style="list-style-type: none"> <li data-bbox="367 381 925 404">– Installs all factory default keys. It will force the system in User Mode. <li data-bbox="367 409 601 431">– Options available: Yes/No. <li data-bbox="335 435 899 517">◆ Enroll Efi Image <ul style="list-style-type: none"> <li data-bbox="367 459 899 517">– Press [Enter] to enroll SHA256 hash of the binary into Authorized Signature Database (db). <li data-bbox="335 522 696 572">◆ Restore DB defaults <ul style="list-style-type: none"> <li data-bbox="367 545 696 572">– Restore DB variable to factory defaults. <li data-bbox="335 577 893 627">◆ Secure Boot variable <ul style="list-style-type: none"> <li data-bbox="367 600 893 627">– Displays the current status of the variables used for secure boot. <li data-bbox="335 631 803 736">◆ Platform Key (PK) <ul style="list-style-type: none"> <li data-bbox="367 655 803 682">– Displays the current status of the Platform Key (PK). <li data-bbox="367 686 675 713">– Press [Enter] to configure a new PK. <li data-bbox="367 718 611 736">– Options available: Set New. <li data-bbox="335 741 941 878">◆ Key Exchange Keys (KEK) <ul style="list-style-type: none"> <li data-bbox="367 765 941 846">– Displays the current status of the Key Exchange Key Database (KEK). <li data-bbox="367 851 904 878">– Press [Enter] to configure a new KEK or load additional KEK from storage devices. <li data-bbox="367 882 675 901">– Options available: Set New/Append. <li data-bbox="335 882 904 1019">◆ Authorized Signatures (DB) <ul style="list-style-type: none"> <li data-bbox="367 906 904 932">– Displays the current status of the Authorized Signature Database. <li data-bbox="367 937 941 987">– Press [Enter] to configure a new DB or load additional DB from storage devices. <li data-bbox="367 992 675 1019">– Options available: Set New/Append. <li data-bbox="335 1023 899 1160">◆ Forbidden Signatures (DBX) <ul style="list-style-type: none"> <li data-bbox="367 1047 899 1074">– Displays the current status of the Forbidden Signature Database. <li data-bbox="367 1078 888 1128">– Press [Enter] to configure a new dbx or load additional dbx from storage devices. <li data-bbox="367 1133 675 1160">– Options available: Set New/Append. <li data-bbox="335 1165 925 1301">◆ Authorized TimeStamps (DBT) <ul style="list-style-type: none"> <li data-bbox="367 1188 925 1215">– Displays the current status of the Authorized TimeStamps Database. <li data-bbox="367 1219 904 1270">– Press [Enter] to configure a new DBT or load additional DBT from storage devices. <li data-bbox="367 1274 675 1301">– Options available: Set New/Append. <li data-bbox="335 1306 915 1434">◆ OsRecovery Signatures <ul style="list-style-type: none"> <li data-bbox="367 1329 915 1356">– Displays the current status of the OsRecovery Signature Database. <li data-bbox="367 1361 888 1411">– Press [Enter] to configure a new OsRecovery Signature or load additional OsRecovery Signature from storage devices. <li data-bbox="367 1415 675 1434">– Options available: Set New/Append.

5-6 Boot Menu

The Boot menu allows you to set the drive priority during system boot-up. BIOS setup will display an error message if the legacy drive(s) specified is not bootable.

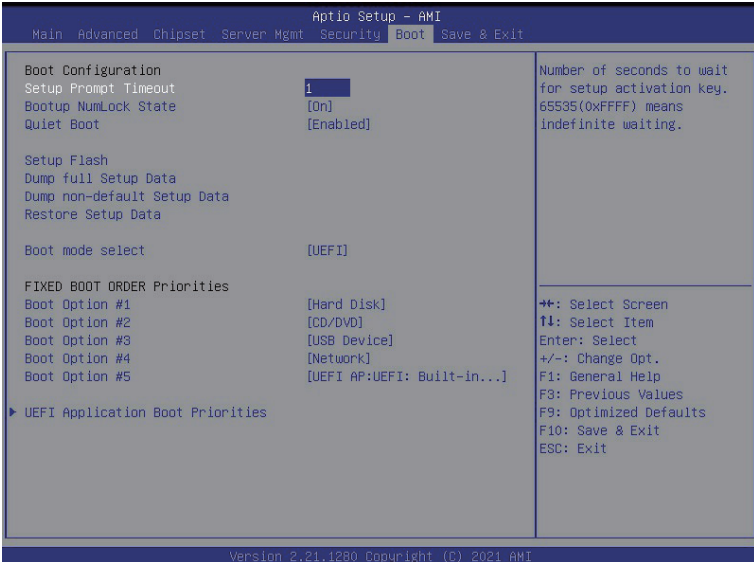

Parameter	Description
Boot Configuration	
Setup Prompt Timeout	Number of seconds to wait for setup activation key. 65535 (0xFFFF) means indefinite waiting. Press the numeric keys to input the desired values.
Bootup NumLock State	Enable/Disable the Bootup NumLock function. Options available: On/Off. Default setting is Off .
Quiet Boot	Enable/Disable showing the logo during POST. Options available: Enabled/Disabled. Default setting is Enabled .
Setup Flash	Press [Enter] to run setup flash.
Boot mode select	Selects the boot mode. Options available: LEGACY/UEFI. Default setting is UEFI .

Parameter	Description
FIXED BOOT ORDER Priorities	
Boot Option #1 / #2 / #3 / #4 / #5	<p data-bbox="402 200 948 283">Press [Enter] to configure the boot priority. By default, the server searches for boot devices in the following sequence:</p> <ol data-bbox="439 288 910 426" style="list-style-type: none"> <li data-bbox="439 288 910 310">1. Hard drive. <li data-bbox="439 315 910 337">2. CD-COM/DVD drive. <li data-bbox="439 341 910 363">3. USB device. <li data-bbox="439 368 910 390">4. Network. <li data-bbox="439 395 910 417">5. UEFI.
UEFI Network Drive BBS Priorities	Press [Enter] to configure the boot priority.
UEFI Application Boot Priorities	Press [Enter] to configure the boot priority.

5-6-1 UEFI NETWORK Drive BBS Priorities

The UEFI network drive BBS priorities submenu allows you to specify the boot device priority from the available UEFI network drives during system boot-up. BIOS setup will display an error message if the legacy drive(s) specified is not bootable.



5-7 Save & Exit Menu

The Save & Exit menu displays the various options to quit from the BIOS setup. Highlight any of the exit options then press <Enter>.

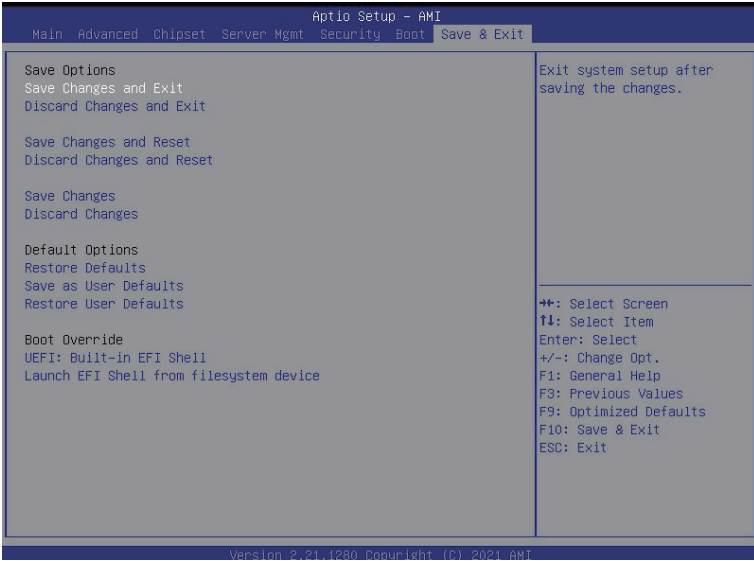

Parameter	Description
Save Options	
Save Changes and Exit	Saves changes made and closes the BIOS setup. Options available: Yes/No.
Discard Changes and Exit	Discards changes made and exits the BIOS setup. Options available: Yes/No.
Save Changes and Reset	Restarts the system after saving the changes made. Options available: Yes/No.
Discard Changes and Reset	Restarts the system without saving any changes. Options available: Yes/No.
Save Changes	Saves changes made in the BIOS setup. Options available: Yes/No.
Discard Changes	Discards changes made and closes the BIOS setup. Options available: Yes/No.

Parameter	Description
Default Options	
Restore Defaults	Loads the default settings for all BIOS setup parameters. Setup Defaults are quite demanding in terms of resources consumption. If you are using low-speed memory chips or other kinds of low-performance components and you choose to load these settings, the system might not function properly. Options available: Yes/No.
Save as User Defaults	Saves the changes made as the user default settings. Options available: Yes/No.
Restore User Defaults	Loads the user default settings for all BIOS setup parameters. Options available: Yes/No.
Boot Override	Press [Enter] to configure the device as the boot-up drive.

5-8 BIOS POST Codes

5-8-1 AMI Standard - PEI

PEI_CORE_STARTED	0x10
PEI_CAR_CPU_INIT	0x11
PEI_CAR_NB_INIT	0x15
PEI_CAR_SB_INIT	0x19
PEI_MEMORY_SPD_READ	0x2B
PEI_MEMORY_PRESENCE_DETECT	0x2C
PEI_MEMORY_TIMING	0x2D
PEI_MEMORY_CONFIGURING	0x2E
PEI_MEMORY_INIT	0x2F
PEI_MEMORY_INSTALLED	0x31
PEI_CPU_INIT	0x32
PEI_CPU_CACHE_INIT	0x33
PEI_CPU_AP_INIT	0x34
PEI_CPU_BSP_SELECT	0x35
PEI_CPU_SMM_INIT	0x36
PEI_MEM_NB_INIT	0x37
PEI_MEM_SB_INIT	0x3B
PEI_DXE_IPL_STARTED	0x4F
DXE_CORE_STARTED	0x60
//Recovery	
PEI_RECOVERY_AUTO	0xF0
PEI_RECOVERY_USER	0xF1
PEI_RECOVERY_STARTED	0xF2
PEI_RECOVERY_CAPSULE_FOUND	0xF3
PEI_RECOVERY_CAPSULE_LOADED	0xF4
//S3	
PEI_S3_STARTED	0xE0
PEI_S3_BOOT_SCRIPT	0xE1
PEI_S3_VIDEO_REPOST	0xE2
PEI_S3_OS_WAKE	0xE3

5-8-2 AMI Standard - DXE

DXE_CORE_STARTED	0x60
DXE_NVRAM_INIT	0x61
DXE_SBRUN_INIT	0x62
DXE_CPU_INIT	0x63
DXE_NB_HB_INIT	0x68
DXE_NB_INIT	0x69
DXE_NB_SMM_INIT	0x6A

DXE_SB_INIT	0x70
DXE_SB_SMM_INIT	0x71
DXE_SB_DEVICES_INIT	0x72
DXE_ACPI_INIT	0x78
DXE_CSM_INIT	0x79
DXE_BDS_STARTED	0x90
DXE_BDS_CONNECT_DRIVERS	0x91
DXE_PCI_BUS_BEGIN	0x92
DXE_PCI_BUS_HPC_INIT	0x93
DXE_PCI_BUS_ENUM	0x94
DXE_PCI_BUS_REQUEST_RESOURCES	0x95
DXE_PCI_BUS_ASSIGN_RESOURCES	0x96
DXE_CON_OUT_CONNECT	0x97
DXE_CON_IN_CONNECT	0x98
DXE_SIO_INIT	0x99
DXE_USB_BEGIN	0x9A
DXE_USB_RESET	0x9B
DXE_USB_DETECT	0x9C
DXE_USB_ENABLE	0x9D
DXE_IDE_BEGIN	0xA0
DXE_IDE_RESET	0xA1
DXE_IDE_DETECT	0xA2
DXE_IDE_ENABLE	0xA3
DXE_SCSI_BEGIN	0xA4
DXE_SCSI_RESET	0xA5
DXE_SCSI_DETECT	0xA6
DXE_SCSI_ENABLE	0xA7
DXE_SETUP_VERIFYING_PASSWORD	0xA8
DXE_SETUP_START	0xA9
DXE_SETUP_INPUT_WAIT	0xAB
DXE_READY_TO_BOOT	0xAD
DXE_LEGACY_BOOT	0xAE
DXE_EXIT_BOOT_SERVICES	0xAF
RT_SET_VIRTUAL_ADDRESS_MAP_BEGIN	0xB0
RT_SET_VIRTUAL_ADDRESS_MAP_END	0xB1
DXE_LEGACY_OPROM_INIT	0xB2
DXE_RESET_SYSTEM	0xB3
DXE_USB_HOTPLUG	0xB4
DXE_PCI_BUS_HOTPLUG	0xB5
DXE_NVRAM_CLEANUP	0xB6
DXE_CONFIGURATION_RESET	0xB7

5-8-3 AMI Standard - ERROR

PEI_MEMORY_INVALID_TYPE	0x50
PEI_MEMORY_INVALID_SPEED	0x50
PEI_MEMORY_SPD_FAIL	0x51
PEI_MEMORY_INVALID_SIZE	0x52
PEI_MEMORY_MISMATCH	0x52
PEI_MEMORY_NOT_DETECTED	0x53
PEI_MEMORY_NONE_USEFUL	0x53
PEI_MEMORY_ERROR	0x54
PEI_MEMORY_NOT_INSTALLED	0x55
PEI_CPU_INVALID_TYPE	0x56
PEI_CPU_INVALID_SPEED	0x56
PEI_CPU_MISMATCH	0x57
PEI_CPU_SELF_TEST_FAILED	0x58
PEI_CPU_CACHE_ERROR	0x58
PEI_CPU_MICROCODE_UPDATE_FAILED	0x59
PEI_CPU_NO_MICROCODE	0x59
PEI_CPU_INTERNAL_ERROR	0x5A
PEI_CPU_ERROR	0x5A
PEI_RESET_NOT_AVAILABLE	0x5B
//Recovery	
PEI_RECOVERY_PPI_NOT_FOUND	0xF8
PEI_RECOVERY_NO_CAPSULE	0xF9
PEI_RECOVERY_INVALID_CAPSULE	0xFA
//S3 Resume	
PEI_MEMORY_S3_RESUME_FAILED	0xE8
PEI_S3_RESUME_PPI_NOT_FOUND	0xE9
PEI_S3_BOOT_SCRIPT_ERROR	0xEA
PEI_S3_OS_WAKE_ERROR	0xEB
DXE_CPU_ERROR	0xD0
DXE_NB_ERROR	0xD1
DXE_SB_ERROR	0xD2
DXE_ARCH_PROTOCOL_NOT_AVAILABLE	0xD3
DXE_PCI_BUS_OUT_OF_RESOURCES	0xD4
DXE_LEGACY_OPROM_NO_SPACE	0xD5
DXE_NO_CON_OUT	0xD6
DXE_NO_CON_IN	0xD7
DXE_INVALID_PASSWORD	0xD8
DXE_BOOT_OPTION_LOAD_ERROR	0xD9
DXE_BOOT_OPTION_FAILED	0xDA
DXE_FLASH_UPDATE_FAILED	0xDB
DXE_RESET_NOT_AVAILABLE	0xDC

5-8-4 Intel UPI POST Codes

Initialize KTIRC ininput structure default values	0xA0
Collect info such as SBSP, Boot Mode, Reset type etc	0xA1
Setup IO SADs in SBSP to access the config space	0xA2
Setup up minimum path between SBSP & other sockets Add the node to the tree Parse the LEP of the discovered socket Check if the system has the supported topology Setup the boot path for the parent which is not directly connected to Legacy CPU Setup path from SBSP to the new found node	0xA3
Setup IO SADs in PBSP to access the config space	0xA4
System configurations that require some kind of reset	0xA5
Sync up with PBSPs	0xA6
Topology discovery and route calculation	0xA7
Program final route	0xA8
Program final IO SAD setting	0xA9
Protocol layer and other Uncore settings	0xAA
Transition links to full speed operation	0xAB
Phy layer settings	0xAC
Link layer settings	0xAD
Coherency Settings	0xAE
KTIRC is done	0xAF

5-8-5 Intel UPI Error Codes

When system BSP tries to setup path for remote sockets or sends a Boot_Go command to remote socket in SetupSbspPathToAllSockets() or SyncUpPbspForReset(). If the remote socket(s) hasn't checked-in, assert; it is a fatal condition, this error will be logged. No retry. <i>RC Behavior: System Halt</i>	0xD8
When SBSP tries to add this remote socket into system topology tree in SetupSbspPathToAllSockets(), there are some errors occur in the data structure. No retry. <i>RC Behavior: The current Socket is not added to the tree.</i> When SBSP setups the boot path for the parent which is not directly connected to Legacy CPU in SetupSbspPathToAllSockets(). The Child is not an immediate neighbor of Parent. No retry.	0xDA
SAD setup error <i>RC Behavior: System Halt</i>	0xDB

Unsupported topology <i>RC Behavior: System Halt</i>	0xDC
SBSP cannot find KPIRC TXEQ Parameters for this link in GetSocketLinkEparams(). No retry. <i>RC Behavior: System Halt</i>	0xDD

5-8-6 Intel MRC POST Codes

Detect DIMM population	0xB0
Set DDR frequency	0xB1
Gather remaining SPD data	0xB2
Program registers on the memory controller level	0xB3
Evaluate RAS modes and save rank information	0xB4
Program registers on the channel level	0xB5
DDRIO Initialization	0xB6
Train DDR	0xB7
Initialize CLTT/OLTT	0xB8
Hardware memory test and init	0xB9
Execute memory init	0xBA
Program memory map and interleaving	0xBB
Program RAS configuration	0xBC
Rank margin tool	0xBD
MRC is done	0xBF

5-8-7 Intel MRC Error Codes

No memory was detected	0xE8
Memory test failure	0xEB
Different dimm types are detected installed in the system	0xED
Number of HAs found in system greater than MAX_HA defined in MRC build	0xEE
Indicates a CLTT table structure error	0xEF
Invalid VR mode, unable to set DRAM VDD	0xF0
Failure occurred reserving memory for IOT	0xF1
Reference code assert	0xF2
Unsupported MC frequency set	0xF3
Unable to get current MC frequency	0xF4

5-8-8 Intel PM POST Codes

Start of PPM structure initialization	0xD0
PPM CSR programming	0xD1
PPM MSR programming	0xD2
Start of PState transition init	0xD3
PPM exit	0xD4
PPM On ready to boot event	0xD5

5-8-9 Intel PM POST Codes

Start of IIO early Initialization	0xE0
Pre Link training	0xE1
Start of Gen3 EQ training	0xE2
Start of PState transition init	0xE3
Gen3 parameters override	0xE4
End of IIO Early Initialization	0xE5
Start of IIO Late initialization	0xE6
PCIE port initialization	0xE7
IOAPIC initialization	0xE8
VTD initialization	0xE9
IOAT initialization	0xEA
DFX initialization	0xEB
NTB initialization	0xEC
Security Initialization	0xED
IIO late initialization	0xEE
IIO On ready to boot event	0xEF

5-9 BIOS POST Beep code (AMI standard)

5-9-1 PEI Beep Codes

# of Beeps	Description
1	Memory not Installed.
1	Memory was installed twice (InstallPeiMemory routine in PEI Core called twice)
2	Recovery started
3	DXE IPL was not found
3	DXE Core Firmware Volume was not found
4	Recovery failed
4	S3 Resume failed
7	Reset PPI is not available

5-9-2 DXE Beep Codes

# of Beeps	Description
1	Invalid password
4	Some of the Architectural Protocols are not available
5	No Console Output Devices are found
5	No Console Input Devices are found
6	Flash update is failed
7	Reset protocol is not available
8	Platform PCI resource requirements cannot be met