

**FLEX 3-1480/
FLEX 3-1580
Hardware
Maintenance
Manual**

Notes:

- Before using this information and the product it supports, be sure to read the general information under “Notices” on page 93.
- This manual applies to the following models: Lenovo FLEX 3-1480/FLEX 3-1580. The illustrations used in this manual are for Lenovo FLEX 3-1580 unless otherwise stated.

First Edition (Aug. 2015)

© Copyright Lenovo 2015. All rights reserved.

LIMITED AND RESTRICTED RIGHTS NOTICE: If data or software is delivered pursuant a General Services Administration “GSA” contract, use, reproduction, or disclosure is subject to restrictions set forth in Contract No. GS-35F-05925.

© 2015 Lenovo

Contents

About this manual	iv	1040 PCI Express Mini Card for wireless LAN	40
Safety information	1	1050 DIMM	42
General safety	2	1060 IO board	43
Electrical safety	3	1070 Speakers	44
Safety inspection guide	5	1080 Fan assembly and Heat Sink assembly	45
Handling devices that are sensitive to electrostatic discharge	6	1090 System board	47
Grounding requirements	6	1100 Touchpad module and upper case	55
Safety notices: multilingual translations	7	1110 LCD unit	59
Laser compliance statement	14	1120 Hinges and LCD cover	62
Important service information	16	1130 Sensor board and antenna assembly	66
Strategy for replacing FRUs	16	1140 LCD module	71
Strategy for replacing a hard disk drive	17	1150 Integrated camera	73
Important notice for replacing a system board	17	Locations	74
Important information about replacing RoHS compliant FRUs	18	Front view and right-side view	74
General checkout	19	Bottom and Left-side view	76
What to do first	20	Parts list	77
Power system checkout	21	Overall	78
Checking the AC adapter	21	LCD FRUs	86
Checking operational charging	22	Miscellaneous parts	88
Checking the battery pack	22	AC adapters	89
Related service information	23	Screws	89
Restoring the factory contents by using OneKey Recovery	23	Power cords	90
Restore of factory default	23	Notices	93
Passwords	24	Trademarks	94
Power-on password	24		
Hard-disk password	24		
Administrator password	24		
Power management	25		
Screen blank state	25		
Putting the computer to sleep or shutting it down	25		
Putting your computer to sleep	25		
Shutting down the computer	25		
Lenovo FLEX 3-1480/FLEX 3-1580	26		
Specifications	26		
Status indicators	28		
Fn key combinations/Hotkeys	29		
FRU replacement notices	30		
Screw notices	30		
Removing and replacing an FRU	31		
1010 Base cover	32		
1020 Battery pack	35		
1030 Hard disk drive	37		

About this manual

This manual contains service and reference information for the following Lenovo product:

Lenovo FLEX 3-1480/FLEX 3-1580

Use this manual to troubleshoot problems.

The manual is divided into the following sections:

- The common sections provide general information, guidelines, and safety information required for servicing computers.
- The product-specific section includes service, reference, and product-specific parts information.

Important:

This manual is intended only for trained servicers who are familiar with Lenovo products. Use this manual to troubleshoot problems effectively.

Before servicing a Lenovo product, make sure to read all the information under “Safety information” on page 1 and “Important service information” on page 16.

Safety information

This chapter presents the following safety information that you need to get familiar with before you service a Lenovo FLEX 3-1480/FLEX 3-1580 computer:

- “General safety” on page 2
- “Electrical safety” on page 3
- “Safety inspection guide” on page 5
- “Handling devices that are sensitive to electrostatic discharge” on page 6
- “Grounding requirements” on page 6
- “Safety notices: multilingual translations” on page 7
- “Laser compliance statement” on page 14

General safety

Follow these rules below to ensure general safety:

- Observe a good housekeeping in the area where the machines are put during and after the maintenance.
- When lifting any heavy object:
 1. Make sure that you can stand safely without slipping.
 2. Distribute the weight of the object equally between your feet.
 3. Use a slow lifting force. Never move suddenly or twist when you attempt to lift it.
 4. Lift it by standing or pushing up with your leg muscles; this action could avoid the strain from the muscles in your back. Do not attempt to lift any object that weighs more than 16 kg (35 lb) or that you think is too heavy for you.
- Do not perform any action that causes hazards to the customer, or that makes the machine unsafe.
- Before you start the machine, make sure that other service representatives and the customer are not in a hazardous position.
- Please remove covers and other parts in a safe place, away from all personnel, while you are servicing the machine.
- Keep your toolcase away from walk areas so that other people will not trip over it.
- Do not wear loose clothing that can be trapped in the moving parts of the machine. Make sure that your sleeves are fastened or rolled up above your elbows. If your hair is long, fasten it.
- Insert the ends of your necktie or scarf inside clothing or fasten it with the nonconductive clip, about 8 centimeters (3 inches) from the end.
- Do not wear jewelry, chains, metal-frame eyeglasses, or metal fasteners for your clothing.

Attention: Metal objects are good electrical conductors.
- Wear safety glasses when you are hammering, drilling, soldering, cutting wire, attaching springs, using solvents, or working in any other conditions that may be hazardous to your eyes.
- After service, reinstall all safety shields, guards, labels, and ground wires. Replace any safety device that is worn or defective.
- Reinstall all covers correctly before returning the machine to the customer.
- Fan louvers on the machine help to prevent the overheating of internal components. Do not obstruct fan louvers or cover them with labels or stickers.

Electrical safety

Observe the following rules when working on electrical equipments.

Important:

Use only approved tools and test equipments. Some hand tools have handles covered with a soft material that does not insulate you when working with live electrical currents.

Many customers have rubber floor mats near their machines that contain small conductive fibers to decrease electrostatic discharges. Do not use such kind of mat to protect yourself from electrical shock.

- Find the room emergency power-off (EPO) switch, disconnecting switch or electrical outlet. If an electrical accident occurs, you can then operate the switch or unplug the power cord quickly.
- Do not work alone under hazardous conditions or near the equipment that has hazardous voltages.
- Disconnect all power before:
 - Performing a mechanical inspection
 - Working near power supplies
 - Removing or installing main units
- Before you start to work on the machine, unplug the power cord. If you cannot unplug it, ask the customer to power-off the wall box that supplies power to the machine, and to lock the wall box in the off position.
- If you need to work on a machine that has exposed electrical circuits, observe the following precautions:
 - Ensure that another person, familiar with the power-off controls, is near you.

Attention: Another person must be there to switch off the power, if necessary.
 - Use only one hand when working with powered-on electrical equipment; keep the other hand in your pocket or behind your back.

Attention: An electrical shock can occur only when there is a complete circuit. By observing the above rule, you may prevent a current from passing through your body.
 - When using testers, set the controls correctly and use the approved probe leads and accessories for that tester.
 - Stand on suitable rubber mats (obtained locally, if necessary) to insulate you from grounds such as metal floor strips and machine frames.

Observe the special safety precautions when you work with very high voltages; instructions for these precautions are in the safety sections of maintenance information. Be extremely careful when you measure the high voltages.

- Regularly inspect and maintain your electrical hand tools for safe operational condition.
- Do not use worn or broken tools and testers.
- Never assume that power has been disconnected from a circuit. First, check it to make sure that it has been powered off.

- Always look carefully for possible hazards in your work area. Examples of these hazards are moist floors, nongrounded power extension cables, power surges, and missing safety grounds.
- Do not touch live electrical circuits with the reflective surface of a plastic dental mirror. The surface is conductive; such touching can cause personal injury and machine damage.
- Do not service the following parts with the power on when they are removed from their normal operating places in a machine:
 - Power supply units
 - Pumps
 - Blowers and fans
 - Motor generatorsand similar units. (This practice ensures correct grounding of the units.)
- If an electrical accident occurs:
 - Caution: do not become a victim yourself.
 - Switch off the power.
 - Send the victim to get medical aid.

Safety inspection guide

The purpose of this inspection guide is to assist you in identifying potential unsafe conditions. As each machine was designed and built, required safety items were installed to protect users and service personnel from injury. This guide addresses only those items. You should use good judgment to identify potential safety hazards according to the attachment of non-Lenovo features or options not covered by this inspection guide.

If any unsafe conditions are present, you must determine how serious the apparent hazard could be and whether you can continue without first correcting the problem.

Consider these conditions and the safety hazards they present:

- Electrical hazards, especially primary power (primary voltage on the frame can cause serious or fatal electrical shock)
- Explosive hazards, such as a damaged CRT face or a bulging capacitor
- Mechanical hazards, such as loose or missing hardware

To determine whether there are any potential unsafe conditions, use the following checklist at the beginning of every service task. Begin the checks with the power off, and the power cord disconnected.

Checklist:

1. Check exterior covers for damage (loose, broken, or sharp edges).
2. Turn off the computer. Disconnect the power cord.
3. Check the power cord for:
 - a. A third-wire ground connector in good condition. Use a meter to measure third-wire ground continuity for 0.1 ohm or less between the external ground pin and the frame ground.
 - b. The power cord should be the type specified in the parts list.
 - c. Insulation must not be frayed or worn.
4. Check for cracked or bulging batteries.
5. Remove the cover.
6. Check for any obvious non-Lenovo alterations. Use good judgment as to the safety of any non-Lenovo alterations.
7. Check inside the unit for any obvious unsafe conditions, such as metal filings, contamination, water or other liquids, or signs of fire or smoke damage.
8. Check for worn, frayed, or pinched cables.
9. Check that the power-supply cover fasteners (screws or rivets) have not been removed or tampered with.

Handling devices that are sensitive to electrostatic discharge

Any computer part containing transistors or integrated circuits (ICs) should be considered sensitive to electrostatic discharge (ESD). ESD damage can occur when there is a difference in charge between objects. Protect against ESD damage by equalizing the charge so that the machine, the part, the work mat, and the person handling the part are all at the same charge.

Notes:

1. Use product-specific ESD procedures when they exceed the requirements noted here.
2. Make sure that the ESD protective devices you use have been certified (ISO 9000) as fully effective.

When handling ESD-sensitive parts:

- Keep the parts in protective packages until they are inserted into the product.
- Avoid contact with other people.
- Wear a grounded wrist strap against your skin to eliminate static on your body.
- Prevent the part from touching your clothing. Most clothing is insulative and retains a charge even when you are wearing a wrist strap.
- Use the black side of a grounded work mat to provide a static-free work surface. The mat is especially useful when handling ESD-sensitive devices.
- Select a grounding system, such as those listed below, to provide protection that meets the specific service requirement.

Note:

The use of a grounding system to guard against ESD damage is desirable but not necessary.

- Attach the ESD ground clip to any frame ground, ground braid, or green-wire ground.
- When working on a double-insulated or battery-operated system, use an ESD common ground or reference point. You can use coax or connector-outside shells on these systems.
- Use the round ground prong of the ac plug on ac-operated computers.

Grounding requirements

Electrical grounding of the computer is required for operator safety and correct system function. Proper grounding of the electrical outlet can be verified by a certified electrician.

Safety notices: multilingual translations

The safety notices in this section are provided in English, French, German, Hebrew, Italian, Japanese, and Spanish.

Safety notice 1

Before the computer is powered on after FRU replacement, make sure all screws, springs, and other small parts are in place and are not left loose inside the computer. Verify this by shaking the computer and listening for rattling sounds. Metallic parts or metal flakes can cause electrical shorts.

Avant de remettre l'ordinateur sous tension après remplacement d'une unité en clientèle, vérifiez que tous les ressorts, vis et autres pièces sont bien en place et bien fixées. Pour ce faire, secouez l'unité et assurez-vous qu'aucun bruit suspect ne se produit. Des pièces métalliques ou des copeaux de métal pourraient causer un court-circuit.

Bevor nach einem FRU-Austausch der Computer wieder angeschlossen wird, muß sichergestellt werden, daß keine Schrauben, Federn oder andere Kleinteile fehlen oder im Gehäuse vergessen wurden. Der Computer muß geschüttelt und auf Klappergeräusche geprüft werden. Metallteile oder-splitter können Kurzschlüsse erzeugen.

לפני הפעלת המחשב לאחר החלפת FRU יש לוודא שכל הברגים, הקפיצים, וחלקים קטנים אחרים נמצאים במקומם ואינם חופשיים לזוז בתוך המחשב. כדי לוודא זאת, יש ללטלט את המחשב ולהקשיב לגילוי קולות שקשוק. חלקי או שבבי מתכת עלולים לגרום לקצרים חשמליים.

Prima di accendere l'elaboratore dopo che é stata effettuata la sostituzione di una FRU, accertarsi che tutte le viti, le molle e tutte le altri parti di piccole dimensioni siano nella corretta posizione e non siano sparse all'interno dell'elaboratore. Verificare ciò scuotendo l'elaboratore e prestando attenzione ad eventuali rumori; eventuali parti o pezzetti metallici possono provocare cortocircuiti pericolosi.

FRUの交換後、コンピュータの電源を入れる前に、ねじ、バネ、その他の小さな部品がすべて正しい位置にあり、またコンピュータの内部で緩んでいないことを確認してください。これを確認するには、コンピュータを振って、カチャカチャと音がしないか確かめます。金属部品や金属破片はショートの原因になることがあります。

Antes de encender el sistema despues de sustituir una FRU, compruebe que todos los tornillos, muelles y demás piezas pequeñas se encuentran en su sitio y no se encuentran sueltas dentro del sistema. Compruébelo agitando el sistema y escuchando los posibles ruidos que provocarían. Las piezas metálicas pueden causar cortocircuitos eléctricos.

Safety notice 2

⚠ DANGER

Some standby batteries contain a small amount of nickel and cadmium. Do not disassemble a standby battery, recharge it, throw it into fire or water, or short-circuit it. Dispose of the battery as required by local ordinances or regulations. Use only the battery in the appropriate parts listing. Use of an incorrect battery can result in ignition or explosion of the battery.

Certaines batteries de secours contiennent du nickel et du cadmium. Ne les démontez pas, ne les rechargez pas, ne les exposez ni au feu ni à l'eau. Ne les mettez pas en court-circuit. Pour les mettre au rebut, conformez-vous à la réglementation en vigueur. Lorsque vous remplacez la pile de sauvegarde ou celle de l'horloge temps réel, veillez à n'utiliser que les modèles cités dans la liste de pièces détachées adéquate. Une batterie ou une pile inappropriée risque de prendre feu ou d'exploser.

Die Bereitschaftsbatterie, die sich unter dem Diskettenlaufwerk befindet, kann geringe Mengen Nickel und Cadmium enthalten. Sie darf nicht zerlegt, wiederaufgeladen, kurzgeschlossen, oder Feuer oder Wasser ausgesetzt werden. Bei der Entsorgung die örtlichen Bestimmungen für Sondermüll beachten. Beim Ersetzen der Bereitschafts-oder Systembatterie nur Batterien des Typs verwenden, der in der Ersatzteilliste aufgeführt ist. Der Einsatz falscher Batterien kann zu Entzündung oder Explosion führen.

סוללות המתנה מסוימות מכילות כמות קטנה של ניקל וקדמיום. אין לפרק סוללת המתנה, לטעון אותה מחדש, להשליך אותה לנאש או למים או לקצר אותה. יש לשלוק את הסוללה בנדרש על ידי התקנות והחוקים המקומיים. יש להשתמש רק בסוללה המופיעה ברשימת החלקים המתאימה. שימוש בסוללה לא מתאימה עלול לגרום להצתה או התפוצצות של הסוללה.

Alcune batterie di riserva contengono una piccola quantità di nichel e cadmio. Non smontarle, ricaricarle, gettarle nel fuoco o nell'acqua né cortocircuitarle. Smaltirle secondo la normativa in vigore (DPR 915/82, successive disposizioni e disposizioni locali). Quando si sostituisce la batteria dell'RTC (real time clock) o la batteria di supporto, utilizzare soltanto i tipi inseriti nell'appropriato Catalogo parti. L'impiego di una batteria non adatta potrebbe determinare l'incendio o l'esplosione della batteria stessa.

予備バッテリーの中には少量のニッケルとカドミウムが含まれているものがあります。したがって、予備バッテリーの分解、再充電、火または水の中への投棄、またはショートさせることは決して行わないでください。バッテリーを廃棄する場合は地方自治体の条例に従ってください。適切なパーツ・リストにあるバッテリーだけを使用してください。誤ったバッテリーを使用すると、バッテリーが発火したり、爆発したりすることがあります。

Algunas baterías de reserva contienen una pequeña cantidad de níquel y cadmio. No las desmonte, ni recargue, ni las eche al fuego o al agua ni las cortocircuite. Deséchelas tal como dispone la normativa local. Utilice sólo baterías que se encuentren en la lista de piezas. La utilización de una batería no apropiada puede provocar la ignición o explosión de la misma.

Safety notice 3**⚠ DANGER**

The battery pack contains small amounts of nickel. Do not disassemble it, throw it into fire or water, or short-circuit it. Dispose of the battery pack as required by local ordinances or regulations. Use only the battery in the appropriate parts listing when replacing the battery pack. Use of an incorrect battery can result in ignition or explosion of the battery.

La batterie contient du nickel. Ne la démontez pas, ne l'exposez ni au feu ni à l'eau. Ne la mettez pas en court-circuit. Pour la mettre au rebut, conformez-vous à la réglementation en vigueur. Lorsque vous remplacez la batterie, veillez à n'utiliser que les modèles cités dans la liste de pièces détachées adéquate. En effet, une batterie inappropriée risque de prendre feu ou d'exploser.

Akkus enthalten geringe Mengen von Nickel. Sie dürfen nicht zerlegt, wiederaufgeladen, kurzgeschlossen, oder Feuer oder Wasser ausgesetzt werden. Bei der Entsorgung die örtlichen Bestimmungen für Sondermüll beachten. Beim Ersetzen der Batterie nur Batterien des Typs verwenden, der in der Ersatzteilliste aufgeführt ist. Der Einsatz falscher Batterien kann zu Entzündung oder Explosion führen.

מארו הסוללה מכיל כמויות קטנות של ניקל וקדמיום. אין לפרק את מארו הסוללה, להשליך אותו לאש או למים או לקצר אותו. יש לטפל את מארו הסוללה כנדרש על ידי התקנות והחוקים המקומיים. יש להשתמש רק בסוללה המופיעה ברשימת החלקים המתאימה בזמן החלפת מארו הסוללה. שימוש בסוללה לא מתאימה עלול לגרום להצתה או התפוצצות של הסוללה.

La batteria contiene piccole quantità di nichel. Non smontarla, gettarla nel fuoco o nell'acqua né cortocircuitarla. Smaltirla secondo la normativa in vigore (DPR 915/82, successive disposizioni e disposizioni locali). Quando si sostituisce la batteria, utilizzare soltanto i tipi inseriti nell'appropriato Catalogo parti. L'impiego di una batteria non adatta potrebbe determinare l'incendio o l'esplosione della batteria stessa.

バッテリー・パックには少量のニッケルが含まれています。バッテリー・パックを分解したり、火または水の中に投げ込んだり、ショートさせないでください。バッテリー・パックの廃棄にあたっては、地方自治体の条例または規則に従ってください。バッテリー・パックを交換するときは、適切なパーツ・リストにあるバッテリーだけを使用してください。誤ったバッテリーを使用すると、バッテリーが発火したり、爆発したりすることがあります。

Las baterías contienen pequeñas cantidades de níquel. No las desmonte, ni recargue, ni las eche al fuego o al agua ni las cortocircuite. Deséchelas tal como dispone la normativa local. Utilice sólo baterías que se encuentren en la lista de piezas al sustituir la batería. La utilización de una batería no apropiada puede provocar la ignición o explosión de la misma.

Safety notice 4

⚠ DANGER

The lithium battery can cause a fire, an explosion, or a severe burn. Do not recharge it, remove its polarized connector, disassemble it, heat it above 100°C (212°F), incinerate it, or expose its cell contents to water. Dispose of the battery as required by local ordinances or regulations. Use only the battery in the appropriate parts listing. Use of an incorrect battery can result in ignition or explosion of the battery.

La pile de sauvegarde contient du lithium. Elle présente des risques d'incendie, d'explosion ou de brûlures graves. Ne la rechargez pas, ne retirez pas son connecteur polarisé et ne la démontez pas. Ne l'exposez pas à une température supérieure à 100°C, ne la faites pas brûler et n'en exposez pas le contenu à l'eau. Mettez la pile au rebut conformément à la réglementation en vigueur. Une pile inappropriée risque de prendre feu ou d'exploser.

Die Systematterie ist eine Lithiumatterie. Sie kann sich entzünden, explodieren oder schwere Verbrennungen hervorrufen. Batterien dieses Typs dürfen nicht aufgeladen, zerlegt, über 100 C erhitzt oder verbrannt werden. Auch darf ihr Inhalt nicht mit Wasser in Verbindung gebracht oder der zur richtigen Polung angebrachte Verbindungsstecker entfernt werden. Bei der Entsorgung die örtlichen Bestimmungen für Sondermüll beachten. Beim Ersetzen der Batterie nur Batterien des Typs verwenden, der in der Ersatzteilliste aufgeführt ist. Der Einsatz falscher Batterien kann zu Entzündung oder Explosion führen.

סוללת הליתיום עלולה לגרום לשריפה, להתפוצצות או לכוויות קשות. אין לטעון אותה מחדש, לטלוק את המחבר המלוכטב שלה, לפרק אותה או לחמם אותה לטמפרטורה העולה על 100 מעלות צלזיוס. אין לשרוף את הסוללה ואין לחשוף את תוכן התא למים. יש לטלוק את הסוללה כנדרש בתקנות ובחוקים המקומיים. יש להשתמש רק בסוללה המומינה ברשימת החלקים המתאימים. שימוש בסוללה אחרת עלול לגרום לשריפת או התפוצצות.

La batteria di supporto e una batteria al litio e puo incendiarsi, esplodere o procurare gravi ustioni. Evitare di ricaricarla, smontarne il connettore polarizzato, smontarla, riscaldarla ad una temperatura superiore ai 100 gradi centigradi, incendiarla o gettarla in acqua. Smaltirla secondo la normativa in vigore (DPR 915/82, successive disposizioni e disposizioni locali). L'impiego di una batteria non adatta potrebbe determinare l'incendio o l'esplosione della batteria stessa.

リチウム・バッテリーは、火災、爆発、または重症のやけどを引き起こすことがあります。バックアップ・バッテリーの充電、その極性コネクタの取り外し、バッテリー本体の分解、100°C (212°F) 以上への加熱、焼却、電池の中身を水に浸すことはしないでください。バッテリーを廃棄する場合は地方自治体の条例に従ってください。適切なパーツ・リストにあるバッテリーだけを使用してください。誤ったバッテリーを使用すると、バッテリーが発火したり、爆発したりすることがあります。

La batería de repuesto es una batería de litio y puede provocar incendios, explosiones o quemaduras graves. No la recargue, ni quite el conector polarizado, ni la desmonte, ni caliente por encima de los 100°C (212°F), ni la incinere ni exponga el contenido de sus celdas al agua. Deséchela tal como dispone la normativa local.

Safety notice 5

If the LCD breaks and the fluid from inside the LCD gets into your eyes or on your hands, immediately wash the affected areas with water at least for 15 minutes. Seek medical care if any symptoms caused by the fluid are present after washing.

Si le panneau d'affichage à cristaux liquides se brise et que vous recevez dans les yeux ou sur les mains une partie du fluide, rincez-les abondamment pendant au moins quinze minutes. Consultez un médecin si des symptômes persistent après le lavage.

Die Leuchtstoffröhre im LCD-Bildschirm enthält Quecksilber. Bei der Entsorgung die örtlichen Bestimmungen für Sondermüll beachten. Der LCD-Bildschirm besteht aus Glas und kann zerbrechen, wenn er unsachgemäß behandelt wird oder der Computer auf den Boden fällt. Wenn der Bildschirm beschädigt ist und die darin befindliche Flüssigkeit in Kontakt mit Haut und Augen gerät, sollten die betroffenen Stellen mindestens 15 Minuten mit Wasser abgespült und bei Beschwerden anschließend ein Arzt aufgesucht werden.

אם מסך הנביש הנוזלי (LCD) נשבר והנוזל מתוך המסך בא במגע עם עיניים או ידיים, שטפו את האזורים הנוגעים מיד במים במשך 15 דקות לפחות. פנו לקבלת עזרה רפואית אם תסמינים הנובעים מהמגע עם הנוזל נמשכים לאחר השטיפה.

Nel caso che caso l'LCD si dovesse rompere ed il liquido in esso contenuto entrasse in contatto con gli occhi o le mani, lavare immediatamente le parti interessate con acqua corrente per almeno 15 minuti; poi consultare un medico se i sintomi dovessero permanere.

LCD が破損し、LCD 中の液体が目に入ったり、手に触れたりした場合は、液体が触れた部分を少なくとも 15 分間洗い流してください。洗い流した後に、液体によって何らかの症状が現れた場合は、医師の治療を受けてください。

Si la LCD se rompe y el fluido de su interior entra en contacto con sus ojos o sus manos, lave inmediatamente las áreas afectadas con agua durante 15 minutos como mínimo. Obtenga atención medica si se presenta algún sintoma del fluido despues de lavarse.

Safety notice 6

⚠ DANGER

To avoid shock, do not remove the plastic cover that protects the lower part of the inverter card.

Afin d'éviter tout risque de choc électrique, ne retirez pas le cache en plastique protégeant la partie inférieure de la carte d'alimentation.

Aus Sicherheitsgründen die Kunststoffabdeckung, die den unteren Teil der Spannungswandlerplatine umgibt, nicht entfernen.

כדי למנוע התחשמלות, אין להסיר את מכסה הפלסטיק המגן על חלקו התחתון של הכרטיס התחנות.

Per evitare scosse elettriche, non rimuovere la copertura in plastica che avvolge la parte inferiore della scheda invertitore.

感電を防ぐため、インバーター・カードの下部を保護しているプラスチック・カバーを外さないでください。

Para evitar descargas, no quite la cubierta de plástico que rodea la parte baja de la tarjeta invertida.

Safety notice 7

⚠ DANGER

Though the main batteries have low voltage, a shorted or grounded battery can produce enough current to burn personnel or combustible materials.

Bien que le voltage des batteries principales soit peu élevé, le court-circuit ou la mise à la masse d'une batterie peut produire suffisamment de courant pour brûler des matériaux combustibles ou causer des brûlures corporelles graves.

Obwohl Hauptbatterien eine niedrige Spannung haben, können sie doch bei Kurzschluß oder Erdung genug Strom abgeben, um brennbare Materialien zu entzünden oder Verletzungen bei Personen hervorzurufen.

אף שהסוללות הראשיות הן בעלות מתח נמוך, סוללה מקוצרת או מוארקת עלולה להפיק זרם מספיק לגרימת כוויות או להצתת חומרים דליקים.

Sebbene le batterie di alimentazione siano a basso voltaggio, una batteria in corto circuito o a massa può fornire corrente sufficiente da bruciare materiali combustibili o provocare ustioni ai tecnici di manutenzione.

メイン・バッテリーの電圧は低くても、ショートしたり、接地したバッテリーが、作業者にやけどを負わせたり、可燃物を燃やすだけの電流を発生させる場合があります。

Aunque las baterías principales tienen un voltaje bajo, una batería cortocircuitada o con contacto a tierra puede producir la corriente suficiente como para quemar material combustible o provocar quemaduras en el personal.

Safety notice 8**⚠ DANGER**

Before removing any FRU, turn off the computer, unplug all power cords from electrical outlets, remove the battery pack, and then disconnect any interconnecting cables.

Avant de retirer une unité remplaçable en clientèle, mettez le système hors tension, débranchez tous les cordons d'alimentation des socles de prise de courant, retirez la batterie et déconnectez tous les cordons d'interface.

Die Stromzufuhr muß abgeschaltet, alle Stromkabel aus der Steckdose gezogen, der Akku entfernt und alle Verbindungskabel abgenommen sein, bevor eine FRU entfernt wird.

לפני סילוק FRU כלשהו, יש לכבות את המחשב, לנתק את כל כבלי החשמל משקעי החשמל, להוציא את מטריז הסוללה, ואז לנתק כבלי חיבור אחרים אם יש כאלה.

Prima di rimuovere qualsiasi FRU, spegnere il sistema, scollegare dalle prese elettriche tutti i cavi di alimentazione, rimuovere la batteria e poi scollegare i cavi di interconnessione.

FRU を取り外す前に、**ThinkPad** の電源を切って、すべての電源コードをコンセントから外してください。次に、バッテリー・パックを外し、相互接続ケーブルを外してください。

Antes de quitar una FRU, apague el sistema, desenchufe todos los cables de las tomas de corriente eléctrica, quite la batería y, a continuación, desconecte cualquier cable de conexión entre dispositivos.

Laser compliance statement

Some models of Lenovo computer are equipped from the factory with an optical storage device such as a CD-ROM drive or a DVD-ROM drive. Such devices are also sold separately as options. If one of these drives is installed, it is certified in the U.S. to conform to the requirements of the Department of Health and Human Services 21 Code of Federal Regulations (DHHS 21 CFR) Subchapter J for Class 1 laser products. Elsewhere, the drive is certified to conform to the requirements of the International Electrotechnical Commission (IEC) 825 and CENELEC EN 60 825 for Class 1 laser products.

If a CD-ROM drive, a DVD-ROM drive, or another laser device is installed, note the following:

CAUTION

Use of controls or adjustments or performance of procedures other than those specified herein might result in hazardous radiation exposure.

O uso de controles, ajustes ou desempenho de procedimentos diferentes daqueles aqui especificados pode resultar em perigosa exposição à radiação.

凡未在这里指明的任何控制用法、调整、行为，都会导致严重后果。

Pour éviter tout risque d'exposition au rayon laser, respectez les consignes de réglage et d'utilisation des commandes, ainsi que les procédures décrites.

Werden Steuer- und Einstellelemente anders als hier festgesetzt verwendet, kann gefährliche Laserstrahlung auftreten.

Az itt előírt eljárásoktól, beállítástoktól és vezérlésektől eltérni a lézersugárzás veszélye miatt kockázatos!

L'utilizzo di controlli, regolazioni o l'esecuzione di procedure diverse da quelle specificate possono provocare l'esposizione a.

Использование элементов настройки и выполнение процедур иных, чем указано здесь, может привести к опасному радиационному облучению.

Použitie kontrol, úprav alebo iných vykonaní od iných výrobcov, ako je v tomto špecifikované, mohlo by mať za následok nebezpečenstvo vystavenia sa vyžiarovaniu.

本書で指定された内容以外の、お客様による整備、調整、または手順を行った場合、レーザー光の放射の危険があります。

El uso de controles o ajustes o la ejecución de procedimientos distintos de los aquí especificados puede provocar la exposición a radiaciones peligrosas.

Opening the CD-ROM drive, the DVD-ROM drive, or any other optical storage device could result in exposure to hazardous laser radiation. There are no serviceable parts inside those drives. **Do not open.**

A CD-ROM drive, a DVD-ROM drive, or any other storage device installed may contain an embedded Class 3A or Class 3B laser diode. Note the following:

 **DANGER**

Emits visible and invisible laser radiation when open. Do not stare into the beam, do not view directly with optical instruments, and avoid direct exposure to the beam.

Radiação por raio laser ao abrir. Não olhe fixo no feixe de luz, não olhe diretamente por meio de instrumentos óticos e evite exposição direta com o feixe de luz.

开启时会有激光发射时，请勿直视激光束，请勿直接查看视觉仪器，并且避免直接接触在激光光束之中。

Rayonnement laser si carter ouvert. Évitez de fixer le faisceau, de le regarder directement avec des instruments optiques, ou de vous exposer au rayon.

Laserstrahlung bei geöffnetem Gerät. Nicht direkt oder über optische Instrumente in den Laserstrahl sehen und den Strahlungsbereich meiden.

Kinyitáskor lézersugár ! Ne nézzen bele se szabad szemmel, se optikai eszközökkel. Kerülje a sugárnyalábbal való érintkezést!

Aprendo l'unità vengono emesse radiazioni laser. Non fissare il fascio, non guardarlo direttamente con strumenti ottici e evitare l'esposizione diretta al fascio.

Открывая, берегитесь лазерного излучения. Не смотрите на луч, не разглядывайте его с помощью оптических инструментов, а также избегайте прямого воздействия лазерного луча.

Keď je laserová jednotka otvorená. Vyhnite sa priamemu pohľadu a nehladte priamo s optickými nástrojmi do lúča a vyhnite sa priamemu vystaveniu lúčov.

開けるとレーザー光が放射されます。光線を見つめたり、光学機械を使って直接見たりしないでください。

Radiación láser al abrir. No mire fijamente ni examine con instrumental óptico el haz de luz. Evite la exposición directa al haz.

Important service information

This chapter presents the following important service information:

- “Strategy for replacing FRUs” on page 16
 - “Strategy for replacing a hard disk drive” on page 17
 - “Important notice for replacing a system board” on page 17
- “Important information about replacing RoHS compliant FRUs” on page 18

Important:

BIOS and device driver fixes are customer-installable. The BIOS and device drivers are posted on the customer support site:

<http://support.lenovo.com>.

Strategy for replacing FRUs

Before replacing parts:

Make sure that all software fixes, drivers, and BIOS downloads are installed before replacing any FRUs listed in this manual.

After a system board is replaced, ensure that the latest BIOS is loaded to the system board before completing the service action.

To download software fixes, drivers, and BIOS, follow the steps below:

1. Go to <http://support.lenovo.com>.
2. Enter the serial number or select a product or use Lenovo smart downloading.
3. Select the BIOS/Driver/Applications and download.
4. Follow the directions on the screen and install the necessary software.

Use the following strategy to prevent unnecessary expense for replacing and servicing FRUs:

- If you are instructed to replace an FRU, but the replacement does not solve the problem, reinstall the original FRU before you continue.
- Some computers have both a processor board and a system board. If you are instructed to replace either of them, and replacing one of them does not solve the problem, reinstall that board, and then replace the other one.
- If an adapter or a device consists of more than one FRU, any of the FRUs may be the cause of the error. Before replacing the adapter or device, remove the FRUs one by one to see if the symptoms change. Replace only the FRU that changed the symptoms.

Attention: The setup configuration on the computer you are servicing may have been customized. Running Automatic Configuration may alter the settings. Note the current configuration settings (using the View Configuration option); then, when service has been completed, verify that those settings remain in effect.

Strategy for replacing a hard disk drive

Always try to run a low-level format before replacing a hard disk drive. This will cause all customer data on the hard disk to be lost. Make sure that the customer has a current backup of the data before performing this action.

Attention: The drive startup sequence in the computer you are servicing may have been changed. Be extremely careful during write operations such as copying, saving, or formatting. If you select an incorrect drive, data or programs can be overwritten.

Important notice for replacing a system board

Some components mounted on a system board are very sensitive. Improper handling can cause damage to those components, and may cause a system malfunction.

Attention: When handling a system board:

- Do not drop the system board or apply any excessive force to it.
- Avoid rough handling of any kind.
- Avoid bending the system board and hard pushing to prevent cracking at each BGA (Ball Grid Array) chipset.

Important information about replacing RoHS compliant FRUs

RoHS, The Restriction of Hazardous Substances in Electrical and Electronic Equipment Directive (2002/95/EC) is a European Union legal requirement affecting the global electronics industry. RoHS requirements must be implemented on Lenovo products placed on the market after June 2006. Products on the market before June 2006 are not required to have RoHS compliant parts. If the original FRU parts are non-compliant, replacement parts can also be non-compliant. In all cases if the original FRU parts are RoHS compliant, the replacement part must also be RoHS compliant.

Note: RoHS and non-RoHS FRU part numbers with the same fit and function are identified with unique FRU part numbers.

Lenovo plans to transit to RoHS compliance well before the implementation date and expects its suppliers to be ready to support Lenovo’s requirements and schedule in the EU. Products sold in 2005 and 2006 will contain some RoHS compliant FRUs. The following statement pertains to these products and any product Lenovo produces containing RoHS compliant FRUs.

RoHS compliant FRUs have unique FRU part numbers. Before or after the RoHS implementation date, failed RoHS compliant parts must always be replaced with RoHS compliant ones, so only the FRUs identified as compliant in the system HMM or direct substitutions for those FRUs may be used.

Products marketed before June 2006		Products marketed after June 2006	
Current or original part	Replacement FRU	Current or original part	Replacement FRU
Non-RoHS	Can be Non-RoHS	Must be RoHS	Must be RoHS
Non-RoHS	Can be RoHS		
Non-RoHS	Can sub to RoHS		
RoHS	Must be RoHS		

Note: A direct substitution is a part with a different FRU part number that is automatically shipped by the distribution center at the time of the order.

General checkout

This chapter presents the following information:

- “What to do first” on page 20
- “Power system checkout” on page 21

Before you go to the checkout, make sure to read the following important notes:

Important notes:

- **Only certified trained personnel can service the computer.**
- **Before replacing any FRU, read the entire page on removing and replacing FRUs.**
- **Carefully remove screws for reuse when replacing FRUs.**
- **Be extremely careful during such write operations as copying, saving, or formatting.** Drives in the computer that you are servicing sequence might have been altered. If you select an incorrect drive, data or programs might be overwritten.
- **Replace an FRU only with another FRU of the correct model.** When you replace an FRU, make sure that the machine model and the FRU part number are correct by referring to the FRU parts list.
- **An FRU should not be replaced just because of a single, unreproducible failure.** Single failures can occur for a variety of reasons that have nothing to do with a hardware defect, such as cosmic radiation, electrostatic discharge, or software errors. Consider replacing an FRU only when a problem recurs. If you suspect that an FRU is defective, clear the error logs and run the test again. If the error does not recur, do not replace the FRU.
- **Be careful not to replace a nondefective FRU.**

What to do first

When you do return an FRU, you must include the following information in the parts exchange form or parts return form that you attach to it:

1. Name and phone number of servicer
2. Date of service
3. Date on which the machine failed
4. Date of purchase
5. Procedure index and page number in which the failing FRU was detected
6. Failing FRU name and part number
7. Machine type, model number, and serial number
8. Customer's name and address

Note for warranty: During the warranty period, the customer may be responsible for repair costs if the computer damage was caused by misuse, accident, modification, unsuitable physical or operating environment, or improper maintenance by the customer.

The following is a list of some common items that are not covered under warranty and some symptoms that might indicate that the system was subjected to stress beyond normal use.

Before checking problems with the computer, determine whether the damage is covered under the warranty by referring to the following list:

The following are not covered under warranty:

- LCD panel cracked from the application of excessive force or from being dropped
- Scratched (cosmetic) parts
- Distortion, deformation, or discoloration of the cosmetic parts
- Plastic parts, latches, pins, or connectors that have been cracked or broken by excessive force
- Damage caused by liquid spilled into the system
- Damage caused by the improper insertion of a PC Card or the installation of an incompatible card
- Improper disk insertion or use of an optical drive
- Diskette drive damage caused by pressure on the diskette drive cover, foreign material in the drive, or the insertion of a diskette with multiple labels
- Damaged or bent diskette eject button
- Fuses blown by attachment of a nonsupported device
- Forgotten computer password (making the computer unusable)
- Sticky keys caused by spilling a liquid onto the keyboard
- Use of an incorrect AC adapter on laptop products

The following symptoms might indicate damage caused by nonwarranted activities:

- Missing parts might be a symptom of unauthorized service or modification.
- If the spindle of a hard disk drive becomes noisy, it may have been subjected to excessive force, or dropped.

Power system checkout

To verify a symptom, follow the steps below:

1. Turn off the computer.
2. Remove the battery pack.
3. Connect the AC adapter.
4. Make sure that power is supplied when you turn on the computer.
5. Turn off the computer.
6. Disconnect the AC adapter and install the charged battery pack.
7. Make sure that the battery pack supplies power when you turn on the computer.

If you suspect a power problem, see the appropriate one of the following power supply checkouts:

- “Checking the AC adapter” on page 21
- “Checking operational charging” on page 22
- “Checking the battery pack” on page 22

Checking the AC adapter

You are here because the computer fails only when the AC adapter is used.

- If the power-on indicator does not turn on, check the power cord of the AC adapter for correct continuity and installation.
- If the computer does not charge during operation, go to “Checking operational charging”.

To check the AC adapter, follow the steps below:

1. Unplug the AC adapter cable from the computer.
2. Measure the output voltage at the plug of the AC adapter cable. See the following figure:



Pin	Voltage (V DC)
1	+5
2	D-
3	D+
4	GND
5	0

Note: Output voltage for the AC adapter pin No. 5 may differ from the one you are servicing.

3. If the voltage is not correct, replace the AC adapter.
4. If the voltage is acceptable, do the following:
 - Replace the system board.
 - If the problem persists, go to “Lenovo FLEX 3-1480/FLEX 3-1580” on page 26.

Note: Noise from the AC adapter does not always indicate a defect.

Checking operational charging

To check whether the battery charges properly during operation, use a discharged battery pack or a battery pack that has less than 50% of the total power remaining when installed in the computer.

Perform operational charging. If the battery status indicator or icon does not light on, remove the battery pack and let it return to room temperature. Reinstall the battery pack. If the charge indicator or icon is still off, replace the battery pack.

If the charge indicator still does not light on, replace the system board. Then reinstall the battery pack. If it is still not charged, go to the next section.

Checking the battery pack

Battery charging does not start until the Power Meter shows that less than 95% of the total power remains; under this condition the battery pack can charge to 100% of its capacity. This protects the battery pack from being overcharged or from having a shortened life.

To check your battery, move your cursor to the Power Meter icon in the icon tray of the Windows® taskbar and wait for a moment (but do not click it), and the percentage of battery power remaining is displayed. To get detailed information about the battery, double-click the Power Meter icon.

Note: If the battery pack becomes hot, it may not be able to be charged. Remove it from the computer and leave it at room temperature for a while. After it cools down, reinstall and recharge it.

Related service information

This chapter presents the following information:

- “Restoring the factory contents by using OneKey Recovery” on page 23
- “Passwords” on page 24
- “Power management” on page 25

Restoring the factory contents by using OneKey Recovery

Restore of factory default

The Lenovo FLEX 3-1480/FLEX 3-1580 computers come with pre-installed OneKey Recovery System. In order to save application files and the initial backed up files of the system, the hard disk in a Lenovo computer includes a hidden partition when it is shipped. If you need to restore the system to the point of your first boot up, just enter Lenovo OneKey Recovery System and run **System Recovery**. For details of OneKey Recovery System, see *the User Guide for Lenovo OneKey Recovery System*.

Note: This will delete all the new data on the system partition (C drive), which is not recoverable. Make sure to back up your critical data before you perform this action.

Passwords

As many as three passwords may be needed for any Lenovo computer: the power-on password (POP), the hard disk password (HDP), and the administrator password.

If any of these passwords has been set, a prompt for it appears on the screen whenever the computer is turned on. The computer does not start until the password is entered.

Power-on password

A power-on password (POP) protects the system from being powered on by an unauthorized person. The password must be entered before an operating system can be booted.

Hard-disk password

There are two hard-disk passwords (HDPs):

+ User HDP - for the user

+ Master HDP - for the system administrator, who can use it to get access to the hard disk drive even if the user has changed the user HDP

Attention: If the user HDP has been forgotten, check whether a master HDP has been set. If it has, it can be used for access to the hard disk drive. If no master HDP is available, neither Lenovo nor Lenovo authorized service technicians provide any services to reset either the user or the master HDP, or to recover data from the hard disk drive. The hard disk drive can be replaced for a scheduled fee.

Administrator password

Administrator password controls the access of the whole setup utility. Only Administrator password was set then User password can be set. If Administrator password was cleared, the User password was cleared too.

Power management

Note: Power management modes are not supported for APM operating system.

To reduce power consumption, the computer has three power management modes: screen blank, sleep (standby), and shut down.

Screen blank state

If the time set on the “Turn off monitor” timer in the operating system expires, the LCD backlight turns off. You can also turn off the LCD backlight by pressing **F9**.

To end screen blank state and resume normal operation, press any key.

Putting the computer to sleep or shutting it down

When you have finished working with your computer, you can put it to sleep or shut it down.

Putting your computer to sleep

If you will be away from your computer for only a short time, put the computer to sleep. When the computer is in sleep mode, you can quickly wake it to resume use, bypassing the startup process. To put the computer to sleep, do one of the following:

- Close the display lid.
- Press the Power button.
- Open the start menu, and then select **Power**  → **Sleep**.

Attention: Wait until the power indicator light starts blinking (indicating that the computer is in sleep mode) before you move your computer. Moving your computer while the hard disk is spinning can damage the hard disk, causing loss of data.

To wake the computer, do one of the following:

- Press any key on the keyboard.
- Press the Power button.

Shutting down the computer

If you are not going to use your computer for a long time, shut it down. To shut down your computer:

- Open the start menu, and then select **Power**  → **Shut down**.
- Press and hold or right-click the **Start** button in the lower-left corner and select **Shut down or sign out** → **Shut down**.

Lenovo FLEX 3-1480/FLEX 3-1580

This chapter presents the following product-specific service references and product-specific parts information:

- “Specifications” on page 26
- “Status indicators” on page 28
- “Fn key combinations/Hotkeys” on page 29
- “FRU replacement notices” on page 30
- “Removing and replacing an FRU” on page 31
- “Locations” on page 74
- “Parts list” on page 77

Specifications

The following table lists the specifications of the Lenovo FLEX 3-1480/ FLEX 3-1580:

Table 1. Specifications

Feature	Description
Processor	<ul style="list-style-type: none"> • See the system properties of your computer, you can do this as follows: Open the Control Panel, and then select System and Security → System.
Graphic memory chip	<ul style="list-style-type: none"> • Integrated Graphics: GT2 • Discreted Graghics (Option): Integrated/Nvidia N16V-GM/ Nvidia N16S-GT
Display	<ul style="list-style-type: none"> • 14.0" 16:9, 1,366 × 768 pixels HD / 1,920 × 1,080 pixels FHD • 15.6" 16:9, 1,366 × 768 pixels HD / 1,920 × 1,080 pixels FHD
Standard memory	<ul style="list-style-type: none"> • 1,600 MHz SODIMM × 1 (max 8 GB)
Hard disk drive	<ul style="list-style-type: none"> • 2.5-inch, 7 mm SATA II/SATA III • 500 GB / 1 TB 5,400 rpm
I/O port	<ul style="list-style-type: none"> • Combo audio jack × 1 • RJ-45 × 1 • HDMI port × 1 • USB 2.0 port × 1, USB 3.0 port × 2 • 4 in 1 slot × 1 (SD/SDHC/SDXC/MMC)
Audio	<ul style="list-style-type: none"> • 1/8" Combo audio jack • 1.5 W speakers × 2 • Single/Array Digital MIC
Ethernet (on the system board)	<ul style="list-style-type: none"> • 1,000 Mbps
Bluetooth wireless	<ul style="list-style-type: none"> • Combined in combo card
Keyboard	<ul style="list-style-type: none"> • 6 row ISO full size keyboard
Touchpad	<ul style="list-style-type: none"> • Multi-touch type

Table 1. Specifications (continued)



Feature	Description
Integrated camera	<ul style="list-style-type: none">• HD/0.3 M
Battery	<ul style="list-style-type: none">• 3 cells / 2 cells, 45 Wh / 30 Wh
AC adapter	<ul style="list-style-type: none">• DIS 65 W, UMA 45 W
Pre-installed operating system	<ul style="list-style-type: none">• Linpus lite/DOS• Windows Mobile• Windows 10 (or similar update in 13 months)

Status indicators

The system status indicators below show the computer status:



Table 2. Status indicators

Indicator	Indicator status	Meaning
1 Battery status indicator 	On (solid white)	The battery has more than 20% charge.
	On (solid amber)	The battery has between 5% and 20% charge.
	Blinking quickly (amber)	The battery has less than 5% charge.
	Blinking slowly (amber)	The battery is being charged. When the battery charge reaches 20%, the blinking color will change to white.
	Blinking slowly (white)	The battery has between 20% and 80% charge and is still charging. When the battery reaches 80% charge the light will stop blinking, but charging will continue until the battery is fully charged.
2 Power status indicator 	On (solid white)	The computer is powered on.
	Blinking	The computer is in sleep mode.
	Off	The computer is powered off.

Fn key combinations/Hotkeys

The following table shows the function of each combination of Fn with a function key.

Table 3. Fn key combinations

Lenovo FLEX 3-1480













Fn + Home:	Activates the pause function.
Fn + End:	Activates the break function.
Fn + PgUp :	Enables/disables the scroll lock.
Fn + PgDn :	Activates the insert function.
Fn + Space (on select models):	Adjusts the keyboard backlight (off → dim → bright → off).

Lenovo FLEX 3-1580

Fn + Home:	Activates the pause function.
Fn + End:	Activates the break function.
Fn + PgUp :	Enables/disables the scroll lock.
Fn + PgDn :	Activates the system request.
Fn + Space (on select models):	Adjusts the keyboard backlight (off → dim → bright → off).

You can access certain system settings quickly by pressing the appropriate hotkeys.

Table 4. Hotkeys

 : Mutes/unmutes the sound.	 : Enables/disables Airplane mode.
 : Decreases the volume level.	 : Displays all currently active apps.
 : Increases the volume level.	 : Turns on/off the backlight of the LCD screen.
 : Closes the currently active window.	 : Toggles the display between the computer and an external device.
 : Refreshes the desktop or the currently active window.	 : Decreases the display brightness.
 : Enables/disables the touchpad.	 : Increases the display brightness.

FRU replacement notices

This section presents notices related to removing and replacing parts. Read this section carefully before replacing any FRU.

Screw notices

Loose screws can cause a reliability problem. In the Lenovo computer, this problem is addressed with special nylon-coated screws that have the following characteristics:

- They maintain tight connections.
- They do not easily come loose, even with shock or vibration.
- They are harder to tighten.

Do the following when you service this machine:

- Keep the screw kit in your tool bag.
- Carefully remove screws for reuse when replacing FRUs.
- Use a torque screwdriver if you have one.

Tighten screws as follows:

- **Plastic to plastic**

Turn an additional 90° after the screw head touches the surface of the plastic part:

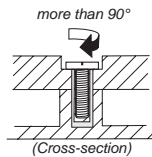

- **Logic card to plastic**

Turn an additional 180° after the screw head touches the surface of the logic card:

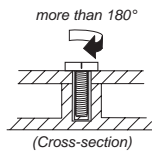

- **Torque driver**

If you have a torque screwdriver, refer to the "Torque" column for each step.

- Make sure that you use the correct screws. If you have a torque screwdriver, tighten all screws firmly to the torque shown in the table. **Carefully remove screws for reuse when replacing FRUs. Make sure that all screws are tightened firmly.**
- Ensure torque screwdrivers are calibrated correctly following country specifications.

Removing and replacing an FRU

This section presents exploded figures with the instructions to indicate how to remove and replace the FRU. Make sure to observe the following general rules:

1. Do not attempt to service any computer unless you have been trained and certified. An untrained person runs the risk of damaging parts.
2. Before replacing any FRU, review “FRU replacement notices” on page 30.
3. Begin by removing any FRUs that have to be removed before the failing FRU. Any of such FRUs are listed at the top of the page. Remove them in the order in which they are listed.
4. Follow the correct sequence in the steps to remove the FRU, as given in the figures by the numbers in square callouts.
5. When turning a screw to replace an FRU, turn it in the direction as given by the arrow in the figure.
6. When removing the FRU, move it in the direction as given by the arrow in the figure.
7. To put the new FRU in place, reverse the removal procedures and follow any of the notes that pertain to replacement. For information about connecting and arranging internal cables, see “Locations” on page 74.
8. When replacing an FRU, use the correct screw as shown in the procedures.

DANGER

Before removing any FRU, turn off the computer, unplug all power cords from electrical outlets, remove the battery pack, and then disconnect any of the interconnecting cables.

Attention: After replacing an FRU, do not turn on the computer until you have made sure that all screws, springs, and other small parts are in place and none are loose inside the computer. Verify this by shaking the computer gently and listening for rattling sounds. Metallic parts or metal flakes can cause electrical short circuits.

Attention: The system board is sensitive to, and can be damaged by, electrostatic discharge. Before touching it, establish personal grounding by touching a ground point with one hand or using an electrostatic discharge (ESD) strap (P/N 6405959) to remove potential shock reasons.

Notes:

- The following procedures about removing and replacing FRUs are the same for the Lenovo FLEX 3-1480/FLEX 3-1580.
- The illustrations used in this section are of the Lenovo FLEX 3-1580, unless otherwise stated.

1010 Base cover

Figure 1. Removal steps of base cover

Remove the screws **1**.

FLEX 3-1480

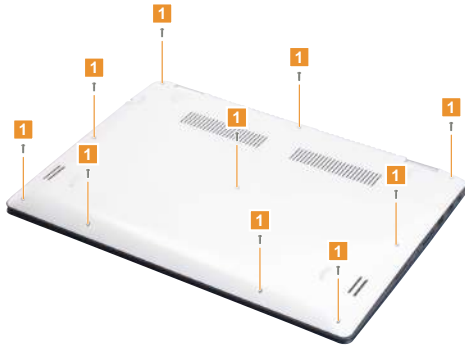

FLEX 3-1580

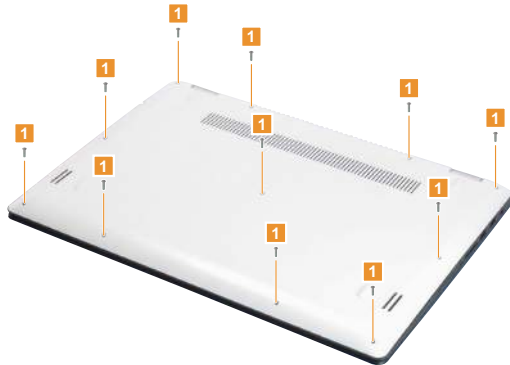

Step	Screw (quantity)	Color	Torque
1	M2.0 × 6.0 mm, Phillips head, nylok-coated (10) LCASE to UCASE (FLEX 3-1480)	Sliver	2.0 kg*cm
1	M2.0 × 6.0 mm, Phillips head, nylok-coated (11) LCASE to UCASE (FLEX 3-1580)	Sliver	2.0 kg*cm

Figure 1. Removal steps of base cover (continued)

Remove the base cover in the directions shown by arrows **2** and **3**.

FLEX 3-1480

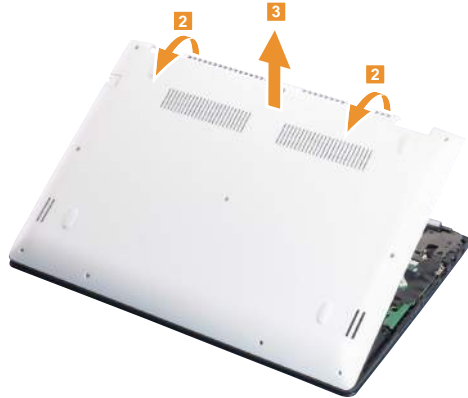

FLEX 3-1580

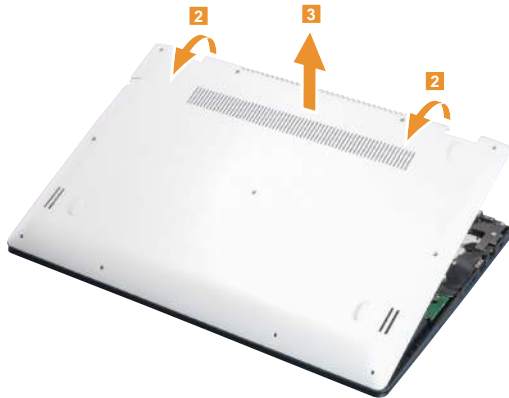

Note: Applying labels to the base cover

The new base cover FRU is shipped with a kit containing labels of several kinds. When you replace the base cover, you need to apply the following labels:

The following labels need to be peeled off from the old base cover and put on the new base cover.

a	Barcode label	g	Postel label (for Indonesia)
b	Rating label	h	D side label (for Indonesia)
c	GML label	i	BIS label (for India)
d	BT label (for US/CA/TW)	j	WL/BT label (for Israel)
e	WL label (for US/CA/TW)	k	WL/BT label (for Brazil)
f	KCC label (for Korea)	l	WL label (for South Africa)

For some models, you also need to apply one or two FCC labels. Check the old base cover; if it has one or two FCC labels, find duplicates of them in the label kit and apply them to the new base cover.

For the location of each label, refer to the following figure:

FLEX 3-1480

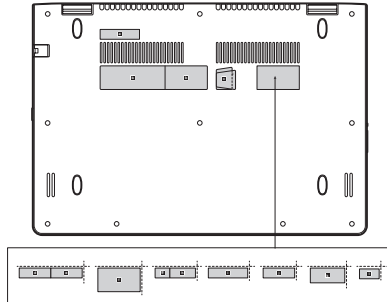

FLEX 3-1580

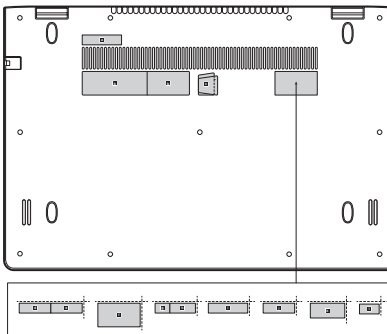

1020 Battery pack

For access, remove this FRU:

- “1010 Base cover” on page 32

⚠ DANGER

Only use the battery specified in the parts list for your computer. Any other battery could ignite or explode.

Figure 2. Removal steps of battery pack

FLEX 3-1480

Disconnect the FPC connector in the directions shown by arrows **1** and **2**. Unplug the battery connector in the direction shown by arrow **3**, then remove the screws **4**. Remove the battery pack **5**.

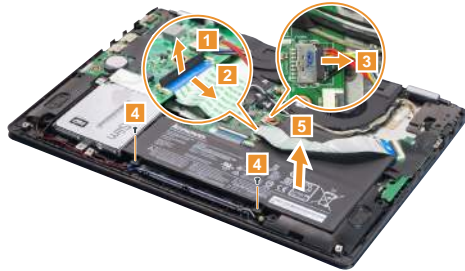

Step	Screw (quantity)	Color	Torque
4	M2.0 × 4.0 mm, Phillips head, nylok-coated (2) Battery to UCASE (FLEX 3-1480)	Black	2.0 kgf*cm

Figure 2. Removal steps of battery pack (continued)

FLEX 3-1580

Unplug the battery connector in the direction shown by arrow **1**, then remove the screws **2**. Remove the battery pack **3**.

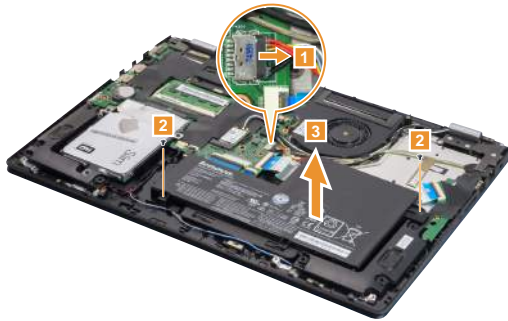

Step	Screw (quantity)	Color	Torque
2	M2.0 × 2.5 mm, Phillips head, nylok-coated (2) Battery to UCASE (FLEX 3-1580)	Black	2.0 kgf*cm

When installing: Make sure that the connectors are attached firmly.

1030 Hard disk drive

For access, remove these FRUs in order:

- “1010 Base cover” on page 32
- “1020 Battery pack” on page 35

Attention:

- **Do not drop the hard disk drive or apply any physical shock to it.** The hard disk drive is sensitive to physical shock. Improper handling can cause damage and permanent loss of data.
- Before removing the drive, suggest the customer to backup all the information on it if possible.
- Never remove the drive while the system is operating or in suspend mode.

Figure 3. Removal steps of hard disk drive

Remove the three screws **1**. Pull the hard disk driver in the direction shown by arrow **2**. Then remove the hard disk drive.

FLEX 3-1480

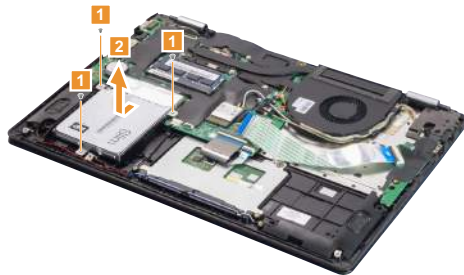
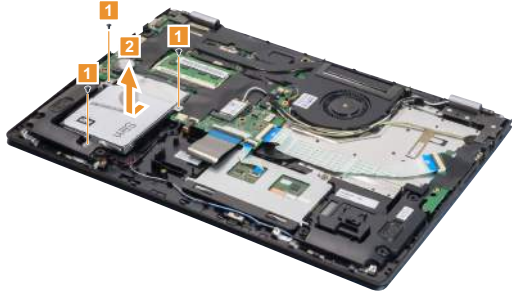

Figure 3. Removal steps of hard disk drive (continued)

FLEX 3-1580



Step	Screw (quantity)	Color	Torque
1	M2.0 × 2.5 mm, Phillips head, nylok-coated (3) HDD Brkt to UCASE	Black	2.0 kgf*cm

When installing: Make sure that the HDD connector is attached firmly.

Figure 3. Removal steps of hard disk drive (continued)

Peel off the hard disk drive mylar label in the direction shown by arrow **3**.
Remove the screws **4** and detach the metal frame from the hard disk drive.

FLEX 3-1480



FLEX 3-1580



Step	Screw (quantity)	Color	Torque
4	M3.0 × 4.0 mm, Phillips head, nylok-coated (4) HDD Brkt to HDD	Silver	2.5 kgf*cm

1040 PCI Express Mini Card for wireless LAN

For access, remove these FRUs in order:

- “1010 Base cover” on page 32
- “1020 Battery pack” on page 35

Important: The preinstalled WLAN module may only be replaced with a Lenovo approved module in order to comply with FCC and IC regulations. Refer to “Table 5. Parts list—Overall” on page 80 for Lenovo part numbers for the approved modules.

Figure 4. Removal steps of PCI Express Mini Card for wireless LAN

Disconnect the two wireless LAN cables (black, white) **1**, and then remove the screw **2**.

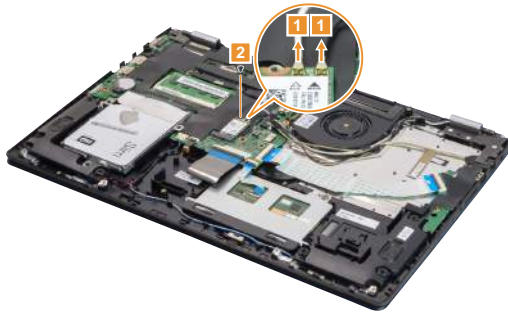

In step **1**, unplug the jacks by using the removal tool antenna RF connector (P/N: 08K7159), or pick up the connectors with your fingers and gently unplug them in the direction shown by the arrows.

Notes: The wireless LAN card has 2 cables in step **1**.

The wireless LAN card in some models might have 3 cables in step **1**.

Step	Screw (quantity)	Color	Torque
2	M2.0 × 2.5 mm, Phillips head, nylok-coated (1) NGFF to MB	Black	2.0 kgf*cm

Figure 4. Removal steps of PCI Express Mini Card for wireless LAN (continued)

Remove the card in the direction shown by arrow **3**.



When installing:

- In models with a wireless LAN card that has two antenna connectors, plug the black cable (1st) (MAIN) into the jack labeled **MAIN**, and the white cable (2nd) (AUX) into the jack labeled **AUX** on the card.
- In models with a wireless LAN card that has three antenna connectors, plug the black cable (1st) (MAIN) into the jack labeled **1**, the grey cable (3rd) into the jack labeled **3**, and the white cable (2nd) (AUX) into the jack labeled **2** on the card.

1050 DIMM

For access, remove these FRUs in order:

- “1010 Base cover” on page 32
- “1020 Battery pack” on page 35

Figure 5. Removal steps of DIMM

Remove the memory EMI shielding bracket. Release the two latches on both edges of the socket at the same time in the directions shown by arrows **1**, and then unplug the DIMM in the direction shown by arrow **2**.

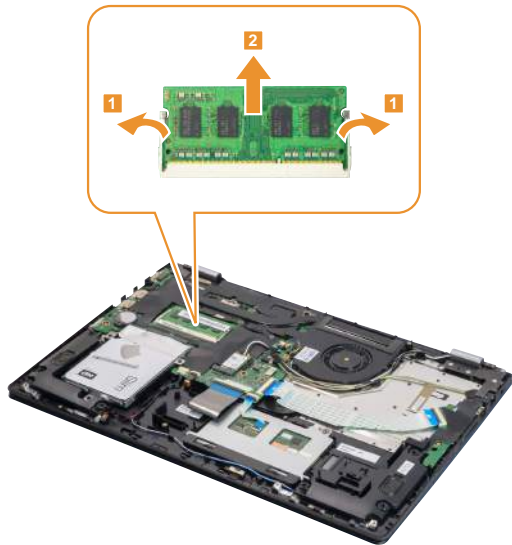

When installing: Insert the notched end of the DIMM into the socket. Push the DIMM firmly, and pivot it until it snaps into place. Make sure that it is firmly fixed in the slot and is difficult to move.

1060 IO board

For access, remove these FRUs in order:

- “1010 Base cover” on page 32
- “1020 Battery pack” on page 35

Figure 6. Removal steps of IO board

Detach the LED board connector in the directions shown by arrows **1** and **2**. Remove the screw **3**.



Step	Screw (quantity)	Color	Torque
3	M2.0 × 4.0 mm, Phillips head, nylok-coated (1) IO to Hinge to U case (FLEX 3-1480)	Black	2.0 kgf*cm
3	M2.0 × 2.5 mm, Phillips head, nylok-coated (1) IO to U case (FLEX 3-1580)	Black	2.0 kgf*cm

Remove the LED board in the direction shown by arrow **4**.

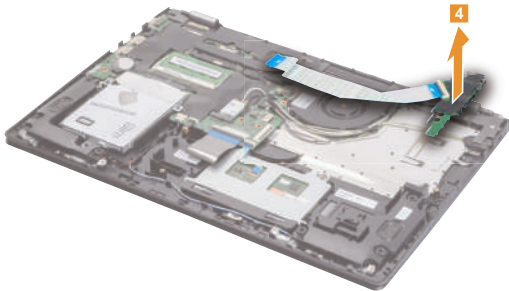

When installing: Make sure that the connector is attached firmly.

1070 Speakers

For access, remove these FRUs in order:

- “1010 Base cover” on page 32
- “1020 Battery pack” on page 35

Figure 7. Removal steps of speakers

Detach the connector in the direction shown by arrow **1**.



Remove the speakers in the direction shown by arrows **2**.

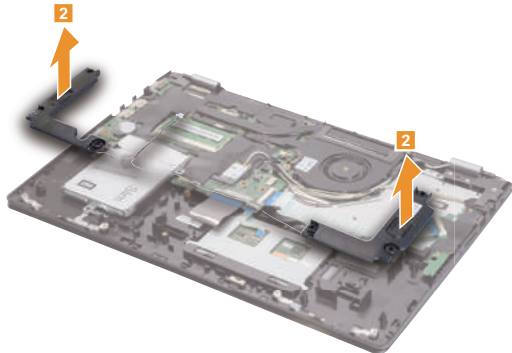

When installing: Make sure that the connector is attached firmly.

1080 Fan assembly and Heat Sink assembly

For access, remove these FRUs in order:

- “1010 Base cover” on page 32
- “1020 Battery pack” on page 35

Figure 8. Removal steps of fan assembly and heat sink assembly

Unplug the fan connector in the direction shown by arrow **1**. Loosen the five screws **2**. Release the cables from the cable guides **3**.

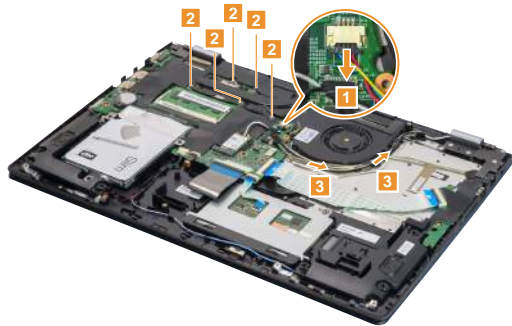
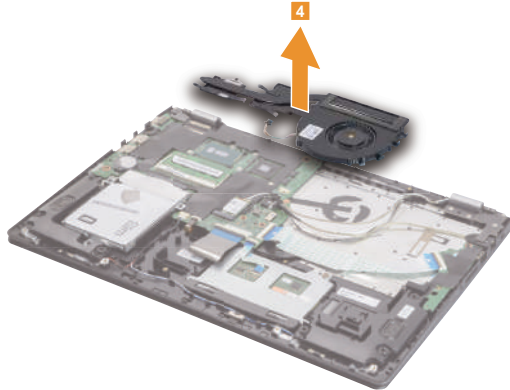

Figure 8. Removal steps of fan assembly and heat sink assembly (continued)

Remove the Fan and Heat Sink in the direction shown by arrow **4**.



When installing:

- Route the antenna cables along the cable guides. As you route the cables, make sure that they are not subjected to any tension. Tension could cause the cables to be damaged by the cable guides, or a wire to be broken.
- Make sure that the connector is attached firmly.

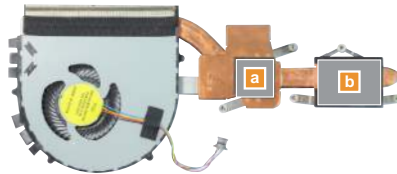

When installing:

Before you attach the fan assembly to the computer, apply thermal grease, at an amount of 0.2 grams, to the **a** **b** part shown in the figure above. Either too much or too less grease application can cause a thermal problem due to imperfect contact with a component.

1090 System board

Important notices for handling the system board:

When handling the system board, bear the following in mind.

- Be careful not to drop the system board on a bench top that has a hard surface, such as metal, wood, or composite.
- Avoid rough handling of any kind.
- During the whole process, make sure not to drop or stack the system board.
- If you put a system board down, make sure to put it only on a padded surface such as an ESD mat or conductive corrugated material.

For access, remove these FRUs in order:

- “1010 Base cover” on page 32
- “1020 Battery pack” on page 35
- “1030 Hard disk drive” on page 37
- “1040 PCI Express Mini Card for wireless LAN” on page 40
- “1060 IO board” on page 43
- “1070 Speakers” on page 44
- “1080 Fan assembly and Heat Sink assembly” on page 45

Figure 9. Removal steps of system board

Detach the LCD cable in the directions shown by arrows **1** and **2**.

FLEX 3-1480



Figure 9. Removal steps of system board (continued)

FLEX 3-1580

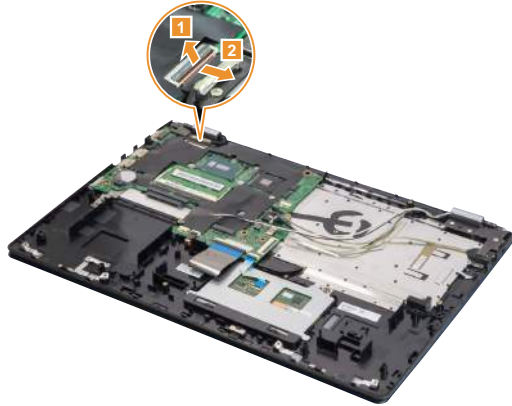

When installing: Make sure that the connector is attached firmly.

Remove the screws **3**.

FLEX 3-1480

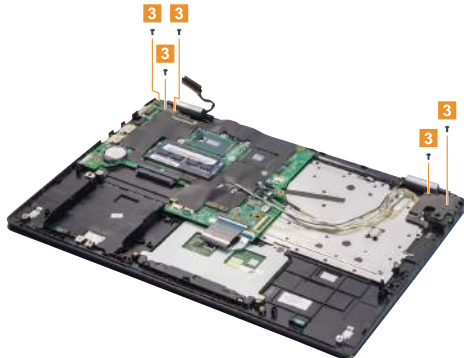
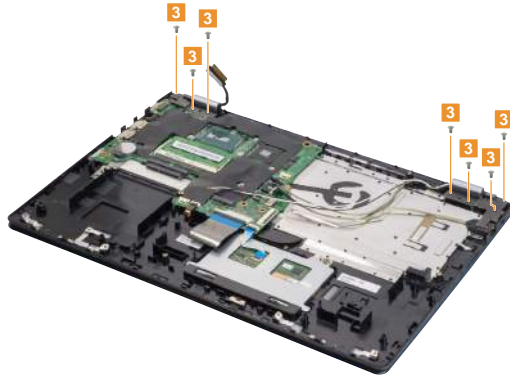

Figure 9. Removal steps of system board (continued)

FLEX 3-1580



Step	Screw (quantity)	Color	Torque
3	M2.0 × 4.0 mm, Phillips head, nylok-coated (5) Hinge to UCASE (FLEX 3-1480)	Black	2.0 kgf*cm
3	M2.5 × 4.0 mm, Phillips head, nylok-coated (7) Hinge to UCASE (FLEX 3-1580)	Silver	2.5 kgf*cm

Open the hinges **4**.

FLEX 3-1480

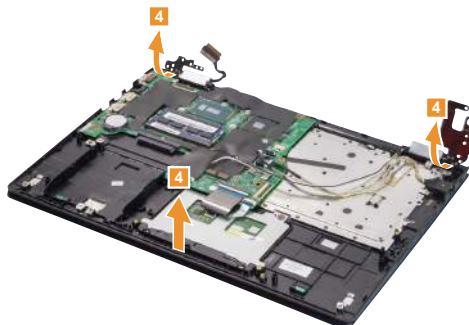
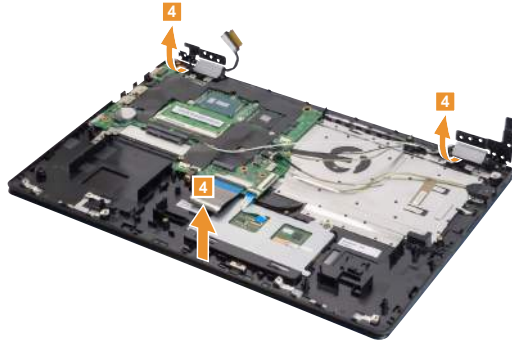

Figure 9. Removal steps of system board (continued)

FLEX 3-1580



Disconnect the DC-in cable in the direction shown by arrow **5**.

FLEX 3-1480

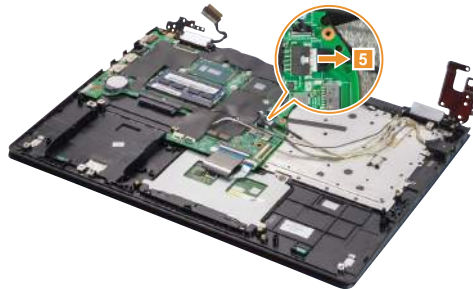
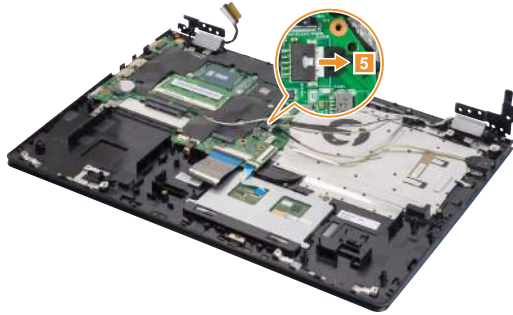

Figure 9. Removal steps of system board (continued)

FLEX 3-1580



When installing: Make sure that the connector is attached firmly.

Remove the DC-in cable in the direction shown by arrows 6.

FLEX 3-1480

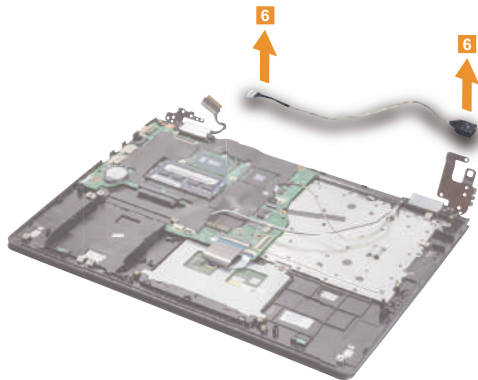
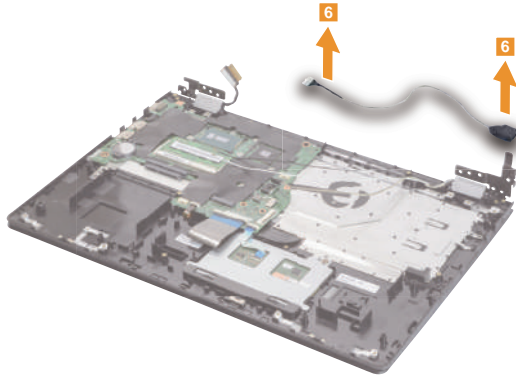

Figure 9. Removal steps of system board (continued)

FLEX 3-1580



Disconnect the connectors in the directions shown by arrows **7**, **8** and **9**.
Remove the screws **10**.

FLEX 3-1480

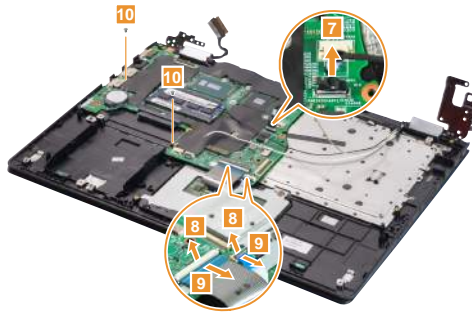
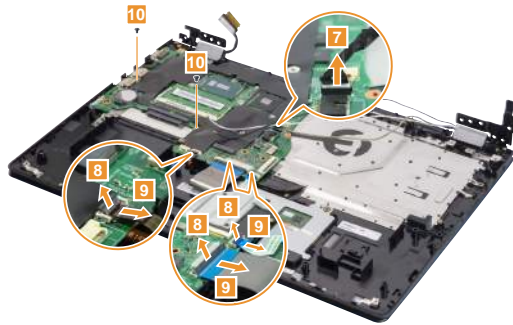

Figure 9. Removal steps of system board (continued)

FLEX 3-1580



Step	Screw (quantity)	Color	Torque
10	M2.0 × 2.5 mm, Phillips head, nylok-coated (2) M/B to U case	Silver/ Black	2.0 kgf*cm

When installing: Make sure that the connectors are attached firmly.

Remove the system board **11**.

FLEX 3-1480

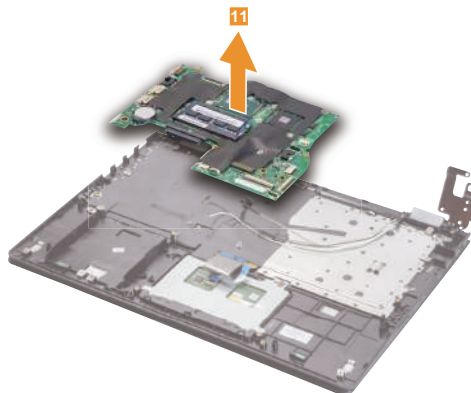
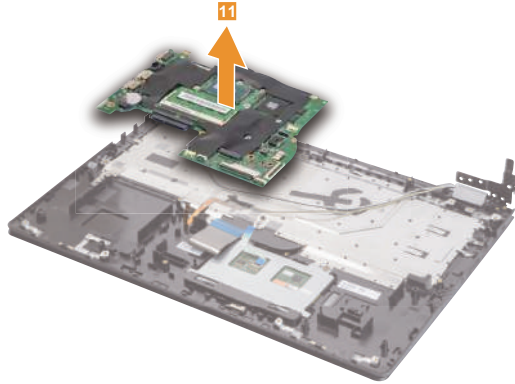

Figure 9. Removal steps of system board (continued)

FLEX 3-1580



1100 Touchpad module and upper case

For access, remove these FRUs in order:

- “1010 Base cover” on page 32
- “1020 Battery pack” on page 35
- “1030 Hard disk drive” on page 37
- “1040 PCI Express Mini Card for wireless LAN” on page 40
- “1060 IO board” on page 43
- “1070 Speakers” on page 44
- “1080 Fan assembly and Heat Sink assembly” on page 45
- “1090 System board” on page 47

Figure 10. Removal steps of touchpad module and upper case

Peel off the keyboard mylar in the direction shown by arrow **1**. Remove the two screws **2**.

FLEX 3-1480

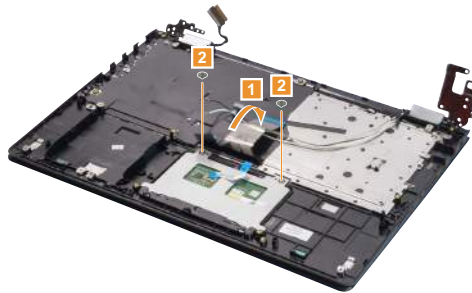
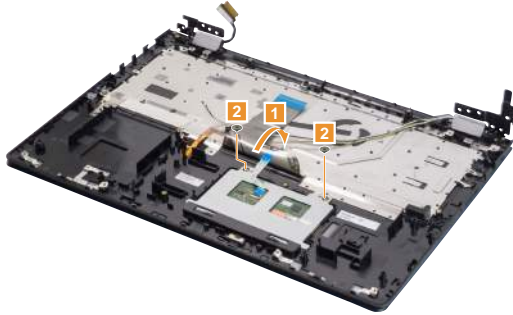

Figure 10. Removal steps of touchpad module and upper case (continued)

FLEX 3-1580



Step	Screw (quantity)	Color	Torque
2	M2.0 × 2.5 mm, Phillips head, nylok-coated (2) TP Bracketr to U case	Black	2.0 kg*cm

Figure 10. Removal steps of touchpad module and upper case (continued)

Remove the touchpad module from the upper case in the directions shown by arrows 3 and 4.

FLEX 3-1480

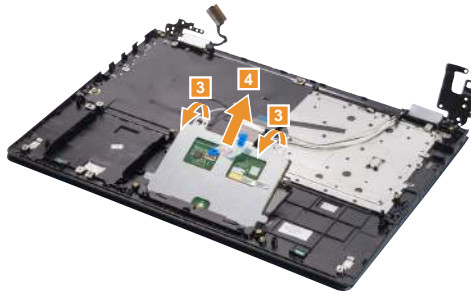

FLEX 3-1580

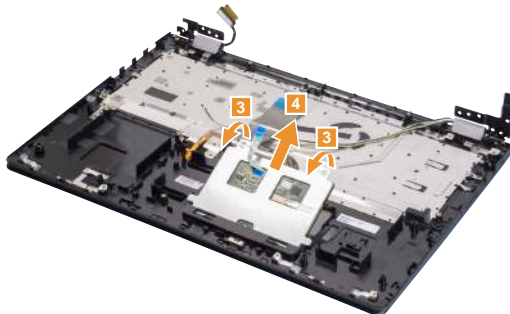
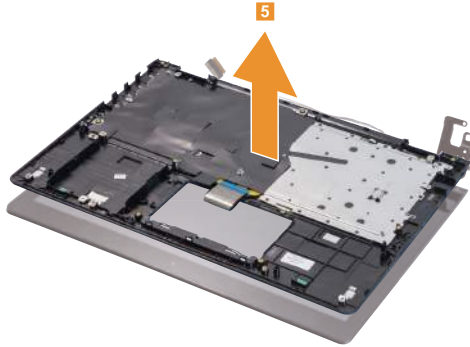

Figure 10. Removal steps of touchpad module and upper case (continued)

Remove the upper case in the direction shown by arrow **5**.

FLEX 3-1480



FLEX 3-1580

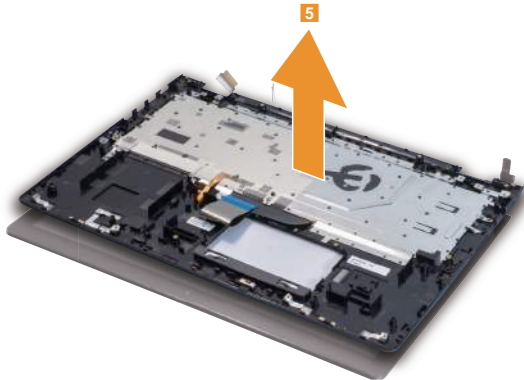

1110 LCD unit

For access, remove these FRUs in order:

- “1010 Base cover” on page 32
- “1020 Battery pack” on page 35
- “1030 Hard disk drive” on page 37
- “1040 PCI Express Mini Card for wireless LAN” on page 40
- “1060 IO board” on page 43
- “1070 Speakers” on page 44
- “1080 Fan assembly and Heat Sink assembly” on page 45
- “1090 System board” on page 47
- “1100 Touchpad module and upper case” on page 55

Figure 11. Removal steps of LCD unit

Remove LCD bezel screw pads **1** and the screws **2**.

FLEX 3-1480



Figure 11. Removal steps of LCD unit (continued)

FLEX 3-1580



Step	Screw (quantity)	Color	Torque
2	M2.0 × 4.0 mm, Phillips-head, nylok-coated (2) Bezel cover to Panel	Black/ Silver	2.0 kgf*cm

Figure 11. Removal steps of LCD unit (continued)

Separate the hinge cover from the rest of LCD unit with a prying tool **3**. Remove the hinge cover and LCD bezel cover in the direction shown by arrows **4**.

FLEX 3-1480

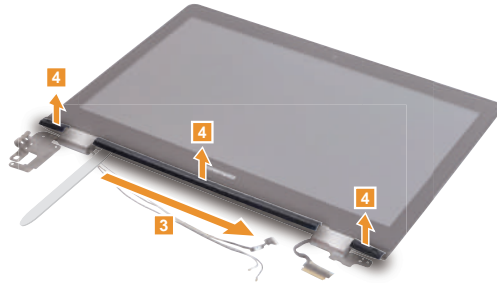

FLEX 3-1580

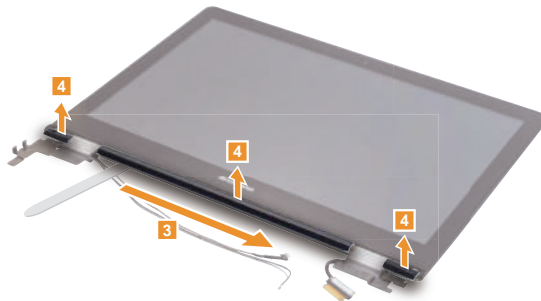

1120 Hinges and LCD cover

For access, remove these FRUs in order:

- “1010 Base cover” on page 32
- “1020 Battery pack” on page 35
- “1030 Hard disk drive” on page 37
- “1040 PCI Express Mini Card for wireless LAN” on page 40
- “1060 IO board” on page 43
- “1070 Speakers” on page 44
- “1080 Fan assembly and Heat Sink assembly” on page 45
- “1090 System board” on page 47
- “1100 Touchpad module and upper case” on page 55
- “1110 LCD unit” on page 59

Figure 12. Removal steps of hinges and LCD cover

Adjust the hinges **1** and remove the hinge rubbers **2**. Remove the screws **3**. Then remove the LCD module in the direction shown by arrows **4**.

FLEX 3-1480

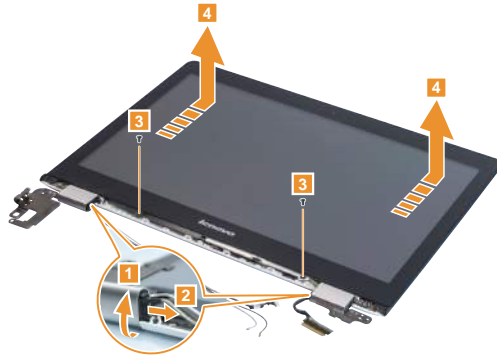
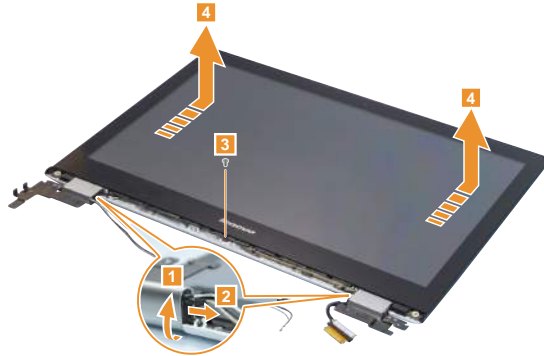

Figure 12. Removal steps of hinges and LCD cover (continued)

FLEX 3-1580



Step	Screw (quantity)	Color	Torque
3	M2.0 × 4.0 mm, Phillips-head, nylok-coated (2) Bezel to Panel (FLEX 3-1480)	Black	2.0 kgf*cm
3	M2.0 × 4.0 mm, Phillips-head, nylok-coated (1) Bezel to Panel (FLEX 3-1580)	Silver	2.0 kgf*cm

When installing:

- Make sure that the connector is attached firmly.
- Push the LCD module in the direction shown by the arrow on illustration below, otherwise the hooks of the LCD cover might be damaged.

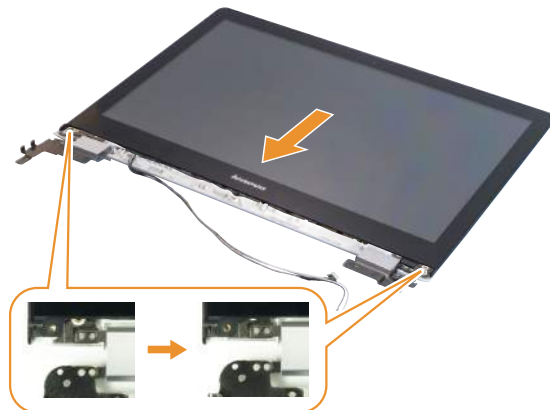
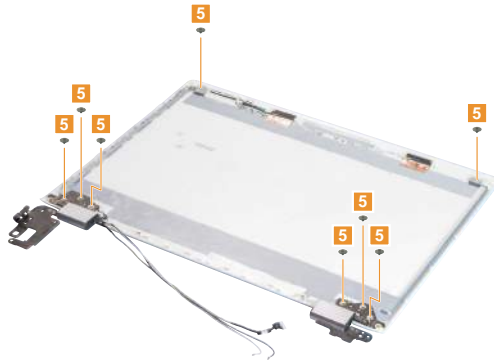

Figure 12. Removal steps of hinges and LCD cover (continued)

Remove the screws **5**.

FLEX 3-1480



FLEX 3-1580



Step	Screw (quantity)	Color	Torque
5	M2 × 2.5 mm, Phillips-head, nylok-coated (8) LCD-Brkt to Hinge to Panel	Black	2.0 kgf*cm

Figure 12. Removal steps of hinges and LCD cover (continued)

Remove the hinges **6**.

FLEX 3-1480

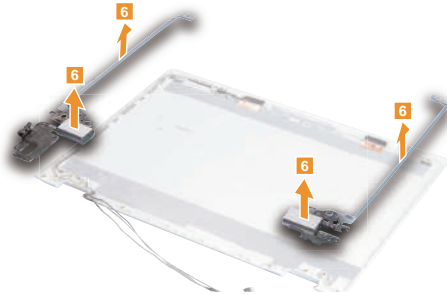

FLEX 3-1580

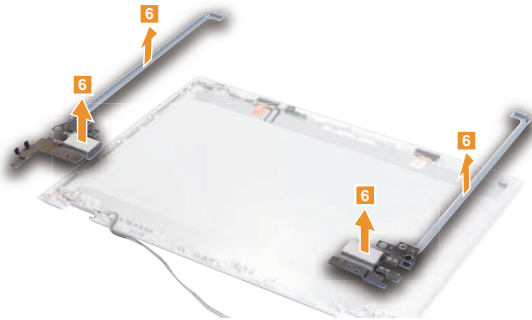

1130 Sensor board and antenna assembly

For access, remove these FRUs in order:

- “1010 Base cover” on page 32
- “1020 Battery pack” on page 35
- “1030 Hard disk drive” on page 37
- “1040 PCI Express Mini Card for wireless LAN” on page 40
- “1060 IO board” on page 43
- “1070 Speakers” on page 44
- “1080 Fan assembly and Heat Sink assembly” on page 45
- “1090 System board” on page 47
- “1100 Touchpad module and upper case” on page 55
- “1110 LCD unit” on page 59
- “1120 Hinges and LCD cover” on page 62

Figure 13. Removal steps of sensor board and antenna assembly

FLEX 3-1480

Peel off the adhesive tape securing the cables **1**.



Figure 13. Removal steps of sensor board and antenna assembly (continued)

Detach the sensor board connector in the direction shown by arrow **2**.



When installing: Make sure that the connector is attached firmly.

Figure 13. Removal steps of sensor board and antenna assembly (continued)

Peel off the adhesive tape securing the antenna boards. Release the cables from the cable guide, and then remove the antenna assembly and sensor board cable in the direction shown by arrows **3**.

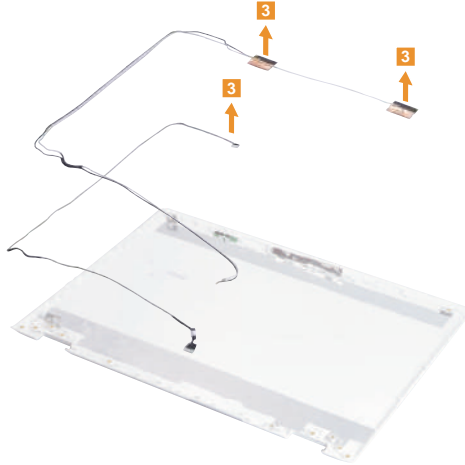

Remove the sensor board in the direction shown by arrow **4**.



Figure 13. Removal steps of sensor board and antenna assembly (continued)

FLEX 3-1580

Detach the sensor board connector in the direction shown by arrow **1**, then remove the sensor board in the direction shown by arrow **2**.



When installing: Make sure that the connector is attached firmly.

Peel off the adhesive tape securing the cables **3**.



Figure 13. Removal steps of sensor board and antenna assembly (continued)

Peel off the adhesive tape securing the antenna boards. Release the cables from the cable guide, and then remove the antenna assembly and sensor board cable in the direction shown by arrows **4**.



When installing: Route the antenna cables along the cable guides and secure the antenna boards with adhesive tape. As you route the cables, make sure that they are not subjected to any tension. Tension could cause the cables to be damaged by the cable guides, or a wire to be broken.

1140 LCD module

For access, remove these FRUs in order:

- “1010 Base cover” on page 32
- “1020 Battery pack” on page 35
- “1030 Hard disk drive” on page 37
- “1040 PCI Express Mini Card for wireless LAN” on page 40
- “1060 IO board” on page 43
- “1070 Speakers” on page 44
- “1080 Fan assembly and Heat Sink assembly” on page 45
- “1090 System board” on page 47
- “1100 Touchpad module and upper case” on page 55
- “1110 LCD unit” on page 59
- “1120 Hinges and LCD cover” on page 62

Figure 14. Removal steps of LCD module

Detach the three connectors in the directions shown by arrows **1**.



When installing: Make sure that the connectors are attached firmly.

Figure 14. Removal steps of LCD module (continued)

Remove the LCD cable **2**.

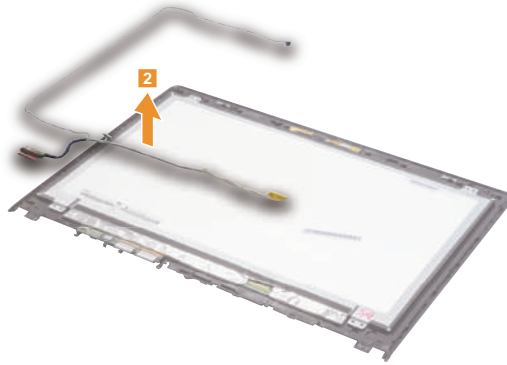

1150 Integrated camera

For access, remove these FRUs in order:

- “1010 Base cover” on page 32
- “1020 Battery pack” on page 35
- “1030 Hard disk drive” on page 37
- “1040 PCI Express Mini Card for wireless LAN” on page 40
- “1060 IO board” on page 43
- “1070 Speakers” on page 44
- “1080 Fan assembly and Heat Sink assembly” on page 45
- “1090 System board” on page 47
- “1100 Touchpad module and upper case” on page 55
- “1110 LCD unit” on page 59
- “1120 Hinges and LCD cover” on page 62
- “1140 LCD module” on page 71

Figure 15. Removal steps of integrated camera

Note: The integrated camera is stuck to the top of the LCD cover. Be careful when removing it.

Remove the integrated camera in the direction shown by arrow **1**.



When installing: Stick the integrated camera to the LCD cover and adjust the placement of the board to make sure the connectors are attached firmly.

Locations

Front view and right-side view

- 1 Integrated camera
- 2 Built-in microphone
- 3 Wireless LAN antennas
- 4 Multi-touch screen
- 5 HDMI port
- 6 RJ-45 port
- 7 USB port
- 8 Novo button
- 9 Power button
- 10 Battery status indicator

Note: For the description of each indicator, see “Status indicators” on page 28.

- 11 Touchpad

FLEX 3-1480



FLEX 3-1580



Bottom and Left-side view

- 1** Speaker
- 2** Volume up button
- 3** Volume down button
- 4** Rotation lock button
- 5** Combo audio jack
- 6** Memory card slot
- 7** USB port
- 8** AC power adapter jack
- 9** Kensington lock slot
- 10** Ventilation slots

FLEX 3-1480



FLEX 3-1580



Parts list

This section presents the following service parts:

- “Overall” on page 78
- “LCD FRUs” on page 86
- “Miscellaneous parts” on page 88
- “AC adapters” on page 89
- “Screws” on page 89
- “Power cords” on page 90

Note:

Each FRU is available for all types or models, unless specific types or models are specified.

Attention:

Do not attempt to replace an FRU on your own. If an FRU is damaged, contact a Lenovo authorized servicer or a marketing representative for replacement or repair. Only qualified technicians can inspect or repair this product.

Overall

FLEX 3-1480

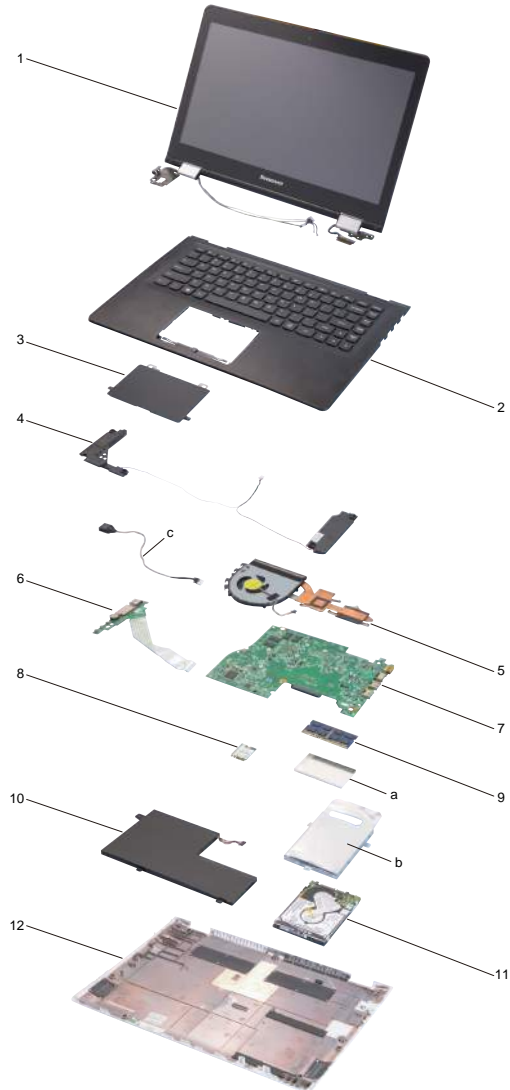

FLEX 3-1580

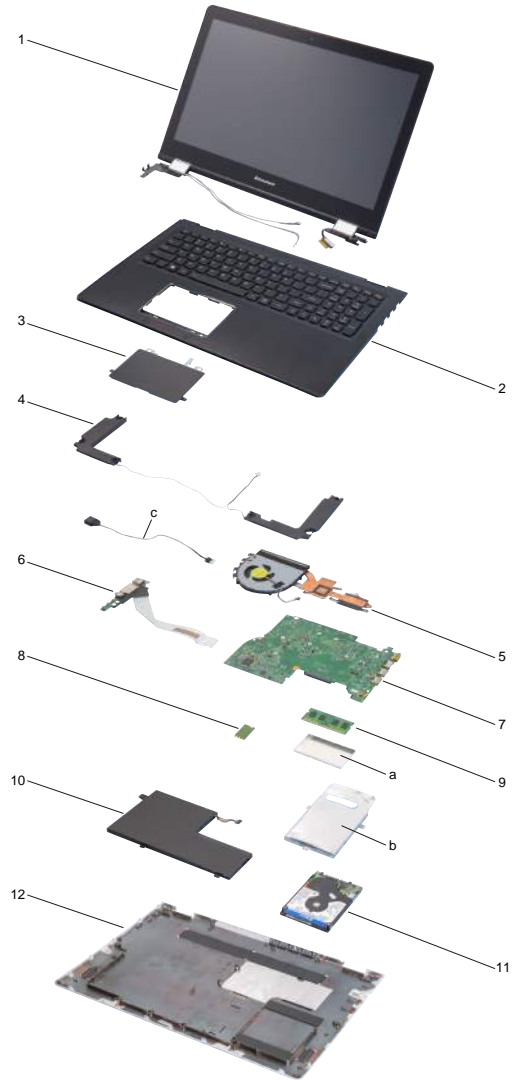

Table 5. Parts list—Overall

No.	FRU	FRU no.	CRU ID.	FLEX 3-1480	FLEX 3-1580
a-b	See "Miscellaneous parts" on page 88.				
1	LCD unit (see "LCD FRUs" on page 86.)				
2	Upper Case W Flex3-1470 US	5CB0H91250	N	●	
2	Upper Case W Flex3-1470 BKL US	5CB0H91126	N	●	
2	Upper Case W Flex3-1470 UK	5CB0H91156	N	●	
2	Upper Case W Flex3-1470 BKL UK	5CB0H91188	N	●	
2	Upper Case W Flex3-1470 NBKL AR	5CB0J34024	N	●	
2	Upper Case W Flex3-1470 NBKL GK	5CB0J34081	N	●	
2	Upper Case W Flex3-1470 NBKL HE	5CB0J34019	N	●	
2	Upper Case W Flex3-1470 NBKL INDIA	5CB0J34075	N	●	
2	Upper Case W Flex3-1470 NBKL KR	5CB0J34014	N	●	
2	Upper Case W Flex3-1470 NBKL TC	5CB0J34069	N	●	
2	Upper Case W Flex3-1470 NBKL RU	5CB0J34007	N	●	
2	Upper Case W Flex3-1470 NBKL TH	5CB0J34061	N	●	
2	Upper Case W Flex3-1470 NBKL US INT	5CB0J34013	N	●	
2	Upper Case W Flex3-1470 BKL AR	5CB0J34107	N	●	
2	Upper Case W Flex3-1470 BKL GK	5CB0J34071	N	●	
2	Upper Case W Flex3-1470 BKL HE	5CB0J34009	N	●	
2	Upper Case W Flex3-1470 BKL INDIA	5CB0J34065	N	●	
2	Upper Case W Flex3-1470 BKL KR	5CB0J34001	N	●	
2	Upper Case W Flex3-1470 BKL TC	5CB0J34055	N	●	
2	Upper Case W Flex3-1470 BKL RU	5CB0J34106	N	●	
2	Upper Case W Flex3-1470 BKL TH	5CB0J34053	N	●	
2	Upper Case W Flex3-1470 BKL US INT	5CB0J34105	N	●	
2	Upper Case W Flex3-1470 BKL USA	5CB0J34044	N	●	
2	Upper Case W Flex3-1470 NBKL IT	5CB0J34070	N	●	
2	Upper Case W Flex3-1470 NBKL SP	5CB0J34008	N	●	
2	Upper Case W Flex3-1470 NBKL TR	5CB0J34062	N	●	
2	Upper Case W Flex3-1470 NBKL PO	5CB0J34000	N	●	
2	Upper Case W Flex3-1470 NBKL LA	5CB0J34054	N	●	
2	Upper Case W Flex3-1470 NBKL EF-C	5CB0J34108	N	●	
2	Upper Case W Flex3-1470 NBKL FR	5CB0J34046	N	●	
2	Upper Case W Flex3-1470 NBKL GR	5CB0J34003	N	●	
2	Upper Case W Flex3-1470 NBKL BZ	5CB0J34057	N	●	
2	Upper Case W Flex3-1470 NBKL AR-E	5CB0J34110	N	●	
2	Upper Case W Flex3-1470 NBKL DUTH	5CB0J34047	N	●	
2	Upper Case W Flex3-1470 NBKL HG	5CB0J34020	N	●	
2	Upper Case W Flex3-1470 NBKL ND	5CB0J34076	N	●	
2	Upper Case W Flex3-1470 NBKL BE	5CB0J34015	N	●	
2	Upper Case W Flex3-1470 NBKL ICE	5CB0J34067	N	●	
2	Upper Case W Flex3-1470 NBKL SA	5CB0J34010	N	●	
2	Upper Case W Flex3-1470 NBKL SW	5CB0J34063	N	●	
2	Upper Case W Flex3-1470 NBKL CZ-SK	5CB0J34021	N	●	
2	Upper Case W Flex3-1470 NBKL BG	5CB0J34077	N	●	
2	Upper Case W Flex3-1470 BKL IT	5CB0J34101	N	●	
2	Upper Case W Flex3-1470 BKL SP	5CB0J34040	N	●	
2	Upper Case W Flex3-1470 BKL TR	5CB0J34093	N	●	

Table 5. Parts list—Overall (continued)

No.	FRU	FRU no.	CRU ID.	FLEX 3-1480	FLEX 3-1580
2	Upper Case W Flex3-1470 BKL PO	5CB0J34049	N	•	
2	Upper Case W Flex3-1470 BKL LA	5CB0J34102	N	•	
2	Upper Case W Flex3-1470 BKL EF-C	5CB0J34041	N	•	
2	Upper Case W Flex3-1470 BKL FR	5CB0J34094	N	•	
2	Upper Case W Flex3-1470 BKL GR	5CB0J34031	N	•	
2	Upper Case W Flex3-1470 BKL BZ	5CB0J34098	N	•	
2	Upper Case W Flex3-1470 BKL AR-E	5CB0J34036	N	•	
2	Upper Case W Flex3-1470 BKL DUTH	5CB0J34089	N	•	
2	Upper Case W Flex3-1470 BKL HG	5CB0J34028	N	•	
2	Upper Case W Flex3-1470 BKL ND	5CB0J34084	N	•	
2	Upper Case W Flex3-1470 BKL BE	5CB0J34022	N	•	
2	Upper Case W Flex3-1470 BKL ICE	5CB0J34078	N	•	
2	Upper Case W Flex3-1470 BKL SA	5CB0J34037	N	•	
2	Upper Case W Flex3-1470 BKL SW	5CB0J34090	N	•	
2	Upper Case W Flex3-1470 BKL CZ-SK	5CB0J34029	N	•	
2	Upper Case W Flex3-1470 BKL BG	5CB0J34085	N	•	
2	Upper Case W Flex3-1570 US	5CB0H91211	N		•
2	Upper Case W Flex3-1570 BKL US	5CB0H91243	N		•
2	Upper Case W Flex3-1570 UK	5CB0H91271	N		•
2	Upper Case W Flex3-1570 BKL UK	5CB0H91148	N		•
2	Upper Case W Flex3-1570 NBKL TH	5CB0J34103	N		•
2	Upper Case W Flex3-1570 NBKL KR	5CB0J34042	N		•
2	Upper Case W Flex3-1570 NBKL TC	5CB0J34097	N		•
2	Upper Case W Flex3-1570 NBKL RU	5CB0J34035	N		•
2	Upper Case W Flex3-1570 NBKL AR	5CB0J34088	N		•
2	Upper Case W Flex3-1570 NBKL GK	5CB0J34027	N		•
2	Upper Case W Flex3-1570 NBKL HE	5CB0J34083	N		•
2	Upper Case W Flex3-1570NBKL US INTE	5CB0J34023	N		•
2	Upper Case W Flex3-1570NBKL INDIA	5CB0J34080	N		•
2	Upper Case W Flex3-1570 BKL USA	5CB0J34016	N		•
2	Upper Case W Flex3-1570 BKL TH	5CB0J34068	N		•
2	Upper Case W Flex3-1570 BKL KR	5CB0J34006	N		•
2	Upper Case W Flex3-1570 BKL TC	5CB0J34060	N		•
2	Upper Case W Flex3-1570 BKL RU	5CB0J33998	N		•
2	Upper Case W Flex3-1570 BKL AR	5CB0J34050	N		•
2	Upper Case W Flex3-1570 BKL GK	5CB0J34099	N		•
2	Upper Case W Flex3-1570 BKL HE	5CB0J34038	N		•
2	Upper Case W Flex3-1570BKL US INTE	5CB0J34091	N		•
2	Upper Case W Flex3-1570 BKL INDIA	5CB0J34030	N		•
2	Upper Case W Flex3-1570 NBKL IT	5CB0J34018	N		•
2	Upper Case W Flex3-1570 NBKL SP	5CB0J34074	N		•
2	Upper Case W Flex3-1570 NBKL TR	5CB0J34072	N		•
2	Upper Case W Flex3-1570 NBKL PO	5CB0J34011	N		•
2	Upper Case W Flex3-1570 NBKL LA	5CB0J34064	N		•
2	Upper Case W Flex3-1570 NBKL EF-C	5CB0J34004	N		•
2	Upper Case W Flex3-1570 NBKL FR	5CB0J34058	N		•
2	Upper Case W Flex3-1570 NBKL GR	5CB0J34111	N		•

Table 5. Parts list—Overall (continued)

No.	FRU	FRU no.	CRU ID.	FLEX 3-1480	FLEX 3-1580
2	Upper Case W Flex3-1570 NBKL BZ	5CB0J34048	N		•
2	Upper Case W Flex3-1570NBKL DUTCH	5CB0J34100	N		•
2	Upper Case W Flex3-1570 NBKL HG	5CB0J34039	N		•
2	Upper Case W Flex3-1570 NBKL ND	5CB0J34092	N		•
2	Upper Case W Flex3-1570 NBKL BE	5CB0J34034	N		•
2	Upper Case W Flex3-1570 NBKL ICE	5CB0J34087	N		•
2	Upper Case W Flex3-1570 NBKL SA	5CB0J34026	N		•
2	Upper Case W Flex3-1570 NBKL SW	5CB0J34082	N		•
2	Upper Case W Flex3-1570NBKL CZ-SK	5CB0J34052	N		•
2	Upper Case W Flex3-1570 NBKL BG	5CB0J34104	N		•
2	Upper Case W Flex3-1570 NBKL AR-E	5CB0J34043	N		•
2	Upper Case W Flex3-1570 BKL IT	5CB0J34086	N		•
2	Upper Case W Flex3-1570 BKL SP	5CB0J34025	N		•
2	Upper Case W Flex3-1570 BKL TR	5CB0J34079	N		•
2	Upper Case W Flex3-1570 BKL PO	5CB0J34017	N		•
2	Upper Case W Flex3-1570 BKL LA	5CB0J34073	N		•
2	Upper Case W Flex3-1570 BKL EF-C	5CB0J34012	N		•
2	Upper Case W Flex3-1570 BKL FR	5CB0J34066	N		•
2	Upper Case W Flex3-1570 BKL GR	5CB0J34002	N		•
2	Upper Case W Flex3-1570 BKL BZ	5CB0J34056	N		•
2	Upper Case W Flex3-1570 BKL DUTCH	5CB0J34109	N		•
2	Upper Case W Flex3-1570 BKL HG	5CB0J34045	N		•
2	Upper Case W Flex3-1570 BKL ND	5CB0J34096	N		•
2	Upper Case W Flex3-1570 BKL BE	5CB0J34033	N		•
2	Upper Case W Flex3-1570 BKL ICE	5CB0J34095	N		•
2	Upper Case W Flex3-1570 BKL SA	5CB0J34032	N		•
2	Upper Case W Flex3-1570 BKL SW	5CB0J34005	N		•
2	Upper Case W Flex3-1570 BKL CZ-SK	5CB0J34059	N		•
2	Upper Case W Flex3-1570 BKL BG	5CB0J33999	N		•
2	Upper Case W Flex3-1570 BKL AR-E	5CB0J34051	N		•
3	Touchpad Module W Flex3-1470W/C	5T60H91163	N	•	
3	Thouchpad Module W Flex3-1570	5T60H91179	N		•
4	Speaker W Flex3-1470	5SB0H91206	N	•	
4	Speaker W Flex3-1570	5SB0H91212	N		•
5	Thermal Module W 80R3 DIS W/F	5H40K36385	N	•	•
5	Thermal Module W 80R3 UMA W/F	5H40K36386	N	•	•
6	I/O Board W Flex3-1470 W/Cable	5C50H91127	N	•	
6	I/O Board W Flex3-1570 W/Cable	5C50H91267	N		•
7	MB W 80R3 4405U UMA WIN	5B20K36388	N	•	
7	MB W 80R3 4405U N16SGT 2G WIN	5B20K36391	N	•	
7	MB W 80R3 4405U N16VGM 2G WIN	5B20K36381	N	•	
7	MB W 80R3 I3 6100U UMA WIN	5B20K36387	N	•	
7	MB W 80R3 I36100U N16SGT 2G WIN	5B20K36394	N	•	
7	MB W 80R3 I36100U N16VGM 2G WIN	5B20K36390	N	•	
7	MB W 80R3 I5 6200U UMA WIN	5B20K36393	N	•	
7	MB W 80R3 I56200U N16SGT 2G WIN	5B20K36392	N	•	
7	MB W 80R3 I56200U N16VGM 2G WIN	5B20K36384	N	•	

Table 5. Parts list—Overall (continued)

No.	FRU	FRU no.	CRU ID.	FLEX 3-1480	FLEX 3-1580
7	MB W 80R3 I7 6500U UMA WIN	5B20K36389	N	•	
7	MB W 80R3 I76500U N16SGT 2G WIN	5B20K36382	N	•	
7	MB W 80R3 I76500U N16VGM 2G WIN	5B20K36383	N	•	
7	MB W 80R3 NOK 4405U UMA	5B20K61840	N	•	
7	MB W 80R3 NOK 4405U N16SGT 2G	5B20K61839	N	•	
7	MB W 80R3 NOK 4405U N16VGM 2G	5B20K61842	N	•	
7	MB W 80R3 NOK I36100U UMA	5B20K61837	N	•	
7	MB W 80R3 NOK I36100U N16SGT 2G	5B20K61841	N	•	
7	MB W 80R3 NOK I36100U N16VGM 2G	5B20K61846	N	•	
7	MB W 80R3 NOK I56200U UMA	5B20K61843	N	•	
7	MB W 80R3 NOK I56200U N16SGT 2G	5B20K61844	N	•	
7	MB W 80R3 NOK I56200U N16VGM 2G	5B20K61845	N	•	
7	MB W 80R3 NOK I76500U UMA	5B20K61838	N	•	
7	MB W 80R3 NOK I76500U N16SGT 2G	5B20K61836	N	•	
7	MB W 80R3 NOK I76500U N16VGM 2G	5B20K61847	N	•	
7	MB W 80R4 4405U UMA WIN	5B20K36403	N		•
7	MB W 80R4 4405U N16SGT 2G WIN	5B20K36406	N		•
7	MB W 80R4 4405U N16VGM 2G WIN	5B20K36399	N		•
7	MB W 80R4 I3 6100U UMA WIN	5B20K36405	N		•
7	MB W 80R4 I36100U N16SGT 2G WIN	5B20K36402	N		•
7	MB W 80R4 I36100U N16VGM 2G WIN	5B20K36397	N		•
7	MB W 80R4 I5 6200U UMA WIN	5B20K36404	N		•
7	MB W 80R4 I56200U N16SGT 2G WIN	5B20K36401	N		•
7	MB W 80R4 I56200U N16VGM 2G WIN	5B20K36396	N		•
7	MB W 80R4 I7 6500U UMA WIN	5B20K36400	N		•
7	MB W 80R4 I76500U N16SGT 2G WIN	5B20K36398	N		•
7	MB W 80R4 I76500U N16VGM 2G WIN	5B20K36407	N		•
7	MB W 80R4 NOK 4405U UMA	5B20K61849	N		•
7	MB W 80R4 NOK 4405U N16SGT 2G	5B20K61852	N		•
7	MB W 80R4 NOK 4405U N16VGM 2G	5B20K61853	N		•
7	MB W 80R4 NOK I36100U UMA	5B20K61858	N		•
7	MB W 80R4 NOK I36100U N16SGT 2G	5B20K61854	N		•
7	MB W 80R4 NOK I36100U N16VGM 2G	5B20K61851	N		•
7	MB W 80R4 NOK I56200U UMA	5B20K61859	N		•
7	MB W 80R4 NOK I56200U N16SGT 2G	5B20K61856	N		•
7	MB W 80R4 NOK I56200U N16VGM 2G	5B20K61857	N		•
7	MB W 80R4 NOK I76500U UMA	5B20K61855	N		•
7	MB W 80R4 NOK I76500U N16SGT 2G	5B20K61848	N		•
7	MB W 80R4 NOK I76500U N16VGM 2G	5B20K61850	N		•
8	NBWLAN, Intel 3165 1x1AC+BT PCIE M.2 WLAN	SW10H24486	N	•	•
8	NBWLAN, Cbt BCM43162 1x1AC+BT4.0 PCIE M.2 WLAN V2	SW10A11586	N	•	•
8	NBWLAN, Cbt RTL8821AE 1x1AC+BT4.0 PCIE M.2 WLAN	SW10A11648	N	•	•
8	NBWLAN, Ltn NFA435 1x1AC+BT4.0 PCIE M.2 WLAN	SW10A11641	N	•	•

Table 5. Parts list—Overall (continued)

No.	FRU	FRU no.	CRU ID.	FLEX 3-1480	FLEX 3-1580
8	NBWLAN,Ltn BCM4350 2x2AC+BT4.0 PCIE M.2 WLAN	SW10H24481	N	•	•
8	NBWLAN,Fxn BCM4350 2x2AC+BT4.0 PCIE M.2 WLAN	SW10H24482	N	•	•
9	RAM,M471B5173EB0-YK0	5M30G18425	N	•	•
9	RAM,HMT451S6BFR8A-PB/RD 4GB DDR3L 1600	11202706	N	•	•
9	RAM,RMT3170MN68F9F-1600 N -die/25nm/4Gb Mono	5M30G75129	N	•	•
9	RAM,MT8KTF51264HZ-1G6E1 4GB DDR3L 1600	11202125	N	•	•
9	RAM,MEMORY M471B1G73EB0-YK0 1600 8GB	5M30G18424	N	•	•
9	RAM,HMT41GS6BFR8A-PB/RD 8GB DDR3L 1600	11202707	N	•	•
9	RAM,RMT3160ME68FAF-1600 8GB DDR3L 1600	11202450	N	•	•
9	RAM,MT16KTF1G64HZ-1G6E1 8GB DDR3L 1600	11201304	N	•	•
10	Battery, C112:C127Tesla SP/A L14M2P21 7.4V30Wh2cell bty	5B10G78612	N	•	•
10	Battery, Tesla SP/C L14M2P21 7.4V30Wh2cell bty	5B10G78610	N	•	•
10	Battery, Tesla LG L15L2PB0 7.4V30Wh2cell bty	5B10J40591	N	•	•
10	Battery, Tesla SP/A L14M2P21 7.4V30Wh2cell GB	5B10K10182	N	•	•
10	Battery, Tesla SP/C L14M2P21 7.4V30Wh2cell GB	5B10K10229	N	•	•
10	Battery, Tesla LGL14L2P21 7.4V30Wh2cell GB	5B10K10180	N	•	•
10	Battery, Tesla SP/A L14M3P21 11.1V45Wh3cell bty	5B10G78611	N	•	•
10	Battery, Tesla SP/C L14M3P21 11.1V45Wh3cell bty	5B10G78609	N	•	•
10	Battery, Tesla LG L15L3PB0 11.1V45Wh3cell bty	5B10J40590	N	•	•
10	Battery, Tesla SP/A L14M3P21 11.1V45Wh3cell GB	5B10K10186	N	•	•
10	Battery, Tesla SP/C L14M3P21 11.1V45Wh3cell GB	5B10K10236	N	•	•
10	Battery, Tesla LG L14L3P21 11.1V45Wh3cell GB	5B10K10214	N	•	•
11	Hard disk drive,ST500LT012 6G 7mm 5.4K 500G HDD	16200383	N	•	•
11	Hard disk drive,HTS545050A7E660 6G 7mm 5.4K 500G HDD	5H20H14223	N	•	•
11	Hard disk drive,MQ01ABF050 6G 7mm 5.4K 500G HDD	16200433	N	•	•

Table 5. Parts list—Overall (continued)

No.	FRU	FRU no.	CRU ID.	FLEX 3-1480	FLEX 3-1580
11	Hard disk drive,WD WD5000LPCX-24VHAT0 7mm 5400rpm 500G HDD	5H20J35762	N	•	•
11	Hard disk drive,ST500LM000 6G 7mm 500G+8G SSHD	5H20H24608	N	•	•
11	Hard disk drive,HTS541010A7E630	16200658	N	•	•
11	Hard disk drive,WD10SPCX-24HWST1 6G 7mm 1T HDD	16200554	N	•	•
11	Hard disk drive,MQ02ABF	5H20G09709	N	•	•
11	Hard disk drive,WD10S21X-24R1BT0 7mm 5400rpm 1TB+8G SSHD	16200681	N	•	•
12	Lower Case W Flex3-1470 Red	5CB0H91133	N	•	
12	Lower Case W Flex3-1470 Black	5CB0H91166	N	•	
12	Lower Case W Flex3-1470 White	5CB0H91195	N	•	
12	Lower Case W Flex 3-1535 Black	5CB0J91258	N		•
12	Lower Case W Flex 3-1535 White	5CB0J91256	N		•
—	AC adapter (see "AC adapters" on page 89).				

LCD FRUs

In Lenovo FLEX 3-1480/FLEX 3-1580, there are following types of LCDs.

- “14.0-in. HD LED”
- “15.6-in. HD LED”

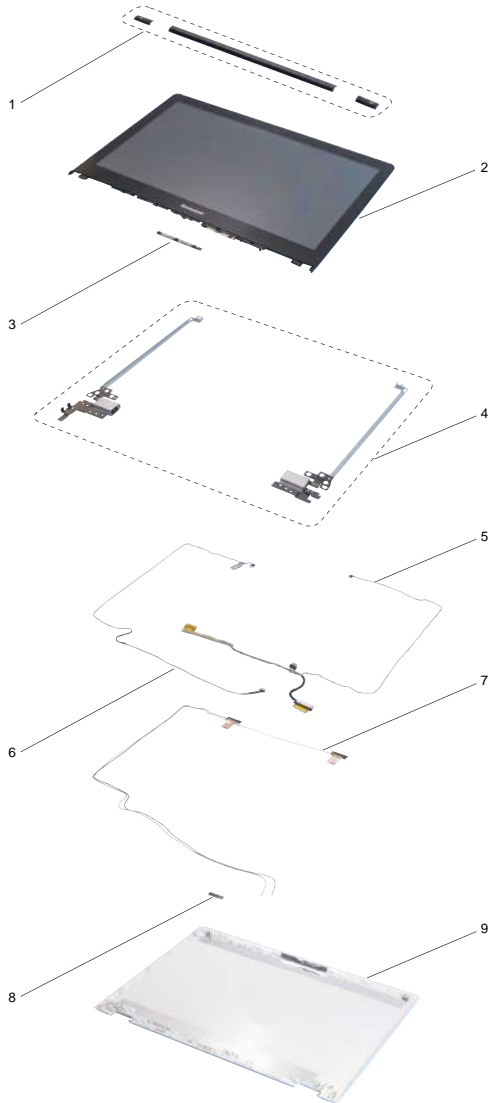

Table 6. Parts list—LCD FRUs

No.	FRU	FRU no.	CRU ID.	FLEX 3-1480	FLEX 3-1580
1	Bezel Cover W Flex3-1470 L/R/M	5B30H91254	N	•	
1	Bezel Cover W Flex3-1570 L/R/M	5B30J15974	N		•
2	LCD Module W 80R3 FHD W/BEZEL	5D10K42173	N	•	
2	LCD Module W 80R3 HD W/BEZEL	5D10K42171	N	•	
2	LCD Module W 80R4 FHD W/BEZEL	5D10K42174	N		•
2	LCD Module W 80R4 HD W/BEZEL	5D10K42175	N		•
3	Camera W Flex3-1435 HD 1.0M 2MIC	5C20J46195	N	•	•
3	Camera W Flex3-1435 VGA 0.3M 1MIC	5C20J46196	N	•	•
4	Hinge W Flex3-1470 W/Rubber	5H50H91217	N	•	
4	Hinge W Flex3-1570 W/Rubber	5H50H91180	N		•
5	LCD Cable W Flex3-1470	5C10H91193	N	•	
5	LCD Cable W Flex3-1570	5C10H91208	N		•
6	Sensor Board Cable W Flex3-1470	5C10H91225	N	•	
6	Sensor Board Cable W Flex3-1570	5C10H91266	N		•
7	Antenna W Flex3-1435	5A30J40283	N	•	
7	Antenna W Flex 3-1535 Main+Aux	5A30J91263	N		•
8	Sensor Board W Flex3-1470	5C50H91215	N	•	•
9	LCD Cover W Flex3-1470 Red	5CB0H91227	N	•	
9	LCD Cover W Flex3-1470 Black	5CB0H91260	N	•	
9	LCD Cover W Flex3-1470 White	5CB0H91137	N	•	
9	LCD Cover W Flex3-1570 BLK W/BKT	5CB0H91204	N		•
9	LCD Cover W Flex3-1570 WHT W/BKT	5CB0H91241	N		•

Miscellaneous parts

Table 7. Parts list—Miscellaneous parts

FRU	FRU no.	CRU ID.	FLEX 3-1480	FLEX 3-1580	
System miscellaneous parts:					
• (a) Memory EMI Shielding W 80R3	5M20K42172	N	•	•	
• (b) HDD Bracket W Flex3-1470	5B40H91170		•	•	
Cable miscellaneous parts:					
• (c) DC IN Cable W S41-70	5C10H71415		•		
• (c) DC-IN Cable W Flex3-1570	5C10H91237			•	
Note: Italicized letters in parentheses are references to the exploded view in "Overall" on page 78.					

AC adapters

Table 8. Parts list—3-pin AC adapters

FRU	FRU no.	CRU ID.	FLEX 3-1480	FLEX 3-1580
Adapter, Acbel ADLX45NAC3A 20V2.25A adap	5A10K02213	*	•	•
Adapter, Liteon ADLX45DLC3A 20V2.25A adap DOE	5A10H03910	*	•	•
Adapter, Chicony ADLX45NCC3A 20V2.25A adap DOE	5A10H03912	*	•	•
Adapter, Delta ADLX45NDC3A 20V2.25A adap DOE	5A10H03911	*	•	•
Adapter, Delta ADLX65NDC3A 20V3.25A BIS	5A10J46692	*	•	•
Adapter, Liteon ADLX65NLC3A 20V3.25A AD BIS	5A10J75114	*	•	•
Adapter, Chicony ADLX65NCC3A 20V3.25A AD BIS	5A10J75111	*	•	•
Adapter, Liteon ADLX65NLC3A 20V3.25A adap(CMN)	36200607	*	•	•
Adapter, Chicony ADLX65NCC3A 20V3.25A adap(CMN)	36200611	*	•	•
Adapter, Delta ADLX65NDC3A 20V3.25A adapter	36200249	*	•	•

Screws

Table 9. Parts list—screws

FRU	FRU no.	CRU ID.	FLEX 3-1480	FLEX 3-1580
Screw Pack W Flex3-1470	5S10H91178	N	•	
Screw Pack W Flex3-1570	5S10H91187	N		•

Power cords

A Lenovo power cord for a specific country or region is usually available only in that country or region:

Table 10. Parts list—3-pin power cords

Region	P/N	CRU ID.	FLEX 3-1480	FLEX 3-1580
UK 3pin • LINETEK LP-61L+ H03VV-F+ LS15 1m	145000593			
UK 3pin • Longwell LP-61L+H03VV-F+LS-18 1m	145000561			
UK 3pin • VOLEX MP5004+H03VV-F+VAC5S 1m	145000605			
UK 3pin • lux 0031+H03VV-F 0.75/3C+0011 1m	145500000			
Thailand 3pin • lux 0014+H03VV-F 0.75/3C+0011 1m	5L60J33143			
Europe 3pin • LINETEK LP-34+H03VV-F + LS15 1m	145000585			
Europe 3pin • Longwell LP-34A+H03VV-F+LS-18 1m	145000553			
Europe 3pin • VOLEX M2511+H03VV-F+VAC5S 1m	145000525			
Europe 3pin • lux 0033+H03VV-F 0.75/3C+0011 1m	145500001			
US 3pin • LINETEK LP-30B + SPT-2 + LS15 1m	145000594			
US 3pin • Longwell LP-30B+SPT-2 18AWG+LS-18 1m	145000562	*	•	•
US 3pin • Volex US15S3+SPT-2 + VAC5S 1m	145000537			
US 3pin • lux 0014+SPT-2 60°C 18/3C+0016 1m	145500002			
China 3pin • LINETEK PC323+RVV300/300+LS15 1m	145000600			
China 3pin • Longwell LSG-31+RVV300/300+LS-18 1m	145000568			
China 3pin • VOLEX GB10S3+RVV 300/500+VAC5S 1m	145000538			
China 3pin • lux 0036+RVV 300/300 0.75/3C+0002 1m	145500003			
India 3pin • LINETEK PE-361+ H05VV-F+ LS15 1m	145000592			
India 3pin • Longwell LP-67+BIS+LS-18 1m	145000560			
India 3pin • lux 0046+IS694 0.75/3C+0011 1m code	145500004			
Japan 3pin • LINETEK LS15+VCTF+LP-54 1m	145000587			

Table 10. Parts list—3-pin power cords (continued)

Region	P/N	CRU ID.	FLEX 3-1480	FLEX 3-1580
Japan 3pin • Longwell LP-54+VCTF+LS-18 1m	145000555			
Japan 3pin • VOLEX VAC5S+VCTF+M755 1m	145000530			
Japan 3pin • lux 0018(E)+VCTF 0.75/3C+0021 1m	145500005			
Australia 3pin • LINETEK LS15+H03VV-F+LP-23A 1m	145000589			
Australia 3pin • Longwell LP-23A+LFC-3R+LS-18 1m	145000557			
Australia 3pin • VOLEX AU10S3+H03VV-F+VAC5S 1m	145000532			
Australia 3pin • lux 0038+H03VV-F 0.75/3C+0011 1m	145500006			
Taiwan 3pin • LINETEK LS15+VCTF+LP-53 1m	145000588			
Taiwan 3pin • Longwell LP-71+VCTF+LS-33 1m	145000556			
Taiwan 3pin • VOLEX TW15CS3+VCTF+VAC5S 1m	145000531			
Taiwan 3pin • lux 0019+VCTF 0.75/3C+0021 1m	145500007			
Korea 3pin • LINETEK LS15+H05VV-F+LP-E04A 1m	145000590	*	•	•
Korea 3pin • Longwell LP-486+KTLH03VV-F+LS-5 1m	145000558			
Korea 3pin • VOLEX M2511+KETI IEC+VAC5S 1m	145000533			
Korea 3pin • lux 0033+H03VV-F 0.75/3C+0011 1m	145500008			
Italy 3pin • LINETEK LS15+H03VV-F+PE-336 1m	145000591			
Italy 3pin • Longwell LP-22+H03VV-F+LS-18 1m	145000559			
Italy 3pin • VOLEX IT10S3+H03VV-F+VAC5S 1m	145000535			
Italy 3pin • lux 0029+H03VV-F 0.75/3C+0011 1m	145500009			
South Africa 3pin • LINETEK LS15+H03VV-F+PE-364 1m	145000586			
South Africa 3pin • Longwell LP-39+H03VV-F+LS-18 1m	145000554			
South Africa 3pin • lux 0044+H03VV-F 0.75/3C+0011 1m	145500010			

Table 10. Parts list—3-pin power cords (continued)

Region	P/N	CRU ID.	FLEX 3-1480	FLEX 3-1580
Brazil 3pin • LINETEK LS15 H03VV-F LP26A 1m	145000596			
Brazil 3pin • Longwell LP-46+H03VV-F+LS-18 1m	145000564			
Brazil 3pin • VOLEX CH10S3+H03VV-F+VAC5S 1m	145000527			
Brazil 3pin • lux 0034+H03VV-F 0.75/3C+0011 1m	145500011			
Israel 3pin • LINETEK LS15+H03VV-F+LP-41 1m	145000595			
Israel 3pin • Longwell LP-41+H03VV-F+LS-18 1m	145000563			
Israel 3pin • VOLEX SI16S3+H03VV-F+VAC5S 1m	145000526			
Israel 3pin • lux 0041+H03VV-F 0.75/3C+0011 1m	145500012			
Switzerland 3pin • LINETEK LS15+H03VV-F+LP-37 1m	145000597			
Switzerland 3pin • Longwell LP-37+H03VV-F+LS-18 1m	145000565	*	•	•
Switzerland 3pin • VOLEX MP232+H03VV-F+VAC5S 1m	145000524			
Switzerland 3pin • lux 0027+H03VV-F 0.75/3C+0011 1m	145500013			
Denmark 3pin • LINETEK LS15+H03VV-F+LP-38 1m	145000598			
Denmark 3pin • Longwell LP-40+H03VV-F+LS-18 1m	145000566			
Denmark 3pin • VOLEX MP233D+H03VV-F+VAC5S 1m	145000534			
Denmark 3pin • lux 0048+H03VV-F 0.75/3C+0011 1m	145500014			
Argentina 3pin • LINETEK LS15+H03VV-F+LP39 1m	145000599			
Argentina 3pin • Longwell LP-24+H03VV-F+LS-18 1m	145000567			
Argentina 3pin • VOLEX VA2073+H03VV-F+VAC5S 1m	145000528			
Argentina 3pin • lux 0040+H03VV-F 0.75/3C+0011 1m	145500015			

Notices

Lenovo may not offer the products, services, or features discussed in this document in all countries. Consult your local Lenovo representative for information on the products and services currently available in your area. Any reference to a Lenovo product, program, or service is not intended to state or imply that only that Lenovo product, program, or service may be used. Any functionally equivalent product, program, or service that does not infringe any Lenovo intellectual property right may be used instead. However, it is the user's responsibility to evaluate and verify the operation of any other product, program, or service.

Lenovo may have patents or pending patent applications covering subject matter described in this document. The furnishing of this document does not give you any license to these patents.

LENOVO GROUP LTD. PROVIDES THIS PUBLICATION "AS IS" WITHOUT WARRANTY OF ANY KIND, EITHER EXPRESS OR IMPLIED, INCLUDING, BUT NOT LIMITED TO, THE IMPLIED WARRANTIES OF NON-INFRINGEMENT, MERCHANTABILITY OR FITNESS FOR A PARTICULAR PURPOSE. Some jurisdictions do not allow disclaimer of express or implied warranties in certain transactions, therefore, this statement may not apply to you.

This information could include technical inaccuracies or typographical errors. Changes are periodically made to the information herein; these changes will be incorporated in new editions of the publication. Lenovo may make improvements and/or changes in the product(s) and/or the program(s) described in this publication at any time without notice.

The products described in this document are not intended for use in implantation or other life support applications where malfunction may result in injury or death to persons. The information contained in this document does not affect or change Lenovo product specifications or warranties. Nothing in this document shall operate as an express or implied license or indemnity under the intellectual property rights of Lenovo or third parties. All information contained in this document was obtained in specific environments and is presented as an illustration. The result obtained in other operating environments may vary.

Lenovo may use or distribute any of the information you supply in any way it believes appropriate without incurring any obligation to you.

Any references in this publication to non-Lenovo Web sites are provided for convenience only and do not in any manner serve as an endorsement of those Web sites. The materials at those Web sites are not part of the materials for this Lenovo product, and use of those Web sites is at your own risk.

Any performance data contained herein was determined in a controlled environment. Therefore, the result obtained in other operating environments may vary significantly. Some measurements may have been made on development-level systems and there is no guarantee that these measurements will be the same on generally available systems. Furthermore, some measurements may have been estimated through extrapolation. Actual results may vary. Users of this document should verify the applicable data for their specific environment.

Trademarks

The following terms are trademarks or registered trademarks of Lenovo in the United States, other countries, or both.

Lenovo
OneKey

Microsoft and Windows are trademarks of Microsoft Corporation in the United States, other countries, or both.

Other company, products, or service names may be trademarks or service marks of others.