



TOSHIBA
Leading Innovation >>>

19BV500B

>REMEMBER

 IF YOU ARE EXPERIENCING ANY DIFFICULTIES PLEASE VISIT WWW.TOSHIBA.CO.UK/FAQ

 OR CONTACT THE TOSHIBA CUSTOMER HELPLINE ON 0844 856 0730



OWNER'S MANUAL

Contents

Safety Precautions	2	AVL	19
Air Circulation	2	Picture Mode.....	20
Heat Damage.....	2	Picture Adjustments	20
Mains Supply	2	Colour Temperature	20
Warning	2	Noise Reduction	20
Do	2	Film Mode	20
Do not	2	Game Mode	20
Installation and Important Information	3	Picture Zoom	20
Exclusion Clause	3	Resetting Picture Settings	20
Digital Switchover	4	Child Lock	22
Inserting Batteries and Effective Range of the Remote Control.....	5	Default Zoom	22
To Connect an HDMI Device	7	Blue Background	22
To Connect a DVI Device	7	Menu Background.....	22
To Connect a Computer	8	Menu Timeout.....	22
To Connect a USB Disk	8	HDMI PC Full Mode (optional).....	22
USB Memory Connection	8	Full Mode (optional).....	22
Switching on	9	Ext Out	22
Using the Remote Control	9	Programme Timers - Digital Only.....	23
Using the Controls and Connections on the TV..	9	Sleep Timer - Analogue	23
Auto Tuning.....	10	Conditional Access	23
Digital Manual Tuning	11	Manual Start	23
Analogue Manual Tuning	11	Auto Start.....	24
APS (Automatic Programming System).....	12	Playing MP3 Files	24
Sorting Programme Positions - Analogue.....	12	Viewing JPG Files.....	24
Stereo and Bilingual Transmissions.....	13	Slideshow Feature.....	25
Viewing Channel List	13	To Close the Media Player.....	25
Moving a Channel.....	13	Autoposition	26
Deleting a Channel	13	H Position	26
Renaming a Channel.....	14	V Position.....	26
Locking a Channel.....	14	Dot Clock	26
Viewing Info Banner.....	14	Phase.....	26
Electronic Programme Guide.....	14	Dot Clock	26
Programme Searching.....	15	PC Picture controls.....	26
Displaying Subtitles	15	Digital Text and Interactive Services.....	27
Language Settings	15	Using Digital Interactive Services	27
Preferred.....	15	Analogue Text Services (if available).....	27
Current	15	Using  Button	27
Viewing Parental Control Menu	16	Accessing Sub-Pages	27
Menu Lock	16	Revealing Concealed Text.....	27
Set PIN	16	Holding a Page	27
Viewing Configuration Menu.....	17	Enlarging the Text Display Size	27
Hard of Hearing (* for EU countries only)	17	Appendix A: PC Input Typical Display Modes.....	28
Controlling Favourite Mode.....	17	PIN Information	28
Channel List Mode.....	17	Appendix B: AV and HDMI Signal Compatibility (Input Signal Types).....	29
Scan Encrypted	17	Appendix C: Supported File Formats for USB Mode.....	30
Receiver Upgrade.....	17	Specifications and Accessories	31
Note on Analogue switch-off	17	License Information	32
Audio Description (optional).....	18		
Standby Search (*)	18		
Viewing Main Menu	18		
Selecting Programme Positions.....	18		
Input Selection	18		
Controlling Volume and Muting Sound	19		
Equalizer Settings.....	19		
Balance	19		
Headphone Volume	19		
Sound Mode	19		

Safety Precautions

This equipment has been designed and manufactured to meet international safety standards but, like any electrical equipment, care must be taken to obtain the best results and for safety to be assured. Please read the points below for your own safety. They are of a general nature, intended to help with all electronic consumer products and some points may not apply to the goods you have just purchased.

Air Circulation

Leave more than 10cm clearance around the television to allow adequate ventilation. This will prevent overheating and possible damage to the television. Dusty places should also be avoided.

Heat Damage

Damage may occur if the television is left in direct sunlight or near a heater. Avoid places subject to extremely high temperatures or humidity, or locations where the temperature is likely to fall below 5°C (41°F).

Mains Supply

The set should be operated only from a 220-240 V AC 50 Hz outlet. DO ensure that the television is not standing on the mains lead. DO NOT cut off the mains plug from this equipment, this incorporates a special Radio Interference Filter, the removal of which will impair its performance. In the UK, the fuse fitted in this plug is approved by ASTA or BSI to BS1362. It should only be replaced by a correctly rated and approved type and the fuse cover must be refitted. IF IN DOUBT PLEASE CONSULT A COMPETENT ELECTRICIAN.

Warning



To prevent the spread of fire, keep candles or other open flames away from this product at all times.

Do

DO read the operating instructions before you attempt to use the equipment.

DO ensure that all electrical connections (including the mains plug, extension leads and interconnections between pieces of equipment) are properly made and in accordance with the manufacturers' instructions. Switch off and withdraw the mains plug before making or changing connections.

DO consult your dealer if you are ever in doubt about the installation, operation or safety of your equipment.

DO be careful with glass panels or doors on equipment.

Do not

DON'T remove any fixed cover as this may expose dangerous voltages.

DON'T obstruct the ventilation openings of the equipment with items such as newspapers, tablecloths, curtains, etc. Overheating will cause damage and shorten the life of the equipment.

DON'T allow electrical equipment to be exposed to dripping or splashing or objects filled with liquids, such as vases, to be placed on the equipment.

DON'T place hot objects or naked flame sources, such as lighted candles or nightlights on, or close to equipment. High temperatures can melt plastic and lead to fires.

DON'T use makeshift stands and NEVER fix legs with wood screws. To ensure complete safety, always fit the manufacturers' approved stand, bracket or legs with the fixings provided according to the instructions.

DON'T leave equipment switched on when it is unattended, unless it is specifically stated that it is designed for unattended operation or has a standby mode. Switch off by withdrawing the plug, make sure your family know how to do this. Special arrangements may need to be made for people with disabilities.

DON'T continue to operate the equipment if you are in any doubt about it working normally, or it is damaged in any way - switch off, withdraw the mains plug and consult your dealer.

WARNING - excessive sound pressure from earphones or headphones can cause hearing loss.

ABOVE ALL - NEVER let anyone, especially children, push or hit the screen, push anything into holes, slots or any other openings in the case.

NEVER guess or take chances with electrical equipment of any kind - it is better to be safe than sorry.

THE MAINS PLUG IS USED AS A DISCONNECTING DEVICE AND THEREFORE SHOULD BE READILY OPERABLE.

Installation and Important Information

Where to install

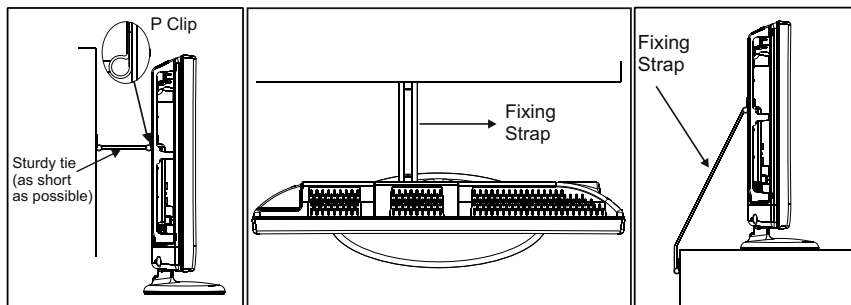

"P" Clip position on TV is dependent on model

* Button and stand style is dependent on model.

Locate the television away from direct sunlight and strong lights. Soft, indirect lighting is recommended for comfortable viewing. Use curtains or blinds to prevent direct sunlight falling on the screen.

Place the TV on a stable, level surface that can support the weight of the TV. In order to maintain stability and prevent it falling over, secure the TV to a wall using a sturdy tie to the clip on the back of the TV.

The LCD display panels are manufactured using an extremely high level of precision technology; however, sometimes some

parts of the screen may be missing picture elements or have luminous spots. This is not a sign of a malfunction.

Make sure the television is located in a position where it cannot be pushed or hit by objects, as pressure will break or damage the screen. Also, please be certain that small items cannot be inserted into slots or openings in the case.

Cleaning the screen and cabinet...

Turn off the power, and clean the screen and cabinet with a soft, dry cloth. We recommend that you do not use any proprietary polishes or solvents on the screen or cabinet as this may cause damage.

Please take note

The digital reception function of this television is only effective in the countries listed in the "Country" section of the "SETUP" menu. Depending on country/area, some of this television's functions may not be available. Reception of future additional or modified services can not be guaranteed with this television.

If stationary images generated by 4:3 broadcasts, text services, channel identification logos, computer displays, video games, on screen menus, etc. are left on the television screen for any length of time, they could become conspicuous. It is always advisable to reduce both the brightness and contrast settings.

Very long, continuous use of the 4:3 picture on a 16:9 screen may result in some retention of the image at the 4:3 outlines. This is not a defect of the LCD TV and is not covered under the manufacturer's warranty. Regular use of other size modes will prevent permanent retention.

Exclusion Clause

Toshiba shall under no circumstances be liable for loss and/or damage to the product caused by:

- i) fire;
- ii) earthquake;
- iii) accidental damage;
- iv) intentional misuse of the product;
- v) use of the product in improper conditions;
- vi) loss and/or damage caused to the product whilst in the possession of a third party;
- vii) any damage or loss caused as a result of the owner's failure and/or neglect to follow the instructions set out in the owner's manual;
- viii) any loss or damage caused directly as a result of misuse or malfunction of the product when used simultaneously with associated equipment;

Furthermore, under no circumstances shall Toshiba be liable for any consequential loss and/or damage including but not limited to the following, loss of profit, interruption of business, the loss of recorded data whether caused during normal operation or misuse of the product.

Note: A Toshiba wall bracket or stand, where available, must be used.

English - 3 -

The Remote Control

Simple at-a-glance reference of your remote control.

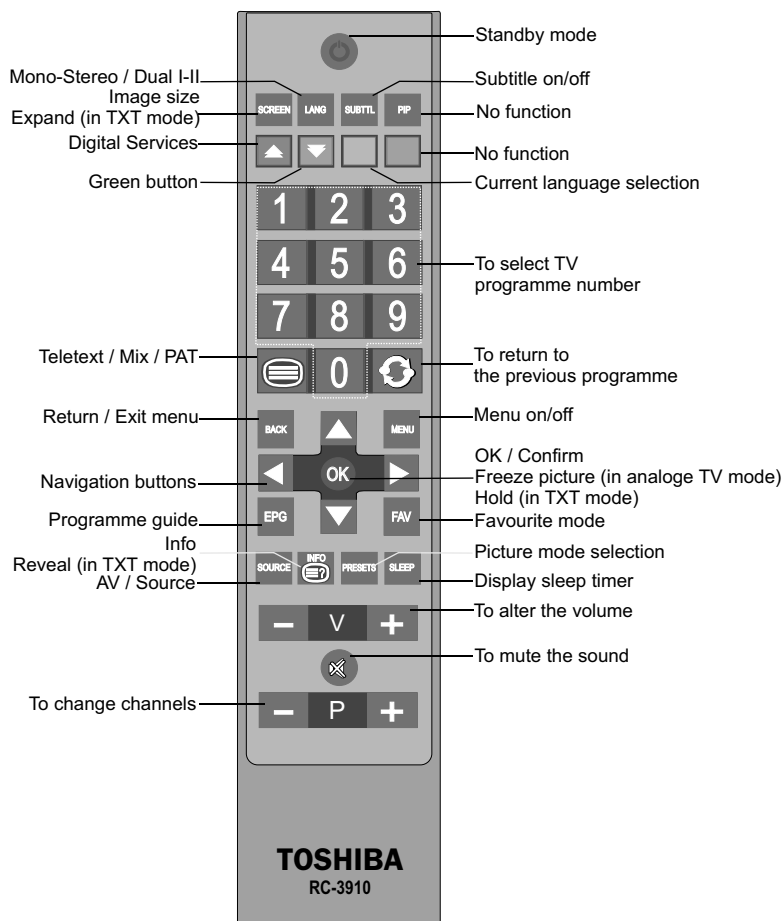

Inserting Batteries and Effective Range of the Remote Control

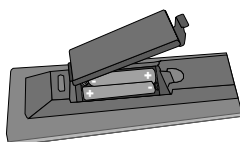

Remove the back cover to reveal the battery compartment and make sure the batteries are inserted the right way round. Suitable battery types for this remote are AAA, IEC R03 1.5V.

Do not combine a used, old battery with a new one or mix battery types. Remove dead batteries immediately to prevent acid from leaking into the battery compartment. Dispose of them in a designated disposal area.

Warning: Batteries must not be exposed to excessive heat such as sunshine, fire or the like.

The performance of the remote control will deteriorate beyond a distance of five metres or outside an angle of 30 degrees from the centre of the television. If the operating range becomes reduced the batteries may need replacing.

Connecting External Equipment

Before connecting any external equipment, turn off the On/Off switch and remove the mains plug from the wall socket.

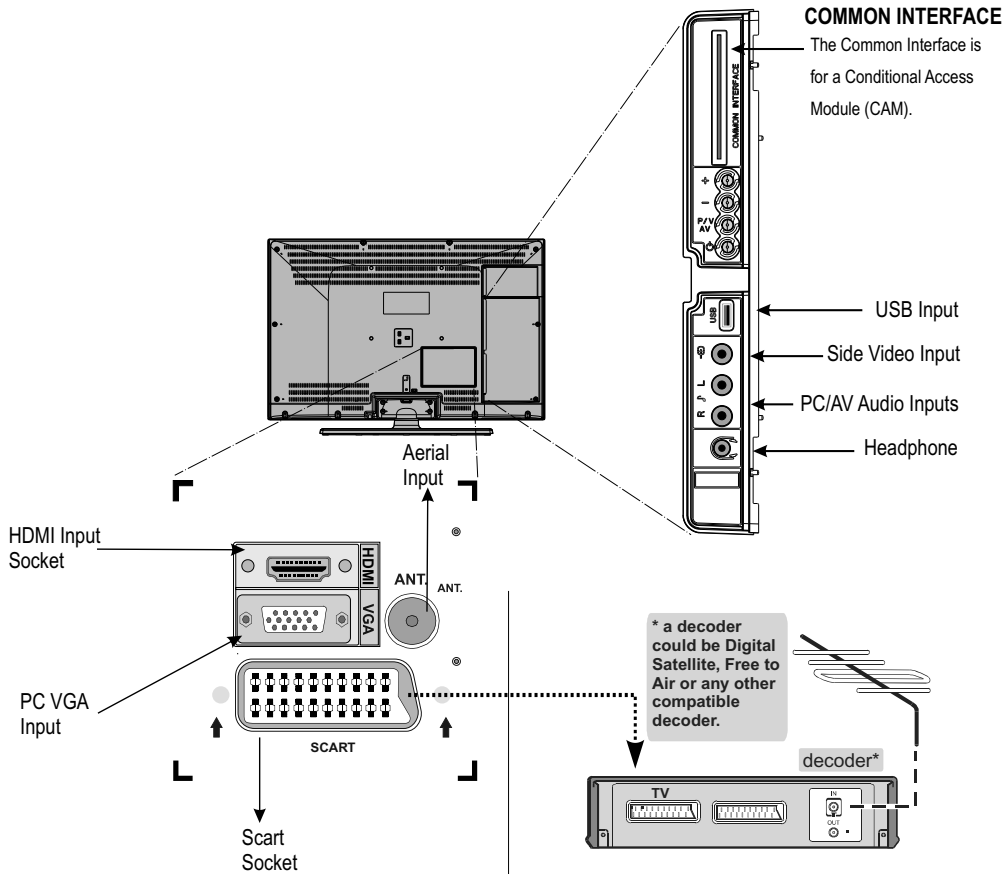

Aerial cable.....
Connect the aerial to the socket on the rear of the television.

SCART lead.....
If you use a **decoder*** or a **media recorder**, it is essential that the scart cable is connected to the television.

Before running **first time installation**, any connected devices to **standby mode**.

The phono sockets located on the side of the TV will accept **L** and **R** audio signals.

HDMI® (High-Definition Multimedia Interface) is for using with a DVD decoder or other equipment with digital audio and video output. It is designed for best performance with 1080i and 1080p high-definition video signals but will also accept and display VGA, 480i, 480p, 576i, 576p and 720p signals. PC format signals will also be displayed.

NOTE: Although this television is able to connect to **HDMI** equipment, it is possible that some equipment may not operate correctly.

A wide variety of external equipment can be connected to the television; therefore, the relevant owner's manuals for all additional equipment must be referred to for exact instructions.

If the television automatically switches over to monitor external equipment, return to normal television by pressing the desired programme position button. To recall external equipment, press **SOURCE** button to switch between sources.

You can also connect **YPbPr** equipment to your TV but this connection can only be enabled by using **YPbPr** to **PC** cable (Cable is not supplied). To enable sound connection, use **AUDIO IN** located side of the TV.

.When the connection is made, switch to **YPbPr** source. See, **Input selection** section.

Connecting an HDMI® or DVI Device to the HDMI Input

The HDMI input on your television receives digital audio and uncompressed digital video from an HDMI source device or uncompressed digital video from a DVI (Digital Visual Interface) source device.

This input is designed to accept HDCP (High-Bandwidth Digital-Content Protection) programme material in digital form from EIA/CEA-861-D-compliant [1] consumer electronic devices (such as a set-top box or DVD player with HDMI or DVI output).

NOTE:

- Some early HDMI equipment may not work properly with your latest HDMI TV.
- Supported Audio format: Linear PCM, sampling rate 32/44.1/48kHz.

To Connect an HDMI Device

Connect an HDMI cable (type A connector) to the HDMI terminal. For proper operation, it is recommended that you use an HDMI cable with the HDMI Logo (HDMI).

- If your HDMI connection is capable of 1080p and/or your television is capable of refresh rates greater than 50Hz, you will need a Category 2 cable. Conventional HDMI/DVI cable may not work properly with this mode.
- HDMI cable transfers both video and audio. Separate analogue audio cables are not required (see illustration).
- To view the HDMI device video, press the **SOURCE** button to select HDMI.

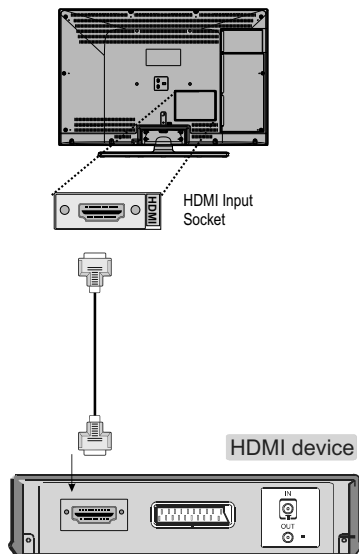

To Connect a DVI Device

Connect an HDMI-to-DVI adaptor cable (HDMI type A connector) to the HDMI terminal and audio cables to the PC/Side AV/YpBPr sockets (see illustration).

- The recommended HDMI-to-DVI adaptor cable length is 6.6 ft (2m).
- An HDMI-to-DVI adaptor cable transfers video only. Separate analogue audio cables are required.

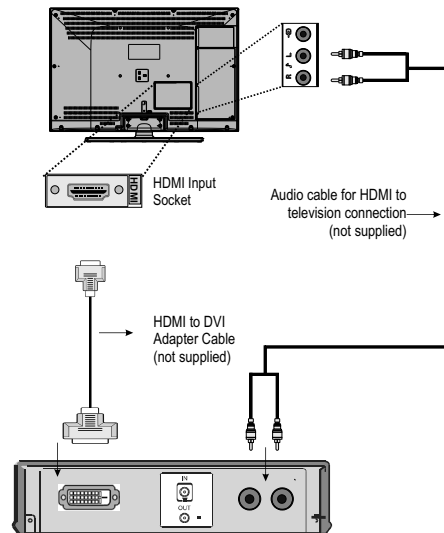

NOTE:

To ensure that the HDMI or DVI device is reset properly, it is recommended that you follow these procedures:

- When turning on your electronic components, turn on the television first, and then the HDMI or DVI device.
- When turning off your electronic components, turn off the HDMI or DVI device first, and then the television.

Connecting a Computer

To Connect a Computer

With either an RGB/PC or an HDMI connection, you can watch your computer's display on the television and hear the sound from the television's speakers.

When connecting a PC to the RGB/PC terminal on the television, use an analogue RGB (15-pin) computer cable and a PC audio cable for the AUDIO socket.

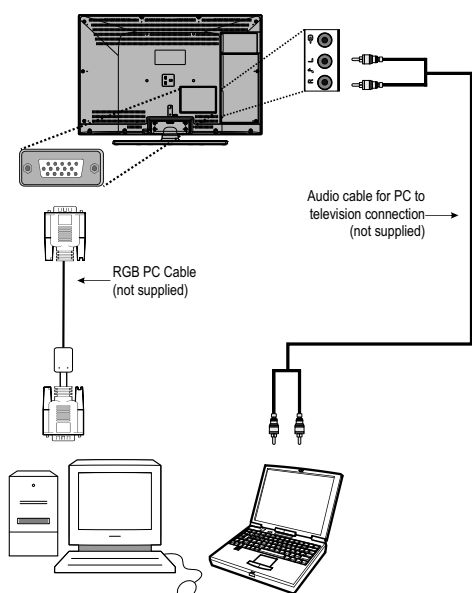

To use a PC, set the monitor output resolution on the PC before connecting it to the television. To display the optimum picture, use the PC setting feature.

NOTE:

- The PC audio input terminal on the television is shared with the YPbPr and Side AV input terminal.
- Some PC models cannot be connected to this television. An adaptor is not needed for computers with a compatible mini D-sub15-pin terminal.
- Depending on the DVD's title and the specifications of the PC on which you are playing the DVD-Video, some scenes may be skipped or you may not be able to pause during multiangle scenes.

Connecting a USB Disk

To Connect a USB Disk

- You can connect a USB disk to your TV by using the USB input of the TV. This feature allows you to display/play music or photo files stored in a USB stick.
- It is possible that certain types of USB devices (e.g. MP3 Players) may not be compatible with this TV.
- You may back up your files before making any connections to the TV set in order to avoid any possible data loss. Note that manufacturer will not be responsible for any file damage or data loss.
- The TV supports only FAT32 disk formatting. NTFS format is not supported. If you connect a USB disk with NTFS format, "usb is unformatted" osd will be displayed.
- Do not pull out USB module while playing a file.

CAUTION: Quickly plugging and unplugging USB devices, is a very hazardous operation. Especially, do not repeatedly quickly plug and unplug the drive. This may cause physical damage to the USB player and especially the USB device itself.

USB Memory Connection

- Plug your USB device to the USB input of the TV.
- IMPORTANT:** The TV supports only FAT32 disk formatting. NTFS format is not supported.

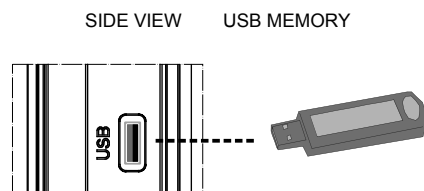

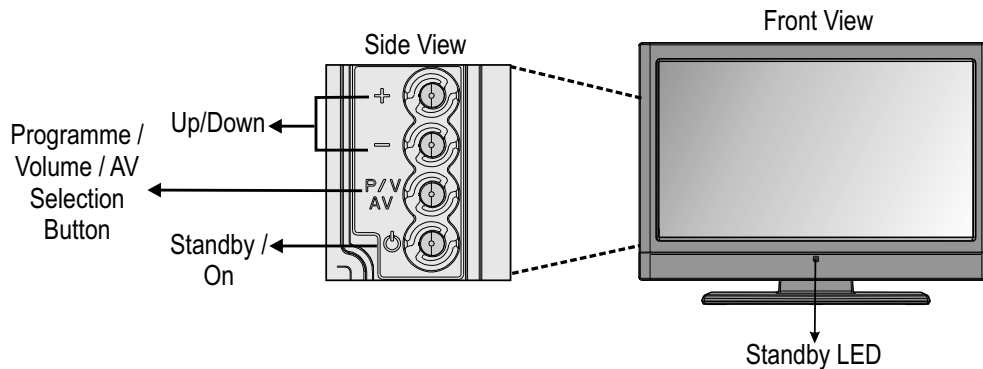

Controlling the TV

A wide variety of external equipment can be connected via the sockets located on the side of the television. *Whilst all the necessary adjustments and controls for the television are made using the remote control, the buttons on the right side of the television may be used for some functions.*



Switching on

If the standby LED is unlit, check that the mains plug is connected to the power and then the LED lights up white. Press the  button on the right side of the television to switch the television on.

To put the television into Standby, press  on the remote control. To view the television, press  again. The picture may take a few seconds to appear.

Note:

The active Standby LED may appear for a few moments when the TV is switched off.

A beeping sound will be heard when the buttons are pressed. This is normal operation, not a fault.

For energy saving:

Turning the television off at its mains supply, or un-plugging it, will cut energy use to nearly zero for all televisions. This is recommended when the television is not being used for a long time, e.g. when on holiday.

Reducing the brightness of the screen will reduce energy use. Energy efficiency cuts energy consumption and thus saves money by reducing electricity bills.

NOTE: Putting the television into standby mode, will reduce energy consumption, but will still draw some power.

Please always refer to the owner's manual of the equipment to be connected for full details.

NOTE: The USB socket has limited functionality, and Toshiba can take no responsibility for damage to other connected equipment.

Using the Remote Control

Press the **MENU** button on the remote control to see the menus.

In **analogue TV** mode the menu appears as a group of icons each for a menu option. Press the Left or Right button to select a topic.

In **digital TV** mode the menu appears as a list. Press the Up or Down button to select a topic.

To use the options press the Up and Down buttons on the remote control to move up and down through them and **OK**, Left or Right buttons to select the required choice. Follow the on screen instructions. The functions of each menu are described in detail throughout the manual.

Using the Controls and Connections on the TV

- Press "+/-" buttons to increase or decrease volume, so a volume level scale (slider) will be displayed on the screen.
- Main menu OSD cannot be displayed via control buttons. "+/-" buttons will function as volume up/down as default. Even if you set other functions for these buttons, "+/-" buttons will perform as default after a short while.
- Press **P/V/AV** button once and then use "+/-" buttons to select the next or previous programme.
- Hold the **"P/V/AV"** button, source OSD will be displayed.
- Use "+/-" buttons to select the desired source.

Initial Installation - Digital & Analogue

Before switching on the television put your decoder and media recorder to **Standby** if they are connected and ensure the aerial is connected to your television. To set up the television use the buttons on the remote control as detailed on **page 4**.

1. Connect the mains plug and switch the TV into standby using the side On/Off switch. Press any numbered or standby button on the remote control, then the language selection menu will be displayed. This screen will appear the first time that the television is switched on and each time the television is reset.
2. By pressing the Up or Down buttons highlight the language you want to set and press OK button. Afterwards, the following message will be displayed on the screen:

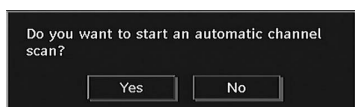

3. Select Yes by using Left or Right buttons and press **OK** to continue. The Auto tuning screen will appear and the television will start to search for available stations. The progress bar will move along the line. You must allow the television to complete the search.
4. After Automatic Search is completed, the following message asking for analogue channel search appears on the screen. Select Yes by using Left or Right buttons and press **OK** to continue.

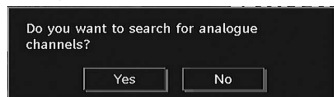

5. Select your Country, Language and Text language by using navigation buttons. Press **OK** or **RED** button to continue. To cancel, press the **BLUE** button.

Note:

- For proper functioning of digital teletext in DTV mode, you should set country as UK in analogue AUTO Programme (for UK broadcasts only).
- Do not turn off the TV while initializing first time installation.

Auto Tuning

As new services are broadcast, it will be necessary to re-tune the television in order to view them.

Auto Tuning will completely re-tune the television and can be used to update the channel list. It is recommended that Auto Tuning is run periodically to ensure that all new services are added. All current channels and settings, i.e. locked channels, will be lost.

- Select the **SETUP** from the main menu by using **Up** or **Down** buttons. Press **OK** and Setup menu will be displayed.



- Select the **Installation** from the Setup menu by using **Up** or **Down** buttons. Press **OK** and Installation menu will be displayed.

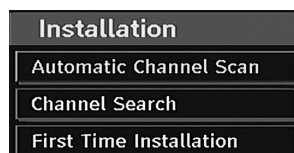

- Select **Automatic Channel Scan** from the Installation menu by using **Up** or **Down** buttons and press **OK**. A screen will appear warning that previous digital programmes and settings will be deleted. Select **Yes** and press **OK** to continue with the **Auto tuning**.



- The television will start to search for all available stations. You must allow the television to complete the search. When the search is complete the **Auto tuning** screen will display the total number of services found.
- After search is completed for digital channels, a message asking whether to search for analogue channels appears on the screen:

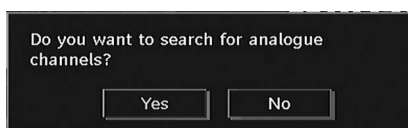

- Press the **OK** button to search for analogue channels. The following menu appears on the screen for analogue channel search:

Auto Tuning continued, Manual Tuning

The television can be tuned-in manually using Manual Tuning feature.



- Select your **Country**, **Language** and **Text language** by using the navigation buttons. Press **OK** or **RED** button to continue. To cancel, press **BLUE** button. The following menu will be displayed during the automatic tuning:

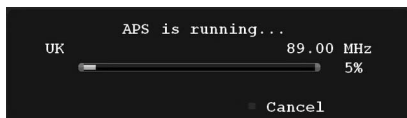

- After APS is finalized, the programme table will appear on the screen. In the programme table you will see the programme numbers and names assigned to the programmes.

Digital Manual Tuning

The feature is available for service engineers or can be used for direct channel entry if the multiplex channel is known.

- Select **Channel Search** from the **Installation** menu and press **OK**.

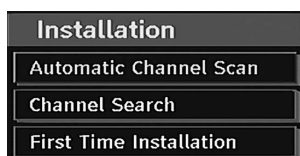

- Enter the multiplex number using the numeric buttons. The television will automatically search for that multiplex. When the multiplex is found any channels not currently on the programme list will be added and the programme information at the top of the screen will be updated.
- Repeat as necessary.

Note: Press **SOURCE** button to switch between TV/DTV.

Analogue Manual Tuning

The television can be tuned-in manually. For example: if the television cannot be connected to a media recorder/decoder with a SCART lead or to tune-in a station on another System.

To allocate a programme position on the television for a decoder and media recorder: turn the decoder on, insert a pre-recorded film into the media recorder and press **PLAY**, then manually tune.

- Press **MENU** and using the Left or Right button select **Install** menu.



- Using the **Down** button select **Program** and key in the programme position to be tuned with the number buttons, we suggest *Programme 0* for a media recorder.
- Use the **Down** button to select **Search** then press the Left or Right button to search. The television will begin searching for channels.
- Each signal will show on the television, if it is not your media recorder press the **Left** or **Right** button to restart the search.
- When your media recorder signal is found, save the selection by pressing the **Down** button until **Store** is highlighted, then press the **Left/Right** or **OK** button to save.
- Repeat for each *programme position* to be tuned then press **BACK** to finish.

Note: Press **SOURCE** button to select between TV or DTV.

Analogue APS and Programme Sorting

Before switching on the television put your decoder and media recorder to **Standby** if they are connected and ensure the aerial is connected to your television.

APS (Automatic Programming System)

When the APS feature is selected all channels and settings will be lost, the television will return to factory settings and then re-tune.

- Press **MENU** and using the Left or Right button select **Program Table** tab.



- The **Program** screen will appear on the screen. Press the **BLUE** button to start **APS**.



- Press the **Left** or **Right** button to set the country.
- Press the **BLUE** button to cancel **APS** or the **RED** or **OK** button to start.

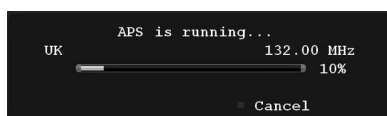

You must allow the television to complete the search.

- When the search is complete the television will automatically select programme position 1. This may not be a clear picture or the signal may be weak, so the station order can be changed using **program table** which will appear on the screen.
- Press **BACK** to finish.

Sorting Programme Positions - Analogue

- Channels may be moved and saved to the position of your choice.
- Select Programme Table tab from the main analogue TV menu.
- With the list of channels showing, use navigation buttons to highlight the channel you want to move and press **GREEN** button. The selected channel will be highlighted with a frame.
- Use navigation buttons move through the list to your preferred position. As you do so, the other channels will move to make room.
- When finished, press **GREEN** button to save your move.

Stereo and Bilingual Transmissions and Channel List

Stereo and Bilingual Transmissions

For ATV programmes

If stereo or dual language broadcasts are transmitted, the word Stereo or Dual will appear on the screen each time positions are changed, disappearing after a few seconds. If the broadcast is not in stereo, the word Mono will appear.

Stereo... Press **LANG.** to select Stereo or Mono.

Bilingual... Bilingual transmissions are rare. If they are transmitted, the word Dual will be displayed. Choose the required programme number, and if the word Dual appears, press **LANG.** to select Dual 1, Dual 2 or Mono.

For DTV Programmes

To view current language and for changing to an alternative language (if available), press **LANG.** button. Available options will be listed.

Viewing Channel List

The channel order may be changed to suit your personal preference.

- Select **Channel List** from the main DTV menu and press **OK**.



- Press Up or Down button for selecting a channel. You can press **RED** or **GREEN** button to move page up or page down.
- To watch a specific channel, highlight it by using Up or Down buttons. Afterwards highlight **Select** tab by using Left or Right buttons. Press **OK** button.

Moving a Channel

- Highlight the desired channel by using Up or Down buttons.
- Select Move option in the channel list and press **OK** button.
- Edit Number screen will be displayed. Enter the desired channel number by using the numeric buttons on the remote control. If there is a previously stored channel on that number, a warning screen will be displayed. Select Yes if you want to move the channel and press **OK**.

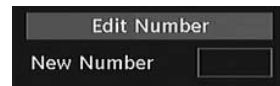

- Press **OK** button to process. Selected channel is now moved.

Deleting a Channel

- Select the channel that you want to delete and select **Delete** option. Press **OK** button to continue.

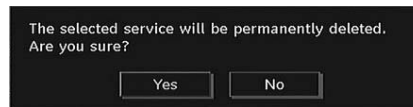

- A warning screen will appear. Select **Yes** to delete, select No to cancel. Press **OK** button to continue.

Renaming a Channel and Viewing Info Banner and Programme Locking

Renaming a Channel

- Select the channel that you want to rename and select Edit Name option. Press **OK** button to continue.

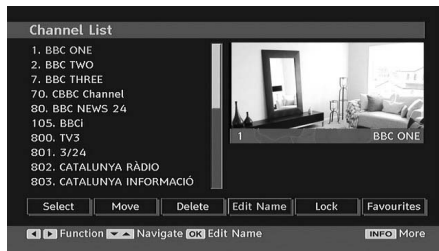

- Pressing **Left** or **Right** button moves to the previous/next character. Pressing **Up** or **Down** button changes the current character. Pressing the numeric buttons '0...9' replaces the highlighted character with the characters printed above the button one by one as the button is pressed.
- When finished, press **OK** button to save. Press **MENU** to cancel.

Locking a Channel

You can press **GREEN** button to tag/untag all channels; **YELLOW** button to tag/untag a single channel.

- Select the channel that you want to lock by using Up or Down buttons.
- Select **Lock** option by using Left or Right buttons. Press **OK** button to continue.
- You will be asked to enter parental control PIN. Enter the PIN number.

Note: Default PIN is set to 0000.

- Press **OK** button when the desired channel is highlighted to lock/unlock the channel. Lock symbol will be displayed next to the selected channel.

Viewing Info Banner

- Press **INFO** button the information screen will appear giving details of the channel and programme currently being viewed.



- Whenever you change channel, the TV displays the broadcast picture along with an information banner at the bottom of the screen (available only in DTV mode). This will remain on the screen for a few seconds.
- If the selected channel is locked, you must enter the correct four numeric code to view the channel. "Enter PIN" will be displayed on the screen in such a case:

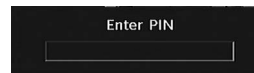

- Enter the PIN number to continue.

Electronic Programme Guide

- Select the on-screen guide by pressing **EPG**, the guide screen will appear highlighting details of the channel and programme currently being viewed. This may take a few moments to appear.



- For information on a highlighted programme, press **INFO** button.
- For details of other programmes currently available, press **RED** or **GREEN** to scroll up and down the list. As channels are selected, details of the programme currently being broadcast will appear.
- To set the timer for a selected programme, press the **OK** button to select Timers menu.
- Press **YELLOW** or **BLUE** for advancing to next or previous day.
- Press **SWAP** (SWAP) button to jump to the current broadcast.

Programme Searching, Displaying Subtitles and Language Settings

Programme Searching

From the guide screen, you can use search feature.

- Press "0" button on the remote control to view **Guide Search** menu. Using this feature, you can search the programme guide database in accordance with the genre selected or with name match.

Displaying Subtitles

In digital mode, this feature will show subtitles on the screen in the selected language provided they are being broadcast.

- Press **SUBTTL** button to activate available subtitles.
- Press **SUBTTL** button again to turn off subtitles.

Note:

- If subtitles are on and a language option is set, pressing the  button causes the following warning message (** for UK only):



Language Settings

Using this menu you can adjust the preferred language settings.

- Select Language from Setup menu and press **OK** to view this menu. Press the **BACK** button on the remote control to exit.

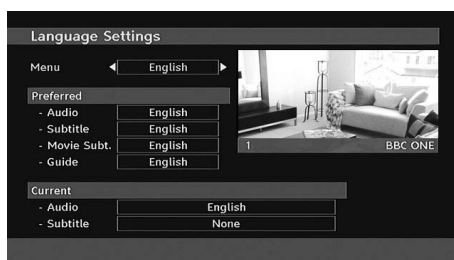

Preferred

These settings will be used if available. Otherwise the current settings will be used.

Audio: by pressing **Left** or **Right** keys change the audio language.

Subtitle: alter the subtitle language with **Left** or **Right** keys. The chosen language will be seen in subtitles.

Movie Subtitle: In order to display subtitles properly, use this setting to select a movie subtitle language. By pressing **Left** or **Right** button, select the desired language option.

Guide: By pressing **Left** or **Right** buttons change the guide language.

Current

Audio: if audio language is supported change the audio language by pressing **Left** or **Right** buttons

Subtitle: if subtitle is backed up, alter the subtitle language with **Left** or **Right** buttons. The chosen language will be seen in subtitles.

Digital Settings - Parental Control, Menu Lock, Set PIN

You can view or set parental preferences of your TV.

Viewing Parental Control Menu

- While in DTV mode, press **MENU** to view main menu. Select Setup from the list and press **OK** button.

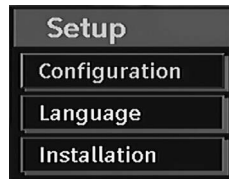

- Select **Configuration** by using **Up** or **Down** button and press **OK**.
- Select **Parental Control** by using **Up** or **Down** button and press **OK**.
- A dialogue box asking for the lock key will be displayed. The default key is set to **0000**. Enter the PIN.
- If it is incorrect, "**Wrong Pin**" OSD will be displayed. If it is correct, the Parental Control menu will be displayed:



Menu Lock

In menu lock you can set locking for all menus, or the Installation Menu to restrict access to these menus. If the menu lock is disabled, there will be free access to the menu system.

- Use **Up** or **Down** buttons to go to Menu Lock option. Use **Left** or **Right** buttons to choose Menu Lock Mode.

DISABLED : All menus are unlocked.

ALL MENUS : All Menus are accessible only with the correct lock key. So the user cannot add, delete, rename, channels, cannot set timers.

INSTALLATION MENU: Installation menu is locked. So the user can't add channels. Changes will be updated after exiting 'Configuration Menu'.

Set PIN

- Use **Up** or **Down** buttons to select **Set PIN** option. Press **OK** to display the **Set PIN** window.
- Use numeric buttons to enter new pin number. You will need to input your new pin a second time for verification purposes.
- After typing correct PIN numbers, PIN number will be changed.

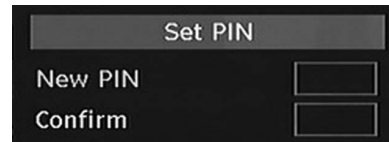

Note: The factory default pin number is 0000, if you change the pin number make sure you write it down and keep it safe.

Digital Settings - Configuration

You can configure DTV settings of your TV by using digital Configuration menu.

Viewing Configuration Menu

You can configure the settings of your TV. Select Configuration from Setup menu and press **OK** to view this menu. Press the **BACK** button on the remote control to exit.



Hard of Hearing (* for EU countries only)

If the broadcaster enables any special signal concerning the audio, you can set this setting as On to receive such signals.

- Use **Up** or **Down** button to select **Hard of Hearing** and then press **Left** or **Right** button to set this setting as On or Off.

Controlling Favourite Mode

Use this function to enable or disable favourite mode.

- Press **Left** or **Right** button to set this function as on or off.

Channel List Mode

You can set a viewing type for channel list using this setting.

- In the **CONFIGURATION** menu, use **Up** or **Down** buttons to select Channel List option.
- Press **Left** or **Right** button to set this function to TV Only, Radio Only, Text Only or Show All.

Scan Encrypted

When this setting is on, search process will locate the encrypted channels as well. If it is set as OFF manually, encrypted channels will not be located while in automatic search or manual search. Scan Encrypted Channel feature will always be ON after performing first time installation.

- In the **CONFIGURATION** menu, use **Up** or **Down** buttons to select **Scan Encrypted**.
- Press **Left** or **Right** button to set this function as On or Off.

Receiver Upgrade

This feature helps to keep your TV updated. It works automatically and searches for new information when available. Note that this setting is inactive to be modified.

- Please ensure that the TV is set to standby mode. The TV automatically goes to active standby mode at 3.00 A.M. each day and searches for any new information which may be broadcasted and will download this to your receiver automatically. This operation will normally take approximately 30 minutes.

Note: Your TV may start in First Time Installation mode after software update.

Note on Analogue switch-off

This is a digital television which is integrated to allow the use of both digital and analogue services. However, during the lifetime of this set it is very likely that analogue services will be switched off to allow for more new digital services.

This 'switch-off' will happen in a number of phases, which will be advertised in your area well in advance. It is recommended that at each phase the television is re-tuned to ensure that existing and new digital services can be viewed without disruption.

Digital Settings Configuration continued

Audio Description (optional)

Audio description refers to an additional narration track for blind and visually impaired viewers of visual media, including television and movies. The description narrator talks through the presentation, describing what is happening on the screen during the natural pauses in the audio (and sometimes during dialogue, if deemed necessary). You can use this feature, only if the broadcaster supports that additional narration track.

- In the configuration menu, highlight **Audio Description** by pressing **Up** or **Down** buttons and press **OK**.
- Use **Up** or **Down** buttons to select an item. Then use **Left** or **Right** buttons to set.



Audio Description: This function enables or disables the audio description feature.

Preferred Language: You can define a preferred language by using this setting. This setting can be used only when it is available.

Relative Volume: Using this option, the Audio Description volume level can be increased or decreased relatively, according to the general volume.

Standby Search (*)

(*) This setting is visible only when the Country option is set to Denmark, Sweden, Norway or Finland.

If the Standby Search is set to On, when the TV is in standby mode, the TV will look for any changes in the saved channels.

- Use **Up** or **Down** button to select **Standby Search** and then press **Left** or **Right** button to set this setting as On or Off.
- If you change Standby Search to Off, this function will be unavailable. To use Standby search please make sure that you select Standby Search as On.

General Controls

Some of the main controls of your TV are as the following.

Viewing Main Menu

- Press “**←**”/“**→**”/“**+**” buttons on the TV at the same time to view main menu.
- Press **MENU** button on the remote control to view main menu.

Selecting Programme Positions

To select a programme position use the numbered buttons on the remote control. Programme positions can also be selected using **P+** and **P-**.

Press **INFO** to display the on-screen information i.e. programme position, stereo/mono signal and picture format. To revert to the previous programme position press **SWAP**.

Input Selection

Use the Input Selection window if the television does not switch over to a connected source automatically.

- Press **SOURCE** button on your remote control for directly changing sources. Or select **Source** option from the main menu by using **Left** or **Right** button. Use then **Up** or **Down** button to highlight an input and press **Right** button to select.

Note: You can mark desired source options by pressing the **OK** button. Therefore, when **SOURCE** button is pressed, only the marked source options will be available (except for the TV source).



Analogue Sound Controls

You can set sound preferences of your TV.

Controlling Volume and Muting Sound

Volume

Press **V+** or **V-** to adjust the volume.

Sound Mute

Press **MUTE** once to turn the sound off and again to cancel.

Equalizer Settings

You can customize current sound mode settings. Select the appropriate mode in accordance with the installation location of the TV and adjust the equalizer on-screen as desired.

- Select the **SOUND** menu.
- Press **Up** or **Down** to highlight **Equalizer**, and then press **OK**.

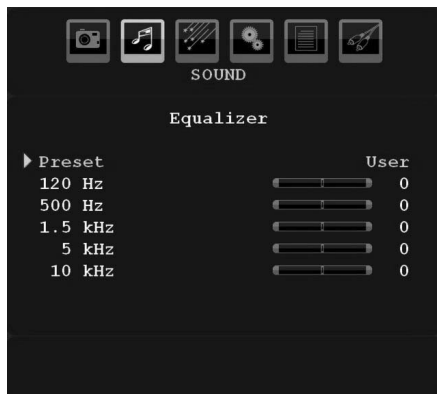

- Press **Left** or **Right** button to change the preset. In equalizer menu, the preset can be changed to **Music**, **Movie**, **Speech**, **Flat**, **Classic** and **User**.
- Select the desired frequency by pressing **Up** or **Down** button and increase or decrease the frequency gain by pressing **Left** or **Right** button.
- Press the **MENU** button to return to the previous menu.

Note: Equalizer menu settings can be changed only when the **Equalizer Mode** is in **User**.

Balance

This setting is used for emphasizing left or right speaker balance.

- Press **Up** or **Down** button to select **Balance**.
- Press **Left** or **Right** button to change the level of the balance. Balance level can be adjusted between **-32** and **+ 32**.

Headphone Volume

This setting is used to set the sound output when headphones are connected.

- Press **Up** or **Down** button to select **Headphone**. Press **Right** button to view the headphone menu.
- Press **Up** or **Down** button to select **Volume**. Press **Right** button to increase headphone volume level. Press **Left** button to decrease headphone volume level. Headphone volume level can be adjusted between 0 and 63.

Sound Mode

This setting is used to select the sound mode of your television.

- Press **Up** or **Down** button to select **Sound Mode**.
- Using **Left** or **Right** button, you can select Mono, Stereo, Dual I or Dual II mode, only if the selected channel supports that mode.

AVL

Sometimes there can be large changes in volume when switching from a DTV 5.1ch to a DTV 2ch, an ATV channel, or an external input. Using the AVL feature reduces these volume differences.

- In the **SOUND** menu, press **Up** or **Down** to highlight AVL.
- Press **Left** or **Right** button to set AVL as on or off.

Picture Controls

Most of the picture controls and functions are available in both digital and analogue modes.

Picture Mode

This television offers the choice of personalising the picture style. **Cinema**, **Dynamic** and **Natural** are preset options and affect settings within the television.

- In the **PICTURE** menu, press **Up** or **Down** to select **Mode**.
- Press **Left** or **Right** to select the picture mode you prefer.

Picture Adjustments

You can customize current picture mode settings as desired. For example you change items such as, **Brightness**, **Contrast**, **Colour**, **Sharpness** and **Hue**.

- In the **PICTURE** menu, press **Up** or **Down** button to select the desired option.



- Press **Left** or **Right** button to set the level.

Note: **Hue** option can only be visible when the TV receives an NTSC signal.

Colour Temperature

Colour Temperature increases the 'warmth' or 'coolness' of the picture by increasing the red or blue tint.

- In the **PICTURE** menu, press **Up** or **Down** to select Colour Temp.
- Press **Left** or **Right** to choose from one of these options: Cool, Normal and Warm.

Note:

- Setting **Cool** option gives white colours a slight blue stress.
- Setting **Warm** option gives white colours a slight red stress.
- For normal colours, select **Normal** option.

Noise Reduction

Sometimes some words or picture elements to become distorted or pixelated. Using the Noise Reduction feature reduces this effect by smoothing out the edges.

- In the **PICTURE** menu, press **Up** or **Down** to select Noise Reduction.

- Press **Left** or **Right** to set Noise Reduction as **Low**, **Medium**, **High** or **Off**.

Film Mode

Films are recorded at a different number of frames per second to normal television programmes. Turn this feature on when you are watching films to see the fast motion scenes clearly.

- In the **PICTURE** menu, press **Up** or **Down** to select Film Mode.
- Press **Left** or **Right** button to set this feature as On or Off.

Game Mode

When Game Mode is set to On, specific game mode settings, which are optimized for better video quality, will be loaded.

- In the **PICTURE** menu, press **Up** or **Down** to select Game Mode.
- Press **Left** or **Right** button to set this feature as On or Off.

Note:

- Picture mode selection button on the remote control will have no function while Game Mode is on.
- Picture Mode, Contrast, Brightness, Sharpness, Colour and Colour Temp settings will be invisible and disabled while Game Mode is on.

Picture Zoom

- In the **PICTURE** menu, press **Up** or **Down** to select Picture Zoom.
- Press **Left** or **Right** button to set this feature to **Auto**, **16:9**, **4:3**, **Panoramic**, **14:9**, **Cinema**, **Subtitle** or **Zoom**.

Resetting Picture Settings

This feature allows you to reset the current Picture Settings to the default values.

- Press **Up** or **Down** to select Reset and press **OK**.

Changing Picture Format

Depending on the type of broadcast being transmitted, programmes can be viewed in a number of formats. Press the **SCREEN** button repeatedly to select between **Auto**, **16:9**, **4:3**, **Subtitle**, **14:9**, **14:9 Zoom**, **Panaromic** or **Cinema**. When **Auto** is selected the format being displayed is determined by the picture being broadcast.

16:9

Use this setting when watching a widescreen DVD, widescreen video tape or a 16:9 broadcast (when available). Due to the range of widescreen formats (16:9, 14:9, 20:9 etc.) black bars may be visible on the top and bottom of the screen.

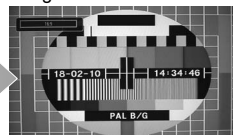

4:3

Use this setting to view a true 4:3 broadcast.

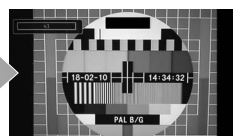

SUBTITLE

When subtitles are included on a letterbox format broadcast, this setting will raise the picture to ensure that all the text is displayed.

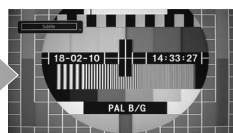

14:9

This zooms up the wide picture (14:9 aspect ratio) to the upper and lower limits of the screen

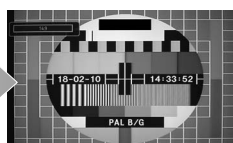

14:9 ZOOM

This option zooms to the 14:9 picture.

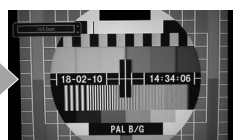

PANORAMIC

This stretches the left and right sides of a normal picture (4:3 aspect ratio) to fill the screen, without making the picture appear unnatural. The top and bottom of the picture are slightly cut off.

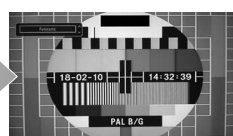

CINEMA

This zooms up the wide picture (16:9 aspect ratio) to the full screen.

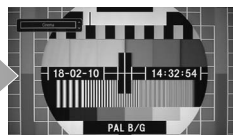

Other Controls

Your television has a list of other controls that function in accordance with your preferences.

Child Lock

Panel Lock disables the buttons on the television. All buttons on the remote control can still be used.

- In the **FEATURE** menu, select Child Lock and choose On or Off using **Left** or **Right** button.
- When **Child Lock** is On, a reminder will appear when the buttons on the television are pressed. If the standby button is pressed, the television will switch off and can only be brought out of standby by using the remote control.

Default Zoom

While zoom mode is set as AUTO, the TV will set the zoom mode in accordance with the signal of the broadcast. If there is no WSS or aspect ratio information, the TV will then use this setting.

- In the **FEATURE** menu, select **Default Zoom** and choose **Panoramic, 16:9, 4:3** or **14:9** using **Left** or **Right** button.

Blue Background

If the signal is weak or absent, the TV will automatically change to a blue screen. To enable this, set Blue Background to On.

- In the **FEATURE** menu, select **Blue Background** and choose On or Off using **Left** or **Right** button.

Menu Background

You can set the menu transparency by using this feature.

Press **Up** or **Down** button to select **Menu Background**. You can set menu background level by pressing **Left** or **Right** button.

- In the **FEATURE** menu, select **Menu Background**.
- Use **Left** or **Right** button to set the transparency level.

Menu Timeout

To set a specific display timeout for menu screens, set a value for this option.

In the **FEATURE** menu, select **Menu Timeout** and choose **5 sec, 30 sec** or **60 sec** using **Left** or **Right** button.

HDMI PC Full Mode (optional)

If you want to view PC screen in HDMI mode by using external connection, HDMI PC FULL MODE option should be On to adjust the screen ratio correctly. This item might be inactive in some resolutions.

Note: *If you connect an HDMI device and switch the TV to HDMI mode, this feature will be visible (except for 1080i/1080P resolution).*

Full Mode (optional)

If you connect a device via HDMI or YPbPr connectors and set 1080i/1080P resolutions, Full Mode item will be visible.

- You can set Full Mode as 1:1 or Normal by using **Left** or **Right** button.
- If you select 1:1, screen ratio will be adjusted correctly. If you set Normal, screen ratio may expand.

Ext Out

To turn on or off external output via scart socket, use this feature.

- Press **Up** or **Down** button to select Ext Out. Use **Left** or **Right** button to set the Ext Out as On or Off.

Note:

For copying from a DVD or VCR device, you should choose desired source from source menu and turn "On" to EXT Out from feature menu.

Ext Out should be On in order to use Timers function in the DTV mode.

Timers - Digital and Analogue, Conditional Access

Programme Timers - Digital Only

This feature will set the television to go to a specific channel at a certain time. It can be used to view a particular programme, or by setting the mode to daily or weekly, can be used to view a series of programmes.

- Press **MENU** and **Up** or **Down** to select Timers item menu and press **OK** to continue.

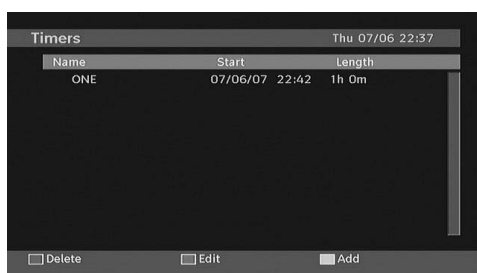

- To add a timer, press the **YELLOW** button on the remote control. Then **Add Timer** window appears.

Channel: **Left** or **Right** keys will navigate the user through the TV or Radio list.

Date: Starting date is entered via the **Left/Right** or the numeric buttons.

Start: Starting time is entered via the **Left/Right** or the numeric buttons.

End: Ending time is entered via the **Left/Right** or the numeric buttons.

Change/Delete: permits or prohibits any modifications for other users.

Duration: Duration between Start and End time.

Repeat: You can set a timer to be repeated as Once, Daily or Weekly.

- You can save the adjustments by pressing the **GREEN** key or cancel the process by pressing the **RED** button.
- You can edit the list via **GREEN** key and delete with the **RED** button.

Sleep Timer - Analogue

The television can be set to turn itself Off after a certain length of time.

- When displaying analogue TV menu, use **Left** or **Right** button to select **FEATURE** menu.
- Press **Up** or **Down** button to select Sleep Timer.
- Use **Left** or **Right** button to set the desired time.

The timer can be programmed between **Off** and **120** minutes in steps of **10** minutes.

If **Sleep Timer** is activated, at the end of the selected time, the TV goes automatically to standby mode

Conditional Access

The Common Interface Slot, situated on the side of the television, enables the insertion of a CAM (Conditional Access Module) and card. These are purchased from a service provider and allow additional subscription broadcasts to be viewed. For more information, see a service provider.

- Insert the CAM and card into the Common Interface Slot, following the instructions provided with the CAM.
- Press the **MENU** button to display the main menu and use the "▼" or "▲" button to highlight the **Conditional Access** line and press the **OK** button:

Conditional Access

Important:

- Switch off the TV and unplug from the mains.
- The CAM should be correctly inserted, it is impossible to insert fully if reversed. The CAM or the TV terminal may be damaged if the CAM is forcefully inserted.
- Connect the TV to the mains supply, switch on and then wait for few moments until the card is activated.
- Some CAMs may require the following set up. Please set the CAM by entering the IDTV menu, Conditional Access then pressing the **"OK"** button. (CAM set up menu is not displayed when it is not required.)
- To see the viewing contract information: enter IDTV; press the **"MENU"** button, then highlight Conditional Access and press the **"OK"** button.
- When no module is inserted, "No Conditional Access module detected" message appears on the screen.
- Refer to the module instruction manual for details of the settings.

Note: Insert or remove the CI module only when the TV is switched off or in standby mode.

Manual Start

- To display Media Browser window, you can press **MENU** button on the remote control and then select **Media Browser** by pressing **Up** or **Down** button.
- Press **OK** button to continue. Media Browser menu contents (depending on the contents of your USB drive) will be displayed.

USB Media Browser

This TV allows you to enjoy photo or music files stored on a USB device.

Auto Start

- When you plug a USB device, the following screen will be displayed:

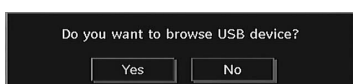

- Select **YES** by pressing **Left** or **Right** button and press **OK** button. Media browser will be displayed.



- You can play music, picture and video files from a USB memory stick.

Note:

If you plug USB stick while in analogue mode, the TV will automatically switch to digital TV mode.

Some USB compliant devices may not be supported.

If the USB stick is not recognized after power off/on or First Time Installation, first, plug the USB device out and power off/on the TV set. Plug the USB device in again.

Playing MP3 Files

To play mp3 files from a USB disk, you can use this menu screen.



- Use **Up** or **Down** button to highlight a file.
- Press **OK** to play the selected file.
- Press **GREEN** button to play all media files in the folder starting with the selected one.
- Press **YELLOW** button to pause a playing file.
- Use **RED** button to stop playback.
- Use **Left** or **Right** button to jump to the previous or next file to play.
- Press **INFO** button to play files randomly. If shuffle mode is enabled, previous/next function will also jump to the tracks randomly.
- Use **BLUE** button to play the selected file repeatedly.

Viewing JPG Files

To view photo files from a USB disk, you can use this menu screen.



- Use **Up** or **Down** button to highlight a file.
- Use numeric (**1...9**) buttons to jump to the selected file.
- Press **OK** button to view the selected picture in full screen.
- Press **GREEN** button to start the slideshow with all pictures in the folder.



USB Media Browser, continued

Slideshow feature.

Slideshow Feature

You can use this feature to display photos on your TV.



- Press **YELLOW** button to pause a playing file.
- Press **GREEN** button to continue with the slideshow.
- Press **Left** or **Right** button to jump to previous or next file of slideshow.
- Use **Up** or **Down** button to rotate the picture using up/down buttons.
- Press **BACK** to exit.
- Press **RED** button to play in random and continuous mode and  icon turns the highlighted icon.
- If during the slideshow when the shuffle mode is enabled, next photo will be chosen randomly.
- If the loop function is not enabled, the slideshow will stop at the end. If the loop function is enabled, after the slideshow ends, it will start again and again.
- Press **BLUE** button to activate Loop function. In Loop mode, Slideshow goes on continuously and  icon turns the highlighted icon.
- Press **INFO** button to activate the operations bar.

To Close the Media Player

- Press **MENU** button on the remote control.

PC Mode

PC Picture Position and PC Picture menus are described below. The other menu items are identical to TV mode menus. Please see the previous sections.

Autoposition

If you shift the picture horizontally or vertically to an unwanted position, use this item to put the picture into correct place automatically.

- Select the **PC POSITION** option from the main menu. **PC Position** menu appears on the screen:

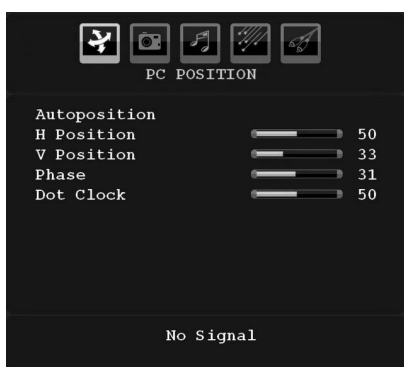

- Press the **Down** button to highlight **Autoposition** and then press the **OK** button.

H Position

H (Horizontal) Position shifts the image horizontally to right hand side or left hand side of the screen.

- In the **PC POSITION** menu press the **Down** button until **H Position** is highlighted.
- Press the **Left** or **Right** button to adjust the value.

V Position

V (Vertical) Position shifts the image vertically towards the top or bottom of the screen.

In the **PC POSITION** menu press the **Down** button until **V Position** is highlighted.

Press the **Left** or **Right** button to adjust the value.

Dot Clock

Dot Clock adjustment corrects interference that appear as vertical banding in dot intensive presentations like spreadsheets or paragraphs or text in smaller fonts.

- In the **PC POSITION** menu press the **Down** button until **Dot Clock** is highlighted.
- Press the **Left** or **Right** button to adjust the value.

Phase

Depending on the resolution and scan frequency that you input to the TV Set, you may see a hazy or noisy picture on the screen. In such a case you can use this item to get a clear picture by trial and error method.

- In the **PC POSITION** menu press the **Down** button until **Phase** is highlighted.
- Press the **Left** or **Right** button to adjust the value.

Dot Clock

Dot Clock adjustments correct the interference that appear as vertical banding in dot intensive presentations like spreadsheets or paragraphs or text in smaller fonts.

- In the **PC POSITION** menu press the **Down** button until **Dot Clock** is highlighted.

Press the **Left** or **Right** button to adjust the value.

PC Picture controls

Contrast, Brightness and Colour Temperature adjustments in this menu are identical to adjustments defined in TV picture menu.

When Colour Temp is Manual, you can also adjust the R, G, B items. R, G and B adjust the TV image colour in PC RGB mode. You can change the TV colour to your desired colour: R (Red), G (Green), B (Blue)

Select Reset and press **OK** button to reset the adjustments to factory default settings.

Note:

*For switching to PC source, press **SOURCE** button on your remote control and select PC input. You can also use **Source** menu to switch to PC mode.*

Note that PC mode menu settings are available only while the TV is in PC source.

Digital and Analogue (if available) Text Services

This television has a multi-page text memory, which takes a few moments to load.



Digital Text and Interactive Services

The digital text and interactive services are the up-to-date way of viewing service information, using computer-style formats, incorporating pictures and interactive views.

They offer high quality on-screen images with multi-colour photographic still images, advanced text and graphics and are user-friendly. These services are free to anyone with a digital television, however; they are not available for all digital stations and are dependant on the broadcaster.

Simply using the navigation and coloured buttons on the remote control, navigating pages and pulling-down menus are quick and easy.

Using Digital Interactive Services

- Most channels that offer interactive services will show a prompt, for example, "PRESS RED".
- To access digital interactive services press the  or RED button. It may take a few seconds to load.
- Using Up or Down button, highlight the required subject and press **OK**.
- Use the coloured buttons as instructed.
- To return to normal viewing press .

Analogue Text Services (if available)





Before using the text services the required language region must be chosen.

- Select **TEXT Language** from the **FEATURE** menu.
- Press the Left or Right button to choose the required language region.



- After the teletext language is selected, press **MENU** button to exit.

Using Button

- To view text services press . Press  again to superimpose text over a normal broadcast picture. Pressing this button again will split the screen into two windows, one displaying the teletext and the other displaying the current channel (PAT).
- Press  again to return to normal viewing.
- Programmes cannot be changed until text is cancelled.
- The first text page shown will be the initial page.
- Any text page can be accessed by entering the 3 digit page number using the numbered buttons, pressing the coloured buttons or pressing  to advance to the next page and to go back to the previous page.
- Four coloured titles will appear at the base of the screen. To access one of the four given subjects, press the relevant coloured button on the remote control.
- For further information on your particular text system(s), see the broadcast text index page or, consult your local Toshiba dealer.

Below is a guide to the functions of the remote control text buttons.

Accessing Sub-Pages

If a text page has sub-pages, press  and enter the sub-page numbers 01,02,03 etc. which can be selected using Left/ Right buttons at the bottom of the text page under the coloured links.

Revealing Concealed Text

To discover the solutions on quiz and joke pages press the **INFO** button.

Holding a Page

At times it is convenient to hold a page of text. Press **OK** and hold symbol will appear in the top left of the screen. The page will be held on screen until the button is pressed again.

Enlarging the Text Display Size

Press **SCREEN** once to enlarge the top half of the page, press again to enlarge the bottom half of the page. Press again to revert to normal size.

Note: Analogue text is not available in certain areas due to Digital switchover.

Appendix A: PC Input Typical Display Modes

The display has a maximum resolution of 1600 X 1200. The following table is an illustration of some of the typical video display modes.

Your TV may not support different resolutions. Supported resolution modes are listed below.

If you switch your PC to an unsupported mode, a warning OSD will appear on the screen.

Index	Resolution		Frequency		Standard	Supported Zoom Modes
	Hor	Ver	Ver (Hz)	Hor (KHz)		
1	640	480	60	31.5	VESA	16:9, 4:3
2	640	480	72	37.9	VESA	16:9, 4:3
3	640	480	75	37.5	VESA	16:9, 4:3
4	800	600	56	35.2	VESA	16:9, 4:3
5	800	600	60	37.9	VESA	16:9, 4:3
6	800	600	70	43.8		16:9, 4:3
7	800	600	72	48.1	VESA	16:9, 4:3
8	800	600	75	46.9	VESA	16:9, 4:3
9	832	624	75	49.7	MAC	16:9, 4:3
10	1024	768	60	48.4	VESA	16:9, 4:3
11	1024	768	70	56.5	VESA	16:9, 4:3
12	1024	768	72	57.7		16:9, 4:3
13	1024	768	75	60.0		16:9, 4:3
14	1152	864	70	64.2	VESA	16:9, 4:3
15	1152	864	75	67.5	VESA	16:9, 4:3
16	1152	870	75	68.9	MAC	16:9, 4:3
17	1280	768	60	47.7	VESA	16:9, 4:3
18	1360	768	60	47.7		16:9, 4:3
19	1280	960	60	60.0	VESA	16:9, 4:3
20	1280	1024	60	64.0	VESA	16:9
21	1280	1024	75	80.0	VESA	16:9
22	1600	1200	60	75.0	VESA	16:9

PIN Information

Before connecting any external equipment, turn off all main power switches. If there is no switch, remove the mains plug from the wall socket. Signal information for Mini D-sub 15 pin connector

Pin No.	Signal name	Pin No.	Signal name	Pin No.	Signal name
1	R	6	Ground	11	NC
2	G	7	Ground	12	NC
3	B	8	Ground	13	H-sync
4	NC*	9	NC	14	V-sync
5	NC	10	Ground	15	NC

* NC = not connected

Appendix B: AV and HDMI Signal Compatibility (Input Signal Types)

Source	Supported Signals		Available
EXT-1 (SCART)	PAL 50/60		O
	NTSC 60		O
	RGB 50		O
	RGB 60		O
FAV	PAL 50/60		O
	NTSC 60		O
YPbPr	480I	60Hz	O
	480P	60Hz	O
	576I	50Hz	O
	576P	50Hz	O
	720P	50Hz	O
	720P	60Hz	O
	1080I	50Hz	O
	1080I	60Hz	O
	1080P	50Hz	O
	1080P	60Hz	O
HDMI	480I	60Hz	O
	480P	60Hz	O
	576I	50Hz	O
	576P	50Hz	O
	720P	50Hz	O
	720P	60Hz	O
	1080I	50Hz	O
	1080I	60Hz	O
	1080P	24Hz	O
	1080P	25Hz	O
	1080P	30HZ	O
	1080P	50HZ	O
	1080P	60HZ	O

(X: Not Available, O: Available)

Note: In some cases a signal on the LCD TV may not be displayed properly. The problem may be an inconsistency with standards from the source equipment (DVD, Set-top box, etc.). If you do experience such a problem please contact your dealer and also the manufacturer of the source equipment.

Appendix C: Supported File Formats for USB Mode

Media	File Extension	Format		Remarks
		Video	Audio	(Maximum resolution/Bit rate etc.)
Music	.mp3	-	MPEG 1/2 Layer 1/2/3 (MP3)	Sample Rate: 8K ~ 48KHz, Bit Rate: 64K~320Kbps
Photo	.jpg	Baseline JPEG		WxH = 8902x8902 up to 77Mega-pixel Support format: 444/ 440/ 422/ 420/ Grayscale
		Progressive JPEG		Up to 4 Mega-pixel Support format: 444/ 440/ 422/ 420/ Grayscale

Specifications and Accessories

DVB-T Broadcast Systems/Channels

UK UHF 21-58

Broadcast Systems/Channels

PAL-I UK21-UK69

Video Input

PAL, SECAM, NTSC 4.43

Stereo

Nicam

Visible Screen Size (approx.)

19" 47cm

Display

16:9

Sound Output (at 10% distortion)

Main 2.5 + 2.5

Power Consumption (approx.)

19" 45W

Standby Power Consumption (approx.)

0.9W

External Connections

SCART

Input

21-pin SCART

RGB, A/V

YPbPr

Input

Mini D-Sub 16-Pin Analogue

via YPbPr to PC cable (optional).

FAV

Input (Side)

Phono Jack

Video

Phono Jacks

Audio L + R

HDMI 1

Input

HDMI® (Enable Content Type, INSTAPORT™, RGB Range supported)

PC

Input

Mini D-Sub 16-Pin Analogue

RGB Signal

USB Port

Media Browser Interface Version: USB 2.0

USB Class: Mass Storage

File System: FAT32

Headphone Socket

3.5 mm stereo

Dimensions (approx.)

34 cm (H) 46 cm (W) 63 cm (D)

(Height dimension includes foot stand)

Weight (approx.)

4.5 kg (without stand) 4.20 kg

Operating Conditions

Temperature 5°C - 35°C (41°F - 94°F)

Humidity 20 - 80% (non-condensing)

Supplied Accessories

Remote Control

2 batteries (AAA, IEC r03 1.5V)

P Clip

License Information

HDMI, the HDMI logo, and High-Definition Multimedia Interface are trademarks or registered trademarks of HDMI Licensing, LLC.

DVB is a registered trademark of the DVB Project.

[1] EIA/CEA-861-D compliance covers the transmission of uncompressed digital video with high-bandwidth digital content protection, which is being standardized for reception of high-definition video signals. Because this is an evolving technology, it is possible that some devices may not operate properly with the television.

Cleaning the screen and cabinet...

Turn off the power, clean the screen and cabinet with a soft, dry cloth. We recommend that you do not use any proprietary polishes or solvents on the screen or cabinet as this may cause damage.

Disposal...

The following information is only for EU-member states:

Disposal of products

The crossed out wheeled dust bin symbol indicates that products must be collected and disposed of separately from household waste. Integrated batteries and accumulators can be disposed of with the product. They will be separated at the recycling centres.

The black bar indicates that the product was placed on the market after August 13, 2005.

By participating in separate collection of products and batteries, you will help to assure the proper disposal of products and batteries and thus help to prevent potential negative consequences for the environment and human health.

For more detailed information about the collection and recycling programmes available in your country, please contact your local city office or the shop where you purchased the product.

Disposal of batteries and/or accumulators

The crossed out wheeled dust bin symbol indicates that batteries and/or accumulators must be collected and disposed of separately from household waste.

If the battery or accumulator contains more than the specified values of lead (Pb), mercury (Hg), and/or cadmium (Cd) defined in the Battery Directive (2006/66/EC), then the chemical symbols for lead (Pb), mercury (Hg) and/or cadmium (Cd) will appear below the crossed out wheeled dust bin symbol.

By participating in separate collection of batteries, you will help to assure the proper disposal of products and batteries and thus help to prevent potential negative consequences for the environment and human health. For more detailed information about the collection and recycling programmes available in your country, please contact your local city office or the shop where you purchased the product.



Questions and Answers

Below are the answers to some of the most common queries. For more information, go to www.toshiba.co.uk

Q *Why is there no sound or picture?*

A Check the television is not in standby mode.
Check the mains plug and all mains connections.

Q *Why is there a picture but no sound?*

A Check the volume has not been turned down or that sound mute has not been selected.

Q *What can cause a poor picture?*

A Interference or a weak signal. Try a different television station.

Q *Why doesn't the video/DVD being played show on screen?*

A Make sure the media recorder or DVD player is connected to the television as illustrated in the beginning chapters, and then select the correct input by pressing **SOURCE**.

Q *Why is the VCR/DVD picture in black and white?*

A Check that the correct EXT 1 input setting has been chosen or AV.

Q *Why is there a good video picture but no sound?*

A Check all lead connections.
No sound or unacceptable format sound may be received. Check the volume has not been turned down or that sound mute has not been selected.

Q *Why doesn't the remote control work?*

A Check the batteries aren't dead or inserted incorrectly.

Q *Why don't the controls on the top of the television work?*

A Check that **CHILD LOCK** is not selected.

Q *Why is the sound only coming from one speaker when stereo sound is selected?*

A Check that the balance in the **SOUND** menu hasn't been set to one side.

Q *Why are there problems with analogue text service?*

A Good performance of the analogue text depends on a good strong broadcast signal. This normally requires a roof or loft aerial. If the text is unreadable or garbled, check the aerial. Go to the *main index* page of the analogue text service and look for the *User Guide*.

Q *What is DVB-T?*

A Digital Video Broadcast via an aerial/antenna.

Q *How are radio channels selected?*

A You can select them via the Channel List.

Q *What can be done if the PIN number has been forgotten?*

A You can reset TV and perform first time installation. Ensure that no-one else can use this by removing the Owner's Manual.

Q *Why are there horizontal stripes and/or blurred images on the screen when in PC mode?*

A The Phase may need adjustment. Select PC Settings and highlight Phase and adjust until the picture clears.

Q *Why doesn't the remote control work?*

A Check the batteries aren't dead or inserted incorrectly.

Q *Why doesn't the remote control work?*

A Check the batteries aren't dead or inserted incorrectly.

Q *Why doesn't the Media Browser feature operate?*

A Make sure that USB is connected correctly. Incorrect behavior may occur with a USB Hub connection.

Q *Why only certain digital channels be viewed?*

A Favourite mode is set to On.

Q *Why are some encrypted digital channels unavailable?*

A Your subscription needs upgrading. Contact your service provider.

Q *Why does the active standby LED sometimes take longer to go out?*

A When put into standby the television's active standby will automatically search all available channels for downloads, provided Automatic Download is enabled. The time it takes to do this may vary.

Q *Why is the DTV main menu unavailable?*

A Analogue mode (TV) is selected. Switch to DTV mode.

Q *Why are there horizontal stripes and/or blurred images on the screen when in PC mode?*

A The Phase may need adjustment. Select PC Settings and highlight Phase and adjust until the picture clears.

Q *Why are there horizontal stripes and/or blurred images on the screen when in PC mode?*

A The Phase may need adjustment. Select PC Settings and highlight Phase and adjust until the picture clears.

Q *Why when digital subtitles have been selected are they not showing on screen?*

A Subtitles are not currently being transmitted by the broadcaster.

Q *Why is the soundtrack in English when a different audio language has been selected?*

A The programme is currently being broadcast with an English soundtrack only.

Q *Why is there no digital text service?*

A The digital programme being viewed is not broadcasting digital text. Try another digital programme.

Q *Why is the digital channel locked?*

A The channel has been selected in the locked programmes list.

© **TOSHIBA Television Central Europe Sp. z o.o.**

All rights reserved.

Reproduction in whole or part without written permission is strictly prohibited.

TOSHIBA Television Central Europe Sp. z o.o.

ul. Pokoju 1, Biskupice Podgórne, 55-040 Kobierzyce, Poland
Specification is subject to change without notice.