

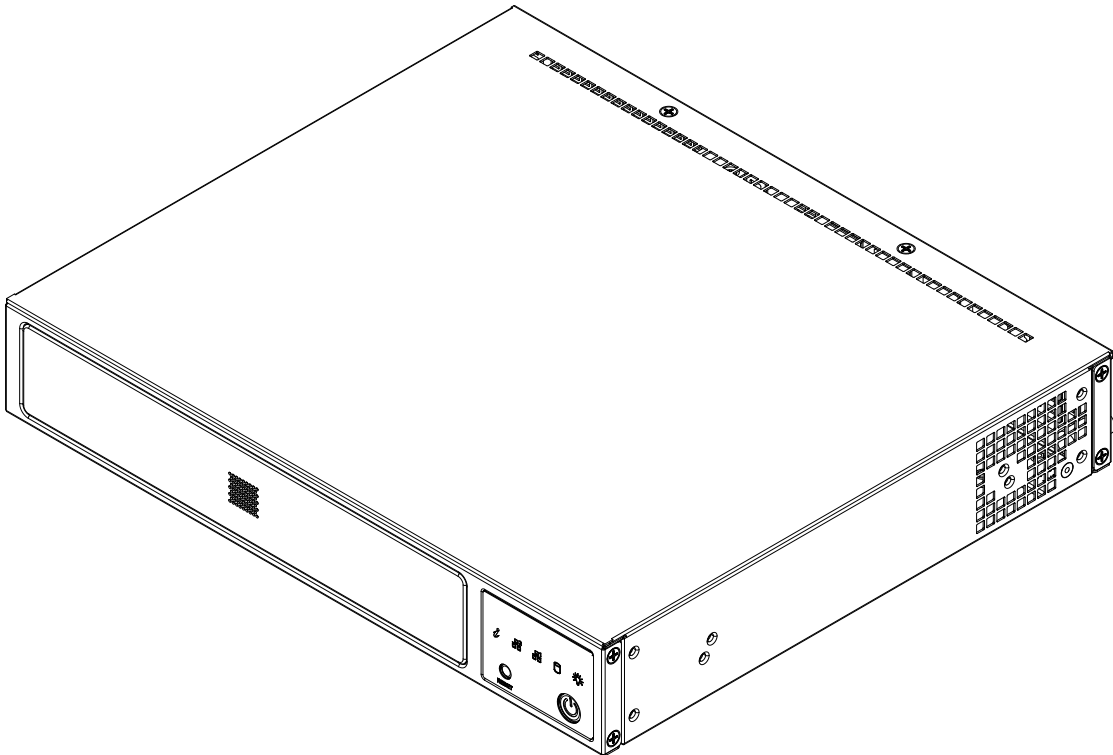

SUPERSERVER[®]
E300-9D



USER'S MANUAL

Revision 1.0

The information in this User's Manual has been carefully reviewed and is believed to be accurate. The vendor assumes no responsibility for any inaccuracies that may be contained in this document, and makes no commitment to update or to keep current the information in this manual, or to notify any person or organization of the updates. **Please Note: For the most up-to-date version of this manual, please see our website at www.supermicro.com.**

Super Micro Computer, Inc. ("Supermicro") reserves the right to make changes to the product described in this manual at any time and without notice. This product, including software and documentation, is the property of Supermicro and/or its licensors, and is supplied only under a license. Any use or reproduction of this product is not allowed, except as expressly permitted by the terms of said license.

IN NO EVENT WILL Super Micro Computer, Inc. BE LIABLE FOR DIRECT, INDIRECT, SPECIAL, INCIDENTAL, SPECULATIVE OR CONSEQUENTIAL DAMAGES ARISING FROM THE USE OR INABILITY TO USE THIS PRODUCT OR DOCUMENTATION, EVEN IF ADVISED OF THE POSSIBILITY OF SUCH DAMAGES. IN PARTICULAR, SUPER MICRO COMPUTER, INC. SHALL NOT HAVE LIABILITY FOR ANY HARDWARE, SOFTWARE, OR DATA STORED OR USED WITH THE PRODUCT, INCLUDING THE COSTS OF REPAIRING, REPLACING, INTEGRATING, INSTALLING OR RECOVERING SUCH HARDWARE, SOFTWARE, OR DATA.

Any disputes arising between manufacturer and customer shall be governed by the laws of Santa Clara County in the State of California, USA. The State of California, County of Santa Clara shall be the exclusive venue for the resolution of any such disputes. Supermicro's total liability for all claims will not exceed the price paid for the hardware product.

FCC Statement: This equipment has been tested and found to comply with the limits for a Class A digital device pursuant to Part 15 of the FCC Rules. These limits are designed to provide reasonable protection against harmful interference when the equipment is operated in a commercial environment. This equipment generates, uses, and can radiate radio frequency energy and, if not installed and used in accordance with the manufacturer's instruction manual, may cause harmful interference with radio communications. Operation of this equipment in a residential area is likely to cause harmful interference, in which case you will be required to correct the interference at your own expense.

California Best Management Practices Regulations for Perchlorate Materials: This Perchlorate warning applies only to products containing CR (Manganese Dioxide) Lithium coin cells. "Perchlorate Material-special handling may apply. See www.dtsc.ca.gov/hazardouswaste/perchlorate".



WARNING: This product can expose you to chemicals including lead, known to the State of California to cause cancer and birth defects or other reproductive harm. For more information, go to www.P65Warnings.ca.gov.

The products sold by Supermicro are not intended for and will not be used in life support systems, medical equipment, nuclear facilities or systems, aircraft, aircraft devices, aircraft/emergency communication devices or other critical systems whose failure to perform be reasonably expected to result in significant injury or loss of life or catastrophic property damage. Accordingly, Supermicro disclaims any and all liability, and should buyer use or sell such products for use in such ultra-hazardous applications, it does so entirely at its own risk. Furthermore, buyer agrees to fully indemnify, defend and hold Supermicro harmless for and against any and all claims, demands, actions, litigation, and proceedings of any kind arising out of or related to such ultra-hazardous use or sale.

Manual Revision 1.0

Release Date: July 10, 2018

Unless you request and receive written permission from Super Micro Computer, Inc., you may not copy any part of this document. Information in this document is subject to change without notice. Other products and companies referred to herein are trademarks or registered trademarks of their respective companies or mark holders.

Copyright © 2018 by Super Micro Computer, Inc.
All rights reserved.

Printed in the United States of America

Preface

About this Manual

This manual is written for professional system integrators and PC technicians. It provides information for the installation and use of the SuperServer E300-9D. Installation and maintenance should be performed by experienced technicians only.

Notes

For your system to work properly, please follow the links below to download all necessary drivers/utilities and the user's manual for your server.

- Supermicro product manuals: <http://www.supermicro.com/support/manuals/>
- Product drivers and utilities: <ftp://ftp.supermicro.com>
- Product safety info: http://www.supermicro.com/about/policies/safety_information.cfm

If you have any questions, please contact our support team at:
support@supermicro.com

This manual may be periodically updated without notice. Please check the Supermicro website (<http://www.supermicro.com>) for possible updates to the manual revision level.

Warnings

Special attention should be given to the following symbols used in this manual.



Warning! Indicates important information given to prevent equipment/property damage or personal injury.



Warning! Indicates high voltage may be encountered when performing a procedure.

Contents

Chapter 1 Introduction

1.1 Overview.....	7
1.2 System Features	8
1.3 Chassis Features	9
Front Features.....	9
Rear Features	10
1.4 Motherboard Layout	11
Quick Reference Table.....	12
Chipset Block Diagram.....	13
1-5 Server Installation and Setup.....	14
Unpacking the System	14
Warnings and Precautions	14
Adding Components to your System	14
Installing Rack Mounting Brackets.....	15

Chapter 2 Maintenance and Component Installation

2.1 Removing Power	16
2.2 Accessing the System.....	17
2.3 Motherboard Components.....	18
Processor	18
Memory Support.....	18
Memory Population Sequence	18
Installing Memory	19
Solid State Storage	20
Motherboard Battery	21
2.4 Chassis Components	22
Installing the Storage Drive	22
Installing the Riser Card	23
System Cooling	24

Chapter 3 Motherboard Connections

3.1 Power Connections	25
3.2 Headers and Connectors	26
Control Panel	29
3.3 Ports	31

3.4 Jumpers.....	33
Explanation of Jumpers.....	33
3.5 LED Indicators.....	35
3.6 SATA Connections.....	38
Chapter 4 Software	
4.1 Driver Installation.....	39
4.2 SuperDoctor® 5.....	40
4.3 IPMI.....	41
Chapter 5 BIOS	
5.1 Introduction.....	42
Starting the Setup Utility.....	42
5.2 Main Setup.....	43
5.3 Advanced.....	45
5.4 Event Logs.....	71
5.5 IPMI.....	73
5.6 Security.....	76
5.7 Boot.....	81
5.8 Save & Exit.....	83
Appendix A BIOS Error Codes	
Appendix B Standardized Warning Statements for DC Systems	
Appendix C System Specifications	

Contacting Supermicro

Headquarters

Address: Super Micro Computer, Inc.
980 Rock Ave.
San Jose, CA 95131 U.S.A.

Tel: +1 (408) 503-8000

Fax: +1 (408) 503-8008

Email: marketing@supermicro.com (General Information)
support@supermicro.com (Technical Support)

Website: www.supermicro.com

Europe

Address: Super Micro Computer B.V.
Het Sterrenbeeld 28, 5215 ML
's-Hertogenbosch, The Netherlands

Tel: +31 (0) 73-6400390

Fax: +31 (0) 73-6416525

Email: sales@supermicro.nl (General Information)
support@supermicro.nl (Technical Support)
rma@supermicro.nl (Customer Support)

Website: www.supermicro.nl

Asia-Pacific

Address: Super Micro Computer, Inc.
3F, No. 150, Jian 1st Rd.
Zhonghe Dist., New Taipei City 235
Taiwan (R.O.C)

Tel: +886-(2) 8226-3990

Fax: +886-(2) 8226-3992

Email: support@supermicro.com.tw

Website: www.supermicro.com.tw

Chapter 1

Introduction

1.1 Overview

The SuperServer E300-9D is a compact, embedded system comprised of the SCE300 chassis and the X11SDV-4C-TLN2F single processor motherboard. Refer to our website for information on operating systems that have been certified for use with the system (www.supermicro.com).

This chapter provides a brief outline of the functions and features. In addition to the motherboard and chassis, several important parts that are included with the system are listed below.

Main Parts List		
Description	Part Number	Quantity
120W DC power adapter	MCP-250-10127-0N	1
Fans	FAN-0065L4	3
RSC-RR1U-E8 (Rev 4.00) Riser Card Riser Card	RSC-RR1U-E8	1
Rackmount Rail Kit	MCP-290-30002-0B	1 set
RJ45 SerialCable for Console	CBL-CUSB-0975	1

1.2 System Features

The following table provides an overview of the main features of the E300-9D. Please refer to Appendix C for additional specifications.

System Features
Motherboard
X11SDV-4C-TLN2F
Chassis
Compact Embedded Mini ITX Box, SCE300
CPU
Intel Xeon D-2123IT (System on a Chip)
Memory
Four DDR4 DIMM sockets; supports up to 512GB DDR4 ECC RDIMM or up to 64GB DDR4 ECC/non-ECC UDIMM; Memory Type 2666/2400/2133MHz; DIMM Sizes 64GB, 32GB, 16GB, 8GB, 4GB
Expansion Slots
One PCI-E 3.0 x16 slot (low profile)
Storage Drives
Single fixed 2.5" hard drive bay with bracket for 9.5 mm thickness HDD (when AOC area is not occupied) One OCuLink port (or one PCI-E x4 slot for NVMe HDDs) One PCI-E 3.0 x8 slot
Power
One external 120 or 150 watt DC power adapter
Input/Output Ports
LAN: Two RJ45 10GBase-T ports IPMI: One dedicated LAN port USB: Two USB3.0 ports Display: VGA Serial ATA: Four SATA 3.0 ports DOM: SuperDOM (Disk on Module) power connectors TPM 2.0 header
Cooling
Three 4-cm PWM chassis fans, plus a passive CPU heatsink
Dimensions
W x H x D: 10" (254 mm) x 1.7" (43 mm) x 8.9" (226 mm)

1.3 Chassis Features

The SCE300 is a compact embedded 1U chassis for Mini ITX and a Flex ATX motherboard.

Front Features

The front of the chassis includes the control panel.

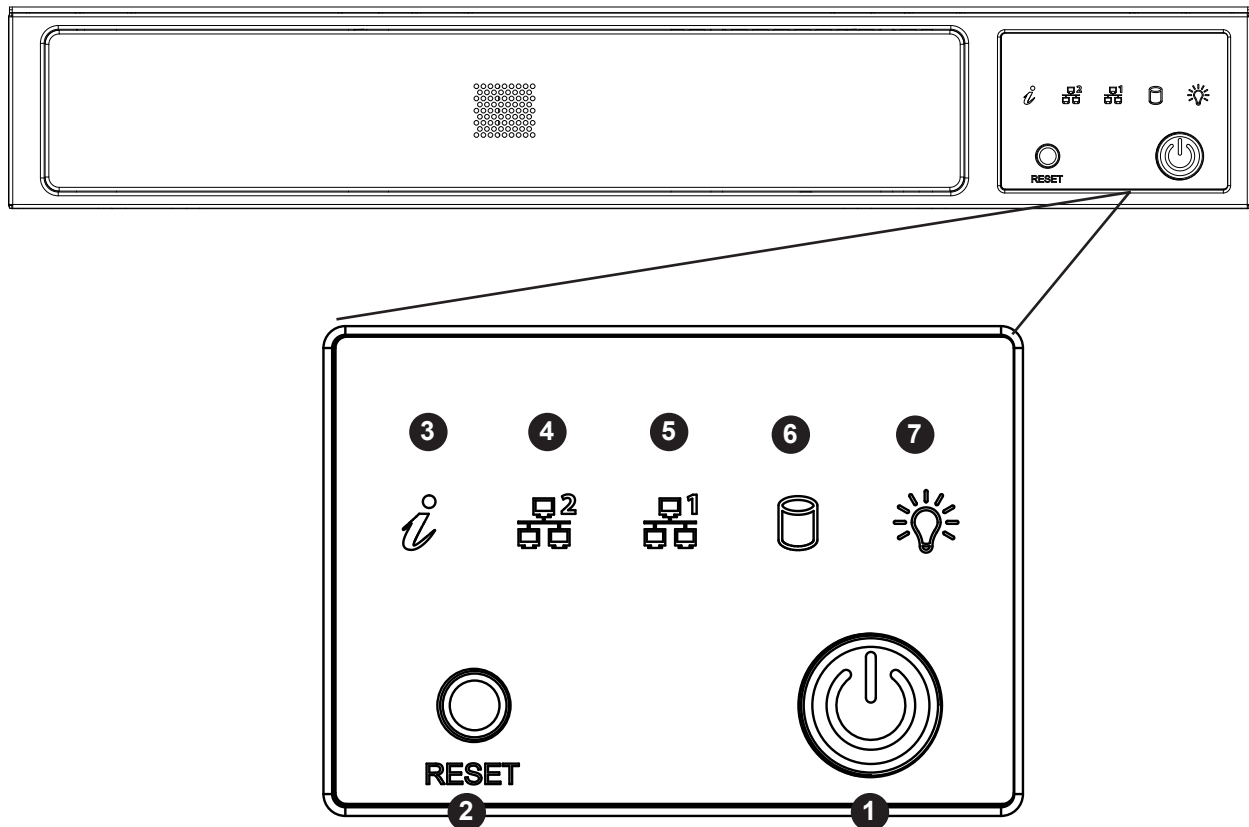

Figure 1-1. Chassis Front and Control Panel

Control Panel Features		
Item	Features	Description
1	Power button	The main power switch applies or removes primary power from the power supply to the server but maintains standby power. To perform most maintenance tasks, unplug the system to remove all power.
2	Reset button	Resets the system
3	Information LED	Alerts operator to several states, as noted in the table below
4 and 5	NIC LED	Indicates network activity on the LAN when flashing.
6	HDD LED	Indicates hard disk drive activity when flashing.
7	Power LED	Indicates power is being supplied to the system power supply units. This LED is illuminated when the system is operating normally.

Information LED	
Status	Description
Continuously on and red	An overheat condition has occurred. (This may be caused by cable congestion.)
Blinking red (1Hz)	Fan failure, check for an inoperative fan.
Blinking red (0.25Hz)	Power failure, check for a non-operational power supply.
Solid blue	Local UID has been activated. Use this function to locate the server in a rackmount environment.
Blinking blue	Remote UID is on. Use this function to identify the server from a remote location.

Rear Features

The chassis rear holds input/output ports, described in chapter 3.

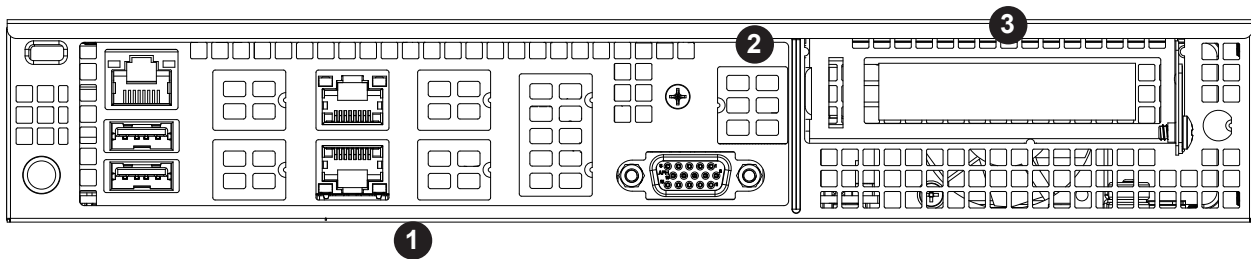

Figure 1-2. Rear Chassis View

Rear Chassis Features		
Item	Features	Description
1	I/O Ports	IPMI LAN, USB, LAN, VGA (further described in Chapter 3)
2	AOM Window	Reserved for RJ45 console redirection cable
3	PCI Bay	Bay for low-profile PCI-E add-on card

1.4 Motherboard Layout

Below is a layout of the X11SDV-4C-TLN2F with jumper, connector and LED locations shown. See the table on the following page for descriptions. For detailed descriptions, pin-out information and jumper settings, refer to Chapter 4.

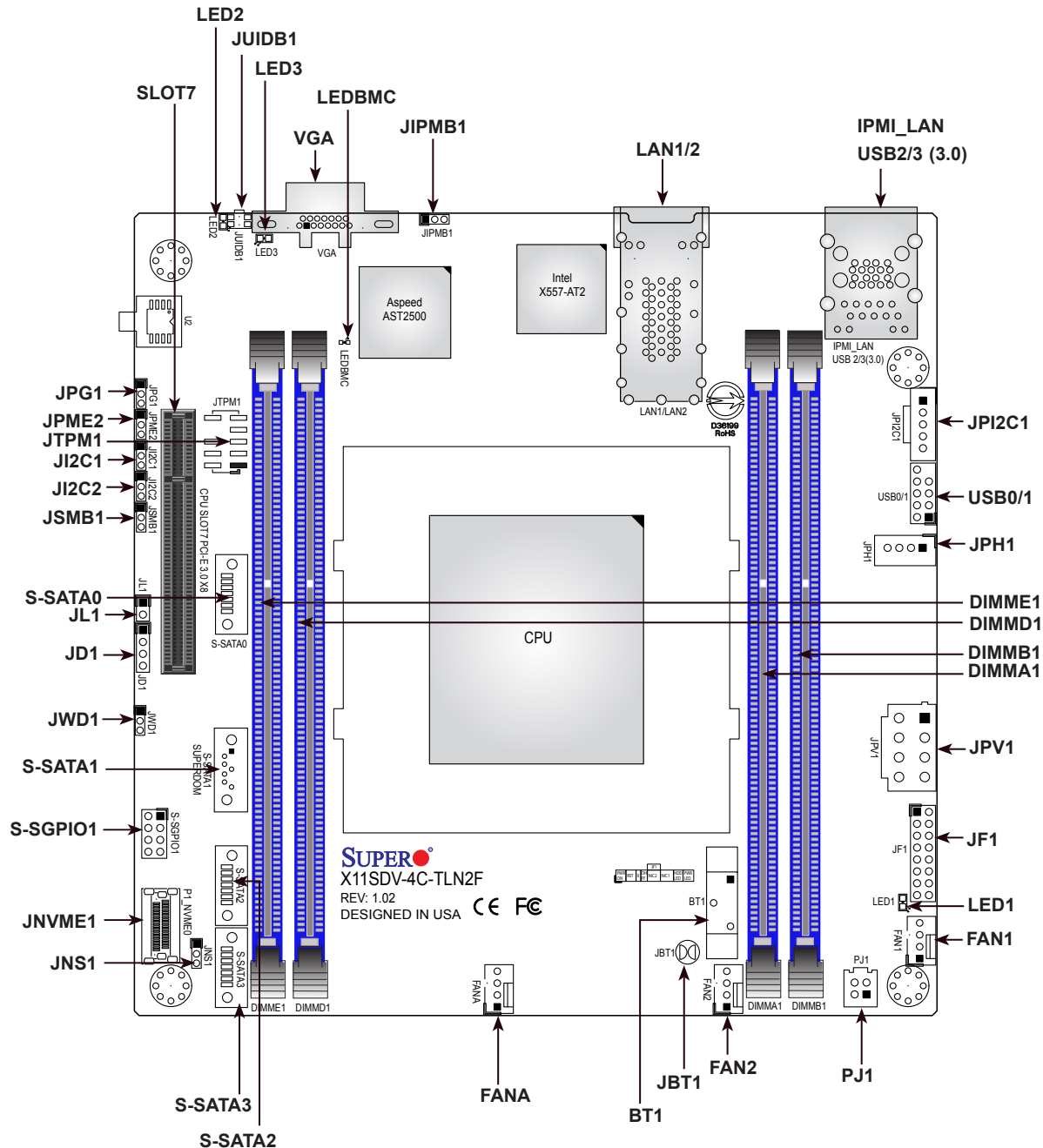

Figure 1-3. Motherboard Layout

Notes:

- "1" indicates the location of pin 1.
- Jumpers/LED indicators not indicated are used for testing only.

Quick Reference Table

Jumper	Description	Default Setting
JBT1	CMOS Clear	Open: Normal, Closed: Clear CMOS
JI ² C1, JI ² C2	SMB to PCI-E Slots Enable/Disable	Pins 2-3 (Disabled)
JNS1	OCuLink to 4x SATA or PCI-E x4 Selection	Pins 2-3: (PCI-E x4)
JPG1	Onboard VGA Enable/Disable	Pins 1-2 (Enabled)
JPME2	Manufacturing Mode Select	Pins 1-2 (Normal)
JWD1	Watch Dog Timer	Pins 1-2 (Reset)

LED	Description	Status
LED1	Power LED	Solid Green: Power On
LED2	UID LED	Solid Blue: Unit Identified
LED3	Overheat (OH)/PWR Fail/Fan Fail LED	Solid Red: Overheat Blinking Red: PWR Fail or Fan Fail
LEDBMC	BMC Heartbeat	Blinking Green: BMC Normal

Connector	Description
BT1	Onboard Battery
FAN1 - FAN2, FANA	CPU/System Fan Headers
IPMI_LAN	Dedicated IPMI LAN Port
JD1	Speaker Header (Pins 1-4: Speaker)
JF1	Front Control Panel Header
JIPMB1	System Management Bus Header (for IPMI only)
JL1	Chassis Intrusion Header
JPI ² C1	Power I ² C System Management Bus (Power SMB) Header
JPH1	4-pin Power Connector for HDD use
JPV1	8-pin 12V DC Power Input (Required for both 12V only and 24-pin ATX power)
JSMB1	System Management Bus Header
JTPM1	Trusted Platform Module (TPM)/Port 80 Connector
JUIDB1	Unit Identifier Button
LAN1 - LAN2	10 Gigabit (RJ45) LAN Ports
P1_NVME0	OCuLink Connector (to 4x SATA or PCI-E x4)
PJ1	Header for ATX Power Signal 5VSTBY/Power ON/Power GOOD/Ground (CBL-PWEX-1063)
S-SATA0 - S-SATA3	SATA 3.0 Ports
S-SGPIO1	Serial General Purpose I/O Header
SLOT7	PCI-E 3.0 x8 Slot
USB0/1	USB 2.0 Header
USB2/3	Back Panel USB 3.0 Ports
VGA	VGA Port

Chipset Block Diagram

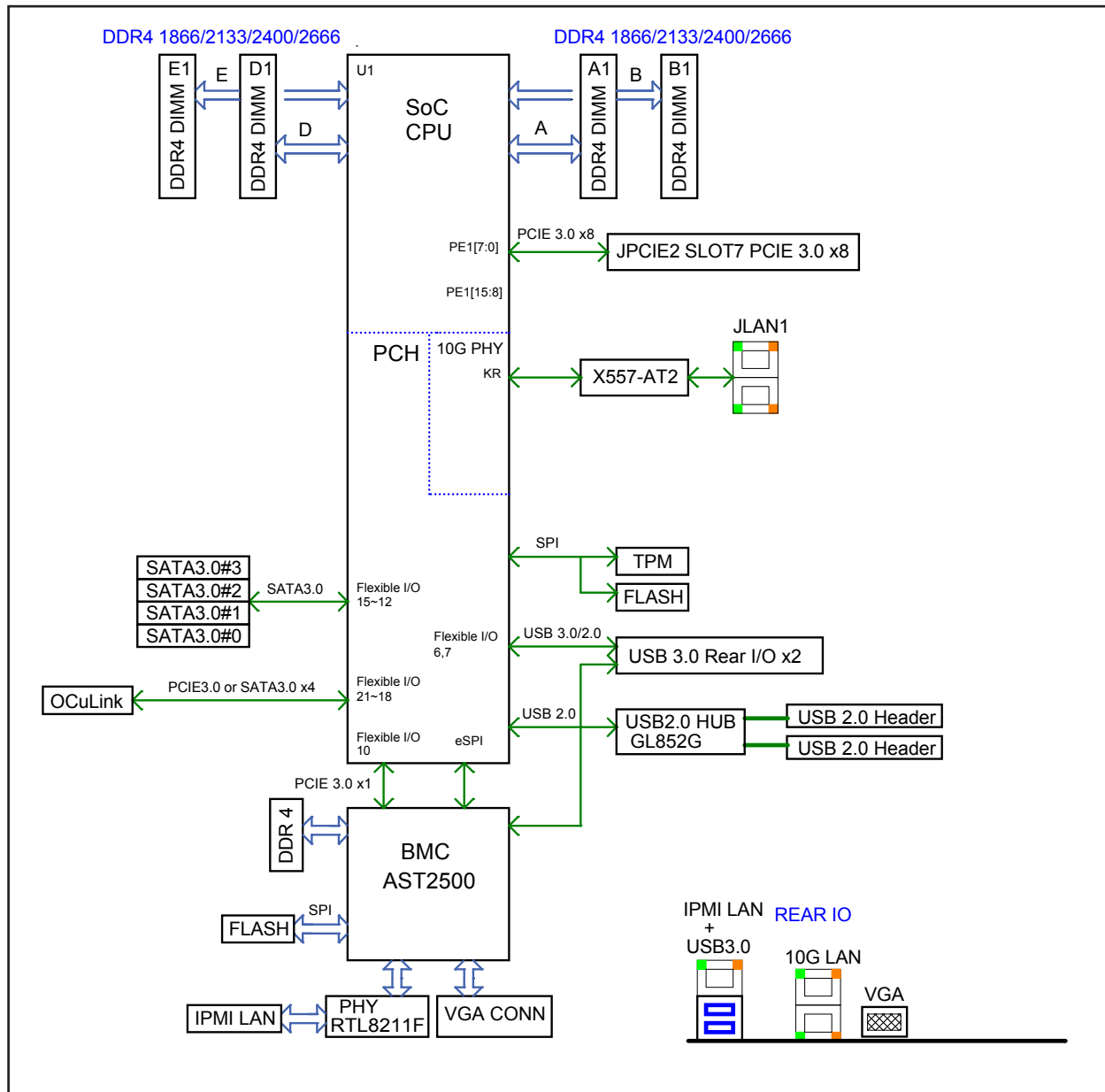

Figure 1-4. System Block Diagram

Note: This is a general block diagram and may not exactly represent the features on your motherboard. See the System Specifications appendix for the actual specifications of your motherboard.

1-5 Server Installation and Setup

The server is shipped with the onboard processor and the motherboard installed in the chassis. Several steps are necessary to begin using your server. You must add memory, mount the hard disk drive, and mount the system in place.

Unpacking the System

Inspect the box in which the system was shipped and note if it was damaged. If the server itself shows damage, file a damage claim with the carrier.

Warnings and Precautions

- Use a regulating uninterruptible power supply (UPS) to protect the server from power surges, voltage spikes and to keep your system operating in case of a power failure.
- Review the electrical and general safety precautions in Appendix B.

Adding Components to your System

- **Memory:** If your system is not already fully integrated with system memory, refer to Chapter 2 for details on compatible types of memory and the installation procedure.
- **Drives and Storage:** To add storage capabilities to your server, see Chapter 2.
- **Input/Output:** See Chapter 3 for I/O ports and connect them as needed.
- **Software:** See Chapter 4 for description and procedures for installing software, including drivers and monitoring programs.

Installing Rack Mounting Brackets

The chassis can be mounted in a rack using two rack brackets and a two-part power adapter shelf bracket (optional, MCP-290-30002-0B).

1. Attach the rack brackets using three screws through the holes in each bracket to secure the bracket to the chassis.
2. Install the handles, using two screws through the bracket and into each handle.
3. If you are using the optional power adapter bracket, install the power adapter on its bracket. Place it as shown, then add the retention bracket using two screws.
4. Mount the power adapter bracket assembly on the right side of the chassis using three screws.

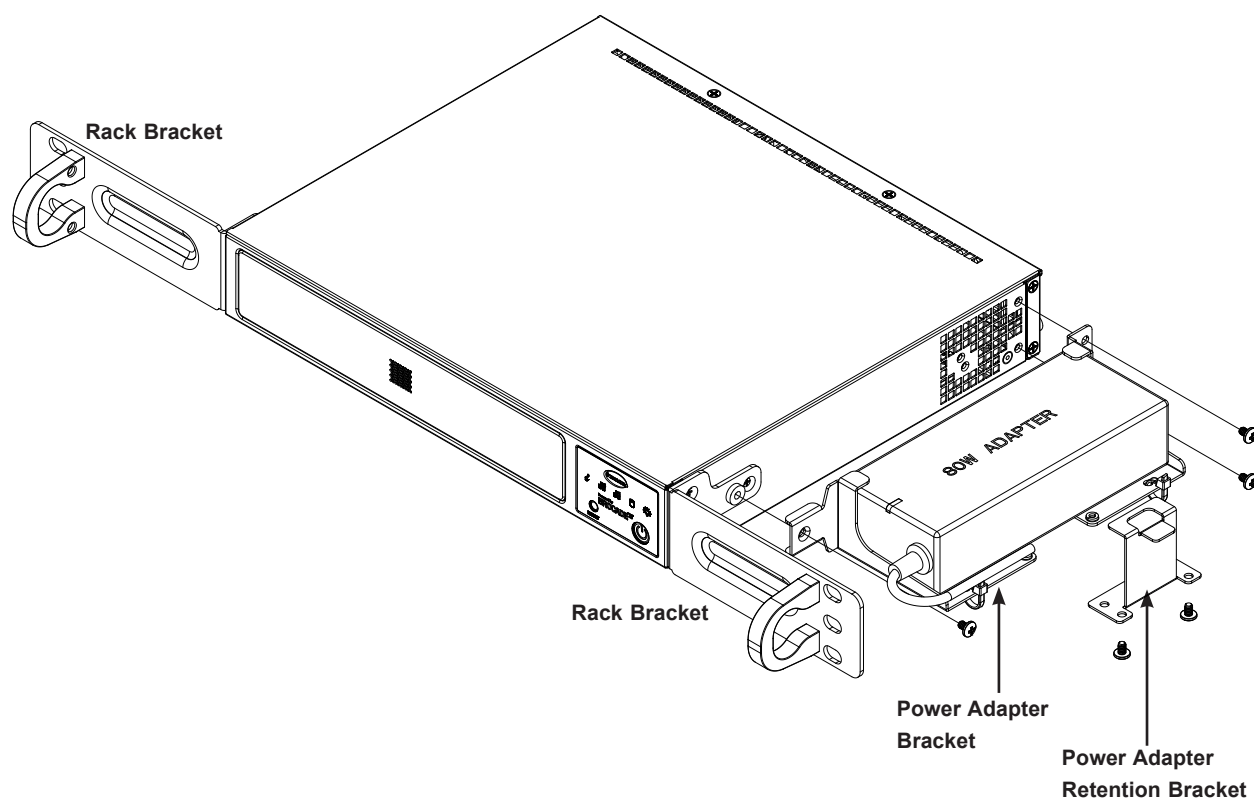

Figure 1-5. Installing Rack Mounting Brackets

Chapter 2

Maintenance and Component Installation

This chapter provides instructions on installing and replacing main system components. To prevent compatibility issues, only use components that match the specifications and/or part numbers given.

Installation or replacement of most components require that power first be removed from the system. Please follow the procedures given in each section.

2.1 Removing Power

Use the following procedure to ensure that power has been removed from the system. This step is necessary when removing or installing non hot-swap components or when replacing a non-redundant power supply.

1. Use the operating system to power down the system.
2. After the system has completely shut-down, disconnect the AC adapter power cord from the power source.
3. Disconnect the power cord from the chassis.

2.2 Accessing the System

The SCE300 features a removable top cover to access to the inside of the chassis.

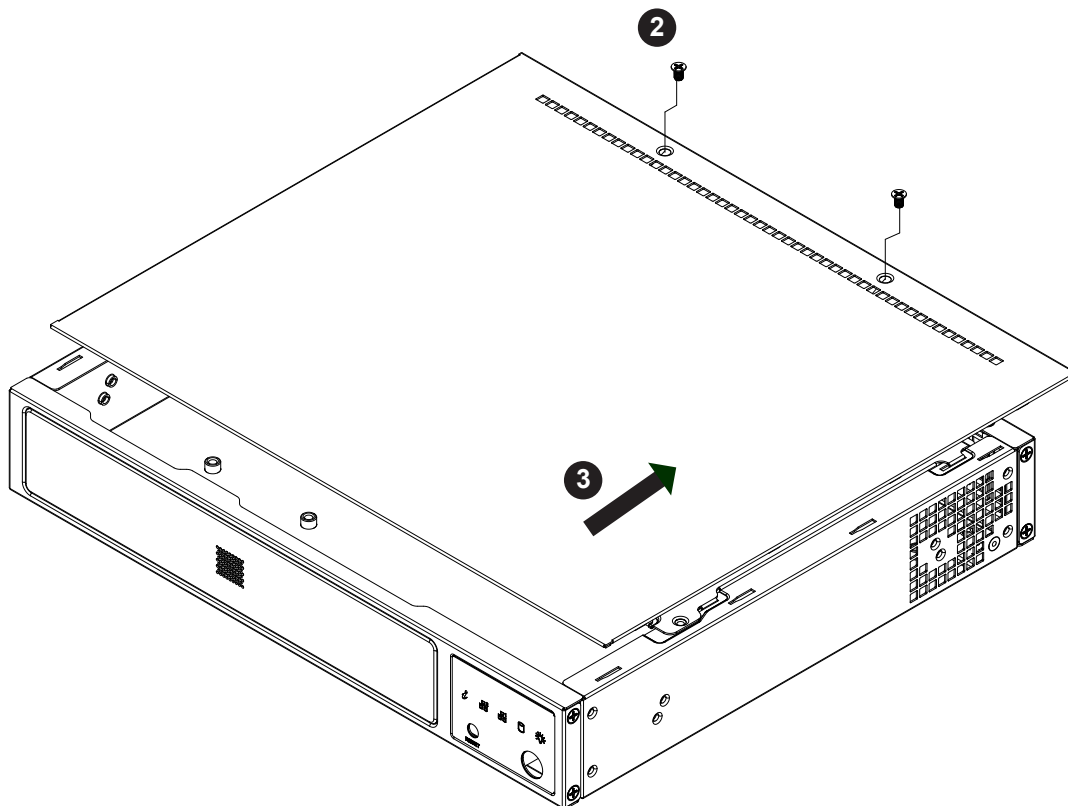

Figure 2-1. Removing the Chassis Cover

Removing the Top Cover

1. Power down the system as described in section 2.1.
2. Remove the two screws that hold the cover in place.
3. Slide the cover sideways as illustrated above to release the front and rear cover hooks from the chassis.
4. Lift the cover up and off the chassis.

Caution: Except for short periods of time, do *not* operate the server without the cover in place. The chassis cover must be in place to allow proper airflow and prevent overheating.

2.3 Motherboard Components

Processor

The E300-9D features an embedded Intel Xeon D-2123IT SoC processor.

Memory Support

The X11SDV-4C-TLN2F motherboard supports up to 512GB of DDR4 ECC RDIMM or up to 64GB of DDR4 ECC/non-ECC UDIMM; DDR4 2666/2400/2133MHz memory in four memory slots. Populating these DIMM slots with memory modules of the same type and size will result in interleaved memory, which will improve memory performance.

Note: Check the Supermicro website for recommended memory modules.

Memory Population Sequence

When installing memory modules, the DIMM slots should be populated in the following order: DIMMA1, DIMMB1, DIMMD1, DIMME1.

Memory Population (Balanced)				
DIMMA1	DIMMB1	DIMMD1	DIMME1	Total System Memory
8GB				8GB
8GB	8GB			16GB
8GB	8GB	8GB		24GB
8GB	8GB	8GB	8GB	32GB
16GB	16GB			32GB
16GB	16GB	16GB		48GB
16GB	16GB	16GB	16GB	64GB
32GB	32GB			64GB
32GB	32GB	32GB		96GB
32GB	32GB	32GB	32GB	128GB
64GB	64GB			128GB
64GB	64GB	64GB		192GB
64GB	64GB	64GB	64GB	256GB
126GB	128GB			256GB
128GB	128GB	128GB	128GB	512GB

Installing Memory

When installing memory modules, the DIMM slots should be populated in the following order: DIMMA1, DIMMB1, then DIMMA2, DIMMB2.

- Always use DDR4 DIMM modules of the same size, type and speed. Mixing memory modules of different types and speeds is not allowed.
- The motherboard will support one DIMM module installed. However, for best memory performance, install DIMM modules in pairs.

Caution: Exercise extreme care when installing or removing DIMM modules to prevent damage.

Installing Memory

Begin by removing power from the system as described in Section 2.1.

1. Starting with P1-DIMMA1, push the release tabs outwards on both ends of the DIMM slot to unlock it.

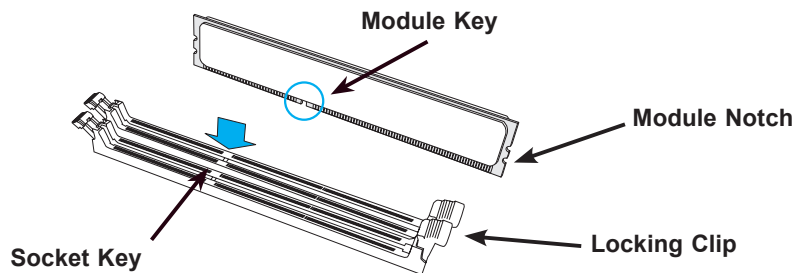

2. Align the key of the DIMM with the receptive point on the memory slot and with your thumbs on both ends of the module, press it straight down into the slot until the module snaps into place.

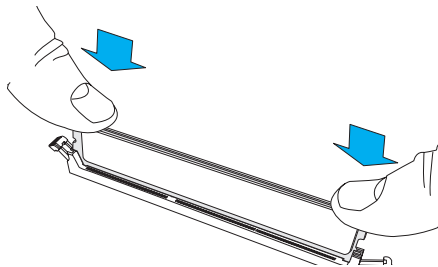

3. Press the release tabs to the locked position to secure the DIMM module into the slot. Repeat for other DIMM slots as needed in the following order:

To remove a DIMM, unlock the release tabs then pull the DIMM from the memory slot.

Solid State Storage

This motherboard supports four internally mounted solid state storage cards:

- Four SATA 3.0 ports(SATA/SAS HDD/SSD). Up to eight SATA 3.0 ports (four via OCuLink connection).
- One OCuLink port can be utilized as four SATA ports or a single U.2 NVMe port.

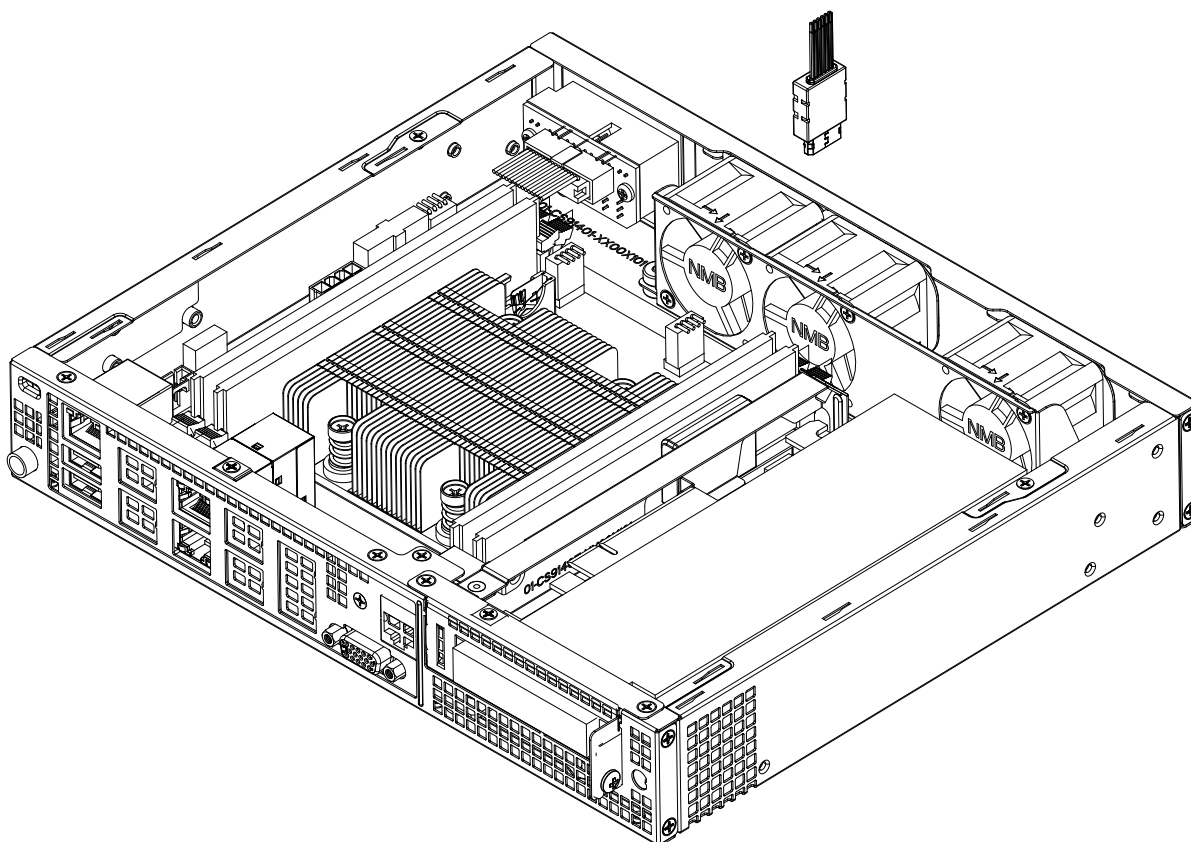

Figure 2-2. Installing a SATA HDD/SSD or a PCI-E NVMe SSD

Motherboard Battery

The motherboard uses non-volatile memory to retain system information when system power is removed. This memory is powered by a lithium battery residing on the motherboard.

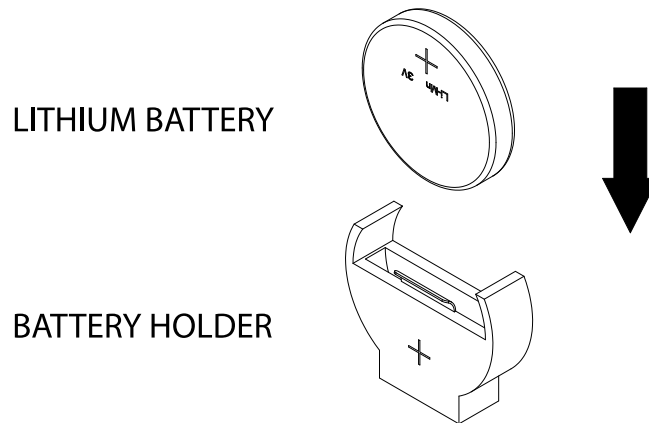

Figure 2-3. Installing the Onboard Battery

Replacing the Battery

1. Remove power from the system as described in section 3.1.
2. Push aside the small clamp that covers the edge of the battery. When the battery is released, lift it out of the holder.
3. To insert a new battery, slide one edge under the lip of the holder with the positive (+) side facing up. Then push the other side down until the clamp snaps over it.

Note: Handle used batteries carefully. Do not damage the battery in any way; a damaged battery may release hazardous materials into the environment. Do not discard a used battery in the garbage or a public landfill. Please comply with the regulations of your local hazardous waste management agency to dispose of your used battery properly.

Warning: There is a danger of explosion if the onboard battery is installed upside down (which reverses its polarities). This battery must be replaced only with the same or an equivalent type recommended by the manufacturer (CR2032).

2.4 Chassis Components

Installing the Storage Drive

The SCE300 can accommodate a single fixed 2.5" storage drive of 9.5 mm thickness. It is installed to a mounting tray inside the chassis. Use an enterprise quality drive.

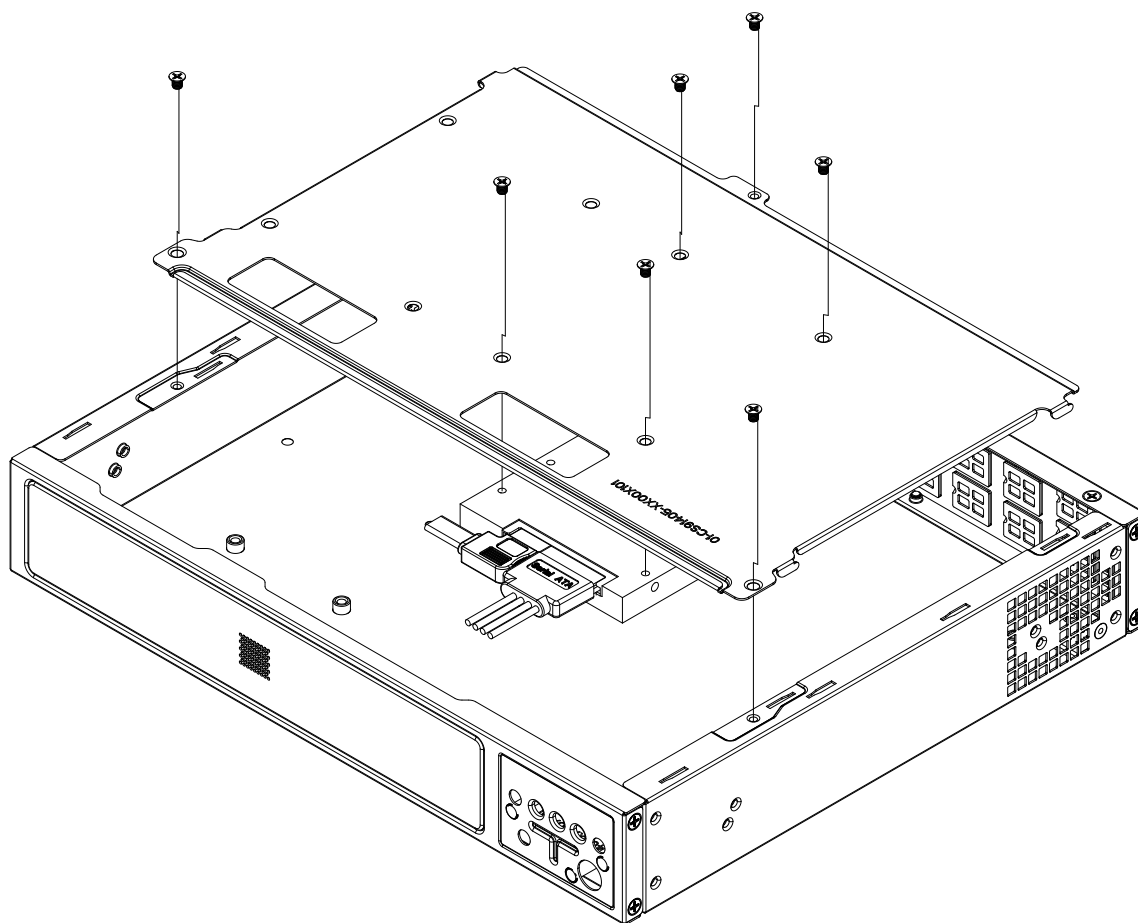

Figure 2-4. Installing the Hard Drive

Installing the Hard Drive

The motherboard should be installed before installing the drive.

1. Make sure there is no power to the system as described in section 2.1 and remove the chassis cover.
2. Remove the screws securing the hard drive tray to the support bracket and set them aside for later use. Lift the tray out.
3. Place the drive into the tray and secure it to the tray with the screws provided with drive.

4. Return the drive tray assembly into the chassis, aligning the tabs of the tray with the slots in the chassis. Secure the tray to the chassis support bracket with the screws previously set aside.
5. Attach the cable SATA connector and to the motherboard connector. This cable carries both the SATA signal and the SATA power.
6. Reinstall the chassis cover and power up the system.

Installing the Riser Card

The system can support one PCI-E x8 expansion card by means of an optional riser card. The riser card is inserted in the expansion slot on the motherboard. Installation of the riser card and riser card bracket is pictured below.

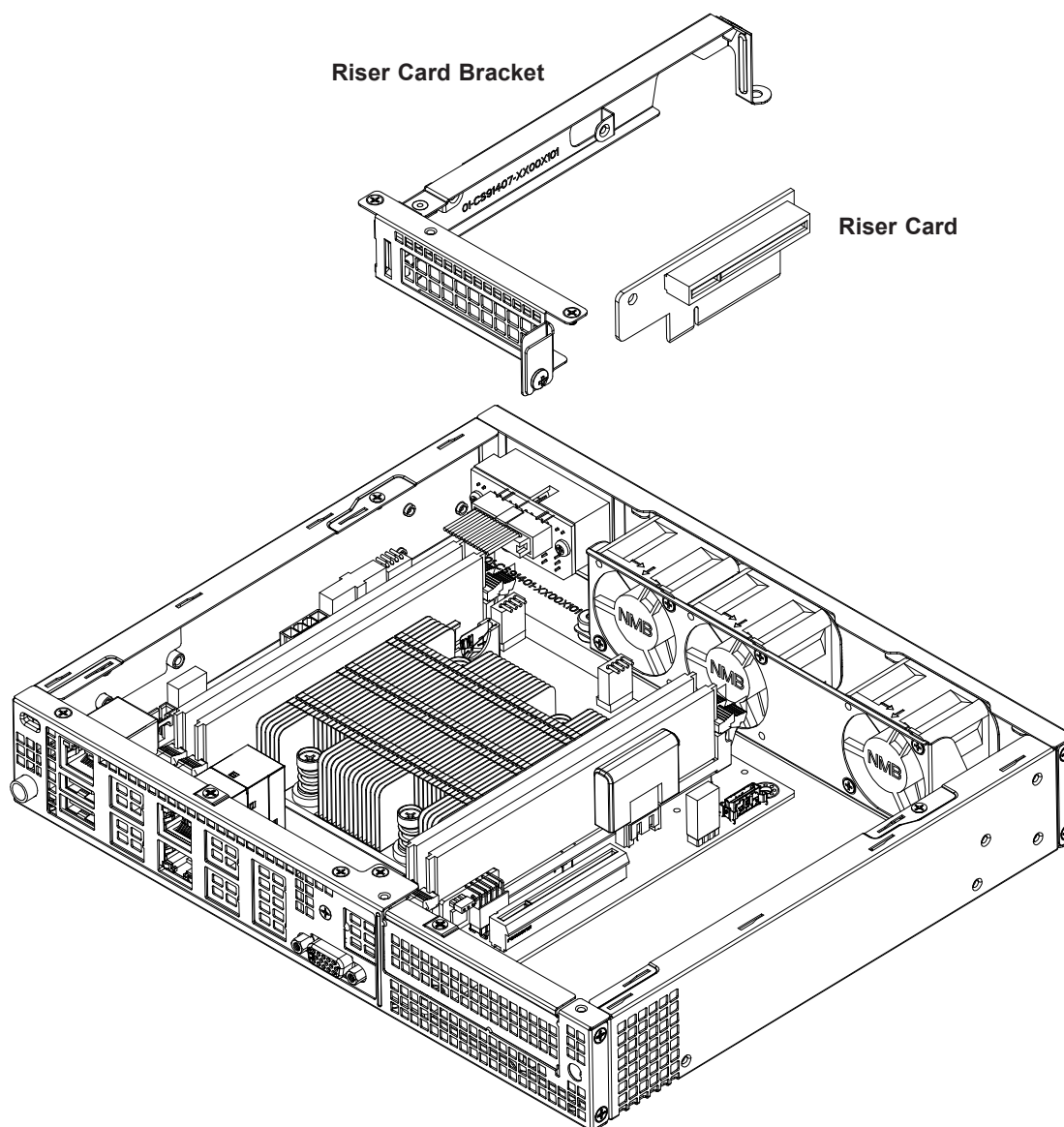

Figure 2-5. Installing the Riser Card

System Cooling

The SCE300 includes two replaceable 4-cm fans. An optional third fan can be purchased.

Replacing the System Fan

1. Power down the system as described in section 2.1 and remove the AC power cord and the chassis cover.
2. Remove the failed fan power cable from motherboard.
3. Remove the screws securing the fan to the chassis wall and save them.
4. Lift the fan out of the chassis.
5. Align the replacement fan with the holes in the wall of the chassis.
6. Secure the fan to the chassis wall using the screws previously set aside.
7. Reconnect the fan cable to motherboard.
8. Reinstall the chassis top cover, reconnect the AC power cord and power up the system.

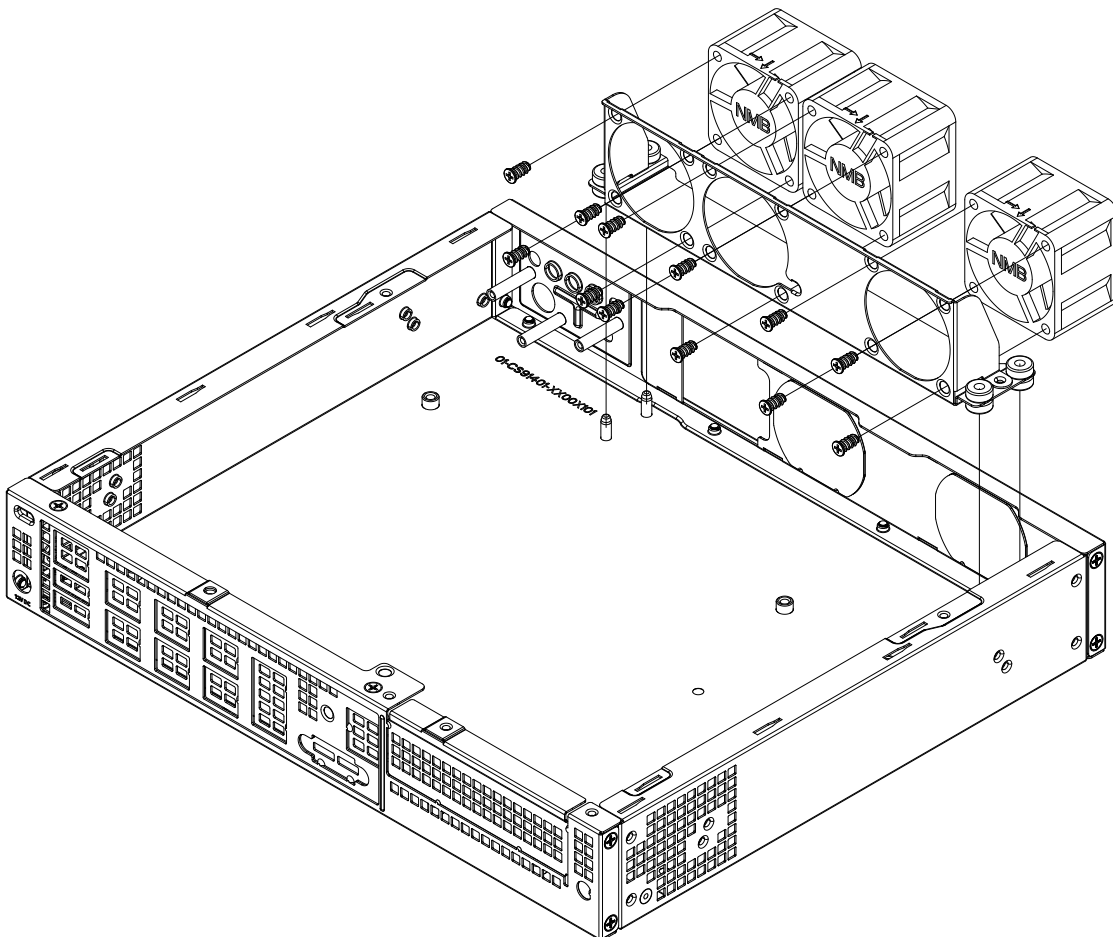

Figure 2-6. System Fans (third fan optional)

Chapter 3

Motherboard Connections

This section describes the connections on the X11SDV-4C-TLN2F motherboard and provides pinout definitions. Note that depending on how the system is configured, not all connections are required. The LEDs on the motherboard are also described here. A motherboard layout indicating component locations may be found in Chapter 1.

Please review the safety precautions in Appendix B before installing or removing components.

3.1 Power Connections

Main ATX Power Supply Connector

JPV1 is the 12V DC power connector that provides alternative power for a special enclosure when the 24-pin ATX power is not in use. PJ1 is a 4-pin to 24-pin ATX power connector.

8-pin 12V Power (JPV1) Pin Definitions	
Pins	Definition
1 - 4	Ground
5 - 8	+12V

4-pin to ATX Power Signal (PJ1) Pin Definitions	
Pin#	Definition
1	PWR_OK
2	GND
3	5VSB
4	PS_ON

HDD Power Connector

JPH1 is a 4-pin power connector for HDD use. It provides power from the motherboard to the onboard HDD.

4-pin HDD Power Pin Definitions	
Pin#	Definition
1	12V
2-3	GND
4	5V

3.2 Headers and Connectors

Fan Headers

The X11SDV-4C-TLN2F has three 4-pin fan headers (FAN1, FAN2, FANA). These headers are backwards-compatible with the traditional 3-pin fans. However, fan speed control is available for 4-pin fans only by Thermal Management via the IPMI 2.0 interface. Refer to the table below for pin definitions.

Fan Header Pin Definitions	
Pin#	Definition
1	Ground (Black)
2	2.5A/+12V (Red)
3	Tachometer
4	PWM_Control

Speaker Header

On the JD1 header, pins 1-4 are for the external speaker.

Speaker Connector Pin Definitions	
Pin#	Definition
1	P5V
2	NIC
3	NIC
4	R_SPKPIN

Chassis Intrusion

A Chassis Intrusion header is located at JL1 on the motherboard. Attach the appropriate cable from the chassis to inform you of a chassis intrusion when the chassis is opened. Refer to the table below for pin definitions.

Chassis Intrusion Pin Definitions	
Pin#	Definition
1	Intrusion Input
2	Ground

SATA Ports

Four SATA 3.0 connectors, supported by the Intel PCH chipset, are located on the X11SDV-4C-TLN2F motherboard. These SATA ports support RAID 0, 1, 5, and 10.

OCuLink Connector

The X11SDV-4C-TLN2F includes an OcuLink connector, which can be used either for high-performance storage connectivity via the NVMe interface or for additional SATA storage. Depending on the setting of jumper JNS1, this OcuLink connector (P1NVMe0) can be utilized as four SATA ports or as a single U.2 NVMe port. NVMe provides lower data latency for increased efficiency and storage performance.

Serial General Purpose I/O Header

One S-SGPIO (Serial Link General Purpose Input/Output) header is on the motherboard. Refer to the tables below for pin definitions.

SGPIO Header Pin Definitions			
Pin#	Definition	Pin#	Definition
1	Clock2	2	Load2
3	GND	4	Data1
5	Load1	6	GND
7	Clock1	8	Data2

SMBus Header

A System Management Bus header for IPMI 2.0 is located at JIPMB1 (for IPMI only). Connect the appropriate cable here to use the IPMB I²C connection on your system. Refer to the table below for pin definitions.

External I ² C Header Pin Definitions	
Pin#	Definition
1	Data
2	GND
3	Clock

Power SMB (I²C) Header

The Power System Management Bus (I²C) connector (JPI²C1) monitors the power supply, fan, and system temperatures. Refer to the table below for pin definitions.

Power SMB Header Pin Definitions	
Pin#	Definition
1	Clock
2	Data
3	PMBUS_Alert
4	Ground
5	NC

TPM/Port 80 Header

A Trusted Platform Module (TPM)/Port 80 header is located at JTPM1 to provide TPM support and a Port 80 connection. Use this header to enhance system performance and data security. Refer to the table below for pin definitions.

Trusted Platform Module Header Pin Definitions			
Pin#	Definition	Pin#	Definition
1	+3.3V	2	SPI_CS#
3	RESET#	4	SPI_MISO
5	SPI_CLK	6	GND
7	SPI_MOSI	8	
9	+3.3V Stby	10	SPI_IRQ#

System Management Bus Header

A System Management Bus header for additional slave devices or sensors is located at JSMB1. See the table below for pin definitions.

External I ² C Header Pin Definitions	
Pin#	Definition
1	Data
2	Ground
3	Clock
4	NC

Control Panel

JF1 contains header pins for various control panel connections. See the figure below for the pin locations and definitions of the control panel buttons and LED indicators.

All JF1 wires have been bundled into a single cable to simplify this connection. Make sure the red wire plugs into pin 1 as marked on the motherboard. The other end connects to the control panel PCB board.

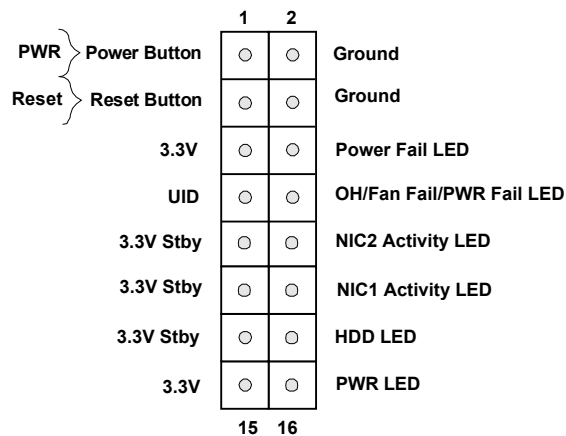

Figure 4-1. JF1: Control Panel Pins

Power Button

The Power Button connection is located on pins 1 and 2 of JF1. Momentarily contacting both pins will power on/off the system. This button can also be configured to function as a suspend button with a setting in the BIOS. To turn off the power when the system is in suspend mode, press the button for 4 seconds or longer.

Power Button Pin Definitions (JF1)	
Pin#	Definition
1	Signal
2	Ground

Reset Button

The Reset Button connection is located on pins 3 and 4 of JF1. Attach it to a hardware reset switch on the computer case.

Reset Button Pin Definitions (JF1)	
Pin#	Definition
3	Reset
4	Ground

Power Fail LED

The Power Fail LED connection is located on pins 5 and 6 of JF1.

Power Fail LED Pin Definitions (JF1)	
Pin#	Definition
5	3.3V
6	PWR Supply Fail

Overheat (OH)/Fan Fail/PWR Fail LED

Connect an LED cable to pins 7 and 8 of the Front Control Panel to use the Overheat (OH)/ Fan Fail/PWR Fail LED connections. The LED on pin 8 provides warnings of overheat, fan failure, or power failure. Refer to the tables below for pin definitions.

OH/Fan Fail Indicator Status	
State	Definition
Off	Normal
On	Overheat
Flashing	Fan Fail/PWR Fail

OH/Fan Fail LED Pin Definitions (JF1)	
Pin#	Definition
7	Blue LED
8	OH/Fan Fail/PWR Fail LED

LAN1/LAN2 Activity LED

The LAN LED connection for LAN port 1 is located on pins 11 and 12 of JF1, and the LED connection for LAN port 2 is on pins 9 and 10. Attach the NIC LED cables here to display network activity. Refer to the table below for pin definitions.

LAN1/LAN2 LED Pin Definitions (JF1)	
Pin#	Definition
9	+3.3 Stby
10	LAN2 Activity LED
11	+3.3 Stby
12	LAN1 Activity LED

HDD LED

The HDD LED connection is located on pins 13 and 14 of JF1. Attach a cable to show the hard drive activity status. Refer to the table below for pin definitions.

HDD LED Pin Definitions (JF1)	
Pin#	Definition
13	3.3V Stdby
14	HDD LED

Power LED

The Power LED connection is located on pins 15 and 16 of JF1. Refer to the table below for pin definitions.

Power LED Pin Definitions (JF1)	
Pin#	Definition
15	3.3V
16	PWR LED

3.3 Ports

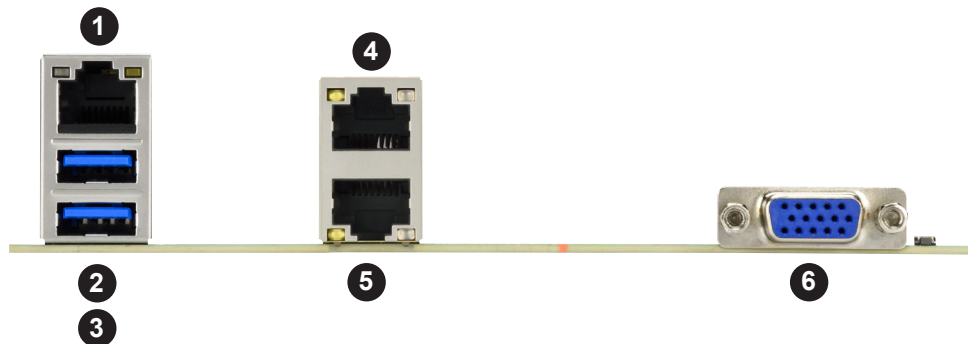

Figure 3-1. Rear I/O Ports

Rear I/O Ports			
#	Description	#	Description
1.	IPMI LAN Port	4	LAN Port 2
2.	USB Port 3	5	LAN Port 1
3	USB Port 2	6	VGA Port

VGA Port

A VGA video port is located on the I/O back panel. Use this connection for a VGA display.

LAN Ports

There are two LAN ports located on the I/O back panel of the motherboard. LAN1 and LAN2 are 10GbE RJ45 Ethernet ports. The motherboard also offers one dedicated IPMI LAN port.

Universal Serial Bus (USB) Ports

There are two USB 3.0 ports (USB2/3) on the I/O back panel. The motherboard also has one USB 2.0 header that provides two USB 2.0 ports (USB0/1). The onboard header can be used to provide front side USB access with a cable (not included).

Back Panel USB 2/3 (3.0) Pin Definitions			
Pin#	Definition	Pin#	Definition
1	+5V	10	+5V
2	USB_N	11	USB_N
3	USB_P	12	USB_P
4	Ground	13	Ground
5	USB3_RXN	14	USB3_RXN
6	USB3_RXP	15	USB3_RXP
7	Ground	16	Ground
8	USB3_TXN	17	USB3_TXN
9	USB3_TXP	18	USB3_TXP

Front Panel USB 0/1 (2.0) Pin Definitions			
Pin#	Definition	Pin#	Definition
1	+5V	2	+5V
3	USB_N	4	USB_N
5	USB_P	6	USB_P
7	Ground	8	Ground
9	Key	10	NC

Unit Identifier Button/UID LED Indicator

A Unit Identifier (UID) button and an LED indicator are provided on the motherboard. The UID button is located next to the VGA port on the back panel. The UID LED is located at LED2, next to the UID button. When you press the UID button, the UID LED will be turned on. Press the UID button again to turn off the LED indicator. The LED indicator provides easy identification of a system unit that may be in need of service.

Note: UID can also be triggered via IPMI on the motherboard. For more information on IPMI, please refer to the IPMI User's Guide posted on our website at <https://www.supermicro.com/support/manuals/>.

UID Button Pin Definitions	
Pin#	Definition
1	Ground
2	Ground
3	Button In
4	Button In

UID LED Pin Definitions	
Color	Status
Blue: On	Unit Identified

3.4 Jumpers

Explanation of Jumpers

To modify the operation of the motherboard, jumpers are used to choose between optional settings. Jumpers create shorts between two pins to change the function associated with it. Pin 1 is identified with a square solder pad on the printed circuit board. See the motherboard layout page for jumper locations.

Note: On a two-pin jumper, "Closed" means the jumper is on both pins and "Open" indicates the jumper is either on only one pin or has been completely removed.

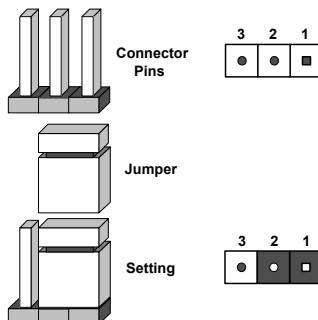

CMOS Clear

JBT1 is used to clear CMOS, which will also clear any passwords. Instead of pins, this jumper consists of contact pads to prevent accidentally clearing the contents of CMOS.

To Clear CMOS

1. First power down the system and unplug the power cord(s).
2. Remove the cover of the chassis to access the motherboard.
3. Remove the onboard battery from the motherboard.
4. Short the CMOS pads with a metal object such as a small screwdriver for at least four seconds.
5. Remove the screwdriver (or shorting device).
6. Replace the cover, reconnect the power cord(s) and power on the system.



Notes: Clearing CMOS will also clear all passwords.

Do not use the PW_ON connector to clear CMOS.

SMBus to PCI-E Slots

Use jumpers JI²C1 and JI²C2 to enable PCI-E SMB (System Management Bus) support to improve system management for the onboard PCI-E slot.

SMBus to PCI-E Slots Jumper Settings	
Jumper Setting	Definition
Pins 1-2	Enabled
Pins 2-3	Disabled (Default)

Manufacturing Mode Select

Close pins 2-3 of jumper JPME2 to bypass SPI flash security and force the system to operate in the manufacturing mode, which will allow the user to flash the system firmware from a host server for system setting modifications. Refer to the table below for jumper settings.

Manufacturing Mode Jumper Settings	
Jumper Setting	Definition
Pins 1-2	Normal (Default)
Pins 2-3	Manufacturing Mode

VGA Enable/Disable

Use jumper JPG1 to enable the onboard VGA connector. Refer to the table below for jumper settings.

VGA Enable/Disable Jumper Settings	
Jumper Setting	Definition
Pins 1-2	Enabled (Default)
Pins 2-3	Disabled

OCuLink Interface Selection

Use the JNS1 jumper to set the OCUlink port to function as a SATA or NVMe interface.

OCuLink Interface Selection Jumper Settings	
Jumper Setting	Definition
Pins 1-2	SATA
Pins 2-3	PCI-E

Watch Dog

JWD1 controls the Watch Dog function. Watch Dog is a monitor that can reboot the system when a software application hangs. Jumping pins 1-2 will cause Watch Dog to reset the system if an application hangs. Jumping pins 2-3 will generate a non-maskable interrupt signal for the application that hangs. Watch Dog must also be enabled in BIOS.

Note: When Watch Dog is enabled, users need to write their own application software to disable it.

Watch Dog Jumper Settings	
Jumper Setting	Definition
Pins 1-2	Reset (Default)
Pins 2-3	NMI
Open	Disabled

3.5 LED Indicators

LAN LEDs

Two LAN ports (LAN1, LAN2) are located on the I/O back panel. Each Ethernet LAN port has two LEDs. The green LED indicates activity, while the other Link LED may be green, amber, or off to indicate the speed of the connection. Refer to the tables below for more information.

LAN Activity LEDs (Left) LED State		
Color	Status	Definition
Yellow	Flashing	Active

LAN Link LEDs (Right) LED State	
LED Color	Definition
Off	No Connection
Amber	1 Gbps
Green	10 Gbps

Power LED

LED1 is an Onboard Power LED. When this LED is lit, it means power is present on the motherboard. In suspend mode, this LED will blink on and off. Be sure to turn off the system and unplug the power cord(s) before removing or installing components.

Onboard Power LED Indicator	
LED Color	Definition
Off	System Off (power cable not connected)
Green	System On

BMC Heartbeat LED

LEDBMC is the BMC heartbeat LED. When the LED is blinking green, BMC is working. Refer to the table below for the LED status.

Onboard Power LED Indicator	
LED Color	Definition
Blinking Green	BMC Normal

Overheat/Power Fail/Fan Fail LED

When the light for LED3 is solid red, it means overheating. When the LED is blinking red, it means a power failure or fan failure.

Overheat/Power Fail/Fan Fail LED Indicator	
LED Color	Definition
Solid Red	Overheat
Blinking Red	Power Failure/ Fan Failure

Main Power LED

A Main Power LED is located at LED3 on the motherboard. When this LED is on, the system power is on. Be sure to turn off the system power and unplug the power cord before removing or installing components.

Main Power LED Indicator	
LED Color	Definition
Off	System Off (power cable not connected)
Green	System Power On

BMC Heartbeat LED

LEDBMC is the BMC heartbeat LED. When the LED is blinking green, BMC is functioning normally.

Onboard Power LED Indicator	
LED Color	Definition
Green: Blinking	BMC Normal

Overheat/PWR Fail/Fan Fail LED

An Overheat/PWR Fail/Fan Fail LED is located at LED8.

Indicator Status	
Status	Definition
Off	Normal
On	Overheat
Flashing	Fan or power fail

Unit Identifier LEDs

UID indicators provide easy identification of a system that may be in need of service. The UID switch is located next to the VGA port on the back panel. The rear UID LED (LED7) is located next to the UID switch; the front UID LED is on the control panel. When you press the UID switch, both rear UID LED and front panel UID LED Indicators are toggled on or off. UID can also be triggered using IPMI.

3.6 SATA Connections

SATA Ports (S-SATA0 - S-SATA3)

There are four SATA 3.0 ports on the motherboard. These ports provide serial-link signal connections with the option of Intel RSTe [RAID 0,1,5,10]. S-SATA1 also supports SuperDOM, Supermicro's proprietary SATA DOM with a built-in power connection via pin 8.

Chapter 4

Software

This section describes the installation of drivers and management programs for the system.

4.1 Driver Installation

The Supermicro FTP site contains drivers and utilities for your system at <ftp://ftp.supermicro.com>. Some of these must be installed, such as the chipset driver.

After accessing the FTP site, go into the CDR_Images directory and locate the ISO file for your motherboard. Download this file to create a DVD of the drivers and utilities it contains. (You may also use a utility to extract the ISO file if preferred.)

After creating a DVD with the ISO files, insert the disk into the DVD drive on your system and the display shown in Figure 5-1 should appear.

Another option is to go to the Supermicro website at <http://www.supermicro.com/products/>. Find the product page for your motherboard here, where you may download individual drivers and utilities to your hard drive or a USB flash drive and install from there.

Note: To install the Windows OS, please refer to the instructions posted on our website at <http://www.supermicro.com/support/manuals/>.

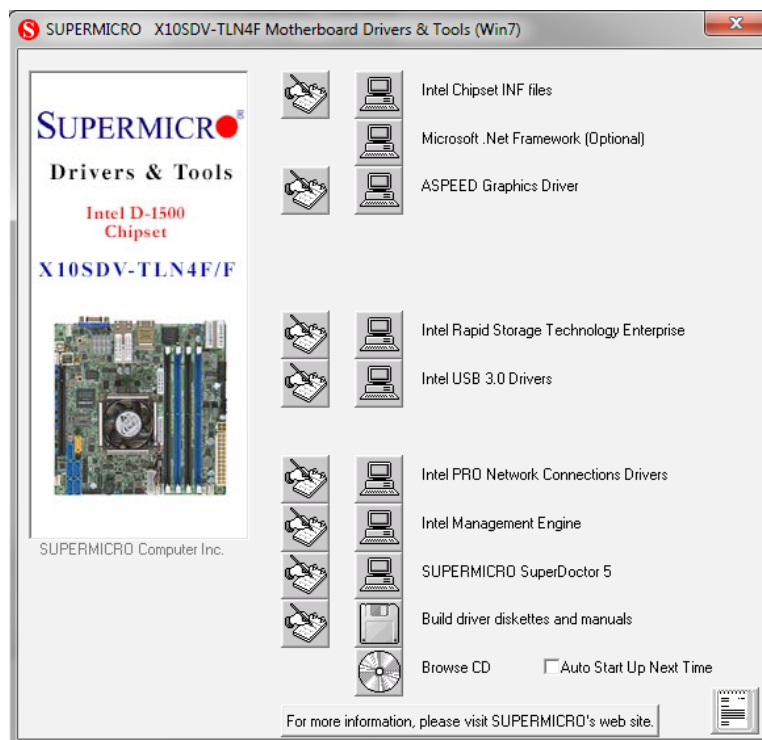

Figure 4-1. Driver & Tool Installation Screen

Note: Click the icons showing a hand writing on paper to view the readme files for each item. Click the computer icons to the right of these items to install each item (from top to the bottom) one at a time. After installing each item, you must re-boot the system before moving on to the next item on the list. The bottom icon with a CD on it allows you to view the entire contents.

4.2 SuperDoctor® 5

The Supermicro SuperDoctor 5 is a program that functions in a command-line or web-based interface for Windows and Linux operating systems. The program monitors such system health information as CPU temperature, system voltages, system power consumption, fan speed, and provides alerts via email or Simple Network Management Protocol (SNMP).

SuperDoctor 5 comes in local and remote management versions and can be used with Nagios to maximize your system monitoring needs. With SuperDoctor 5 Management Server (SSM Server), you can remotely control power on/off and reset chassis intrusion for multiple systems with SuperDoctor 5 or IPMI. SuperDoctor 5 Management Server monitors HTTP, FTP, and SMTP services to optimize the efficiency of your operation.

Note: The default User Name and Password for SuperDoctor 5 is ADMIN / ADMIN.

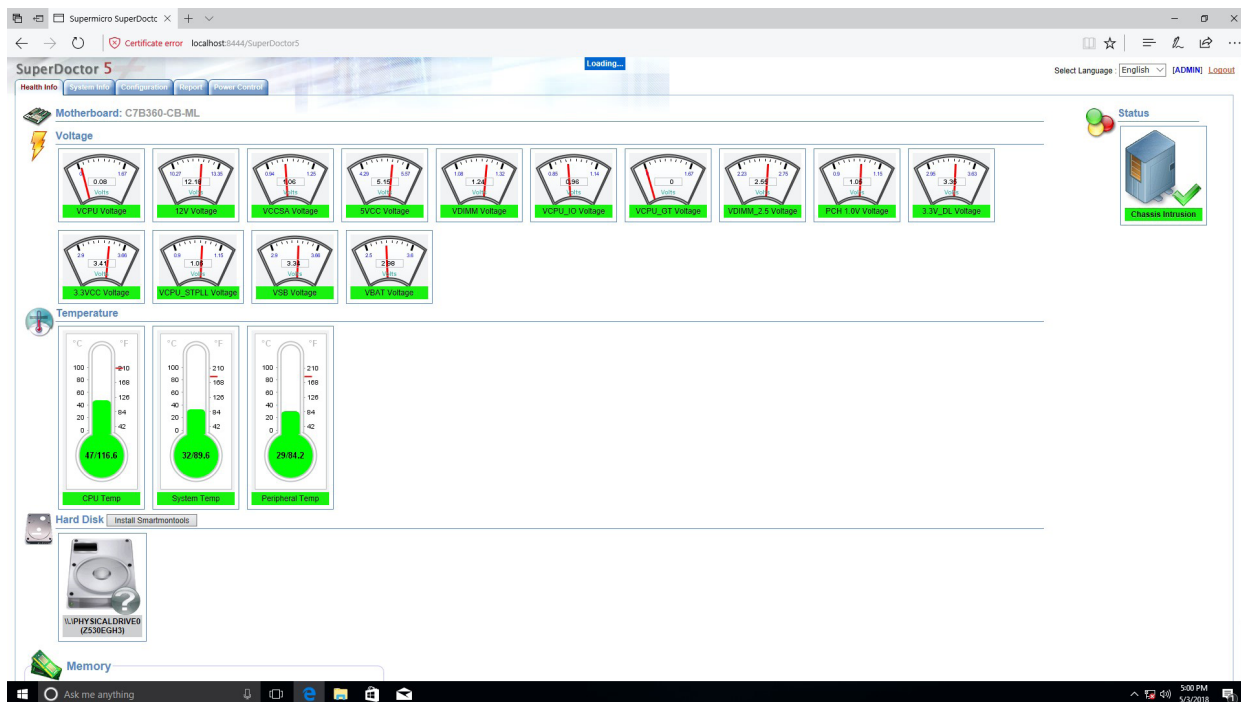

Figure 4-2. SuperDoctor 5 Interface Display Screen (Health Information)

4.3 IPMI

The X11SDV-4C-TLN2F supports the Intelligent Platform Management Interface (IPMI) v2.0. IPMI is used to provide remote access, monitoring and management. There are several BIOS settings that are related to IPMI.

For general documentation and information on IPMI, please visit our website at: <http://www.supermicro.com/products/nfo/IPMI.cfm>.

Chapter 5

BIOS

5.1 Introduction

This chapter describes the AMIBIOS™ Setup utility for the X11SDV-4C-TLN2F motherboard. The BIOS is stored on a chip and can be easily upgraded using a flash program.

Note: Due to periodic changes to the BIOS, some settings may have been added or deleted and might not yet be recorded in this manual. Please refer to the Manual Download area of our website for any changes to BIOS that may not be reflected in this manual.

Starting the Setup Utility

To enter the BIOS Setup Utility, hit the <Delete> key while the system is booting-up. (In most cases, the <Delete> key is used to invoke the BIOS setup screen. There are a few cases when other keys are used, such as <F1>, <F2>, etc.) Each main BIOS menu option is described in this manual.

The Main BIOS screen has two main frames. The left frame displays all the options that can be configured. "Grayed-out" options cannot be configured. The right frame displays the key legend. Above the key legend is an area reserved for a text message. When an option is selected in the left frame, it is highlighted in white. Often a text message will accompany it. (Note that BIOS has default text messages built in. We retain the option to include, omit, or change any of these text messages.) Settings printed in **Bold** are the default values.

A " ►" indicates a submenu. Highlighting such an item and pressing the <Enter> key will open the list of settings within that submenu.

The BIOS setup utility uses a key-based navigation system called hot keys. Most of these hot keys (<F1>, <Enter>, <ESC>, <Arrow> keys, etc.) can be used at any time during the setup navigation process.

5.2 Main Setup

When you first enter the AMI BIOS setup utility, you will enter the Main setup screen. You can always return to the Main setup screen by selecting the Main tab on the top of the screen. The Main BIOS setup screen is shown below and the following features will be displayed:

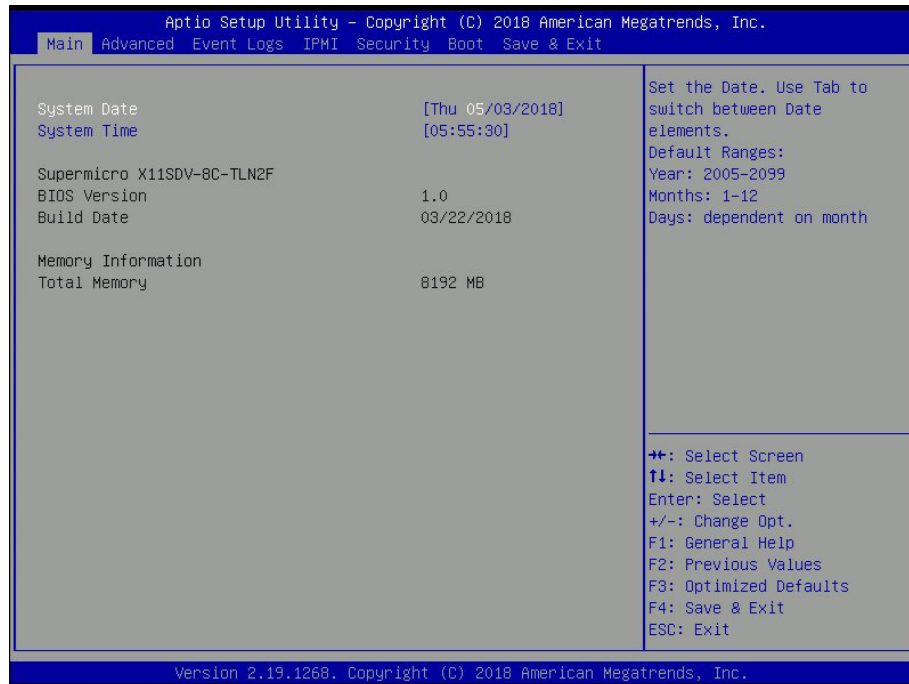

System Date/System Time

Use this option to change the system date and time. Highlight *System Date* or *System Time* using the arrow keys. Enter new values using the keyboard. Press the <Tab> key or the arrow keys to move between fields. The date must be entered in MM/DD/YYYY format. The time is entered in HH:MM:SS format.

Note: The time is in the 24-hour format. For example, 5:30 P.M. appears as 17:30:00. The date's default value is the BIOS build date after RTC reset.

Supermicro X11SDV-4C-TLN2F

BIOS Version

This feature displays the version of the BIOS ROM used in the system.

Build Date

This feature displays the date when the version of the BIOS ROM used in the system was built.

Memory Information

Total Memory

This feature displays the total size of memory available in the system.

5.3 Advanced

Use this menu to configure advanced settings.

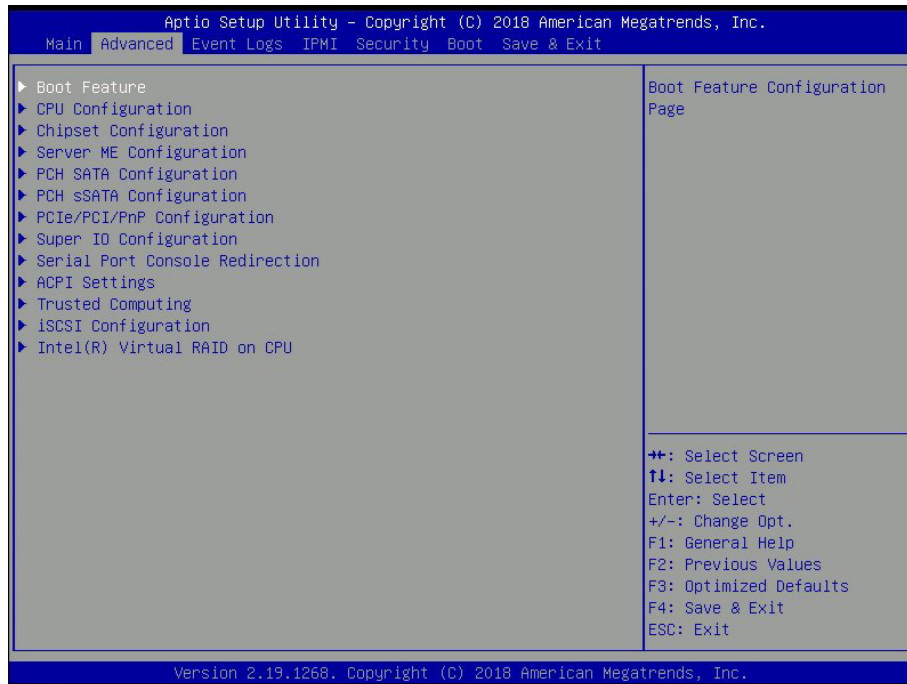

Warning: Take caution when changing the Advanced settings. An incorrect value, a very high DRAM frequency or an incorrect BIOS timing setting may cause the system to malfunction. When this occurs, restore to default manufacturer settings.

► Boot Feature

Quiet Boot

Use this feature to select the screen display between POST messages or the OEM logo at bootup. Select Disabled to display the POST messages. Select Enabled to display the OEM logo instead of the normal POST messages. The options are Disabled and **Enabled**.

Option ROM Messages

Use this feature to set the display mode for the Option ROM. The options are **Force BIOS** and Keep Current.

Bootup NumLock State

Use this feature to set the Power-on state for the Numlock key. The options are Off and **On**.

Wait For "F1" If Error

This feature forces the system to wait until the F1 key is pressed if an error occurs. The options are Disabled and **Enabled**.

INT19 Trap Response

Interrupt 19 is the software interrupt that handles the boot disk function. When this feature is set to Immediate, the ROM BIOS of the host adaptors will "capture" Interrupt 19 at bootup immediately and allow the drives that are attached to these host adaptors to function as bootable disks. If this feature is set to Postponed, the ROM BIOS of the host adaptors will not capture Interrupt 19 immediately and allow the drives attached to these adaptors to function as bootable devices at bootup. The options are **Immediate** and Postponed.

Re-try Boot

If this feature is enabled, the BIOS will automatically reboot the system from a specified boot device after its initial boot failure. The options are **Disabled** and EFI Boot.

Port 61h bit-4 Emulation

Select Enabled to enable the emulation of Port 61h bit-4 toggling in SMM (System Management Mode). The options are Disabled and **Enabled**.

Power Configuration

Watch Dog Function

If enabled, the Watch Dog timer will allow the system to reboot when it is inactive for more than five minutes. The options are **Disabled** and Enabled.

Power Button Function

This feature controls how the system shuts down when the power button is pressed. Select 4 Seconds Override for the user to power off the system after pressing and holding the power button for four seconds or longer. Select Instant Off to instantly power off the system as soon as the user presses the power button. The options are **Instant Off** and 4 Seconds Override.

Restore on AC Power Loss

Use this feature to set the power state after a power outage. Select Power Off for the system power to remain off after a power loss. Select Power On for the system power to be turned on after a power loss. Select Last State to allow the system to resume its last power state before a power loss. The options are Stay Off, Power On, and **Last State**.

►CPU Configuration

The following CPU information will display:

- Processor BSP Revision
- Processor Socket
- Processor ID
- Processor Frequency

- Processor Max Ratio
- Processor Min Ratio
- Microcode Revision
- L1 Cache RAM
- L2 Cache RAM
- L3 Cache RAM
- Processor 0 Version

Hyper-Threading (ALL)

Select Enabled to support Intel Hyper-threading Technology to enhance CPU performance. The options are Disable and **Enable**.

Cores Enabled

Set a numeric value to enable the number of cores. Refer to Intel's website for more information. Enter **0** to enable all cores.

Execute Disable Bit (Available if supported by the OS & the CPU)

Set to Enable for Execute Disable Bit support, which will allow the processor to designate areas in the system memory where an application code can execute and where it cannot, thus preventing a worm or a virus from flooding illegal codes to overwhelm the processor or damage the system during a virus attack. The options are Disable and **Enable**. Refer to Intel and Microsoft websites for more information.

Intel Virtualization Technology

Use this feature to enable the Vanderpool Technology. This technology allows the system to run several operating systems simultaneously. The options are Disable and **Enable**.

PPIN Control

Select Unlock/Enable to use the Protected Processor Inventory Number (PPIN) in the system. The options are Unlock/Disable and **Unlock/Enable**.

Hardware Prefetcher (Available when supported by the CPU)

If set to Enable, the hardware prefetcher will prefetch streams of data and instructions from the main memory to the L2 cache to improve CPU performance. The options are Disable and **Enable**.

Adjacent Cache Prefetch (Available when supported by the CPU)

The CPU prefetches the cache line for 64 bytes if this feature is set to Disabled. The CPU prefetches both cache lines for 128 bytes as comprised if this feature is set to Enable. The options are **Enable** and Disable.

DCU Streamer Prefetcher (Available when supported by the CPU)

Select Enable to enable the DCU (Data Cache Unit) Streamer Prefetcher which will stream and prefetch data and send it to the Level 1 data cache to improve data processing and system performance. The options are Disable and **Enable**.

DCU IP Prefetcher (Available when supported by the CPU)

Select Enable for DCU (Data Cache Unit) IP Prefetcher support, which will prefetch IP addresses to improve network connectivity and system performance. The options are **Enable** and Disable.

LLC Prefetch

If set to Enable, the hardware prefetcher will prefetch streams of data and instructions from the main memory to the L3 cache to improve CPU performance. The options are **Disable** and Enable.

Extended APIC

Select Enable to activate APIC (Advanced Programmable Interrupt Controller) support. The options are **Disable** and Enable.

AES-NI

Select Enable to use the Intel Advanced Encryption Standard (AES) New Instructions (NI) to ensure data security. The options are Disable and **Enable**.

► Advanced Power Management Configuration

Power Technology

This feature allows the user to configure CPU power management settings. The options are Disable, **Energy Efficient**, and Custom.

****If the feature above is set to Custom, the following features will be available for configuration:***

Power Performance Tuning

This feature allows the user to set whether the operating system or the BIOS controls the Energy Performance BIAS (EPB). The options are **OS Controls EPB** and BIOS Controls EPB.

**If the feature above is set to BIOS Controls EPB, the following features will be available for configuration:*

ENERGY_PERF_BIAS_CFG Mode

The Energy Performance BIAS (EPB) feature allows the user to configure CPU power and performance settings. Select Maximum Performance to set the highest performance. Select Performance to optimize performance over energy efficiency. Select Balanced Performance to prioritize performance optimization while conserving energy. Select Balanced Power to prioritize energy conservation while maintaining good performance. Select Power to optimize energy efficiency over performance. The options are Maximum Performance, Performance, **Balanced Performance**, Balanced Power, and Power.

► CPU P State Control

This feature allows the user to configure the following CPU power settings:

SpeedStep (Pstates)

Intel SpeedStep Technology allows the system to automatically adjust processor voltage and core frequency to reduce power consumption and heat dissipation. The options are Disable and **Enable**. This feature must be set to Enable to be able to configure the next two features.

EIST PSD Function

This feature allows the user to choose between Hardware and Software to control the processor's frequency and performance (P-state). In HW_ALL mode, the processor hardware is responsible for coordinating the P-state, and the OS is responsible for keeping the P-state request up to date on all Logical Processors. In SW_ALL mode, the OS Power Manager is responsible for coordinating the P-state, and must initiate the transition on all Logical Processors. In SW_ANY mode, the OS Power Manager is responsible for coordinating the P-state and may initiate the transition on any Logical Processors. The options are **HW_ALL**, SW_ALL, and SW_ANY.

Turbo Mode

This feature will enable dynamic control of the processor, allowing it to run above stock frequency. The options are Disable and **Enable**.

► Hardware PM State Control

Hardware P-States

This setting allows the user to select between OS and hardware-controlled P-states. Selecting Native Mode allows the OS to choose a P-state. Selecting Out of Band Mode allows the hardware to autonomously choose a P-state without OS guidance. Selecting Native Mode with No Legacy Support functions as Native Mode with no support for older hardware. The options are **Disable**, Native Mode, Out of Band Mode, and Native Mode with No Legacy Support.

► CPU C State Control

Autonomous Core C-State

Enabling this setting allows the hardware to autonomously choose to enter a C-state based on power consumption and clock speed. The options are **Disable** and Enable. This feature must be set to Disable to be able to configure the next two features.

CPU C6 Report

Select Enable to allow the BIOS to report the CPU C6 State (ACPI C3) to the operating system. During the CPU C6 State, the power to all cache is turned off. The options are Disable, Enable, and **Auto**.

Enhanced Halt State (C1E)

Select Enable to use Enhanced Halt State technology, which will significantly reduce the CPU's power consumption by reducing its clock cycle and voltage during a Halt state. The options are Disable and **Enable**.

► Package C State Control

Package C State

This feature allows the user to set the limit on the C State package register. The options are C0/C1 State, C2 State, C6 (Non Retention) State, C6 (Retention) State, No Limit, and **Auto**.

► CPU T State Control

Software Controlled T-States

Use this feature to enable Software Controlled T-States. The options are Disable and **Enable**.

► Chipset Configuration

Warning: Setting the wrong values in the sections below may cause the system to malfunction.

► North Bridge Configuration

► UPI Configuration

The following UPI information will display:

- Number of CPU
- Number of IIO
- Current UPI Link Speed
- Current UPI Link Frequency
- UPI Global MMIO Low Base / Limit
- UPI Global MMIO High Base / Limit
- UPI Pci-e Configuration Base / Size

Degrade Precedence

Use this feature to set degrade precedence when system settings are in conflict. Select Topology Precedence to degrade Features. Select Feature Precedence to degrade Topology. The options are **Topology Precedence** and Feature Precedence.

Link L0p Enable

Select Enable for the QPI to enter the L0p state for power saving. The options are Disable, Enable, and **Auto**.

Link L1 Enable

Select Enable for the QPI to enter the L1 state for power saving. The options are Disable, Enable, and **Auto**.

IO Directory Cache (IODC)

IO Directory Cache is an 8-entry cache that stores the directory state of remote IIO writes and memory lookups and saves directory updates. Use this feature to lower cache to cache (C2C) transfer latencies. The options are Disable, **Auto**, Enable for Remote InvltoM Hybrid Push, InvltoM AllocFlow, Enable for Remote InvltoM Hybrid AllocNonAlloc, and Enable for Remote InvltoM and Remote WViLF.

SNC

Sub NUMA Clustering (SNC) is a feature that breaks up the Last Level Cache (LLC) into clusters based on address range. Each cluster is connected to a subset of the memory controller. Enabling SNC improves average latency and reduces memory access congestion to achieve higher performance. Select Auto for 1-cluster or 2-clusters depending on IMC interleave. Select Enable for Full SNC (2-clusters and 1-way IMC interleave). The options are **Disable**, Enable, and Auto.

Isoc Mode

Isochronous (Isoc) mode allows time-sensitive processes to be given priority. The options are Disable, Enable, and **Auto**.

► Memory Configuration

Enforce POR

Select POR (Plan of Record) to enforce POR restrictions on DDR4 frequency and voltage programming. The options are **POR** and Disable.

Memory Frequency

Use this feature to set the maximum memory frequency for onboard memory modules. The options are **Auto**, 2133, 2400, and 2666.

Data Scrambling for DDR4

Use this feature to enable or disable data scrambling for DDR4 memory. The options are **Auto**, Disable, and Enable.

tCCD_L Relaxation

Select Auto to get TCDD settings from SPD (Serial Presence Detect) into memory RC code to improve system reliability. Select Disable for TCCD to follow Intel POR. The options are Disable and **Auto**.

2X REFRESH

Use this feature to select the memory controller refresh rate to 2x refresh mode. The options are **Auto** and Enable.

► Memory Topology

This feature displays the information of onboard memory modules detected by the BIOS.

► Memory RAS Configuration

Static Virtual Lockstep Mode

Select Enable to run the system's memory channels in lockstep mode to minimize memory access latency. The options are **Disable** and Enable.

Mirror Mode

This feature allows memory to be mirrored between two channels, providing 100% redundancy. The options are **Disable**, Mirror Mode 1LM, and Mirror Mode 2LM.

Memory Rank Sparing

Select Enable to enable memory-sparing support for memory ranks to improve memory performance. The options are **Disable** and Enable.

****If the feature above is set to Enable, Multi Rank Sparing will be available for configuration:***

Multi Rank Sparing

Use this feature to indicate how many memory ranks to reserve in case of memory failure. The options are One Rank and **Two Rank**.

Correctable Error Threshold

Use this feature to specify the threshold value for correctable memory error logging, which sets a limit on the maximum number of events that can be logged in the memory error log at a given time. The default setting is **100**.

SDDC

Single device data correction +1 (SDDC Plus One) organizes data in a single bundle (x4/x8 DRAM). If any or all of the bits become corrupted, corrections occur. The x4 condition is corrected on all cases. The x8 condition is corrected only if the system is in Lockstep Mode. The options are **Disable** and Enable.

ADDDC Sparing

Adaptive Double Device Data Correction (ADDDC) Sparing detects when the predetermined threshold for correctable errors is reached, copying the contents of the failing DIMM to spare memory. The failing DIMM or memory rank will then be disabled. The options are **Disable** and Enable.

Patrol Scrub

Patrol Scrub is a process that allows the CPU to correct correctable memory errors detected on a memory module and send the correction to the requestor (the original source). When this feature is set to Enable, the IO hub will read and write back one cache line every 16K cycles if there is no delay caused by internal processing. By using this method, roughly 64 GB of memory behind the IO hub will be scrubbed every day. The options are Disable and **Enable**.

****If the feature above is set to Enable, Patrol Scrub Interval will be available for configuration:***

Patrol Scrub Interval

This feature allows you to decide how many hours the system should wait before the next complete patrol scrub is performed. Use the keyboard to enter a value from 0-24. The default setting is **24**.

► IIO Configuration

EV DFX Features

When this feature is set to Enable, the EV_DFX Lock Bits that are located on a processor will always remain clear during electric tuning. The options are **Disable** and Enable.

► CPU Configuration

IOU0 (IIO PCIe Br1)

Use this feature to configure the PCI-E port Bifuraction setting for a PCI-E port specified by the user. The options are x4x4x4x4, x4x4x8, x8x4x4, x8x8, x16, and **Auto**.

IOU1 (IIO PCIe Br2)

Use this feature to configure the PCI-E port Bifuraction setting for a PCI-E port specified by the user. The options are x4x4x4x4, x4x4x8, x8x4x4, x8x8, x16, and **Auto**.

IOU2 (IIO PCIe Br3)

Use this feature to configure the PCI-E port Bifuraction setting for a PCI-E port specified by the user. The options are x4x4x4x4, x4x4x8, x8x4x4, x8x8, x16, and **Auto**.

► CPU SLOT7 PCI-E 3.0 X8

Link Speed

Use this feature to select the link speed for this port. The options are **Auto**, Gen 1 (2.5 GT/s), Gen 2 (5GT/s), and Gen 3 (GT/s).

PCI-E Port Link Status

This feature shows the status of the device plugged into this slot.

PCI-E Port Link Max

This feature shows the status of the device plugged into this slot.

PCI-E Port Link Speed

This feature shows the status of the device plugged into this slot.

PCI-E Port Max Payload Size

Use this feature to select the maximum payload size for this port. The options are 128B, 256B, and **Auto**.

► IOAT Configuration**Disable TPH**

Transparent Huge Pages (TPH) is a Linux memory management system that enables communication in larger blocks (pages). Enabling this feature will increase performance. The options are **No** and Yes.

****If the feature above is set to No, Relax Ordering will be available for configuration:***

Prioritize TPH

Use this feature to enable Prioritize TPH support. The options are Enable and **Disable**.

Relaxed Ordering

Select Enable to enable Relaxed Ordering support, which will allow certain transactions to violate the strict-ordering rules of PCI bus for a transaction to be completed prior to other transactions that have already been queued. The options are **Disable** and Enable.

► Intel® VT for Directed I/O (VT-d)**Intel® VT for Directed I/O (VT-d)**

Select Enable to use Intel Virtualization Technology for Direct I/O VT-d support by reporting the I/O device assignments to the VMM (Virtual Machine Monitor) through the DMAR ACPI tables. This feature offers fully-protected I/O resource sharing across Intel platforms, providing greater reliability, security, and availability in networking and data-sharing. The options are **Enable** and Disable.

If the feature above is set to **Enable, the five features below will be available for configuration:*

Interrupt Remapping

Use this feature to enable Interrupt Remapping support, which detects and controls external interrupt requests. The options are **Enable** and **Disable**.

PassThrough DMA

Use this feature to allow devices such as network cards to access the system memory without using a processor. Select **Enable** to use the Non-Isoch VT-d Engine Pass Through Direct Memory Access (DMA) support. The options are **Enable** and **Disable**.

ATS

Use this feature to enable Non-Isoch VT-d Engine Address Translation Services (ATS) support. ATS translates virtual addresses to physical addresses. The options are **Enable** and **Disable**.

Posted Interrupt

Use this feature to enable VT-d Posted Interrupt. The options are **Enable** and **Disable**.

Coherency Support (Non-Isoch)

Use this feature to maintain setting coherency between processors or other devices. Select **Enable** for the Non-Isoch VT-d engine to pass through DMA to enhance system performance. The options are **Enable** and **Disable**.

PCI-E Completion Timeout Disable

Use this feature to enable PCI-E Completion Timeout support for electric tuning. The options are **Yes**, **No**, and **Per-Port**.

►South Bridge Configuration

The following South Bridge information will display:

- USB Module Version
- USB Devices

Legacy USB Support

Select **Enabled** to support onboard legacy USB devices. Select **Auto** to disable legacy support if there are no legacy USB devices present. Select **Disable** to have all USB devices available for EFI applications only. The options are **Enabled**, **Disabled**, and **Auto**.

XHCI Hand-off

This is a work-around solution for operating systems that do not support XHCI (Extensible Host Controller Interface) hand-off. The XHCI ownership change should be claimed by the XHCI driver. The settings are **Enabled** and Disabled.

Port 60/64 Emulation

Select Enabled for I/O port 60h/64h emulation support, which in turn will provide complete legacy USB keyboard support for the operating systems that do not support legacy USB devices. The options are Disabled and **Enabled**.

► Server ME Configuration

- General ME Configuration
- Oper. Firmware Version
- Backup Firmware Version
- Recovery Firmware Version
- ME Firmware Status #1
- ME Firmware Status #2
- Current State
- Error Code

► PCH SATA Configuration

When this submenu is selected, the AMI BIOS automatically detects the presence of the SATA devices that are supported by the Intel PCH chip and displays the following features:

SATA Controller

This feature enables or disables the onboard SATA controller supported by the Intel PCH chip. The options are Disable and **Enable**.

Configure SATA as

Select AHCI to configure a SATA drive specified by the user as an AHCI drive. Select RAID to configure a SATA drive specified by the user as a RAID drive. The options are **AHCI** and RAID.

SATA HDD Unlock

This feature allows the user to remove any password-protected SATA disk drives. The options are **Enable** and Disable.

Aggressive Link Power Management

When this feature is set to Enable, the SATA AHCI controller manages the power usage of the SATA link. The controller will put the link in a low power mode during extended periods of I/O inactivity, and will return the link to an active state when I/O activity resumes. The options are **Disable** and Enable.

****If the feature "Configure SATA as" above is set to RAID, the next two features will be available for configuration:***

SATA RSTe Boot Info

Select Enable to provide full int13h support for the devices attached to SATA controller. The options are Disable and **Enable**.

SATA RAID Option ROM/UEFI Driver

Select UEFI to load the EFI driver for system boot. Select Legacy to load a legacy driver for system boot. The options are Disable, EFI, and **Legacy**.

SATA Port 0~7

This feature displays the information detected on the installed SATA drive on the particular SATA port.

- Model number of drive and capacity
- Software Preserve Support

Port 0~7 Hot Plug

Set this feature to Enable for hot plug support, which will allow the user to replace a SATA drive without shutting down the system. The options are Disable and **Enable**.

Port 0~7 Spin Up Device

Set this feature to enable or disable the PCH to initialize the device. The options are **Disable** and Enable.

Port 0~7 SATA Device Type

Use this feature to specify if the SATA port specified by the user should be connected to a Solid State Drive or a Hard Disk Drive. The options are **Hard Disk Drive** and Solid State Drive.

►PCH sSATA Configuration

When this submenu is selected, the AMI BIOS automatically detects the presence of the SATA devices that are supported by the Intel PCH chip and displays the following features:

sSATA Controller

This feature enables or disables the onboard sSATA controller supported by the Intel PCH chip. The options are **Enable** and Disable.

Configure sSATA as

Select AHCI to configure an sSATA drive specified by the user as an AHCI drive. Select RAID to configure an sSATA drive specified by the user as a RAID drive. The options are **AHCI** and RAID.

SATA HDD Unlock

This feature allows the user to remove any password-protected SATA disk drives. The options are Disable and **Enable**.

Aggressive Link Power Management

When this feature is set to Enable, the SATA AHCI controller manages the power usage of the SATA link. The controller will put the link in a low power mode during extended periods of I/O inactivity and will return the link to an active state when I/O activity resumes. The options are **Disable** and Enable.

****If the feature "Configure sSATA as" above is set to RAID, the next two features will be available for configuration:***

sSATA RSTe Boot Info

Select Enable to provide full int13h support for the devices attached to sSATA controller. The options are Disable and **Enable**.

sSATA RAID Option ROM/UEFI Driver

Select UEFI to load the EFI driver for system boot. Select Legacy to load a legacy driver for system boot. The options are Disable, EFI, and **Legacy**.

sSATA Port 0 ~ Port 5

This feature displays the information detected on the installed sSATA drive on the particular sSATA port.

- Model number of drive and capacity
- Software Preserve Support

Port 0 ~ Port 5 Hot Plug

Set this feature to Enable for hot plug support, which will allow the user to replace a SATA drive without shutting down the system. The options are Disable and **Enable**.

Port 0 ~ Port 5 Spin Up Device

Set this feature to enable or disable the PCH to initialize the device. The options are **Disable** and Enable.

Port 0 ~ Port 5 sSATA Device Type

Use this feature to specify if the SATA port specified by the user should be connected to a Solid State Drive or a Hard Disk Drive. The options are **Hard Disk Drive** and Solid State Drive.

►PCIe/PCI/PnP Configuration

The following information will display:

- PCI Bus Driver Version
- PCI Devices Common Settings:

Above 4G Decoding (Available if the system supports 64-bit PCI decoding)

Select Enabled to decode a PCI device that supports 64-bit in the space above 4G Address. The options are Disabled and **Enabled**.

SR-IOV Support

Use this feature to enable or disable Single Root IO Virtualization Support. The options are **Disabled** and Enabled.

MMIO High Base

Use this feature to select the base memory size according to memory-address mapping for the IO hub. The options are **56T**, 40T, 24T, 16T, 4T, and 1T.

MMIO High Granularity Size

Use this feature to select the high memory size according to memory-address mapping for the IO hub. The options are 1G, 4G, 16G, 64G, **256G**, and 1024G.

Maximum Read Request

Use this feature to select the Maximum Read Request size of the PCI-Express device, or select Auto to allow the System BIOS to determine the value. The options are **Auto**, 128 Bytes, 256 Bytes, 512 Bytes, 1024 Bytes, 2048 Bytes, and 4096 Bytes.

MMCFG Base

Use this feature to select the low base address for PCI-E adapters to increase base memory. The options are 1G, 1.5G, 1.75G, **2G**, 2.25G, and 3G.

NVMe Firmware Source

Use this feature to select the NVMe firmware to support booting. The default option, Vendor Defined Firmware, is pre-installed on the drive and may resolve errata or enable innovative functions for the drive. The other option, AMI Native Support, is offered by the BIOS with a generic method. The options are **Vendor Defined Firmware** and AMI Native Support.

VGA Priority

Use this feature to select VGA priority when multiple VGA devices are detected. Select Onboard to give priority to your onboard video device. Select Offboard to give priority to your graphics card. The options are **Onboard** and Offboard.

CPU SLOT7 PCI-E 3.0 X8 OPROM

Use this feature to select which firmware type to be loaded for the add-on card in this slot. The options are Disabled, **Legacy**, and EFI.

Onboard LAN Option ROM Type

Use this feature to select which firmware type to be loaded for onboard LAN devices. The options **Legacy** and EFI. Select Legacy to display and configure the Onboard LAN1 ~ LAN8 Option ROM features.

Onboard LAN1 Option ROM

Use this feature to select which firmware function to be loaded for LAN Port1 used for system boot. The options are Disabled and **Legacy**.

Onboard LAN2 Option ROM

Use this feature to select which firmware function to be loaded for LAN Port2 used for system boot. The options are Disabled and **Legacy**.

Onboard Video Option ROM

Use this feature to select the Onboard Video Option ROM type. The options are Disabled, **Legacy**, and EFI.

► Network Stack Configuration

Network Stack

Select Enabled to enable PXE (Preboot Execution Environment) or UEFI (Unified Extensible Firmware Interface) for network stack support. The options are **Enabled** and Disabled.

****If the feature above is set to Enabled, the next six features will be available for configuration:***

Ipv4 PXE Support

Select Enabled to enable IPv4 PXE boot support. The options are Disabled and **Enabled**.

Ipv4 HTTP Support

Select Enabled to enable IPv4 HTTP boot support. The options are **Disabled** and Enabled.

Ipv6 PXE Support

Select Enabled to enable IPv6 PXE boot support. The options are Disabled and **Enabled**.

Ipv6 HTTP Support

Select Enabled to enable IPv6 HTTP boot support. The options are **Disabled** and Enabled.

PXE boot Wait Time

Use this option to specify the wait time to press the ESC key to abort the PXE boot. Press "+" or "-" on your keyboard to change the value. The default setting is **0**.

Media detect count

Use this option to specify the number of times media will be checked. Press "+" or "-" on your keyboard to change the value. The default setting is **1**.

► Super IO Configuration

Super IO Chip AST2500

► Serial Port 1 Configuration

Serial Port 1

Select Enabled to enable the onboard serial port specified by the user. The options are **Enabled** and Disabled. Enable this feature for the next two features to display and only the Change Settings feature is available for configuration.

Device Settings

This feature displays the base I/O port address and the Interrupt Request address of a serial port specified by the user.

Change Settings

This feature specifies the base I/O port address and the Interrupt Request address of Serial Port 1. Select **Auto** for the BIOS to automatically assign the base I/O and IRQ address to a serial port specified. The options are **Auto**, (IO=3F8h; IRQ=4), (IO=3F8h; IRQ=3, 4, 5, 6, 7, 9, 10, 11, 12), (IO=2F8h; IRQ=3, 4, 5, 6, 7, 9, 10, 11, 12); (IO=3E8h; IRQ=3, 4, 5, 6, 7, 9, 10, 11, 12), and (IO=2E8h; IRQ=3, 4, 5, 6, 7, 9, 10, 11, 12).

► Serial Port 2 Configuration

Serial Port 2

Select Enabled to enable the onboard serial port specified by the user. The options are **Enabled** and Disabled. Enable this feature for the next two features to display and only the Change Settings feature is available for configuration.

Device Settings

This feature displays the base I/O port address and the Interrupt Request address of a serial port specified by the user.

Change Settings

This feature specifies the base I/O port address and the Interrupt Request address of Serial Port 1. Select **Auto** for the BIOS to automatically assign the base I/O and IRQ address to a serial port specified. The options are **Auto**, (IO=2F8h; IRQ=3), (IO=3F8h; IRQ=3, 4, 5, 6, 7, 9, 10, 11, 12), (IO=2F8h; IRQ=3, 4, 5, 6, 7, 9, 10, 11, 12); (IO=3E8h; IRQ=3, 4, 5, 6, 7, 9, 10, 11, 12), and (IO=2E8h; IRQ=3, 4, 5, 6, 7, 9, 10, 11, 12).

►Serial Port Console Redirection

COM1

Console Redirection

Select Enabled to enable COM Port 1 for Console Redirection, which will allow a client machine to be connected to a host machine at a remote site for networking. The options are **Disabled** and Enabled.

****If the feature above is set to Enabled, the following features will become available for configuration:***

►Console Redirection Settings

Terminal Type

This feature allows the user to select the target terminal emulation type for Console Redirection. Select VT100 to use the ASCII Character set. Select VT100+ to add color and function key support. Select ANSI to use the Extended ASCII Character Set. Select VT-UTF8 to use UTF8 encoding to map Unicode characters into one or more bytes. The options are VT100, **VT100+**, VT-UTF8, and ANSI.

Bits per second

Use this feature to set the transmission speed for a serial port used in Console Redirection. Make sure that the same speed is used in the host computer and the client computer. A lower transmission speed may be required for long and busy lines. The options are 9600, 19200, 38400, 57600, and **115200** (bits per second).

Data Bits

Use this feature to set the data transmission size for Console Redirection. The options are 7 and **8**.

Parity

A parity bit can be sent along with regular data bits to detect data transmission errors. Select Even if the parity bit is set to 0, and the number of 1's in data bits is even. Select Odd if the parity bit is set to 0, and the number of 1's in data bits is odd. Select None if you do not want to send a parity bit with your data bits in transmission. Select Mark to add a mark as a parity bit to be sent along with the data bits. Select Space to add a Space as a parity bit to be sent with your data bits. The options are **None**, Even, Odd, Mark, and Space.

Stop Bits

A stop bit indicates the end of a serial data packet. Select 1 Stop Bit for standard serial data communication. Select 2 Stop Bits if slower devices are used. The options are **1** and **2**.

Flow Control

Use this feature to set the flow control for Console Redirection to prevent data loss caused by buffer overflow. Send a "Stop" signal to stop sending data when the receiving buffer is full. Send a "Start" signal to start sending data when the receiving buffer is empty. The options are **None** and Hardware RTS/CTS.

VT-UTF8 Combo Key Support

Select Enabled to enable VT-UTF8 Combination Key support for ANSI/VT100 terminals. The options are Disabled and **Enabled**.

Recorder Mode

Select Enabled to capture the data displayed on a terminal and send it as text messages to a remote server. The options are **Disabled** and Enabled.

Resolution 100x31

Select Enabled for extended-terminal resolution support. The options are Disabled and **Enabled**.

Legacy OS Redirection Resolution

Use this feature to select the number of rows and columns used in Console Redirection for legacy OS support. The options are **80x24** and 80x25.

Putty KeyPad

This feature selects Function Keys and KeyPad settings for Putty, which is a terminal emulator designed for the Windows OS. The options are **VT100**, LINUX, XTERMR6, SCO, ESCN, and VT400.

Redirection After BIOS POST

Use this feature to enable or disable legacy console redirection after BIOS POST. When set to BootLoader, legacy console redirection is disabled before booting the OS. When set to Always Enable, legacy console redirection remains enabled when booting the OS. The options are **Always Enable** and BootLoader.

SOL Console Redirection

Select Enabled to use the SOL port for Console Redirection. The options are Disabled and Enabled.

**If the feature above is set to Enabled, the following features are available for configuration:*

► Console Redirection Settings

Use this feature to specify how the host computer will exchange data with the client computer, which is the remote computer used by the user.

SOL

Terminal Type

Use this feature to select the target terminal emulation type for Console Redirection. Select VT100 to use the ASCII Character set. Select VT100+ to add color and function key support. Select ANSI to use the Extended ASCII Character Set. Select VT-UTF8 to use UTF8 encoding to map Unicode characters into one or more bytes. The options are VT100, **VT100+**, VT-UTF8, and ANSI.

Bits per second

Use this feature to set the transmission speed for a serial port used in Console Redirection. Make sure that the same speed is used in the host computer and the client computer. A lower transmission speed may be required for long and busy lines. The options are 9600, 19200, 38400, 57600, and **115200** (bits per second).

Data Bits

Use this feature to set the data transmission size for Console Redirection. The options are 7 and 8.

Parity

A parity bit can be sent along with regular data bits to detect data transmission errors. Select Even if the parity bit is set to 0, and the number of 1's in data bits is even. Select Odd if the parity bit is set to 0, and the number of 1's in data bits is odd. Select None if you do not want to send a parity bit with your data bits in transmission. Select Mark to add a mark as a parity bit to be sent along with the data bits. Select Space to add a Space as a parity bit to be sent with your data bits. The options are **None**, Even, Odd, Mark and Space.

Stop Bits

A stop bit indicates the end of a serial data packet. Select 1 Stop Bit for standard serial data communication. Select 2 Stop Bits if slower devices are used. The options are 1 and 2.

Flow Control

Use this feature to set the flow control for Console Redirection to prevent data loss caused by buffer overflow. Send a "Stop" signal to stop sending data when the receiving buffer is full. Send a "Start" signal to start sending data when the receiving buffer is empty. The options are **None** and Hardware RTS/CTS.

VT-UTF8 Combo Key Support

Select Enabled to enable VT-UTF8 Combination Key support for ANSI/VT100 terminals. The options are Disabled and **Enabled**.

Recorder Mode

Select Enabled to capture the data displayed on a terminal and send it as text messages to a remote server. The options are **Disabled** and Enabled.

Resolution 100x31

Select Enabled for extended-terminal resolution support. The options are Disabled and **Enabled**.

Legacy OS Redirection Resolution

Use this feature to select the number of rows and columns used in Console Redirection for legacy OS support. The options are **80x24** and 80x25.

Putty KeyPad

This feature selects Function Keys and KeyPad settings for Putty, which is a terminal emulator designed for the Windows OS. The options are **VT100**, LINUX, XTERMR6, SCO, ESCN, and VT400.

Redirection After BIOS POST

Use this feature to enable or disable legacy console redirection after BIOS POST. When set to BootLoader, legacy console redirection is disabled before booting the OS. When set to Always Enable, legacy console redirection remains enabled when booting the OS. The options are **Always Enable** and BootLoader.

Legacy Console Redirection

Redirection COM Port

Use this feature to select a COM port to display redirection of Legacy OS and Legacy OPROM messages. The options are **COM1** and SOL.

Serial Port for Out-of-Band Management/Windows Emergency Management Services (EMS)

This submenu allows the user to configure Console Redirection settings to support Out-of-Band Serial Port management.

Console Redirection

Select Enabled to use a COM port selected by the user for EMS Console Redirection. The options are **Disabled** and Enabled.

**If the feature above is set to Enabled, the following features are available for configuration:*

► Console Redirection Settings

This feature allows the user to specify how the host computer will exchange data with the client computer, which is the remote computer used by the user.

Out-of-Band Mgmt Port

The feature selects a serial port in a client server to be used by the Microsoft Windows Emergency Management Services (EMS) to communicate with a remote host server. The options are **COM1** and SOL.

Terminal Type

Use this feature to select the target terminal emulation type for Console Redirection. Select VT100 to use the ASCII character set. Select VT100+ to add color and function key support. Select ANSI to use the extended ASCII character set. Select VT-UTF8 to use UTF8 encoding to map Unicode characters into one or more bytes. The options are VT100, VT100+, **VT-UTF8**, and ANSI.

Bits per second

This feature sets the transmission speed for a serial port used in Console Redirection. Make sure that the same speed is used in the host computer and the client computer. A lower transmission speed may be required for long and busy lines. The options are 9600, 19200, 57600, and **115200** (bits per second).

Flow Control

Use this feature to set the flow control for Console Redirection to prevent data loss caused by buffer overflow. Send a "Stop" signal to stop sending data when the receiving buffer is full. Send a "Start" signal to start sending data when the receiving buffer is empty. The options are **None**, Hardware RTS/CTS, and Software Xon/Xoff.

Data Bits

Parity

Stop Bits

►ACPI Settings

Use this feature to configure Advanced Configuration and Power Interface (ACPI) power management settings for your system.

WHEA Support

Select Enabled to support the Windows Hardware Error Architecture (WHEA) platform and provide a common infrastructure for the system to handle hardware errors within the Windows OS environment in order to reduce system crashes and enhance system recovery and health monitoring. The options are Disabled and **Enabled**.

High Precision Event Timer

Select Enabled to activate the High Precision Event Timer (HPET) that produces periodic interrupts at a much higher frequency than a Real-time Clock (RTC) does in synchronizing multimedia streams, providing smooth playback and reducing the dependency on other timestamp calculation devices, such as an x86 RDTSC Instruction embedded in the CPU. The High Performance Event Timer is used to replace the 8254 Programmable Interval Timer. The options are Disabled and **Enabled**.

►Trusted Computing

The following features are displayed if a TPM 1.2 module is detected:

Configuration

Security Device Support

If this feature and the TPM jumper on the motherboard are both set to Enabled, onboard security devices will be enabled for TPM support to enhance data integrity and network security. Reboot the system for a change on this setting to take effect. The options are Disable and **Enable**.

TPM State

Select Enabled to use TPM (Trusted Platform Module) settings to enhance system data security. Reboot your system for any change on the TPM state to take effect. The options are Disabled and **Enabled**.

Pending Operation

Use this feature to schedule a TPM-related operation to be performed by a security device for system data integrity. The options are **None** and TPM Clear.

Note: Your system will reboot to carry out a pending TPM operation.

Current Status Information

This feature displays the status of the TPM support on this motherboard.

- TPM Enabled Status
- TPM Active Status
- TPM Owner Status

SMCI BIOS-Based TPM Provision Support

Use feature to enable the Supermicro TPM Provision support. The options are Disabled and **Enabled**.

TXT Support

Intel TXT (Trusted Execution Technology) helps protect against software-based attacks and ensures protection, confidentiality, and integrity of data stored or created on the system. Use this feature to enable or disable TXT Support. The options are **Disabled** and Enabled.

**The following features are displayed if a TPM 2.0 module is detected:*

TPM20 Device Found

Vendor: IFX

Firmware Version: 7.62

Security Device Support

If this feature and the TPM jumper on the motherboard are both set to Enabled, onboard security devices will be enabled for TPM support to enhance data integrity and network security. Please reboot the system for a change on this setting to take effect. The options are Disable and **Enable**.

The following TPM information will be displayed:

- Active PCR banks
- Available PCR banks

**If the feature "Security Device Support" is enabled, the following features are available for configuration:*

SHA256 PCR Bank

Use this feature to disable or enable the SHA256 Platform Configuration Register (PCR) bank for the installed TPM device. The options are Disabled and **Enabled**.

Pending Operation

Use this feature to schedule a TPM-related operation to be performed by a security device for system data integrity. Your system will reboot to carry out a pending TPM operation. The options are **None** and TPM Clear.

Platform Hierarchy

Use this feature to disable or enable platform hierarchy for platform protection. The options are Disabled and **Enabled**.

Storage Hierarchy

Use this feature to disable or enable storage hierarchy for cryptographic protection. The options are Disabled and **Enabled**.

Endorsement Hierarchy

Use this feature to disable or enable endorsement hierarchy for privacy control. The options are Disabled and **Enabled**.

PH Randomization

Use this feature to disable or enable Platform Hierarchy (PH) Randomization. The options are **Disabled** and Enabled.

SMCI BIOS-Based TPM Provision Support

Use feature to enable the Supermicro TPM Provision support. The options are **Disabled** and Enabled.

TXT Support

Intel TXT (Trusted Execution Technology) helps protect against software-based attacks and ensures protection, confidentiality and integrity of data stored or created on the system. Use this feature to enable or disable TXT Support. The options are **Disabled** and Enabled.

► iSCSI Configuration

iSCSI Initiator Name

This feature allows the user to enter the unique name of the iSCSI Initiator in IQN format. Once the name of the iSCSI Initiator is entered into the system, configure the proper settings for the following features.

► **Add an Attempt**

► **Delete Attempts**

► **Change Attempt Order**

► Intel(R) Virtual RAID on CPU

Intel(R) VROC with VMD Technology 5.2.4.1000

RAID volume and Intel VMD Controller information will be displayed if they are detected by the system.

5.4 Event Logs

Use this menu to configure event log settings.

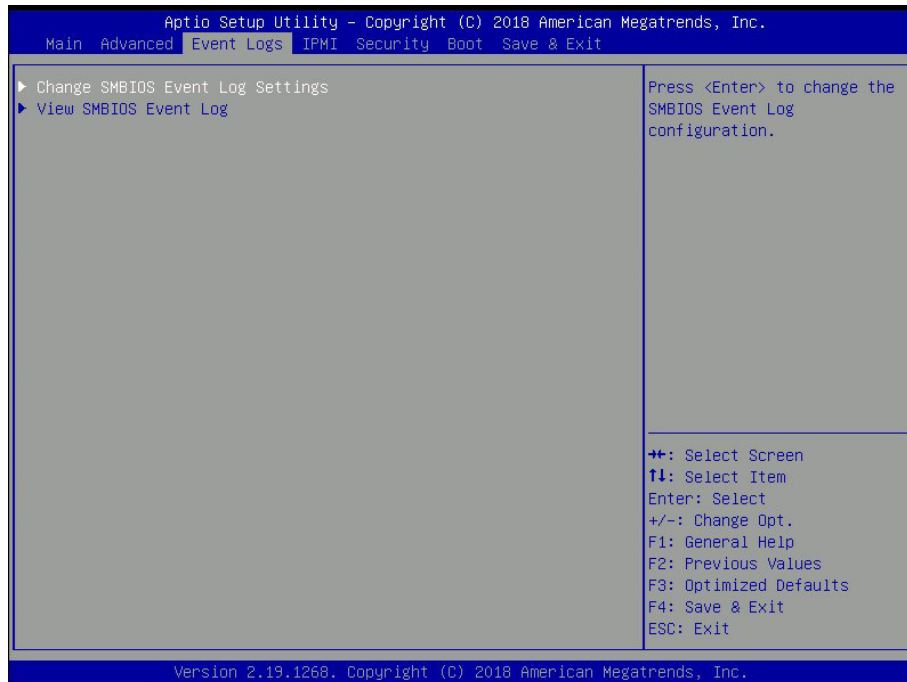

► Change SMBIOS Event Log Settings

Enabling/Disabling Options

SMBIOS Event Log

Change this feature to enable or disable all features of the SMBIOS Event Logging during system boot. The options are **Enabled** and Disabled.

Erasing Settings

Erase Event Log

Select Enabled to erase all error events in the SMBIOS (System Management BIOS) log before an event logging is initialized at bootup. The options are **No**, "Yes, Next reset," and "Yes, Every reset."

When Log is Full

Select Erase Immediately to immediately erase all errors in the SMBIOS event log when the event log is full. Select Do Nothing for the system to do nothing when the SMBIOS event log is full. The options are **Do Nothing** and Erase Immediately.

SMBIOS Event Log Standard Settings

Log System Boot Event

Select Enabled to log system boot events. The options are Enabled and **Disabled**.

MECI (Multiple Event Count Increment)

Enter the increment value for the multiple event counter. Enter a number between 1 to 255. The default setting is **1**.

METW (Multiple Event Count Time Window)

This feature is used to determine how long (in minutes) the multiple event counter should wait before generating a new event log. Enter a number between 0 to 99. The default setting is **60**.

Note: Reboot the system for the changes to take effect.

►View SMBIOS Event Log

This feature allows the user to view the event in the SMBIOS event log. The following categories are displayed:

DATE/TIME/ERROR CODE/SEVERITY

5.5 IPMI

Use this menu to configure Intelligent Platform Management Interface (IPMI) settings.



BMC Firmware Revision

This feature displays the IPMI firmware revision used in your system.

IPMI STATUS

This feature displays the status of the IPMI firmware installed in your system.

▶ System Event Log

Enabling/Disabling Options

SEL Components

Select Enabled for all system event logging at bootup. The options are Disabled and Enabled.

Erasing Settings

Erase SEL

Select Yes, On next reset to erase all system event logs upon next system reboot. Select Yes, On every reset to erase all system event logs upon each system reboot. Select No to keep all system event logs after each system reboot. The options are **No**, "Yes, On next reset," and "Yes, On every reset."

When SEL is Full

This feature allows the user to determine what the BIOS should do when the system event log is full. Select Erase Immediately to erase all events in the log when the system event log is full. The options are **Do Nothing** and Erase Immediately.

Note: Reboot the system for the changes to take effect.

► BMC Network Configuration

BMC network configuration

Configure IPV4 support

IPMI LAN Selection

This feature displays the IPMI LAN setting. The default setting is **Failover**.

IPMI Network Link Status

This feature displays the IPMI Network Link status. The default setting is **Dedicated LAN**.

Update IPMI LAN Configuration

Select Yes for the BIOS to implement all IP/MAC address changes at the next system boot. The options are **No** and Yes.

****If the feature above is set to Yes, the Configuration Address Source and VLAN features are available for configuration:***

Configuration Address Source

Use this feature to select the source of the IP address for this computer. If Static is selected, you will need to know the IP address of this computer and enter it to the system manually in the field. If DHCP is selected, the BIOS will search for a DHCP (Dynamic Host Configuration Protocol) server in the network that is attached to and request the next available IP address for this computer. The options are **DHCP** and Static.

****If the feature above is set to Static, the Station IP Address/Subnet Mask/Gateway IP Address features are available for configuration:***

Station IP Address

This feature displays the Station IP address for this computer. This should be in decimal and in dotted quad form (i.e., 192.168.10.253).

Subnet Mask

This feature displays the sub-network that this computer belongs to. The value of each three-digit number separated by dots should not exceed 255.

Station MAC Address

This feature displays the Station MAC address for this computer. Mac addresses are 6 two-digit hexadecimal numbers.

Gateway IP Address

This feature displays the Gateway IP address for this computer. This should be in decimal and in dotted quad form (i.e., 192.168.10.253).

VLAN

This feature is configurable if the Update IPMI LAN Configuration feature is set to Yes. Use this feature to enable or disable the IPMI VLAN function. The options are **Disable** and **Enable**.

****If the feature above is set to Enabled, the VLAN ID feature below is available for configuration:***

VLAN ID

Use this feature to select a value for VLAN ID.

Configure IPV6 support**IPV6 Support**

Use this feature to enable IPV6 support. The options are **Enabled** and **Disabled**.

Configuration Address Source

Use this feature to select the source of the IP address for this computer. If Static is selected, you will need to know the IP address of this computer and enter it to the system manually in the field. If DHCP is selected, the BIOS will search for a DHCP (Dynamic Host Configuration Protocol) server in the network that is attached to and request the next available IP address for this computer. The options are Unspecified, Static, and **DHCP**.

****If the feature above is set to Static, the Station IP Address/Prefix Length/IPV6 Router1 IP Address features are available for configuration:***

Station IPV6 Address

Use this feature to enter the IPV6 address.

Prefix Length

Use this feature to change the prefix length.

IPV6 Router1 IP Address

Use this feature to change the IPV6 Router1 IP address.

5.6 Security

Use this menu to configure the security settings.

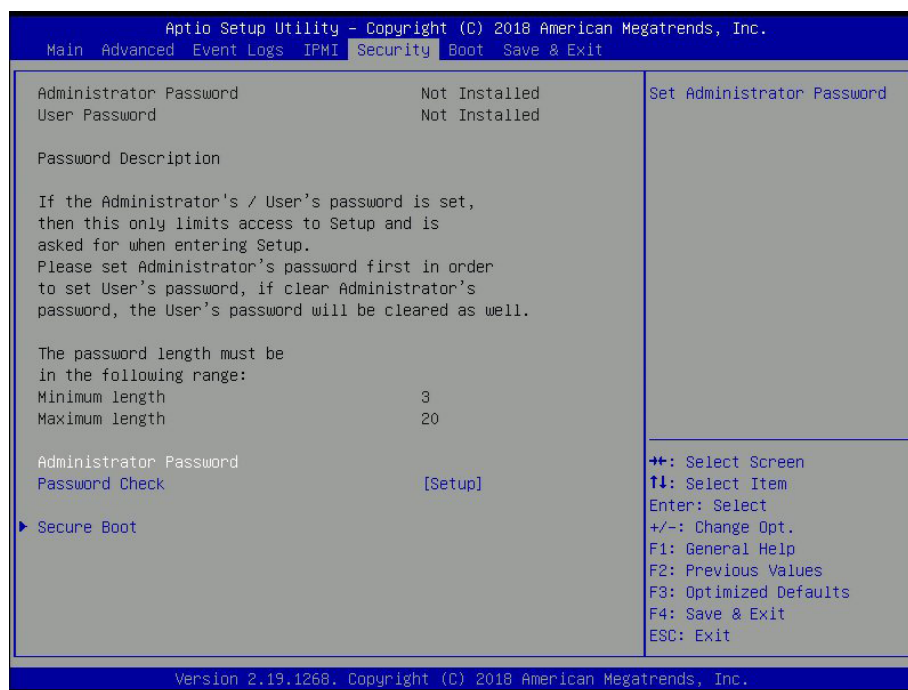

Administrator Password

Use this feature to set the administrator password which is required to enter the BIOS setup utility. The length of the password should be from 3 to 20 characters long.

Password Check

Select Setup for the system to check for a password at Setup. Select Always for the system to check for a password at bootup or upon entering the BIOS Setup utility. The options are **Setup** and **Always**.

▶ Secure Boot

System Mode

Vendor Keys

Secure Boot Enable

Select Enable for secure boot support to ensure system security at bootup. The options are **Disabled** and **Enabled**.

Secure Boot Mode

This feature allows the user to select the desired secure boot mode for the system. The options are Standard and **Custom**.

****If Secure Boot Mode is set to Custom, Key Management features are available for configuration:***

CSM Support

This feature is for manufacturing debugging purposes.

▶ Key Management

This submenu allows the user to configure the following Key Management settings.

Factory Key Provision

Select Enabled to install the default Secure Boot keys set by the manufacturer. The options are **Disabled** and Enabled.

****If the feature above is set to Enabled, all features below are available for configuration:***

▶ Restore Factory Keys

Select Yes to restore all factory keys to the default settings. The options are Yes and No.

▶ Reset to Setup Mode

Select Yes to delete all Secure Boot key databases and force the system to Setup Mode. The options are Yes and No.

▶ Export Secure Boot variables

Use this feature to copy the NVRAM contents of the secure boot variables to a file.

▶ Enroll Efi Image

This feature allows the image to run in Secure Boot mode.

Device Guard Ready

▶ Remove 'UEFI CA' from DB

Use this feature to remove the Microsoft UEFI CA certificate from the database. The options are Yes and No.

▶ Restore DB Defaults

Select Yes to restore the DB defaults.

▶ Platform Key (PK)

This feature allows the user to configure the settings of the platform keys.

Details

Select this feature to view the details of the Platform Key.

Export

Select Yes to export a PK from a file on an external media.

Update

Select Yes to load a factory default PK or No to load from a file on an external media.

Delete

Select Ok to remove the PK and then the system will reset to Setup/Audit Mode.

▶ **Key Exchange Keys (KEK)**

Details

Select this feature to view the details of the Key Exchange Key.

Export

Select Yes to export a KEK from a file on an external media.

Update

Select Yes to load a factory default KEK or No to load from a file on an external media.

Append

Select Yes to add the KEK from the manufacturer's defaults list to the existing KEK. Select No to load the KEK from a file. The options are Yes and No.

Delete

Select Ok to remove the KEK and then the system will reset to Setup/Audit Mode.

▶ **Authorized Signatures**

Details

Select this feature to view the details of the db.

Export

Select Yes to export a db from a file on an external media.

Update

Select Yes to load a factory default db or No to load from a file on an external media.

Append

Select Yes to add the db from the manufacturer's defaults list to the existing db. Select No to load the db from a file. The options are Yes and No.

Delete

Select Ok to remove the db and then the system will reset to Setup/Audit Mode.

► Forbidden Signatures**Details**

Select this feature to view the details of the dbx.

Export

Select Yes to export a dbx from a file on an external media.

Update

Select Yes to load a factory default dbx or No to load from a file on an external media.

Append

Select Yes to add the dbx from the manufacturer's defaults list to the existing dbx. Select No to load the dbx from a file. The options are Yes and No.

Delete

Select Ok to remove the dbx and then the system will reset to Setup/Audit Mode.

► Authorized TimeStamps**Details**

Select this feature to view the details of the dbt.

Export

Select Yes to export a dbt from a file on an external media.

Update

Select Yes to load a factory default dbt or No to load from a file on an external media.

Append

Select Yes to add the dbt from the manufacturer's defaults list to the existing dbt. Select No to load the dbt from a file. The options are Yes and No.

Delete

Select Ok to remove the dbt and then the system will reset to Setup/Audit Mode.

► OsRecovery Signatures**Details**

Select this feature to view the details of the dbr.

Export

Select Yes to export a dbr from a file on an external media.

Update

Select Yes to load a factory default dbr or No to load from a file on an external media.

Append

Select Yes to add the dbr from the manufacturer's defaults list to the existing dbr. Select No to load the dbr from a file. The options are Yes and No.

Delete

Select Ok to remove the dbr and then the system will reset to Setup/Audit Mode.

5.7 Boot

Use this menu to configure boot settings:

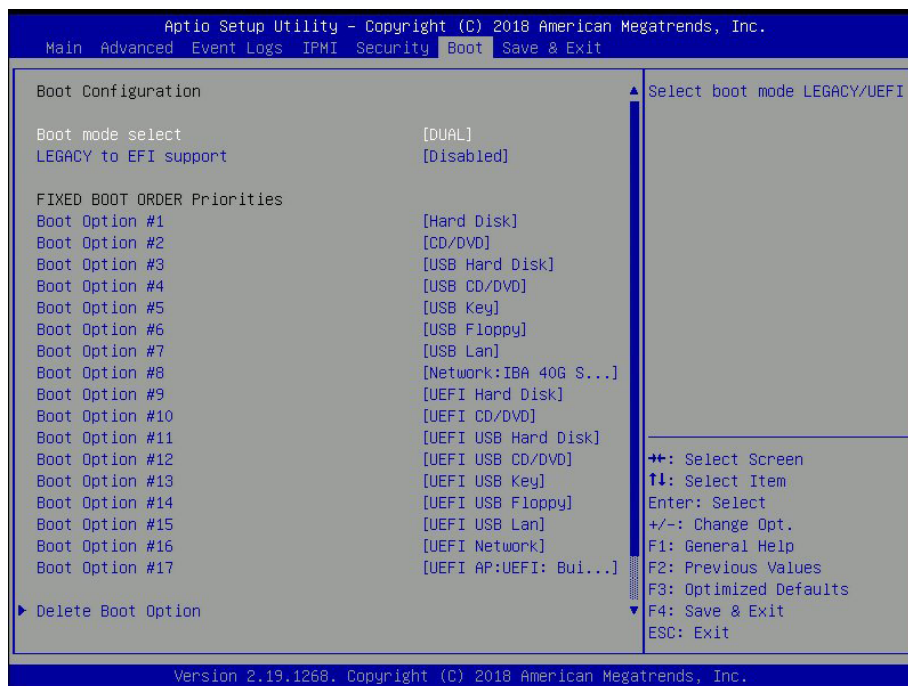

Boot mode select

Use this feature to select the boot mode. The options are LEGACY, UEFI, and **DUAL**.

LEGACY to EFI Support

Select Enabled to boot EFI OS support after Legacy boot order has failed. The options are **Disabled** and Enabled.

Fixed BOOT ORDER Priorities

This option prioritizes the order of bootable devices that the system to boot from. Press <Enter> on each entry from top to bottom to select devices.

- Boot Option #1
- Boot Option #2
- Boot Option #3
- Boot Option #4
- Boot Option #5
- Boot Option #6
- Boot Option #7

- Boot Option #8
- Boot Option #9
- Boot Option #10
- Boot Option #11
- Boot Option #12
- Boot Option #13
- Boot Option #14
- Boot Option #15
- Boot Option #16
- Boot Option #17

► **Delete Boot Option**

Use this feature to select a boot device to delete from the boot priority list.

► **UEFI Application Boot Priorities**

- Boot Option # - This feature sets the system boot order of detected devices. The options are **[the list of detected boot device(s)]** and Disabled.

► **NETWORK Drive BBS Priorities**

- Boot Option # - This feature sets the system boot order of detected devices. The options are **[the list of detected boot device(s)]** and Disabled.

5.8 Save & Exit

Use this menu to configure save and exit settings.

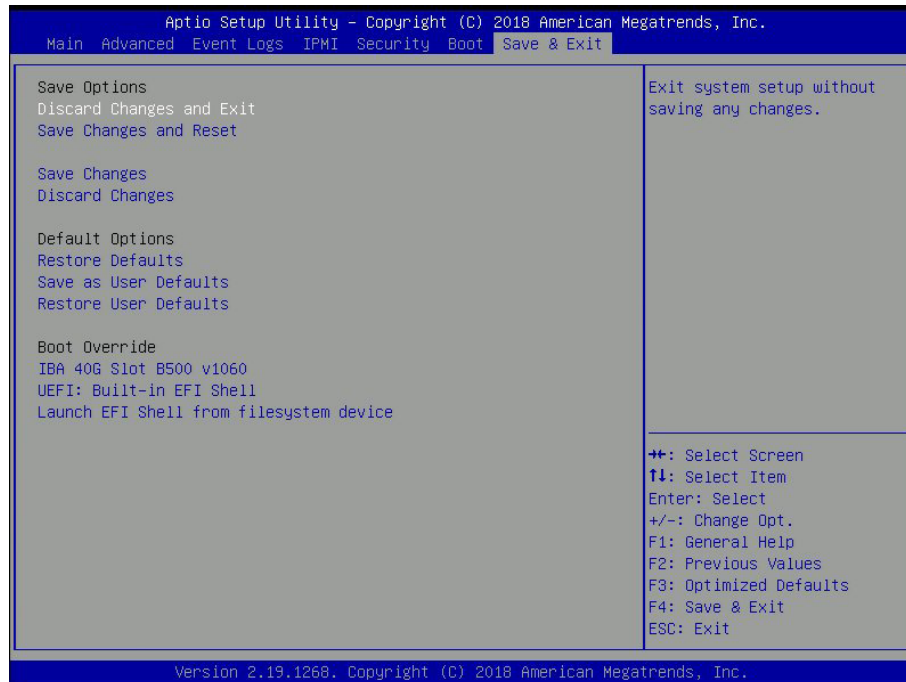

Save Options

Discard Changes and Exit

Select this feature to quit the BIOS Setup without making any permanent changes to the system configuration and reboot the computer. Select Discard Changes and Exit from the Exit menu and press <Enter>.

Save Changes and Reset

When you have completed the system configuration changes, select this option to save all changes made and reset the system.

Save Changes

When you have completed the system configuration changes, select this option to save all changes made. This will not reset (reboot) the system.

Discard Changes

Select this feature and press <Enter> to discard all the changes and return to the AMI BIOS Utility Program.

Default Options

Restore Defaults

To set this feature, select Restore Optimized Defaults and press <Enter>. These are factory settings designed for maximum system performance but not for maximum stability.

Save as User Defaults

To set this feature, select Save as User Defaults from the Exit menu and press <Enter>. This enables the user to save any changes to the BIOS setup for future use.

Restore User Defaults

To set this feature, select Restore User Defaults from the Exit menu and press <Enter>. Use this feature to retrieve user-defined settings that were saved previously.

Boot Override

Other boot options are listed in this section. The system will boot to the selected boot option.

IBA 40G Slot B500 v1060

UEFI: Built-in EFI Shell

Launch EFI Shell from filesystem device

Appendix A

BIOS Error Codes

A-1 BIOS Error Beep (POST) Codes

During the POST (Power-On Self-Test) routines, which are performed upon each system boot, errors may occur.

Non-fatal errors are those which, in most cases, allow the system to continue to boot. These error messages normally appear on the screen.

Fatal errors will not allow the system to continue with bootup. If a fatal error occurs, you should consult with your system manufacturer for possible repairs.

These fatal errors are usually communicated through a series of audible beeps. The table below lists some common errors and their corresponding beep codes encountered by users.

BIOS Beep (POST) Codes		
Beep Code	Error Message	Description
1 beep	Refresh	Circuits have been reset (Ready to power up)
5 short, 1 long	Memory error	No memory detected in system
5 long, 2 short	Display memory read/write error	Video adapter missing or with faulty memory
1 long continuous	System OH	System overheat condition

A-2 Additional BIOS POST Codes

The AMI BIOS supplies additional checkpoint codes, which are documented online at <http://www.supermicro.com/support/manuals/> ("AMI BIOS POST Codes User's Guide").

When BIOS performs the Power On Self Test, it writes checkpoint codes to I/O port 0080h. If the computer cannot complete the boot process, a diagnostic card can be attached to the computer to read I/O port 0080h (Supermicro p/n AOM-SPI80-V).

For information on AMI updates, please refer to <http://www.ami.com/products/>.

Appendix B

Standardized Warning Statements for DC Systems

B.1 About Standardized Warning Statements

The following statements are industry standard warnings, provided to warn the user of situations which have the potential for bodily injury. Should you have questions or experience difficulty, contact Supermicro's Technical Support department for assistance. Only certified technicians should attempt to install or configure components.

Read this appendix in its entirety before installing or configuring components in the Supermicro chassis.

These warnings may also be found on our website at http://www.supermicro.com/about/policies/safety_information.cfm.

Warning Definition



Warning! This warning symbol means danger. You are in a situation that could cause bodily injury. Before you work on any equipment, be aware of the hazards involved with electrical circuitry and be familiar with standard practices for preventing accidents.

警告の定義

この警告サインは危険を意味します。

人身事故につながる可能性がありますので、いずれの機器でも動作させる前に、電気回路に含まれる危険性に注意して、標準的な事故防止策に精通して下さい。

此警告符号代表危險。

您正处于可能受到严重伤害的工作环境中。在您使用设备开始工作之前，必须充分意识到触电的危险，并熟练掌握防止事故发生的标准工作程序。请根据每项警告结尾的声明号码找到此设备的安全性警告说明的翻译文本。

此警告符號代表危險。

您目前所處的工作環境可能讓您受傷。在您使用任何設備之前，請注意觸電的危險，並且要熟悉預防事故發生的標準工作程序。請依照每一注意事項後的號碼找到相關的翻譯說明內容。

Warnung

WICHTIGE SICHERHEITSHINWEISE

Dieses Warnsymbol bedeutet Gefahr. Sie befinden sich in einer Situation, die zu Verletzungen führen kann. Machen Sie sich vor der Arbeit mit Geräten mit den Gefahren elektrischer Schaltungen und den üblichen Verfahren zur Vorbeugung vor Unfällen vertraut. Suchen Sie mit der am Ende jeder Warnung angegebenen Anweisungsnummer nach der jeweiligen Übersetzung in den übersetzten Sicherheitshinweisen, die zusammen mit diesem Gerät ausgeliefert wurden.

BEWAHREN SIE DIESE HINWEISE GUT AUF.

INSTRUCCIONES IMPORTANTES DE SEGURIDAD

Este símbolo de aviso indica peligro. Existe riesgo para su integridad física. Antes de manipular cualquier equipo, considere los riesgos de la corriente eléctrica y familiarícese con los procedimientos estándar de prevención de accidentes. Al final de cada advertencia encontrará el número que le ayudará a encontrar el texto traducido en el apartado de traducciones que acompaña a este dispositivo.

GUARDE ESTAS INSTRUCCIONES.

IMPORTANTES INFORMATIONS DE SÉCURITÉ

Ce symbole d'avertissement indique un danger. Vous vous trouvez dans une situation pouvant entraîner des blessures ou des dommages corporels. Avant de travailler sur un équipement, soyez conscient des dangers liés aux circuits électriques et familiarisez-vous avec les procédures couramment utilisées pour éviter les accidents. Pour prendre connaissance des traductions des avertissements figurant dans les consignes de sécurité traduites qui accompagnent cet appareil, référez-vous au numéro de l'instruction situé à la fin de chaque avertissement.

CONSERVEZ CES INFORMATIONS.

תקנון הצהרות אזהרה

הצהרות הבאות הן אזהרות על פי תקני התעשייה, על מנת להזהיר את המשתמש מפני חבלה

פיזית אפשרית. במידה ויש שאלות או היתקלות בבעיה כלשהי, יש ליצור קשר עם מחלקת תמיכה

טכנית של סופרמיקרו. טכנאים מוסמכים בלבד רשאים להתקין או להגדיר את הרכיבים. יש לקרוא את הנספח במלואו לפני התקנת או הגדרת הרכיבים במארזי סופרמיקרו.

اَكْ ف حالة وُكِي اَي تتسبب ف اصابة جسدهُ هذا الزهز عُ خطر! تحذُرُ .
قبل اَي تعول على اَي هعدات، كي على علن بالوخاطز ال اُجوة عي الذوائر
الكهزبائِة
وكي على دراةُ بالووارسات النقاائِة لو عُ وقع اَي حادث
استخدم رِقن الب اِي الو صُص ف هاةُ كل تحذُرُ للعشر تزجوتها

안전을 위한 주의사항

경고!

이 경고 기호는 위험이 있음을 알려 줍니다. 작업자의 신체에 부상을 야기 할 수 있는 상태에 있게 됩니다. 모든 장비에 대한 작업을 수행하기 전에 전기회로와 관련된 위험요소들을 확인하시고 사전에 사고를 방지할 수 있도록 표준 작업절차를 준수해 주시기 바랍니다.

해당 번역문을 찾기 위해 각 경고의 마지막 부분에 제공된 경고문 번호를 참조하십시오

BELANGRIJKE VEILIGHEIDSINSTRUCTIES

Dit waarschuwings symbool betekent gevaar. U verkeert in een situatie die lichamelijk letsel kan veroorzaken. Voordat u aan enige apparatuur gaat werken, dient u zich bewust te zijn van de bij een elektrische installatie betrokken risico's en dient u op de hoogte te zijn van de standaard procedures om ongelukken te voorkomen. Gebruik de nummers aan het eind van elke waarschuwing om deze te herleiden naar de desbetreffende locatie.

BEWAAR DEZE INSTRUCTIES

Installation Instructions



Warning! Read the installation instructions before connecting the system to the power source.

設置手順書

システムを電源に接続する前に、設置手順書をお読み下さい。

警告

将此系统连接电源前,请先阅读安装说明。

警告

將系統與電源連接前，請先閱讀安裝說明。

Warnung

Vor dem Anschließen des Systems an die Stromquelle die Installationsanweisungen lesen.

¡Advertencia!

Lea las instrucciones de instalación antes de conectar el sistema a la red de alimentación.

Attention

Avant de brancher le système sur la source d'alimentation, consulter les directives d'installation.

יש לקרוא את הוראות התקנה לפני חיבור המערכת למקור מתח.

اقر إرشادات التركيب قبل توصيل النظام إلى مصدر للطاقة

시스템을 전원에 연결하기 전에 설치 안내를 읽어주십시오.

Waarschuwing

Raadpleeg de installatie-instructies voordat u het systeem op de voedingsbron aansluit.

Circuit Breaker

Warning! This product relies on the building's installation for short-circuit (overcurrent) protection. Ensure that the protective device is rated not greater than: 60VDC, 20A.

サーキット・ブレーカー

この製品は、短絡(過電流)保護装置がある建物での設置を前提としています。

保護装置の定格が60VDC、20Aを超えないことを確認下さい。

警告

此产品的短路(过载电流)保护由建筑物的供电系统提供,确保短路保护设备的额定电流不大于60VDC,20A。

警告

此產品的短路(過載電流)保護由建築物的供電系統提供,確保短路保護設備的額定電流不大於60VDC,20A。

Warnung

Dieses Produkt ist darauf angewiesen, dass im Gebäude ein Kurzschluss- bzw. Überstromschutz installiert ist. Stellen Sie sicher, dass der Nennwert der Schutzvorrichtung nicht mehr als: 60VDC, 20A beträgt.

¡Advertencia!

Este equipo utiliza el sistema de protección contra cortocircuitos (o sobrecorrientes) del edificio. Asegúrese de que el dispositivo de protección no sea superior a: 60VDC, 20A.

Attention

Pour ce qui est de la protection contre les courts-circuits (surtension), ce produit dépend de l'installation électrique du local. Vérifiez que le courant nominal du dispositif de protection n'est pas supérieur à :60VDC, 20A.

מוצר זה מסתמך על הגנה המותקנת במבנים למניעת קצר חשמלי. יש לוודא כי המכשיר המגן מפני הקצר החשמלי הוא לא יותר מ-60VDC, 20A

هذا المنتج يعتمد على معدات الحماية مه الدوائر القصيرة التي تم تثبيتها في المبنى
تأكد من أن تقييم الجهاز الوقائي ليس أكثر من : 20A, 60VDC

경고!

이 제품은 전원의 단락(과전류)방지에 대해서 전적으로 건물의 관련 설비에 의존합니다. 보호장치의 정격이 반드시 60VDC(볼트), 20A(암페어)를 초과하지 않도록 해야 합니다.

Waarschuwing

Dit product is afhankelijk van de kortsluitbeveiliging (overspanning) van uw elektrische installatie. Controleer of het beveiligde apparaat niet groter gedimensioneerd is dan 60VDC, 20A.

Power Disconnection Warning



Warning! The system must be disconnected from all sources of power and the power cord removed from the power supply module(s) before accessing the chassis interior to install or remove system components.

電源切斷の警告

システムコンポーネントの取り付けまたは取り外しのために、シャーシ内部にアクセスするには、システムの電源はすべてのソースから切斷され、電源コードは電源モジュールから取り外す必要があります。

警告

在你打开机箱并安装或移除内部器件前,必须将系统完全断电,并移除电源线。

警告

在您打開機殼安裝或移除內部元件前，必須將系統完全斷電，並移除電源線。

Warnung

Das System muss von allen Quellen der Energie und vom Netzanschlusskabel getrennt sein, das von den Spg.Versorgungsteilmodulen entfernt wird, bevor es auf den Chassisinnenraum zurückgreift, um Systemsbestandteile anzubringen oder zu entfernen.

¡Advertencia!

El sistema debe ser disconnected de todas las fuentes de energía y del cable eléctrico quitado de los módulos de fuente de alimentación antes de tener acceso el interior del chasis para instalar o para quitar componentes de sistema.

Attention

Le système doit être débranché de toutes les sources de puissance ainsi que de son cordon d'alimentation secteur avant d'accéder à l'intérieur du chasis pour installer ou enlever des composants de système.

אזהרה מפני ניתוק חשמלי

אזהרה!

יש לנתק את המערכת מכל מקורות החשמל ויש להסיר את כבל החשמלי מהספק לפני גישה לחלק הפנימי של המארז לצורך התקנת או הסרת רכיבים.

يجب فصل انظاؤ من جميع مصادر انطاقت وإزانت سهك انكهرباء من وحدة امداد
انطاقت قيم
انصل إني امنطاق انداخهيت نههيكم نتشيج أو إزانت مكناث الجهاز

경고!

시스템에 부품들을 장착하거나 제거하기 위해서는 새시 내부에 접근하기 전에 반드시 전원 공급장치로부터 연결되어있는 모든 전원과 전기코드를 분리해주어야 합니다.

Waarschuwing

Voordat u toegang neemt tot het binnenwerk van de behuizing voor het installeren of verwijderen van systeem onderdelen, dient u alle spanningsbronnen en alle stroomkabels aangesloten op de voeding(en) van de behuizing te verwijderen

Equipment Installation



Warning! Only trained and qualified personnel should be allowed to install, replace, or service this equipment.

機器の設置

トレーニングを受け認定された人だけがこの装置の設置、交換、またはサービスを許可されていま
す。

警告

只有经过培训且具有资格的人员才能进行此设备的安装、更换和维修。

警告

只有經過受訓且具資格人員才可安裝、更換與維修此設備。

Warnung

Das Installieren, Ersetzen oder Bedienen dieser Ausrüstung sollte nur geschultem, qualifiziertem Personal gestattet werden.

¡Advertencia!

Solamente el personal calificado debe instalar, reemplazar o utilizar este equipo.

Attention

Il est vivement recommandé de confier l'installation, le remplacement et la maintenance de ces équipements à des personnels qualifiés et expérimentés.

אזהרה!

צוות מוסמך בלבד רשאי להתקין, להחליף את הציוד או לתת שירות עבור הציוד.

والمدربيه لتزكيب واستبدال أو خدمة هذا الجهاز يجب أن يسمح فقط للمظفيه المؤهليه

경고!

훈련을 받고 공인된 기술자만이 이 장비의 설치, 교체 또는 서비스를 수행할 수 있습니다.

Waarschuwing

Deze apparatuur mag alleen worden geïnstalleerd, vervangen of hersteld door geschoold en gekwalificeerd personeel.

Restricted Area

Warning! This unit is intended for installation in restricted access areas. A restricted access area can be accessed only through the use of a special tool, lock and key, or other means of security. (This warning does not apply to workstations).

アクセス制限区域

このユニットは、アクセス制限区域に設置されることを想定しています。

アクセス制限区域は、特別なツール、鍵と錠前、その他のセキュリティの手段を用いてのみ出入りが可能です。

警告

此部件应安装在限制进出的场所，限制进出的场所指只能通过使用特殊工具、锁和钥匙或其它安全手段进出的场所。

警告

此装置僅限安裝於進出管制區域，進出管制區域係指僅能以特殊工具、鎖頭及鑰匙或其他安全方式才能進入的區域。

Warnung

Diese Einheit ist zur Installation in Bereichen mit beschränktem Zutritt vorgesehen. Der Zutritt zu derartigen Bereichen ist nur mit einem Spezialwerkzeug, Schloss und Schlüssel oder einer sonstigen Sicherheitsvorkehrung möglich.

¡Advertencia!

Esta unidad ha sido diseñada para instalación en áreas de acceso restringido. Sólo puede obtenerse acceso a una de estas áreas mediante la utilización de una herramienta especial, cerradura con llave u otro medio de seguridad.

Attention

Cet appareil doit être installé dans des zones d'accès réservés. L'accès à une zone d'accès réservé n'est possible qu'en utilisant un outil spécial, un mécanisme de verrouillage et une clé, ou tout autre moyen de sécurité.

אזור עם גישה מוגבלת

אזהרה!

יש להתקין את היחידה באזורים שיש בהם הגבלת גישה. הגישה ניתנת בעזרת 'כלי אבטחה בלבד' (מפתח, מנעול וכד.).

تخصيص هذه انحدة نترك بُها ف مناطق محظورة تم .
ممكن انصل إن منطقت محظورة فقط من خلال استخداو أداة خاصت
أو أوس هُت أخري نلالأما ققم ومفتاح

경고!

이 장치는 접근이 제한된 구역에 설치하도록 되어있습니다. 특수도구, 잠금 장치 및 키, 또는 기타 보안 수단을 통해서만 접근 제한 구역에 들어갈 수 있습니다.

Waarschuwing

Dit apparaat is bedoeld voor installatie in gebieden met een beperkte toegang. Toegang tot dergelijke gebieden kunnen alleen verkregen worden door gebruik te maken van speciaal gereedschap, slot en sleutel of andere veiligheidsmaatregelen.

Battery Handling



Warning! There is the danger of explosion if the battery is replaced incorrectly. Replace the battery only with the same or equivalent type recommended by the manufacturer. Dispose of used batteries according to the manufacturer's instructions

電池の取り扱い

電池交換が正しく行われなかった場合、破裂の危険性があります。交換する電池はメーカーが推奨する型、または同等のものを使用下さい。使用済電池は製造元の指示に従って処分して下さい。

警告

電池更換不當會有爆炸危險。請只使用同類電池或制造商推薦的功能相當的電池更換原有電池。請按製造商的說明處理廢舊電池。

警告

電池更換不當會有爆炸危險。請使用製造商建議之相同或功能相當的電池更換原有電池。請按照製造商的說明指示處理廢棄舊電池。

Warnung

Bei Einsetzen einer falschen Batterie besteht Explosionsgefahr. Ersetzen Sie die Batterie nur durch den gleichen oder vom Hersteller empfohlenen Batterietyp. Entsorgen Sie die benutzten Batterien nach den Anweisungen des Herstellers.

Attention

Danger d'explosion si la pile n'est pas remplacée correctement. Ne la remplacer que par une pile de type semblable ou équivalent, recommandée par le fabricant. Jeter les piles usagées conformément aux instructions du fabricant.

¡Advertencia!

Existe peligro de explosión si la batería se reemplaza de manera incorrecta. Reemplazar la batería exclusivamente con el mismo tipo o el equivalente recomendado por el fabricante. Desechar las baterías gastadas según las instrucciones del fabricante.

אזהרה!

קיימת סכנת פיצוץ של הסוללה במידה והוחלפה בדרך לא תקינה. יש להחליף את הסוללה בסוג התואם מחברת יצרן מומלצת. סילוק הסוללות המשומשות יש לבצע לפי הוראות היצרן.

هناك خطر من انفجار في حالة اسحبذال البطارية بطريقة غير صحيحة فعليل
اسحبذال البطارية
فقط بنفس النوع أو ما يعادلها مما أوصت به الشركة المصنعة
جخلص من البطاريات المسحعملة وفقا لعمليات الشركة الصانعة

경고!

배터리가 올바르게 교체되지 않으면 폭발의 위험이 있습니다. 기존 배터리와 동일하거나 제조사에서 권장하는 동등한 종류의 배터리로만 교체해야 합니다. 제조사의 안내에 따라 사용된 배터리를 처리하여 주십시오.

Waarschuwing

Er is ontplofingsgevaar indien de batterij verkeerd vervangen wordt. Vervang de batterij slechts met hetzelfde of een equivalent type die door de fabrikant aanbevolen wordt. Gebruikte batterijen dienen overeenkomstig fabrieksvoorschriften afgevoerd te worden.

Redundant Power Supplies



Warning! This unit might have more than one power supply connection. All connections must be removed to de-energize the unit.

冗長電源装置

このユニットは複数の電源装置が接続されている場合があります。

ユニットの電源を切るためには、すべての接続を取り外さなければなりません。

警告

此部件连接的电源可能不止一个，必须将所有电源断开才能停止给该部件供电。

警告

此装置连接的电源可能不只一个，必须切断所有电源才能停止对该装置的供电。

Warnung

Dieses Gerät kann mehr als eine Stromzufuhr haben. Um sicherzustellen, dass der Einheit kein Strom zugeführt wird, müssen alle Verbindungen entfernt werden.

¡Advertencia!

Puede que esta unidad tenga más de una conexión para fuentes de alimentación. Para cortar por completo el suministro de energía, deben desconectarse todas las conexiones.

Attention

Cette unité peut avoir plus d'une connexion d'alimentation. Pour supprimer toute tension et tout courant électrique de l'unité, toutes les connexions d'alimentation doivent être débranchées.

אם קיים יותר מספק אחד

אזהרה!

ליחידה יש יותר מחיבור אחד של ספק. יש להסיר את כל החיבורים על מנת לרוקן את היחידה.

قد يكون لهذا الجهاز عدة اتصالات بوحدات امداد الطاقة .
يجب إزالة كافة الاتصالات لعسل الوحدة عن الكهرباء

경고!

이 장치에는 한 개 이상의 전원 공급 단자가 연결되어 있을 수 있습니다. 이 장치에 전원을 차단하기 위해서는 모든 연결 단자를 제거해야만 합니다.

Waarschuwing

Deze eenheid kan meer dan één stroomtoevoeraansluiting bevatten. Alle aansluitingen dienen verwijderd te worden om het apparaat stroomloos te maken.

Backplane Voltage



Warning! Hazardous voltage or energy is present on the backplane when the system is operating. Use caution when servicing.

バックプレーンの電圧

システムの稼働中は危険な電圧または電力が、バックプレーン上にかかっています。

修理する際には注意ください。

警告

当システム正在进行时，背板上有很危险的电压或能量，进行维修时务必小心。

警告

當系統正在進行時，背板上危險的電壓或能量，進行維修時務必小心。

Warnung

Wenn das System in Betrieb ist, treten auf der Rückwandplatine gefährliche Spannungen oder Energien auf. Vorsicht bei der Wartung.

¡Advertencia!

Cuando el sistema está en funcionamiento, el voltaje del plano trasero es peligroso. Tenga cuidado cuando lo revise.

Attention

Lorsque le système est en fonctionnement, des tensions électriques circulent sur le fond de panier. Prendre des précautions lors de la maintenance.

מתח בפנל האחורי

אזהרה!

קיימת סכנת מתח בפנל האחורי בזמן תפעול המערכת. יש להיזהר במהלך העבודה.

هناك خطر من التيار الكهربائي أو الطاقة المتجددة على اللوحة
عندما يكون النظام يعمل كه حذرا عند خدمة هذا الجهاز

경고!

시스템이 동작 중일 때 후면판 (Backplane)에는 위험한 전압이나 에너지가 발생 합니다.
서비스 작업 시 주의하십시오.

Waarschuwing

Een gevaarlijke spanning of energie is aanwezig op de backplane wanneer het systeem in gebruik is. Voorzichtigheid is geboden tijdens het onderhoud.

Comply with Local and National Electrical Codes



Warning! Installation of the equipment must comply with local and national electrical codes.

地方および国の電気規格に準拠

機器の取り付けはその地方および国の電気規格に準拠する必要があります。

警告

设备安装必须符合本地与本国电气法规。

警告

設備安裝必須符合本地與本國電氣法規。

Warnung

Die Installation der Geräte muss den Sicherheitsstandards entsprechen.

¡Advertencia!

La instalación del equipo debe cumplir con las normas de electricidad locales y nacionales.

Attention

L'équipement doit être installé conformément aux normes électriques nationales et locales.

תיאום חוקי החשמל הארצי
אזהרה!
התקנת הציוד חייבת להיות תואמת לחוקי החשמל המקומיים והארציים.

تركيب المعدات الكهربائية يجب أن يمتثل للقوايه المحلية والبطية المتعلقة
بالكهرباء

경고!

현 지역 및 국가의 전기 규정에 따라 장비를 설치해야 합니다.

Waarschuwing

Bij installatie van de apparatuur moet worden voldaan aan de lokale en nationale elektriciteitsvoorschriften.

Product Disposal



Warning! Ultimate disposal of this product should be handled according to all national laws and regulations.

製品の廃棄

この製品を廃棄処分する場合、国の関係する全ての法律・条例に従い処理する必要があります。

警告

本产品的废弃处理应根据所有国家的法律和规章进行。

警告

本產品的廢棄處理應根據所有國家的法律和規章進行。

Warnung

Die Entsorgung dieses Produkts sollte gemäß allen Bestimmungen und Gesetzen des Landes erfolgen.

¡Advertencia!

Al deshacerse por completo de este producto debe seguir todas las leyes y reglamentos nacionales.

Attention

La mise au rebut ou le recyclage de ce produit sont généralement soumis à des lois et/ou directives de respect de l'environnement. Renseignez-vous auprès de l'organisme compétent.

סילוק המוצר

אזהרה!

סילוק סופי של מוצר זה חייב להיות בהתאם להנחיות וחוקי המדינה.

التخلص النهائي من هذا المنتج ينبغي التعامل معه وفقا لجميع القوانين واللوائح الطننية عند

경고!

이 제품은 해당 국가의 관련 법규 및 규정에 따라 폐기되어야 합니다.

Waarschuwing

De uiteindelijke verwijdering van dit product dient te geschieden in overeenstemming met alle nationale wetten en reglementen.

Hot Swap Fan Warning



Warning! Hazardous moving parts. Keep away from moving fan blades. The fans might still be turning when you remove the fan assembly from the chassis. Keep fingers, screwdrivers, and other objects away from the openings in the fan assembly's housing.

ファン・ホットスワップの警告

警告!回転部品に注意。運転中は回転部(羽根)に触れないでください。シャーシから冷却ファン装置を取り外した際、ファンがまだ回転している可能性があります。ファンの開口部に、指、ドライバー、およびその他のものを近づけないで下さい。

警告!

警告! 危險的可移動性零件。請務必與轉動的风扇叶片保持距離。當您從機架移除風扇裝置，風扇可能仍在轉動。小心不要將手指、螺絲起子和其他物品太靠近風扇

警告

危險的可移動性零件。請務必與轉動的风扇叶片保持距離。當您從機架移除風扇裝置，風扇可能仍在轉動。小心不要將手指、螺絲起子和其他物品太靠近風扇。

Warnung

Gefährlich Bewegende Teile. Von den bewegenden Lüfterblätter fern halten. Die Lüfter drehen sich u. U. noch, wenn die Lüfterbaugruppe aus dem Chassis genommen wird. Halten Sie Finger, Schraubendreher und andere Gegenstände von den Öffnungen des Lüftergehäuses entfernt.

¡Advertencia!

Riesgo de piezas móviles. Mantener alejado de las aspas del ventilador. Los ventiladores podran dar vuelta cuando usted quite el montaje del ventilador del chasis. Mantenga los dedos, los destornilladores y todos los objetos lejos de las aberturas del ventilador

Attention

Pieces mobiles dangereuses. Se tenir a l'écart des lames du ventilateur Il est possible que les ventilateurs soient toujours en rotation lorsque vous retirerez le bloc ventilateur du châssis. Prenez garde à ce que doigts, tournevis et autres objets soient éloignés du logement du bloc ventilateur.

אזהרה!

חלקים נעים מסוכנים. התרחק מלהבי המאוורר בפעולה כאשר מסירים את חלקי המאוורר מהמארז, יתכן והמאווררים עדיין עובדים. יש להרחיק למרחק בטוח את האצבעות וכלי עבודה שונים מהפתחים בתוך המאוורר

تحذير! أجزاء متحركة خطيرة. ابتعد عن شفرات المروحة المتحركة. من الممكن أن المراوح لا تزال تدور عند إزالة كتلة المروحة من الهيكل يجب إبقاء الأصابع ومفكات البراغي وغيرها من الأشياء بعيدا عن الفتحات في كتلة المروحة

경고!

움직이는 위험한 부품. 회전하는 송풍 날개에 접근하지 마세요. 새시로부터 팬 조립품을 제거할 때 팬은 여전히 회전하고 있을 수 있습니다. 팬 조립품 외관의 열려있는 부분들로부터 손가락 및 스크류드라이버, 다른 물체들이 가까이 하지 않도록 배치해 주십시오.

Waarschuwing

Gevaarlijk bewegende onderdelen. Houd voldoende afstand tot de bewegende ventilatorbladen. Het is mogelijk dat de ventilator nog draait tijdens het verwijderen van het ventilatorsamenstel uit het chassis. Houd uw vingers, schroevendraaiers en eventuele andere voorwerpen uit de buurt van de openingen in de ventilatorbehuizing.

DC Power Supply



Warning! When stranded wiring is required, use approved wiring terminations, such as closedloop or spade-type with upturned lugs. These terminations should be the appropriate size for the wires and should clamp both the insulation and conductor.

警告

より線が必要な場合、承認済みのケーブル終端(上向きの端子を備えたクローズループ型またはU字型の終端など)を使用してください。使用するワイヤーに適したサイズで、絶縁体および導体が両方ともクランプされている終端でなければなりません。

警告

需要多股佈線時，請使用經核准的佈線終端，例如閉環或鑷型接線片。這些終端的大小應適合線路，並且可以同時夾住絕緣體和導體。

警告

需要使用绞线连接时，请使用经认可的连接端子，如闭环端子或具有接线柱的铲形端子。这些端子的大小应与线缆相吻合，并且可以将绝缘部分和导体夹紧固定。

Warnung

Wenn Litzenverdrahtung erforderlich ist, sind zugelassene Verdrahtungsabschlüsse, z.B. für einen geschlossenen Regelkreis oder gabelförmig, mit nach oben gerichteten Kabelschuhen zu verwenden. Diese Abschlüsse sollten die angemessene Größe für die Drähte haben und sowohl die Isolierung als auch den Leiter festklemmen.

¡Advertencia!

Cuando se necesite hilo trenzado, utilizar terminales para cables homologados, tales como las de tipo "bucle cerrado" o "espada", con las lengüetas de conexión vueltas hacia arriba. Estos terminales deberán ser del tamaño apropiado para los cables que se utilicen, y tendrán que sujetar tanto el aislante como el conductor.

Attention

Quand des fils torsadés sont nécessaires, utiliser des douilles terminales homologuées telles que celles à circuit fermé ou du type à plage ouverte avec cosses rebroussées. Ces douilles terminales doivent être de la taille qui convient aux fils et doivent être refermées sur la gaine isolante et sur le conducteur.

תקנון הזהרות אזהרה

הזהרות הבאות הן אזהרות על פי תקני התעשייה, על מנת להזהיר את המשתמש מפני חבלה פיזית אפשרית. במידה ויש שאלות או היתקלות בבעיה כלשהי, יש ליצור קשר עם מחלקת תמיכה טכנית של סופרמיקרו. טכנאים מוסמכים בלבד רשאים להתקין או להגדיר את הרכיבים.

יש לקרוא את הנספח במלואו לפני התקנת או הגדרת הרכיבים במארזי סופרמיקרו.

تحذير

وأقلغم قق ل ح لشم، اهل ل ع قق ف او مل اء ان! كال س ال ا م اد خ ت س او، ل ب س ل ا م ه ب ت ع ط ق ت ن ي ذ ل ا ك ال س ال ا ب و ل ط م ن و ك ي ا م د ن ع ب ج ي و ك ال س ال ل ب س ان م ل ا م ج ح ل ا ن و ك ي ت اء اء ان ال ا ه ذ ل ي غ ب ن ي و. ة ب و ل ق م ت ا و ر ع ل ا ع م ع و ن ل ا ة ي ق ي ق ح ل ا ا ه ي ا م س ا ب ا ي ش ال ا ل ص و م و ل ز ع ل ا ن م ل ك ح ب ك.

주의!

꼬인 배선이 요구 될 때에는 폐회로나 돌출부가 위로 튀어 나온 Spade 형태의 승인된 배선 터미네이션들을 사용하세요.

이 터미네이션들은 배선들을 위해 적절한 크기여야 하고, 절연체와 도체 모두를 고정시킬 수 있어야 합니다.

Waarschuwing

Wanneer geslagen bedrading vereist is, dient u bedrading te gebruiken die voorzien is van goedgekeurde aansluitingspunten, zoals het gesloten-lus type of het grijperschop type waarbij de aansluitpunten omhoog wijzen. Deze aansluitpunten dienen de juiste maat voor de draden te hebben en dienen zowel de isolatie als de geleider vast te klemmen.

DC Power Disconnection



Warning! Before performing any of the following procedures, ensure that power is removed from the DC circuit.

警告

次の手順を開始する前に、DC回路から電源が切断されていることを確認してください。

警告

進行以下任一操作程序前，請確保直流電路已斷電。

警告

请在进行以下任一操作程序前，确保直流电路的电源已经断开。

Warnung

Vor Ausführung der folgenden Vorgänge ist sicherzustellen, daß die Gleichstromschaltung keinen Strom erhält.

¡Advertencia!

Antes de proceder con los siguientes pasos, comprobar que la alimentación del circuito de corriente continua (CC) esté cortada (OFF).

Attention

Avant de pratiquer l'une quelconque des procédures ci-dessous, vérifier que le circuit en courant continu n'est plus sous tension.

אזהרה!
לפני ביצוע אחת הפעולות הבאות, ודא כי אספקת החשמל למעגל הזרם הישר DC הינה מנותקת.

تحذير

وأقول غم ققلح لشم، ادهي لع ققفاومل اءاهن! كالسأل مادختساو، لبسلا مهب تعطقت نيذلا كالسأل ابولطم نوكي امدنع بجي وكالسأل بسانملا مچحل نوكي تاءاهن إل اذهل يغبنني و. ةبولقم تاورعل عم عونلا ةيقي قحلا ادهي امس أب اءيشأل لصوصم و لزعل نم لك حبك.

주의!

다음 절차들을 수행하기 전에, 전원이 DC 회로로부터 제거되었는지를 확인해 주십시오.

Waarschuwing

Wanneer geslagen bedrading vereist is, dient u bedrading te gebruiken die voorzien is van goedgekeurde aansluitingspunten, zoals het gesloten-lus type of het grijperschop type waarbij de aansluitpunten omhoog wijzen. Deze aansluitpunten dienen de juiste maat voor de draden te hebben en dienen zowel de isolatie als de geleider vast te klemmen.

Hazardous Voltage or Energy Present on DC Power Terminals



Warning! Hazardous voltage or energy may be present on DC power terminals. Always replace cover when terminals are not in service. Be sure uninsulated conductors are not accessible when cover is in place.

警告

直接電力端子に危険な電圧やエネルギーが発生している可能性があります。使用していない端子には常にカバーをつけてください。カバーがついているときは非絶縁形コンダクターに接触していないことを確認してください。

警告

直流電源終端可能產生危險的電壓或能量。終端不使用時，請務必蓋上機蓋。當蓋上機蓋，確認不絕緣導體無法使用。

警告

直流电源终端可能会产生危险的电压或能量。终端不使用时，请务必盖上机盖。机盖盖上后，请确保导体未绝缘部分无法使用。

Warnung

In mit Gleichstrom betriebenen Terminals kann es zu gefährlicher Spannung kommen. Die Terminals müssen abgedeckt werden, wenn sie nicht in Betrieb sind. Stellen Sie bei Benutzung der Abdeckung sicher, dass alle nicht isolierten, stromführenden Kabel abgedeckt sind.

¡Advertencia!

Puede haber energía o voltaje peligrosos en los terminales eléctricos de CC. Reemplace siempre la cubierta cuando no estén utilizándose los terminales. Asegúrese de que no haya acceso a conductores descubiertos cuando la cubierta esté colocada.

Attention

Le voltage ou l'énergie électrique des terminaux à courant continu peuvent être dangereux. Veillez à toujours replacer le couvercle lors les terminaux ne sont pas en service. Assurez-vous que les conducteurs non isolés ne sont pas accessibles lorsque le couvercle est en place.

אזהרה!

מקור מתח מסוכן עלול להיות נוכח על הקטבים של זרם ה-DC. החלף תמיד את המכסה כאשר הקטבים לא בשימוש. ודא כי המוליכים הלא מבודדים אינם נגישים כאשר המכסה נמצא במקומו.

تحذير

امدنع امئاد ءاطغ لادبتسا . ءمصاعل ءق اظلا تاظحم ىلع ءدوجوم نوكت ءق اظلا واً ءرطخل دهجل دق
ءاطغلا امدنع اهول لوصول نكمي ال لوزعم ريغ تالوصولم اله يف كش ال امم . ءمدخل اله تسيل تاظحمل
هنكم يف .

주의!

DC전원 단자들에 위험한 전압이나 에너지가 발생할 수 있습니다.

단말기들을 운영하지 않을 때에는 덮개로 다시 덮어 놓아 주십시오. 덮개가 제자리에 있어야만 절연되지 않은 도체들의 접근을 막을 수 있습니다.

Waarschuwing

Op DC-aansluitingspunten kunnen zich gevaarlijke voltages of energieën voordoen. Plaats altijd de afsluiting wanneer de aansluitingspunten niet worden gebruikt. Zorg ervoor dat blootliggende contactpunten niet toegankelijk zijn wanneer de afsluiting is geplaatst.

Appendix C

System Specifications

Processors

Single Intel Xeon D-2123IT

Chipset

SoC (System on a Chip)

BIOS

128Mb SPI Flash EEPROM with AMI UEFI BIOS

Memory

Four DDR4 DIMM sockets to support up to 512GB DDR4 ECC RDIMM or up to 64GB DDR4 ECC/non-ECC UDIMM 2666/2400/2133MHz memory; DIMM Sizes 64GB, 32GB, 16GB, 8GB, 4GB

SATA Controller

SATA 3.0 (6Gbps) from Intel SoC

Drive Bays

Single fixed 2.5" hard drive bay with bracket for 9.5 mm thickness HDD

Expansion Slots

One onboard OCuLink port (or one PCI-E 3.0 x4 NVMe) and one PCI-E 3.0 x8 low-profile)

Motherboard

X11SDV-4C-TLN2F; Mini-ITX form factor 6.75" x 6.75" (17.15 x 17.15cm)

Chassis

SCE300; Mini ITX, Width 10" (254mm), Height 1.7" (43mm), Depth 8.9" (226mm)

System Cooling

One to three 4-cm high performance PWM fan

Power Supply

120W Lockable DC Power Adapter with PFC
12VDC, 5A (60W) DC Power Adapter; 12VDC, 7A (84W) DC Power Adapter

Weight

Gross Weight: 7.5 lbs (3.4 kg)
Net Weight: 3.45 lbs (1.56 kg)

Operating Environment

Operating Temperature: 0°C to 40°C (32°F to 104°F)
Non-operating Temperature: -40°C to 70°C (-40°F to 158°F)
Operating Relative Humidity: 8% to 90% (non-condensing)
Non-operating Relative Humidity: 5% to 95% (non-condensing)

Regulatory Compliance

Electromagnetic Emissions: FCC Class A, EN 55032 Class A, EN 61000-3-2/3-3, CISPR 32 Class A

Electromagnetic Immunity: EN 55024/CISPR 24, (EN 61000-4-2, EN 61000-4-3, EN 61000-4-4, EN 61000-4-5, EN 61000-4-6, EN 61000-4-8, EN 61000-4-11)

Safety: CSA/EN/IEC/UL 60950-1 Compliant, UL or CSA Listed (USA and Canada), CE Marking (Europe)

Other: VCCI-CISPR 32 and AS/NZS CISPR 32

Environmental: Directive 2011/65/EU and Directive 2012/19/EU

Perchlorate Warning

California Best Management Practices Regulations for Perchlorate Materials: This Perchlorate warning applies only to products containing CR (Manganese Dioxide) Lithium coin cells. "Perchlorate Material-special handling may apply. See www.dtsc.ca.gov/hazardouswaste/perchlorate"