

Accessories

Please make sure that following items are included in the box, along with the main. If any items missing, contact your dealer.



- Before using, read the "Quick Start Guide" and the owner's manual to ensure correct usage through understanding.
- After reading, store them in a safe place for future reference.
- Do not look into the lens while the projector's power is turned on.
- Do not put something close to the lens when power on the projector, it may damage the projector or may cause fire hazard.

Projector

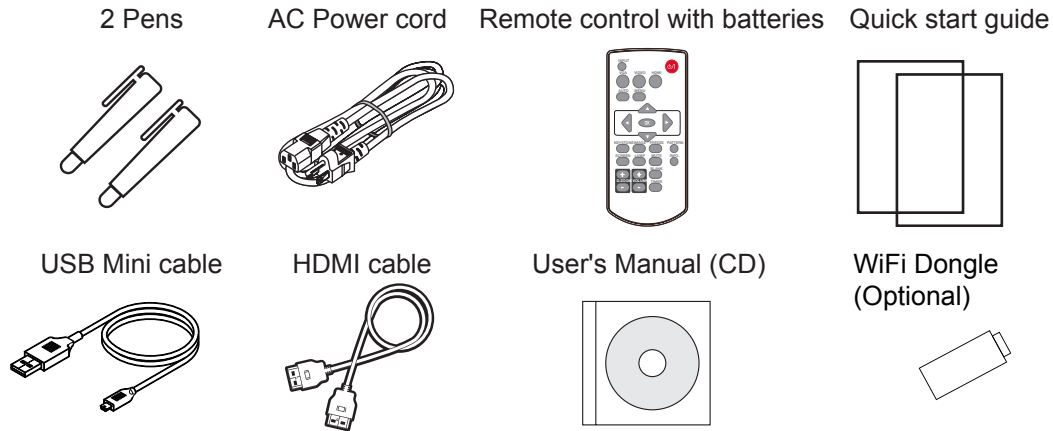
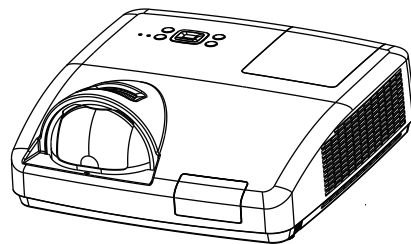

Positioning the projector

- The brightness in a room has a great influence on picture quality. It is recommended to limit the ambient lighting in order to get the best image.
- All measurements are approximate and may vary from the actual sizes.

XGA

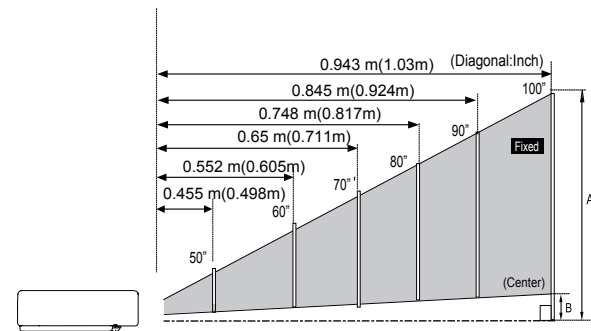

✓ Note: The data in "()" is the project distance for 16:9 aspect ratio.

4:3

Screen size	50"	60"	70"	80"	90"	100"
size (WxH)mm	1016	1219	1422	1626	1829	2032
4:3 aspect ratio	x	x	x	x	X	x
zoom fisso	0.455m	0.552m	0.65m	0.748m	0.845m	0.943m

16:9

Screen size	50"	60"	70"	80"	90"	100"
size (WxH)mm	1107	1328	1550	1771	1992	2214
16:9 aspect ratio	x	x	x	x	X	x
zoom fisso	0.498m	0.587m	0.692m	0.796m	0.9m	1.004m

WXGA

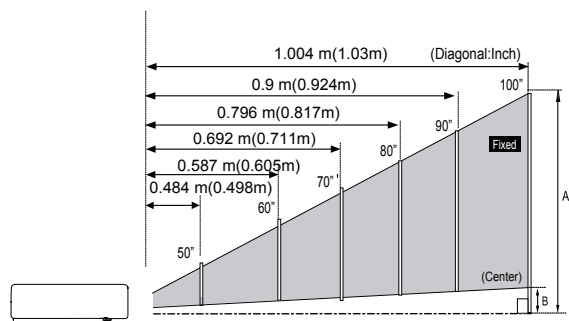

✓ Note: The data in "()" is the project distance for 16:9 aspect ratio.

16:10

Screen size	50"	60"	70"	80"	90"	100"
size (WxH)mm	1077	1292	1508	1723	1939	2154
16:10 aspect ratio	x	x	x	x	x	x
zoom fisso	0.484m	0.587m	0.692m	0.796m	0.9m	1.00m

16:9

Screen size	50"	60"	70"	80"	90"	100"
size (WxH)mm	1107	1328	1550	1771	1992	2214
16:9 aspect ratio	x	x	x	x	X	x
zoom fisso	0.498m	0.587m	0.692m	0.796m	0.9m	1.004m

Turn on the projector

1. Complete peripheral connections (with a computer, VCR, etc.) before turning on the projector.
2. Connect the projector's AC power cord into the AC outlet. The POWER indicator turns red.
3. Press the POWER button on the top control or on the remote control. The POWER indicator becomes green and the cooling fans start to work. The preparation display appears on the screen.
4. If the projector is locked with a PIN code, a PIN code input dialog box appears. Enter the PIN code as instructed below.



Move the cursor to "Set", and press "OK".

■ Enter a PIN code

Press the OK button, press ▲▼ button to select a number and press the OK button to enter it to the PIN code box, then number changes to "*", automatically move the cursor to next box. If you fixed an incorrect number, press MENU button to reset it again.

Repeat the steps to complete entering a three-digit number. After entering the three-digit number, automatically move the cursor to "Set", press the OK button then you can start to operate the projector.

If you entered an incorrect "PIN code", the number (***) turn red. PIN code will be reset within one second automatically, Enter the correct PIN code all over again.

Install remote control batteries

① Open the battery cover.

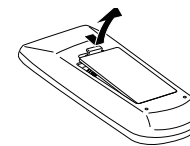

② Install new batteries.

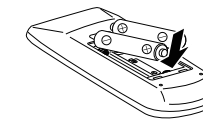

Two AAA batteries
For correct polarity (+ and -), be sure battery terminals are in contact with pins in the compartment.

③ Put the cover back.

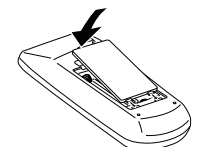

To ensure safe operation, please observe the following precautions:

- Use two (2) AAA or LR3 type alkaline batteries.
- Always replace batteries in sets.
- Do not use a new battery with a used battery.
- Avoid contact with water or liquid matter.
- Do not expose the remote control to moisture or heat.
- Do not drop the remote control.
- If the battery has leaked in the remote control, carefully wipe the case clean and install new batteries.
- Risk of explosion if two batteries are replaced by an incorrect type.
- Dispose of used batteries according to the instructions on the battery or local regulations or guides.

Operating range

Point the remote control toward the remote control receivers on the projector (front and back) when pressing any button.

The maximum operating range for the remote control is about 5 meters and 60 degrees.

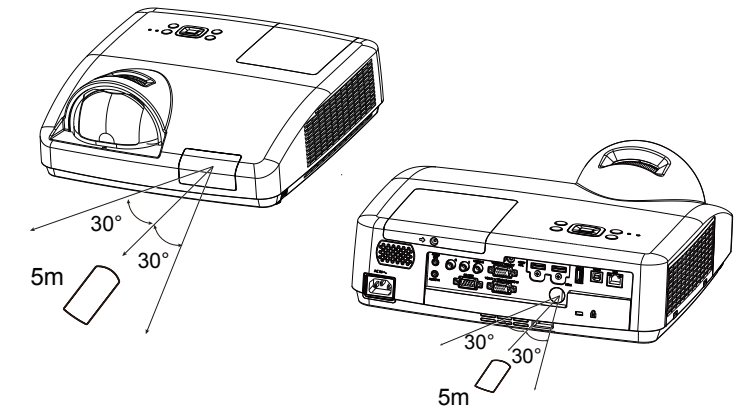

Adjustable foot

The projector can be adjusted up to 40 mm (10 degree) with the adjustable foot. Rotate the adjustable foot to lift the projector to a certain height. During lifting, rotate the foot clockwise.

To lower or retract the adjustable foot, rotate the foot counterclockwise. Keystone distortion of projected images can be corrected by auto settings, remote control operation or menu operation.

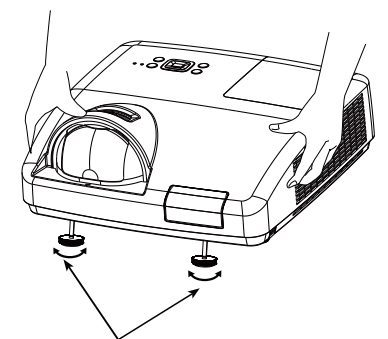

Adjustable foot

Installation

⚠ Unplug the power cords of both the projector and external equipment from the AC outlet before connecting the cables.

■ Connecting to computer

Cables used for connection:

- VGA cable
 - HDMI cable*
 - USB-Mini cable**
 - USB-Micro cable**
 - Serial cable(crossover type)*
- (*=Cables are not supplied with the projector)
(**=Cables are supplied by model.)

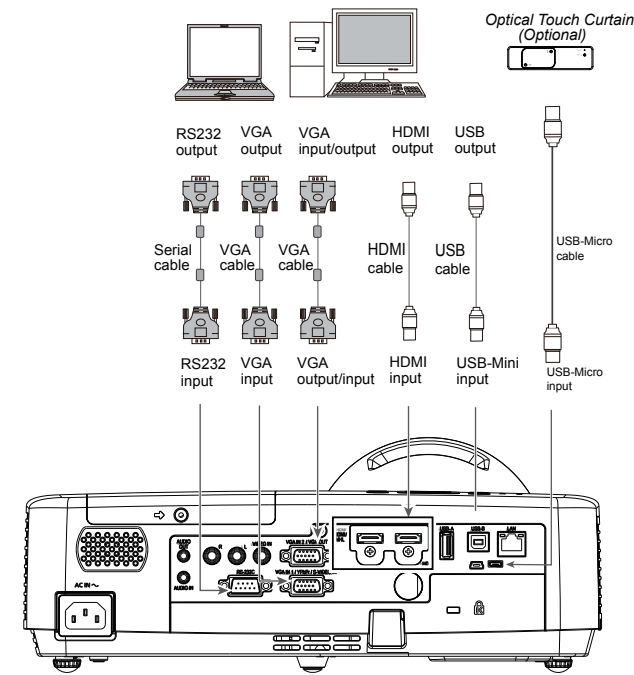

■ Connecting to video equipment (Video, S-Video)

- S-video cable**
 - Component conversion cable*
 - Video cable*
- (*=Cables are not supplied with the projector)
(**=Dedicated cable is required and can be ordered through your dealer)

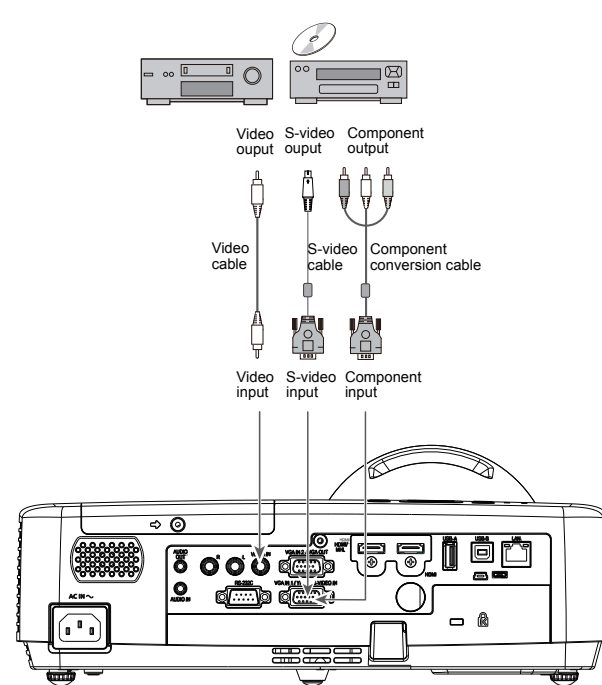

■ Connecting to audio equipment

- Audio cable*
- (*=Cables are not supplied with the projector)

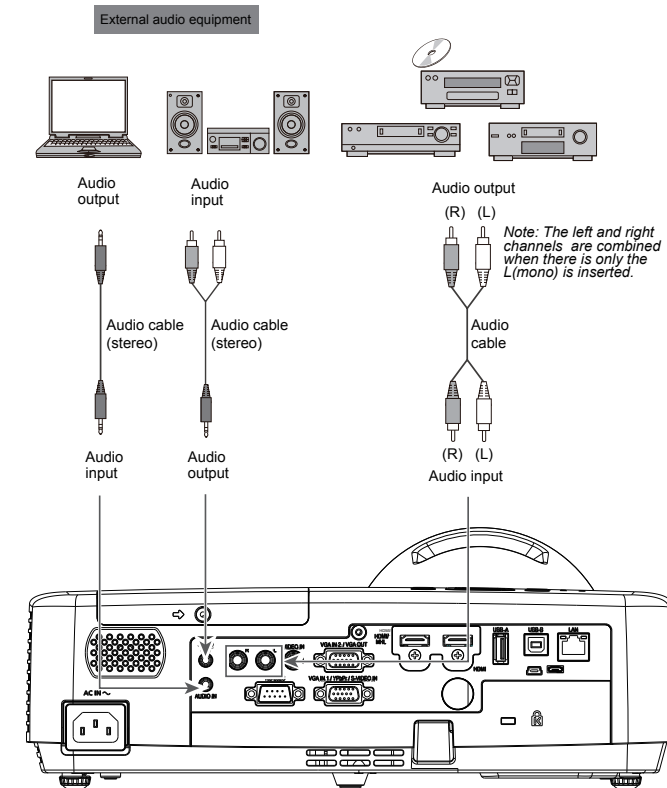

■ Connecting to USB device (USB-A, USB-B)

- USB-B cable*
 - WiFi Dingle(Optional) or USB-A device*
- (*=Cables are not supplied with the projector)

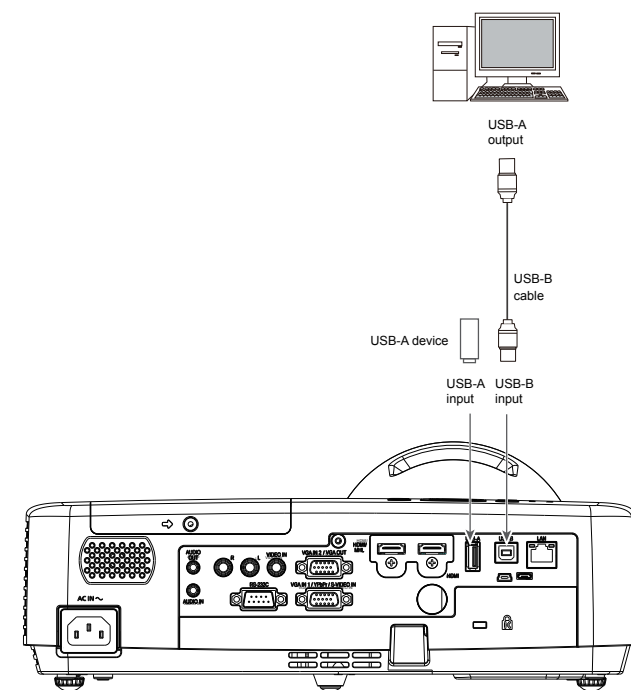

Turn off the projector

1. Press the POWER button on the top control or on the remote control, and "Power off?" appears on the screen.
2. Then, press the POWER button again in 4 seconds. The POWER indicator starts to flash red, and the cooling fans keep running (You can select the fan noise and running speed). Now you can unplug the AC power cord after the fans stop running. Otherwise, the service life of the projector will be affected or the projector will can not be turned on or turn on abnormal.
3. When the projector has cooled down enough to be turned on again, the POWER indicator stops flashing.

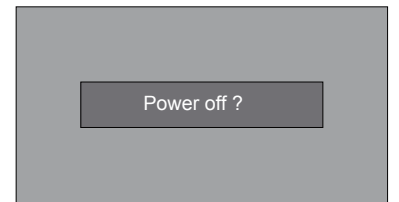

"Power off ?" disappears after 4 seconds.



- To maintain the lamp life, once you turn the projector on, wait at least 5 minutes before turning it off.
- Do not operate the projector continuously without reset. Continuous use may result in shortening the lamp life. Turn off the projector and let it standby for about an hour in every 24 hours.

Indicator and projector state

Check the indicator to know about the state of projector.

Indicator		State of projector
WARNING (Red)	POWER (Green/Red/Yellow)	
○	○	Your projector is in Off status (without AC power supply).
○	⊘	Your projector is in standby status. Press Standby button to turn it on.
○	⊘	Your projector is in normal status.
○	⊘	It is ready for standby or the lamp is cooling. You may power on your projector only after the lamp is fully cooled and the POWER light indicator stops flashing.
○	⊘	Your projector is in Ready mode.
⊘	⊘	Your projector cannot power on, as its internal temperature is too high. You may power it on after it is fully cooled, temperature backs to normal, and the POWER light indicator turns red.
⊘	⊘	Your projector detects lamp abnormality and switches into standby mode.
⊘	⊘	Your projector detects the temperature abnormality and switches into standby mode.
○	⊘	Your projector detects power abnormality.
○	⊘	Your projector detects fan abnormality
⊘	⊘	Your projector detects IRIS abnormality.
⊘	⊘	Your projector detects its usage time ≥ the life of the projector -300H when the projector usage time <1.1 times the life of the projector.
⊘	⊘	Your projector detects its usage time ≥ 1.1times the life of the projector.

⊘ Green ⊘ Flash green ⊘ Red ⊘ Flash red ⊘ Yellow ⊘ Flash Yellow ○ Off

* When the lamp reaches the end of its life, the LAMP indicator lights Yellow. In this case, replace the lamp with a new one promptly.

Troubleshooting



- High voltages are used to operate this projector. Do not attempt to open the cabinet.
- If problems still persist after following all operating instructions, contact the dealer where you purchased the projector or the service center.

Before calling your dealer or service center for assistance, check the items below once again :

- Make sure you have properly connected the projector to peripheral equipment.
- Make sure all equipment is connected to the AC outlet and the power is turned on.
- If the projector does not project an image when it is connected to a PC, restart the PC.

Problems	Solutions	Problems	Solutions
No power	- Plug the power cord of the projector into the AC power outlet. - Check whether the POWER indicator lights red. - Only when the POWER indicator lights red you can power on the projector again. - Check the WARNING indicator. If it is blinking red, the projector can not be powered on. - Check the projection lamp. - Unlock the "Key lock" function.	No image	- Check the connection between Computer or video equipment and the projector. - Images can show up only about 20 seconds after the projector is powered on. - If BLANK function is enabled, no image will appear on the screen. You can then press the BLANK button or other button on the remote control.
Input signals are automatically switched (can't be switched)	- Properly adjust the Input search function.	Indicators light or flash	- Refer to Indicators and projector condition to check the status of the projector.
Ambiguous images	- Adjust the focus. - Set a more proper projection distance. - Check whether the lens needs to be cleaned. - When moved from a environment with low temperature to the one with higher temperature, water will be condensed on the lens. If so, you have to wait till the condensed water disappears.	PIN code dialog box appears at start-up	- PIN code lock is being set.
		The remote control does not work	- Check the batteries. - Make sure no obstruction is between the projector and the remote control. - Make sure you are not too far from the projector when using the remote control. Maximum operating range is 5 m. - Unlock the Key lock function in the Setting menu for the remote control.