



# User Manual

## Vigilance 5 megapixel H.265 Outdoor Dome Camera

DCS-4605EV

---

# Preface

D-Link reserves the right to revise this publication and to make changes in the content hereof without obligation to notify any person or organization of such revisions or changes. Information in this document may become obsolete as our services and websites develop and change.

## Manual Revisions

Revision	Date	Description
1.00	06/15/2018	DCS-4605EV Revision A1 with firmware version 1.00

## Trademarks

D-Link and the D-Link logo are trademarks or registered trademarks of D-Link Corporation or its subsidiaries in the United States or other countries. All other company or product names mentioned herein are trademarks or registered trademarks of their respective companies.

Copyright © 2018 D-Link Corporation.

All rights reserved. This publication may not be reproduced, in whole or in part, without prior expressed written permission from D-Link Corporation.

---

# Table of Contents

<b>Product Overview.....</b>	<b>4</b>	Advanced.....	60
Package Contents.....	4	Camera Configuration.....	67
Introduction.....	5	Camera Options .....	71
System Requirements .....	5	Camera Info.....	71
Features.....	6	Time .....	72
Hardware Overview .....	7	Administration Settings .....	75
<b>Installation.....</b>	<b>9</b>	Camera Log .....	78
Mounting the Camera.....	9	<b>Technical Specifications.....</b>	<b>79</b>
Using the DCS-37-1 Mount (optional).....	12	<b>Regulatory Information .....</b>	<b>83</b>
Using the DCS-37-2 Mount (optional).....	14		
Using the DCS-37-3 Mount (optional).....	16		
Waterproofing Your Installation .....	17		
Software Installation.....	20		
<b>Configuration .....</b>	<b>23</b>		
Using the Configuration Interface.....	23		
Live Video .....	25		
Setup Wizard .....	27		
<b>Network Setup Wizard.....</b>	<b>28</b>		
Motion Detection Setup Wizard.....	30		
Settings .....	33		
Network Settings .....	33		
Camera Settings .....	39		
Recording Management .....	48		
Advanced Setup.....	60		

# Product Overview

## Package Contents



DCS-4605EV Vigilance 5 megapixel H.265 Outdoor Dome Camera



Cable Waterproofing Connector



Mounting Kit



CD-ROM with User Manual and software



Quick Installation Guide

If any of the above items are missing, please contact your reseller.

**Safety Notice:** Installation and servicing should be done by certified technicians to conform with all local codes and prevent voiding your warranty.

## Introduction

The DCS-4605EV Vigilance 5 megapixel H.265 Outdoor Dome Camera is a professional surveillance and security solution for small, medium, and large enterprises. It uses a 5 megapixel progressive scan CMOS sensor to deliver low-noise video and low-light capability ideal for surveillance applications. The DCS-4605EV is a complete surveillance solution featuring a built-in IR cut filter and IR LEDs effective to 20 meters, allowing it to stream simultaneous real-time Full HD resolution video during the day or at night in indoor and outdoor environments.

The DCS-4605EV can be accessed remotely, controlled and configured from any computer over your local network or through the Internet via a web browser. The simple installation and intuitive web-based interface offer easy configuration across the full range of its advanced feature set, including granular control over multiple video streams with different configurations and multicast video streams that help you manage your video bandwidth.

The DCS-4605EV has an IP66-certified weatherproof housing designed for both indoor and outdoor applications. The DCS-4605EV also incorporates Power over Ethernet (PoE), allowing it to be easily installed in a variety of locations without the need for supplemental power cabling. The combination of IP66 weatherproof housing, IK10 vandal-proof housing, IR-Cut Filter, IR LEDs, and PoE make the DCS-4605EV an ideal solution for a dependable and cost-effective 24 hour surveillance solution with easy clutter-free installation.

## System Requirements

- Computer with Microsoft Windows® 10, 8, or 7
- Internet Explorer 8, Firefox 20, or Chrome or higher
- Existing 10/100 Ethernet-based network with an available 802.3af Power over Ethernet (PoE) port

# Features

## **H.265 Compression**

The DCS-4605EV supports the latest H.265 compression algorithm to bring out the best performance in the compromise between quality, bandwidth, and storage space.

## **Simple to Maintain**

The DCS-4605EV is a stand-alone system with a built-in CPU, requiring no special hardware or software. The DCS-4605EV can be viewed and managed through most web browsers, including Internet Explorer®, Firefox®, and Chrome®.

## **Supports a Variety of Platforms**

With support for TCP/IP networking, HTTP, and other Internet related protocols, the DCS-4605EV can also be integrated easily into other Internet/ Intranet applications because of its standards-based features. The DCS-4605EV works in network that supports 10/100 Ethernet, making the DCS-4605EV easy to integrate into your existing network environment.

## **Advanced Event Management**

The DCS-4605EV can be set up to send e-mail notifications with snapshots when an event occurs, such as when motion is detected. Events can be triggered from several sources, such as motion detection and time-based events.

## **IR LEDs for Day and Night Functionality**

The built-in infrared LEDs enable night time viewing of up to 20 meters.

## **IP66 Weatherproof and Vandal-proof Housing**

The DCS-4605EV uses an IP66 weatherproof housing, allowing you to rest assured that in the toughest of conditions, it will continue to provide round-the-clock surveillance.

## **PoE (Power over Ethernet) for Flexible Installation**

The DCS-4605EV can draw all the power it needs from a PoE switch or PoE injector for a simple and clutter-free installation.

## **Remote Monitoring Utility**

The D-Link D-ViewCam™ application adds enhanced features and functionality for the camera and allows administrators to configure and access the camera from a separate site via Intranet or Internet. Other features include image monitoring, recording images to a hard drive, viewing up to 32 cameras on one screen, and taking snapshots.

## Hardware Overview

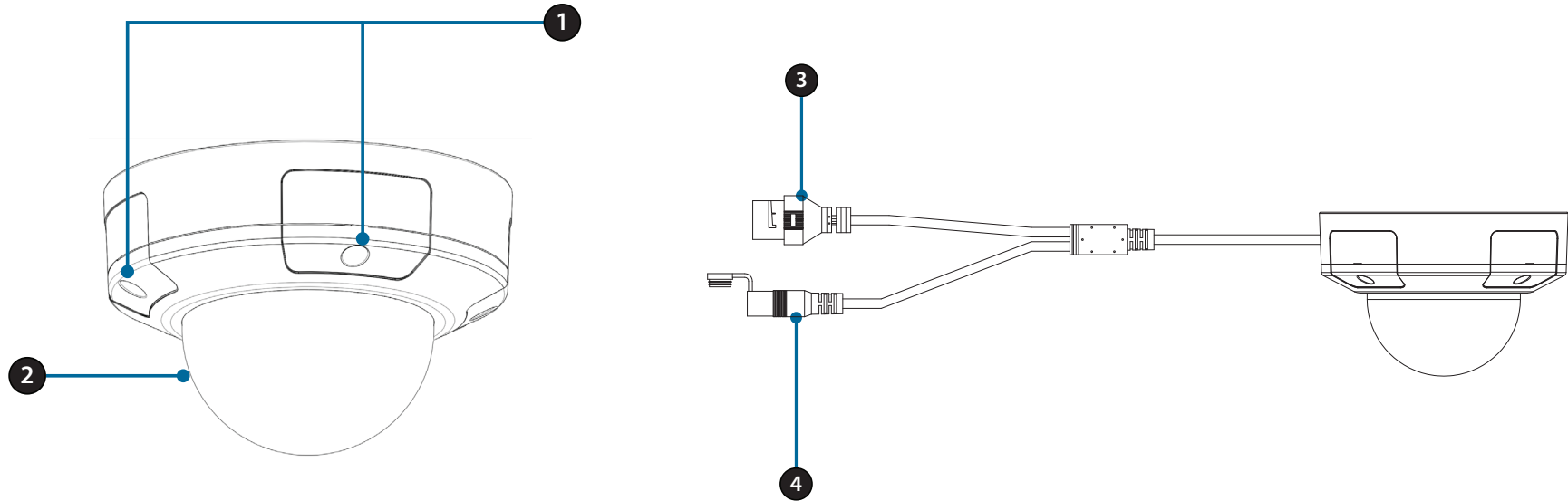

1	<b>Cover Screws</b>	These four screws can be removed with the included wrench.
2	<b>Protective Cover</b>	Protects the camera lens assembly from the environment.
3	<b>Ethernet Port</b>	RJ-45 connector for Ethernet which can also be used to power the camera using Power over Ethernet (PoE).
4	<b>Power Port</b>	Connects to an optional 12 V / 1.5 A power adapter (not included).

## Hardware Overview

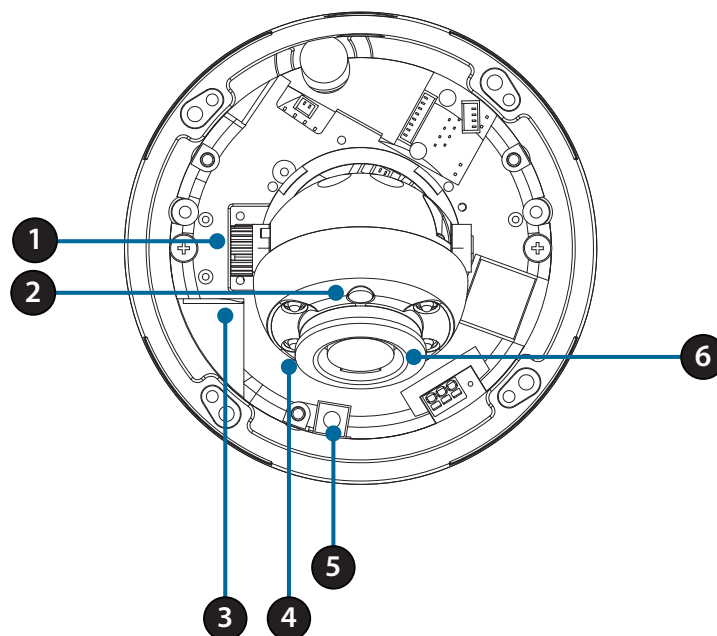

1	<b>Tilt Lock Screw</b>	Can be loosened to adjust the camera's tilt angle.
2	<b>Light Sensor</b>	Detects lighting levels and switches between day and night mode accordingly.
3	<b>microSD Card Slot</b>	Insert a microSD card for onboard storage of snapshots and video.
4	<b>IR LEDs</b>	Provide illumination for low-light environments.
5	<b>Reset Button</b>	Press and hold this button down for 10 seconds to reset the camera to factory default settings.
6	<b>Camera Lens</b>	Camera lens to record video of the surrounding area.



# Installation

## Mounting the Camera

It is highly recommended that you configure and test your camera before mounting it.

### Step 1

Place the mounting sticker where you want to position the camera.

Use a 6 mm drill bit to make the required holes approximately 25 mm deep, then insert the wall anchors into the holes.

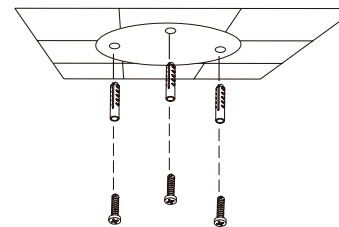

### Step 2

**If you are running the camera cables through the wall,** drill a hole in the center and pull the cables through the hole.

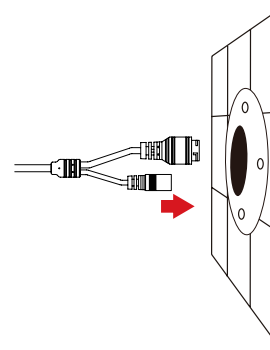

### Step 3

Use the included wrench to loosen the 4 screws on the top of the camera, then lift the camera cover off.

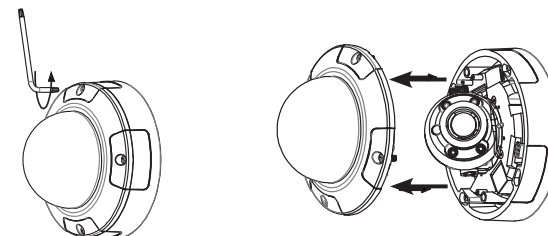

### Step 4

Use the screws provided to mount the camera to the wall.

**If you are running the camera cables out the side of the camera,** guide the camera cables through the cable channel on the base.

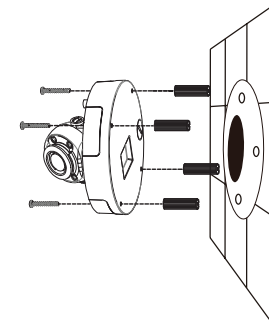

**If you are mounting the camera to the ceiling,** use a flathead screwdriver to remove the plastic hole cover from the bottom of the base, then guide the cables through the bottom.

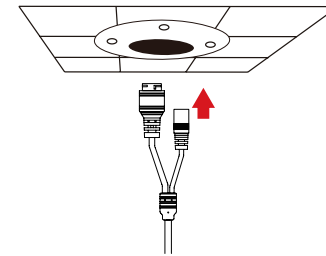

### Step 5

Connect the power and Ethernet cables, or just the Ethernet cable if you are using a PoE connection.

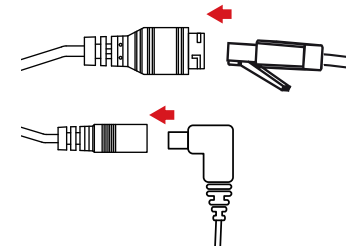

## Section 2: Installation

### Step 6

Loosen the adjustment screw on the side of the lens assembly, then re-tighten it after adjusting the lens assembly to the desired vertical angle. The camera supports from 30° to 90° of tilt. You can also adjust the pan within a -120° to 120° range by rotating it clockwise or counter-clockwise.

When you are done adjusting the camera's angle, put the inner cover back into place.

**Note:** The camera has a limited range of motion; if it stops when you are adjusting it, do not attempt to rotate or tilt the camera any further in that direction.

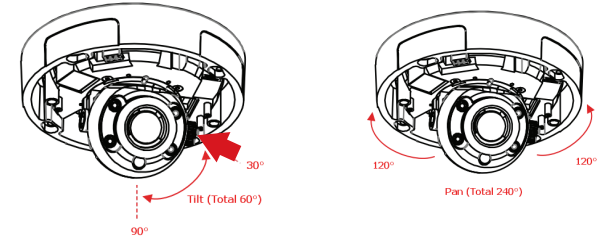

### Step 7

Use the screws provided to mount the camera to the ceiling.

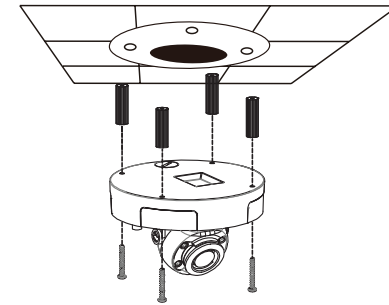

### Step 8

Re-attach the camera cover.

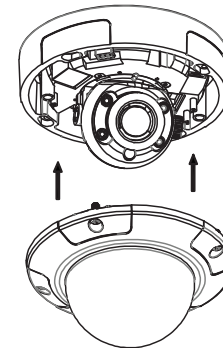

## Using the DCS-37-1 Mount (optional)

To mount the camera with the DCS-37-1 mount, follow the instructions below.

### Step 1

Place the DCS-37-1 mounting sticker in the desired location, then use a 6 mm drill bit to drill the required holes 25 mm deep and insert the wall anchors into the holes. If you plan to pass cables through the wall, you will also need to drill a hole for the cable channel.

**Note:** The camera in the corresponding graphics may be different from your product, but the basic process is the same.

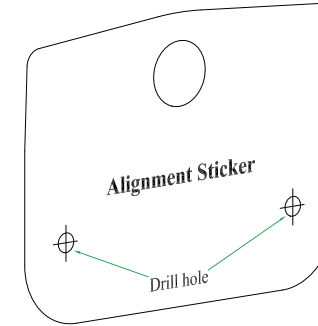

### Step 2

Use the provided screws to mount the DCS-37-1 to the wall.

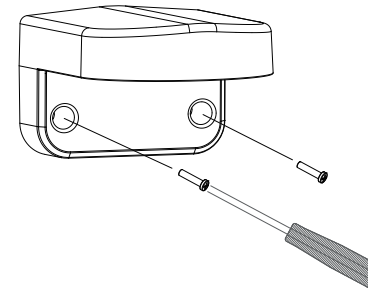

### Step 3

Guide the camera connectors through the back or bottom cable channel on the DCS-37-1. Then screw the mounting plate to the bracket using the set of mounting holes marked **B**.

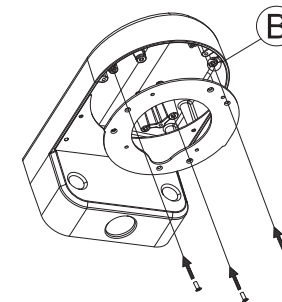

## Section 2: Installation

---

### Step 4

Remove the cover from the camera.

Use the provided screws to mount the camera to the DCS-37-1, then adjust the angle and rotation of the camera as desired using the tilt lock screw.

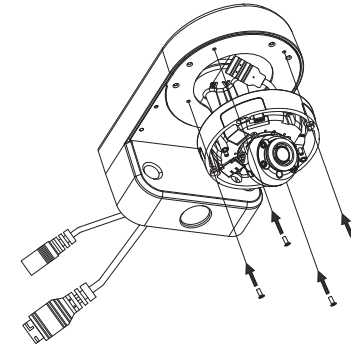

### Step 5

Attach the camera cover.

If you are passing the camera cables through the wall, place the rubber stopper into the bottom cable channel on the mount to seal it.

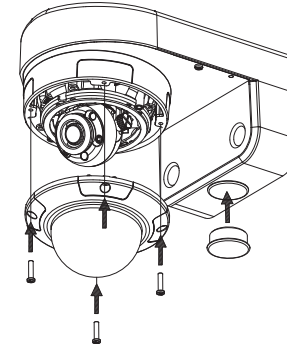

## Using the DCS-37-2 Mount (optional)

To mount the camera with the DCS-37-2 mount, follow the instructions below.

### Step 1

Place the DCS-37-2 mounting sticker in the desired location, then use a 6 mm drill bit to drill the required holes 25 mm deep and insert the wall anchors into the holes. If you plan to pass cables through the ceiling, you will also need to drill a hole for the cable channel.

**Note:** The camera in the corresponding graphics may be different from your product, but the procedure is the same.

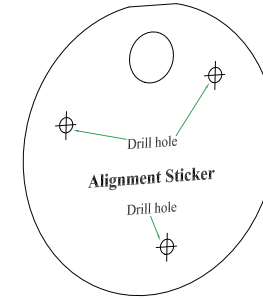

### Step 2

Use the provided screws to mount the DCS-37-2 to the wall using the inner mounting holes.

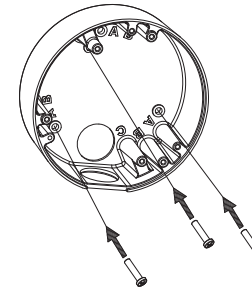

### Step 3

Guide the camera connectors through the back or side cable channel on the DCS-37-2. Use the provided screws to mount the camera to the DCS-37-2 using the set of mounting holes marked **B**.

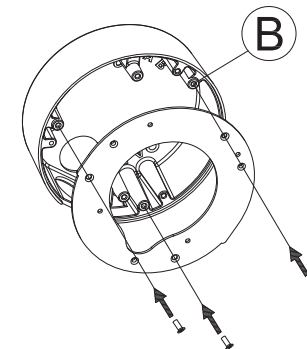

## Section 2: Installation

---

### Step 4

Remove the cover from the camera.

Use the provided screws to mount the camera to the DCS-37-2, then adjust the angle and rotation of the camera as desired using the tilt lock screw.

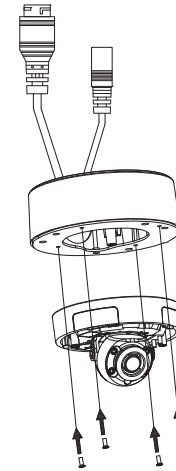

### Step 5

Attach the camera cover.

If you are passing the camera cables through the ceiling, place the rubber stopper into the side cable channel to seal it.

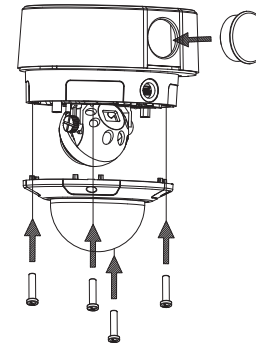

## Using the DCS-37-3 Mount (optional)

To mount the camera with the DCS-37-3 mount, follow the instructions below.

### Step 1

Place the DCS-37-3 mounting sticker in the desired location, then use a 6 mm drill bit to drill the required holes 25 mm deep and insert the wall anchors into the holes. If you plan to pass cables through the ceiling, you will also need to drill a hole for the cable channel.

**Note:** The camera in the corresponding graphics may be different from your product, but the procedure is the same.



### Step 2

Use the provided screws to mount the DCS-37-3 to the ceiling using the inner mounting holes.

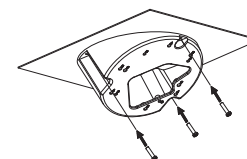

### Step 3

Remove the cover from the camera.

Guide the camera connectors through the bottom cable channel on the DCS-37-3. Use the provided screws to mount the camera to the DCS-37-3 using the set of mounting holes marked **D**.

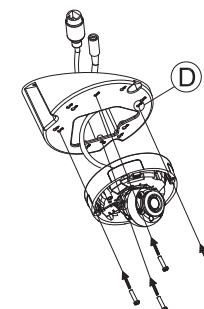

### Step 4

Remove the cover and adjust the angle and rotation of the camera as desired, then put the cover back in place. Screw the camera cover back in place.

Make sure the rubber stopper is in the side cable channel to seal it.

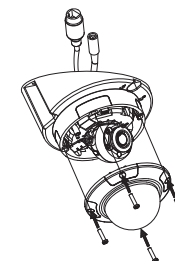



## Waterproofing Your Installation

To waterproof your camera installation, follow the instructions below. Round Ethernet cable, a crimping tool, and RJ-45 plugs are required for this procedure.

### Step 1

Place the washer around the base of the Ethernet connector as shown.

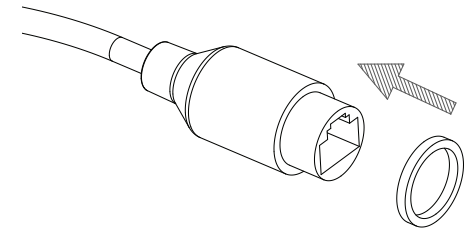

### Step 2

Thread bare Ethernet cable through the waterproof connector as shown, then crimp an RJ-45 plug onto the cable.

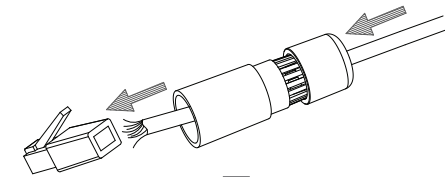

### Step 3

Crimp an RJ-45 connector onto the end of the cable.

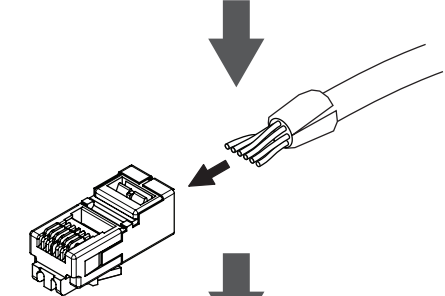

### Step 4

Connect the other end of the Ethernet cable to the camera's Ethernet port.

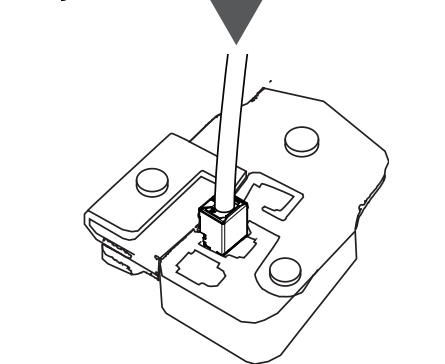

## Section 2: Installation

---

### Step 5

Connect the RJ-45 plug into the Ethernet connector, then screw the waterproof connector to the Ethernet connector by turning it about a half-turn clockwise.

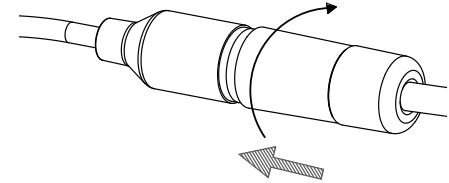
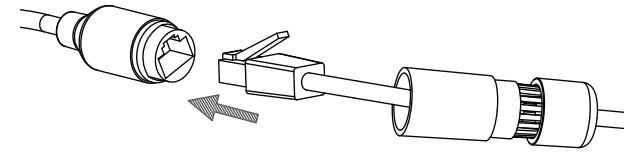

### Step 6

Screw the back part of the waterproof connector clockwise until there is a tight seal around the Ethernet cable.

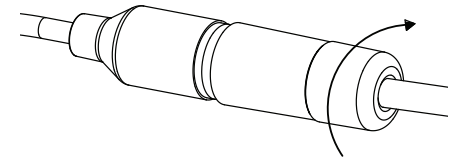

**If you are using PoE to power your camera,** use the power connector cap to seal the power connector.

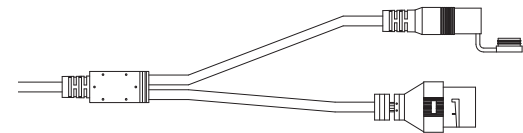

**If you are using a power adapter (not included) to power your camera,** wind waterproof tape around the connection in an overlapping manner to cover it.

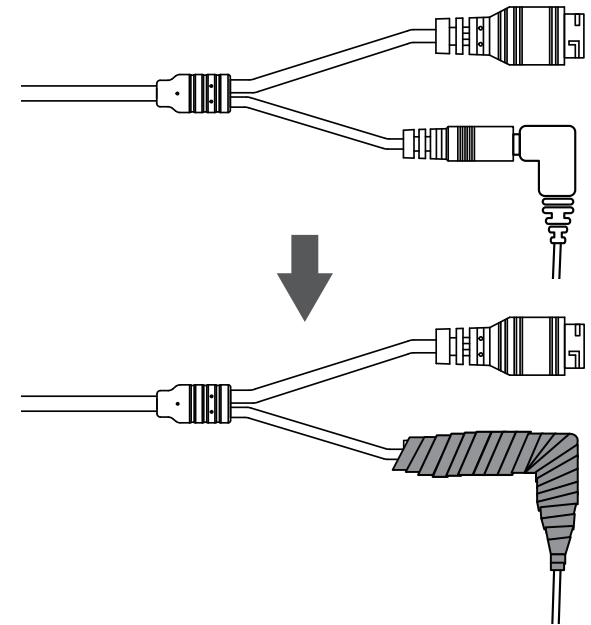

## Software Installation

### Step 1

Insert the DCS-4605EV CD into your computer's CD-ROM drive to begin the installation.

If the Autorun function on your computer is disabled, or if the D-Link Launcher fails to start automatically, click the Start button and type **D:\autorun.exe** (where D: represents the drive letter of your CD-ROM drive) and press **Enter**.



### Step 2

Click on the **D-Link Setup Wizard SE** icon that was created in your Windows Start menu (**Start > D-Link > Setup Wizard SE**).

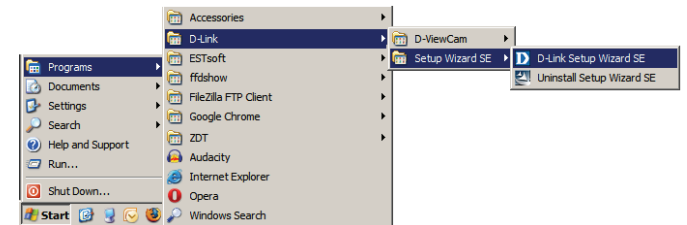

## Section 2: Installation

### Step 3

The Setup Wizard will appear and display the MAC address and IP address of your camera(s). If you have a DHCP server on your network, a valid IP Address will be displayed. If your network does not use a DHCP server, the network camera's default static IP **192.168.0.20** will be displayed.

Select your camera, then click the **Wizard** button to continue.



### Step 4

Enter the Admin ID and password. When logging in for the first time, the default Admin ID is **admin** with the password left blank.

Click the checkboxes if you wish to change the admin ID and password for the camera, and enter the new ID and password you wish to use.

Click **Next** to continue.

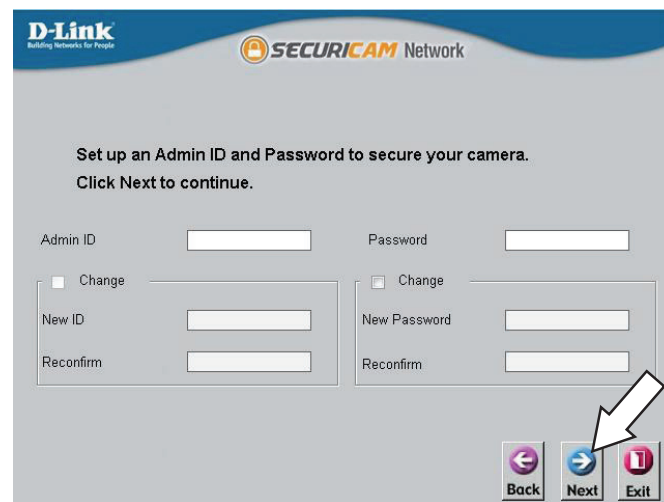

## Section 2: Installation

### Step 5

Select **DHCP** if your camera obtains an IP address automatically from a DHCP server such as a router. Select **Static IP** if you want to manually enter the IP settings for the camera.

Click **Next** to continue.



D-Link Building Networks for People

SECURICAM Network

### Set IP Address

DHCP

Static IP

IP Address

Subnet Mask

Default Gateway

Primary DNS

Secondary DNS

### Step 6

Take a moment to confirm your settings and click **Restart**.

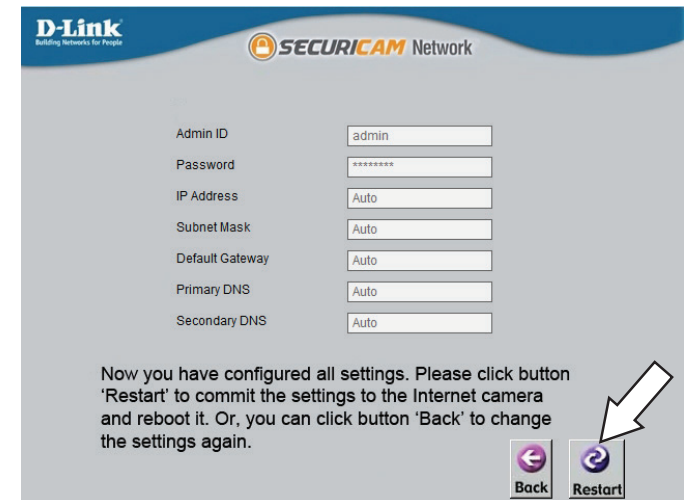

D-Link Building Networks for People

SECURICAM Network

Admin ID

Password

IP Address

Subnet Mask

Default Gateway

Primary DNS

Secondary DNS

Now you have configured all settings. Please click button 'Restart' to commit the settings to the Internet camera and reboot it. Or, you can click button 'Back' to change the settings again.

# Configuration

## Using the Configuration Interface

After completing the Camera Installation Wizard, you are ready to use your camera. The camera's built-in Web configuration utility is designed to allow you to easily access and configure your DCS-4605EV. At the end of the wizard, click **Link**, or enter the IP address of your camera into a web browser, such as Firefox. To log in, use the User name **admin** and the password you created in the Installation Wizard. If you did not create a password, the default password is blank. After entering your password, click **OK**.

### Step 1

Click on the **D-Link Setup Wizard SE** icon that was created in your Windows Start menu (**Start > D-Link > Setup Wizard SE**).

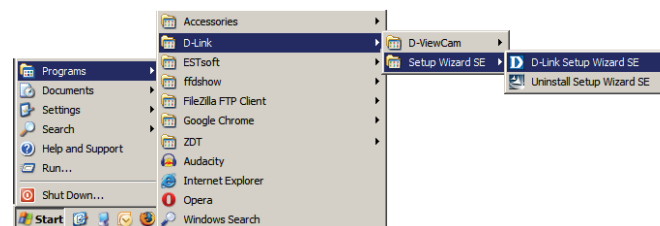

### Step 2

Select the camera and click **Link** to access the web configuration.

The Setup Wizard will automatically open your web browser to the IP address of the camera.

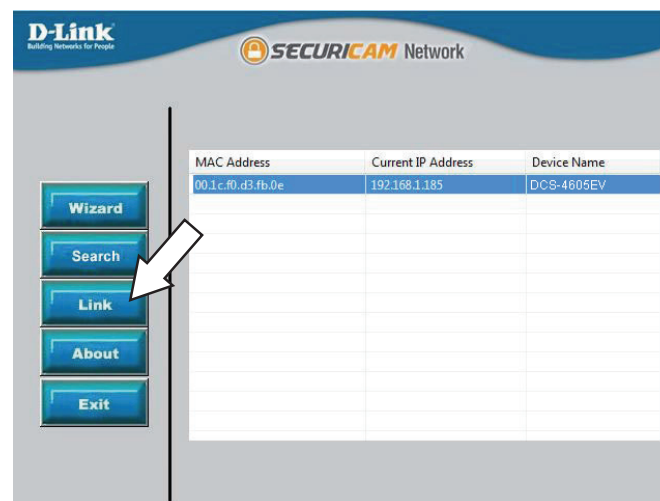

## Section 3: Configuration

### Step 3

The first time you connect to the camera, you will be asked to set a password for the administrator account. After entering a password, click **Save**.

OR

Under Password, enter the same password configured during setup and click **Login** to continue.

Select Language: English ▼

For security, it is recommended to change the password for your administrator account.

New Password:

Confirm New Password:

### Step 4

This section displays your camera's live video. You can select your video profile and view or operate the camera.















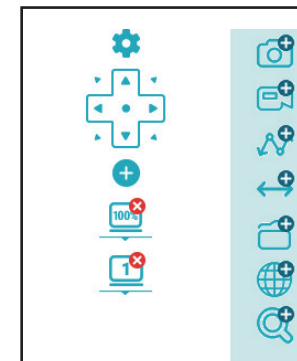

# Live Video

This section shows your camera's live video. You may select any of the available icons listed below to operate the camera. You may also select your language using the drop-down menu on the left side of the screen.





If your view window area is less than your frame size, you can click and drag on the live video to move the camera view around. Refer to **"Video Stream" on page 45**.

	<b>Setup</b>	Clicking this will take you to the camera configuration pages.
	<b>Control Pad</b>	If your view window area is less than your frame size, you can use the control pad to electronically pan and tilt. Click on the arrows to move the view in that direction. Click the center to return to the home position.
	<b>Edit Toolbar</b>	Clicking this will allow you to add and remove icons from the toolbar. This lets you create a custom toolbar with only the options you want.
	<b>Window Size</b>	You can choose between various screen sizes for your camera's video: <ul style="list-style-type: none"> <li>▪ <b>Auto Screen:</b> Automatically resize the camera video to match your browser window</li> <li>▪ <b>Full Screen:</b> View your camera video using the entire screen</li> <li>▪ <b>100% Screen:</b> View your camera's video at 100% size</li> <li>▪ <b>50% Screen:</b> View your camera's video at 50% size</li> <li>▪ <b>25% Screen:</b> View your camera's video at 25% size</li> </ul>
	<b>Video Profile 1/2</b>	Select a video profile to use. For more on setting up your video profiles, refer to <b>"Video Stream" on page 45</b> .
	<b>Take a Snapshot</b>	This will save a snapshot to your PC using the storage folder you have selected.
	<b>Record a Video Clip</b>	This will start recording a video clip to your PC using the storage folder you have selected. Click it again to stop recording. If you close the browser window, the recording will stop.



	<b>Patrol</b>	After creating a list of preset ePTZ camera positions, click this to automatically cycle through the preset sequence.
	<b>Auto Pan</b>	Click this to start automatically panning the currently selected view.
	<b>Set a Storage Folder</b>	Select a storage folder to save snapshots and video clips to.
	<b>Global View</b>	This will show a thumbnail of your camera's full view. This can be useful when you are zooming in on the video in the Live Video screen.
	<b>Zoom In/Out</b>	Click this and use the slider to zoom in and out of your camera's video.

You can find these icons in the top-right corner of the Live Video screen:

	<b>Alarm</b>	This will flash red when motion is detected or a DI signal is received.
	<b>Record Status</b>	This will turn red when the camera is recording.
	<b>Help</b>	Click this to open a window that describes the Live Video controls.
	<b>Logout</b>	Click this to log out of the web interface.

# Setup Wizard

This page lets your use setup wizards to walk you through setting up your camera's network and motion detection settings.

**Network Setup Wizard:** Click on this button to start the Network Setup Wizard. Refer to **"Network Setup Wizard" on page 28.**

**Motion Detection Setup Wizard:** Click on this button to start the Motion Detection Setup Wizard. Refer to **"Motion Detection Setup Wizard" on page 30.**

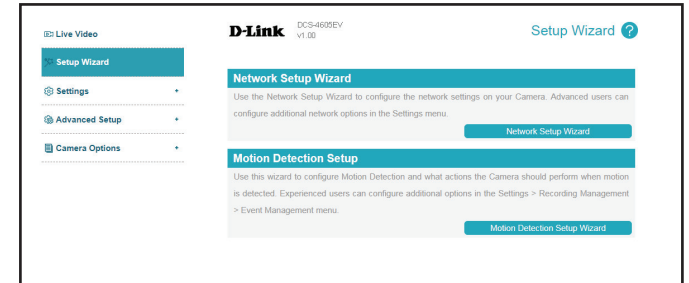

## Network Setup Wizard

This wizard will guide you through a step-by-step process to configure your camera and connect it to the Internet. Click **Next** to continue.

### Step 1:

Select how the camera will connect to the Internet.

- If your camera is connected to a router, or you are unsure how your camera will connect to the Internet, select **DHCP**.
- Select **Static IP Client** if your Internet Service Provider has provided you with connection settings, or if you wish to set a static address within your home network. Enter the correct configuration information and click **Next** to continue.
- If you are using PPPoE, select **PPPoE** and enter your user name and password.

Click **Next** to continue.

### Network Setup Wizard

This wizard will configure your D-Link camera and make it accessible to your network. To configure your camera, we will go through the following steps:

- Step 1: Configure LAN Settings
- Step 2: Configure Dynamic DNS
- Step 3: Assign a Name to the Camera
- Step 4: Set your Camera's Time Zone

Back Next

### Step 1: Configure LAN Settings

Select how your camera will connect to your network. If your camera is connected to a router or you are unsure what settings to choose, select DHCP. Otherwise, select Static IP to configure a static IP address or enter the username and password from your ISP to connect via PPPoE.

DHCP

Static IP Client

IP Address

Subnet Mask

Default Router

Primary DNS

Secondary DNS

PPPoE

User Name

(e.g. 654321@hinet.net)

Password

Back Next

### Step 2:

If you have a Dynamic DNS account and would like the camera to update your IP address automatically, select **Enable DDNS** and enter your host information. Click **Next** to continue.

### Step 3:

Enter a name for your camera and click **Next** to continue.

### Step 4:

Set the correct time to ensure that all events will be triggered as scheduled. Click **Next** to continue.

### Step 5:

Confirm the settings are correct and click **Finish** to save them. The settings will be saved to the DCS-4605EV and the camera will restart.

#### Step 2: Configure Dynamic DNS

If you have a Dynamic DNS account, you can configure your camera to update your external IP address automatically by enabling DDNS and entering your account details. Click Next to continue.

DDNS

Server Address  <<

Host Name

User Name

Password

Verify Password

Timeout  (hours)

[Back](#) [Next](#)

#### Step 3: Assign a Name to the Camera

We recommend that you give your Camera a unique name to easily identify it on your network.

Camera Name  32 characters maximum

[Back](#) [Next](#)

#### Step 4: Set your Camera's Time Zone

Please set the correct time zone for your camera to ensure that all events are triggered, captured, and scheduled correctly.

Time Zone

Daylight Saving

[Back](#) [Next](#)

#### Step 5: Setup Complete

The summary below shows the options you have selected. Click Finish to apply these options or click Back if you wish to make changes. Please make a note of these settings to ensure you can access your Camera in the future.

IP Address	DHCP
Camera Name	DCS-4605EV
Time Zone	(GMT+08:00) Taipei
DDNS	Disable
PPPoE	Disable

[Back](#) [Finish](#)

# Motion Detection Setup Wizard

This wizard will guide you through a step-by-step process to configure your camera's motion detection functions.

Click **Next** to continue.

## Step 1

This step will allow you to enable or disable motion detection, specify the detection sensitivity, and define what parts of the camera's view to monitor for motion.

You may specify whether the camera should capture a snapshot, record a video clip, or save a system log when motion is detected.

Please refer to **"Motion" on page 57** for more information about how to configure motion detection.

Click **Next** to continue.

## Step 2

This step allows you to enable motion detection based on a customized schedule. Specify the day and hours. You may also choose to always record whenever motion is detected.

Click **Next** to continue.

**Welcome To D-LINK Setup Wizard - Motion Detection**

This wizard will guide you through a step-by-step process to configure your IP Camera's motion detection functions. To setup the IP Camera LAN or Internet settings, please click on the Back button to close this wizard and re-open the IP Camera Setup wizard. Otherwise click on the Next button to begin.

- Step 1: Specify Motion Detection Area Settings
- Step 2: Motion Detection Schedule
- Step 3: Alerts and Notifications

[Back](#) [Next](#)

**step 1: Specify Motion Detection Area Settings**

This section will allow you to enable or disable motion detection as well as control the sensitivity of your Camera's ability to detect movement.

Motion Detection Settings  Snapshot  Video Clip  Camera Log



Percentage    
Sensitivity

1  2  3

[Add](#) [Delete](#) [Save](#)

[Back](#) [Next](#)

**Step 2: Motion Detection Schedule**

This wizard will guide you through a step-by-step process to configure your IP Camera's motion detection functions. To setup the IP Camera LAN or Internet settings, please click on the Back button to close this wizard and re-open the IP Camera Setup wizard. Otherwise click on the Next button to begin.

Sun  Mon  Tue  Wed  Thu  Fri  Sat

Time

Always

From   To

[Back](#) [Next](#)

### Step 3

This step allows you to specify where to send the snapshot/video clip/system log when motion is detected. Select **E-mail**, **FTP**, **Network Storage**, or **SD Card**, and enter the relevant information.

Click **Next** to continue.

### Step 3: Alerts and Notification

This final step allows you to specify how you receive notification of camera events. Choose between an email notification or alternatively you can setup an FTP Notification. You will need your email account settings or FTP details. If you are unsure of this information, please contact your ISP. Once you have entered this information, please click on the Next button.

Server Name:

Email

Sender Email Address

Recipient Email Address

Server Address

User Name

Password

Port

StartTLS

FTP

Server Address

Port

Login Type

User Name

Password

Remote Folder Name

Passive Mode

Network Storage

Network Storage Location

(for example: \\my\_nas\disk\folder)

Workgroup

User Name

Password

Primary WINS Server

SD Card

[Back](#) [Next](#)

### Step 4

You have completed the Motion Detection Wizard.

Please verify your settings and click **Finish** to save them.

Please wait a few moments while the camera saves your settings and restarts.

### Step 4: Setup Complete

You have completed your IP Camera setup. Please click the Back button if you want to review or modify your settings or click on the Apply button to save and apply your settings.

Motion Detection :	Enable
EVENT :	System Log
Schedule Day :	Sun ,Mon ,Tue ,Wed ,Thu ,Fri ,Sat ,
Schedule Time :	Always
Alerts and Notification :	SD Card

[Back](#) [Finish](#)



# Settings

## Network Settings

### LAN Settings

Use this section to configure the network connections for your camera. All relevant information must be entered accurately. Please note that PPPoE must be disabled to make any changes on this page; refer to **"PPPoE" on page 34** for more details. After making any changes, click the **Save** button to save your changes.

**DHCP:** Select this connection if you have a DHCP server running on your network and would like your camera to obtain an IP address automatically.

If you choose DHCP, you do not need to fill out the IP address settings.

**Static IP Client:** You may obtain a static or fixed IP address and other network information from your network administrator for your camera. A static IP address may simplify access to your camera in the future.

**IP Address:** Enter the fixed IP address in this field.

**Subnet Mask:** This number is used to determine if the destination is in the same subnet. The default value is 255.255.255.0.

**Default Gateway:** Enter the gateway used to forward frames to destinations in a different subnet. Invalid gateway settings may cause the failure of transmissions to a different subnet.

**Primary DNS:** Enter the primary domain name server for translating domain names to IP addresses.

**Secondary DNS:** Enter the secondary domain name server for translating domain names to IP addresses.

The screenshot displays the 'LAN Settings' interface for a D-Link camera. The 'DHCP' option is selected, and the 'Static IP Client' section is visible but not active. The 'IP Address' field is set to 192.168.0.158, 'Subnet Mask' is 255.255.255.0, 'Default Router' is 192.168.0.1, 'Primary DNS' is 192.168.0.1, and 'Secondary DNS' is 192.168.168.201. A 'Save' button is located at the bottom right of the form.

## IPv6

Use this section to configure your camera's IPv6 settings. After making any changes, click the **Save** button to save your changes.

**Enable IPv6:** Enable the IPv6 setting to use the IPv6 protocol.

**Manually Setup The IP Address:** Enabling the option allows you to manually set up the address, specify an optional IP address, specify an optional router address, and an optional primary DNS address. You can click the **Information** button to see the IPv6 address lists for the host, gateway, and DNS server.

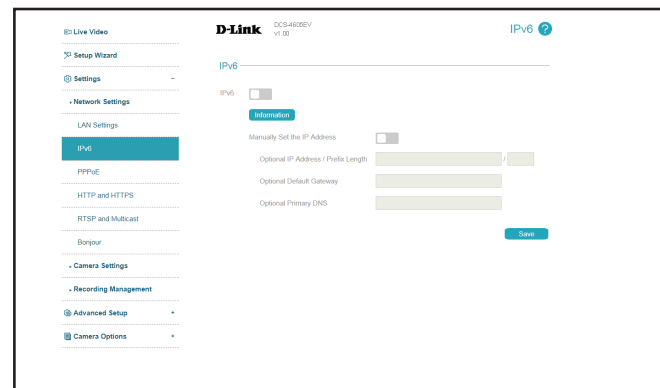

## PPPoE

Use this section to configure your camera's PPPoE settings. After making any changes, click the **Save** button to save your changes.

**Enable PPPoE:** Enable this setting if your network uses PPPoE.

**User Name / Password:** Enter the username and password for your PPPoE account. Re-enter your password in the Confirm Password field. You may obtain this information from your ISP.

**PPPoE Status:** This shows your current PPPoE connection status.

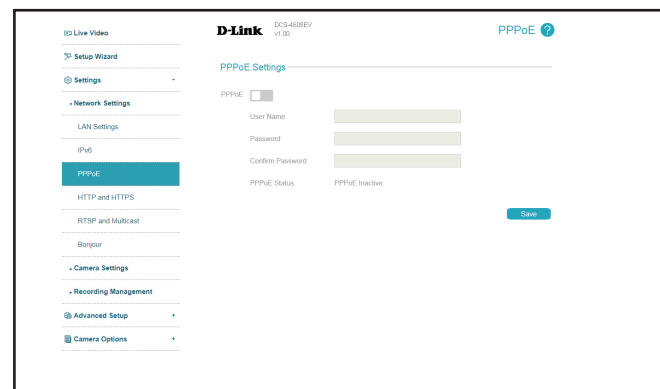

## HTTP and HTTPS

Use this section to configure the HTTP and HTTPS access settings for your camera. After making any changes, click the **Save** button to save your changes.

### HTTP

**Stream Authentication:** Enable or disable stream authentication.

**HTTP Port:** The default port number is 80.

**Access Name for Stream 1~3:** The default name is video#.mjpg, where # is the number of the stream.

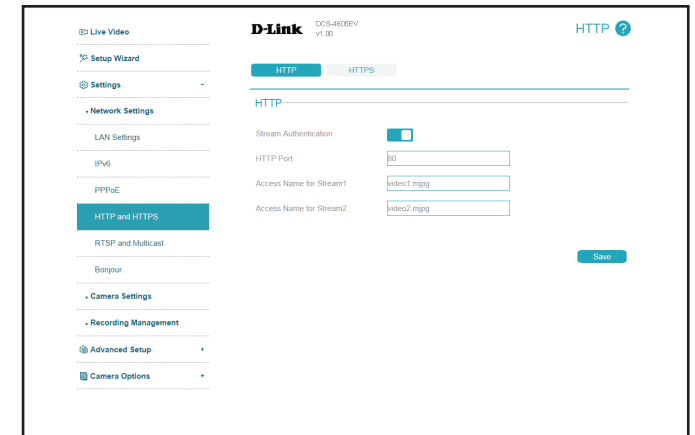

### HTTPS

**HTTPS Port:** You may use a PC with a secure browser to connect to the HTTPS port of the camera. The default port number is 443.

**Enable HTTPS Secure Connection:** Enable the HTTPS service.

**Create Certificate Method:** Choose the way the certificate should be created. Three options are available:

- Create a self-signed certificate automatically
- Create a self-signed certificate manually
- Create a certificate request and install

**Status:** Displays the status of the certificate.

**Note:** The certificate cannot be removed while the HTTPS is still enabled. To remove the certificate, you must first uncheck **HTTPS secure connection**.

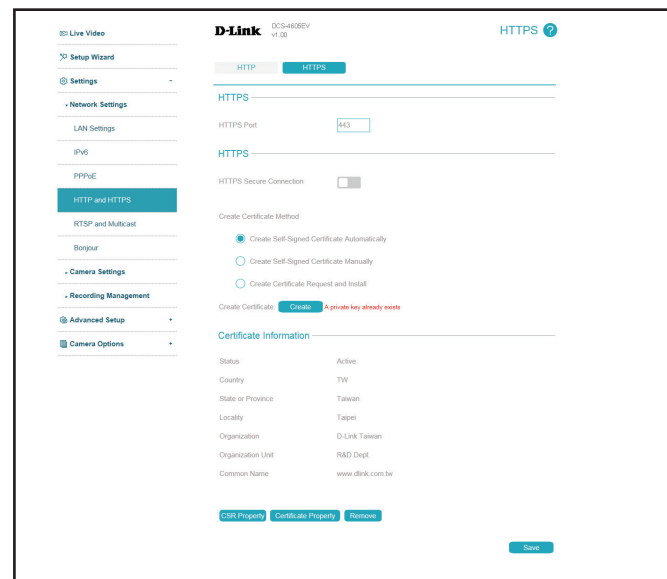

## RTSP and Multicast

Use this section to configure your camera's RTSP and multicast stream settings. After making any changes, click the **Save** button to save your changes.

### RTSP

**Authentication:** Choose to enable or disable RTSP digest encryption. Digest encryption uses MD5 hashes.

**RTSP Port:** The port number that you use for RTSP streaming to mobile devices, such as mobile phones or PDAs. The default port number is 554.

**Access Name for Stream 1/2:** You may specify the address of a particular stream. For instance, live1.sdp can be accessed at rtsp://x.x.x.x/video1.sdp where the x.x.x.x represents the ip address of your camera.

### Multicast

**Multicast for Stream 1/2:** The DCS-4605EV allows you to multicast each of the available streams via a group address and specify the TTL value for each stream. Enter the port and TTL settings you wish to use if you do not want to use the defaults.

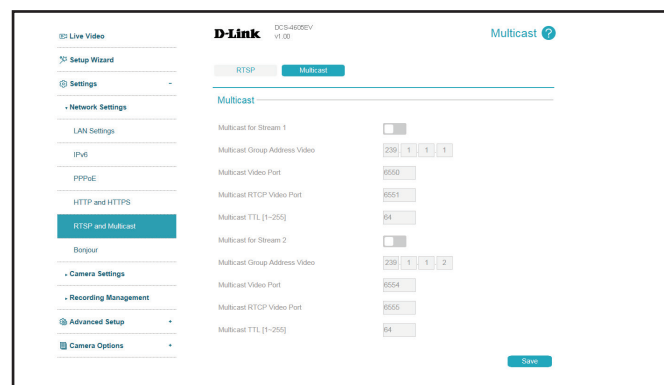
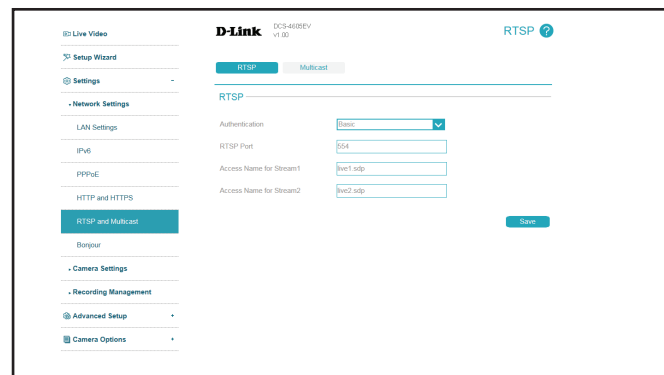

## Bonjour

Use this section to enable Bonjour, which allows your camera to be accessed more easily on your network. After making any changes, click the **Save** button to save your changes.

**Bonjour:** Enable this to enable Bonjour support.

**Bonjour Name:** Enter a name to identify this camera on Bonjour.

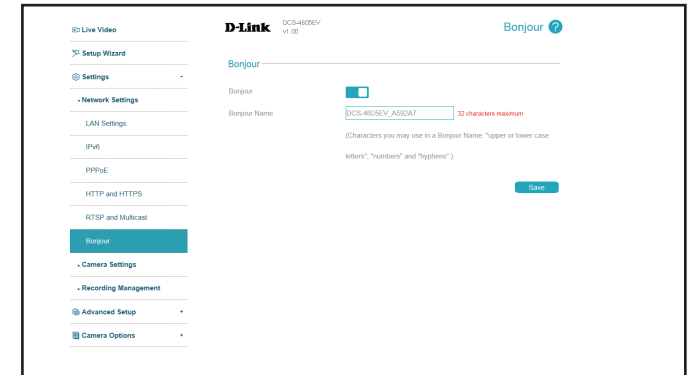

## Camera Settings

### Camera Settings

Use this section to configure the device name and LED behavior for your camera. After making any changes, click the **Save** button to save your changes.

**Camera Name:** Create a unique name for your camera that will be added to the file name prefix when creating a snapshot or a video clip.

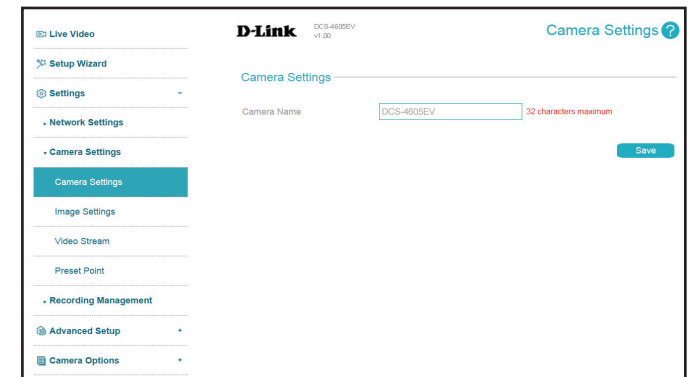

## Image Settings

In this section, you may configure the video image settings for your camera. All changes in the Image Settings section will be made immediately. For the other sections, after making any changes, click the **Save** button to save your changes.

### Image

**Mirror:** This will mirror the image horizontally.

**Flip:** This will flip the image vertically. When turning Flip on, you may want to consider turning **Mirror** on as well.

**DIS:** Enabling Digital Image Stabilization (DIS) will slightly reduce the viewing area of the camera in order to provide image stabilization. This is useful when the camera is mounted in a place that may be affected by wind or vibration.

**Anti-Flicker:** Select the frequency used by your power lines to avoid interference or distortion.

If the Anti-Flicker is set on 50 Hz, the max. frame rate option will be 25fps; If Anti-Flicker is set on 60 Hz, the max. frame rate option will be 30fps.

**White Balance:** Use the drop-down box to change white balance settings to help balance colors for different environments. You can choose from **Auto**, **Outdoor**, **Indoor**, **Fluorescent**, and **Push Hold**. If you choose **Push Hold**, hold a white card or grey card in front of the camera, then click the **Save** button to set the camera's white balance.

**Exposure Mode:** Changes the exposure mode. Use the drop-down box to set the camera for **Indoor**, **Outdoor**, or **Night** environments, or to **Moving** to capture moving objects. The **Low Noise** option will focus on creating a high-quality picture without noise. You can also create 3 different custom exposure modes. Max Gain will limit the brightness of the exposure.

**Denoise:** This setting controls the amount of noise reduction that will be applied to the picture.

**3D Denoise:** This setting controls the amount of 3D denoise that will be applied to the picture. 3D denoise reduces the amount of image noise when viewing a low-light environment.

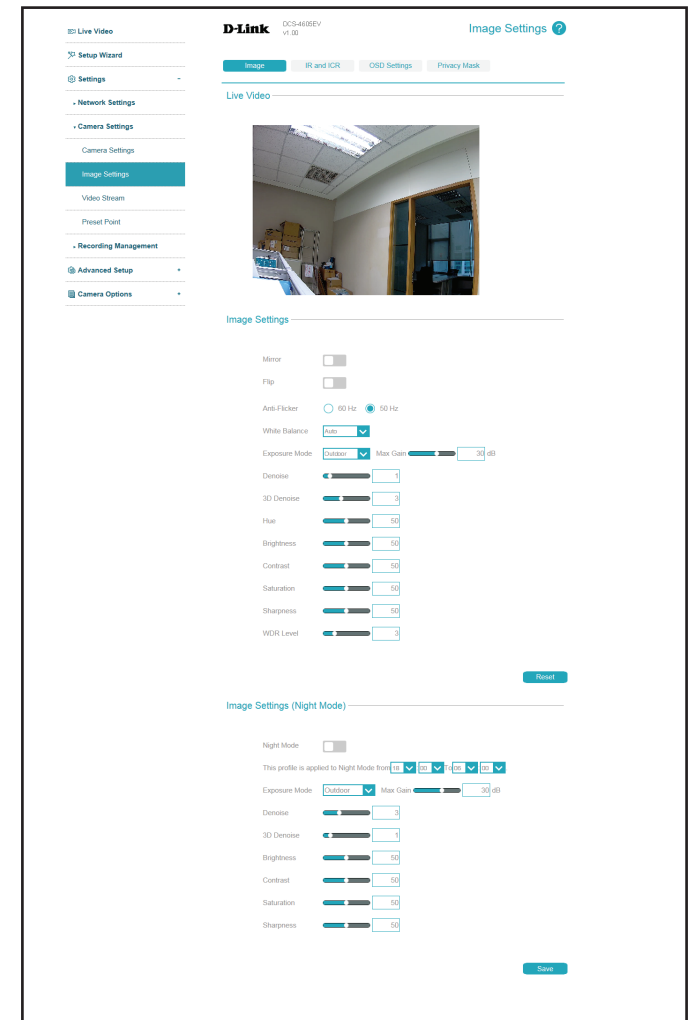



**Hue:** Adjust this setting to change the color of the camera video.

**Brightness:** Adjust this setting to compensate for backlit subjects.

**Contrast:** Adjust this setting to alter the color intensity/strength.

**Saturation:** This setting controls the amount of coloration, from grayscale to fully saturated.

**Sharpness:** Specify a value from 0 to 100 to specify how much sharpening to apply to the image.

**WDR Level:** Wide Dynamic Range (WDR) helps improve exposure, making it easier to see objects in very bright or dark areas of the camera's image. Specify a value from 0 to 10 to specify how much WDR adjustment to apply to the image, or select **None**.

**Reset:** Click this button to reset the image to factory default settings.

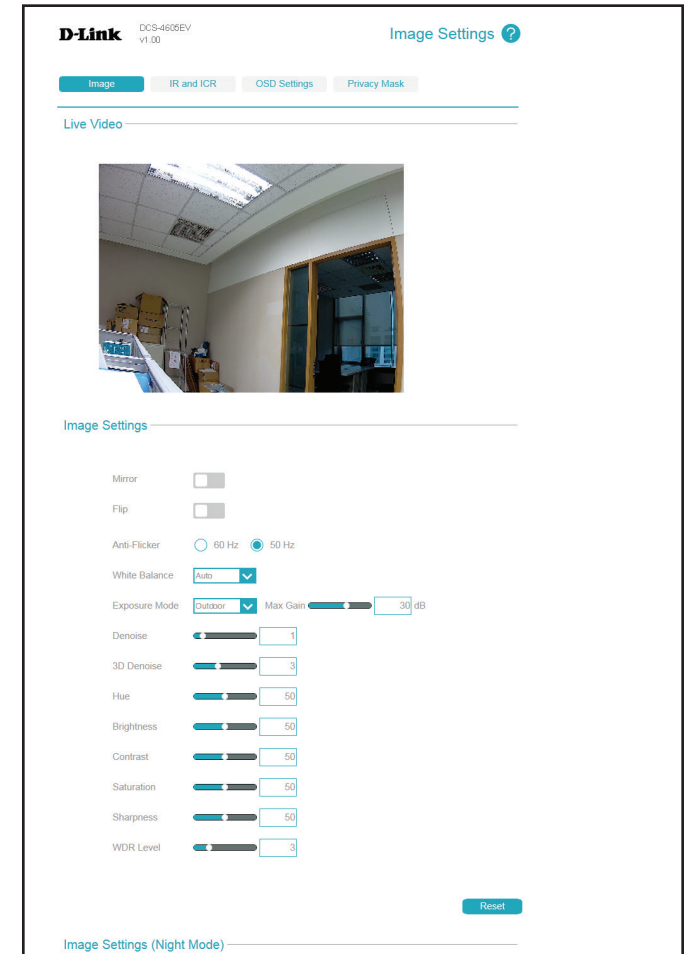

**Night Mode:** Here, you can enable a different set of image settings for when the camera uses night mode. To do so, enable **Night Mode**, select the period of time you want the different image settings to apply, then adjust the image settings as desired. After making any changes, click the **Save** button to save your changes.

**Note:** This does not control when night mode will be used; this only controls when these image settings will be used.

**This profile is applied to Night Mode from:** If Night Mode is enabled, you can set a schedule via the drop-down boxes to set the time span for the settings to take effect.

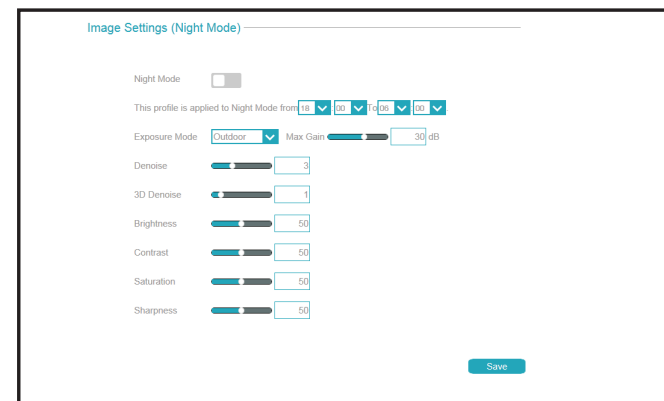

**Exposure Mode:** Changes the exposure mode. Use the drop-down box to set the camera for **Indoor**, **Outdoor**, or **Night** environments, or to **Moving** to capture moving objects. The **Low Noise** option will focus on creating a high-quality picture without noise. You can also create 3 different custom exposure modes. Max Gain will limit the brightness of the exposure.

**Denoise:** This setting controls the amount of noise reduction that will be applied to the picture.

**3D Denoise:** This setting controls the amount of 3D denoise that will be applied to the picture. 3D denoise reduces the amount of image noise when viewing a low-light environment.

**Brightness:** Adjust this setting to compensate for backlit subjects.

**Contrast:** Adjust this setting to alter the color intensity/strength.

**Saturation:** This setting controls the amount of coloration, from grayscale to fully saturated.

**Sharpness:** Specify a value from 0 to 100 to specify how much sharpening to apply to the image.

### IR & ICR

Use this section to configure the IR LED and IR-cut removable filter behavior for your camera.

**Automatic:** The Day/Night mode is set automatically. Generally, the camera uses Day mode and switches to Night mode when needed. Use the **Sensitivity** drop-down box to select when the camera should switch to Night mode. The text to the right of the drop-down box shows what the current lighting conditions are like, and you can refresh this information by clicking the **Refresh** button.

**Day Mode:** Day mode enables the IR Cut Filter and turns off the IR LEDs.

**Night Mode:** Night mode disables the IR Cut Filter and turns on the IR LEDs.

**Schedule Mode:** Set Day/Night mode using the schedule set in the drop-down boxes. The camera will enter Day mode at the starting time and return to Night mode at the ending time.

Activate the **Disable IR LED** to set Day mode for the set times.

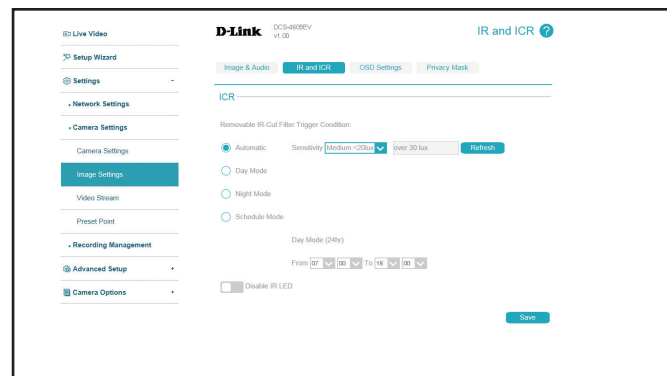

### OSD Settings

**OSD:** Select this option to enable the On-Screen Display feature for your camera. This will allow some information to appear in the top-left corner of the camera's video.

**Label:** Enter a label for the camera, which will be shown on the OSD when it is enabled.

**Show Time:** Select this option to enable the time-stamp display on the video screen.

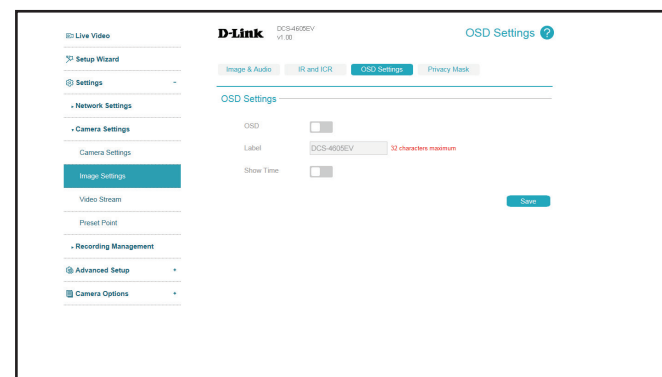

### Privacy Mask

**Privacy Mask Settings:** To add a privacy mask window, click the **Add** button. A privacy mask window will appear in the top-left corner of the live video. After moving and resizing the window how you wish, click **Save** to save your changes.

To modify an existing privacy mask window, click on the button next to the window's number, then move and resize it as you wish. You can delete the window by clicking the **Delete** button.

The Privacy Mask setting allows you to define up to 3 rectangular areas on the camera's image to be blocked/excluded from recordings and snapshots.

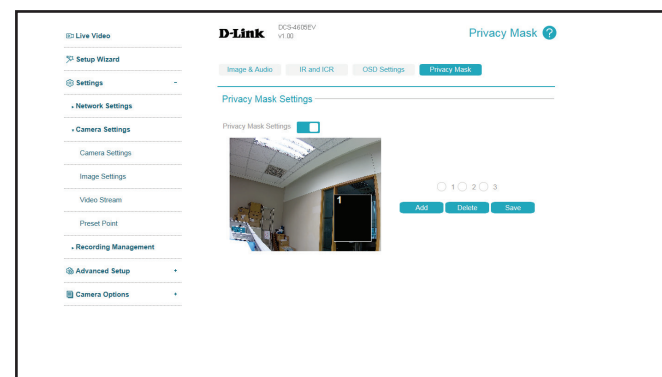

## Video Stream

You may configure up to 2 video profiles with different settings for your camera. This allows you to set different settings for recording video and for viewing your video remotely, for example. After making any changes, click the **Save** button to save your changes.

- Number of Active Profiles:** You can have up to 2 active profiles to configure and use.
- Aspect Ratio:** Set whether you want your camera to use a 4:3 or 16:19 aspect ratio for its video. When changing this setting, you will need to redo setup for motion detection, privacy masks, and preset points.
- Mode:** Set the video codec to be used to **H.264**, **H.265**, or **MJPEG**.
- Frame Size:** Select what frame size to use. Frame size determines the total capture resolution. Larger frame sizes provide more detail, but will require more bandwidth.
- View Window Area:** Select how large the view window should be. Setting it to be the same as your Frame Size will allow you to see the complete view of the camera. Setting a smaller view window will show a portion of the full camera view, and allows you to use ePTZ to move the camera view around and use preset points.
- Maximum Frame Rate:** You can set the maximum frame rate to be 1 fps to 30 fps. A higher frame rate provides smoother motion for videos and requires more bandwidth. Lower frame rates will result in stuttering motion and require less bandwidth.

If the Anti-Flicker is set on 50 Hz, the max. frame rate option will be 25fps; If Anti-Flicker is set on 60 Hz, the max. frame rate option will be 30fps.

- Rate Control:** This adjusts how the camera manages the quality and bandwidth usage of the camera.
- **VBR** - Variable Bit Rate will automatically change the bit rate based on the camera video's complexity. If the **Mode** is set to **MJPEG**, this will be the only choice available.
  - **CBR** - Constant Bit Rate will use a fixed bit rate that you set.
  - **CVBR** - Constrained Variable Bit Rate works like VBR, but lets you set a maximum bit rate.

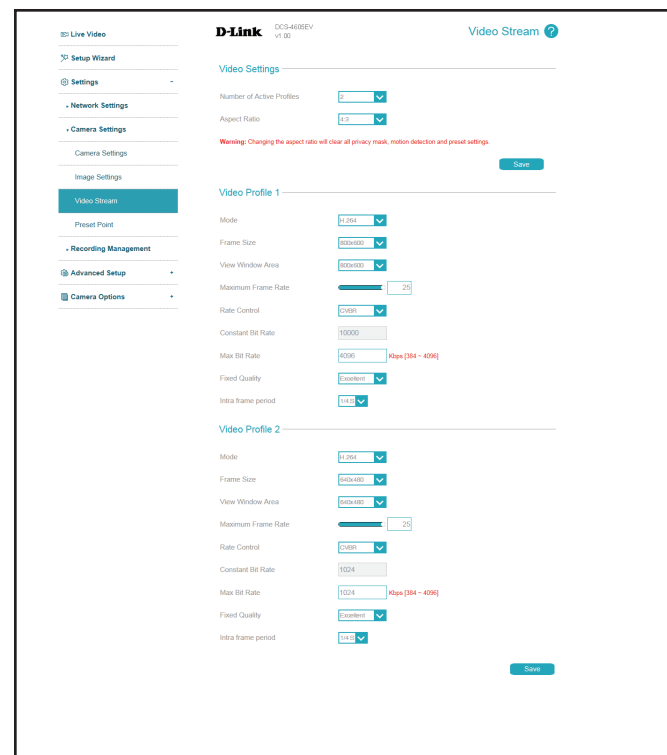

**Constant Bit Rate:** If the **Rate Control** is set to **CBR**, you can set the bit rate to use for this video profile.

**Max Bit Rate:** If the **Rate Control** is set to **CVBR**, you can set the maximum bit rate this video profile can use.

**Fixed Quality:** Select the image quality level for the camera to try to maintain. High quality levels will result in increased bit rates and use more bandwidth.

**Intra frame period:** This sets the period (in seconds) between each full-image frame for the compression algorithm selected; this setting is only configurable for H.264 and H.265, as MJPEG uses the full image for every frame. A general rule of thumb is the lower that number, the better the image but the higher the bandwidth and storage requirements.

The screenshot displays the configuration interface for 'Video Profile 1'. The settings are as follows:

Setting	Value
Mode	H.264
Frame Size	800x600
View Window Area	800x600
Maximum Frame Rate	25
Rate Control	CVBR
Constant Bit Rate	10000
Max Bit Rate	4096 Kbps [384 ~ 4096]
Fixed Quality	Excellent
Intra frame period	1/4 S

## Preset Point

If your viewing window area is less than your frame size, you can use preset points to save specific camera positions (refer to **"Video Stream" on page 45** for more details). You can also set a preset sequence for the camera to patrol through automatically. After making any changes, click the **Save** button to save your changes.

**Video Profile:** This selects which video profile to use.

**ePTZ Speed:** You can set how fast the camera will pan/tilt/zoom and auto pan.

**Input Preset Name:** To create a new preset, click and drag the red box in the live video to the position you want, enter the name of the preset you want to create, then click the **Add** button. If an existing preset has been selected from the Preset List, you can change its name by typing in a new name, then clicking the **Rename** button.

**Preset List:** Click this drop-down box to see a list of all the presets that have been created. You can select one, then click the **GoTo** button to change the displayed camera view to the preset. Clicking the **Remove** button will delete the currently selected preset.

**Preset Sequence:** This section allows you to create a preset sequence, which automatically moves the camera's view between a set of preset views. To add a preset to the sequence, select it from the Preset List drop-down box, then click the **Add** button. You can move the selected preset earlier or later in the sequence by clicking the arrow buttons, and you can remove a preset by selecting it and clicking the trashcan button. You can also set how many seconds the camera will stay at each position by setting the **Dwell Time** for each preset.

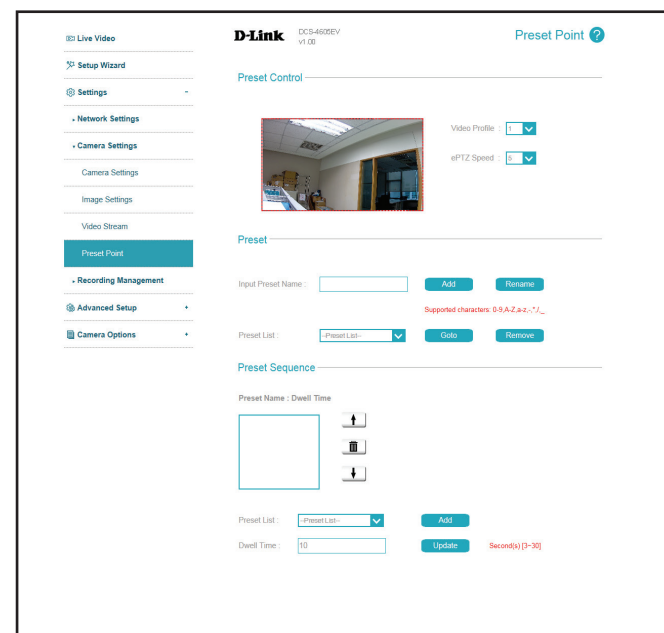

## Recording Management Event Management

The DCS-4605EV has a comprehensive Event system that lets you configure the camera to perform certain actions when an event occurs. For example, when motion is detected, you can have snapshots sent to an e-mail address. You can also configure the camera to take regular video recordings according to a schedule you define. Detailed information for the following steps can be found in the following pages.

### Step 1: Select your destination Server and Media type

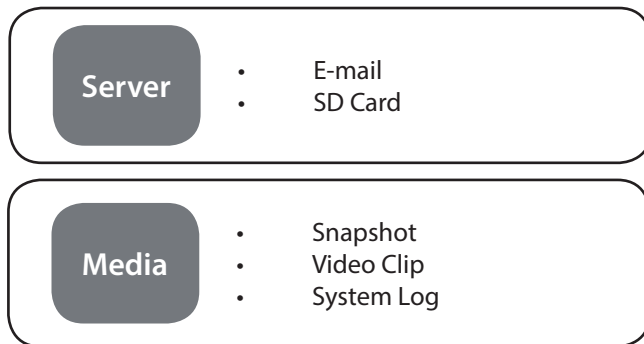

### Step 2: Select your Trigger event and Action

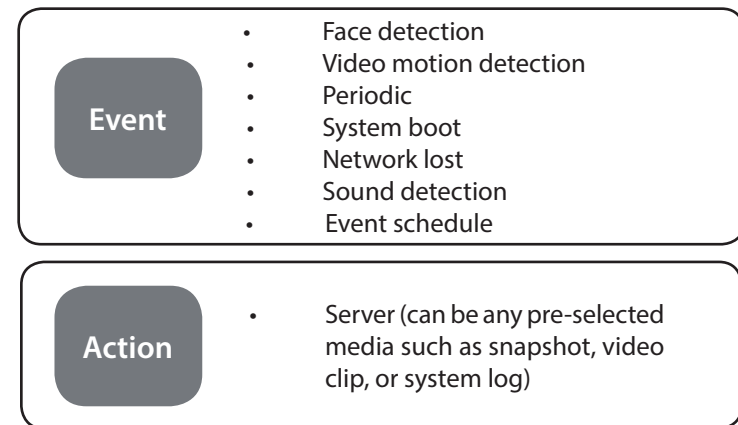

**When an event is triggered:**

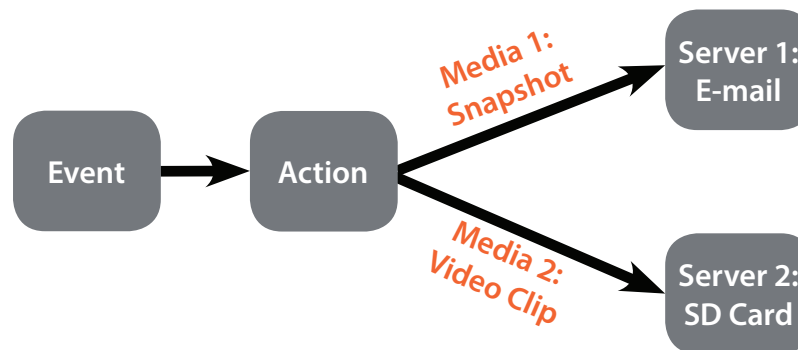



## Event MGMT

The Event Setup page includes 4 different sections:

- Server
- Media
- Event Settings
- Record

1. To add a new server, media, event, or recording item, click **Add**. A screen will appear and allow you to update the fields accordingly.
2. To delete the selected item from the server, media, event, or recording drop-down menus, click the **Delete** button next to it.
3. Click on the name of an item to edit it.

The screenshot displays the D-Link Event Management interface. The top navigation bar includes 'Event MGMT', 'SD Card', 'Motion', and 'Tamper'. The main content area is titled 'Event Setup' and contains four sections:

- Server:** A table with columns 'Server Name', 'Type', and 'Address/Location'. It shows one entry: 'Server 1' with type 'SD card'. Below the table are 'Add' and 'Delete' buttons.
- Media:** A table with columns 'Server Name', 'Type', and 'Source'. It shows one entry: 'Media1' with type 'Snapshot' and source 'Profile 1'. Below the table are 'Add' and 'Delete' buttons.
- Event Settings:** A table with columns 'Server Name', 'Status', 'Sun', 'Mon', 'Tue', 'Wed', 'Thu', 'Fri', 'Sat', 'Time', and 'Trigger'. It shows one entry: 'Event1' with status 'ON', days 'V V V V V V V', time '00:00-23:59', and trigger 'Motion'. Below the table are 'Add' and 'Delete' buttons.
- Record:** A table with columns 'Server Name', 'Status', 'Sun', 'Mon', 'Tue', 'Wed', 'Thu', 'Fri', 'Sat', 'Time', 'Source', and 'Destination'. It shows one entry with 'Add' and 'Delete' buttons.

## Server

You can configure a server for each server type, and up to 5 FTP servers. After making any changes, click the **Save** button to save your changes.

**Server Name:** Enter the name for the server.

**Email:** If you want to use an e-mail address for your server, select this and enter the settings for your target e-mail account.

**FTP:** If you want to use an FTP server for your server, select this and enter the settings for your target FTP server.

**Network Storage:** If you want to use a network storage device for your server, select this and enter its settings here.

**Total Recording Size:** This space is reserved for camera to record video clip or snapshot. The space must be more than 400MB. When this function is selected, it will reserve 200MB of keep free space automatically for the transaction stage when the storage space is about to full and new data arrives.

**Keep Free Space:** This space is reserved and prohibit to record any video clip or snapshot. The space must be more than 200MB.

**Cyclic:** The oldest file will be replaced by new file when the total recording size exceeds this value.

**SD Card:** If you want to use an inserted microSD card for your server, select this.

Before you set up this option please make sure your HDD has enough space, and it is better to not save other files in the same folder as recording files.

### Media

There are three types of media: **Snapshot**, **Video Clip**, and **System Log**. You can make a media entry for each type. After making any changes, click the **Save** button to save your changes.

**Media Name:** Enter a unique name for media type you want to create.

**Snapshot:** Select this option to set the media type to snapshots.

**Source:** Set the video profile to use as the media source. Refer to "**Video Stream**" on **page 45** for more information on video profiles.

**Send pre-event image(s) [0~4]:** Set the number of pre-event images to take. Pre-event images are images taken before the main event snapshot is taken.

**Send post-event image(s) [0~7]:** Set the number of post-event images to take. Post-event images are images taken after the main event snapshot is taken. You can set up to 7 post-event images to be taken.

For example:

If both the Send pre-event images and Send post-event images are set to four, a total of 9 images are generated after a trigger is activated.

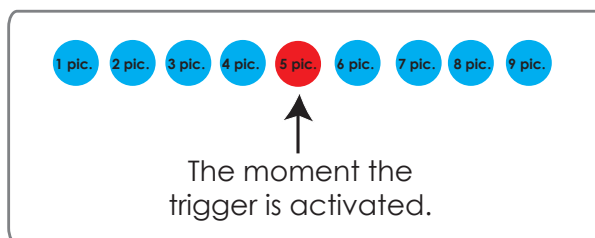

The screenshot shows the D-Link DCS-4605EV v1.00 Media configuration page. The 'Event MGMT' tab is selected, and the 'Media Type' is set to 'Snapshot'. The 'Source' is 'Profile1'. The 'Send' field for 'Pre-Event Image(s) [0~4]' is set to 1, and the 'Send' field for 'Post-Event Image(s) [0~7]' is set to 1. The 'File Name Prefix' is empty. The 'Add Date and Time Suffix to File Name' checkbox is unchecked. The 'Video Clip' and 'Camera Log' options are also visible.

**File name prefix:** The prefix name will be added to the file name.

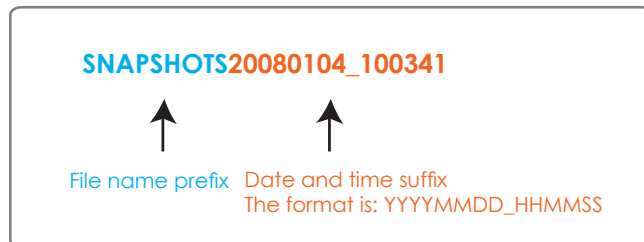

**Add date and time suffix to file name:** Enable this to add the date and time the snapshot was recorded as a file name suffix.

**Video clip:** Select this option to set the media type to video clips.

**Source:** Set the video profile to use as the media source. Refer to **"Video Stream" on page 45** for more information on video profiles.

**Pre-event recording:** This sets how many seconds to record before the main event video clip starts. You can record up to 4 seconds of pre-event video.

**Maximum duration:** Set the maximum length of video to record for your video clips.

**Maximum file size:** Set the maximum file size to record for your video clips.

**File Name Prefix:** This is the prefix that will be added to the filename of saved video clips.

**Camera log:** Select this option to set the media type to system logs. This will save the event to the camera system log, but will not record any snapshots or video.

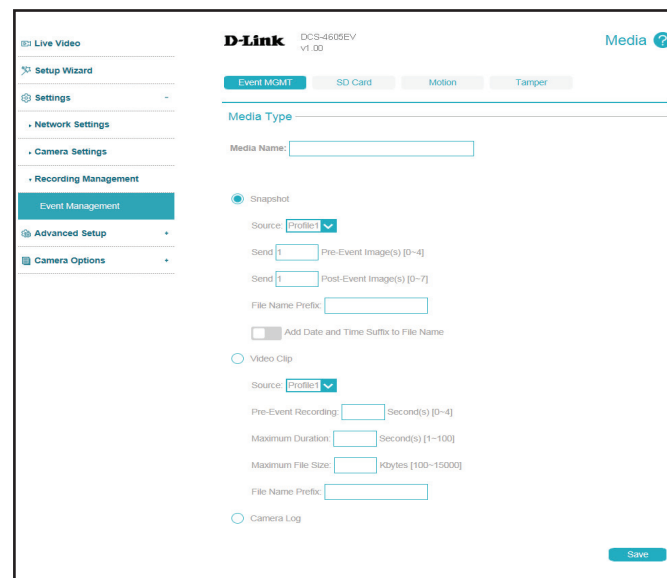

## Event

Create and schedule up to three events with their own settings here. After making any changes, click the **Save** button to save your changes.

**Event name:** Enter a name for the event.

**Enable this event:** Toggle this to activate this event.

**Priority:** Set the priority for this event. Events with higher priority will be executed first.

**Delay for...:** Specify the delay time before allowing this event to be triggered again. This is used for both motion detection events and event triggers.

## Trigger

**Video Motion Detection:** Selecting this will trigger the event when motion is detected during live video monitoring. Make sure you have enabled motion detection and specified what part of the image to monitor for motion. For more details, refer to **"Motion" on page 57**.

**Periodic:** Selecting this will trigger the event in specified intervals. The trigger interval unit is in minutes.

**Camera Boot:** Selecting this will trigger an event when the system boots up.

**Network Lost:** Selecting this will trigger an event when the camera's connection to the network is lost.

**Tamper Detection:** Selecting this will trigger an event when tampering has been detected. For more details, refer to **"Tamper" on page 59**.

## Event Schedule

Specify when you want to monitor for this event. Select which days to monitor for this event, then select **Always** or enter the time interval to monitor for the specified event.

**Action:** Select the actions you want the camera to take when the event happens. Select the Server to use, then choose the Media you want to save to it. Please note that you need to set up your Server and Media entries first.

The screenshot displays the 'Event Settings' page for a D-Link DCS-4605EV camera. The interface is organized into a sidebar and a main content area. The sidebar on the left contains navigation links: Live Video, Setup Wizard, Settings, Network Settings, Camera Settings, Recording Management, Event Management (highlighted), Advanced Setup, and Camera Options. The main content area features a header with the D-Link logo, model number DCS-4605EV, version v1.00, and an 'Event Settings' title with a help icon. Below the header are tabs for 'Event MGMT', 'SD Card', 'Motion', and 'Tamper'. The 'Event MGMT' tab is selected, showing the following configuration options:

- Event:**
  - Event Name: [Text Input Field]
  - Enable This Event
  - Priority: **normal** (dropdown menu)
  - Delay for: **10** seconds before detecting next event (For motion detection)
- Trigger:**
  - Video Motion Detection
  - Periodic:
    - Trigger Every **1** minutes
  - Camera Boot
  - Network Lost
  - Tamper Detection
- Event Schedule:**
  - Calendar: Sun, Mon, Tue, Wed, Thu, Fri, Sat (all days are checked)
- Time:**
  - Always
  - From [00] To [23] [00] To [59] (dropdown menus)

A 'Save' button is located at the bottom right of the main content area.

## Recording

Here you can configure and schedule the recording settings. After making any changes, click the **Save** button to save your changes.

**Recording Entry Name:** Enter a name for the recording.

**Enable This Recording:** Select this to enable the recording function.

**Priority:** Set the priority for this entry. An entry with a higher priority value will be executed first.

**Source:** Select the video profile to use as the recording source.

### Recording Schedule

Use the checkboxes to set which days to record video on. Select **Always** to record for the entire day, or select **From** and select what period of time you want to record using the dropdown boxes.

**Destination:** Select a storage destination that was configured in Server to send recordings there.

**Size of Each File for Recording:** If this is selected, files will be split based on the file size you specify.

**Time of Each File for Recording:** If this is selected, files will be based on the maximum length you specify.

**File Name Prefix:** The prefix name will be added to the beginning of the file name of the recording file(s).

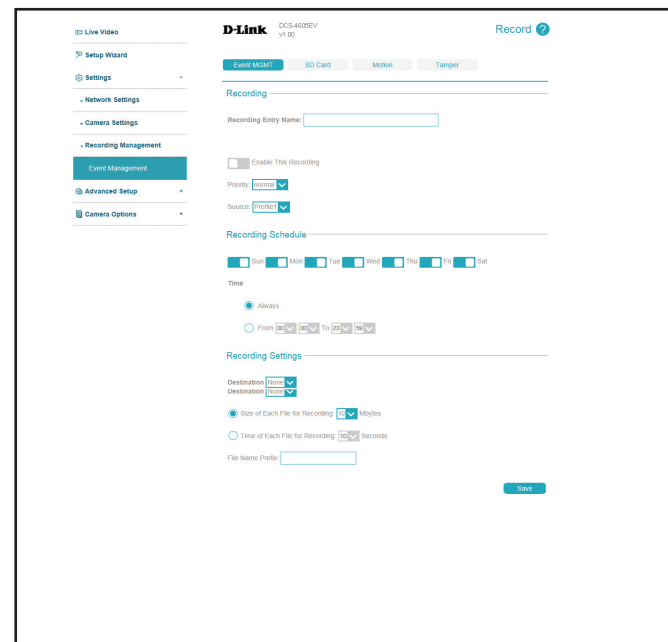

## SD Card

Here you may browse and manage the recorded files stored on the microSD card. Video is stored in the **Video** folder, and snapshots are stored in the **Picture** folder. You can play video and view snapshots by clicking on the appropriate folders, then clicking on the file you want to view.

**Keep Free Space:** Reserve space on your storage so that the camera will not save videos or snapshots to this space.

**Cyclic:** The oldest files will be automatically deleted to make room for new recordings.

**Files Per Page:** Use the drop-down menu to specify how many files to show per page. To change pages, use the drop-down menu on the right.

**Refresh:** Click this to refresh the file and folder information from the microSD card.

**Format:** Click this button to automatically format the microSD card and create the Video and Picture folders.

**Deleting Files and Folders:** To delete files and folders, click on the checkbox next to the files or folders you want to delete, then click the **OK** button.

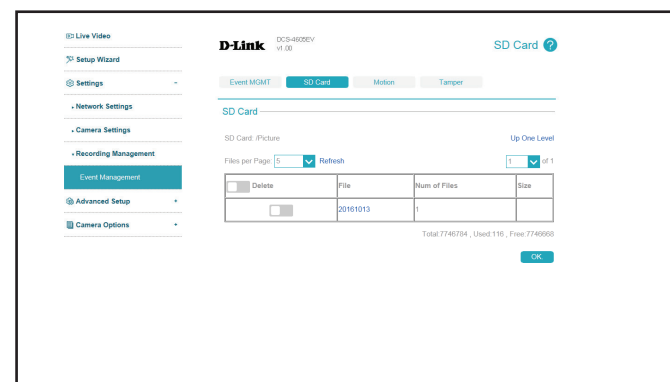
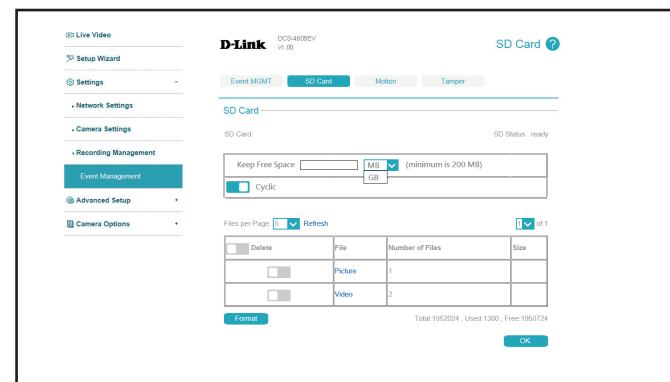



## Motion

Motion detection enables the camera to monitor the video feed for movement. Here, you can adjust the sensitivity settings that determine whether motion is detected by the camera or not. After making any changes, click the **Save** button to save your changes.

**Motion Detection Setting:** Enable this to enable the motion detection feature of your camera. Please note that you must create at least one motion detection box for the camera to detect motion.

**Percentage:** Set how much of the area being monitored for motion must change for motion to be detected. A low percentage means that only part of the area being monitored has to change to detect motion, and a high percentage means that most of the area needs to change to detect motion.

Low percentages can be useful when monitoring an area such as a large room, and high percentages can be useful when you are only monitoring a specific part of the camera's view, such as a doorway.

**Sensitivity:** Set how sensitive motion detection will be from 0% to 100%. A low sensitivity means that there must be large changes between two images in order to detect motion, and a high sensitivity means that even small changes will cause motion to be detected.

Low sensitivities may be useful when monitoring an area that has flickering lights or a window to the outside in view. High sensitivities may be useful when monitoring an area that rarely changes, such as a storeroom or warehouse.

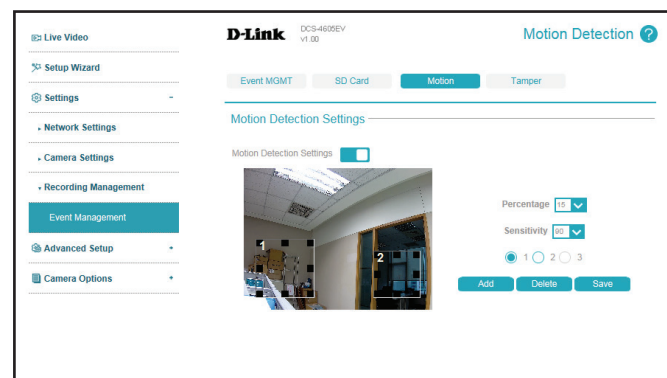

**Defining Motion** You can define up to 3 rectangular areas to monitor for motion.

**Detection Windows:** To add a motion detection box, click the **Add** button. A motion detection box will appear in the corner of the live video. Click on the black squares to resize each box and click in the middle of the box to move it. After moving and resizing the window how you wish, click **Save** to save your changes.

To modify an existing motion detection box, click on the button next to the window's number, then move and resize it as you wish. You can delete the window by clicking the **Delete** button.

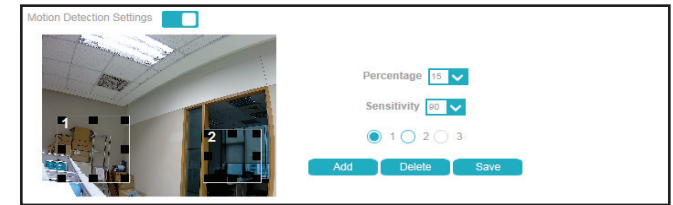

## Tamper

With tamper detection, the camera is capable of detecting incidents such as redirection, blocking or de-focusing, or even spray paint. After making any changes, click the **Save** button to save your changes.

**Tamper Detection:** Enable this to use tamper detection.

**Trigger Duration:** Enter the tamper trigger duration in seconds. The tamper alarm will be triggered only when there is a substantial change in the camera's view for longer than the trigger duration specified.

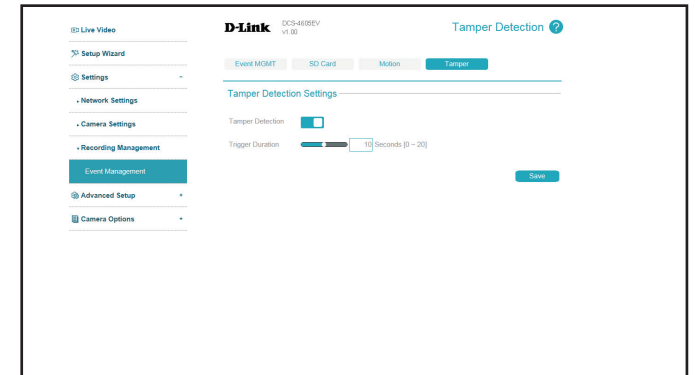

# Advanced Setup

## Advanced UPnP

Enabling Video Motion will allow your camera to use UPnP to automatically set up port forwarding on your router. After making any changes, click the **Save** button to save your changes.

**Enable UPnP Presentation:** Enabling this setting allows your camera to be configured as a UPnP device on your network.

**Enable UPnP Port Forwarding:** Enabling this setting allows the camera to add port forwarding entries into the router automatically on a UPnP capable network.

**Forwarding Port:** If UPnP Port Forwarding is enabled, you can set which port to use for forwarding.

**Forwarding Status:** If UPnP Port Forwarding is enabled, this will show the UPnP Port Forwarding status.

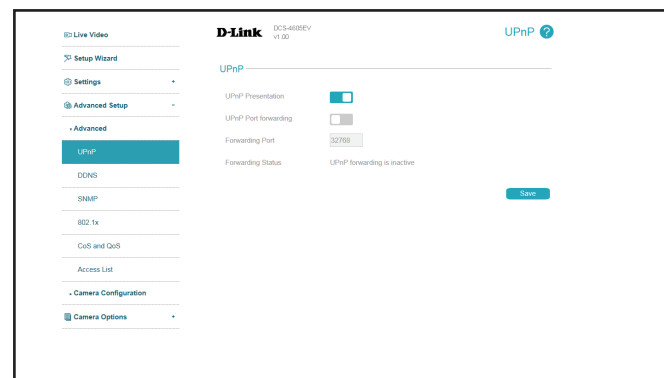

## DDNS

DDNS allows you to compensate for changing IP addresses by having a URL that automatically points to the current IP address of your camera.. To do this, you will need to have an account with one of the DDNS services listed in the drop-down box on this page. After making any changes, click the **Save** button to save your changes.

**DDNS:** Check this box to enable the DDNS function.

**Server Address:** Enter your DDNS server address, or select a service from the drop-down menu.

**Host Name:** Enter the host name of the DDNS service.

**User Name:** Enter the username or e-mail address used to connect to the DDNS service.

**Password:** Enter the password used to connect to the DDNS service.

**Timeout:** You can set up how often the camera notifies the DDNS service of its current global IP address by entering a whole number in hours.

**Status:** This shows the current status of your DDNS updates.

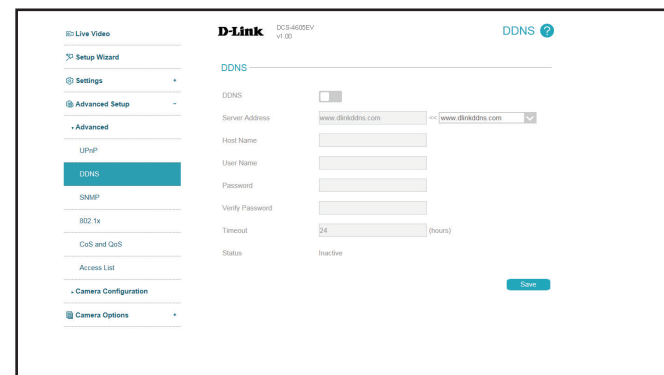

## SNMP

Here you can set the Simple Network Management Protocol (SNMP) settings for the camera, which allow for SNMP management of the camera. After making any changes, click the **Save** button to save your changes.

**Enable SNMPv1, SNMPv2c:** Enable this option to allow for SNMPv1 and SNMPv2c management of the camera.

**Read/Write Community:** Enter a name for the read/write community of your SNMP server.

**Read Only Community:** Enter a name for the read-only community of your SNMP server.

**Enable SNMPv3:** Enable this option to allow SNMPv3 management of the camera.

**Read/Write Security Name:** Enter a name for the read/write community of your read/write SNMP server.

**Authentication Type:** Enter the type of authentication used by your read/write SNMP server.

**Authentication Password:** Enter the authentication password used for your read/write SNMP server.

**Encryption Password:** Enter the encryption password used for your read/write SNMP server.

**Read Only Security Name:** Enter a name for the read-only community of your read-only SNMP server.

## Section 3: Configuration

**Authentication Type:** Enter the type of authentication used by your read-only SNMP server.

**Authentication Password:** Enter the authentication password used for your read-only SNMP server.

**Encryption Password:** Enter the encryption password used for your read-only SNMP server.

**Traps:** Enable or disable sending of traps by the camera.

**Trap Address:** Enter the IP address of the SNMP server/management station where the trap messages will be sent.

**Traps Community:** Enter a trap community string used by your SNMP server.

**Trap Address 2:** Enter a second IP address of the SNMP server/management station where trap messages will be sent.

**Trap Community 2:** Enter a second trap community string used by your SNMP server.

The screenshot shows the D-Link web interface for the DCS-4605EV v1.00. The left sidebar contains navigation options: Live Video, Setup Wizard, Settings, Advanced Setup, URP, DNS, SNMP (highlighted), 802.1x, CoS and QoS, Access List, Camera Configuration, and Camera Options. The main content area is titled 'SNMP Configuration' and includes the following settings:

- Enable SNMPv1, SNMPv2:
- Read/Write Community: write\_A5102A7
- Read-Only Community: public\_A5102A7
- Enable SNMPv3:
- Read/Write Security Name: [text input]
- Authentication Type: MD5
- Authentication Password: [password input]
- Encryption Password: [password input]
- Read-Only Security Name: [text input]
- Authentication Type: MD5
- Authentication Password: [password input]
- Encryption Password: [password input]
- Traps:
- Trap address: [text input]
- Trap community: [text input]
- Trap address 2: [text input]
- Trap community 2: [text input]

A 'Save' button is located at the bottom right of the configuration area.

# 802.1x

This page lets you set up 802.1x authentication for your camera. Your network devices, intermediary switches, and RADIUS server must support and enable 802.1x. After making any changes, click the **Save** button to save your changes.

**IEEE 802.1x:** Enable this to use IEEE 802.1x authentication.

**EAP Type:** Select the EAP type used by your 802.1x server.

**Identity:** Enter the identity issued by your certificate authority.

**Password:** Enter the password issued by your certificate authority.

**Status:** This will show information about the current CA certificate that was uploaded to the camera. To remove the CA certificate, click the **Delete** button.

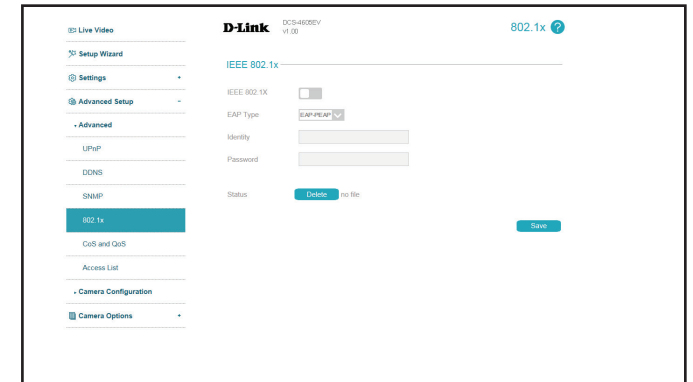



## CoS and QoS

Class of Service (CoS) and Quality of Service (QoS) allow you to prioritize surveillance traffic on your network to ensure that your cameras can stream video smoothly and remain accessible even when there is heavy traffic on your network. Your network must support CoS or QoS in order to use them. After making any changes, click the **Save** button to save your changes.

**Enable CoS:** Enabling the Class of Service setting implements a best-effort policy to prioritize traffic without making any bandwidth reservations.

To use CoS, enable it, enter the VLAN ID to use for the camera, and set the priority for your **Live Video**, **Live Audio**, **Event/Alarm**, and **Management** camera traffic.

**Enable QoS:** Enabling QoS allows you to specify a traffic priority policy to ensure a consistent Quality of Service during busy periods. If the Network Camera is connected to a router that itself implements QoS, the router's settings will override the QoS settings of the camera.

To use CoS, enable it and set the priority for your **Live Video**, **Live Audio**, **Event/Alarm**, and **Management** camera traffic.

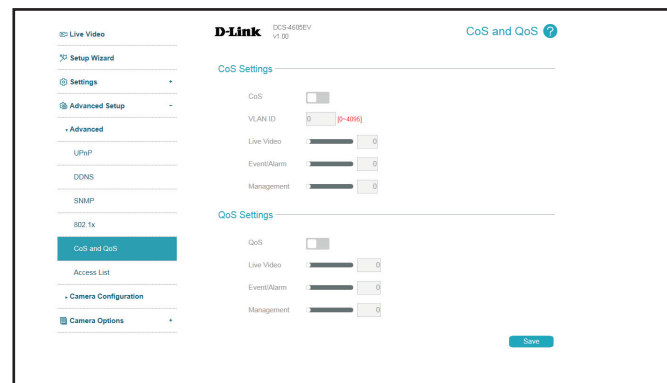

## Access List

Here you can define which IP addresses are allowed to view your DCS-4605EV. You can set up to 7 IP address ranges for both the allow and deny lists.

**Allow List:** The section lets you define what IP addresses have access rights to the camera.

**Note:** When adding entries to the Allow list, make sure the first entry includes the IP address of the computer or device you are using to access the camera. Otherwise, you may be blocked from accessing the camera after adding the entry to the Allow list.

**Start IP Address:** The starting IP address of the IP address range for the devices (such as a computer) that have permission to access the video of the camera.

**End IP Address:** The ending IP address of the IP address range for the devices (such as a computer) that have permission to access the video of the camera. Click **Add** to save your changes.

**Delete Allow List:** Select an entry to remove from the Allow List, then click **Delete**.

**Deny List:** The list of IP addresses that have no access rights to the camera.

**Start IP Address:** The starting IP address of the IP address range for the devices (such as a computer) that will be denied access to the camera.

**End IP Address:** The ending IP address of the IP address range for the devices (such as a computer) that will be denied access to the camera. Click **Add** to save your changes.

**Delete Deny List:** Select an entry to remove from the Deny List, then click **Delete**.

**Note:** All addresses in the Deny List will be denied access, even if they are also in the Allow List.

The screenshot shows the 'Access List' configuration page for a D-Link DCS-4605EV camera. The page is organized into two main sections: 'Allow List' and 'Deny List'. Each section contains input fields for 'Start IP Address' and 'End IP Address', followed by an 'Add' button. Below these fields is a 'Delete' button. The 'Allow List' section also includes a 'Delete Allow List' button with a dropdown arrow. The 'Deny List' section includes a 'Delete Deny List' button with a dropdown arrow. The interface is clean and modern, with a blue and white color scheme. The D-Link logo and device information are visible at the top right of the page.

## Camera Configuration

### Save and Load Configuration

In this section, you may back up or restore the camera configuration.

**Save To Local Hard Drive:** You may save your current camera configuration as a file on your computer.

**Load From Local Hard Drive:** Locate a pre-saved configuration by clicking **Browse** and then restore the pre-defined settings to your camera by clicking **Upload**.

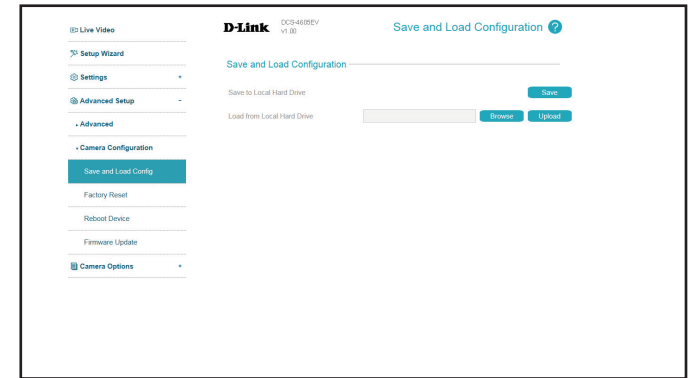

## Factory Reset

Here you can reset the camera configuration back to the factory defaults.

**Keep Network Setting:** Enabling this option will allow you to keep your network settings when resetting your camera to the factory defaults.

**Restore to Factory Default:** You may reset your camera and restore the factory settings by clicking **Restore**.

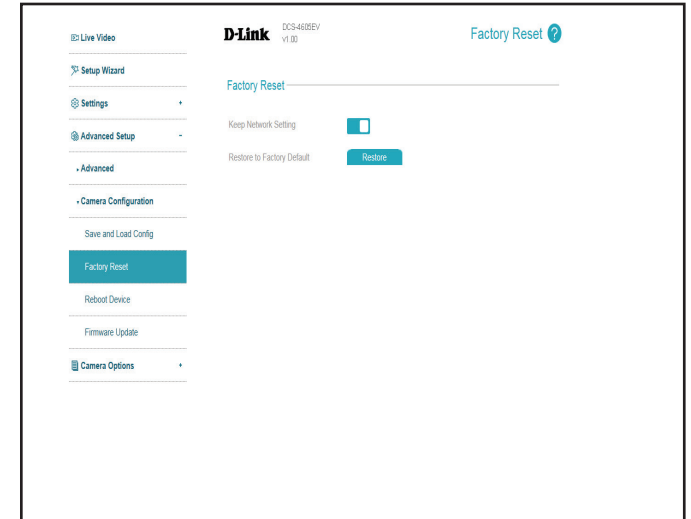

## Reboot Device

Here you can reboot the camera, or set a schedule to reboot the camera automatically.

**Reboot Device:** This will restart your camera.

**Schedule Reboot:** If you want your camera to reboot on a regular schedule, enable this option, then select the days and time you want the camera to reboot on and click the **Save** button.

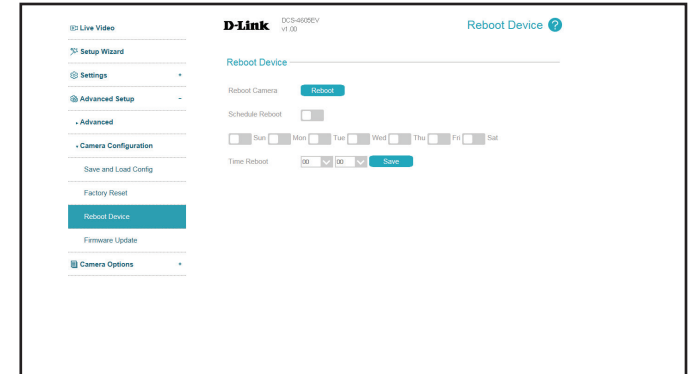

## Firmware Update

Here you can update the camera's firmware. The current version of the firmware is shown next to the D-Link logo at the top of the page.

**File Path:** To update the firmware, select a firmware file to use from your hard drive by clicking **Browse...**, then click the **Upload** button.

**Note:** While the firmware is being update, do not close the web browser or disconnect your camera's power or network connection until the update is complete.

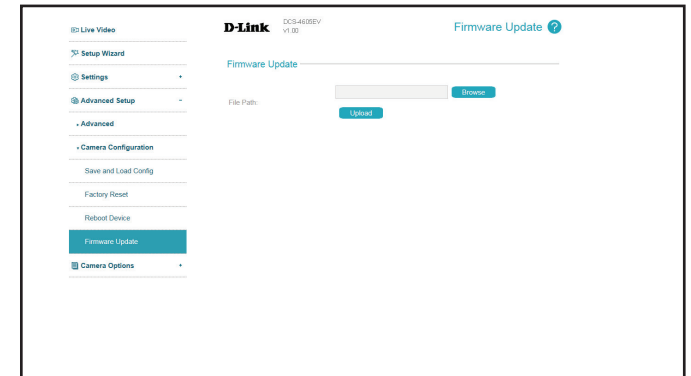

# Camera Options

## Camera Info

This page displays detailed information about your camera, the services running on your camera, and active video streams.

**D-Link** DCS-4605EV v1.00 Camera Info ?

---

### Camera Information

IP Address: 192.168.0.158  
 Link Local Address: 169.254.185.163  
 PPPoE Address:  
 Camera Name: DCS-4605EV  
 Firmware Version: v1.00.00  
 Firmware Date: Wed, 15 Nov 2017 11:30:56 GMT  
 MAC Address: 00:0E:AE:A5:92:A7  
 Hardware Version: A  
 Connected Client(s): 0

---

### Time & Date

Time & Date: Mon, 27 Nov 2017 16:09:36 GMT

---

### Service Status

Service	Enable/Disable	Protocol	Server Port
HTTP	Enable	TCP	80
Secondary HTTP	Disable	TCP	-
HTTPS	Disable	TCP	443
RTSP	Enable	TCP	554
UPnP Presentation	Enable	-	-
UPnP Port forwarding	Disable	-	-
802.1x	Disable	-	-
CoS	Disable	-	-
QoS/DSCP	Disable	-	-
DDNS	Disable	-	-
Access List	Disable	-	-

---

### Stream Status

Stream Number	Codec Type	Resolution	Max Frame Rate	Bit Rate/Quality
Stream 1	H264	800x600	25	4096/90
Stream 2	H264	640x480	25	1024/90

# Time Time Settings

This section allows you set the time zone and Daylight Saving settings for your camera.

**Time Zone:** Select your time zone from the drop-down menu.

**Daylight Saving:** If your region uses Daylight Saving time, you can enable it here. Select Set date and time manually if you want to manually set the offset and the period of time that the Daylight Saving correction should be used.

**Offset:** Enter the offset that should be used when Daylight Saving is being used.

**Start Time:** Set the date and time that Daylight Saving should start.

**End Time:** Set the date and time that Daylight Saving should end.

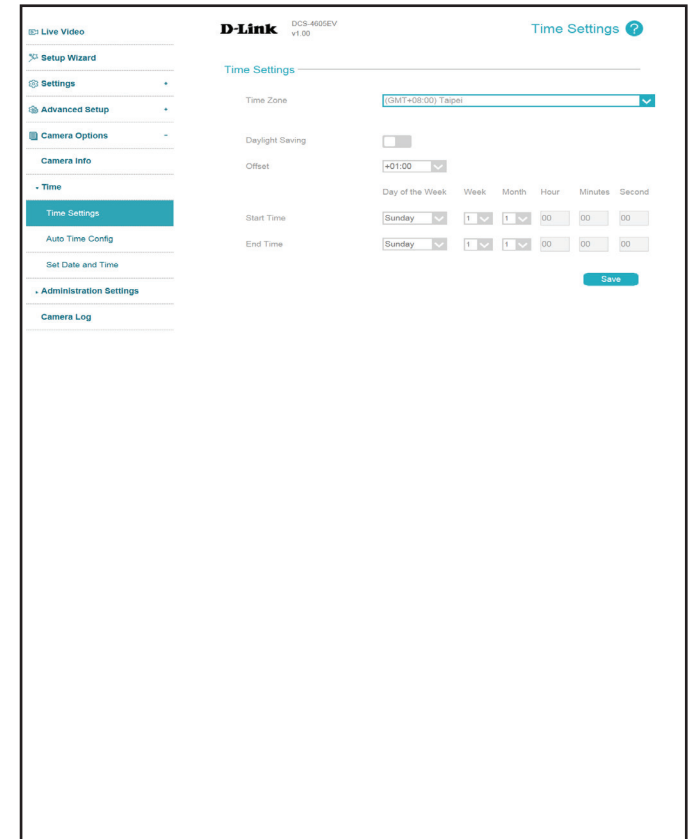



## Auto Time Config

This section lets you set your camera's date and time automatically by using an NTP server.

**NTP Server:** Enable this option to set your camera's time using an NTP server, then select an NTP server to use from the drop-down box.

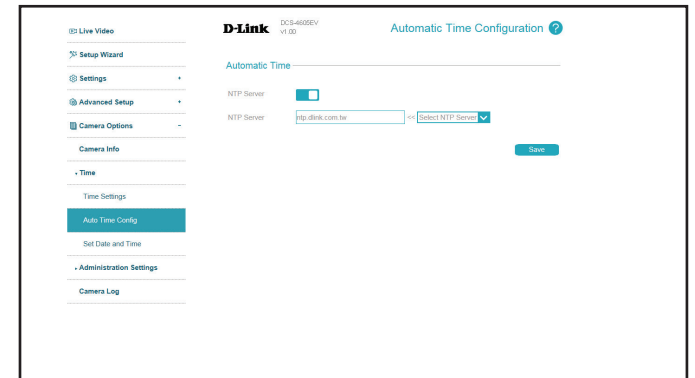

## Set Date and Time

This section lets you manually set your camera's date and time. If you have **NTP Server** enabled in **Auto Time Config**, you will need to disable it before setting the date and time manually.

**Set Date and Time Manually:** This option allows you to set the time and date manually.

**Copy your PC's time:** It will synchronize the time information from your PC

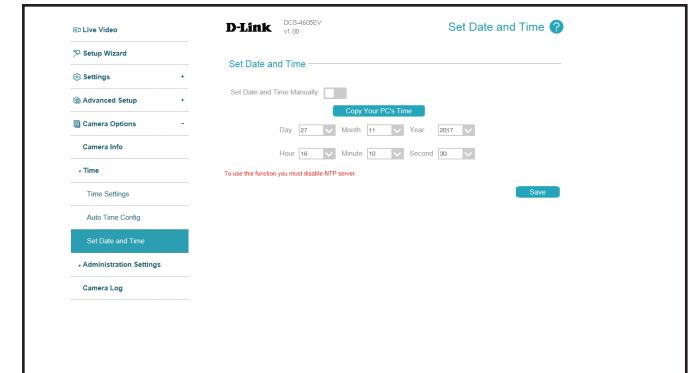

# Administration Settings

## Admin Password

Here, you may modify the administrator's password for your camera.

**New Password / Retype Password:** Set a new password for the administrator's account.

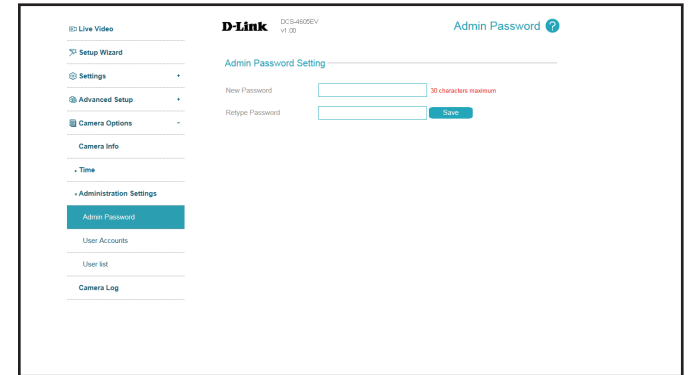

## User Accounts

Here, you may add user accounts for accessing the camera. User accounts are allowed to access the Live Video page, but cannot access any of the camera's configuration pages.

**User Name:** Enter a user name for the user you wish to create.

**New Password / Retype Password:** Enter a password for the user you wish to create.

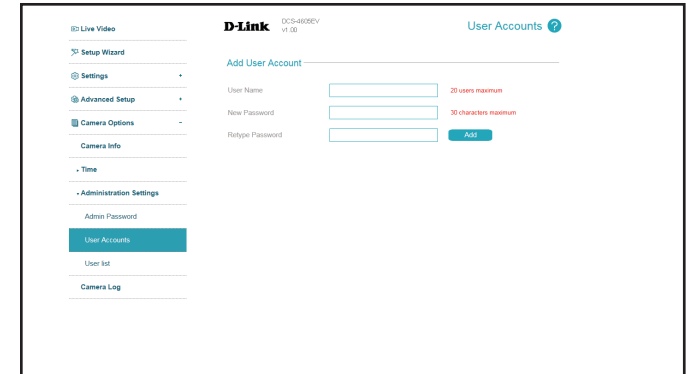

## User List

Here, you may manage the user accounts for accessing the camera.

**User Name:** If you want to change a user's password, select a user from the drop-down box, enter the new password, then click the **Modify** button.

If you want to remove a user from the user list, select a user from the drop-down box, then click the **Delete** button.

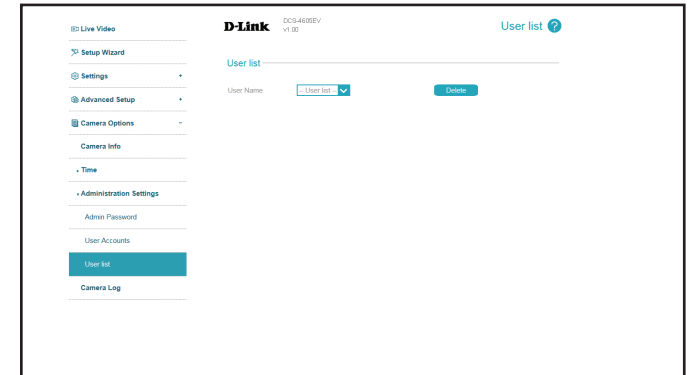

## Camera Log

This page displays the log information of your camera. You may download the information by clicking **Download**. You may also click **Clear** to delete the saved log information.

**D-Link** DCS-4605EV v1.00 Camera Log ?

### Camera Log

```
Nov 27 16:06:05 DCS-4633EV user.info Venc: profile[0] running 0
Nov 27 16:06:05 DCS-4633EV user.debug rtsp-svr: closing (192.168.0.132) TCP
Nov 27 16:06:05 DCS-4633EV user.debug rtsp-svr: client (192.168.0.132) close
Nov 27 16:06:05 DCS-4633EV user.debug rtsp-svr: session count 0
Nov 27 16:06:05 DCS-4633EV user.debug rtsp-svr: tearing down rtsp://192.168.
Nov 27 16:06:05 DCS-4633EV user.debug rtsp-svr: client (192.168.0.132) reque
Nov 27 16:05:55 DCS-4633EV user.info Venc: profile[0] running 1
Nov 27 16:05:55 DCS-4633EV user.debug rtsp-svr: session count 1
Nov 27 16:05:55 DCS-4633EV user.debug rtsp-svr: client (192.168.0.132) reque
Nov 27 16:05:54 DCS-4633EV user.debug rtsp-svr: client (192.168.0.132) reque
Nov 27 16:05:54 DCS-4633EV user.debug rtsp-svr: vindex=0, audio=0, aformat=4
Nov 27 16:05:54 DCS-4633EV user.info Venc: send video index = 0 to clinet, f
Nov 27 16:05:54 DCS-4633EV user.info Venc: profile[0] running 0
Nov 27 16:05:54 DCS-4633EV user.info Venc: setup client info: index=0, video
Nov 27 16:05:54 DCS-4633EV user.info Venc: stream channel=0, audio=0
Nov 27 16:05:54 DCS-4633EV user.info Venc: ==> vencChn_0 update fps = 25
Nov 27 16:05:54 DCS-4633EV user.info Venc: h264 vbr.
Nov 27 16:05:54 DCS-4633EV user.info Venc: h264 vbr.
Nov 27 16:05:54 DCS-4633EV user.debug rtsp-svr: describing streams under 'rt
Nov 27 16:05:54 DCS-4633EV user.debug rtsp-svr: client (192.168.0.132) reque
Nov 27 16:05:54 DCS-4633EV user.debug rtsp-svr: client (192.168.0.132) reque
Nov 27 16:05:54 DCS-4633EV user.debug rtsp-svr: Handle RTSP command
Nov 27 16:05:54 DCS-4633EV user.debug rtsp-svr: RTSP-HTTP tunnel established
Nov 27 16:05:54 DCS-4633EV user.debug rtsp-svr: client (192.168.0.132) reque
Nov 27 16:05:54 DCS-4633EV user.debug rtsp-svr: processing RTSP-HTTP tunnel
Nov 27 16:05:54 DCS-4633EV user.debug rtsp-svr: client (192.168.0.132) reque
Nov 27 16:03:33 DCS-4633EV user.info Venc: profile[0] running 0
Nov 27 16:03:33 DCS-4633EV user.debug rtsp-svr: client (192.168.0.132) close
Nov 27 16:03:33 DCS-4633EV user.debug rtsp-svr: client (192.168.0.132) close
Nov 27 16:03:33 DCS-4633EV user.debug rtsp-svr: session count 0
Nov 27 16:03:33 DCS-4633EV user.debug rtsp-svr: tearing down rtsp://192.168.
Nov 27 16:03:33 DCS-4633EV user.debug rtsp-svr: client (192.168.0.132) reque
Nov 27 16:03:32 DCS-4633EV user.info Venc: profile[0] running 1
```

[Clear](#) [Download](#)

# Technical Specifications

Camera		
Camera Hardware Profile	<ul style="list-style-type: none"> <li>• 1/2.9" 5 Megapixel progressive CMOS sensor</li> <li>• 20 meter IR illumination distance</li> <li>• Minimum illumination:               <ul style="list-style-type: none"> <li>• 0.01 lux / F2.0 (color)</li> <li>• 0.008 lux /F2.0 (B/W)</li> <li>• 0 lux / F2.0 (IR-LED on)</li> </ul> </li> <li>• Built-in Infrared-Cut Removable (ICR) Filter module</li> <li>• 10x digital zoom</li> <li>• Minimum object distance 0.5M</li> </ul>	<ul style="list-style-type: none"> <li>• Focal length: 2.8 mm</li> <li>• Aperture: F2.0</li> <li>• Angle of view(4:3):               <ul style="list-style-type: none"> <li>• (H) 87°</li> <li>• (V) 65°</li> <li>• (D) 110°</li> </ul> </li> <li>• Adjustment angle (non-motorized):               <ul style="list-style-type: none"> <li>• Vertical: 30~90°</li> <li>• Horizontal: -120~120°</li> </ul> </li> </ul>
Camera Housing	<ul style="list-style-type: none"> <li>• IP66 compliant weatherproof housing</li> </ul>	<ul style="list-style-type: none"> <li>• IK10 vandal-proof housing</li> </ul>
Image Features	<ul style="list-style-type: none"> <li>• Configurable image size, quality, frame rate, and bit rate</li> <li>• Configurable motion detection windows</li> <li>• Configurable privacy mask zones</li> <li>• Configurable shutter speed, brightness, saturation, contrast, sharpness and 3D filter.</li> </ul>	<ul style="list-style-type: none"> <li>• Auto White Balance (AWB)</li> <li>• Auto Gain Control (AGC)</li> <li>• Wide Dynamic Range (WDR)</li> <li>• Time stamp and text overlays</li> </ul>
Video Compression	<ul style="list-style-type: none"> <li>• Simultaneous H.265/H.264/MJPEG format compression</li> <li>• H.265/H.264/MJPEG multicast streaming</li> </ul>	<ul style="list-style-type: none"> <li>• JPEG for still images</li> </ul>
Video Resolution	<ul style="list-style-type: none"> <li>• 16:9 - 2592 x 1440 up to 15 fps, 1920 x 1080, 1280 x 720, 800 x 448, 640 x 360 up to 30 fps</li> </ul>	<ul style="list-style-type: none"> <li>• 4:3 - 2560x1920 up to 15 fps, 1600 x 1200, 1440 x 1080, 1280 x 960, 800 x 600, 640 x 480 up to 30 fp</li> </ul>
External Device Interfaces	<ul style="list-style-type: none"> <li>• 10/100 BASE-TX Fast Ethernet port</li> </ul>	<ul style="list-style-type: none"> <li>• Supports 802.3af PoE Class 3</li> </ul>
Network		
Network Protocols	<ul style="list-style-type: none"> <li>• IPv6</li> <li>• IPv4</li> <li>• ARP</li> <li>• TCP/IP</li> <li>• UDP</li> <li>• ICMP</li> <li>• DHCP client</li> <li>• NTP client (D-Link)</li> <li>• DNS client</li> <li>• DDNS client (D-Link)</li> <li>• SMTP client</li> <li>• FTP client</li> </ul>	<ul style="list-style-type: none"> <li>• HTTP/HTTPS</li> <li>• Samba client</li> <li>• PPPoE</li> <li>• UPnP port forwarding</li> <li>• RTP/RTSP/RTCP</li> <li>• IP filtering</li> <li>• Multicast</li> <li>• CoS</li> <li>• QoS/DSCP</li> <li>• SNMP</li> <li>• 802.1x port-based authentication</li> <li>• ONVIF-compliant</li> </ul>
Security	<ul style="list-style-type: none"> <li>• Administrator and user group protection</li> <li>• Password authentication</li> </ul>	<ul style="list-style-type: none"> <li>• HTTP and RTSP authentication</li> </ul>



## Appendix A: Technical Specifications

System Management		
Event Management	<ul style="list-style-type: none"> <li>• Motion detection</li> <li>• Tamper detection</li> <li>• Event notification and uploading of snapshots/video clips via e-mail or FTP</li> </ul>	<ul style="list-style-type: none"> <li>• Supports multiple SMTP and FTP servers</li> <li>• Multiple event notifications</li> <li>• Multiple recording methods for easy backups</li> </ul>
Remote Management	<ul style="list-style-type: none"> <li>• Take snapshots/video clips and save to local hard drive</li> </ul>	<ul style="list-style-type: none"> <li>• Configuration interface accessible via web browser</li> </ul>
System Requirements for Web Interface	<ul style="list-style-type: none"> <li>• Operating System: Microsoft Windows 10 / 8 / 7</li> </ul>	<ul style="list-style-type: none"> <li>• Browser: Internet Explorer, Firefox, Chrome</li> </ul>
D-ViewCam™ System Requirements	<ul style="list-style-type: none"> <li>• Operating System: <ul style="list-style-type: none"> <li>• 32-bit: Windows 8 / 7 (SP1)</li> <li>• 64-bit: Windows 10 / 8 / 7 (SP1) / Server 2012 / Server 2008 R2</li> </ul> </li> </ul>	<ul style="list-style-type: none"> <li>• Web Browser: Internet Explorer 7 or higher</li> <li>• Protocol: Standard TCP/IP</li> </ul>
D-ViewCam™ Software Functions	<ul style="list-style-type: none"> <li>• Remote management/control of up to 32 cameras</li> <li>• Supports all management functions provided in web interface</li> </ul>	<ul style="list-style-type: none"> <li>• Viewing of up to 32 cameras on one screen</li> <li>• Scheduled motion triggered, or manual recording options</li> </ul>
General		
Weight	<ul style="list-style-type: none"> <li>• 365 g ± 5%</li> </ul>	
Power	<ul style="list-style-type: none"> <li>• Input: 100 to 240 V AC, 50/60 Hz</li> </ul>	<ul style="list-style-type: none"> <li>• Output: 12 V DC 1.5 A</li> </ul>
Power Consumption	<ul style="list-style-type: none"> <li>• 6 W ± 5% (PoE)</li> </ul>	
Temperature	<ul style="list-style-type: none"> <li>• Operating: -30 to 50 °C (-22 to 124 °F)</li> </ul>	<ul style="list-style-type: none"> <li>• Storage: -20 to 70 °C (-4 to 158 °F)</li> </ul>
Humidity	<ul style="list-style-type: none"> <li>• Operating: 20% to 80% non-condensing</li> </ul>	<ul style="list-style-type: none"> <li>• Storage: 5% to 95% non-condensing</li> </ul>
Certifications	<ul style="list-style-type: none"> <li>• CE</li> <li>• CE LVD</li> </ul>	<ul style="list-style-type: none"> <li>• FCC</li> <li>• RCM</li> </ul>

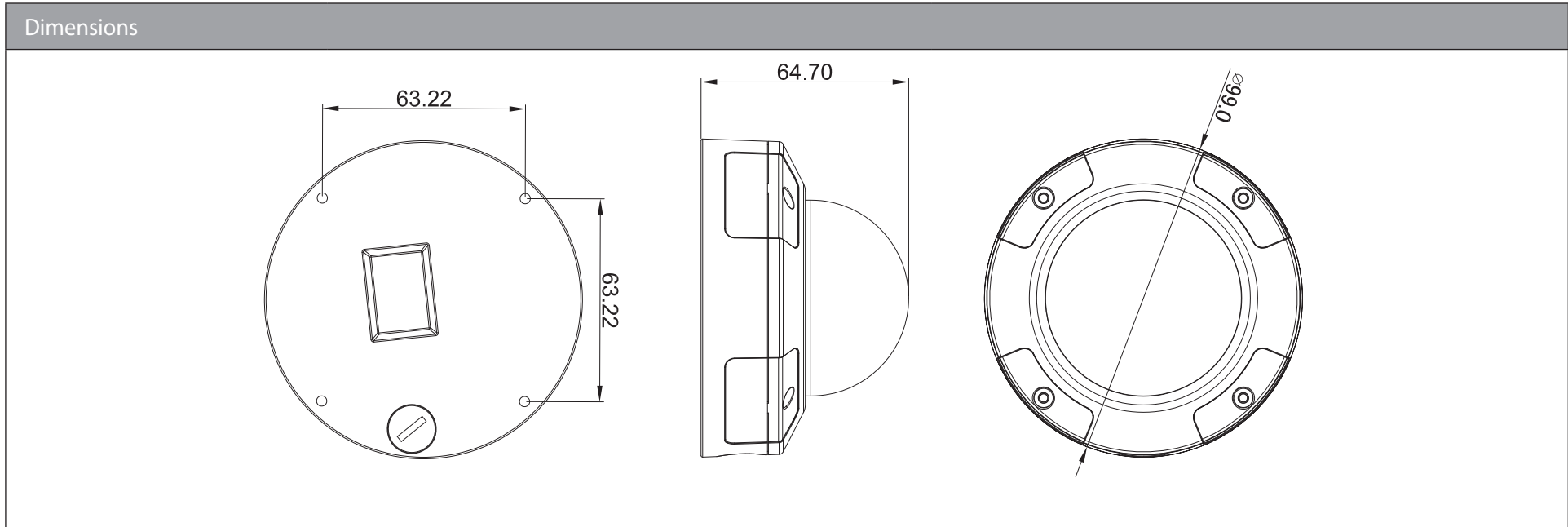



## Appendix A: Technical Specifications

Optional Accessories			
Model Name	• Wall-Mount Bracket	• Ceiling-Mount Bracket	• Angled Ceiling-Mount Bracket
Model Number	• DCS-37-1	• DCS-37-2	• DCS-37-3
Product Image			
Dimensions (L x W x H)	• 183 x 120 x 90 mm	• Ø 117 x 40 mm	• Ø 129 x 72.1 mm
Weight	• 567 g	• 237 g	• 73 g
Maximum Load	• 2 Kg	• 2 Kg	• 4 Kg
Material	• Metal	• Metal	• Polycarbonate
Camera Models Supported	<ul style="list-style-type: none"> <li>• DCS-4602EV</li> <li>• DCS-4603</li> <li>• DCS-4633EV</li> <li>• DCS-4605EV</li> <li>• DCS-4802E</li> <li>• DCS-6212L</li> </ul>	<ul style="list-style-type: none"> <li>• DCS-4602EV</li> <li>• DCS-4603</li> <li>• DCS-4633EV</li> <li>• DCS-4605EV</li> <li>• DCS-4802E</li> <li>• DCS-6212L</li> </ul>	<ul style="list-style-type: none"> <li>• DCS-4602EV</li> <li>• DCS-4603</li> <li>• DCS-4633EV</li> <li>• DCS-4605EV</li> <li>• DCS-4802E</li> <li>• DCS-6212L</li> </ul>

# Regulatory Information

## **Federal Communication Commission Interference Statement:**

This equipment has been tested and found to comply with the limits for a Class A digital device, pursuant to part 15 of the FCC Rules. These limits are designed to provide reasonable protection against harmful interference when the equipment is operated in a commercial environment. This equipment generates, uses, and can radiate radio frequency energy and, if not installed and used in accordance with the instruction manual, may cause harmful interference to radio communications. Operation of this equipment in a residential area is likely to cause harmful interference in which case the user will be required to correct the interference at his own expense.

## **Non-modification Statement:**

Any changes or modifications not expressly approved by the party responsible for compliance could void the user's authority to operate this equipment.

## **Caution:**

This device complies with Part 15 of the FCC Rules. Operation is subject to the following two conditions: (1) This device may not cause harmful interference, and (2) this device must accept any interference received, including interference that may cause undesired operation.

## **Industry Canada Statement:**

This Class A digital apparatus complies with Canadian ICES-003.

Cet appareil numérique de la classe A est conforme à la norme NMB-003 du Canada.

## **European Union**

### **CE EMI Class A Warning**

This equipment is compliant with Class A of CISPR 32. In a residential environment this equipment may cause radio interference.



### **SAFETY INSTRUCTIONS**

The following general safety guidelines are provided to help ensure your own personal safety and protect your product from potential damage. Remember to consult the product user instructions for more details.

- Static electricity can be harmful to electronic components. Discharge static electricity from your body (i.e. touching grounded bare metal) before touching the product.
- Do not attempt to service the product and never disassemble the product. For some products with a user replaceable battery, please read and follow the instructions in the user manual.
- Do not spill food or liquid on your product and never push any objects into the openings of your product.
- Do not use this product near water, areas with high humidity, or condensation unless the product is specifically rated for outdoor application.
- Keep the product away from radiators and other heat sources.
- Always unplug the product from mains power before cleaning and use a dry lint free cloth only.

### **SICHERHEITSVORSCHRIFTEN**

Die folgenden allgemeinen Sicherheitsvorschriften dienen als Hilfe zur Gewährleistung Ihrer eigenen Sicherheit und zum Schutz Ihres Produkts. Weitere Details finden Sie in den Benutzeranleitungen zum Produkt.

- Statische Elektrizität kann elektronischen Komponenten schaden. Um Schäden durch statische Aufladung zu vermeiden, leiten Sie elektrostatische Ladungen von Ihrem Körper ab, (z. B. durch Berühren eines geerdeten blanken Metallteils), bevor Sie das Produkt berühren.
- Unterlassen Sie jeden Versuch, das Produkt zu warten, und versuchen Sie nicht, es in seine Bestandteile zu zerlegen. Für einige Produkte mit austauschbaren Akkus lesen Sie bitte das Benutzerhandbuch und befolgen Sie die dort beschriebenen Anleitungen.
- Vermeiden Sie, dass Speisen oder Flüssigkeiten auf Ihr Produkt gelangen, und stecken Sie keine Gegenstände in die Gehäuseschlitze oder -öffnungen Ihres Produkts.
- Verwenden Sie dieses Produkt nicht in unmittelbarer Nähe von Wasser und nicht in Bereichen mit hoher Luftfeuchtigkeit oder Kondensation, es sei denn, es ist speziell zur Nutzung in Außenbereichen vorgesehen und eingestuft.
- Halten Sie das Produkt von Heizkörpern und anderen Quellen fern, die Wärme erzeugen.
- Trennen Sie das Produkt immer von der Stromzufuhr, bevor Sie es reinigen und verwenden Sie dazu ausschließlich ein trockenes fusselfreies Tuch.

### **CONSIGNES DE SÉCURITÉ**

Les consignes générales de sécurité ci-après sont fournies afin d'assurer votre sécurité personnelle et de protéger le produit d'éventuels dommages. Veuillez consulter les consignes d'utilisation du produit pour plus de détails.

- L'électricité statique peut endommager les composants électroniques. Déchargez l'électricité statique de votre corps (en touchant un objet en métal relié à la terre par exemple) avant de toucher le produit.
- N'essayez pas d'intervenir sur le produit et ne le démontez jamais. Pour certains produits contenant une batterie remplaçable par l'utilisateur, veuillez lire et suivre les consignes contenues dans le manuel d'utilisation.
- Ne renversez pas d'aliments ou de liquide sur le produit et n'insérez jamais d'objets dans les orifices.
- N'utilisez pas ce produit à proximité d'un point d'eau, de zones très humides ou de condensation sauf si le produit a été spécifiquement conçu pour une application extérieure.
- Éloignez le produit des radiateurs et autres sources de chaleur.
- Débranchez toujours le produit de l'alimentation avant de le nettoyer et utilisez uniquement un chiffon sec non pelucheux.

### **INSTRUCCIONES DE SEGURIDAD**

Las siguientes directrices de seguridad general se facilitan para ayudarle a garantizar su propia seguridad personal y para proteger el producto frente a posibles daños. No olvide consultar las instrucciones del usuario del producto para obtener más información.

- La electricidad estática puede resultar nociva para los componentes electrónicos. Descargue la electricidad estática de su cuerpo (p. ej., tocando algún metal sin revestimiento conectado a tierra) antes de tocar el producto.
- No intente realizar el mantenimiento del producto ni lo desmonte nunca. Para algunos productos con batería reemplazable por el usuario, lea y siga las instrucciones del manual de usuario.
- No derrame comida o líquidos sobre el producto y nunca deje que caigan objetos en las aberturas del mismo.
- No utilice este producto cerca del agua, en zonas con humedad o condensación elevadas a menos que el producto esté clasificado específicamente para aplicación en exteriores.
- Mantenga el producto alejado de los radiadores y de otras fuentes de calor.
- Desenchufe siempre el producto de la alimentación de red antes de limpiarlo y utilice solo un paño seco sin pelusa.

### **ISTRUZIONI PER LA SICUREZZA**

Le seguenti linee guida sulla sicurezza sono fornite per contribuire a garantire la sicurezza personale degli utenti e a proteggere il prodotto da potenziali danni. Per maggiori dettagli, consultare le istruzioni per l'utente del prodotto.

- L'elettricità statica può essere pericolosa per i componenti elettronici. Scaricare l'elettricità statica dal corpo (ad esempio toccando una parte metallica collegata a terra) prima di toccare il prodotto.
- Non cercare di riparare il prodotto e non smontarlo mai. Per alcuni prodotti dotati di batteria sostituibile dall'utente, leggere e seguire le istruzioni riportate nel manuale dell'utente.
- Non versare cibi o liquidi sul prodotto e non spingere mai alcun oggetto nelle aperture del prodotto.
- Non usare questo prodotto vicino all'acqua, in aree con elevato grado di umidità o soggette a condensa a meno che il prodotto non sia specificatamente approvato per uso in ambienti esterni.
- Tenere il prodotto lontano da caloriferi e altre fonti di calore.
- Scollegare sempre il prodotto dalla presa elettrica prima di pulirlo e usare solo un panno asciutto che non lasci filacce.

### **VEILIGHEIDSINFORMATIE**

De volgende algemene veiligheidsinformatie werd verstrekt om uw eigen persoonlijke veiligheid te waarborgen en uw product te beschermen tegen mogelijke schade. Denk eraan om de gebruikersinstructies van het product te raadplegen voor meer informatie.

- Statische elektriciteit kan schadelijk zijn voor elektronische componenten. Ontlaad de statische elektriciteit van uw lichaam (d.w.z. het aanraken van geaard bloot metaal) voordat u het product aanraakt.
- U mag nooit proberen het product te onderhouden en u mag het product nooit demonteren. Voor sommige producten met door de gebruiker te vervangen batterij, dient u de instructies in de gebruikershandleiding te lezen en te volgen.
- Mors geen voedsel of vloeistof op uw product en u mag nooit voorwerpen in de openingen van uw product duwen.
- Gebruik dit product niet in de buurt van water, gebieden met hoge vochtigheid of condensatie, tenzij het product specifiek geclassificeerd is voor gebruik buitenshuis.
- Houd het product uit de buurt van radiators en andere warmtebronnen.
- U dient het product steeds los te koppelen van de stroom voordat u het reinigt en gebruik uitsluitend een droge pluisvrije doek.

## Disposing and Recycling Your Product

### ENGLISH

EN



This symbol on the product or packaging means that according to local laws and regulations this product should be not be disposed of in household waste but sent for recycling. Please take it to a collection point designated by your local authorities once it has reached the end of its life, some will accept products for free. By recycling the product and its packaging in this manner you help to conserve the environment and protect human health.

### D-Link and the Environment

At D-Link, we understand and are committed to reducing any impact our operations and products may have on the environment. To minimise this impact D-Link designs and builds its products to be as environmentally friendly as possible, by using recyclable, low toxic materials in both products and packaging.

D-Link recommends that you always switch off or unplug your D-Link products when they are not in use. By doing so you will help to save energy and reduce CO2 emissions.

To learn more about our environmentally responsible products and packaging please visit [www.dlinkgreen.com](http://www.dlinkgreen.com).

### DEUTSCH

DE



Dieses Symbol auf dem Produkt oder der Verpackung weist darauf hin, dass dieses Produkt gemäß bestehender örtlicher Gesetze und Vorschriften nicht über den normalen Hausmüll entsorgt werden sollte, sondern einer Wiederverwertung zuzuführen ist. Bringen Sie es bitte zu einer von Ihrer Kommunalbehörde entsprechend amtlich ausgewiesenen Sammelstelle, sobald das Produkt das Ende seiner Nutzungsdauer erreicht hat. Für die Annahme solcher Produkte erheben einige dieser Stellen keine Gebühren. Durch ein auf diese Weise durchgeführtes Recycling des Produkts und seiner Verpackung helfen Sie, die Umwelt zu schonen und die menschliche Gesundheit zu schützen.

### D-Link und die Umwelt

D-Link ist sich den möglichen Auswirkungen seiner Geschäftstätigkeiten und seiner Produkte auf die Umwelt bewusst und fühlt sich verpflichtet, diese entsprechend zu mindern. Zu diesem Zweck entwickelt und stellt D-Link seine Produkte mit dem Ziel größtmöglicher Umweltfreundlichkeit her und verwendet wiederverwertbare, schadstoffarme Materialien bei Produktherstellung und Verpackung.

D-Link empfiehlt, Ihre Produkte von D-Link, wenn nicht in Gebrauch, immer auszuschalten oder vom Netz zu nehmen. Auf diese Weise helfen Sie, Energie zu sparen und CO2-Emissionen zu reduzieren.

Wenn Sie mehr über unsere umweltgerechten Produkte und Verpackungen wissen möchten, finden Sie entsprechende Informationen im Internet unter [www.dlinkgreen.com](http://www.dlinkgreen.com).

## FRANÇAIS

FR



Ce symbole apposé sur le produit ou son emballage signifie que, conformément aux lois et réglementations locales, ce produit ne doit pas être éliminé avec les déchets domestiques mais recyclé. Veuillez le rapporter à un point de collecte prévu à cet effet par les autorités locales; certains accepteront vos produits gratuitement. En recyclant le produit et son emballage de cette manière, vous aidez à préserver l'environnement et à protéger la santé de l'homme.

### D-Link et l'environnement

Chez D-Link, nous sommes conscients de l'impact de nos opérations et produits sur l'environnement et nous engageons à le réduire. Pour limiter cet impact, D-Link conçoit et fabrique ses produits de manière aussi écologique que possible, en utilisant des matériaux recyclables et faiblement toxiques, tant dans ses produits que ses emballages.

D-Link recommande de toujours éteindre ou débrancher vos produits D-Link lorsque vous ne les utilisez pas. Vous réaliserez ainsi des économies d'énergie et réduirez vos émissions de CO2.

Pour en savoir plus sur les produits et emballages respectueux de l'environnement, veuillez consulter le [www.dlinkgreen.com](http://www.dlinkgreen.com).

## ESPAÑOL

ES



Este símbolo en el producto o el embalaje significa que, de acuerdo con la legislación y la normativa local, este producto no se debe desechar en la basura doméstica sino que se debe reciclar. Llévelo a un punto de recogida designado por las autoridades locales una vez que ha llegado al fin de su vida útil; algunos de ellos aceptan recogerlos de forma gratuita. Al reciclar el producto y su embalaje de esta forma, contribuye a preservar el medio ambiente y a proteger la salud de los seres humanos.

### D-Link y el medio ambiente

En D-Link, comprendemos y estamos comprometidos con la reducción del impacto que puedan tener nuestras actividades y nuestros productos en el medio ambiente. Para reducir este impacto, D-Link diseña y fabrica sus productos para que sean lo más ecológicos posible, utilizando materiales reciclables y de baja toxicidad tanto en los productos como en el embalaje.

D-Link recomienda apagar o desenchufar los productos D-Link cuando no se estén utilizando. Al hacerlo, contribuirá a ahorrar energía y a reducir las emisiones de CO2.

Para obtener más información acerca de nuestros productos y embalajes ecológicos, visite el sitio [www.dlinkgreen.com](http://www.dlinkgreen.com).



## ITALIANO

IT



La presenza di questo simbolo sul prodotto o sulla confezione del prodotto indica che, in conformità alle leggi e alle normative locali, questo prodotto non deve essere smaltito nei rifiuti domestici, ma avviato al riciclo. Una volta terminato il ciclo di vita utile, portare il prodotto presso un punto di raccolta indicato dalle autorità locali. Alcuni questi punti di raccolta accettano gratuitamente i prodotti da riciclare. Scegliendo di riciclare il prodotto e il relativo imballaggio, si contribuirà a preservare l'ambiente e a salvaguardare la salute umana.

### D-Link e l'ambiente

D-Link cerca da sempre di ridurre l'impatto ambientale dei propri stabilimenti e dei propri prodotti. Allo scopo di ridurre al minimo tale impatto, D-Link progetta e realizza i propri prodotti in modo che rispettino il più possibile l'ambiente, utilizzando materiali riciclabili a basso tasso di tossicità sia per i prodotti che per gli imballaggi.

D-Link raccomanda di spegnere sempre i prodotti D-Link o di scollegarne la spina quando non vengono utilizzati. In questo modo si contribuirà a risparmiare energia e a ridurre le emissioni di anidride carbonica.

Per ulteriori informazioni sui prodotti e sugli imballaggi D-Link a ridotto impatto ambientale, visitate il sito all'indirizzo [www.dlinkgreen.com](http://www.dlinkgreen.com).

## NEDERLANDS

NL



Dit symbool op het product of de verpakking betekent dat dit product volgens de plaatselijke wetgeving niet mag worden weggegooid met het huishoudelijk afval, maar voor recyclage moeten worden ingeleverd. Zodra het product het einde van de levensduur heeft bereikt, dient u het naar een inzamelpunt te brengen dat hiertoe werd aangeduid door uw plaatselijke autoriteiten, sommige autoriteiten accepteren producten zonder dat u hiervoor dient te betalen. Door het product en de verpakking op deze manier te recyclen helpt u het milieu en de gezondheid van de mens te beschermen.

### D-Link en het milieu

Bij D-Link spannen we ons in om de impact van onze handelingen en producten op het milieu te beperken. Om deze impact te beperken, ontwerpt en bouwt D-Link zijn producten zo milieuvriendelijk mogelijk, door het gebruik van recycleerbare producten met lage toxiciteit in product en verpakking.

D-Link raadt aan om steeds uw D-Link producten uit te schakelen of uit de stekker te halen wanneer u ze niet gebruikt. Door dit te doen bespaart u energie en beperkt u de CO<sub>2</sub>-emissies.

Breng een bezoek aan [www.dlinkgreen.com](http://www.dlinkgreen.com) voor meer informatie over onze milieuverantwoorde producten en verpakkingen.

**POLSKI****PL**

Ten symbol umieszczony na produkcie lub opakowaniu oznacza, że zgodnie z miejscowym prawem i lokalnymi przepisami niniejszego produktu nie wolno wyrzucać jak odpady czy śmieci z gospodarstwa domowego, lecz należy go poddać procesowi recyklingu. Po zakończeniu użytkowania produktu, niektóre odpowiednie do tego celu podmioty przyjmą takie produkty nieodpłatnie, dlatego prosimy dostarczyć go do punktu zbiórki wskazanego przez lokalne władze. Poprzez proces recyklingu i dzięki takiemu postępowaniu z produktem oraz jego opakowaniem, pomogą Państwo chronić środowisko naturalne i dbać o ludzkie zdrowie.

**D-Link i środowisko**

D-Link podchodzimy w sposób świadomy do ochrony otoczenia oraz jesteśmy zaangażowani w zmniejszanie wpływu naszych działań i produktów na środowisko naturalne. W celu zminimalizowania takiego wpływu firma D-Link konstruuje i wytwarza swoje produkty w taki sposób, aby były one jak najbardziej przyjazne środowisku, stosując do tych celów materiały nadające się do powtórnego wykorzystania, charakteryzujące się małą toksycznością zarówno w przypadku samych produktów jak i opakowań.

Firma D-Link zaleca, aby Państwo zawsze prawidłowo wyłączali z użytku swoje produkty D-Link, gdy nie są one wykorzystywane. Postępując w ten sposób pozwalają Państwo oszczędzać energię i zmniejszać emisje CO<sub>2</sub>.

Aby dowiedzieć się więcej na temat produktów i opakowań mających wpływ na środowisko prosimy zapoznać się ze stroną Internetową [www.dlinkgreen.com](http://www.dlinkgreen.com).

**ČESKY****CZ**

Tento symbol na výrobku nebo jeho obalu znamená, že podle místně platných předpisů se výrobek nesmí vyhazovat do komunálního odpadu, ale odeslat k recyklaci. Až výrobek doslouží, odnese jej prosím na sběrné místo určené místními úřady k tomuto účelu. Někteřá sběrná místa přijímají výrobky zdarma. Recyklací výrobku i obalu pomáháte chránit životní prostředí i lidské zdraví.

**D-Link a životní prostředí**

Ve společnosti D-Link jsme si vědomi vlivu našich provozů a výrobků na životní prostředí a snažíme se o minimalizaci těchto vlivů. Proto své výrobky navrhujeme a vyrábíme tak, aby byly co nejekologičtější, a ve výrobcích i obalech používáme recyklovatelné a nízkotoxické materiály.

Společnost D-Link doporučuje, abyste své výrobky značky D-Link vypnuli nebo vytáhli ze zásuvky vždy, když je nepoužíváte. Pomůžete tak šetřit energii a snížit emise CO<sub>2</sub>.

Více informací o našich ekologických výrobcích a obalech najdete na adrese [www.dlinkgreen.com](http://www.dlinkgreen.com).

**MAGYAR****HU**



Ez a szimbólum a terméken vagy a csomagoláson azt jelenti, hogy a helyi törvényeknek és szabályoknak megfelelően ez a termék nem semmisíthető meg a háztartási hulladékkal együtt, hanem újrahasznosításra kell küldeni. Kérjük, hogy a termék élettartamának elteltét követően vigye azt a helyi hatóság által kijelölt gyűjtőhelyre. A termékek egyes helyeken ingyen elhelyezhetők. A termék és a csomagolás újrahasznosításával segíti védeni a környezetet és az emberek egészségét.

### A D-Link és a környezet

A D-Linknél megértjük és elkötelezettek vagyunk a műveleteink és termékeink környezetre gyakorolt hatásainak csökkentésére. Az ezen hatás csökkentése érdekében a D-Link a lehető leginkább környezetbarát termékeket tervez és gyárt azért, hogy újrahasznosítható, alacsony károsanyag-tartalmú termékeket gyárt és csomagolásokat alkalmaz.

A D-Link azt javasolja, hogy mindig kapcsolja ki vagy húzza ki a D-Link termékeket a tápforrásból, ha nem használja azokat. Ezzel segít az energia megtakarításában és a széndioxid kibocsátásának csökkentésében.

Környezetbarát termékeinkről és csomagolásainkról további információkat a [www.dlinkgreen.com](http://www.dlinkgreen.com) weboldalon tudhat meg.

### NORSK

**NO**



Dette symbolet på produktet eller forpakningen betyr at dette produktet ifølge lokale lover og forskrifter ikke skal kastes sammen med husholdningsavfall, men leveres inn til gjenvinning. Vennligst ta det til et innsamlingssted anvist av lokale myndigheter når det er kommet til slutten av levetiden. Noen steder aksepteres produkter uten avgift. Ved på denne måten å gjenvinne produktet og forpakningen hjelper du å verne miljøet og beskytte folks helse.

### D-Link og miljøet

Hos D-Link forstår vi oss på og er forpliktet til å minske innvirkningen som vår drift og våre produkter kan ha på miljøet. For å minimalisere denne innvirkningen designer og lager D-Link produkter som er så miljøvennlig som mulig, ved å bruke resirkulerbare, lav-toksiske materialer både i produktene og forpakningen.

D-Link anbefaler at du alltid slår av eller frakobler D-Link-produkter når de ikke er i bruk. Ved å gjøre dette hjelper du å spare energi og å redusere CO<sub>2</sub>-utslipp.

For mer informasjon angående våre miljøansvarlige produkter og forpakninger kan du gå til [www.dlinkgreen.com](http://www.dlinkgreen.com).

### DANSK

**DK**



Dette symbol på produktet eller emballagen betyder, at dette produkt i henhold til lokale love og regler ikke må bortskaffes som husholdningsaffald, mens skal sendes til genbrug. Indlever produktet til et indsamlingssted som angivet af de lokale myndigheder, når det er nået til slutningen af dets levetid. I nogle tilfælde vil produktet blive modtaget gratis. Ved at indlevere produktet og dets emballage til genbrug på denne måde bidrager du til at beskytte miljøet og den menneskelige sundhed.

### D-Link og miljøet

Hos D-Link forstår vi og bestræber os på at reducere enhver indvirkning, som vores aktiviteter og produkter kan have på miljøet. For at minimere denne indvirkning designer og producerer D-Link sine produkter, så de er så miljøvenlige som muligt, ved at bruge genanvendelige materialer med lavt giftighedsniveau i både produkter og emballage.

D-Link anbefaler, at du altid slukker eller frakobler dine D-Link-produkter, når de ikke er i brug. Ved at gøre det bidrager du til at spare energi og reducere CO<sub>2</sub>-udledningerne.

Du kan finde flere oplysninger om vores miljømæssigt ansvarlige produkter og emballage på [www.dlinkgreen.com](http://www.dlinkgreen.com).

### SUOMI

FI



Tämä symboli tuotteen pakkauksessa tarkoittaa, että paikallisten lakien ja säännösten mukaisesti tätä tuotetta ei pidä hävittää yleisen kotitalousjätteen seassa vaan se tulee toimittaa kierrätettäväksi. Kun tuote on elinkaarensa päässä, toimita se lähimpään viranomaisten hyväksymään kierrätyspisteeseen. Kierrättämällä käytetyn tuotteen ja sen pakkauksen autat tukemaan sekä ympäristön että ihmisten terveyttä ja hyvinvointia.

### D-Link ja ympäristö

D-Link ymmärtää ympäristönsuojelun tärkeyden ja on sitoutunut vähentämään tuotteistaan ja niiden valmistuksesta ympäristölle mahdollisesti aiheutuvia haittavaikutuksia. Nämä negatiiviset vaikutukset minimoidakseen D-Link suunnittelee ja valmistaa tuotteensa mahdollisimman ympäristöystävällisiksi käyttämällä kierrätettäviä, alhaisia pitoisuuksia haitallisia aineita sisältäviä materiaaleja sekä tuotteissaan että niiden pakkauksissa.

Suosittellemme, että irrotat D-Link-tuotteesi virtalähteestä tai sammutat ne aina, kun ne eivät ole käytössä. Toimimalla näin autat säästämään energiaa ja vähentämään hiilidioksiidipäästöjä.

Lue lisää ympäristöystävällisistä D-Link-tuotteista ja pakkauksistamme osoitteesta [www.dlinkgreen.com](http://www.dlinkgreen.com).

### SVENSKA

SE



Den här symbolen på produkten eller förpackningen betyder att produkten enligt lokala lagar och föreskrifter inte skall kastas i hushållssoporna utan i stället återvinnas. Ta den vid slutet av dess livslängd till en av din lokala myndighet utsedd uppsamlingsplats, vissa accepterar produkter utan kostnad. Genom att på detta sätt återvinna produkten och förpackningen hjälper du till att bevara miljön och skydda människors hälsa.

### D-Link och miljön

På D-Link förstår vi och är fast beslutna att minska den påverkan våra verksamheter och produkter kan ha på miljön. För att minska denna påverkan utformar och bygger D-Link sina produkter för att de ska vara så miljövänliga som möjligt, genom att använda återvinningsbara material med låg gifthalt i både produkter och förpackningar.

D-Link rekommenderar att du alltid stänger av eller kopplar ur dina D-Link produkter när du inte använder dem. Genom att göra detta hjälper du till att spara energi och minska utsläpp av koldioxid.

För mer information om våra miljöansvariga produkter och förpackningar [www.dlinkgreen.com](http://www.dlinkgreen.com).

### PORTUGUÊS

PT



Este símbolo no produto ou embalagem significa que, de acordo com as leis e regulamentações locais, este produto não deverá ser eliminado juntamente com o lixo doméstico mas enviado para a reciclagem. Transporte-o para um ponto de recolha designado pelas suas autoridades locais quando este tiver atingido o fim da sua vida útil, alguns destes pontos aceitam produtos gratuitamente. Ao reciclar o produto e respectiva embalagem desta forma, ajuda a preservar o ambiente e protege a saúde humana.

### A D-Link e o ambiente

Na D-Link compreendemos e comprometemo-nos com a redução do impacto que as nossas operações e produtos possam ter no ambiente. Para minimizar este impacto a D-Link concebe e constrói os seus produtos para que estes sejam o mais inofensivos para o ambiente possível, utilizando materiais recicláveis e não tóxicos tanto nos produtos como nas embalagens.

A D-Link recomenda que desligue os seus produtos D-Link quando estes não se encontrarem em utilização. Com esta acção ajudará a poupar energia e reduzir as emissões de CO<sub>2</sub>.

Para saber mais sobre os nossos produtos e embalagens responsáveis a nível ambiental visite [www.dlinkgreen.com](http://www.dlinkgreen.com).